



# Unreinforced Masonry Buildings and Earthquakes

Developing Successful Risk Reduction Programs

FEMA P-774 / October 2009



FEMA



The cover photos show significant damage to unreinforced masonry buildings that resulted from earthquakes occurring over the last century, across the country.

Front Cover Photo Credits (clockwise from top left):

1886, Charleston, South Carolina: *J. K. Hillers, U.S. Geological Survey*

2003, San Simeon, California: *Josh Marrow, Earthquake Engineering Research Institute Reconnaissance Team*

2001, Nisqually, Washington: *Oregon Department of Geology and Mineral Industries*

1935, Helena, Montana: *L. H. Jorud, courtesy of Montana Historical Society and Montana Bureau of Mines & Geology*

1993, Klamath Falls, Oregon: *Oregon Department of Geology and Mineral Industries*

2008, Wells, Nevada: *Craig dePolo, Wells Earthquake Portal, [www.nbmng.unr.edu/WellsEQ/](http://www.nbmng.unr.edu/WellsEQ/).*

# Unreinforced Masonry Buildings and Earthquakes

## Developing Successful Risk Reduction Programs

FEMA P-774/October 2009

Prepared for:  
FEDERAL EMERGENCY MANAGEMENT AGENCY (FEMA)  
Cathleen Carlisle, Project Monitor  
Washington, D.C.

Prepared by:  
APPLIED TECHNOLOGY COUNCIL (ATC)  
201 Redwood Shores Parkway, Suite 240  
Redwood City, California

PRINCIPAL AUTHOR  
Robert Reitherman

CONTRIBUTING AUTHOR  
Sue C. Perry

PROJECT MANAGER  
Thomas R. McLane

PROJECT REVIEW PANEL  
Ronald P. Gallagher  
Jon A. Heintz  
William T. Holmes  
Ugo Morelli  
Lawrence D. Reaveley  
Christopher Rojahn



**FEMA**

Any opinions, findings, conclusions, or recommendations expressed in this publication do not necessarily reflect the views of FEMA. Additionally, neither FEMA or any of its employees makes any warrantee, expressed or implied, or assumes any legal liability or responsibility for the accuracy, completeness, or usefulness of any information, product, or process included in this publication. Users of information from this publication assume all liability arising from such use.

---

# Contents

1	<b>Introduction</b> . . . . .	1
	Unreinforced Masonry Buildings and Earthquakes: Where in the United States are the Risks? . . . . .	2
	Types of Earthquake Risks . . . . .	3
2	<b>Earthquake Performance of Unreinforced Masonry Buildings</b> . . . . .	7
	What is Unreinforced Masonry? . . . . .	7
	Examples and Statistics from Past U.S. Earthquakes . . . . .	10
3	<b>Developing a Strategy for Implementing a URM Building Risk Reduction Program</b> . . . . .	15
	Occupancy and Ownership Factors: The People Who Own and Use the Buildings . . . . .	16
	Historic and Architectural Character . . . . .	16
	Cost Issues Related to Seismic Retrofits . . . . .	17
	City Planning Factors . . . . .	17
4	<b>Examples of Successful Risk Reduction Programs</b> . . . . .	19
	Compiling an Inventory of Unreinforced Masonry Buildings . . . . .	19
	Successful Programs Require Sustained Support and Leadership . . . . .	20
	Utah: Engineering Inspections Triggered by Re-roofing Projects . . . . .	20
	Utah: Statewide Inventory of Unreinforced Masonry Buildings . . . . .	21
	State of California Unreinforced Masonry Building Law: Measuring the Problem and the Progress Toward Addressing It . . . . .	22
	Seattle, Washington: Saving Historic Buildings . . . . .	23
	Seattle, Washington: Combining Modernization with Seismic Retrofitting . . . . .	23
	Oregon: A Statewide Inventory and Funding Approach for Schools and Essential Facilities . . . . .	24
	Berkeley and Other California Cities: Financial Incentives for Retrofitting . . . . .	24
	Public Schools in California: A Statewide Approach to a Special Kind of Facility . . . . .	25
	Long Beach, California: A Pioneering Accomplishment . . . . .	25
	Los Angeles, California: Evidence of the Effectiveness of Retrofits . . . . .	26
	San Luis Obispo, California: Making the Effort to Communicate with Building Owners . . . . .	27
5	<b>Additional Technical Background on Unreinforced Masonry Construction</b> . . . . .	29
	How Do Unreinforced Masonry Buildings Behave in Earthquakes? . . . . .	31
	How Are Unreinforced Masonry Buildings Seismically Retrofitted? . . . . .	34
6	<b>Sources of Information</b> . . . . .	39
	Publications for the General Public . . . . .	39
	Historic Buildings and Seismic Retrofits . . . . .	40
	Building Inventories and Evaluation of Existing Buildings . . . . .	40
	Building Codes, Standards, Guidelines, and Laws Applicable to Existing Buildings . . . . .	41
	Costs of Seismic Retrofits . . . . .	42
7	<b>End Notes and Cited References</b> . . . . .	43
8	<b>Project Participants</b> . . . . .	47



# 1

## Introduction

This document provides guidance on how to develop programs to reduce the earthquake risks of existing unreinforced masonry buildings. As the following chapters will show, this building type is typically the most seismically vulnerable category of construction in a community, and it is by far the most common type of building to be singled out for voluntary or mandatory seismic risk reduction programs in the United States.

While the information presented here is based on extensive earthquake engineering knowledge, this guide has been written for use by a non-technical audience, including government officials, building owners, and the general public. It also contains relevant information for building officials, consulting structural engineers and building contractors.

Unreinforced masonry walls do not have a grid of steel reinforcing bars embedded within them. See Chapters 2 and 5 for further description.

The typical *unreinforced masonry* building in the United States has brick walls with no steel reinforcing bars embedded within them. A more precise definition of unreinforced masonry buildings or “URMs,” as they are known in many places, is contained in Chapter 2, “Earthquake Performance of

Unreinforced Masonry Buildings.” Additional details about their construction are included in Chapter 5. The reader does not need to study all of this terminology, but he or she should clearly understand the basic differences between unreinforced and reinforced masonry.

Chapter 3, “Developing a Strategy for Implementing a URM Risk Reduction Program,” describes how a number of factors unrelated to construction are involved in any efforts to reduce unreinforced masonry seismic risks. Those factors include retrofit costs and the economic viability of older existing buildings, the number of occupants and type of use of the buildings, and the historic or architectural character of the buildings. Each of these considerations involves an important segment of the community that should be included in active consideration of any risk reduction program.

This guide does not presume to prescribe a rigidly uniform sequence of steps that must be taken in order to reduce risk. As Chapter 4, “Examples of Successful Risk Reduction Programs,” clearly documents, a wide variety of approaches has been developed across the country.

Chapter 5, “Additional Technical Background on Unreinforced Masonry Buildings,” provides simple explanations of some key earthquake engineering terminology and concepts for the non-engineer audience. This information is intended to help facilitate conversations between the non-technical audience, such as city officials and the general public, and the technical community that includes building inspectors, engineers, and architects.

Chapter 6, “Sources of Information,” provides a number of annotated references for both technical (engineering-oriented) and non-technical audiences.

Chapter 7, “End Notes and Cited References,” provides notes and cites references to document all of the information presented in this guide. Almost all of the Sources of Information and the Cited References are accessible on the internet free of charge.

## Unreinforced Masonry Buildings and Earthquakes: Where in the United States are the Risks?

If the current building code in a locale does not allow unreinforced masonry construction, then existing buildings of that type can be considered a significant earthquake risk that should be investigated further.

Current U.S. building codes (described further in Chapter 2) allow unreinforced masonry walls in new building construction only in those areas where the probability or chance of strong earthquake shaking is very low. In past decades, however, many thousands of unreinforced masonry buildings were constructed in all areas of the country, even in regions subject to the most frequent strong earthquakes. In the light of today’s knowledge, we recognize

that this existing URM building stock presents a problem with respect to earthquake risk.

The URM problem in jurisdictions that are now effectively enforcing the current building code (essentially the latest edition of the *International Building Code*, the IBC) is due to those buildings that were built before recent model code seismic provisions were adopted and enforced. The jurisdiction’s building department can provide the benchmark date, when the locally enforced building code began to include seismic provisions that cover unreinforced masonry. Unreinforced masonry buildings can be found in every state. Because of its durability, fire resistance, and architectural character, unreinforced masonry has often been the construction material of choice for schools, city halls, central business district buildings, factories, and apartment buildings. However, the probability of strong earthquake shaking is not equally distributed across the states, which raises the question: Where in the United States are unreinforced masonry buildings of concern?

Figure 1 provides a general view of those areas of the U.S. where unreinforced masonry is not permitted for current construction.<sup>1</sup> This Figure serves as an initial guide to where some level of concern is warranted regarding the earthquake risks posed by these buildings. A local building department or a consulting structural engineer can provide more detailed guidance as to whether current seismic code provisions allow unreinforced masonry for a precise location, type of soil, and occupancy or use of a building. Even in regions where unreinforced masonry is currently allowed, older unreinforced masonry buildings may exist in a deteriorated



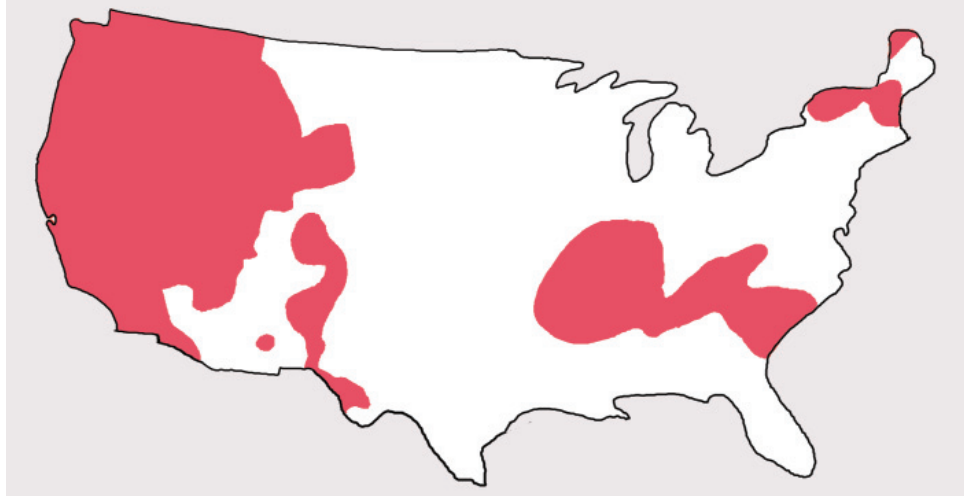

■ Figure 1. Approximate mapping of the areas of the United States where current building code regulations do not allow new construction with unreinforced masonry.

state much weaker than that required by code today. Assessing the earthquake vulnerabilities of older unreinforced masonry buildings appropriately in areas that still allow URM construction might take the form of requiring inspection of exterior materials, especially masonry materials like bricks or terra cotta, in order to ensure they are still attached firmly enough to prevent falling. Chicago, for example, has passed a local building condition assessment ordinance that requires periodic inspection of building facades, although the city is located in an area where the current *International Building Code* allows unreinforced masonry.

## Types of Earthquake Risks

Poor building performance poses three basic types of risk in an earthquake: the risk of injury, property damage, and loss of use. Spending the time and effort, and imposing the new regulations and costs on building owners, to implement a risk reduction program for unreinforced masonry buildings makes sense when it is clearly based on reducing one or more of these types of risk.



**INJURY:** Promoting safety is the prime rationale for building code regulations in general, whether applied to earthquakes, fires, or other hazards. Damage to unreinforced masonry buildings is dangerous.

When masonry debris falls, it is potentially lethal. A single brick weighs from 6 to 12 pounds (2½ to 5 kg), and just one square foot of a typical wall weighs 120 pounds or more (over 50 kg). Unreinforced masonry buildings are dangerous not only to their occupants but also to those in adjacent buildings and to pedestrians. Figure 2 illustrates the danger of falling masonry debris, even if the entire building does not collapse. Parapets, which are the short walls that often extend around the perimeter of a roof (as in the two buildings pictured in Figure 2), are particularly vulnerable, as are chimneys and cornices (the decorative ledges that run around the top of the building). Figure 3 illustrates the level of danger posed by complete collapse of a URM building.

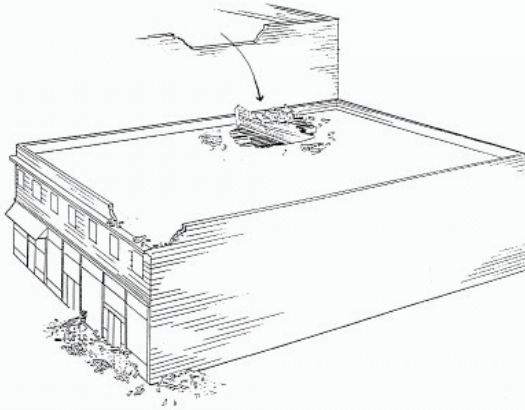

■ **Figure 2. Diagram illustrating the dangers of unreinforced masonry.**

When unreinforced masonry buildings begin to come apart in earthquakes, heavy debris can fall on adjacent buildings or onto the exterior where pedestrians are located. This diagram illustrates the failure of parapets, one of the most common types of unreinforced masonry building damage. This level of damage can occur even in relatively light earthquake shaking. —*Rutherford & Chekene*



■ **Figure 3. Complete collapse of an unreinforced brick building.**

The most severe level of damage, with the greatest likelihood of fatalities, is complete collapse. After a few seconds of ground shaking in the 1933 Long Beach earthquake, the brick walls holding up the second floor and roof of this building broke apart. That not only caused the fall of hazardous brick debris—it also immediately led to complete collapse. —*Los Angeles Public Library*



**PROPERTY DAMAGE:** Experience from past earthquakes has shown that expensive repairs will be needed to an unreinforced masonry building, after an earthquake. More than for any other kind of damaged building, there is often no way to “put Humpty Dumpty back together again” for a URM building. This results in the demolition of the building. Some of the most architecturally prominent and historically valued buildings in the United States are made of unreinforced masonry. See Figure 4. Protecting these architectural and historic assets may be an important goal of risk reduction programs, in addition to preventing costly damage. The damage to the Pacific Avenue Historic District in the city of Santa Cruz that resulted from the 1989 Loma Prieta earthquake was so extensive that the downtown area was removed from the National Register of Historic Places (see Figure 5). In that Historic District, 52% of the old brick buildings were so badly damaged that they were quickly demolished, and another 16% were “red-tagged” (closed because they were unsafe to enter<sup>2</sup>).

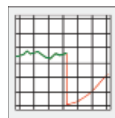

**LOSS OF USE:** Even minor earthquake damage can require the closure of an unreinforced masonry building, until repairs are made. More often than for other kinds of construction, a damaged unreinforced masonry building may need to be upgraded to a higher level of safety than it possessed in its pre-earthquake state, before it can reopen. Closure of a building, while permits are obtained and a major re-construction project is carried out, often lasts for several years. The kind of damage shown in Figure 6, which causes the building to be “red tagged” as unsafe to enter, can present so many problems in bringing the building back into use that long-term vacancy or demolition of the building may result.



■ **Figure 4. The Salt Lake City and County Building, an architectural and historic community asset that could be lost, if damaged.**

The Salt Lake City and County Building was extensively seismically retrofitted, not only to make it safer but also to provide long-term protection for a valued historic building. —*U.S. Geological Survey*

---



■ **Figure 5. Destruction of a historic building.**

Complete collapse of one of the historic buildings in the former Pacific Avenue Historic District of the City of Santa Cruz, California. —*James R. Blacklock, NISEE, U.C. Berkeley*

---



■ **Figure 6. Damaged URM wall in a red-tagged building, fated to be torn down or to undergo a multi-year closure for repairs and upgrading.**

Pre-earthquake retrofitting usually looks quite modest, compared to the comprehensive upgrading that building codes will require to repair a damaged, non-code-conforming building after an earthquake. —*Robert Reitherman*

---

All three kinds of risk—injury, property damage, and loss of use—are usually greater for unreinforced masonry buildings than for the other buildings in a city or region. While some communities, university systems, owners, and others have chosen to deal with the risks of other kinds of existing buildings or to upgrade utility and transportation systems,<sup>3</sup> addressing unreinforced masonry building problems is usually the top priority in any serious effort to provide seismic protection.

Dealing with the earthquake risks of unreinforced masonry buildings is a challenging and difficult undertaking. However, many communities have developed successful risk reduction strategies. A number of examples are presented in Chapter 4.

# 2

## Earthquake Performance of Unreinforced Masonry Buildings

This chapter provides brief descriptions and illustrations of unreinforced masonry, along with explanations of why unreinforced masonry buildings are so susceptible to earthquake damage. When subjected to strong earthquake shaking in past U.S. earthquakes, five out of six URM buildings have been damaged to the extent that potentially lethal amounts of brickwork fell. One-fifth of those buildings either partially or completely collapsed.<sup>4</sup>

### What is Unreinforced Masonry?

Unreinforced masonry can be defined generally as masonry that contains no reinforcing in it. The terms “unreinforced” and “masonry” are both more precisely described in this chapter. A shared understanding of these facts and definitions will be helpful to conversations between engineers and non-engineers, when discussing a risk reduction program.

Masonry is made of earthen materials and includes the sub-types listed below. The most common unreinforced masonry materials used for the walls of buildings are the first two listed, brick and hollow concrete block, which are illustrated in Figure 7, Figure 8, and Figure 9.

- Brick: clay that is fired to a hard consistency.
- Hollow concrete block: “concrete masonry unit” in the terminology of building codes, commonly known as “cinder block.”
- Hollow clay tile: similar to concrete block in shape, having hollow cells, but brick-colored.
- Stone: can be “dressed” or cut into rectangular blocks, or used in its natural shape.
- Adobe: mud poured into the form of walls or made into sun-dried bricks.

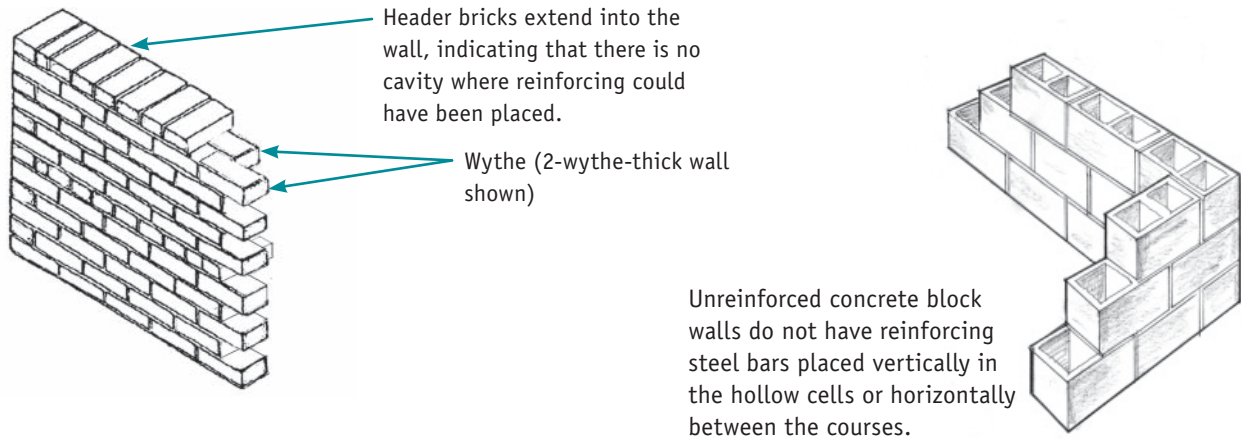

■ Figure 7. Components of unreinforced brick (left) and unreinforced concrete block (right) walls.

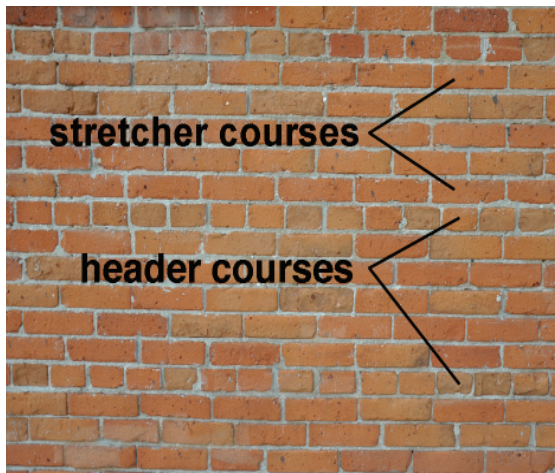

■ Figure 8. "Header" versus "stretcher" courses. The presence of header courses is usually the easiest way to tell if a brick wall is unreinforced.



■ Figure 9. Complete collapse of an unreinforced concrete block building, 1971 San Fernando earthquake. —Karl Steinbrugge, NISEE, U.C. Berkeley

**B**earing walls perform the essential job of resisting gravity and holding a building up. Destruction of bearing walls leads to collapse.

The most common type of unreinforced masonry building in the United States is constructed of brick walls, with wood-frame floors and roof, as shown in Figure 10 and Figure 11. From the outside, one can observe that the spans over windows are short, and the walls are thick. The masonry walls around the exterior, and sometimes similar walls in the interior, bear up under the weight that is delivered to them by floor or roof beams. For this reason, they are called *bearing walls*. When the masonry is built into the rectangular openings or bays of a concrete or steel frame, with the frame holding up the masonry, then they are called *infill walls*. That kind of building requires its own special analysis and is not in the subject of this booklet.

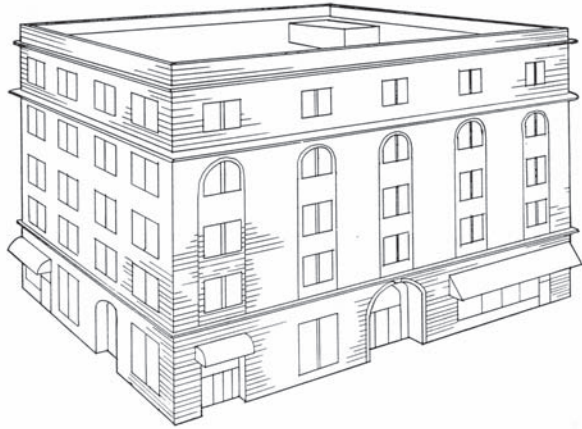

■ **Figure 10. Typical appearance of a multistory unreinforced brick building.**

When buildings are much taller than this, there is often also a steel or concrete frame, making an infill structure. —*Rutherford and Chekene*

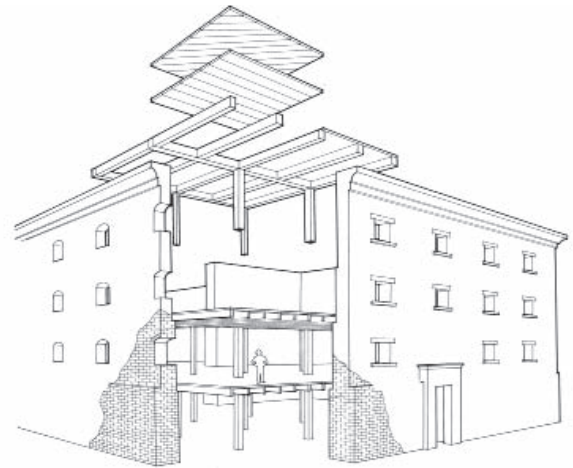

■ **Figure 11. Components of a URM building.**

Many larger unreinforced brick buildings have heavy timber columns and beams in the interior. The wooden posts and beams do not provide significant horizontal (earthquake) force resistance. —*FEMA 154, Rapid Visual Screening of Buildings for Potential Seismic Hazards: A Handbook*

Masonry veneer is usually composed of one layer of ordinary brick or of thinner brick that is applied to a supporting wall behind it, as shown in Figure 12. Veneer is typically about four inches (100 mm) or less in thickness. It may also consist of stone facing. The veneer is adhered to and literally hangs onto a wall behind it for vertical and horizontal support. Terra cotta, a ceramic material similar to brick



■ **Figure 12. Workers installing brick veneer.**

The individual pieces of veneer are being adhered to the reinforced concrete wall behind them. The result looks like a brick wall. —*Robert Reitherman*

that has a smooth finish and is made in various forms and colors, was often used in older buildings for both decorations and veneer. Current code provisions in areas of seismic activity include requirements to prevent veneer from falling off in an earthquake. Older buildings with thick (one-brick thick) veneer that does not meet current seismic safety requirements can experience the veneer peeling off, when the building is shaken. Masonry veneer on houses is typically more of a property damage risk than a significant safety risk. However, veneer on taller walls in public settings adjacent to areas where pedestrians may be presents a significant risk that an unreinforced masonry risk reduction program should consider.

Further information on unreinforced masonry construction is provided in Chapter 5.

## Examples and Statistics from Past U.S. Earthquakes

A number of earthquakes in the United States would have resulted in some property loss but no real disaster, if damage to unreinforced masonry buildings had not occurred. The following brief survey provides evidence in support of this conclusion. Magnitude (M) numbers are included for each earthquake below. While one may often hear references to the “Richter scale,” in many cases today, seismologists measure the overall size of an earthquake using one of the other magnitude scales that were developed after Charles Richter developed his in 1935. The differences in magnitude scales are not particularly relevant here. The symbol M below stands for generic earthquake magnitude.

**1886 Charleston Earthquake, South Carolina, M 7.7:** Eighty-two percent of the brick buildings suffered more than minor damage, and 7% collapsed or were demolished.<sup>5</sup> See Figure 13, illustrating the debris from collapsing second story masonry walls, which extends beyond the middle of the street.



■ Figure 13. Debris resulting from the 1886 Charleston, South Carolina earthquake.  
—NISEE, U.C. Berkeley



**1925 Santa Barbara Earthquake, Southern California, M 6.2:** The most severe damage from this earthquake occurred among unreinforced brick commercial and residential construction and was a primary motivation for engineers in California to adapt seismic design ideas from Japan into the *Uniform Building Code*. Forty percent of the unreinforced masonry buildings were severely damaged or collapsed.<sup>6</sup> See Figure 14, the Hotel Californian, in which extensive wood-frame and plaster partitions barely managed to hold the building up, after exterior brick walls failed.



■ Figure 14. Heavily damaged Hotel Californian, 1925 Santa Barbara, California earthquake. —NISEE, U.C. Berkeley

**1933 Long Beach Earthquake, Southern California, M 6.3:** In the City of Long Beach (adjacent to the City of Los Angeles), 54% of the unreinforced masonry buildings ended up with damage that ranged from significant wall destruction to complete collapse. In 20% of the cases, damage fell in the categories of either damage to more than half the wall area, partial collapse, or complete collapse.<sup>7</sup> See Figure 15, showing parapet (the short walls that often extend around the perimeter of a roof) and top story failure and the effect of the falling masonry debris.



■ Figure 15. URM building damage, 1933 Long Beach, California earthquake. —Los Angeles County Public Library

**1983 Coalinga Earthquake, Central California, M 6.2:** Out of 37 unreinforced masonry buildings—the core of the Coalinga business district—only one escaped damage. Sixty percent were damaged to the extent of having more than half of their walls ruined, up to complete collapse.<sup>8</sup> The entire downtown area was cordoned off, until badly damaged buildings could be demolished and the debris removed. See Figure 16, which illustrates a common form of damage, in which the gable (peaked roof) end wall falls.



■ **Figure 16. URM building with end-wall failure, 1983 Coalinga, California earthquake.** Robert Reitherman  
—NISEE, U.C. Berkeley

**1983 Borah Peak Earthquake, Idaho, M 7.3:** In the town of Challis, Idaho, the only earthquake-related fatalities occurred when an unreinforced masonry wall fell on two children on their way to school. In Mackay, the town's main street buildings, built of unreinforced brick, concrete block, or stone, were all damaged, Eight required demolition. In relative terms, when compared to the size of the town (see Figure 17), this amount of damage constituted a large disaster.



■ **Figure 17. Aerial view of heavily damaged Mackay, Idaho.** The unreinforced masonry buildings on the main commercial street of the small town were badly damaged in the 1983 Borah Peak, Idaho earthquake.  
—NISEE, U.C. Berkeley

**1989 Loma Prieta Earthquake, Northern California, M 7.1:** In this earthquake, 374 (16%) of the 2,400 unreinforced masonry buildings in the region experienced damage severe enough to require that they be vacated.<sup>9</sup> The earthquake was centered 60 miles south of the San Francisco Bay Area, and the majority of these buildings were subjected to only light to moderate shaking. Figure 18 illustrates an upper-story failure of brickwork, which fell onto the sidewalk and cars below, killing five people.



■ **Figure 18. Upper story wall collapse, with resulting fatalities.**

Five people were killed when the brick wall in the fourth story fell on top of cars and the sidewalk in the 1989 Loma Prieta earthquake. —James Blacklock, NISEE, U.C. Berkeley

**2001 Nisqually Earthquake, Puget Sound Region, Washington, M 6.8:**

“URM buildings built before 1950 exhibited the poorest behavior. The most common damage included shedding of brick from parapets and chimneys. Other URM buildings exhibited diagonal ‘stair-step’ cracking in walls and piers, damage to walls in the upper stories, vertical cracking in walls, damage to masonry arches, and damage to walls as a result of pounding. In many cases, fallen brick resulted in damage to objects, such as cars and canopies, outside the building.”<sup>10</sup> See Figure 19.



■ **Figure 19. URM building damage, 2001 Nisqually, Washington earthquake.**

At left, hollow clay tile debris from a collapsed wall; at right, diagonal “stair-step” cracking of a brick wall (the crack following mortar horizontal bed joint and vertical head joint lines), a sign of the wall’s inability to resist shear stress from in-plane forces. —André Filiatraut

**2003 San Simeon Earthquake, Central California, M 6.5:** Of 53 unreinforced masonry buildings in Paso Robles, the nearest affected city, none of the nine that had been retrofitted experienced major damage. Many of the others were damaged so extensively that they were subsequently demolished. “During earthquakes unreinforced masonry buildings that have not been retrofitted continue to be the most dangerous buildings in California.” One building owner commented afterward: “I’m confident the building would have come down in the quake if we hadn’t done the retrofiting. There were times when we were bleeding so badly in paying for it, we wondered what in the heck we were doing. Now we know.”<sup>11</sup> See Figure 20. The two fatalities in the town were due to the collapse of an unretrofitted, unreinforced brick building.



■ **Figure 20. Retrofitted URM building, 2003 San Simeon, California earthquake.**

Retrofitted prior to the earthquake, this unreinforced brick building experienced no damage. —Janise E. Rodgers, NISEE, U.C. Berkeley.

Putting together the statistics on 4,457 unreinforced masonry buildings from several U.S. earthquakes<sup>4</sup>, we see the following profile of how unreinforced masonry buildings perform, when strong earthquake shaking occurs:

- Five out of six are damaged enough for brickwork to fall;
- One-fifth are damaged to the point of partial or complete collapse.

# 3

## Developing a Strategy for Implementing a URM Building Risk Reduction Program

A number of considerations should be taken into account when developing a strategy for implementing an unreinforced masonry building risk reduction program. Each consideration involves key individuals and groups who will formulate, carry out, and be affected by the program. For that reason, it is important to involve them as early in the process as possible.

Many considerations must be taken into account when developing a program to reduce the earthquake risks of unreinforced masonry buildings. Each consideration involves key individuals and groups, who should become involved at an early stage in the development process. For example, a planning department maintains information on the inhabitants and people who use the buildings in a community. The local building department is the agency that maintains data on the construction characteristics of buildings. This department is centrally involved in enforcing building code ordinances or voluntary construction standards and in issuing permits for any retrofit construction projects. Economic factors in a risk reduction program obviously affect building owners (and retrofit costs often “flow down” to tenants); in addition, financial and real estate institutions may have relevant insights and interests regarding the program. Agencies or non-profit organizations with architectural or historical preservation interests have a stake in how buildings of that character may be changed by any seismic retrofits. Finally, when unreinforced masonry buildings are clustered together, as they often are in older central business districts, then risk reduction programs raise city planning issues with regard to zoning, parking, redevelopment efforts, and other city concerns.

Retrofitting is the process of adding earthquake resistance to an existing building. It is generally synonymous with the terms ‘seismic strengthening’ or ‘seismic rehabilitation.’

The principal means of reducing the seismic risks of unreinforced masonry buildings is *retrofitting*, although changing a building’s use in order to reduce its occupant load (number of occupants) also reduces risk.

Retrofitting an unreinforced masonry building can take several different forms (see Chapter 5), but it must be kept in mind that a retrofit is a significant construction project, which may affect owners, occupants, and the community at large.

## Occupancy and Ownership Factors: The People Who Own and Use the Buildings

The usage or occupancy of a building is an important consideration, when planning a risk reduction program. Occupancies are defined by building codes in terms of the number of people who occupy a building and what the building's functions are. More intensive uses, which bring more people to a building, increase risk exposure to earthquake-caused injuries. Current building code regulations require that essential facilities such as fire stations be designed to higher earthquake safety standards than ordinary buildings. This suggests that existing buildings with many occupants or essential facilities should have a higher priority for retrofits. Ownership patterns are also important. Twenty buildings on a school or college campus have one owner and ultimately, one decision-making process (for example, the setting of policies by a school board). Twenty buildings along a commercial street may be owned by twenty different owners, with twenty distinct sets of decision-making variables involved, leading to greater variety of outcomes.

A retrofit project in an apartment building that displaces residents for weeks or months presents the problem of where those residents will find temporary housing. Are apartment buildings providing low-rent housing, so that passing along retrofit costs to tenants in the form of higher rents will be a major economic burden? Are unreinforced masonry buildings located where few residents speak English? Such demographic factors must be taken into account, when planning how to craft a risk reduction program and how to involve the public. In San Francisco, a study was conducted to lay the groundwork for San Francisco's unreinforced masonry building retrofit program that specifically estimated what kinds of retrofits would be needed for residential buildings.

## Historic and Architectural Character

Protecting people from the earthquake dangers of unreinforced masonry buildings must be a community's highest priority. However, protecting the property value of buildings by preventing damage is also important. In addition, some buildings have historic or architectural significance, which is itself a value to be preserved. Because masonry is a durable material and was often the first choice for important buildings constructed in the past, many communities' most historic and architecturally valued buildings are of this structural type, as in the case illustrated in Figure 21.

Retrofitting these buildings to increase their earthquake resistance is necessary in order to prevent irreparable damage from occurring to the buildings in an earthquake. Yet the retrofit itself can alter the building's appearance and change its historic materials in an undesirable way, if not carried out sensitively. Fortunately, today's earthquake engineering methods provide options for dealing with the earthquake vulnerabilities of a building, while leaving its appearance largely unchanged. As Chapter 5 discusses, the technique of seismic isolation has been used for some monumental public buildings with extensive unreinforced masonry components. These isolators can reduce the seismic forces on the building to only one third of what they would otherwise be, and the isolators are usually installed unobtrusively at the foundation or basement level.



■ **Figure 21. Pioneer Square Historic District, Seattle, Washington.**

The historic buildings in this city district are unreinforced masonry buildings. This is often the case.

## Cost Issues Related to Seismic Retrofits

Groups like a downtown business owners association or chamber of commerce, an apartment owners or renters association, or a historic preservation league, may have concerns about retrofit costs. Structurally strengthening an unreinforced masonry building is not an inexpensive remodeling project, and the cost implications must be considered. As part of developing a risk reduction plan, it is important to collect information on the economic viability of the unreinforced masonry buildings at issue. Are the buildings high in value, generating strong income streams, because they form the heart of the “old town” tourist district that is common in many cities? Or are they in a declining area that used to be the central business district but which has been supplanted by shopping centers and office parks located elsewhere? Do the properties provide enough collateral for their owners to obtain construction loans to finance the upgrading work?

FEMA provides an on-line retrofit cost estimating feature on its website,<sup>12</sup> and FEMA documents provide further information.<sup>13</sup> Costs can vary greatly, however, so locally-based estimates should be carried out prior to instituting a risk reduction program.

## City Planning Factors

An inventory of unreinforced masonry buildings can be presented in table format, to display the buildings’ square footage and number of stories, construction dates, and occupancy. Building location is also significant. Are buildings dispersed throughout an area, or are they clustered? How are they located with respect to current zoning districts? The community may have a long-range plan for streets, parking, plazas and pedestrian areas. Any economic redevelopment plans should include a list of the locations of unreinforced masonry buildings. Aside from an individual building’s architectural or historic merits, it is important to consider the collective effect for a town or city of having a number of well-preserved, economically vital, older buildings that define the overall community character. There may also be environmental

impact reporting requirements that a retrofit program would trigger; city planning departments should be familiar with any such requirements. Figure 22 illustrates how an inventory of unreinforced masonry buildings can be overlaid with political and economic (building value) data.

As the examples in Chapter 4 make clear, a variety of risk reduction approaches that address these factors have been successfully adopted. Developing these successful approaches has almost always required involving the key individuals and groups associated with each consideration in the planning and decision-making process.

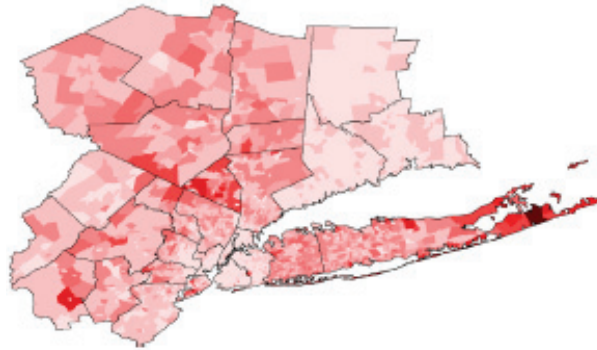

■ **Figure 22. The distribution of unreinforced masonry buildings in the greater New York City region.**

Maps such as this one, published by the New York City Area Consortium for Earthquake Loss Mitigation, relate seismic information to geographic and land use planning data.



# 4

## Examples of Successful Risk Reduction Programs

A large number of unreinforced masonry building risk reduction programs have been implemented across the United States. A sample of representative programs is included here, to illustrate the variety of possible approaches.

“If the shoe doesn’t fit, then don’t wear it” is a good caveat to add, when giving advice. While one of the following programs may provide an ideal model for a given community, it is likely that a new risk reduction program will require some unique features based on the particular situation in that community. The examples presented in this chapter illustrate key components of risk reduction programs, which communities can then synthesize in a variety of ways, in order to suit their particular circumstances.

### Compiling an Inventory of Unreinforced Masonry Buildings

Most programs to reduce unreinforced masonry seismic risks share certain characteristics. First, they all need to include an inventory of buildings, which should be carried out early in the planning process. Conducting an inventory is not difficult, because unreinforced masonry buildings are among the easiest of construction types to identify. Building department, insurance industry, and tax assessor files can sometimes provide useful information. “Sidewalk surveys” that observe buildings from the outside are often sufficient. The FEMA 154 Handbook provides a “rapid visual screening” method that is applicable to a wide variety of buildings<sup>14</sup> (see Figure 23). Section E.13 of Appendix E of the FEMA 154 Handbook provides

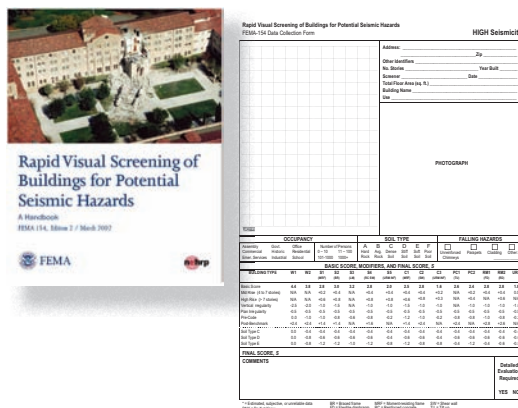

■ Figure 23. FEMA 154, a technical resource containing forms and standardized guidance on compiling an inventory. —FEMA 154, *Rapid Visual Screening of Buildings for Potential Seismic Hazards: A Handbook*

relevant information for a screening program restricted to unreinforced masonry buildings. Any inventory needs to include not only the overall quantity of unreinforced masonry buildings, but also their locations, ownership and physical characteristics, as well as social or city planning factors. Typically, a building department and planning department of the jurisdiction are key actors in carrying out that inventory. Local structural engineers and architects can also be a valuable source of expertise and knowledge.

## Successful Programs Require Sustained Support and Leadership

More broadly, successful programs share another trait: they benefit from the sustained support and efforts of individuals and organizations that recognize the value of earthquake protection and are willing to work for it. The following conclusion, from a review of successful seismic safety programs in the United States,<sup>15</sup> outlines concisely some of the challenges that arise when addressing the unreinforced masonry building problem (Note: interested readers can find more information on social aspects of seismic safety efforts in the references cited in the passage below):

Promoting seismic safety is difficult. Earthquakes are not high on the political agenda because they occur infrequently and are overshadowed by more immediate, visible issues. Even where citizens are aware of seismic risks, taking action to improve seismic safety is difficult because costs are immediate and benefits uncertain, public safety is not visible, benefits may not occur during the tenure of current elected officials, and seismic safety lacks a significant public constituency (Olshansky and Kartez, 1998; Lambright, 1984; May, 1991; Drabek et al., 1983; Rossi et al., 1982; Wyner and Mann, 1986; Alesch and Petak, 1986; Berke and Beatley, 1992). Many factors are critical to the successful advancement of seismic safety at local and state levels. These include public advancement of the problem; persistent, skillful, and credible advocates; repeated interaction and communication among participants; availability of staff resources; linkage to other issues; occurrence of a disaster that leads to a “window of opportunity” for change; community wealth and resources; assistance from higher levels of government; and previous experience with hazards (Berke and Beatley, 1992; Olshansky and Kartez, 1998). Of these, advocacy stands out because it represents a way that individuals can make a difference.<sup>15</sup>

## Utah: Engineering Inspections Triggered by Re-roofing Projects

This program, implemented in a variety of ways by local governments across Utah, has the virtue of setting a deadline almost automatically.

The Utah Uniform Building Standard Act Rules have been amended to add a way to upgrade the earthquake resistance and general structural safety of buildings, especially unreinforced masonry ones, incrementally. When embarking on a re-roofing project, the building owner must retain an engineer to inspect the

adequacy of the building's roof-to-wall connections and the ability of its parapet walls and cornices to withstand horizontal earthquake forces. The logic behind this incremental approach is that the removal of old roofing presents an opportune time for an engineer to inspect these conditions, and that any strengthening measures would be carried out prior to re-roofing, as part of that construction project. Section R156-56-801, Statewide Amendments to the IBC (*International Building Code*), Section 58, requires that these appendages be able to withstand 75% of the force levels that are stipulated for new buildings. Portions of the building that don't perform up to that standard must be either reinforced or removed. Buildings built after 1975, when codes for new buildings began to address this seismic vulnerability in Utah, are exempt.<sup>16</sup>

Roofing materials will typically need to be replaced within a time period of twenty to forty years, and that replacement work will then trigger this retroactive seismic requirement. It is common for building codes to require retroactive upgrading of safety features, if a building is to be significantly remodeled. The reasoning is that the remodel will extend the life of the building and that in the context of a major renovation project, the safety improvements will represent only a minor cost.

## Utah: Statewide Inventory of Unreinforced Masonry Buildings

The evolving Utah program demonstrates the need to conduct an inventory of buildings as a first step in evaluating their seismic risks and the costs and methods that could best be used to retrofit them.

In 2008, the Utah legislature passed a resolution urging “the Utah Seismic Safety Commission to compile an inventory of unreinforced masonry buildings so that the quantity and extent of the problem in Utah can be determined. Be it further resolved that the Legislature urges the Utah Seismic Safety Commission to recommend priorities to address the problem in a manner that will most effectively protect the lives, property,

and economy of the state.”<sup>17</sup> Similar in some respects to the California case described below, the strategy here is first, to identify the location and size of the problem and then, to devise appropriate solutions. Utah is unique among the most highly seismic states of the United States, in that it has many single-family dwellings of unreinforced masonry construction. These smaller buildings present different (usually lesser) risks of collapse or injury, but they also could have a very high impact on the population after an earthquake, if many such housing units were unsafe to occupy, and if homeowners' investments in their homes were wiped out. In the Salt Lake Valley alone, there are over 185,000 unreinforced masonry buildings, many of them single-family residences, typically built with hollow walls that do not comply with model codes and retrofit provisions such as the *Uniform Code for Building Conservation*.<sup>18</sup>

## State of California Unreinforced Masonry Building Law: Measuring the Problem and the Progress Toward Addressing It

The California program provides one example of a state government imposing a basic requirement on local governments to identify their unreinforced masonry buildings, while leaving open a range of ways in which they can deal with that risk.

In 1986, California passed a state law requiring all local governments situated in the highest seismicity zone of the currently enforced building code to inventory their unreinforced masonry buildings, to establish a risk reduction program, and to report results to the state. At that time, that highest zone of seismicity was Zone 4 of the *Uniform Building Code*, which was used in the West and Midwest, until the nationwide *International Building Code* took effect in 2000. The geo-

graphic scope of Zone 4 in California encompasses a population of approximately 28 million people. The state sought to balance its compelling interest in seismic safety against the cost of retrofitting buildings by leaving its criteria for these new risk reduction programs loosely defined: a program could consist of as little as publishing a list of the unreinforced masonry buildings in a local jurisdiction and encouraging owners to renovate them, while posting warning signs at unretrofitted buildings. Thus, a recent review of the law concluded, “On the surface, the level of compliance with this law has been quite high with over 98 percent of the 25,900 URM buildings now in loss reduction programs. But so far, only about 70 percent of the owners have reduced earthquake risk by retrofitting in accordance with a recognized building code or by other means. Significant progress has occurred, yet many URM programs are ineffective in reducing future earthquake losses.”<sup>19</sup> Relatively few of the 25,945 URM buildings addressed by the loss reduction programs were demolished. While demolition is sometimes desirable in order to renew the building stock, it is generally wise to minimize it to avoid abruptly changing the architectural and socio-economic fabric of a city.

The local programs with the strictest requirements require actual retrofitting or demolition of the hazardous buildings. Next strictest are those programs that require owners to retain an engineer to produce an evaluation report, with actual retrofitting remaining voluntary, perhaps encouraged by incentives. The California Seismic Safety Commission has found that voluntary strengthening programs have not been effective. One can conclude either that the incentives in voluntary programs have not been great enough, or that the absence of the “stick” to go along with the “carrot” is the weakness. The lowest level of compliance with the state law, and the least effective at reducing risks, is when local governments send a letter to the building owners informing them that the local building inventory conducted under state law found their building to be of unreinforced masonry construction. These simple notices do not impose any requirement to have the building either evaluated by an engineer or upgraded. The Commission’s 2006 survey of local governments found that 52% had mandatory programs, 15% voluntary, 18% notification of owner only, with another 15% in a miscellaneous category. The Commission provides a suggested model ordinance. Once a local government makes that decision and sets time tables, the actual engineering measures required are already set in model code provisions for existing buildings.<sup>20</sup>

## Seattle, Washington: Saving Historic Buildings

This case illustrates the valuable support that an organization knowledgeable about grants and loans can provide to retrofit programs, by making funds available to bridge any funding gaps.

In the 2001 Nisqually earthquake, two-thirds of the 31 buildings that were posted as unsafe for occupancy (“red tagged”) were built of unreinforced masonry, and many were a century old. “Historic” and “unreinforced masonry” are often synonymous. After that earthquake, Historic Seattle, a non-profit advocacy organization, quickly launched a program of grants of approximately \$10,000 each to historic building owners:

the grants provided financial support for initial engineering studies, with the goal being to have owners investigate repair and upgrading alternatives in lieu of demolition. While this initiative was a reaction to an earthquake rather than a preventive program in place prior to the earthquake, it still had the effect of promoting retrofit measures to reduce earthquake risks from future earthquakes. In this case, those risks include both the risk of injury to occupants or pedestrians and the risk of irreparable damage to the buildings. Any Seattle resident who appreciates historic architecture will recognize many of the buildings that Historic Seattle helped through that program: Steil Building, McCoy’s Firehouse, Slugger Sports, Compass Center, Bread of Life Mission, Milwaukee Hotel and Alps Hotel, Hong Kong Building, Hip Sing Building, Panama Hotel, Bush Hotel, Bing Kung Building, Seattle Hebrew Academy, Trinity Parish Episcopal Church, Assay Office, Mount Baker Park Presbyterian Church, and the Cadillac Hotel.<sup>21</sup>

## Seattle, Washington: Combining Modernization with Seismic Retrofitting

The voters who were asked to fund seismic retrofits were supportive partly because the money was to be applied to essential facilities.

Thirty-two fire stations in Seattle were identified as needing modernization work that included energy conservation measures, general remodeling and in some cases, seismic upgrading. A ballot measure to approve a tax for that purpose was passed by a 69% majority of voters in 2003. The measure was introduced only two years after the Nisqually earthquake, when memories of damage

from that earthquake were fresh in the voters’ minds. Known as the Fire Facilities and Emergency Response Levy, the program integrates seismic retrofits with historic preservation requirements and with upgrading the stations to modern fire safety and other standards. The \$197 million in taxes average out to about \$73 a year in additional property tax for the owner of a median-value house.<sup>22</sup>

This program provides more than one possible lesson for other local programs. Selecting an obviously high priority public safety category of facilities likely increased voter support, as did the recency of an earthquake (although a non-earthquake disaster might also be an impetus for multi-hazard upgrades). Rather than first imposing requirements on private property owners, the local government also provided leadership by example, by dealing with vulnerabilities in its own buildings. And in packaging a variety of renovation measures along with seismic retrofitting, more cost-effective construction projects resulted.

## Oregon: A Statewide Inventory and Funding Approach for Schools and Essential Facilities

This example illustrates the value of assembling a committee or task force comprised of a variety of important community organizations.

In 2002, Oregon voters approved two seismic safety measures. One allowed the use of general obligation bonds to finance seismic upgrades of educational facilities owned by the State government (including State universities and community colleges) and local governments (local public school districts). A companion measure applied to fire, police, and hospital buildings. The educational measure followed up on a state law passed by the legislature in 2001 that required seismic evaluations of schools, using a standardized method published by FEMA.<sup>23</sup> While these laws launched Oregon on the path toward reducing seismic risks from existing buildings—URM buildings being prominent among them—no funding was provided to implement the initiatives. The Oregon Seismic Safety Policy Advisory Committee and the Division of Geology and Mineral Industries subsequently worked to obtain funding to conduct a statewide seismic evaluation of educational and emergency services buildings, and to put bonds on the ballot as needed to correct the seismic deficiencies found.<sup>24</sup>

## Berkeley and Other California Cities: Financial Incentives for Retrofitting

A “carrot and stick” approach can be more effective than using an incentive or penalty alone.

Because the City of Berkeley levies a tax of 1.5% of the selling price of real estate, it has the leverage to refund a portion of that tax, if the new owner carries out seismic retrofit work. The City will refund retrofit expenses up to one-third of that tax amount (up to 1/2% of the property value transferred) for qualifying residential properties, when the new owner completes seismic retrofit work within one year of purchase, up to a maximum refund of \$2,000. While most of the properties included in the program have been wood-frame dwellings, unreinforced masonry buildings also qualify.<sup>25</sup> In its first decade of implementation, 12,000 properties were retrofitted and rebates were issued totaling \$6 million.

A number of other California cities offer incentives, and their programs are summarized by the Association of Bay Area Governments.<sup>26</sup> These programs include tax breaks, as in the Berkeley case; waiving of building permit fees for seismic upgrades; conferring zoning benefits such as an increase in density or exemption from non-conforming parking or other conditions; low-interest or no-interest financing from publicly issued bonds or redevelopment district revenue, and; acquiring federal grant money for subsidizing retrofits. The Association of Bay Area Governments report includes information specific to unreinforced masonry buildings. A number of cities are included in that survey: Arroyo Grande, Berkeley, Fullerton, Inglewood, La Verne, Long Beach, Palo Alto, San Diego, San Jose, San Mateo, Sonoma, Torrance, Upland, Vacaville, and West Hollywood. The report also includes sample ordinances, state legislation, and other reference material.

One possible lesson to be drawn from the examples of these cities is the value of offering both a carrot and a stick, both incentives and requirements. As the California Seismic Safety Commission report<sup>19</sup> noted, incentives by themselves have not led to significant retrofitting.

## Public Schools in California: A Statewide Approach to a Special Kind of Facility

California legislation singled out schools as a high-priority type of facility. The legislation set long-term but definitive deadlines for retrofitting buildings or taking them out of service.

The Long Beach earthquake in Southern California occurred at 5:54 p.m. on Friday, March 10, 1933. The fact that it barely missed occurring while children were in school and that the public saw numerous scenes of unreinforced masonry rubble on school campuses supplied graphic proof that new earthquake regulations in the

building code were needed. Prior to this time, there were no statewide earthquake regulations in the United States, and only a handful of California cities, such as Santa Barbara, which had gone through its own earthquake disaster in 1925, had any such provisions. Precisely one month after the Long Beach earthquake, the California legislature passed the Field Act, which effectively made the State into the building department for every school constructed by local governments (local school districts). The act prevented construction of new unreinforced masonry buildings and in 1939, the Garrison Act required school districts to inventory and to design a program for reducing the hazards of all pre-Field Act buildings. These were essentially the unreinforced masonry buildings remaining on their campuses. However, this legislation did not lead to immediate retrofit efforts, and the law gave school board members immunity from liability, if they made an effort to secure funds for retrofit efforts via bond elections. One key reason for the lack of action was that there was no deadline in the Garrison Act. In 1967 and 1968, the legislature passed the Greene Acts. This action “put teeth” in the retroactive seismic safety requirements for schools by setting a 1970 deadline for producing structural evaluations of pre-1933 buildings and by prohibiting their use by students, as of 1975.<sup>27</sup>

Possible lessons for unreinforced masonry seismic safety programs include the singling out of a key public concern, such as safe schools, and the need to consider the possibility that deadlines and compliance may slip over time.

## Long Beach, California: A Pioneering Accomplishment

The persistent and skillful efforts of just one person can have a lasting effect.

Long Beach, California, where the 1933 earthquake had been centered, was the first city to enforce retroactive requirements to seismically upgrade unreinforced masonry buildings. In 1959, Edward O’Connor was the chief building official of the city, and he took upon himself the duty to identify the most hazardous of these buildings, including high-occupancy buildings like theaters, and to deliver the notice personally to the owners that they must either structurally

strengthen them or tear them down. This case-by-case approach withstood resistance, based on a California Supreme Court case that justified retroactive fire safety requirements when high risk to public safety was present (retroactive “hazard abatement”). It later developed into a long-term, systematic law and program enacted and updated by the Long Beach City Council.<sup>28</sup> Over time, as engineering developments occurred, technical details of the program evolved, but the essence of what one person began endured. By 1989, the unreinforced masonry buildings that had been rated as being in the most dangerous and intermediate dangerous categories had all been retrofitted or demolished, although there remained 560 buildings in the third category of hazard.

In addition to the mandatory regulation, the city introduced an incentive by establishing an assessment district composed of the affected properties. The establishment of the assessment district enabled the city to issue bonds, the proceeds of which would provide loans to the property owners and cover the city’s cost of implementing the financial program and the building department’s monitoring of the retrofit work. The repayment of the bonds came from assessments on the owners in the district. While owners paid the going rate for the loans, they would otherwise have been largely unavailable. Owners who defaulted on their loans could have their property foreclosed, with the city verifying in advance that there was enough value in the property to cover the loan value.<sup>29</sup>

Edward O’Connor had to go it alone, without other models of mandatory programs to refer to and without adopted engineering standards for the evaluation and retrofit of unreinforced masonry buildings. Today, those resources are available. Still applicable as a lesson of this story, however, is the need for a dedicated lead individual to push steadily for the goal of seismic safety. It is also true that the local building department will usually be the key agency implementing such efforts.

## Los Angeles, California: Evidence of the Effectiveness of Retrofits

Successful local programs vary in their sources of support, but three kinds are usually essential: a state or local structural engineering association or supportive individual engineers, the local building department, and key local government officials and legislators.

The City of Los Angeles, adjacent to the City of Long Beach and with a population over three million, launched the largest mandatory local government retroactive seismic safety program in the United States, when the City Council passed an ordinance in 1981. The law required structural upgrading, or demolition, of 14,000 unreinforced masonry buildings, excepting residential buildings that had four or fewer dwelling units.<sup>30</sup> The 1985 Mexico City earthquake that caused over 10,000 deaths motivated

the Los Angeles City Council to accelerate the time table for compliance, and by the time of the 1994 Northridge earthquake in Los Angeles, most URM buildings subject to the ordinance had been retrofitted.

The 1994 earthquake caused strong ground motion over Los Angeles and other cities of the region and “provided one of the first major tests of the performance of retrofitted unreinforced masonry (URM) buildings, and once again pointed out the vulnerability of URMs that have not been strengthened.... As would be expected,



unretrofitted URM buildings performed worse, in general, than both reinforced masonry buildings and retrofitted URM buildings. As observed in previous earthquakes, many of these buildings suffered significant structural damage and posed serious risks to life safety.”<sup>31</sup> These statements pertain to unreinforced brick buildings. The region also had some very old and historic adobe buildings, and the same engineering report just cited noted: “Historic adobe buildings in the Los Angeles area suffered a tragic loss.” These buildings, which are present in other Western and Southwestern states, have unique structural features, including the different material properties of the adobe walls and their usually larger thickness, and they require their own engineering retrofit approaches, different from those used on the more common brick building.

The large-scale program enacted by the Los Angeles ordinance catalyzed the involvement of a wide spectrum of the community, many of whom initially opposed the idea because of cost. The key to its eventual success may lie with three sets of proponents. These include its earliest advocates, the structural engineers of the region, who knew how great the risks were. With funding from the National Science Foundation, tests and analyses were conducted to develop a hazard reduction package of retrofit measures. The goal was not to bring these old buildings up to current code standards—which would be virtually an impossible task and prohibitively expensive—but to bring them up to a reasonable level of safety. The performance of buildings retrofitted to that standard in the 1994 Northridge earthquake was generally in line with that criterion, although building owners often did not understand that “hazard reduction” could be compatible with a level of damage that required expensive repairs.

The Los Angeles Department of Building and Safety also played an essential role in this program. This agency reviewed a large volume of building evaluation reports submitted by consulting engineers and approved retrofit design documents, once the program was underway. It was also responsible for reporting to the City Council on costs and progress and for initiating any legal actions against non-compliant owners.

The third source of crucial support was the Los Angeles City Council, which remained determined in passing an unpopular law. One legislator in particular, Howard Berman, maintained progress on the effort over a span of decades.

## San Luis Obispo, California: Making the Effort to Communicate with Building Owners

The goal of working toward seismic safety was combined with efforts by local agencies to support the economic development of the affected businesses.

This central California city passed its unreinforced masonry law in 1992, taking the approach of setting deadlines for mandatory retrofitting. Buildings were put into two categories, with the higher occupancy buildings having closer deadlines. Partial upgrades could be implemented, in order to extend the time permitted to come into full compliance. After

the nearby 2003 San Simeon earthquake, the city decided to accelerate retrofits of the remaining 40 unreinforced masonry buildings, which were clustered in the central business district. In the meantime, the state’s unreinforced masonry law required posting a standard hazard warning on unretrofitted unreinforced

masonry buildings. As the deadlines approached, the downtown business association and individual owners became more opposed to and concerned about mandatory retrofits. Rather than wait until conflicts flared, the city retained an Economic Development Manager, who met individually with building owners to explain requirements and to inform them of technical assistance and financial incentives available.<sup>32</sup> The original deadline for all of the buildings to be in full compliance was 2018; it has since been moved to 2012. Twenty years would seem like a reasonable timetable for compliance but in fact, many business owners ignored the program in its first decade and only seriously considered the law's requirements when the time remaining had grown short.

The City's effort to incorporate an economic development perspective into its program, rather than a building safety enforcement approach alone, is a lesson that may well be applicable elsewhere. Another lesson is that allowing a long lead time before the first deadline for compliance comes due can result in a program getting off to a slow start.

# 5

## Additional Technical Background on Unreinforced Masonry Construction

Unreinforced masonry buildings have design and construction characteristics that make them perform poorly in earthquakes. Various retrofit techniques are available to reduce their risk, ranging from low-cost solutions like anchoring masonry parapets to highly engineered solutions involving seismic isolation. This chapter details typical construction characteristics, conceptual information about the earthquake response of URM buildings, and possible retrofit solutions.

Out-of-plane forces act on a wall both inwardly and outwardly, primarily causing bending (flexural) stresses. In-plane forces, oriented parallel with the wall, cause sliding or shear stresses.

Masonry materials are intrinsically strong when compressed under the usual gravity loads but are weak in resisting earthquake forces, which make materials flex and also shear; ‘shear’ describes the tendency for a portion of the wall to slide vis-à-vis the rest. When an earthquake shakes an unreinforced masonry building, it causes the building’s walls to flex *out-of-plane* (see Figure 24) and to shear *in-plane* (see Figure 25). Unreinforced masonry is weak in resisting both of those types

of forces. Mortar is the “glue” that holds the masonry units together; however, when it eventually cracks, it does so in a brittle manner, similar to the way that the bricks crack. Generally speaking, older masonry construction was built using much weaker mortar than current building codes require. Mortar also tends to deteriorate in strength over time more than the masonry units themselves do. Thus, earthquake engineers sometimes say that in old masonry buildings, “the mortar holds the bricks apart, not together.”

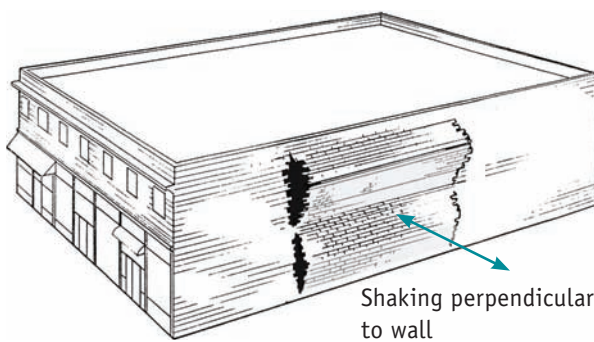

■ Figure 24. Out-of-plane failure of unreinforced masonry walls. —Rutherford and Chekene

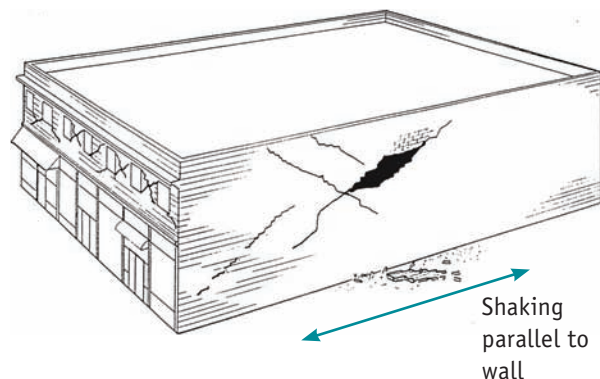

■ Figure 25. In-plane failure of unreinforced masonry walls. —Rutherford and Chekene

A common type of unreinforced masonry wall in one- or two-story buildings is approximately a foot thick and uses a pattern of brickwork called “American bond.” In this pattern, most of the bricks are laid running parallel with the wall (these are known as stretchers). Approximately every sixth horizontal row, there will be a row of bricks with their ends rather than their sides visible (these are known as headers), as illustrated in Figure 7 and Figure 8. The header courses extend into the cross-section or thickness of the wall, and they provide a strong clue that the wall is unreinforced (because there is no empty space in the middle of the wall, where reinforcing and grout could have been placed). A form of hollow cavity unreinforced brick wall also exists, which has no bricks connecting outer and inner layers. This type of masonry work is done to provide some insulation and to keep rainwater from seeping through from the outside to inside of a building. There are many patterns of brickwork, although American bond is the most common one. While engineers and building departments evaluate the strengths of unreinforced masonry walls on their individual merits, all unreinforced masonry walls are essentially “guilty until proven innocent,” when it comes to earthquake resistance. Simple field testing methods can be used to measure existing masonry strength without damaging the wall.

Unreinforced masonry, as the name implies, is masonry without reinforcing. “Reinforcing” (see Figure 26) has a very specific meaning in this context. It refers to steel reinforcing bars (rebar), which vary in diameter from approximately 3/8 inch in diameter (9.5 mm, called a #3 bar) to an inch (25 mm) or more in diameter. A bar 4/8 inch in diameter is called a #4 bar, and so on. The bars have knobs or ridges along their length to increase their adhesion or bond with concrete or grout. Grout is essentially a very fluid form of concrete, with small pea-sized gravel instead of the larger aggregate in concrete.



■ **Figure 26. A piece of #4 bar (a steel reinforcing bar that is 4/8 inch in diameter).**  
A nickname for reinforcing bar is rebar.

A reinforced masonry wall has a grid of horizontal and vertical steel reinforcing bars within the wall cross-section (see Figure 27). In reinforced brick construction, a hollow cavity is formed between an outer stack or wythe of bricks and an inner wythe, and the reinforcing is placed in this space. Grout is poured into the cavity, and when it sets, a monolithic structural sandwich forms, which is strong in resisting horizontal earthquake forces, both those forces perpendicular to and those parallel to the wall.

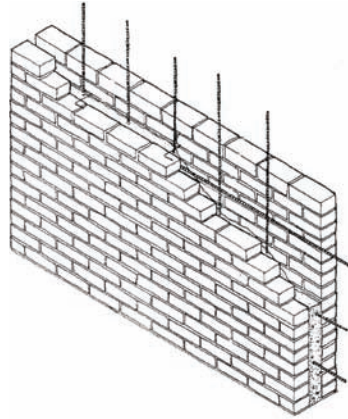

■ **Figure 27. Reinforced brick wall.** —FEMA 154, *Rapid Visual Screening of Buildings for Potential Seismic Hazards: A Handbook*

**D**uctility is the toughness of a material—its ability to crack or permanently bend out of shape, while still maintaining its structural integrity.

Reinforced masonry walls are not only much stronger than unreinforced ones: they also remain intact and stable, even if they are shaken to the point at which cracking occurs. That desirable property of *ductility* is one of the most important seismic requirements for all kinds of construction. Unreinforced

masonry, which lacks ductility, often comes apart in a brittle manner and collapses, when it is shaken severely and begins to crack.

## How Do Unreinforced Masonry Buildings Behave in Earthquakes?

The short answer to this question is that unreinforced masonry buildings, on average, perform very poorly in earthquakes. More than any other kind of construction, they can be singled out as being seismically vulnerable. The following points clarify why this is so.

**I**nertial forces are caused by rapid movements—the quick speeding up, slowing down, or turning of a car, for example—or the rapid and erratic shaking of the ground to which the building is connected.

When shaken in an earthquake, the heavy mass of masonry walls contributes to high earthquake forces. If you hold an empty cardboard box and shake it, then you don't feel much effect. Fill it with groceries, though, and shake it, and you experience large *inertial* forces, because the mass is now greater. Inertial forces are the product of the mass of an object and the acceleration of its

motions; thus, heavier (more massive) buildings generate higher forces when they are shaken. *Acceleration* indicates how much an object speeds up, slows down, or changes direction. Drop an object here on Earth, and it falls with an acceleration of 1 unit of gravity, 1 g. Shake the ground horizontally with an acceleration of 1 g, and an object that is rigidly mounted to it experiences a sideways force that is equal to its own weight. Accelerations of  $\frac{1}{2}$  g up to 1 g or more have been measured in earthquakes. It is easy to understand why people can't stand up during strong earthquake shaking, when you imagine yourself subjected to horizontal, erratic pulls equal to half or more of your body weight.

**A**cceleration is a common measure of the severity of earthquake shaking.

As a rough guide, when strong-motion seismographic instruments measure accelerations of ground shaking to be about one to two tenths of that of gravity (0.1 g to 0.2 g), then earthquake-resistant construction may suffer cracking but no serious damage. However, unreinforced masonry buildings can experience significant damage and may drop debris, such as parapets. As shaking severities approach  $\frac{1}{2}$  g or even exceed 1 g, then damage to all kinds of construction is common, but it is especially severe for unreinforced masonry buildings. The building code allows the structure to deform so much in a severe earthquake that it no longer elastically returns to its pre-earthquake position and condition. Keeping it “earthquake-proof”—that is, able to undergo strong shaking without experiencing even minor damage—would require prohibitively expensive protection for the structure and for nonstructural components such as ceilings, partitions, piping, etc. Modern buildings designed to recent building codes have successfully resisted the most severe earthquake ground motions with only repairable damage. For most kinds of modern, code-conforming construction, less than 5% is severely damaged or performs in a hazardous manner in a strong earthquake, whereas more than half of unreinforced masonry buildings typically receive that level of damage (see Chapter 2).

A cardboard box with a lid can resist much higher sideways or lateral forces than the same box without the top can resist. Building walls also need that “lid on the box,” in order to stabilize them. That role is provided by the roof and any floors above ground level. Floor and roof diaphragms hold the walls of a building together.

**D**iaphragm is the term structural engineers use to refer to floors or roofs in their roles of resisting horizontal, rather than the usual vertical, forces.

The most common kind of floor and roof in an unreinforced masonry building is wood frame, typically “two-by” lumber such as  $2 \times 10$  small beams (joists), which are usually sheathed with “one-by” boards (the use of plywood not being common until after World War II in building

construction). The wood floor or roof diaphragm of a building is, unfortunately, very flexible when compared to the stiffer masonry walls. This flexible wooden diaphragm can allow building walls to lean or bow excessively either inwardly or outwardly (out-of-plane). As the diaphragm bends sideways and vibrates back and forth, it dynamically pushes and pulls on the brick walls, increasing their motions and damage.

Individual structural elements, such as a wall and the roof, only perform adequately in earthquakes when these elements are strongly connected. The typical connection of the wood beams or joists to the unreinforced masonry walls, however, is very weak. A common construction detail used over the decades was to rest the end of a beam in a pocket or niche in the brick wall, with little or no steel hardware providing a strong, positive connection. When an unreinforced masonry building is shaken, the roof or floor framing can pull away from the walls. The walls need the roof to keep them from leaning too far and collapsing, while the roof needs the walls to support it, in order to keep from falling. Typical unreinforced masonry damage includes both the collapse of heavy masonry wall areas and the collapse of part or all of the roof or upper floors (see Figure 28).

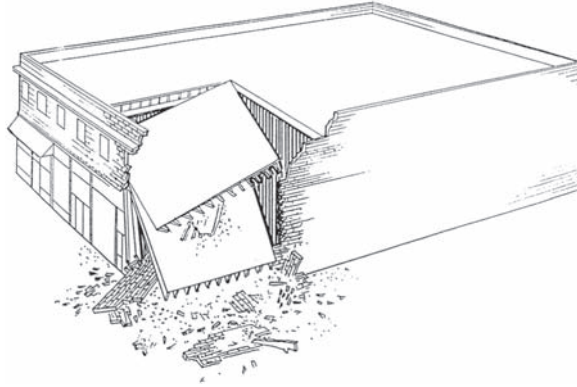

■ **Figure 28. Failure of roof-to-wall connection, with resulting collapse.** —*Rutherford and Chekene*

Chapter 2 previously mentioned the common presence of parapets, chimneys, and cornices or other decorative features on unreinforced masonry buildings. These elements do not play a structural role, but their failure can be very hazardous.

The fact that unreinforced masonry buildings often have multiple seismic weaknesses is not surprising—they were not designed to be seismically safe in the first place. By the time when American building codes started to include seismic requirements, first in California in the 1930s and slowly spreading nationwide, reinforced masonry construction techniques became increasingly standard. Strong steel connections, analysis of the overall load path that the structural elements needed to provide, and an emphasis on ductility also became increasingly standard.

Thus, unreinforced masonry buildings not only have three strikes against them from an earthquake engineering point of view—they are vulnerable for at least twice as many reasons:

1. The walls are weak in resisting horizontal forces (and they lack ductility or toughness);
2. The walls are heavy (they have high mass, leading to high inertial forces);
3. Diaphragms are excessively flexible (insufficient lateral support for the walls);
4. Diaphragm-to-wall connections are either absent or weak;
5. Parapets and ornamentation are common (and made of masonry), and;
6. The buildings were not seismically designed by an engineer (because they were built prior to the time when seismic regulations pertaining to masonry began to be enforced in that particular region).

## How Are Unreinforced Masonry Buildings Seismically Retrofitted?

Retrofitting or seismically upgrading a building, which means reconstructing portions of it, in order to improve its earthquake resistance, is not the only way to reduce risks. A building that is demolished obviously poses no further risk. One that has its occupancy changed to a lower level—for example, from a theater to a warehouse—also reduces the risk of injury. The risk of economic loss might be reduced by purchasing earthquake insurance (although it is often unavailable or very expensive for this kind of construction). In this document, however, risk reduction through structural seismic retrofit (also referred to as rehabilitation) is the focus.

A variety of retrofit measures have been included in unreinforced masonry building risk reduction programs, and one or more of those measures may be appropriate in a given case. The FEMA book, *Techniques for Seismic Rehabilitation of Existing Buildings* (FEMA 547), provides examples that relate to several kinds of construction, including unreinforced masonry bearing wall buildings.<sup>33</sup> The general standard for such retrofit measures in the United States is the *International Existing Building Code*.<sup>34</sup> The International Code Council (ICC) was formed in 2000 through the merger of the three previous model building code organizations: the Building Officials and Code Administrators (BOCA), which promulgated the *National Building Code*; the International Conference of Building Officials (ICBO), which promulgated the *Uniform Building Code* (UBC), and; the Southern Building Code Congress International (SBCCI), which promulgated the *Standard Building Code*. Prior to the establishment of the ICC code for existing buildings, the model code available with specific application to seismic retrofit projects was “Seismic Strengthening Provisions for Unreinforced Masonry Bearing Wall Buildings,” the *Uniform Code for Building Conservation* (UCBC) Appendix Chapter 1, 1997 edition, which was cross-referenced with the 1997 *Uniform Building Code*. In some cases, a local program may still use the *Uniform Code for Building Conservation* rather than the newer ICC document. Over time, it is expected that adopted versions of building codes will standardize around the ICC codes and the standards that it incorporates by reference.

Usually retrofit that offers the biggest benefit relative to its costs is the anchorage of masonry parapets, those short walls that extend a few feet above a building’s roofline. Bracing or removing these parts of the building, along with other exterior masonry appendages such as cornices, effectively addresses the type of damage that can happen even in very light shaking. The most common type of bracing used is to bolt diagonal steel struts to the top of the parapet, with the bottom end of the struts anchored with bolts into the roof structure. Usually this does not change the building’s appearance from the street (see Figure 29).

Parapet safety programs do not provide protection, however, against the collapse of the building itself. The first additional increment of seismic protection, beyond parapet and appendage bracing, is provided by bolting the walls to the roof and to any floors above the ground floor level. Long steel bolts are typically inserted into holes drilled in the wall and attached to a steel angle, which in turn is bolted to the side of a wooden joist. The end of the bolt on the outside of the wall requires a large washer (the size of a teacup saucer) to prevent it from pulling through in an earthquake (see Figure 30). In many communities that have enacted seismic ret-





■ **Figure 29. Retrofit bracing of an unreinforced masonry parapet.**

Typically, diagonal bracing struts are installed behind the wall and anchored to the roof, as shown here, which makes them unobtrusive.

—Federal Emergency Management Agency

■ **Figure 30. Generic wall-diaphragm connection retrofit detail.** —FEMA 547, *Techniques for the Seismic Rehabilitation of Existing Buildings*

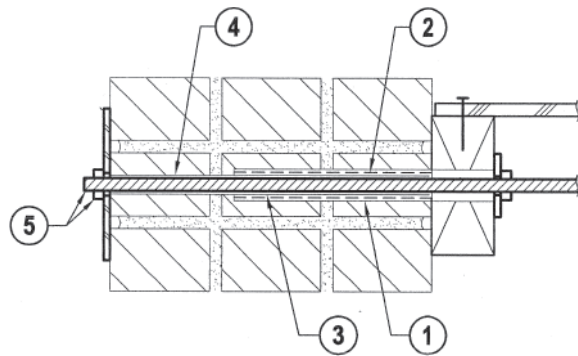

rofit ordinances, the row of these washers running along the roofline indicates the presence of this kind of retrofit. Similar-looking steel washers may be part of an older building’s construction. In general, old, pre-seismic-code wall-joist anchors are not found to be adequate.

The next additional increment of earthquake protection is provided by conducting a more thorough engineering examination of the entire building structure. This examination might reveal the need to increase the horizontal stiffness of floors and the roof, which is typically accomplished by adding a layer of sheathing (sheets of plywood or oriented-strand board). New columns (posts) may be added that can hold up the floors and roof, even if portions of the bearing wall fail. The brick or concrete block walls themselves cannot be transformed into modern reinforced masonry construction. However, walls can be strengthened by several techniques, making them stronger, even if not as strong as new, reinforced masonry walls. One available technique is to add a layer of reinforced concrete to the inside or outside of the wall, as shown in Figure 31.

**S**trongbacks are vertical “splints” that retrofit a wall to increase its out-of-plane resistance to horizontal forces.

Another approach is to install columns attached to the walls, which act like splints or *strongbacks* that brace the wall against excessively bowing outward or inward (see Figure 32). Yet another wall strengthening method is to drill holes down through the wall from top to bottom, using machinery adapted from the oil well industry to insert a steel bar and grout. Interior partitions can also help to stiffen the overall box structure and can damp out or absorb its vibrations. Each retrofit brings its



■ **Figure 31. California Capitol Retrofit.**

An exhibit shows a cut-away view of the reinforced concrete that is anchored into the brickwork with epoxied reinforcing bars. —*Robert Reitherman*

■ **Figure 32. A retrofitted lateral-force-resisting post (strongback).**

The strongback column spans from foundation to roof, serving to brace a brick wall against out-of-plane forces. —*Consortium of Universities for Research in Earthquake Engineering*

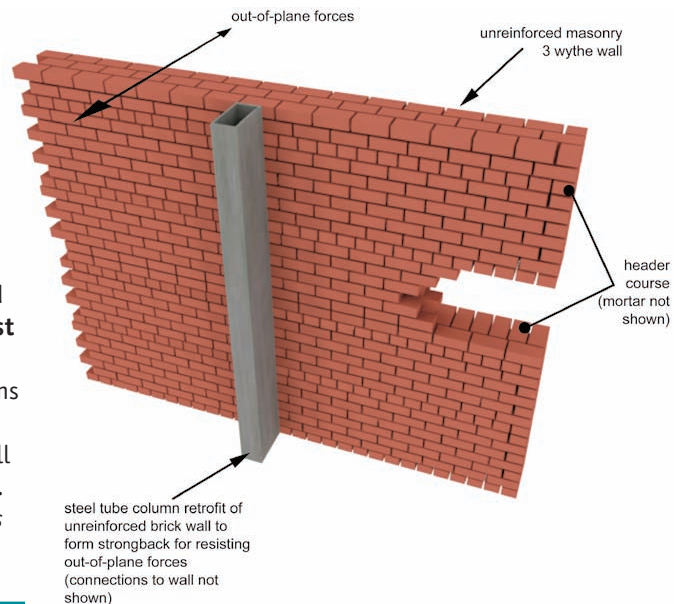

own challenges. For example, a church with an unreinforced masonry spire may need to insert steel trusswork inside the tower to brace it adequately.

Seismic isolation devices can be employed in combination with any of the above techniques. These devices are “shock absorbers” manufactured for the specific purpose of being installed between a building’s superstructure and foundation; they soften and reduce the motion of the ground, as it comes up into the building structure. Prominent examples of this kind of retrofit being applied to prominent historic buildings that contain unreinforced masonry include the Salt Lake City and County Building and San Francisco City Hall (see Figure 33).

One can’t simply take the building code regulations for new buildings and extract particular features to guide the retrofitting of existing buildings. In fact, these kinds of retrofits require design criteria developed specifically for existing buildings. The *Uniform Code for Building Conservation* and the *ICC International Existing Building Code* evolved to meet that need. Local communities have also adopted a number of different code rules for unreinforced masonry retrofits; some of these are described in Chapter 4. Codes also typically have “triggers” that require much more significant overall building upgrading if a building remodel exceeds a particular threshold. For example, code requirements might be triggered if the cost of the new work exceeds some percentage of the value of the existing building.



■ **Figure 33. The San Francisco City Hall seismic retrofit, which includes seismic isolators.** —*Robert Reitherman*

These requirements may address concerns beyond the seismic safety concern that motivated an earthquake retrofit. Issues such as handicapped access, exits, energy conservation, removal of hazardous materials such as asbestos, and so on can come into play. Deciding on the level of required seismic retrofitting that is appropriate relative to its associated costs is a big part of developing any risk reduction program.

Retrofits require an engineer’s expertise to design the changes to the construction. There are many kinds of engineer; in this instance, we are referring to civil engineers with structural engineering expertise. In some states, “structural engineer” is a license or professional registration category, while in other states, the term is used more generically. Seismic retrofits are significant remodels that require building permits, and thus building departments must review plans and issue permits. The technical community—the consulting structural engineers, building departments, architects, and contractors—are essential to any successful unreinforced masonry building risk reduction program, but they can’t implement such measures by themselves. The guidance in Chapter 3, “Developing a Strategy for Implementing a URM Risk Reduction Program,” and in Chapter 4, “Examples of Successful Risk Reduction Programs,” makes it clear that key non-technical sectors of the community must be involved and exert leadership.



# 6

## Sources of Information

In addition to the cited references, the following sources of information may be useful to consult for further information.

Note that all of the documents published by FEMA listed here are available as downloads and can often be mailed in printed form, upon request. A much larger number of earthquake publications than are listed here are available from FEMA. See: <http://www.fema.gov/plan/prevent/earthquake/>.

### Publications for the General Public

**California Seismic Safety Commission, "Status of the Unreinforced Masonry Building Law: 2006 Progress Report to the Legislature," California Seismic Safety Commission, Sacramento, California;** <http://www.seismic.ca.gov/pub.html>.

In concise form, this report indicates the types of programs being used in California and their success rates.

**Oregon Department of Land Conservation and Development, *Natural Hazard Technical Resource Guide*, Salem, Oregon, July 2000;** [http://oregon.gov/LCD/HAZ/docs/earthquakes/08\\_seismic.pdf](http://oregon.gov/LCD/HAZ/docs/earthquakes/08_seismic.pdf).

This booklet explains to the public the nature of the various natural hazards in Oregon and what is being done about them. Examples of programs to reduce the earthquake hazards of existing buildings are included, along with a review of legislative bills that were drafted to require seismic inventories of buildings. It points the reader toward further sources of information.

**Utah Seismic Safety Commission, "The Utah Guide for the Seismic Improvement of Unreinforced Masonry Dwellings" (n.d.);** <http://ussc.utah.gov/utahseismic>.

This booklet exists as a web-based document for the general public. It promotes the idea of producing web-accessible public information products as part of a seismic risk reduction program, with the twin advantages of lowering costs (eliminating printing and distribution costs once the document is produced) and appealing to the increasing number of people who turn to the web as their first source of information. It may also be advisable to have printed versions of such documents available, for example, to hand out at meetings, to reach those who do not usually use the web, and to reach additional audiences such as those who pick up a copy when waiting at the counter of a building or planning department.

**Utah Seismic Safety Commission, “Putting Down Roots in Earthquake Country: Your Handbook for Earthquakes in Utah,” 2008; <http://ussc.utah.gov>.**

This booklet is a customized version of a publication developed for California residents by the Southern California Earthquake Center, the U.S. Geological Survey, and the Federal Emergency Management Agency. It includes an explanation of the hazard of earthquake shaking and fault rupture in Utah and information on unreinforced masonry.

## Historic Buildings and Seismic Retrofits

**California Historical Building Code (Part 8, Title 24 of California law), California Building Standards Commission, 2007; <http://www.dsa.dgs.ca.gov/SHBSB/default.htm>.**

This is the generally prevailing code used for historical buildings in California, though not required statewide, and is now correlated with the provisions of the 2006 *International Building Code*. It allows more latitude in seismic retrofitting of historic buildings than apply to non-historic building projects.

**Rachel Cox, *Controlling Disaster: Earthquake-Hazard Reduction for Historic Buildings*, National Trust for Historic Buildings, Washington, DC 2001; <http://www.preservationbooks.org>.**

An introduction to the topic and guide to further resources.

## Building Inventories and Evaluation of Existing Buildings

**American Society of Civil Engineers, *Seismic Evaluation of Existing Buildings—ASCE 31-03*, Reston, Virginia, 2002; ordering information: <http://pubs.asce.org/books/standards/>.**

This standard was developed for the use of structural engineers and building departments in applying consistent criteria and calculation methods to the seismic evaluation of existing buildings, that is, the process of deciding whether an existing building is deficient in particular ways and requires strengthening. It covers all kinds of buildings.

**Applied Technology Council, *Rapid Visual Screening of Buildings for Potential Seismic Hazards: A Handbook—FEMA 154*, second edition, Federal Emergency Management Agency, Washington, DC, 2002; <http://www.fema.gov/plan/prevent/earthquake/>.**

A guide to the subject concerning all types of buildings, but with a chapter specific to unreinforced masonry bearing wall buildings. Includes sample data collection forms and guidance on field methods to identify unreinforced masonry buildings.

## Building Codes, Standards, Guidelines, and Laws Applicable to Existing Buildings

**American Society of Civil Engineers, *Seismic Rehabilitation of Existing Buildings*—ASCE/SEI 41/06, Reston, Virginia, 2007; ordering information: <http://pubs.asce.org/books/standards/>.**

This standard was developed for use by structural engineers and building departments after the decision is made to strengthen (rehabilitate) a building, and it is not limited to unreinforced masonry. It includes guidance to the engineer on how to give appropriate earthquake engineering “credit” to older kinds of structural components that are not included in modern building codes and how to analyze them. Forerunner publications to this standard include documents known as FEMA 273, and FEMA 356.

**Association of Bay Area Governments, *Seismic Retrofit Incentive Programs, Oakland, California*; <http://www.abag.ca.gov/bayarea/eqmaps/incentives>**

This report focuses on incentives, but it also includes summaries of several local government ordinances.

**California Seismic Safety Commission, “Status of the Unreinforced Masonry Building Law: 2006 Progress Report to the Legislature,” California Seismic Safety Commission, Sacramento, California; <http://www.seismic.ca.gov/pub.html>.**

Includes a summary of this state law, passed in 1986. Also mentioned above, under Publications for the General Public.

**International Code Council, *International Existing Building Code, 2006 edition, Washington, DC; ordering information: <http://www.iccsafe.org/>***

This is derived from the earlier *Uniform Code for Building Conservation*, which may still be the locally applicable standard, depending upon the jurisdiction.

**Rutherford & Chekene, *Techniques for the Seismic Rehabilitation of Existing Buildings*—FEMA 547, Federal Emergency Management Agency, October 2006; <http://www.fema.gov/plan/prevent/earthquake/>.**

Written for engineers and building department personnel, this manual deals in Chapter 21 with specific retrofit measures for unreinforced masonry buildings, ranging from bracing parapets and veneer to reinforced concrete and fiber-reinforced polymer methods of strengthening walls. Includes generic engineering details of the various retrofit alternatives.

*Uniform Code for Building Conservation, Appendix Chapter 1, International Code Conference, Washington, DC, 1997; ordering information: <http://www.iccsafe.org/>*

Originally published by the International Conference of Building Officials, the organization promulgating the *Uniform Building Code*, prior to the merger of model code organizations into the International Code Council. The *Uniform Code for Building Conservation* is formatted to be compatible with the 1997 *Uniform Building Code*.

## Costs of Seismic Retrofits

**Federal Emergency Management Agency, “FEMA Seismic Rehabilitation Cost Estimator,” FEMA Seismic Rehabilitation Cost Estimator; <http://www.fema.gov/srce/index.jsp>**

The user of this web-based calculator can either use a simplified method requiring little input information or a more advanced method that requires selections among more variables.

**Hart Consultant Group, Inc., *Typical Costs for Seismic Rehabilitation of Buildings, Volume 1, Summary—FEMA 156, and Volume 2, Supporting Documentation—FEMA 157, Federal Emergency Management Agency, Washington DC, 1994-1995, second edition; <http://www.fema.gov/plan/prevent/earthquake/>.***

A study of completed seismic upgrade projects to derive cost statistics.

**Rutherford & Chekene, *Seismic Retrofitting Alternatives for San Francisco’s Unreinforced Masonry Buildings: Estimates of Construction Cost and Seismic Damage, San Francisco Department of City Planning, 1990.***

A study which grouped the city’s 2,000 unreinforced masonry buildings into categories based on occupancy, size, and configuration, in order to estimate what kinds of retrofits would be needed to meet alternative proposed strengthening criteria, listed with associated costs.



# 7

## End Notes and Cited References

1. The *International Building Code*, promulgated by the International Code Council, obtains its seismic criteria for where particular types of structural systems can be used from ASCE 7-05, *Minimum Design Loads for Buildings and Other Structures* (ASCE/SEI 7-05 including Supplement No. 1), American Society of Civil Engineers, Reston, Virginia, 2006. The map in Figure 1 of this document is based on several assumptions, including: (1) Occupancies up through III in Table 1-1 of ASCE 7-05, which does not include fire stations, hospitals, or other essential facilities; (2) a short-period site coefficient,  $F_a$ , of 1.75 (Table 11.4-1), based on the mapped short-period Maximum Considered Earthquake ( $S_S$ ); and (3) the design spectral short-period accelerations ( $S_{DS}$ ) must be less than 0.33 for Seismic Design Category B to apply (Table 11.6-1), and with the above assumptions, the maximum  $S_S$  of 0.33 is rounded here to 0.3 for mapping purposes. For essential occupancies or for very soft soil, the red areas on the map would expand.
2. Architectural Resources Group, *An Assessment of Damage Caused to Historic Resources by the Loma Prieta Earthquake*, National Trust for Historic Preservation, Washington, DC, August 1990, p. 40.
3. The Federal Emergency Management Agency has published a number of publications that deal with a variety of kinds of buildings, and also for utility and transportation systems. See <http://www.fema.gov/plan/prevent/earthquake/>. FEMA publication number 736, "Catalog of FEMA Earthquake Resources," available at that website, provides the complete list.
4. Statistics are compiled from the 1886 Charleston, 1906 San Francisco, 1925 Santa Barbara, 1933 Long Beach, 1971 San Fernando, and 1983 Coalinga earthquakes, in districts where the Modified Mercalli Intensity was approximately VII or greater. Data for the 1886 Charleston earthquake from H.C. Stockdell, H. C. et al., *Record of Earthquake Damages*, Winham & Lester Publishers, Atlanta, Georgia, 1886. Data for the 1925 Santa Barbara earthquake in Karl V. Steinbrugge, *Earthquakes, Volcanoes, and Tsunamis: An Anatomy of Hazards*, Skandia America, New York, New York, 1982, p. 306. Data for the other earthquakes from the compilation in Robert Reitherman, "Seismic Damage to Unreinforced Masonry Buildings," Final Report to the National Science Foundation, Scientific Service, Inc., Redwood City, California, 1984, p. 23.
5. H.C. Stockdell, et al., *Record of Earthquake Damages*, Winham & Lester Publishers, Atlanta, Georgia, 1886; figure for the demolitions from John R. Freeman, *Earthquake Damage*, McGraw-Hill, New York, New York, 1932, p. 284.
6. Karl Steinbrugge, *Earthquakes, Volcanoes, and Tsunamis: An Anatomy of Hazards*, Skandia America Group, New York, 1982, p. 306.

7. C. D. Wailes and A. C. Horner, "Earthquake Damage Analyzed by Long Beach Officials," *Engineering News-Record*, May 25, 1933.
8. Robert Reitherman, Gregor Cuzner, T.C. Zsutty, and Gretchen Smith, "Performance of Unreinforced Masonry Buildings," *Coalinga, California, Earthquake of May 2, 1983*, Earthquake Engineering Research Institute, Oakland, California, 1984, p. 132.
9. Architectural Resources Group, *An Assessment of Damage Caused to Historic Resources by the Loma Prieta Earthquake*, National Trust for Historic Preservation, Washington, DC, 1990, p. 29.
10. Nisqually Earthquake Clearinghouse Group, *The Nisqually Earthquake of 28 February 2001: Preliminary Reconnaissance Report*, p. 11.
11. California Seismic Safety Commission, "Findings and Recommendations from the San Simeon Earthquake of December 22, 2003," California Seismic Safety Commission, Sacramento, California; <http://www.seismic.ca.gov/pub.html>.
12. Federal Emergency Management Agency, "FEMA Seismic Rehabilitation Cost Estimator," <http://www.fema.gov/srce/index.jsp>.
13. Hart Consultant Group, Inc., *Typical Costs for Seismic Rehabilitation of Buildings, Volume 1, Summary—FEMA 156, and Volume 2—FEMA 157, Supporting Documentation*, Federal Emergency Management Agency, Washington DC, 1994-1995, second edition; <http://www.fema.gov/plan/prevent/earthquake/>.
14. Applied Technology Council, *Rapid Visual Screening of Buildings for Potential Seismic Hazards: A Handbook—FEMA 154*, second edition, Federal Emergency Management Agency, Washington, DC, 2002; <http://www.fema.gov/plan/prevent/earthquake/>.
15. Robert Olshansky, "Making a Difference: Stories of Successful Seismic Safety Advocates," *Earthquake Spectra*, Volume 21, No. 2, May 2005; <http://www.urban.illinois.edu/faculty/olshansky/index.html>.
16. The Utah law; <http://www.dopl.utah.gov/laws/R156-56.pdf>.
17. The Utah resolution H.J.R. 7; <http://le.utah.gov/~2008/bills/hbillenr/hjr007.pdf>.
18. Personal communication from Barry Welliver, former Chair, Utah Seismic Safety Commission, June 23, 2009.
19. California Seismic Safety Commission, "Status of the Unreinforced Masonry Building Law: 2006 Progress Report to the Legislature," California Seismic Safety Commission, Sacramento, California; <http://www.seismic.ca.gov/pub.html>.
20. The original referenced standard was the *Uniform Code for Building Conservation*, Appendix Chapter 1, published by the International Conference of Building Officials. After the three U.S. model code groups merged in 2000 to form the *International Code Council* and to promulgate the *International Building Code*, the relevant existing building code became the *International Existing Building Code* of 2006.
21. Historic Architecture, Seattle, Washington; <http://www.historicseattle.org/advocacy/nisqually.aspx>.

22. Levy Oversight Committee, “Status Report, July 17 2008,” Fleets and Facilities Department, City of Seattle, Washington; <http://www.seattle.gov/fleetsfacilities/firelevy/about.htm>.
23. Robert Olshansky, “Making a Difference: Stories of Successful Seismic Safety Advocates,” *Earthquake Spectra*, Volume 21, No. 2, May 2005; <http://www.urban.illinois.edu/faculty/olshansky/index.html>.
24. Yumei Wang and Bill Burns, “Case History on the Oregon GO Bond Task Force: Promoting Earthquake Safety in Public Schools and Emergency Facilities,” *Proceedings of the 8th National US Earthquake Conference*, Earthquake Engineering Research Institute, Oakland, California, 2006; <http://www.oregon-geology.org/sub/projects/rvs/EERI-GO-Bond-text.pdf>.
25. Real Property Transfer Tax—Seismic Retrofit Fund, City of Berkeley; <http://www.ci.berkeley.ca.us/ContentDisplay.aspx?id=6282>.
26. Association of Bay Area Governments, *Seismic Retrofit Incentive Programs*, Oakland, California; <http://www.abag.ca.gov/bayarea/eqmaps/incentives>.
27. Daniel Barclay, “Assessing Seismic Safety Policy,” *Massachusetts Institute of Technology Undergraduate Research Journal*, Volume 10, Spring 2004; <http://web.mit.edu/murj/www/v10/v10-Features/v10-f2.pdf>.
28. Edward M. O’Connor, “An Interview With Edward M. O’Connor: Retroactive Regulations in Long Beach,” Robert Reitherman, interviewer, *Building Standards*, International Conference of Building Officials, September-October, 1984.
29. Association of Bay Area Governments, *Seismic Retrofit Incentive Programs*, Oakland, California; <http://www.abag.ca.gov/bayarea/eqmaps/incentives/>. See pages 25-34.
30. Daniel Alesch and William Petak, *The Politics and Economics of Earthquake Hazard Mitigation: Unreinforced Masonry Buildings in Southern California*, Natural Hazards Center, University of Colorado, Boulder, 1986; <http://www.colorado.edu/hazards/publications/monographs/monopubs.html> - 1980.
31. William T. Holmes and Peter Somers, editors, *Northridge Earthquake of January 17, 1994 Reconnaissance Report—Volume 2*, *Earthquake Spectra*, supplement C to Volume 11, January 1996, p. 195-217.
32. City of San Luis Obispo, “Unreinforced Masonry Hazard Mitigation Program,” <http://www.ci.san-luis-obispo.ca.us/economicdevelopment/seismiccoord.asp>; City Manager, City of San Luis Obispo, “Draft Outline of Seismic Safety Ordinance Update,” [http://www.prcity.com/government/citycouncil/agenda-items/2004/March/2004\\_03-16\\_CC\\_ITM\\_17.pdf](http://www.prcity.com/government/citycouncil/agenda-items/2004/March/2004_03-16_CC_ITM_17.pdf).
33. Rutherford & Chekene, *Techniques for the Seismic Rehabilitation of Existing Buildings—FEMA 547*, Federal Emergency Management Agency, October 2006; <http://www.fema.gov/plan/prevent/earthquake/>.
34. International Code Council, *International Existing Building Code*, 2006 edition, Washington, DC; ordering information: <http://www.iccsafe.org/>.



---

# 8

## Project Participants

### **FEMA Project Monitor**

Cathleen M. Carlisle  
Federal Emergency Management Agency  
500 C Street, SW  
Washington, DC 24072

### **Project Manager**

Thomas R. McLane  
Applied Technology Council  
2111 Wilson Blvd., Suite 700  
Arlington, Virginia 22201

### **Principal Authors**

Robert K. Reitherman  
Consortium of Universities for Research in  
Earthquake Engineering  
1301 South 46th St., Building 420  
Richmond, California 94804

Sue C. Perry  
U.S. Geological Survey  
525 So. Wilson Avenue  
Pasadena, California 91106

### **Project Review Panel**

Ronald P. Gallagher  
R P Gallagher Associates, Inc.  
519 17th Street, Suite 220  
Oakland, California 94612

Jon A. Heintz  
Applied Technology Council  
201 Redwood Shores Parkway, Suite 240  
Redwood City, California 94065

William T. Holmes  
Rutherford & Chekene  
55 Second Street, Suite 600  
San Francisco, California 94105

Ugo Morelli  
2700 Calvert Street, NW, #314  
Washington, DC 20008

Lawrence D. Reaveley  
University of Utah  
Dept. of Civil and Environmental Eng'g  
160 S. Central Campus Drive, Room 104  
Salt Lake City, Utah 84112-0561

Christopher Rojahn  
Applied Technology Council  
201 Redwood Shores Parkway, Suite 240  
Redwood City, California 94065

### **Editor**

Kristen Yawitz  
1923 Lyon Avenue  
Belmont, California 94002