

CONSUMER PRODUCT SAFETY COMMISSION

16 CFR Part 1422

RIN 3041-AC78

[Docket No. CPSC-2009-0087]

Safety Standard for Recreational Off-Highway Vehicles (ROVs)

AGENCY: Consumer Product Safety Commission.

ACTION: Notice of Proposed Rulemaking.

SUMMARY: The U.S. Consumer Product Safety Commission has determined preliminarily that there may be an unreasonable risk of injury and death associated with recreational off-highway vehicles (ROVs). To address these risks, the Commission proposes a rule that includes: lateral stability and vehicle handling requirements that specify a minimum level of rollover resistance for ROVs and require that ROVs exhibit sublimit understeer characteristics; occupant retention requirements that would limit the maximum speed of an ROV to no more than 15 miles per hour (mph), unless the seat belts of both the driver and front passengers, if any, are fastened, and would require ROVs to have a passive means, such as a barrier or structure, to limit further the ejection of a belted occupant in the event of a rollover; and information requirements.

DATES: Submit comments by February 2, 2015.

ADDRESSES: You may submit comments, identified by Docket No. CPSC-2009-0087, by any of the following methods:

Electronic Submissions: Submit electronic comments to the Federal eRulemaking Portal at: <http://www.regulations.gov>. Follow the instructions for submitting comments. The Commission does not accept comments submitted by electronic mail (email), except through www.regulations.gov. The Commission encourages you to submit electronic comments by using the Federal eRulemaking Portal, as described above.

Written Submissions: Submit written submissions by mail/hand delivery/courier to: Office of the Secretary, Consumer Product Safety Commission, Room 820, 4330 East West Highway, Bethesda, MD 20814; telephone (301) 504-7923.

Instructions: All submissions received must include the agency name and docket number for this notice. All comments received may be posted without change, including any personal identifiers, contact information, or other personal information provided, to: <http://www.regulations.gov>. Do not

submit confidential business information, trade secret information, or other sensitive or protected information that you do not want to be available to the public. If furnished at all, such information should be submitted in writing.

Docket: For access to the docket to read background documents or comments received, go to: <http://www.regulations.gov>, and insert the docket number CPSC-2009-0087, into the "Search" box, and follow the prompts.

Submit comments related to the Paperwork Reduction Act (PRA) aspects of the proposed rule to the Office of Information and Regulatory Affairs, Attn: OMB Desk Officer for the CPSC or by email:

OIRA_submission@omb.eop.gov or fax: 202-395-6881. In addition, comments that are sent to OMB also should be submitted electronically at <http://www.regulations.gov>, under Docket No. CPSC-2009-0087.

FOR FURTHER INFORMATION CONTACT:

Caroleene Paul, Project Manager, Directorate for Engineering Sciences, Consumer Product Safety Commission, 5 Research Place, Rockville, MD 20850; telephone: 301-987-2225; email: cpaul@cpsc.gov.

SUPPLEMENTARY INFORMATION:

I. Background

The U.S. Consumer Product Safety Commission (Commission or CPSC) is proposing a standard for recreational off-highway vehicles (ROVs).¹ ROVs are motorized vehicles that combine off-road capability with utility and recreational use. Reports of ROV-related fatalities and injuries prompted the Commission to publish an advance notice of proposed rulemaking (ANPR) in October 2009 to consider whether there may be unreasonable risks of injury and death associated with ROVs. (74 FR 55495 (October 28, 2009)). The ANPR began a rulemaking proceeding under the Consumer Product Safety Act (CPSA). The Commission received 116 comments in response to the ANPR. The Commission is now issuing a notice of proposed rulemaking (NPR) that would establish requirements for lateral stability, vehicle handling, and occupant protection performance, as well as information requirements. The information discussed in this preamble

¹ The Commission voted (3-2) to publish this notice in the **Federal Register**. Chairman Elliot F. Kaye and Commissioners Robert S. Adler and Marietta S. Robinson voted to approve publication of the proposed rule. Commissioners Ann Marie Buerkle and Joseph P. Mohorovic voted against publication of the proposed rule.

is derived from CPSC staff's briefing package for the NPR and from CPSC staff's supplemental memorandum to the Commission, which are available on CPSC's Web site at <http://www.cpsc.gov/Global/Newsroom/FOIA/CommissionBriefingPackages/2014/SafetyStandardforRecreationalOff-HighwayVehicles-ProposedRule.pdf> and <http://www.cpsc.gov/Global/Newsroom/FOIA/CommissionBriefingPackages/2015/SupplementalInformation-ROVs.pdf>.

II. The Product

A. Products Covered

ROVs are motorized vehicles designed for off-highway use with the following features: Four or more pneumatic tires designed for off-highway use; bench or bucket seats for two or more occupants; automotive-type controls for steering, throttle, and braking; and a maximum vehicle speed greater than 30 miles per hour (mph). ROVs are also equipped with rollover protective structures (ROPS), seat belts, and other restraints (such as doors, nets, and shoulder barriers) for the protection of occupants.

ROVs and All-Terrain Vehicles (ATVs) are similar in that both are motorized vehicles designed for off-highway use, and both are used for utility and recreational purposes. However, ROVs differ significantly from ATVs in vehicle design. ROVs have a steering wheel instead of a handle bar for steering; foot pedals instead of hand levers for throttle and brake control; and bench or bucket seats rather than straddle seating for the occupant(s). Most importantly, ROVs only require steering wheel input from the driver to steer the vehicle, and the motion of the occupants has little or no effect on vehicle control or stability. In contrast, ATVs require riders to steer with their hands and to maneuver their body front to back and side to side to augment the ATV's pitch and lateral stability.

Early ROV models emphasized the utility aspects of the vehicles, but the recreational aspects of the vehicles have become very popular. Currently, there are two varieties of ROVs: Utility and recreational. Models emphasizing utility have larger cargo beds, higher cargo capacities, and lower top speeds. Models emphasizing recreation have smaller cargo beds, lower cargo capacities, and higher top speeds. Both utility and recreational ROVs with maximum speed greater than 30 mph are covered by the scope of this NPR.

B. Similar or Substitute Products

There are several types of off-road vehicles that have some characteristics

that are similar to those of ROVs and may be considered substitutes for some purposes.

Low-Speed Utility vehicles (UTVs)—Although ROVs can be considered to be a type of utility vehicle, their maximum speeds of greater than 30 mph distinguish them from low-speed utility vehicles, which have maximum speeds of 25 mph or less. Like ROVs, low-speed utility vehicles have steering wheels and bucket or bench seating capable of carrying two or more riders. All utility vehicles have both work and recreational uses. However, low-speed utility vehicles might not be good substitutes for ROVs in recreational uses where speeds higher than 30 mph are important.

All-terrain vehicles (ATVs)—Unlike ROVs, ATVs make use of handlebars for steering and hand controls for operating the throttle and brakes. The seats on ATVs are intended to be straddled, unlike the bucket or bench seats on ROVs. Some ATVs are intended for work or utility applications, as well as for recreational uses; others are intended primarily for recreational purposes. ATVs are usually narrower than ROVs. This means that ATVs can navigate some trails or terrain that some ROVs might not be able to navigate.

Unlike ROVs, ATVs are rider interactive. When riding an ATV, the driver must shift his or her weight from side to side while turning, or forward or backward when ascending or descending a hill or crossing an obstacle. Most ATVs are designed for one rider (the driver). On ATVs that are designed for more than one rider, the passenger sits behind the driver and not beside the driver as on ROVs.

Go-Karts—Go-karts (sometimes called “off-road buggies”) are another type of recreational vehicle that has some similarities to ROVs. Go-karts are usually intended solely for recreational purposes. Some go-karts with smaller engines are intended to be driven by children 12 and younger. Some go-karts are intended to be driven primarily on prepared surfaces. These go-karts would not be substitutes for ROVs. Other go-karts have larger engines, full suspensions, can reach maximum speeds in excess of 30 mph, and can be used on more surfaces. These go-karts could be close substitutes for ROVs in some recreational applications.

III. Risk of Injury

A. Incident Data

As of April 5, 2013, CPSC staff is aware of 550 reported ROV-related incidents that occurred between January 1, 2003 and April 5, 2013; there were

335 reported fatalities and 506 reported injuries related to these incidents. To analyze hazard patterns related to ROVs, a multidisciplinary team of CPSC staff reviewed incident reports that CPSC received by December 31, 2011 concerning incidents that occurred between January 1, 2003 and December 31, 2011. CPSC received 428 reports of ROV-related incidents that occurred between January 1, 2003 and December 31, 2011, from the Injury and Potential Injury Incident (IPII) and In-Depth Investigation (INDP) databases.

ROV-related incidents can involve more than one injury or fatality because the incidents often involve both a driver and passengers. There were a total of 826 victims involved in the 428 incidents. Of the 428 ROV-related incidents, there were a total of 231 reported fatalities and 388 reported injuries. Seventy-five of the 388 injuries (19 percent) could be classified as severe; that is, based on the information available, the victim has lasting repercussions from the injuries received in the incident. The remaining 207 victims were either not injured or their injury information was not known.

Of the 428 ROV-related incidents, 76 incidents involved drivers under 16 years of age (18 percent); 227 involved drivers 16 years of age or older (53 percent); and 125 involved drivers of unknown age (29 percent). Of the 227 incidents involving adult drivers, 86 (38 percent) are known to have involved the driver consuming at least one alcoholic beverage before the incident; 52 (23 percent) did not involve alcohol; and 89 (39 percent) have an unknown alcohol status of the driver.

Of the 619 victims who were injured or killed, most (66 percent) were in a front seat of the ROV, either as a driver or passenger, when the incidents occurred. The remaining victims were in the rear of the ROV or in an unspecified location of the ROV.

In many of the ROV-related incidents resulting in at least one death, the Commission was able to obtain more detailed information on the events surrounding the incident through an In-Depth Investigation (IDI). Of the 428 ROV-related incidents, 224 involved at least one death. This includes 218 incidents resulting in one fatality, five incidents resulting in two fatalities, and one incident resulting in three fatalities, for a total of 231 fatalities. Of the 224 fatal incidents, 145 (65 percent) occurred on an unpaved surface; 38 (17 percent) occurred on a paved surface; and 41 (18 percent) occurred on unknown terrain.

B. Hazard Characteristics

After CPSC staff determined that a reported incident resulting in at least one death or injury was ROV-related, a multidisciplinary team reviewed all the documents associated with the incident. The multidisciplinary team was made up of a human factors engineer, an economist, a health scientist, and a statistician. As part of the review process, each member of the review team considered every incident and coded victim characteristics, the characteristics of the vehicle involved, the environment, and the events of the incident.² Below, we discuss the key hazard characteristics that the review identified.

1. Rollover

Of the 428 reported ROV-related incidents, 291 (68 percent) involved rollover of the vehicle, more than half of which occurred while the vehicle was in a turn (52 percent). Of the 224 fatal incidents, 147 (66 percent) involved rollover of the vehicle, and 56 of those incidents (38 percent) occurred on flat terrain. The slope of the terrain is unknown in 39 fatal incidents.

A total of 826 victims were involved in the 428 reported incidents, including 231 fatalities and 388 injuries. Of the 231 reported fatalities, 150 (65 percent) died in an incident involving lateral rollover of the ROV. Of the 388 injured victims, 75 (19 percent) were classified as being severely injured; 67 of these victims (89 percent) were injured in incidents that involved lateral rollover of the ROV.

2. Occupant Ejection and Seat Belt Use

From the 428 ROV-related incidents reviewed by CPSC, 817 victims were reported to be in or on the ROV during the incident, and 610 (75 percent) were known to have been injured or killed. Seatbelt use is known for 477 of the 817 victims; of these, 348 (73 percent) were not wearing a seatbelt at the time of the incident.

Of the 610 fatally and nonfatally injured victims who were in or on the ROV, 433 (71 percent) were partially or fully ejected from the ROV; and 269 (62 percent) of these victims were struck by

² The data collected for the Commission's study are based on information reported to the Commission through various sources. The reports are not a complete set of all incidents that have occurred, nor do they constitute a statistical sample representing all ROV-related incidents with at least one death or injury resulting. Additionally, reporting is ongoing for ROV-related incidents that occurred in the specified time frame. The Commission is expecting additional reports and information on ROV-related incidents that resulted in a death or injury and that occurred in the given time frame.

a part of the vehicle, such as the roll cage or side of the ROV, after ejection. Seat belt use is known for 374 of the 610 victims; of these, 282 (75 percent) were not wearing a seat belt.

Of the 225 fatal victims who were in or on the ROV at the time of the incident, 194 (86 percent) were ejected partially or fully from the vehicle, and 146 (75 percent) were struck by a part of the vehicle after ejection. Seat belt use is known for 155 of the 194 ejected victims; of these, 141 (91 percent) were not wearing a seat belt.

C. NEISS Data

To estimate the number of nonfatal injuries associated with ROVs that were treated in a hospital emergency department, CPSC undertook a special study to identify cases that involved ROVs that were reported through the National Electronic Injury Surveillance System (NEISS) from January 1, 2010 to August 31, 2010.³

NEISS does not contain a separate category or product code for ROVs. Injuries associated with ROVs are

³ NEISS is a stratified national probability sample of hospital emergency departments that allows the Commission to make national estimates of product-related injuries. The sample consists of about 100 of the approximately 5,400 U.S. hospitals that have at least six beds and provide 24-hour emergency service. Consumer product-related injuries treated in emergency departments of the NEISS-member hospitals are coded from the medical record. As such, information about the injury is extracted, but specifics about the product and its use are often not available.

usually assigned to an ATV product category (NEISS product codes 3286—3287) or to the utility vehicle (UTV) category (NEISS product code 5044). A total of 2,018 injuries that were related to ATVs or UTVs were recorded in NEISS between January 1, 2010 and August 31, 2010. The Commission attempted follow-up interviews with each victim (or a relative of the victim) to gather more information about the incidents and the vehicles involved. CPSC determined whether the vehicle involved was an ROV based on the make and model of the vehicle reported in the interviews. If the make and model of the vehicle was not reported, staff did not count the case as involving an ROV.

A total of 688 surveys were completed, resulting in a 33 percent response rate for this survey. Of the 688 completed surveys, 16 were identified as involving an ROV based on the make and model of the vehicle involved. It is possible that more cases involved an ROV, but it was not possible to identify them due to lack of information on the vehicle make and model.

The estimated number of emergency department-treated ROV-related injuries occurring in the United States between January 1, 2010 and August 31, 2010, is 2,200 injuries. Extrapolating for the year 2010, the estimated number of emergency department-treated, ROV-related injuries is 3,000, with a corresponding 95 percent confidence interval of 1,100 to 4,900.

D. Yamaha Rhino Repair Program

CPSC staff began investigating ROVs following reports of serious injuries and fatalities associated with the Yamaha Rhino. In March 2009, CPSC staff negotiated a repair program on the Yamaha Rhino 450, 660, and 700 model ROVs to address stability and handling issues with the vehicles.⁴ CPSC staff investigated more than 50 incidents, including 46 driver and passenger deaths related to the Yamaha Rhino. The manufacturer voluntarily agreed to design changes through a repair program that would increase the vehicle's lateral stability and change the vehicle's handling characteristic from oversteer to understeer. The repair consisted of the following: (1) Addition of 50-mm spacers on the vehicle's rear wheels to increase the track width, and (2) the removal of the rear stabilizer bar to effect understeer characteristics.

CPSC staff reviewed reports of ROV-related incidents reported to the CPSC between January 1, 2003 and May 31, 2012, involving Yamaha Rhino model vehicles. (The data are only those reported to CPSC staff and are not representative of all incidents.) The number of incidents that occurred by quarters of a year are shown below in Figure 1.

⁴ CPSC Release #09-172, March 31, 2009, Yamaha Motor Corp. Offers Free Repair for 450, 660, and 700 Model Rhino Vehicles.

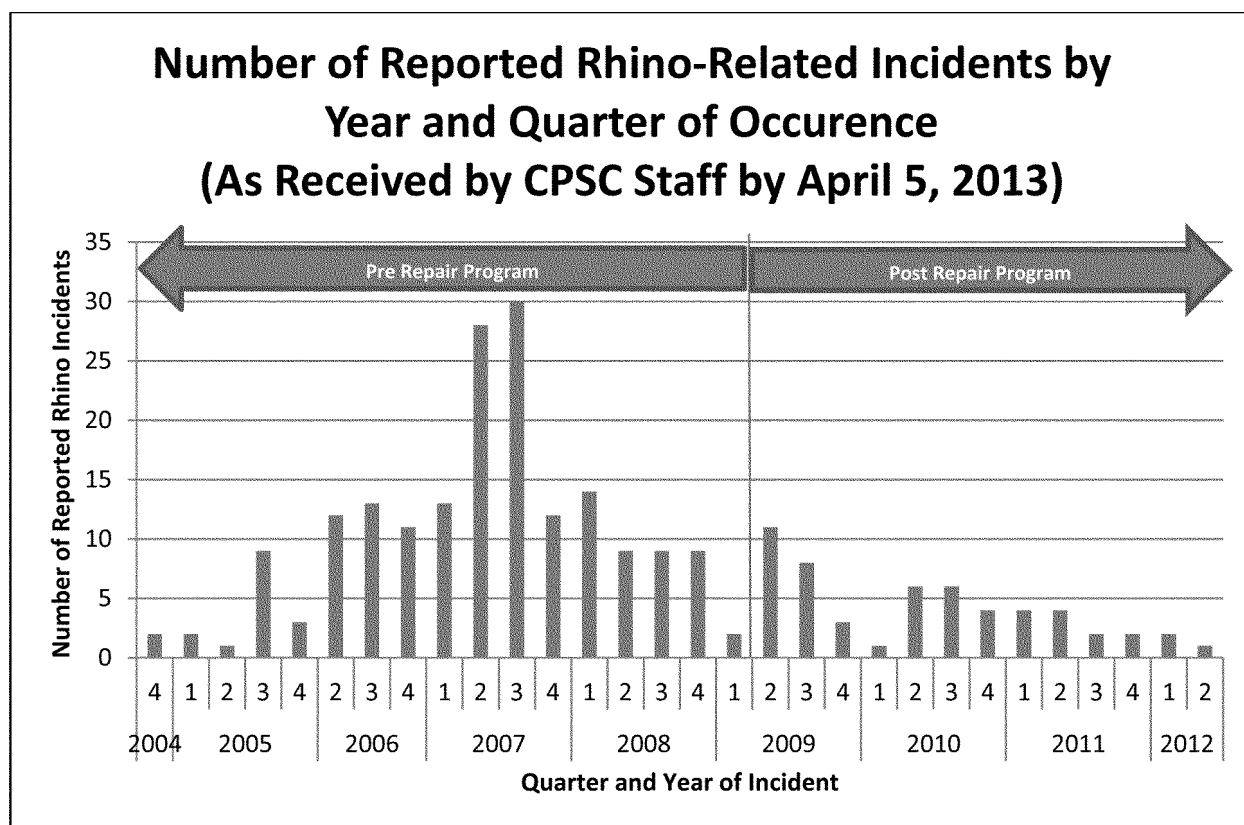

Figure 1. Number of Reported Yamaha Rhino Incidents from January 2003 to May 2012.

After the repair program was initiated in March 2009, the number of reported incidents involving a Yamaha Rhino ROV decreased noticeably.

CPSC staff also analyzed the 242 Yamaha Rhino-related incidents reported to CPSC and identified 46 incidents in which a Yamaha Rhino vehicle rolled over during a turn on flat or gentle terrain. Staff identified forty-one of the 46 incidents as involving an unrepaired Rhino vehicle. In comparison, staff identified only two of the 46 incidents in which a repaired Rhino vehicle rolled during a turn, and each of these incidents occurred on terrain with a 5 to 10 degree slope. Among these 41 reported incidents, there were no incidents involving repaired Rhinos rolling over on flat terrain during a turn.

The Commission believes the decrease in Rhino-related incidents after the repair program was initiated can be attributed to the vehicle modifications made by the repair program. Specifically, correction of oversteer and improved lateral stability can reduce rollover incidents by reducing the risk of sudden and unexpected increases in lateral acceleration during a turn, and increasing the amount of force required to roll the vehicle over. CPSC believes

that lateral stability and vehicle handling have the most effect on rollovers during a turn on level terrain because the rollover is caused primarily by lateral acceleration generated by friction during the turn. Staff's review of rollover incidents during a turn on level ground indicates that repaired Rhino vehicles are less likely than unrepaired vehicles to roll over. CPSC believes this is further evidence that increasing lateral stability and correcting oversteer to understeer contributed to the decrease in Yamaha Rhino incidents.

IV. Statutory Authority

ROVs are "consumer products" that can be regulated by the Commission under the authority of the CPSA. *See* 15 U.S.C. 2052(a). Section 7 of the CPSA authorizes the Commission to promulgate a mandatory consumer product safety standard that sets forth certain performance requirements for a consumer product or that sets forth certain requirements that a product be marked or accompanied by clear and adequate warnings or instructions. A performance, warning, or instruction standard must be reasonably necessary to prevent or reduce an unreasonable risk or injury. *Id.*

Section 9 of the CPSA specifies the procedure the Commission must follow to issue a consumer product safety standard under section 7. In accordance with section 9, the Commission may commence rulemaking by issuing an ANPR; as noted previously, the Commission issued an ANPR on ROVs in October 2009. Section 9 authorizes the Commission to issue an NPR including the proposed rule and a preliminary regulatory analysis in accordance with section 9(c) of the CPSA and request comments regarding the risk of injury identified by the Commission, the regulatory alternatives being considered, and other possible alternatives for addressing the risk. *Id.* 2058(c). Next, the Commission will consider the comments received in response to the proposed rule and decide whether to issue a final rule along with a final regulatory analysis. *Id.* 2058(c)-(f). The Commission also will provide an opportunity for interested persons to make oral presentations of the data, views, or arguments, in accordance with section 9(d)(2) of the CPSA. *Id.* 2058(d)(2).

According to section 9(f)(1) of the CPSA, before promulgating a consumer product safety rule, the Commission must consider, and make appropriate

findings to be included in the rule, concerning the following issues: (1) The degree and nature of the risk of injury that the rule is designed to eliminate or reduce; (2) the approximate number of consumer products subject to the rule; (3) the need of the public for the products subject to the rule and the probable effect the rule will have on utility, cost, or availability of such products; and (4) the means to achieve the objective of the rule while minimizing adverse effects on competition, manufacturing, and commercial practices. *Id.* 2058(f)(1).

According to section 9(f)(3) of the CPSA, to issue a final rule, the Commission must find that the rule is “reasonably necessary to eliminate or reduce an unreasonable risk of injury associated with such product” and that issuing the rule is in the public interest. *Id.* 2058(f)(3)(A)&(B). In addition, if a voluntary standard addressing the risk of injury has been adopted and implemented, the Commission must find that: (1) The voluntary standard is not likely to eliminate or adequately reduce the risk of injury, or that (2) substantial compliance with the voluntary standard is unlikely. *Id.* 2058(f)(3)(D). The Commission also must find that expected benefits of the rule bear a reasonable relationship to its costs and that the rule imposes the least burdensome requirements that would adequately reduce the risk of injury. *Id.* 2058(f)(3)(E)&(F).

Other provisions of the CPSA also authorize this rulemaking. Section 27(e) provides the Commission with authority to issue a rule requiring consumer product manufacturers to provide the Commission with such performance and technical data related to performance and safety as may be required to carry out the CPSA and to give such performance and technical data to prospective and first purchasers. *Id.* 2076(e). This provision bolsters the Commission’s authority under section 7 to require provision of safety-related information, such as hang tags.

V. Overview of Proposed Requirements

Based on incident data, vehicle testing, and experience with the Yamaha Rhino repair program, the Commission believes that improving lateral stability (by increasing rollover resistance) and improving vehicle handling (by correcting oversteer to understeer) are the most effective approaches to reducing the occurrence of ROV rollover incidents. ROVs with higher lateral stability are less likely to

roll over because more lateral force is necessary to cause rollover than an ROV with lower lateral stability. ROVs exhibiting understeer during a turn are less likely to rollover because steering control is stable and the potential for the driver to lose control is low.

The Commission believes that when rollovers do occur, improving occupant protection performance (by increasing seat belt use) will mitigate injury severity. CPSC’s analysis of ROV incidents indicates that 91 percent of fatally ejected victims were not wearing a seat belt at the time of the incident. Increasing seat belt use, in conjunction with better shoulder retention performance, will significantly reduce injuries and deaths associated with an ROV rollover event.

To address these hazards, the Commission is proposing requirements for:

- A minimum level of rollover resistance of the ROV when tested using the J-turn test procedure;
- A hang tag providing information about the vehicle’s rollover resistance on a progressive scale;
- Understeer performance of the ROV when tested using the constant radius test procedure;
- Limited maximum speed of the ROV when tested with occupied front seat belts unbuckled; and
- A minimum level of passive shoulder protection when using a probe test.

VI. CPSC Technical Analysis and Basis for Proposed Requirements

A. Overview of Technical Work

In February 2010, the Commission contracted SEA, Limited (SEA) to conduct an in-depth study of vehicle dynamic performance and static rollover measures for ROVs. SEA evaluated a sample of 10 ROVs that represented the recreational and utility oriented ROVs available in the U.S. market that year. SEA tested and measured several characteristics and features that relate to the rollover performance of the vehicles and to the vehicle’s handling characteristics.

In 2011, SEA designed and built a roll simulator to measure and analyze occupant response during quarter-turn roll events of a wide range of machines, including ROVs. The Commission contracted with SEA to conduct occupant protection performance evaluations of seven ROVs with differing occupant protection designs.⁵

B. Lateral Stability

1. Definitions

Following are definitions of basic terms used in this section.

- **Lateral acceleration:** acceleration that generates the force that pushes the vehicle sideways. During a turn, lateral acceleration is generated by friction between the tires and surface. Lateral acceleration is expressed as a multiple of free-fall gravity (g).
- **Two-wheel lift:** point at which the inside wheels of a turning vehicle lift off the ground, or when the uphill wheels of a vehicle on a tilt table lift off the table. Two-wheel lift is a precursor to a rollover event. We use the term “two-wheel lift” interchangeably with “tip-up.”
- **Threshold lateral acceleration:** minimum lateral acceleration of the vehicle at two-wheel lift.
- **Untripped rollover:** rollover that occurs during a turn due solely to the lateral acceleration generated by friction between the tires and the road surface.
- **Tripped rollover:** rollover that occurs when the vehicle slides and strikes an object that provides a pivot point for the vehicle to roll over.

2. Static Measures to Evaluate ROV Lateral Stability

CPSC and SEA evaluated the static measurements of the static stability factor (SSF) and tilt table ratio (TTR) to compare lateral stability of a group of 10 ROVs.

a. Static Stability Factor (SSF)

SSF approximates the lateral acceleration in units of gravitational acceleration (g) at which rollover begins in a simplified vehicle that is assumed to be a rigid body without suspension movement or tire deflections. NHTSA uses rollover risk as determined by dynamic test results and SSF values to evaluate passenger vehicle rollover resistance for the New Car Assessment Program (NCAP).⁶ SSF relates the track width of the vehicle to the height of the vehicle center of gravity (CG), as shown in Figure 2. Loading condition is important because CG height and track width vary, depending on the vehicle load condition. Mathematically, the relationship is track width (T) divided by two times the CG height (H), or $SSF = T/2H$. Higher values for SSF indicate higher lateral stability, and lower SSF values indicate lower lateral stability.

⁵ SEA’s reports are available on CPSC’s Web site at: <http://www.cpsc.gov/en/Research-Statistics/Sports-Recreation/ATVs/Technical-Reports/>.

⁶ NHTSA, 68 FR 59250, “Consumer Information; New Car Assessment Program; Rollover Resistance,” (Oct. 14, 2003).

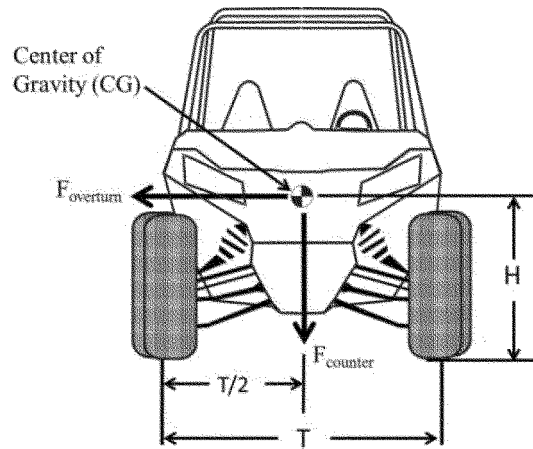

Figure 2. Components of SSF

SEA measured track width and CG height values for the sample group of 10 ROVs. SEA used their Vehicle Inertia Measurement Facility (VIMF), which incorporates the results of five different tests to determine the CG height. SEA has demonstrated that VIMF CG height measurements are repeatable within ±0.5 percent of the measured values.⁷ Using the CG height and track width measurement, SEA calculated SSF values for several different load conditions. (See Table 1).

TABLE 1—SSF VALUES

Vehicle rank (SSF)	SSF
F	0.881
A	0.887
H	0.918

TABLE 1—SSF VALUES—Continued

Vehicle rank (SSF)	SSF
B	0.932
D	0.942
J	0.962
E	0.965
C	0.991
G	1.031
I	1.045

b. Tilt Table Ratio (TTR)

SEA conducted tilt table tests on the ROV sample group. In this test, the vehicles in various loaded conditions were placed on a rigid platform, and the angle of platform tilt was increased (see Figure 3) until both upper wheels of the vehicle lifted off the platform. The

platform angle at two-wheel lift is the Tilt Table Angle (TTA). The trigonometric tangent of the TTA is the Tilt Table Ratio (TTR). TTA and TTR are used to evaluate the stability of the vehicle. Larger TTA and TTR generally correspond to better lateral stability, except these measures do not account for dynamic tire deflections or dynamic suspension compliances. Tilt testing is a quick and simple static test that does not require sophisticated instrumentation. Tilt testing is used as a rollover metric in the voluntary standards created by the Recreational Off-Highway Vehicle Association (ROHVA) and the Outdoor Power Equipment Institute (OPEI). TTA and TTR values measured by SEA are shown in Table 2.⁸

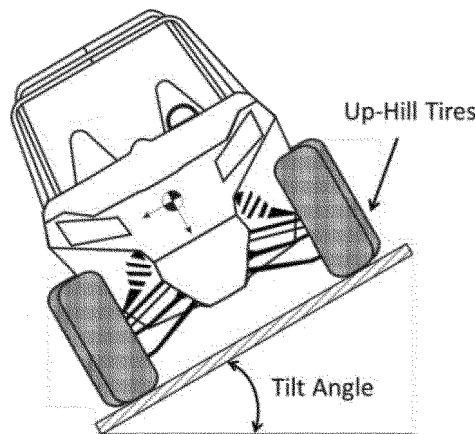

Figure 3. Tilt Table Ratio (TTR) = Tan (Tilt Angle)

⁷ Heydinger, Gary J., et al, *The Design of a Vehicle Inertia Measurement Facility*, SAE 950309, 1995.

⁸ ROHVA developed ANSI/ROHVA 1 for recreation-oriented ROVs and OPEI developed ANSI/OPEI B71.0 for utility-oriented ROVs.

TABLE 2—TTA AND TTR VALUES

Vehicle rank (TTA)	TTA (deg.)	Vehicle rank (TTR)	TTR
A	33.0	A	0.650
B	33.6	B	0.664
D	33.7	D	0.667
I	35.4	I	0.712
H	35.9	H	0.724
J	36.1	J	0.730
F	36.4	F	0.739
E	38.1	E	0.784
C	38.8	C	0.803
G	39.0	G	0.810

Because ROVs are designed with long suspension travel and soft tires for off-road performance, staff was concerned that SSF and TTR would not accurately characterize the dynamic lateral stability of the vehicle. Therefore, CPSC’s contractor, SEA, conducted dynamic J-turn tests to determine whether SSF or TTR measurement corresponded with actual dynamic measures for lateral stability.

3. Dynamic Test To Measure ROV Lateral Stability—the J-Turn Test

In 2001, NHTSA evaluated the J-turn test (also called drop-throttle J-turn testing and step-steer testing) as a method to measure rollover resistance of automobiles. NHTSA found the J-turn test to be the most objective and repeatable method for vehicles with low

rollover resistance. Specifically, the J-turn test is objective because a programmable steering machine turns the steering wheel during the test, and the test results show that the vehicle speed, lateral acceleration, and roll angle data observed during J-turn tests were highly repeatable.⁹ However, NHTSA determined that although the J-turn test is the most objective and repeatable method for vehicles with low rollover resistance, the J-turn test is unable to measure the high rollover resistance of most passenger automobiles.¹⁰ On pavement where a high-friction surface creates high lateral accelerations, vehicles with high rollover resistance (such as passenger automobiles) will lose tire traction and slide in a severe turn rather than roll over. The threshold lateral acceleration cannot be measured because rollover does not occur. In contrast, vehicles with low rollover resistance exhibit untripped rollover on a pavement

during a J-turn test, and the lateral acceleration at rollover threshold can be measured. Thus, the J-turn test is the most appropriate method to measure the rollover resistance of ROVs because ROVs exhibit untripped rollover during the test.

J-turn tests are conducted by driving the test vehicle in a straight path, releasing (dropping) the throttle, and rapidly turning the steering wheel to a specified angle once the vehicle slows to a specified speed. The steering wheel angle and vehicle speed are selected to produce two-wheel lift of the vehicle. Outriggers, which are beams that extend to either side of a vehicle, allow the vehicle to roll but prevent full rollover. The sequence of events in the test procedure is shown in Figure 4. SEA conducted drop-throttle J-turn tests to measure the minimum lateral accelerations necessary to cause two-wheel lift (shown in Step 3 of Figure 4) for each vehicle. Side loading of the vehicle occurs naturally as a result of the lateral acceleration that is created in the J-turn and this lateral acceleration can be measured and recorded. The lateral acceleration produced in the turn is directly proportional to the side loading force acting to overturn the vehicle according to the equation $F = (m)(A_y)$, where F is force, m is the mass of the vehicle, and A_y is lateral acceleration.

⁹ Forkenbrock, G. and Garrott, W. (2002). A Comprehensive Experimental Evaluation of Test Maneuvers That May Induce On-Road, Untripped, Light Vehicle Rollover Phase IV of NHTSA’s Light Vehicle Rollover Research Program. DOT HS 809 513.

¹⁰ Forkenbrock, G. and Garrott, W. (2002). A Comprehensive Experimental Evaluation of Test Maneuvers That May Induce On-Road, Untripped, Light Vehicle Rollover Phase IV of NHTSA’s Light Vehicle Rollover Research Program. DOT HS 809 513.

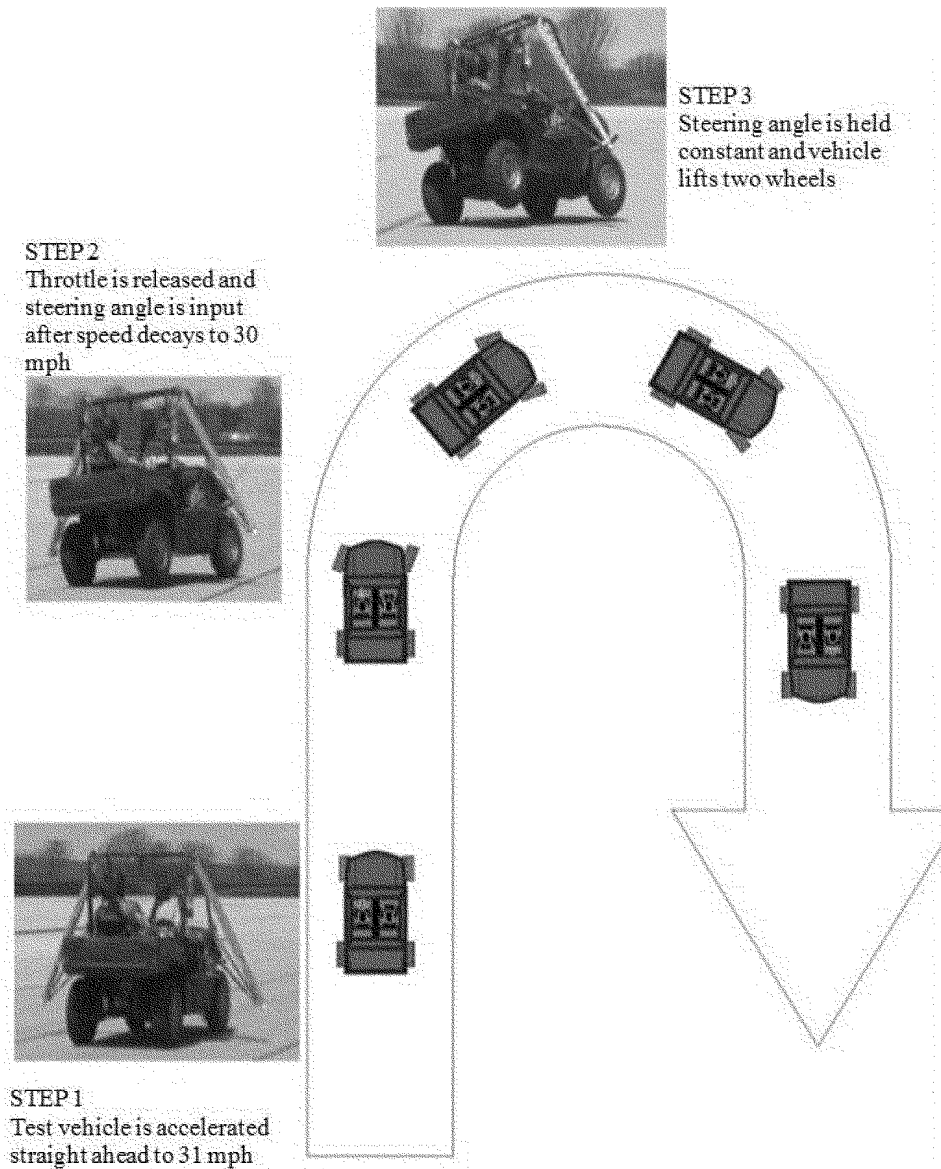

Figure 4. J-Turn Test Sequence of Events

SEA conducted the J-turn testing at 30 mph. A programmable steering controller input the desired steering angles at a steering rate of 500 degrees per second for all vehicles. The chosen steering rate of 500 degrees per second is high enough to approximate a step input, but still within the capabilities of a driver. (A step input is one that happens instantly and requires no time to complete. For steering input, time is required to complete the desired steering angle, so a steering step input is approximated by a high angular rate of steering input.) SEA conducted preliminary tests by starting with a relatively low steering angle of 80 to 90 degrees and incrementally increasing

the steering angle until two-wheel lift was achieved. When SEA determined the steering angle that produced a two-wheel lift, SEA conducted the test run for that vehicle load condition. For each test run, SEA recorded the speed, steering angle, roll rate, and acceleration in three directions (longitudinal, lateral, and vertical). SEA processed and plotted the data to determine the minimum lateral acceleration required for two-wheel lift of the vehicle.

The J-turn test is a direct measure of the minimum or threshold lateral acceleration required to initiate a rollover event, or tip-up of the test vehicle when turning. ROVs that exhibit higher threshold lateral acceleration

have a higher rollover resistance or are more stable than ROVs with lower threshold lateral accelerations. Each of the 10 ROVs tested in the study by SEA exhibited untripped rollover in the J-turn tests at steering wheel angles ranging from 93.8 to 205 degrees and lateral accelerations ranging from 0.625 to 0.785 g. Table 3 shows the vehicles arranged in ascending order for threshold lateral acceleration (A_y) at tip up, SSF, TTA, and TTR. Table 3 illustrates the lack of correlation of the static metrics (SSF, TTA, or TTR) with the direct dynamic measure of threshold lateral acceleration (A_y) at tip up.

TABLE 3

Vehicle rank (A) _y	A _y (g)	SSF	TTR
D	0.625	0.942	0.667
B	0.655	0.932	0.664
A	0.670	0.887	0.650
J	0.670	0.962	0.730
I	0.675	1.045	0.712
F	0.690	0.881	0.739
E	0.700	0.965	0.784
H	0.705	0.918	0.724
C	0.740	0.991	0.803
G	0.785	1.031	0.810

Adapted from: Heydinger, G. (2011). Vehicle Characteristics Measurements of Recreational Off-Highway Vehicles—Additional Results for Vehicle J. Retrieved from <http://www.cpssc.gov/PageFiles/93928/rovj.pdf>.

SEA also conducted J-turn tests on four ROVs to measure the repeatability of the lateral acceleration measurements and found the tests to be very repeatable.¹¹ The results of the repeatability tests indicate the standard deviation for sets of 10 test runs (conducted in opposite directions and left/right turn directions) ranged from 0.002 g to 0.013 g.

Comparison of the SSF, TTR, and A_y values for each ROV indicate that there is a lack of correspondence between the static metrics (SSF and TTR) and the direct measurement of threshold lateral acceleration at rollover. Static metrics cannot be used to evaluate ROV rollover resistance because static tests are unable

to account fully for the dynamic tire deflections and suspension compliance exhibited by the ROVs during a J-turn maneuver. Therefore, the Commission believes that the lateral acceleration threshold at rollover is the most appropriate metric to use when measuring and comparing rollover resistance for ROVs.

C. Vehicle Handling

1. Basic Terms

- *Understeer*: Path of vehicle during a turn in which the vehicle steers less into a turn than the steering wheel angle input by the driver. If the driver does not correct for the understeer path of the

vehicle, the vehicle continues on a straighter path than intended (see Figure 5).

- *Oversteer*: Path of vehicle during a turn in which the vehicle steers more into a turn than the steering wheel angle input by the driver. If the driver does not correct for the oversteer path of the vehicle, the vehicle spirals into the turn more than intended (see Figure 5).

- *Sub-limit understeer or sub-limit oversteer*: Steering condition that occurs while the tires have traction on the driving surface.

- *Limit understeer or limit oversteer*: Steering condition that occurs when the traction limits of the tires have been reached and the vehicle begins to slide.

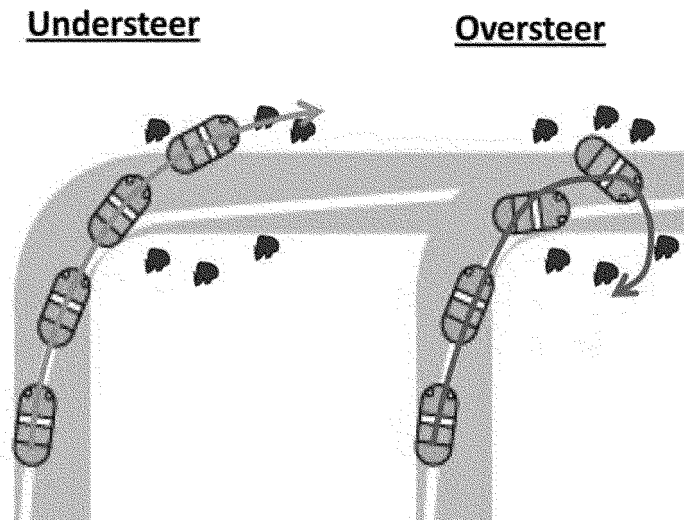

Figure 5. Understeer and Oversteer Path

2. Staff’s Technical Work

a. Constant Radius Test

SAE International (formerly Society of Automotive Engineers) standard, SAE

J266, Surface Vehicle Recommended Practice, *Steady-State Directional Control Test Procedures for Passenger Cars and Light Trucks*, establishes test procedures to measure the vehicle

handling properties of passenger cars and light trucks. ROVs obey the same principles of motion as automobiles because ROVs and automobiles share key characteristics, such as pneumatic

¹¹ Heydinger, G. (2013). Repeatability of J-Turn Testing of Four Recreational Off-Highway Vehicles.

Retrieved from <http://www.cpssc.gov//Global/Research-and-Statistics/Injury-Statistics/Sports->

[and-Recreation/ATVs/SEAReporittoCPSC RepeatabilityTestingSeptember%202013.pdf](http://www.cpssc.gov//Global/Research-and-Statistics/Injury-Statistics/Sports-).

tires, a steering wheel, and spring-damper suspension that contribute to the dynamic response of the vehicle.¹² Thus, the test procedures to measure the vehicle handling properties of passenger cars and light trucks are also applicable to ROVs.

SEA used the constant radius test method, described in SAE J266, to evaluate the sample ROVs' handling characteristics. The test consists of driving each vehicle on a 100 ft. radius circular path from very low speeds, up to the speed where the vehicle

experiences two-wheel lift or cannot be maintained on the path of the circle. The test vehicles were driven in the clockwise and counterclockwise directions. For a constant radius test, "understeer" is defined as the condition when the steering wheel angle required to maintain the circular path increases as the vehicle speed increases because the vehicle is turning less than intended. "Neutral steer" is defined as the condition when the steering wheel angle required to maintain the circular path is unchanged as the vehicle speed

increases. "Oversteer" is defined as the condition when the average steering wheel input required to maintain the circular path decreases as the vehicle speed increases because the vehicle is turning more than intended.

SEA tested 10 ROVs; five of those vehicles (A, D, F, I, and J) exhibited sub-limit transitions to oversteer when tested on asphalt (see Figure 6). The five remaining vehicles (B, C, E, G, and H) exhibited a sub-limit understeer condition for the full range of the test.

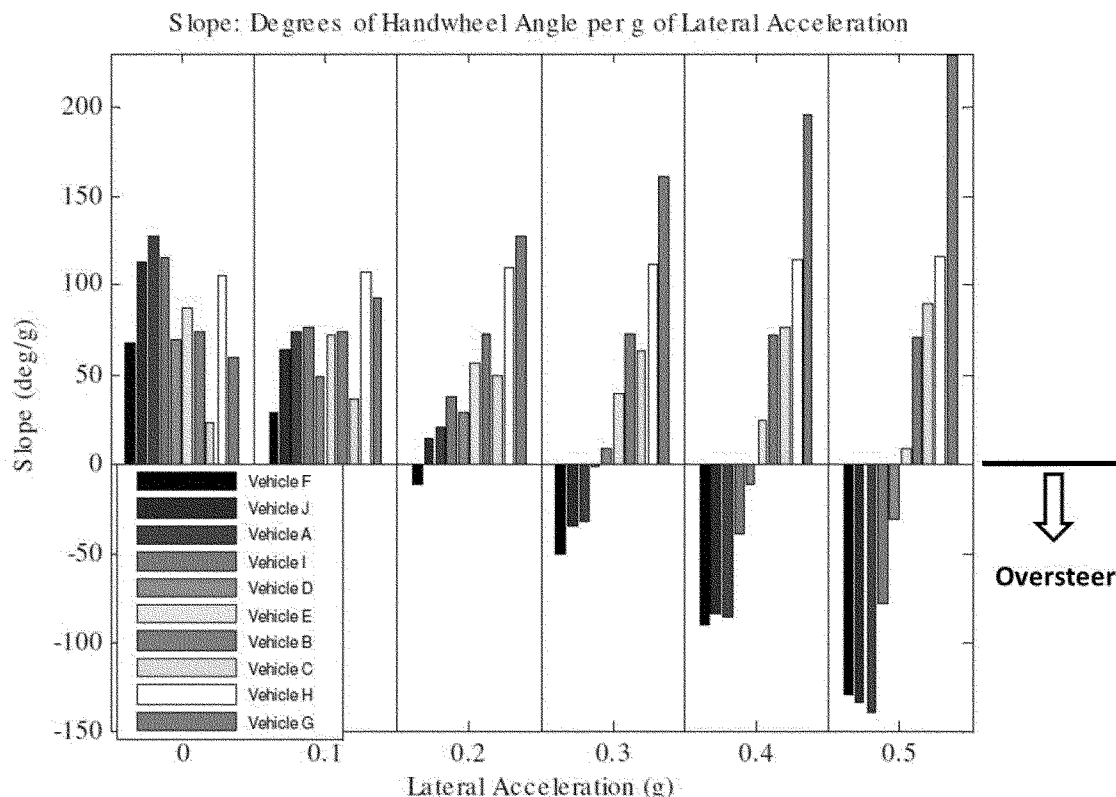

Figure 6. Steering Gradient Slopes at Selected Values of Lateral Acceleration for Tested ROVs

Source: Heydinger, G. (2011) Vehicle Characteristics Measurements of Recreational Off-Highway Vehicles – Additional Results for Vehicle J. Retrieved from <http://www.cpsc.gov/PageFiles/93928/rovj.pdf>.

b. Slowly Increasing Steer (SIS) Test

SAE J266, Surface Vehicle Recommended Practice, *Steady-State Directional Control Test Procedures for Passenger Cars and Light Trucks*, also establishes test procedures for the Constant Speed Variable Steer Angle Test. SEA calls this test the "constant speed slowly increasing steer (SIS) test." During the SIS test, the ROV driver maintains a constant speed of 30 mph, and the vehicle's steering wheel angle is slowly increased at a rate of 5 degrees

per second until the ROV reaches a speed limiting condition or tip-up. A programmable steering controller (PSC) was used to increase the steering angle at a constant rate of 5 degrees per second. During the test, instrumentation for speed, steering angle, lateral acceleration, roll angle, and yaw rate were recorded. SEA conducted SIS tests on the sample of 10 ROVs.

Figure 7 shows SIS test data plotted of lateral acceleration versus time for Vehicle A and Vehicle H. Vehicle H is

the same model vehicle as Vehicle A, but Vehicle H is a later model year, where the sub-limit oversteer has been corrected to understeer.

Plots from the ROV SIS tests in Figure 7 illustrate a sudden increase in lateral acceleration that is found only in vehicles that exhibit sub-limit oversteer. The sudden increase in lateral acceleration is exponential and represents a dynamically unstable

¹² See Tab A of the CPSC staff's briefing package.

condition.¹³ This condition is undesirable because it can cause a vehicle with high lateral stability (such

as a passenger car) to spin out of control, or it can cause a vehicle with

low lateral stability (such as an ROV) to roll over suddenly.

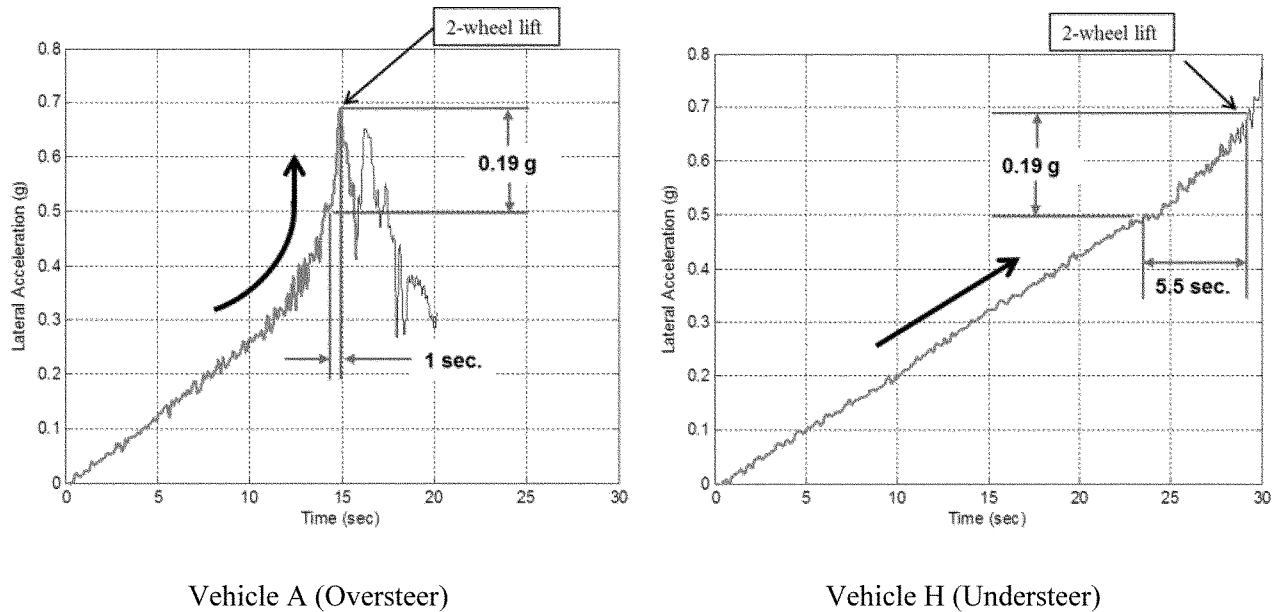

Figure 7. SIS Plots of Lateral Acceleration Gain Over Time

Source: Heydinger, G. (2011) Vehicle Characteristics Measurements of Recreational Off-Highway Vehicles . Retrieved from <http://www.cpsc.gov/PageFiles/96037/rov.pdf>. Appendix D.

When Vehicle A reached its dynamically unstable condition, the lateral acceleration suddenly increased from 0.50 g to 0.69 g (difference of 0.19 g) in less than 1 second, and the vehicle rolled over. (Outriggers on the vehicle prevented full rollover of the vehicle.) In contrast, Vehicle H never reached a point where the lateral acceleration increases exponentially because the condition does not develop in understeering vehicles.¹⁴ The increase in Vehicle H's lateral acceleration remains linear, and the lateral acceleration increase from 0.50 g to 0.69 g (same difference of 0.19 g) occurs in 5.5 seconds.

SEA test results indicate that ROVs that exhibited sub-limit oversteer also exhibited a sudden increase in lateral acceleration that caused the vehicle to roll over. An ROV that exhibits this sudden increase in lateral acceleration is directionally unstable and uncontrollable.¹⁵

Plots of the vehicle path during SIS tests illustrate further how an oversteering ROV (Vehicle A) will roll over earlier in a turn than an understeering ROV (Vehicle H), when the vehicles are operated at the same speed and steering rate (see Figure 8). Vehicle A and Vehicle H follow the same path until Vehicle A begins to

oversteer and its turn radius becomes smaller. Vehicle A becomes dynamically unstable, its lateral acceleration increases exponentially, and the vehicle rolls over suddenly. In contrast, Vehicle H continues to travel 300 more feet in the turn before the vehicle reaches its threshold lateral acceleration and rolls over. A driver in Vehicle H has more margin (in time and distance) to correct the steering to prevent rollover than a driver in Vehicle A because Vehicle H remains in understeer during the turn, while Vehicle A transitions to oversteer and becomes dynamically unstable.

¹³ (Gillespie, T. (1992). Fundamentals of Vehicle Dynamics. Society of Automotive Engineers, Inc. p. 204–205.)

¹⁴ Gillespie, T. (1992). Fundamentals of Vehicle Dynamics. Society of Automotive Engineers.

¹⁵ Gillespie, T. (1992). Fundamentals of Vehicle Dynamics. Society of Automotive Engineers, Inc. p. 204–205; Bundorf, R. T. (1967). The Influence of Vehicle Design Parameters on Characteristic Speed and Understeer. SAE 670078; Segel, L. (1957).

Research in the Fundamentals of Automobile Control and Stability. SAE 570044.

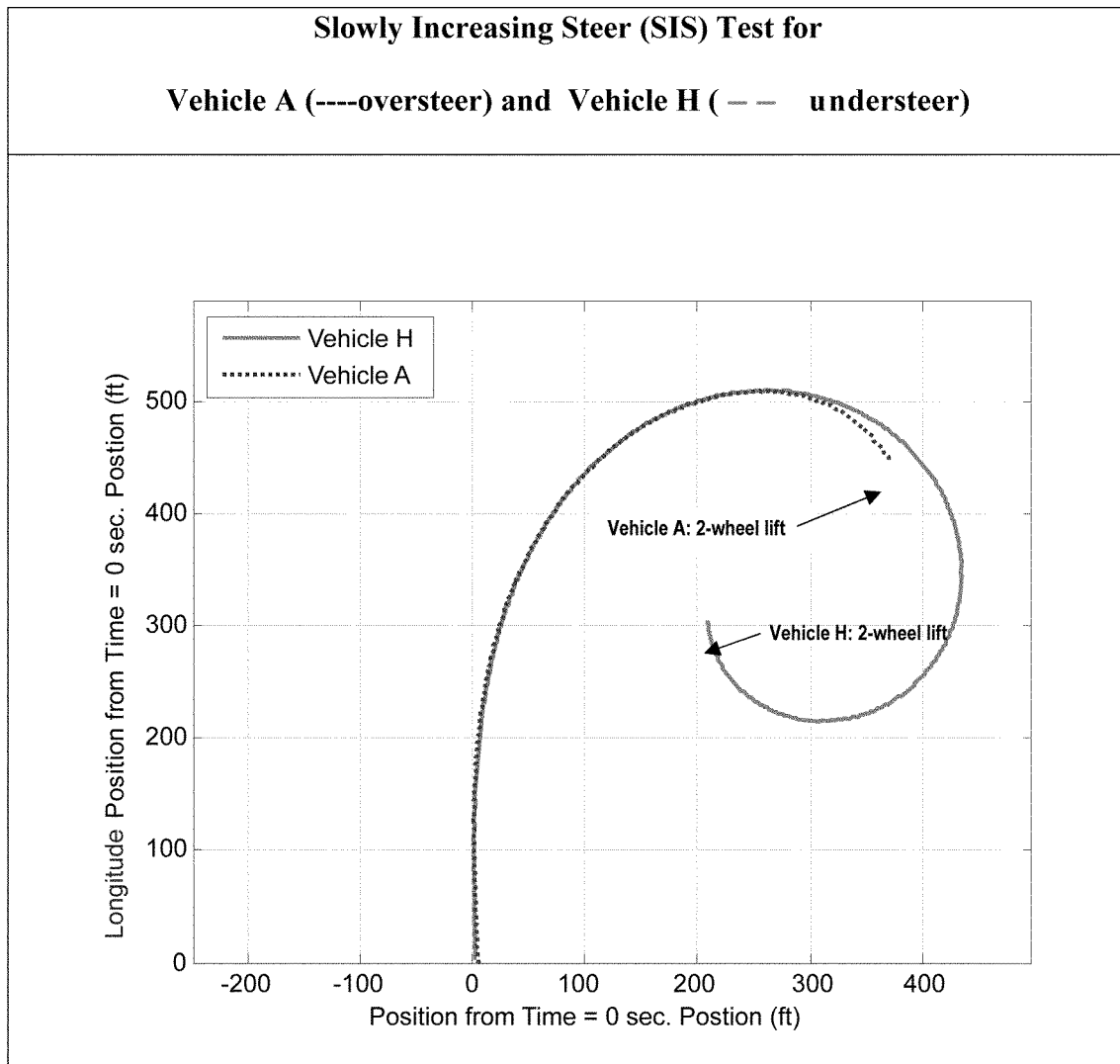

Figure 8. Path of Vehicle A and H During SIS Test (Superimposed in the Right Turn Direction)

The Commission believes that tests conducted by SEA provide strong evidence that sub-limit oversteer in ROVs is an unstable condition that can lead to a rollover incident, especially given the low rollover resistance of ROVs. All ROVs that exhibited sub-limit oversteer reached a dynamically unstable condition during a turn where the increase in lateral acceleration suddenly became exponential. The CPSC believes this condition can

contribute to ROV rollover on level ground, and especially on pavement.

D. Occupant Protection

1. Overview and Basic Terms

The open compartment configuration of ROVs is intentional and allows for easy ingress and egress, but the configuration also increases the likelihood of complete or partial ejection of the occupants in a rollover

event. ROVs are equipped with a ROPS, seat belts, and other restraints for the protection of occupants (see Figure 9). Occupants who remain in the ROV and surrounded by the ROPS, an area known as the protective zone, are generally protected from being crushed by the vehicle during a quarter-turn rollover. Seat belts are the primary restraint for keeping occupants within the protective zone of the ROPS.

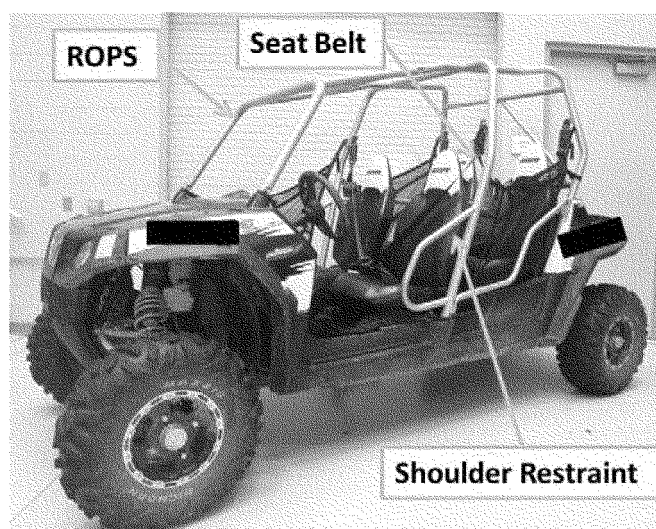

Figure 9. Occupant Protection Components on ROVs

NHTSA evaluates the occupant protection performance of passenger vehicles with tests that simulate vehicle collisions and tests that simulate vehicle rollover.¹⁶ The NHTSA tests use anthropometric test devices (ATDs), or crash test dummies, to evaluate occupant excursion and injury severity during the simulation tests. The occupant movement during these tests is called occupant kinematics. Occupant kinematics is defined as the occupant's motion during a crash event, including the relative motion between various body parts. Occupant kinematics is an important element of dynamic tests because forces act on an occupant from many different directions during a collision or rollover.

There are no standardized tests to evaluate the occupant protection performance of ROVs. However, a test to evaluate occupant protection performance in ROVs should be based on simulations of real vehicle rollover. In a rollover event, the vehicle experiences lateral acceleration and lateral roll. A valid simulation of an ROV rollover will reproduce the lateral acceleration and the roll rate experienced by an ROV during a real rollover event.

2. Seat belts

a. Seat Belt Use in Incidents

From the 428 ROV-related incidents reviewed by the Commission, 817 victims were reported to be in or on the ROV at the time of the incident, and 610 (75 percent) were known to have been injured or killed. Seatbelt use is known for 477 of the 817 victims; of these, 348

(73 percent) were not wearing a seatbelt at the time of the incident.

Of the 610 fatal and nonfatal victims who were in or on the ROV at the time of the incident, 433 (71 percent) were ejected partially or fully from the ROV, and 269 (62 percent) of these victims were struck by a part of the vehicle, such as the roll cage or side of the ROV, after ejection. Seat belt use is also known for 374 of the 610 victims; of these, 282 (75 percent) were not wearing a seat belt.

Of the 225 fatal victims who were in or on the ROV at the time of the incident, 194 (86 percent) were ejected partially or fully from the vehicle, and 146 (75 percent) were struck by a part of the vehicle after ejection. Seat belt use is known for 155 of the 194 ejected victim; of these, 141 (91 percent) were not wearing a seat belt.

A total of 826 victims were involved in the 428 ROV-related incidents reviewed by the Commission's multidisciplinary team. Of these victims, 353 (43 percent) were known to be driving the ROV, and 203 (24 percent) were known to be a passenger in the front seat of the ROV. Of the 231 reported fatalities, 141 (61 percent) were the driver of the ROV, and 49 (21 percent) were the right front passenger in an ROV.

ROHVA also performed an analysis of hazard and risk issues associated with ROV-related incidents and determined that lack of seat belt use is the top incident factor.¹⁷ ROHVA has stated: "Based on the engineering judgment of

its members and its review of ROV incident data provided by the CPSC, ROHVA concludes that the vast majority of hazard patterns associated with ROV rollover would be eliminated through proper seat belt use alone."¹⁸

a. Literature Review (Automotive)

CPSC staff reviewed the substantial body of literature on seat belt use in automobiles. (See Tab I of staff's briefing package.) Although seat belts are one of the most effective strategies for avoiding death and injury in motor vehicle crashes, seat belts are only effective if they are used.

Strategies for increasing seat belt use in passenger vehicles date to January 1, 1972, when NHTSA required all new cars to be equipped with passive restraints or with a seat belt reminder system that used a visual flashing light and audible buzzer that activated continuously for one minute if the vehicle was placed in gear with occupied front seat belts not belted. In 1973, NHTSA required that all new cars be equipped with an ignition interlock that allowed the vehicle to start only if the driver was belted. The ignition interlock was meant to be an interim measure until passive airbag technology matured, but public opposition to the technology led Congress to rescind the legislation and to prohibit NHTSA from requiring either ignition interlocks or continuous audible warnings that last more than 8 seconds. NHTSA then revised the Federal Motor Vehicle Safety Standard (FMVSS) to require a

¹⁶ Federal Motor Vehicle Safety Standard (1971) 49 CFR 571.208.

¹⁷ Heiden, E. (2009). Summary of Recreational Off-Highway Vehicle (ROV) Hazard Analysis. Memorandum from E. Heiden to P. Vitrano. Docket No. CPSC-2009-0087. Regulations.gov.

¹⁸ Yager, T. (2011) Letter to Caroleene Paul. 18 Apr. 2011. Recreational Off-Highway Vehicle Association (ROHVA) written response to CPSC staff's ballot on proposed American National Standard ANSI/ROHVA 1-201X.

seat belt reminder with warning light and audible buzzer that lasts 4 seconds to 8 seconds when front seat belts are not fastened at the time of ignition. This standard still applies today (15 U.S.C. 1410 (b)).

Work by NHTSA indicates seat belt users can be separated loosely into three categories: Full-time users, part-time users, and nonusers. Part-time users and nonusers give different reasons for not wearing seat belts. Part-time seat belt users consistently cite forgetfulness and perceived low risk, such as driving short distances or on familiar roads, as reasons for not using seat belts.¹⁹

One approach to increasing vehicle occupant seat belt use is to provide in-vehicle reminders to encourage occupants to fasten their seat belts. However, possible systems vary considerably in design, intrusiveness, and, most importantly, effectiveness.

Observational studies of cars equipped with the original NHTSA-required seat belt reminders found no significant difference in seat belt use among vehicles equipped with the continuous one minute visual-audio system and vehicles not equipped with the reminder system.²⁰ After NHTSA adopted the less stringent 4-second to 8-second visual and audio reminder system requirements, NHTSA conducted observational and phone interview studies and concluded that the less intrusive reminder system was also not effective in increasing seat belt use.²¹

A national research project by the University of Michigan Transportation Research Institute endeavored to promote safety belt use in the United States by developing an effective in-vehicle safety belt reminder system.²² The project authors performed literature reviews and conducted surveys and focus groups to design an optimal safety belt reminder system. The authors

¹⁹ Block, 1998; Bradbard et al., 1998; Harrison and Senserrick, 2000; Bentley et al., 2003; Boyle and Vanderwolf, 2003; Eby et al., 2005; Boyle and Lampkin, 2008.

²⁰ Robertson, L. S. and Haddon, W. (1974). The Buzzer-Light Reminder System and Safety Belt Use. *American Journal of Public Health*, Vol. 64, No. 8, pp. 814–815.; Robertson, L. S. (1975). Safety Belt Use in Automobiles with Starter-Interlock and Buzzer-Light Reminder Systems. *American Journal of Public Health*, Vol. 65, No. 12, pp. 1319–1325.

²¹ Westefeld, A. and Phillips, B. M. (1976). Effectiveness of Various Safety Belt Warning Systems. (DOT HS 801 953). Washington, DC: National Highway Traffic Safety Administration, U.S. Department of Transportation.

²² Eby, D. W., Molnar, L. J., Kostyniuk, L. P., and Shope, J. T. (2005). Developing an Effective and Acceptable Safety Belt Reminder System. 19th International Technical Conference on the Enhanced Safety of Vehicles, Washington, DC, June 6–9, 2005. <http://www-nrd.nhtsa.dot...01/esv/esv19/05-0171-O.pdf>.

concluded that principles for an optimal safety belt reminder system include the following:

1. The full-time safety belt user should not notice the system.
2. It should be more difficult to cheat on the system than to use the safety belt.
3. Permanent disconnection of the system should be difficult.
4. The system should be reliable and have a long life.
5. Crash and injury risk should not be increased as a result of the system.
6. System design should be based on what is known about the effectiveness and acceptability of system types and elements.
7. System design should be compatible with the manufacturer's intended purpose/goals for the system.

NHTSA conducted a study of enhanced seatbelt reminder (ESBR) effectiveness that compared results of controlled experiments with field observations of actual seat belt use.

Among the findings of the ESBR effectiveness report are: (1) Systems with only visual reminders are not effective; (2) ESBR systems, in general, promote greater seat belt use by 3 to 4 percentage points; (3) more annoying systems are more effective, but that creates the challenge of designing an effective system that is acceptable; (4) potential gains in seat belt use not only come from simply reminding users, but also from motivating users, such as equating seat belt use with elimination of an annoyance; and (5) the positive effects of ESBRs on belt use were more pronounced for the low belt-use propensity groups.²³

c. Innovative Technologies

Automobiles. Researchers developed more innovative in-vehicle technology, beyond visual and audible warnings, to study the effectiveness of systems that hindered a vehicle function if the driver's seat belt was not buckled. One system allowed drivers to start the vehicle but delayed the driver's ability to place the vehicle in gear if the seat belt was not buckled.²⁴ Follow-up

²³ Lerner, N., Singer, J., Huey, R., Jenness, J. (2007). Acceptability and Potential Effectiveness of Enhanced Seat Belt Reminder System Features. (DOT HS 810 848). Washington, DC: National Highway Traffic Safety Administration, U.S. Department of Transportation. Freedman, M., Lerner, N., Zador, P., Singer, J., and Levi, S. (2009). Effectiveness and Acceptance of Enhanced Seat Belt Reminder Systems: Characteristics of Optimal Reminder Systems. (DOT HS 811 097). Washington, DC: National Highway Traffic Safety Administration, U.S. Department of Transportation.

²⁴ Van Houten, R., Malenfant, J.E.L., Reagan, I., Sifrit, K., Compton, R., & Tenenbaum, J. (2010). Increasing Seat Belt Use in Service Vehicle Drivers with a Gearshift Delay. *Journal of Applied Behavior Analysis*, 43, 369–380.

systems made it more difficult for the driver to depress the gas pedal when the vehicle exceeded 20–25 mph if the driver's seat belt was not buckled. Study participants were more receptive to the latter system, which was a consistent and forceful motivator to buckle the seat belt without affecting the general operation of the vehicle.²⁵

ROVs. In 2010, Bombardier Recreation Products (BRP) introduced the Can-Am Commander 1000 ROV with a seat belt speed limiter system that restricts the vehicle speed to 9 mph if the driver's seat belt is not buckled. CPSC staff performed dynamic tests to verify that the vehicle's speed was limited when the driver's seat belt was not buckled. On level ground, the vehicle's speed was limited to 6 to 9 mph when the driver was unbelted, depending on the ignition key and transmission mode selected.

In 2013, BRP introduced the Can-Am Maverick vehicle as a sport-oriented ROV that also includes a seat belt speed limiter system. CPSC staff did not test the Maverick vehicle because a sample vehicle was not available for testing.

In 2014, Polaris Industries (Polaris) announced that model year 2015 Ranger and RZR ROVs will include a seatbelt system that limits the speed of the vehicle to 15 mph if the seatbelt is not engaged. (Retrieved at: <http://www.weeklytimesnow.com.au/machine/sidebyside-vehicles-soon-to-get-safety-improvements/story-fnkerd6b-1227023275396>.) The Commission has not tested these vehicles because they are not yet available on the market.

d. User Acceptance of Innovative Technologies in ROVs

Studies of seat belt reminder systems on automobiles are an appropriate foundation for ROV analysis because ROVs are typically driven by licensed drivers and the seating environment is similar to an automobile. Staff decided to obtain data on ROV users' experience and acceptance of seat belt reminders to validate the analysis.

CPSC staff was not aware of any studies that provide data on the effectiveness of seat belt reminder systems on ROVs or user acceptance of such technologies. Therefore, the CPSC contracted Westat, Inc. (Westat), to conduct focus groups with ROV users to explore their opinions of seat belt speed-limitation systems on ROVs. Phase 1 of the effort involved

²⁵ Van Houten, R., Hilton, B., Schulman, R., and Reagan, I. (2011). Using Haptic Feedback to Increase Seat Belt Use of Service Vehicle Drivers. (DOT HS 811 434). Washington, DC: National Highway Traffic Safety Administration, U.S. Department of Transportation.

conducting focus groups of ROV users and asking questions about ROV use and user opinions of the Can-Am speed-limitation system that were shown in a video to the participants. Results from Phase 1 were used to develop the protocol for Phase 2. Phase 2 of the effort conducts focus groups of ROV users who provide feedback after driving and interacting with an ROV equipped with a speed-limitation system.

Results of Phase 1 of the Westat study indicate that participants:

- Admit to being part-time seat belt users;
- cite familiarity and low-risk perception as reasons for not wearing seat belts;
- value easy ROV ingress and egress over seat belt use;
- generally travel around 5 mph when driving on their own property, and overall, drive 15 to 30 mph for typical use;
- had a mixed reaction to the speed-limitation technology at 10 mph;
- were more accepting of the speed-limitation technology if the speed was raised to 15 mph or if the system was tied to a key control.

Phase 2 of the Westat study is ongoing, and a report of the results is expected by December 2014. The results will provide data on ROV users' acceptance of a seat belt speed limitation technology with a threshold speed of 10 mph, 15 mph, and 20 mph. CPSC believes the results will provide

additional rationale for determining a threshold speed for a seat belt speed limitation technology that balances users acceptance (as high a speed as possible) with safe operation of the ROV without seat belt use (as low a speed as possible).

3. CPSC's Technical Work

To explore occupant protection performance testing for a product for which no standard test protocol exists, CPSC staff contracted Active Safety Engineering (ASE) to conduct two exploratory pilot studies to evaluate potential test methods. After completion of the pilot studies, CPSC staff contracted SEA, Limited (SEA) to conduct occupant protection performance evaluation tests, based on a more advanced test device designed by SEA.²⁶

a. Pilot Study 1

ASE used a HYGES™ accelerator sled to conduct dynamic rollover simulations on sample ROVs, occupied by a Hybrid III 50th percentile male anthropomorphic test device (ATD). The HYGES™ system causes a stationary vehicle, resting on the test sled, to roll over by imparting a short-duration lateral acceleration to the test sled. The torso of an unbelted ATD ejected partially from the ROV during a

simulated rollover. In comparison, the torso of a belted ATD remained in the ROV during a simulated rollover. The tests demonstrated that use of a seat belt prevented full ejection of the ATD's torso.

b. Pilot Study 2

In a follow-up pilot study, ASE used a deceleration platform sled rather than a HYGES™ accelerator sled to impart the lateral acceleration to the test vehicle. The deceleration sled is more accurate than the HYGES™ sled in re-creating the lower energy rollovers associated with ROVs.

An unbelted ATD ejected fully from the vehicle during tests conducted at the rollover threshold of the ROV. In comparison, a belted ATD partially ejected from the vehicle during tests conducted at the same lateral acceleration. These exploratory tests with belted and unbelted occupants indicate the importance of using seat belts to prevent full ejection of the occupant during a rollover event.

c. SEA Roll Simulator

SEA designed and built a roll simulator to measure and analyze occupant response during quarter-turn roll events of a wide range of machines, including ROVs. The SEA roll simulator produces lateral accelerations using a deceleration sled and produces roll rates using a motor to rotate the test sled (see Figure 10).

²⁶ The ASE and SEA reports are available on CPSC's Web site at: <http://www.cpsc.gov/en/Research-Statistics/Sports-Recreation/ATVs/Technical-Reports/>.

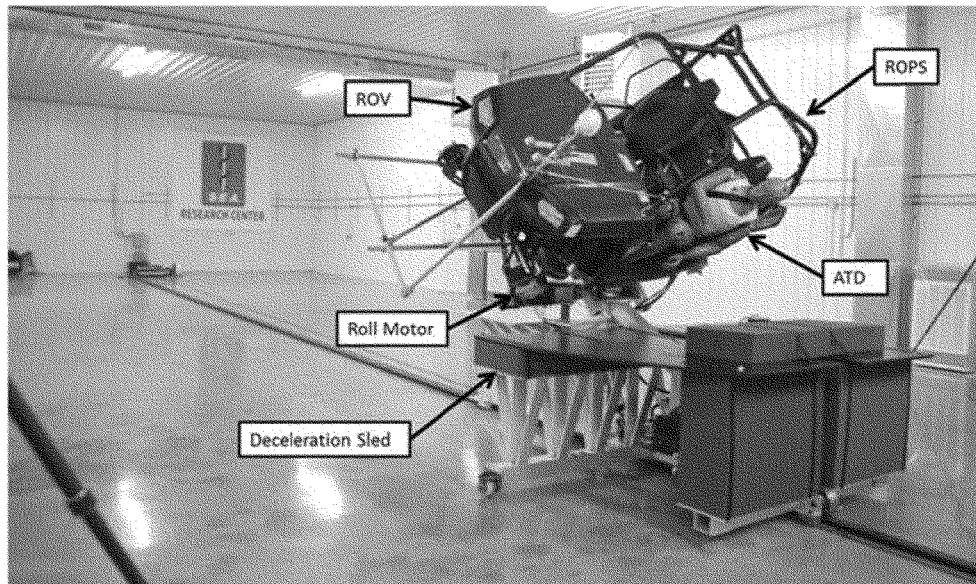

Figure 10. SEA Roll Simulator

Source: Zagorski, S. B., Heydinger, G. J., Sidhu, A., Guenther, D.A., and Andreatta, D. A. (2011). Modeling and Validation of a Roll Simulator for Recreational Off-Highway Vehicles. IMECE 2011-6203.

SEA validated the roll simulator as an accurate simulation of ROV rollover and occupant kinematics by comparing roll rates, lateral accelerations, and ATD ejections that were created by the simulator with actual values measured during autonomous rollover. Results show that the roll simulator accurately re-creates the conditions of an ROV rollover. CPSC believes that the vehicle

kinematics on the SEA rollover simulator accurately represent real-world events because SEA validated the sled kinematics against full-vehicle, real-world rollover events.

SEA simulated tripped and untripped rollovers of seven sample ROVs using belted and unbelted ATD occupants. Plots of the head excursion data indicate how well the vehicle's occupant

protection features retain the occupant inside the protective zone of the ROPS during a roll simulation (see Figure 11). Head displacement plots above the ROPS Plane indicate the occupant's head stayed inside the ROPS zone, and plots below the ROPS Plane indicate that the occupant's head moved outside the ROPS zone.

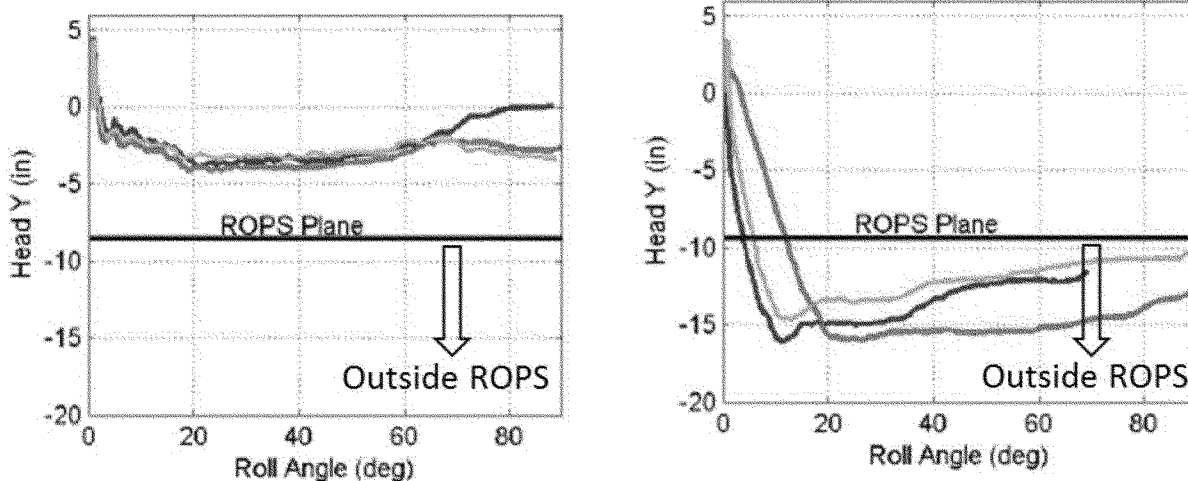

Figure 11. Exemplar Plots of Head Excursion During ROV Roll Simulation

Source: Morr, D. (2012) Test and Evaluation of Recreational Off-Highway Vehicles (ROVs) Dynamic Occupant Protection Performance Tests. Retrieved from <http://www.cpsc.gov/Global/Research-and-Statistics/Technical-Reports/Sports-and-Recreation/ATV-ROV/ROVOccupantProtectionPerformanceTests.pdf>.

The SEA roll simulator test results indicate that five of the seven ROVs

tested allowed a belted occupant's head to eject outside the ROPS of the vehicle

during a quarter-turn rollover simulation. The occupant protection

performance of belted occupants varied from vehicle to vehicle, depending on seat belt design, passive hip and shoulder coverage, whether the rollover was tripped or untripped, and ROPS dimensions and geometry.

CPSC staff analysis of the SEA roll simulator test results indicates that vehicles with the best occupant protection performance restricted movement of the occupant with combinations of quick-locking seat belts, passive coverage in the hip and shoulder areas of the occupant, and large ROPS zones around the occupant's head. Rollover tests indicate that a seat belt is effective at preventing full occupant ejection, but in some cases where the seat belt does not lock quickly, partial occupant ejection still occurs. However, when a seat belt is used in conjunction with a passive shoulder barrier restraint, testing indicates that the occupant remains within the protective zone of the vehicle's ROPS during quarter-turn rollover events.

The SEA roll simulator test results also indicate that unbelted occupants are partially or fully ejected from all vehicles, regardless of the presence of other passive restraints, such as hip restraints or shoulder restraints. Although passive shoulder barriers may not provide substantial benefit for occupant protection in unbelted rollovers, the roll simulator test results indicate that shoulder restraints significantly improved occupant

containment when used in conjunction with a seat belt.

Although the SEA roll simulator is the most advanced test equipment viewed by the Commission, to date, and the test results provide clear evidence of occupant head excursion, not enough test data have been generated to base dynamic occupant protection performance test requirements on a device like the roll simulator. Therefore, the Commission is using the roll simulator test results to focus on occupant protection requirements that maximize occupant retention through seat belt use with passive shoulder restraint.

d. ANSI/ROHVA 1–2011 Occupant Protection Tests

CPSC staff tested 10 sample ROVs to the occupant retention system (ORS) zone requirements specified in ANSI/ROHVA 1–2011. Requirements are specified for Zone 1—Leg/Foot, Zone 2—Shoulder/Hip, Zone 3—Arm/Hand, and Zone 4—Head/Neck. CPSC focused on the requirements for Zone 2 because occupant ejection occurs in this zone.²⁷

ANSI/ROHVA Zone 2—Shoulder/Hip requirements allow the vehicle to pass one of two different test methods to meet that zone's requirement. Under the first option, a construction-based method defines an area near the occupant's side that must be covered by a passive barrier. The test involves applying a 163-lbf. load at a point in the defined test area without failure or

deformation of the barrier. Under the second option, a performance-based method specifies a tilt table test with a vehicle occupied by a belted test dummy. When the vehicle is tilted to 45 degrees on the tilt table, the ejection of the dummy must not exceed 5 inches beyond the vehicle width.

Results of CPSC tests indicate that only four of 10 vehicles passed the construction-based test requirements, and eight of 10 vehicles passed the performance-based test requirements.²⁸ CPSC analysis identified a primary weakness with the performance-based tilt table tests. The performance-based test criteria measure the torso excursion outside the vehicle width, not the excursion outside the protective zone of the ROPS. An occupant must remain inside the envelope of the ROPS to be protected; therefore, the requirement allows an inherently unsafe condition where the occupant moves outside the protective zone of the vehicle's ROPS.

CPSC measured the difference between the outermost point of the ROV and the outermost point on the ROPS near the occupant's head (see Figure 12). On one vehicle, the vehicle's maximum width was 6.75 inches outside the maximum ROPS width near the occupant's head. Because the requirement is based on a 5-inch limitation beyond the vehicle width, the occupant's torso could be 11.75 inches (6.75 inches plus 5 inches) outside of the vehicle ROPS and still meet the performance-based requirement.

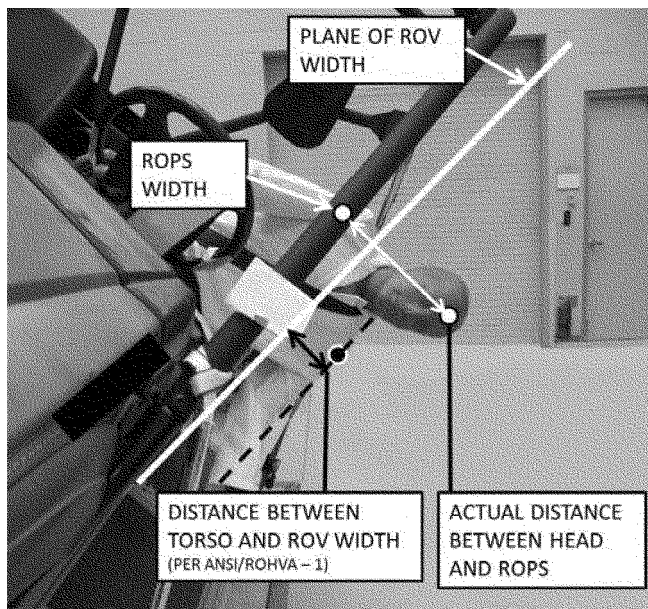

Figure 12. Difference Between Torso and Head Excursion During Tilt Table Test

²⁷ See Tab H of the briefing package.

²⁸ See Tab H of the briefing package.

CPSC also compared the occupant head excursion relative to the torso excursion during the tilt table tests. Due to occupant rotation during the tests, the maximum head displacement exceeded the torso displacement by up to 3 inches. The discrepancy between head and torso displacement and between the vehicle width and ROPS' width can result in occupant head ejection that is 14.75 inches (11.75 inches plus 3 inches) outside the protective zone of the ROPS and still meet the performance-based requirement.

VII. Relevant Existing Standards

A. Background

Two different organizations developed separate voluntary standards for ROVs. The Recreational Off-Highway Vehicle Association (ROHVA) developed ANSI/ROHVA 1, *American National Standard for Recreational Off-Highway Vehicles*, and the Outdoor Power Equipment Institute (OPEI) developed ANSI/OPEI B71.9, *American National Standard for Multipurpose Off-Highway Utility Vehicles*.

ROHVA member companies include: Arctic Cat, BRP, Honda, John Deere, Kawasaki, Polaris, and Yamaha. Work on ANSI/ROHVA 1 started in 2008, and work completed with the publication of ANSI/ROHVA 1–2010. The standard was immediately opened for revision, and a revised standard, ANSI/ROHVA 1–2011, was published in July 2011.

OPEI member companies include: Honda, John Deere, Kawasaki, and Yamaha. Work on ANSI/OPEI B71.9 was started in 2008, and work was completed with the publication of ANSI/OPEI B71.9–2012 in March 2012.

Both voluntary standards address design, configuration, and performance aspects of ROVs, including requirements for accelerator and brake controls; service and parking brake/parking mechanism performance; lateral and pitch stability; lighting; tires; handholds; occupant protection; labels; and owner's manuals.

CPSC staff participated in the canvass process used to develop consensus for ANSI/ROHVA 1 and ANSI/OPEI B71.9. From June 2009 to the present, CPSC staff has engaged actively with ROHVA and OPEI through actions that include the following:

- Sending correspondence to ROHVA and OPEI with comments on voluntary standard ballots that outlined CPSC staff's concerns that the voluntary standard requirements for lateral stability are too low, that requirements for vehicle handling are lacking, and that requirements for occupant protection are not robust;

- Participating in public meetings with ROHVA and OPEI to discuss development of the voluntary standard and to discuss static and dynamic tests performed by contractors on behalf of CPSC staff;

- Sharing all CPSC contractor reports with test results of static and dynamic tests performed on ROVs by making all reports available on the CPSC Web site;
- Requesting copies of test reports on dynamic tests performed on ROVs by ROHVA for CPSC staff to review;
- Demonstrating dynamic test procedures and data collection to ROHVA and OPEI at a public meeting at an outdoor test facility in East Liberty, OH; and

- Submitting suggested changes and additions to the ANSI/ROHVA 1–2011 voluntary standard to improve lateral stability, vehicle handling, and occupant protection (OPEI was copied).

ANSI/ROHVA 1–2011 was published in July 2011, without addressing CPSC staff's concerns. CPSC staff requested, but has not received reports or test results of static or dynamic tests conducted by contractors on behalf of ROHVA.

ANSI/OPEI B71.9–2012 was published in March 2012, without addressing CPSC staff's concerns.

On August 29, 2013, CPSC staff sent a letter to ROHVA with suggested modifications to the voluntary standard requirements to address staff's concerns. CPSC staff sent a courtesy copy of the August 29, 2013 recommendation letter to OPEI. On November 27, 2013, ROHVA responded that ROHVA plans to adopt less stringent versions of CPSC staff's suggested requirements to improve the lateral stability and occupant protection performance of ROVs. On March 13, 2014, ROHVA sent CPSC staff the Canvass Draft of proposed revisions to ANSI/ROHVA 1–2011. Staff responded to the Canvass Draft on May 23, 2014, and summarized why staff believes ROHVA's proposed requirements will not reduce the number of deaths and injuries from ROVs. The discussion below also provides that explanation. On September 24, 2014, ANSI approved the proposed revisions to ANSI/ROHVA 1–2011, which is identical to the Canvass Draft. ROHVA has advised that the revised standard will soon be published as ANSI/ROHVA 1–2014. In addition, CPSC staff met with representatives from ROHVA and OPEI on October 23, 2014. Following is a link to the video of this meeting: <http://www.cpsc.gov/en/Newsroom/Multimedia/?vid=70952>.

On February 21, 2014, OPEI sent a letter to CPSC staff requesting that the CPSC exclude from CPSC's rulemaking

efforts multipurpose off-highway utility vehicles (MOHUVs) that meet the ANSI/OPEI B71.9–12 standard requirements. We address this request in the response to comments section of this preamble (Section VIII).

B. Voluntary Standards Provisions Related to the Proposed Rule

In this section, we summarize the provisions of the voluntary standards that are related to the specific requirements the Commission is proposing and we assess the adequacy of these voluntary standard provisions.

1. Lateral Stability

ANSI/ROHVA 1–2011 and ANSI/OPEI B71.9 include similar provisions to address static lateral stability and differing provisions to address dynamic lateral stability:

Voluntary Standard Requirement: ANSI/ROHVA 1–2011 Section 8.2 Stability Coefficient (K_{st}) and ANSI/OPEI B71.9–2012 Section 8.6 Stability Coefficient (K_{st}) specify a stability coefficient, K_{st} , which is calculated from the vehicle's center of gravity location and track-width dimensions. The value of K_{st} for a vehicle at curb weight (without occupants) is required to be no less than 1.0.

Adequacy: The Commission believes the stability coefficient requirement does not adequately address lateral stability in ROVs because static tests are unable to account fully for the dynamic tire deflections and suspension compliance exhibited by ROVs in a dynamic maneuver. For practical purposes, K_{st} and SSF values provide the same information for ROVs because the difference in front and rear track widths are averaged in the SSF calculation. Table 4 shows the results of SSF measurements made by SEA for driver-plus-passenger load condition. A comparison of how the vehicles would rank if the SSF (or K_{st}) were used instead of the threshold lateral acceleration at rollover (A_y) illustrates how poorly a stability coefficient correlates to the actual rollover resistance of the vehicle. The stability coefficient does not account for dynamic effects of tire compliance, suspension compliance, or vehicle handling, which are important factors in the vehicle's lateral stability.

TABLE 4—VEHICLE ASCENDING RANK ORDER A_y VS. SSF
[Operator plus passenger load]

Vehicle rank (A_y)	A_y (g)	Vehicle rank (SSF)	SSF
D	0.625	F	0.881
B	0.655	A	0.887
A	0.670	H	0.918
J	0.670	B	0.932
I	0.675	D	0.942
F	0.690	J	0.962
E	0.700	E	0.965
H	0.705	C	0.991
C	0.740	G	1.031
G	0.785	I	1.045

Adapted from: Heydinger, G. (2011) Vehicle Characteristics Measurements of Recreational Off-Highway Vehicles—Additional Results for Vehicle J. Retrieved from <http://www.cpsc.gov/PageFiles/93928/rovj.pdf>.

Furthermore, all of the ROVs tested pass the K_{st} minimum of 1.0 for an unoccupied vehicle, as specified by ANSI/ROHVA 1–2011 and ANSI/OPEI B71.9–12. The K_{st} value of an ROV with no occupants is of limited value because an ROV in use has at least one occupant. The Commission believes the ANSI/ROHVA and ANSI/OPEI stability coefficient requirement is a requirement that all ROVs can pass, does not reflect the actual use of ROVs, does not promote improvement in lateral stability, and does not correspond to the actual rollover resistance of ROVs. The Commission believes that the threshold lateral acceleration at rollover is a direct measure for rollover resistance, and its use would eliminate the need for a stability coefficient requirement.

Voluntary Standard Requirement: ANSI/ROHVA 1–2011 Section 8.1 Tilt Table Test and ANSI/OPEI Section 8.7 Tilt Table Stability specify tilt table tests in the driver-plus-passenger load condition and the gross vehicle weight rating (GVWR) load condition. The minimum tilt table angle (TTA) requirement for an ROV with a driver-plus-passenger load condition is 30 degrees, and the minimum TTA for GVWR load condition is 24 degrees.

Adequacy: The CPSC believes the tilt table requirement does not adequately

address lateral stability in ROVs because static tests are unable to account fully for the dynamic tire deflections and suspension compliance exhibited by ROVs in a dynamic maneuver. Table 5 shows the results of tilt table measurements made by SEA for driver-plus-passenger load condition. A comparison of how the vehicles would rank if the TTA were used instead of the direct measurement of threshold lateral acceleration at rollover (A_y) illustrates how poorly the TTA corresponds to the actual rollover resistance of the vehicle. The tilt table test does not account for dynamic effects of tire compliance, suspension compliance, or vehicle handling, which are important factors in the vehicle's lateral stability.

Furthermore, all of the ROVs tested passed the minimum 30 degree TTA requirement specified by ANSI/ROHVA 1–2011. The ROV with the lowest rollover resistance, as directly measured by threshold lateral acceleration at rollover (Vehicle D, $A_y = 0.625$ g, TTA = 33.7 degrees), exceeds the voluntary standard TTA requirement by 3.7 degrees, or 12 percent above the 30 degree minimum. The ROV that was part of a repair program to increase its roll resistance, Vehicle A, exceeds the TTA requirement by 3.0 degrees, or 10 percent above the 30 degree minimum.

TABLE 5—VEHICLE ASCENDING RANK ORDER A_y VS. TTA
[Operator plus passenger load]

Vehicle rank (A_y)	A_y (g)	Vehicle rank (TTA)	TTA (deg.)
D	0.625	A	33.0
B	0.655	B	33.6
A	0.670	D	33.7
J	0.670	I	35.4
I	0.675	H	35.9
F	0.690	J	36.1
E	0.700	F	36.4
H	0.705	E	38.1
C	0.740	C	38.8
G	0.785	G	39.0

Source: Heydinger, G. (2011) Vehicle Characteristics Measurements of Recreational Off-Highway Vehicles—Additional Results for Vehicle J. Retrieved from <http://www.cpsc.gov/PageFiles/93928/rovj.pdf>.

The CPSC believes the ANSI/ROHVA and ANSI/OPEI tilt table requirement does not detect inadequate rollover resistance. The TTA requirement in the voluntary standard does not correlate to the actual rollover resistance of ROVs, allows a vehicle that was part of repair program to pass the test without having undergone the repair, and provides no incentive for manufacturers to improve the lateral stability of ROVs. The CPSC believes the threshold lateral acceleration at rollover is a direct measure of rollover resistance, and its use would eliminate the need for a tilt table test requirement.

Voluntary Standard Requirement: ANSI/ROHVA 1–2011 Section 8.3 Dynamic Stability specifies a dynamic stability test based on a constant steer angle test performed on pavement. The standard describes the method for driving the vehicle around a 25-foot radius circle and slowly increasing the speed until 0.6 g of lateral acceleration is achieved; or 0.6 g lateral acceleration cannot be achieved because the vehicle experiences two-wheel lift of the inside wheels, or the vehicle speed is limited and will not increase with further throttle input. The vehicle passes the dynamic test if at least eight out of 10 test runs do not result in two-wheel lift.

Adequacy: The CPSC does not believe the ANSI/ROHVA requirement accurately characterizes the lateral stability of an ROV because it does not measure the threshold lateral acceleration at rollover. The Commission is not aware of any standards, recognized test protocols, or real-world significance that supports using a constant steer angle test to assess dynamic lateral stability.

CPSC staff contracted SEA to conduct constant steer angle testing, as specified by the ROHVA standard, on vehicles A, F, and J of the ROV study.²⁹ Table 6 shows the results of the tests.

TABLE 6—SUMMARY OF CONSTANT STEER ANGLE TEST FOR 25 FT. RADIUS PATH

Vehicle	Turn direction (CW = clockwise, CCW = counter-clockwise)	Test end condition/limit response	ROHVA Test pass/fail outcome
Vehicle A	Right (CW)	Two-wheel lift	Fail.
	Left (CCW)	Two-wheel lift	Fail.
Vehicle F	Right (CW)	Maximum Speed*	Pass.**
	Left (CCW)	Maximum Speed*	Pass.**

²⁹ Heydinger, G. J. (2011) Results from Proposed ROHVA and OPEI Dynamic Maneuvers—Vehicles

A, F, and J. Retrieved from: <http://www.cpsc.gov/Global/Research-and-Statistics/Technical-Reports/>

Sports-and-Recreation/ATV-ROV/ProposedROHVAandOPEIDynamicManeuvers.pdf.)

TABLE 6—SUMMARY OF CONSTANT STEER ANGLE TEST FOR 25 FT. RADIUS PATH—Continued

Vehicle	Turn direction (CW = clockwise CCW = counter-clockwise)	Test end condition/limit response	ROHVA Test pass/fail outcome
Vehicle J	Right (CW) Left (CCW)	Two-wheel lift Maximum Speed/Spinout	Fail. Pass.

* Maximum speed occurred very near 0.6 g of corrected lateral acceleration for Vehicle F.

** Two-wheel lift occurred for Vehicle F after the driver slowed from maximum speed at the end of the test.

Source: Heydinger, G. (2011) Results from Proposed ROHVA and OPEI Dynamic Maneuvers—Vehicles A, F, and J. Retrieved from <http://www.cpssc.gov/Global/Research-and-Statistics/Technical-Reports/Sports-and-Recreation/ATV-ROV/ProposedROHVAandOPEIDynamicManeuvers.pdf>.

The Commission is concerned that ROVs with low lateral stability can pass ROHVA’s dynamic stability requirement because the small turn radius limits the ROV’s speed and prevents generation of the lateral accelerations necessary to assess rollover resistance (as shown by the results for Vehicle F). The Commission is also concerned that the effects of oversteer can allow an ROV to pass the test because maximum speed is reached by vehicle spinout (as shown by the results for Vehicle J).

NHTSA evaluated the J-turn test protocol as a method to measure the rollover resistance of automobiles.³⁰ NHTSA determined that the J-turn test is the most objective and repeatable method for vehicles with low rollover resistance. Vehicles with low rollover resistance exhibit untripped rollover on pavement during a J-turn test and the lateral acceleration at the rollover threshold can be measured. Lateral acceleration is the accepted measure by vehicle engineers for assessing lateral stability or rollover resistance.³¹ This value is commonly used by engineers to compare rollover resistance from one vehicle to another. The ANSI/ROHVA test protocol does not measure the lateral acceleration at two-wheel lift, and the parameters of the test appear

tuned to allow most vehicles to pass. Based on CPSC’s testing and review, the Commission does not believe the ANSI/ROHVA dynamic stability requirement is a true measure of rollover resistance, and the CPSC does not believe the requirement will improve the lateral stability of ROVs.

Voluntary Standard Requirement: ANSI/OPEI B71.9–2012 Section 8.8 Dynamic Stability specifies a dynamic stability test based on a 20 mph J-turn maneuver performed on pavement. At a steering input of 180 degrees in the right and left directions, the vehicle shall not exhibit two-wheel lift.

Adequacy: The Commission does not believe the ANSI/OPEI requirement accurately characterizes the lateral stability of an ROV because the ANSI/OPEI requirement does not measure the threshold lateral acceleration at rollover. The Commission is not aware of any standards or recognized test protocols that support using a J-turn maneuver with 180 degrees of steering wheel input to assess dynamic lateral stability of an ROV.

OPEI’s use of the J-turn maneuver does not measure the lateral acceleration at two-wheel lift that produces ROV rollover. There is no correspondence between the proposed

ANSI/OPEI dynamic stability requirement and ROV lateral stability because the 180-degree steering wheel input does not correspond to a turning radius. For example, an ROV with a low steering ratio will make a sharper turn at 180 degrees of steering wheel input than an ROV with a high steering ratio. (The steering ratio relates the amount that the steering wheel is turned to the amount that the wheels of the vehicle turns. A higher steering ratio means the driver turns the steering wheel more to get the vehicle wheels to turn, and a lower steering ratio means the driver turns the steering wheel less to get the vehicle wheels to turn.) In the proposed ANSI/ROHVA J-turn test, a vehicle with a larger steering ratio will make a wider turn and generate less lateral acceleration than a vehicle with a smaller steering ratio.

The steering ratio is set by the ROV manufacturer and varies depending on make and model. SEA measured the steering ratios of the 10 sample ROVs that were tested (see Figure 13). If the dynamic lateral stability requirement is defined by a steering wheel angle input, a manufacturer could increase the steering ratio of a vehicle to meet the requirement rather than improve the vehicle’s stability.

³⁰Forkenbrock, G. and Garrott, W. (2002). A Comprehensive Experimental Evaluation of Test Maneuvers That May Induce On-Road, Untripped,

Light Vehicle Rollover Phase IV of NHTSA’s Light Vehicle Rollover Research Program. DOT HS 809 513.

³¹Gillespie, T. (1992). Fundamentals of Vehicle Dynamics. Society of Automotive Engineers, Inc. p. 309–319.

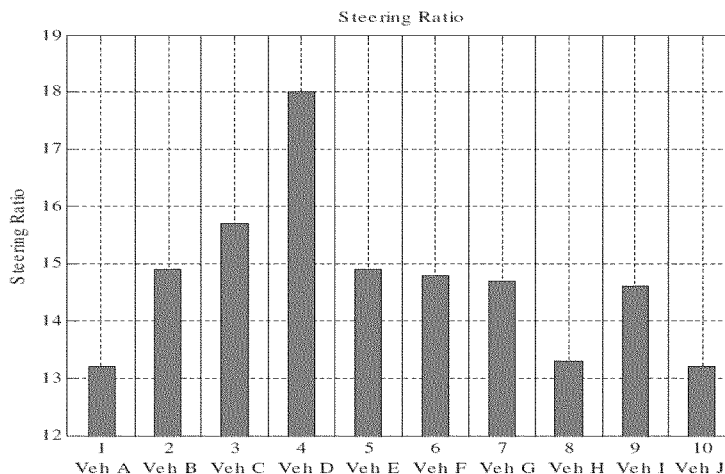

Figure 13. Steering Ratio = steering wheel input (degrees)/change in front wheel angle (degrees)

Source: Heydinger, G. (2011) Vehicle Characteristics Measurements of Recreational Off-Highway Vehicles – Additional Results for Vehicle J. Retrieved from <http://www.cpsc.gov/PageFiles/93928/rovj.pdf>.

CPSC staff contracted SEA to conduct OPEI standard, on vehicles A, F, and J J-turn testing, as specified by the ANSI/ (see Table 7).

TABLE 7—SUMMARY OF J-TURN TEST RESULTS
[20 mph with 180 degrees steering wheel angle input]

Vehicle	Turn direction	Speed required for 2-wheel	OPEI 20 mph test pass/fail outcome
Vehicle A	Right	22 mph	Pass.
	Left	21 mph	Pass.
Vehicle F	Right	21 mph	Pass.
	Left	22 mph	Pass.
Vehicle J	Right	21 mph	Pass.
	Left	23 mph	Pass.

Source: Heydinger, G. (2011) Results from Proposed ROHVA and OPEI Dynamic Maneuvers—Vehicles A, F, and J. Retrieved from <http://www.cpsc.gov/Global/Research-and-Statistics/Technical-Reports/Sports-and-Recreation/ATV-ROV/ProposedROHVAandOPEIDynamicManeuvers.pdf>.

CPSC is concerned that ROVs with low lateral stability can pass OPEI’s dynamic stability requirement because an ROV that was part of a repair program (Vehicle A) to increase its roll resistance passed the ANSI/OPEI stability test. When the ANSI/OPEI J-turn maneuver was conducted just one mile above the requirement at 21 mph, Vehicle A failed. Similarly, when the maneuver was conducted at 22 mph, Vehicle F and Vehicle J failed. These results indicate that the parameters of the test protocol allow most ROVs to pass.

NHTSA evaluated the J-turn test protocol as a method to measure rollover resistance of automobiles and determined that the J-turn test is the most objective and repeatable method for vehicles with low rollover

resistance.³² Vehicles with low rollover resistance exhibit untripped rollover on pavement during a J-turn test and the lateral acceleration at the rollover threshold can be measured. Lateral acceleration is the accepted measure by vehicle engineers for assessing lateral stability or rollover resistance.³³ This value is commonly used by engineers to compare rollover resistance from one vehicle to another. The ANSI/OPEI test protocol does not measure the lateral acceleration at two-wheel lift, and the parameters of the test appear tuned to allow most vehicles to pass. Based on CPSC’s testing and review, the CPSC

³² Forkenbrock, G. and Garrott, W. (2002). A Comprehensive Experimental Evaluation of Test Maneuvers That May Induce On-Road, Untripped, Light Vehicle Rollover Phase IV of NHTSA’s Light Vehicle Rollover Research Program. DOT HS 809 513.

³³ Gillespie, T. (1992). Fundamentals of Vehicle Dynamics. Society of Automotive Engineers, Inc. p. 309–319.

does not believe the ANSI/OPEI dynamic stability requirement is a true measure of rollover resistance, and the CPSC does not believe the requirement will improve the lateral stability of ROVs.

2. Vehicle Handling

ANSI/ROHVA 1–2011 and ANSI/OPEI B71.9 both lack provisions to address vehicle handling:

Voluntary Standard Requirement: ANSI/ROHVA 1–2011 ANSI/OPEI B71.9–2012 do not specify a vehicle handling requirement.

Adequacy: CPSC’s testing and review indicate that a requirement for sub-limit understeer is necessary to reduce ROV rollovers that may be produced by sub-limit oversteer in ROVs. Tests conducted by SEA show that ROVs in sub-limit oversteer transition to a condition where the lateral acceleration increases suddenly and exponentially.

The CPSC believes this condition can lead to untripped ROV rollovers or cause ROVs to slide into limit oversteer and experience tripped rollover.

ROVs that understeer in sub-limit conditions do not exhibit a sudden increase in lateral acceleration. Therefore, the CPSC concludes that ROVs should be required to operate in understeer at sub-limit conditions based on the associated inherent dynamic

stability of understeering ROVs and the smaller burden of steering correction it places on the average driver who is familiar with driving a passenger vehicle that operates in sub-limit understeer.

SIS tests conducted by SEA that illustrate the sudden increase in lateral acceleration that is found only in vehicles that exhibit sub-limit oversteer. The sudden increase in lateral

acceleration is exponential and represents a dynamically unstable condition. This condition is undesirable because it can cause a vehicle with low lateral stability (such as an ROV) to roll over suddenly.

In Figure 14, Vehicle A is an ROV that transitions to oversteer; Vehicle H is the same model ROV, but a later model year in which the oversteer has been corrected to understeer.

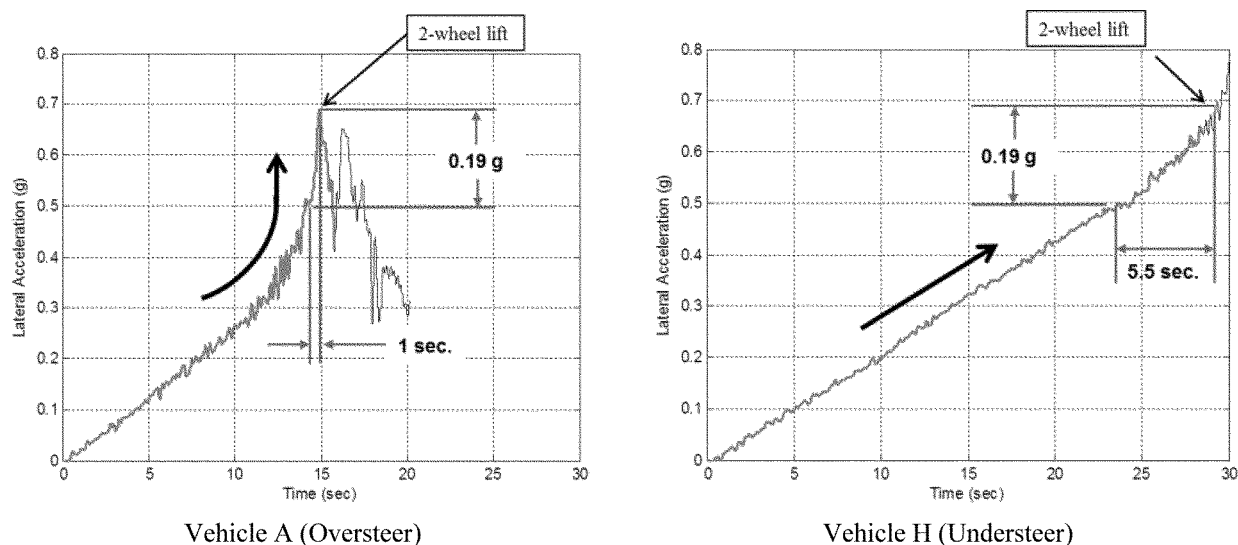

Figure 14. SIS Plots of Lateral Acceleration Gain Over Time

Source: Heydinger, G. (2011) Vehicle Characteristics Measurements of Recreational Off-Highway Vehicles . Retrieved from <http://www.cpsc.gov/PageFiles/96037/rov.pdf>.

When Vehicle A reached its dynamically unstable condition, the lateral acceleration suddenly increased in less than 1 second, and the vehicle rolled over. In contrast, Vehicle H never reaches a dynamically unstable condition because the condition does not develop in understeering vehicles. The increase in Vehicle H's lateral acceleration remains linear, and Vehicle H rolls over more than 5 seconds later than Vehicle A.

3. Occupant Protection

ANSI/ROHVA 1–2011 and ANSI/OPEI B71.9 include similar provisions to address occupant retention during a rollover event.

Voluntary Standard Requirement: ANSI/ROHVA 1–2011 Section 11.2 Seat Belt Reminder and ANSI/OPEI B71.9–2012 Section 5.1.3.2 Seat Belt Reminder System specify that ROVs shall be equipped with a seat belt reminder system that activates a continuous or flashing warning light visible to the operator for at least 8 seconds after the vehicle is started.

Adequacy: The CPSC believes the requirement for an 8-second reminder light is not adequate to increase meaningfully seat belt use rates in ROVs because the system is not intrusive enough to motivate drivers and passengers to wear their seat belts. Results from past studies on automotive seat belt reminders conclude that visual reminders are ineffective. Numerous studies also conclude that reminder systems must be intrusive enough to motivate users to buckle their seat belts. The more intrusive reminders are more effective at changing user behavior, as long as the reminder is not so intrusive that users bypass the system.

The Commission's analysis of ROV-related incidents indicates that 91 percent of fatal victims, and 73 percent of all victims (fatal and nonfatal), were not wearing a seat belt at the time of the incident. Without seat belt use, occupants experience partial to full ejection from the ROV, and many occupants are struck by the ROV after ejection. Based on review of ROV incident data and CPSC's testing

described above, the Commission believes that many ROV deaths and injuries can be eliminated if occupants are wearing seat belts.

Automotive researchers have developed technology that motivates drivers to buckle seat belts by making it more difficult to drive faster than 20–25 mph if the driver's seat belt is not buckled.³⁴ This concept shows promise in increasing seat belt use because the technology was acceptable to users and was 100 percent effective in motivating drivers to buckle their seat belts. One ROV manufacturer has also introduced a technology that limits the vehicle speed if the driver's seat belt is not buckled. ROVs with the speed-limitation technology have been in the market since 2010.

³⁴ Van Houten, R., Hilton, B., Schulman, R., and Reagan, I. (2011). Using Haptic Feedback to Increase Seat Belt Use of Service Vehicle Drivers. (DOT HS 811 434). Washington, DC: National Highway Traffic Safety Administration, U.S. Department of Transportation. Hilton, Bryan W. (2012). The Effect of Innovative Technology on Seatbelt Use. Masters Theses. Paper 103.

Given the low seat belt use rate in ROV-related incidents, as well as the substantial potential reduction in injuries and deaths if seat belt use were higher, the CPSC believes that the requirement for seat belt reminders should be more stringent and should incorporate the most recent advances in technology developed in the automotive and ROV market.

Voluntary Standard Requirement: ANSI/ROHVA 1–2011 Section 11.3 ORS Zones specifies construction and performance requirements for four zones that cover the leg/foot, shoulder/hip, arm/hand, and head/neck areas of an occupant. (Occupant retention system (ORS) is defined in ANSI/ROHVA 1–2011 as a system, including three-point seat belts, for retaining the occupant(s) of a vehicle to reduce the probability of injury in the event of an accident.) The construction requirements specify a force application test to set minimum guidelines for the design of doors, nets, and other barriers that are intended to keep occupants within the protection zone of the ROPS. The performance requirements use a tilt table and a Hybrid III 50th percentile male anthropomorphic test device (ATD) to determine occupant excursion when the vehicle is tilted 45 degrees laterally.

Adequacy: The CPSC believes the tilt table performance requirements for Zone 2—Shoulder/Hip are not adequate to ensure that occupants remain within the protective zone of the vehicle's ROPS during a rollover event. The tilt table test method measures the torso ejection outside the vehicle width, not the ejection outside the protective zone of the ROPS. The CPSC's test results indicate the tilt table test allows unacceptable occupant head excursion beyond the protective zone of the vehicle ROPS. The Commission also believes the tilt table test method is not an accurate simulation of an ROV rollover event because the test method does not reproduce the lateral acceleration and roll experienced by the vehicle, and by extension, the occupants, during a rollover.

CPSC staff also believes the construction-based test method for Zone 2 is inadequate because the specified point of application (a single point) and 3-inch diameter test probe do not accurately represent contact between an occupant and the vehicle during a rollover event. Specifying a single point does not ensure adequate coverage because a vehicle with a passive barrier at only that point would pass the test. Similarly, a 3 inch diameter probe does not represent the upper arm of an

occupant and therefore does not ensure adequate coverage.

Voluntary Standard Requirement: ANSI/OPEI B71.9–2012 Section 5.1.4 Occupant Side Retention Devices specifies ROVs shall be equipped with occupant side retention devices that reduce the probability of entrapment of a properly belted occupant's head, upper torso, and limbs between the vehicle and the terrain, in the event of a lateral rollover. Physical barriers or design features of the vehicle may be used to comply with the requirement, but no performance tests are specified to determine compliance with the requirement.

Adequacy: The Commission believes the occupant side retention requirements are not adequate because they lack performance requirements to gauge occupant protection performance. Performance requirements, based on occupant protection performance tests of ROV rollovers, are needed to ensure that occupants remain within the protective zone of the vehicle's ROPS during a rollover event.

VIII. Response to Comments

In this section, we describe and respond to comments to the ANPR for ROVs. We present a summary of each of the commenter's topics, followed by the Commission's response. The Commission received 116 comments. The comments can be viewed on: www.regulations.gov, by searching under the docket number of the ANPR, CPSC–2009–0087. Letters with multiple and detailed comments were submitted by the following:

- Joint comments submitted on behalf of Arctic Cat Inc., Bombardier Recreational Products Inc., Polaris Industries Inc., and Yamaha Motor Corporation, U.S.A. (Companies);
- Carr Engineering, Inc. (CEI);
- The OPEI/ANSI B 71.9 Committee (Committee); and
- ROHVA.

The respondents were ROV manufacturers and their associations, consultants to ROV manufacturers, and more than 110 consumers. Eighteen commenters supported developing regulatory standards for ROVs. The other commenters opposed rulemaking action. The commenters raised issues in five areas:

- Voluntary standard activities,
- Static stability metrics,
- Vehicle handling,
- Occupant protection, and
- Consumer behavior.

The comment topics are separated by category.

Voluntary Standard Activities

1. **Comment:** Comments from the Companies, ROHVA, and several individuals state that the CPSC should work with ROHVA to develop a consensus voluntary standard for ROVs.

Response: As described in detail in the previous section of this preamble, CPSC staff has been engaged actively with ROHVA since 2009, to express staff's concerns about the voluntary standard and to provide specific recommendations for the voluntary standard and supply ROHVA with CPSC's test results and data supporting the staff's recommendations.

CPSC believes the history of engagement with ROHVA, as detailed above, shows that CPSC staff has tried to work with ROHVA to improve the voluntary standard requirements to address low lateral stability, lack of vehicle handling requirements, and inadequate occupant protection requirements. The Commission does not believe deferring to ROHVA will address those areas of concern because, although ROHVA has made changes to the voluntary standard, the requirements still do not improve the lateral stability of ROVs, do not eliminate sub-limit oversteer handling, and do not improve occupant protection in a rollover event.

2. **Comment:** Comments from the Committee and ROHVA state that the Commission should defer to the current voluntary standards for ROVs. Several comments state that the current voluntary standards are adequate.

Response: In the previous section of this preamble, we explain in detail why the requirements in ANSI/ROHVA 1–2011 and ANSI/OPEI B71.9–2012 do not adequately address the risk of injury and death associated with ROVs. We summarize that explanation below.

Lateral Stability. The Commission believes the static stability requirements and the dynamic lateral stability requirements specified in both voluntary standards do not measure the vehicle's resistance to rollover. Static and dynamic tests conducted by SEA on a sample of ROVs available in the U.S. market indicate that the tests specified in ANSI/ROHVA 1–2011 and the ANSI/OPEI B71.9 will not promote improvement in the rollover resistance of ROVs.

Vehicle Handling. In addition, ANSI/ROHVA 1–2011 and ANSI/OPEI B71.9–2012 do not have requirements for vehicle handling. The Commission believes that a requirement for sub-limit understeer is necessary to reduce ROV rollovers that may be produced by sub-limit oversteer in ROVs. Tests

conducted by SEA show that ROVs in sub-limit oversteer transition to a condition where the lateral acceleration increases suddenly and exponentially. The Commission believes this runaway increase in lateral acceleration can lead to untripped ROV rollovers or cause ROVs to slide into limit oversteer and experience tripped rollover.

Occupant Protection. ANSI/ROHVA 1–2011 and ANSI/OPEI B71.9—2012 require only an 8-second reminder light to motivate users to buckle seat belts. This requirement is similar to the Federal Motor Vehicle Safety Standard (FMVSS) seat belt reminder requirements for automobiles.

Manufacturers in the automotive industry have long since exceeded such minimal seat belt reminder requirements because numerous studies have proven that the FMVSS requirements, and indeed visual-only reminders, are not effective.³⁵

Lastly, the occupant protection requirements in ANSI/ROHVA 1–2011 and ANSI/OPEI B71.9–2012 are not based on valid occupant protection performance tests that simulate conditions of vehicle rollover. ANSI/OPEI B71.9–2012 does not include any performance requirements for occupant protection. ANSI/ROHVA 1–2011 includes performance requirements based on static tilt tests that allow unacceptable occupant head ejection beyond the protective zone of the vehicle ROPS.

3. *Comment:* On February 21, 2014, OPEI sent a letter to CPSC staff requesting that the CPSC exclude multipurpose off-highway utility vehicles (MOHUVs) from CPSC's rulemaking efforts. OPEI states that there are key differences between work-utility vehicles and recreational vehicles. The differences include: Maximum vehicle speed, engine and powertrain design, cargo box configuration and capacity, towing provisions, and vehicle usage.

Response: The Commission's proposed requirements for lateral stability, vehicle handling, and occupant protection are intended to reduce deaths and injuries caused by ROV rollover and occupant ejection. ROVs are motorized vehicles that are designed for off-highway use and have four or more tires, steering wheel, non-straddle seating, accelerator and brake pedals, ROPS, restraint system, and maximum vehicle speed greater than 30 mph.

“MOHUVs,” as defined by ANSI/OPEI B71.9–2012, are vehicles with four or more wheels, a steering wheel, non-straddle seating, and maximum speed between 25 and 50 mph. Therefore, the Commission believes that an MOHUV that exceeds 30 mph is an ROV that is subject to the scope of the proposed rulemaking. The differences cited by OPEI between work-utility vehicles and recreational vehicles, e.g., the cargo capacity or the powertrain of a vehicle, do not exclude these ROVs from the hazard of rollover and occupant ejection.

Static Stability Metrics

1. *Comment:* Comments from CEI state that the Static Stability Factor (SSF), defined as T/2H, is not an appropriate metric for stability because there is no correlation between SSF values and ROV rollovers.

Response: The Commission agrees that the SSF is not an appropriate metric for ROV lateral stability because CPSC staff compared the actual lateral acceleration at rollover threshold of several ROVs, as measured by the J-turn test, and found that static measures (whether K_{st} , SSF, or TTA) are not accurate predictors of the vehicle's rollover resistance. The static tests are unable to account fully for the dynamic tire deflections and suspension compliance exhibited by ROVs. The Commission believes that the threshold lateral acceleration at rollover (A_y) is the most appropriate metric to use because it is a direct measure of the vehicle's resistance to rollover.

2. *Comment:* Comments from the Companies and the Committee state that NHTSA decided not to implement a minimum SSF standard for on-road vehicles because it would have forced the radical redesign of the characteristics of many, and in some cases, all vehicles of certain classes, which would have raised issues of public acceptance and possibly even the elimination of certain classes of vehicles.

Response: Contrary to the comment's implication that setting a minimum lateral stability (in this case SSF) is detrimental to vehicle design, and that NHTSA abandoned the use of SSF, NHTSA concluded that there is a causal relationship between SSF and rollover, and NHTSA has incorporated the SSF in its New Car Assessment Program (NCAP) rating of vehicles. In June 1994, NHTSA terminated rulemaking to establish a minimum standard for rollover resistance because it would be difficult to develop a minimum stability standard that would not disqualify whole classes of passenger vehicles

(light trucks and sport utility vehicles) that consumers demand. Instead, by January 2001, NHTSA concluded that consumer information on the rollover risk of passenger cars would influence consumers to purchase vehicles with a lower rollover risk and inspire manufacturers to produce vehicles with a lower rollover risk.³⁶ NHTSA found consistently that given a single-vehicle crash, the SSF is a good statistical predictor of the likelihood that the vehicle will roll over.³⁷ The number of single-vehicle crashes was used as an index of exposure to rollover because this method eliminates the additional complexity of multi-vehicle impacts and because about 82 percent of light vehicle rollovers occur in single-vehicle crashes. NHTSA decided to use the SSF to indicate the risk of rollover in single-vehicle crashes and to incorporate the new rating into NHTSA's New Car Assessment Program (NCAP). Based on NHTSA's statistical analysis of single-vehicle crash data and vehicle SSF value, the NCAP provides a 5-star rating system. One star represents a 40 percent or higher risk of rollover in a single vehicle crash; two stars represent a risk of rollover between 30 percent and 40 percent; three stars represent a risk of rollover between 20 percent and 29 percent; four stars represent a risk of rollover between 10 percent and 19 percent; and five stars represent a risk of rollover of less than 10 percent.

A subsequent study of SSF trends in automobiles found that SSF values increased for all vehicles after 2001, particularly SUVs, and SUVs tended to have the worst SSF values in the earlier years. NHTSA's intention that manufacturers improve the lateral stability of passenger vehicles was achieved through the NCAP rating, a rating based predominantly on the SSF value of the vehicle.

Based on dynamic stability tests conducted by SEA and improvements in the Yamaha Rhino after the repair program was initiated, the Commission believes that setting a minimum rollover resistance value for ROVs can improve the lateral stability of the current market of ROVs, without forcing radical designs or elimination of any models. The Commission also believes continued increase in ROV lateral stability can be achieved by making the value of each model vehicle's threshold lateral

³⁶ Walz, M. C. (2005). Trends in the Static Stability Factor of Passenger Cars, Light Trucks, and Vans. DOT HS 809 868. Retrieved from <http://www.nhtsa.gov/cars/rules/regrev/evaluate/809868/pages/index.html>.

³⁷ Rollover Prevention Docket No. NHTSA–2000–6859 RIN 2127–AC64. Retrieved from <http://www.nhtsa.gov/cars/rules/rulings/rollover/Chapt05.html>.

³⁵ Westefeld, A. and Phillips, B.M. (1976). Effectiveness of Various Safety Belt Warning Systems. (DOT HS 801 953). Washington, DC: National Highway Traffic Safety Administration, U.S. Department of Transportation.

acceleration at rollover available to consumers. Publication of an ROV model's rollover resistance value on a hang tag will allow consumers to make informed purchasing decisions regarding the comparative lateral stability of ROVs. In addition, publication of rollover resistance will provide a competitive incentive for manufacturers to improve the rollover resistance of their ROVs.

3. *Comment:* Comments from the Companies and the Committee state that K_{st} is the more appropriate stability factor than SSF because it accounts for differences in the rear and track width, as well as differences in the fore and aft location of the vehicle's center of gravity.

Response: K_{st} is a three-dimensional calculation of the two-dimensional SSF, and when the front and rear track widths are equal, K_{st} equals SSF. For practical purposes, K_{st} and SSF provide the same information on ROVs. Occupant-loaded values of K_{st} and SSF are informative to the design process of ROVs; however, K_{st} and SSF values do not account for all the dynamic factors that affect actual rollover resistance. Therefore, they do not represent the best stability metric for ROVs.

The Commission compared the actual lateral acceleration at rollover threshold of several ROVs, as measured by the J-turn test, and found that the static measures (whether K_{st} , SSF, or TTA) are not accurate predictors of the vehicle's actual lateral stability. Direct dynamic measurement of the vehicle's resistance to rollover is possible with ROVs. Therefore, the Commission believes that J-turn testing to determine the threshold lateral acceleration at rollover should be used as the standard requirement to determine lateral stability.

4. *Comment:* Comments from CEI and the Companies state that tilt table angle or tilt table ratio should be used as a measure of lateral stability.

Response: As stated above, the staff compared the actual lateral acceleration at rollover threshold of several ROVs, as measured by the J-turn test, and found that the static measures (whether it is K_{st} or SSF or TTA) are not accurate predictors of the vehicle's actual lateral stability.

The Commission believes that the tilt table requirement in ANSI/ROHVA 1–2011 does not adequately address lateral stability in ROVs. A comparison of how the vehicles would rank if the TTA were used instead of the direct measurement of lateral acceleration at rollover (A_y) illustrates how poorly the TTA correlates to the actual rollover resistance of the vehicle. The tilt table test does not account for dynamic

effects of tire compliance, suspension compliance, and vehicle handling, which are important factors in the vehicle's lateral stability.

Direct dynamic measurement of the vehicle's resistance to rollover is possible with ROVs. Therefore, the Commission believes that J-turn testing to determine the threshold lateral acceleration at rollover should be used as the standard requirement to determine lateral stability.

5. *Comment:* Comments from the Companies state that the ANSI/ROHVA 1, *American National Standard for Recreational Off-Highway Vehicles*, lateral stability requirement of $K_{st} = 1$ and TTA = 30 degrees is adequate and should be adopted by CPSC.

Response: SEA tested 10 representative ROV samples to the tilt table requirements in ANSI/ROHVA 1–2011. All of the ROVs tested pass the minimum 30-degree TTA, which indicates that the tilt table requirement is a status quo test. Vehicle D, the vehicle with the lowest rollover resistance ($A_y = 0.625$ g, TTA = 33.7 degrees), exceeds the TTA requirement by 3.7 degrees, or 12 percent above the 30-degree minimum requirement. Vehicle A, the ROV that was part of a repair program to increase its roll resistance, exceeds the TTA requirement by 3.0 degrees, or 10 percent above the 30-degree minimum.

CPSC believes the ANSI/ROHVA and ANSI/OPEI tilt table requirement is a requirement that all ROVs can pass and will not promote improvement among vehicles that have lower rollover resistance. The TTA requirement in the voluntary standard does not correlate to the actual rollover resistance of ROVs; the requirement allows the Yamaha Rhino to pass the test without having undergone the repair; and the requirement provides no incentive for manufacturers to improve the lateral stability of ROVs. The Commission believes that the threshold lateral acceleration at rollover value is a direct measure for rollover resistance, and its use would eliminate the need for tilt table testing as a requirement.

6. *Comment:* Comments from the Companies, the Committee, and several individuals state that the SSF values recommended by CPSC staff for ROVs would make the vehicles unusable for off-road use and would eliminate this class of vehicle.

Response: Based on the testing and data discussed in this preamble, CPSC staff no longer recommends using the SSF value as a measure of an ROV's rollover resistance. The SSF value of a vehicle represents the best theoretical lateral stability that the vehicle can

achieve. CPSC staff compared the actual lateral acceleration at rollover threshold of several ROVs, as measured by the J-turn test, and found that the static measures (whether it is K_{st} , or SSF, or TTA) are not accurate predictors of the vehicle's actual lateral stability due to the extreme compliance in the vehicle's suspension and tires. Therefore, the Commission believes that neither the K_{st} , nor the SSF is an accurate measure of an ROV's lateral stability. Rather, the vehicle's actual lateral acceleration at rollover threshold is the appropriate measure of the vehicle's lateral stability.

Vehicle Handling

1. *Comment:* Comments from CEI and the Companies state that measurements of understeer/oversteer made on pavement are not applicable to non-pavement surfaces. ROVs are intended for off-highway use and any pavement use is product misuse, they assert.

Response: Both the ANSI/ROHVA and ANSI/OPEI standards specify dynamic testing on a paved surface. This indicates that ROHVA and OPEI agree that testing of ROVs on pavement is appropriate because pavement has a uniform high-friction surface. Tests conducted on pavement show how the vehicle responds at lateral accelerations that range from low lateral accelerations (associated with low friction surfaces like sand) up to the highest lateral acceleration that can be generated by friction at the vehicle's tires. This provides a complete picture of how the vehicle handles on all level surfaces. The amount of friction at the tires, and thus, the lateral accelerations generated, varies on non-paved surfaces. However, the vehicle's handling at each lateral acceleration does not change when the driving surface changes.

2. *Comment:* Comments from CEI state that CEI has performed various tests and analyses on ROVs that demonstrate that ROVs that exhibit oversteer are not unstable.

Response: The Commission disagrees with the statement that ROVs that exhibit oversteer are stable. Vehicles that exhibit sub-limit oversteer have a unique and undesirable characteristic, marked by a sudden increase in lateral acceleration during a turn. This dynamic instability is called critical speed and is described by Thomas D. Gillespie in the *Fundamentals of Vehicle Dynamics* as the speed "above which the vehicle will be unstable."³⁸ Gillespie further explains that an oversteer vehicle "becomes

³⁸ Gillespie, T. (1992). *Fundamentals of Vehicle Dynamics*. Society of Automotive Engineers, Inc. p. 204–205.

directionally unstable at and above the critical speed” because the lateral acceleration gain approaches infinity.

CEI states that their tests demonstrate that ROVs that exhibit oversteer are not unstable. However, testing performed by

SEA shows that oversteering ROVs can exhibit a sudden increase in lateral acceleration resulting in a roll over.

Plots from SIS tests illustrate this sudden increase in lateral acceleration, which is found only in vehicles that

exhibit sub-limit oversteer (see Figure 15). Vehicle A is an ROV that transitions to oversteer; Vehicle H is the same model ROV, but a later model year in which the oversteer has been corrected to understeer.

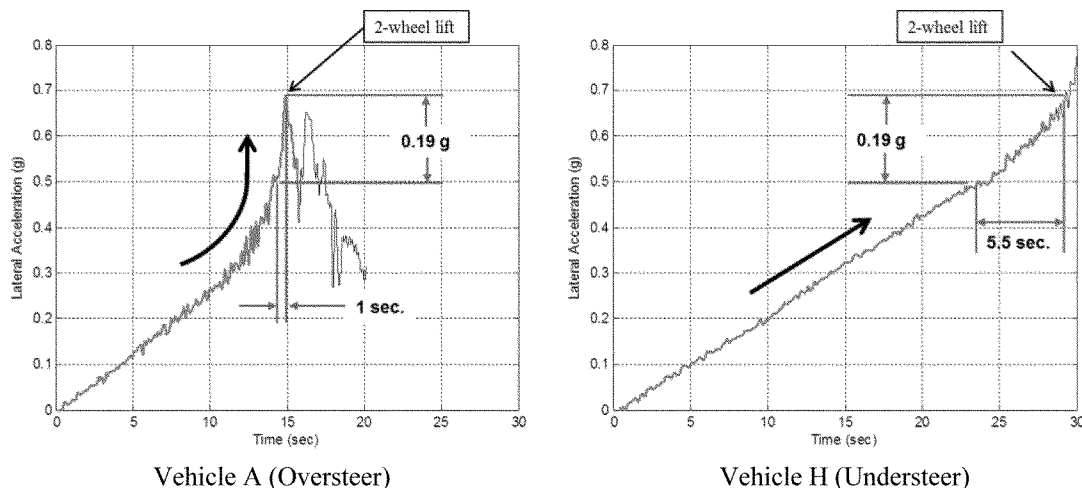

Figure 15. SIS Plot of Lateral Acceleration Gain Over Time

Source: Heydinger, G. (2011) Vehicle Characteristics Measurements of Recreational Off-Highway Vehicles . Retrieved from <http://www.cpsc.gov/PageFiles/96037/rov.pdf>.

When Vehicle A reached its dynamically unstable condition, the lateral acceleration suddenly increased from 0.50 g to 0.69 g (difference of 0.19 g) in less than 1 second, and the vehicle rolled over. (Outriggers on the vehicle prevented full rollover of the vehicle.) In contrast, Vehicle H never reached a dynamically unstable condition because the condition does not develop in understeering vehicles. The increase in Vehicle H's lateral acceleration remains linear, and the lateral acceleration increase from 0.50 g to 0.69 g (same difference of 0.19 g) occurs in 5.5 seconds. A driver in Vehicle H has more margin to correct the steering to prevent rollover than a driver in Vehicle A because Vehicle H remains in understeer during the turn, while Vehicle A transitions to oversteer and becomes dynamically unstable.

SEA test results indicate that ROVs that exhibited sub-limit oversteer also exhibited a sudden increase in lateral acceleration that caused the vehicle to roll over. An ROV that exhibits this sudden increase in lateral acceleration is directionally unstable and uncontrollable.³⁹ Tests conducted by

SEA provide strong evidence that sub-limit oversteer in ROVs is an unstable condition that can lead to a rollover incident, especially given the low rollover resistance of ROVs.

3. *Comment:* Comments from CEI and the Companies state that all vehicles, whether they understeer or oversteer, can be driven to limit conditions and can spin or plough. Any vehicle can exhibit “limit oversteer” through manipulation by the driver.

Response: The Commission does not dispute that operator input and road conditions can affect limit oversteer or understeer in a vehicle. The vehicle handling requirements proposed by the Commission specify that vehicles exhibit sub-limit understeer. The Commission believes that sub-limit oversteer is an unstable condition that can lead to a rollover incident. Ten sample ROVs were tested by SEA; five of the 10 vehicles exhibited a desirable sub-limit understeer condition, and five exhibited a transition to undesirable sub-limit oversteer condition. CPSC's evaluation indicates that ROVs can be designed to understeer with minimal cost and without diminishing the utility or recreational value of this class of vehicle.

4. *Comment:* Comments from the Companies state that oversteer is desirable for path-following capability.

Specifically, vehicles in oversteer will generally follow the path and allow directional control of the vehicle. High rear tire slip angles and tire longitudinal slip are needed for traction on off-highway surfaces, such as loose soil.

Response: The Commission is not aware of any studies that define “path-following capability” and its relation to the sub-limit understeer or oversteer design of the vehicle. Of the 10 sample ROVs tested by SEA, five vehicles exhibited a desirable sub-limit understeer condition. The Commission is not aware of any reports of the steering of sub-limit understeering vehicles causing loss of control or preventing the driver from navigating off-road terrain.

A significant body of research has been developed over many years regarding the science of vehicle dynamic handling and control. The Commission has reviewed technical papers regarding vehicle handling research and finds no agreement with the statement that “a vehicle in an oversteer condition will generally follow the path and allow directional control of the vehicle to be maintained longer.” In fact, the Commission's research finds universal characterization of sub-limit oversteer as directionally unstable, highly undesirable, and dynamically unstable at or above the

³⁹ Bundorf, R. T. (1967). The Influence of Vehicle Design Parameters on Characteristic Speed and Understeer. SAE 670078; Segel, L. (1957). Research in the Fundamentals of Automobile Control and Stability. SAE 570044.

critical speed.⁴⁰ The Commission's review of 80 years of automotive research did not find support for the suggestion that sub-limit oversteer provides superior precision in handling and control.

Likewise, limit oversteer is described by the Companies as the result of the driver "operating the vehicle in a turn at a speed beyond what is safe and reasonable for that turn or applying excessive power in a turn." A vehicle in limit oversteer is essentially sliding with the rear of the vehicle rotating about the yaw axis. A vehicle in a slide is susceptible to a tripped rollover. ROVs have low rollover resistance and are at high risk of a violent, tripped rollover. Autonomous vehicle testing by SEA has duplicated these limit oversteer conditions and found that tripped rollovers can create in excess of 2 g to 3 g of instantaneous lateral acceleration, which produces a violent rollover event. CPSC's evaluation indicates that eliminating sub-limit oversteer will reduce unintentional transitions to limit oversteer.

The Commission does not agree that producing power oversteer by spinning the rear wheels is a necessity for negotiating low-friction, off-highway surfaces. Drifting or power oversteering is a risky practice that presents tripped rollover hazards and does not improve the vehicle's controllability. However, the practice of power oversteering is the result of driver choices that are not under the control of the manufacturer or the CPSC, and will not be significantly affected by the elimination of sub-limit oversteer.

5. *Comment:* Comments from the Companies state that requiring ROVs to exhibit understeer characteristics could create unintended and adverse risk, such as gross loss of mobility. These commenters assert that CPSC would be trading one set of purported safety issues for another, equally challenging set of safety issues, and running against 100 years of experience in off-highway vehicle design and driving practice, which suggests that for off-highway conditions, limit oversteer is at least

sometimes, if not most often, preferable to limit understeer.

Response: ROVs that exhibit sub-limit understeering are currently in the U.S. market in substantial numbers. The Commission is not aware of any reports of the steering of sub-limit understeering vehicles causing loss of control or preventing the driver from navigating off-road terrain. The CPSC is not aware of any reports of sub-limit understeering vehicles that exhibit the unintended consequences described by the Companies.

The Commission believes that sub-limit oversteer is an unstable condition that can lead to a rollover incident. Based on the Yamaha Rhino repair program and the SEA test results indicating that half of the sample ROVs tested already exhibit sub-limit understeer, the CPSC believes that ROVs can be designed to understeer with minimum cost and without diminishing the utility or recreational value of this class of vehicle.

6. *Comment:* Comments from CEI, the Companies, and the Committee state that no correlation can be shown between understeer/oversteer and ROV crashes or rollovers.

Response: From a design and engineering perspective, the physics of vehicle rollover inherently support the fact that increasing a vehicle's resistance to rollover will make the vehicle more stable. In addition, eliminating a vehicle characteristic that exhibits a sudden increase in lateral acceleration during a turn will reduce the risk of rollover. The constant radius tests and SIS tests conducted by SEA provide strong evidence that sub-limit oversteer is an unstable condition that can lead to a rollover incident.

Of the 428 ROV-related incidents reviewed by the CPSC, 291 (68 percent) involved lateral rollover of the vehicle, and more than half of these (52 percent) occurred while the vehicle was turning. Of the 147 fatal incidents that involved rollover, 26 (18 percent) occurred on a paved surface. A vehicle exhibiting oversteer is most susceptible to rollover in a turn where the undesirable sudden increase in lateral acceleration can cause rollover to occur quickly, especially on paved surfaces, where an ROV can exhibit an untripped rollover.

The Commission believes that improving the rollover resistance and vehicle steering characteristics of ROVs is a practical strategy for reducing the occurrence of ROV rollover events.

Occupant Protection

1. *Comment:* Comments from CEI, the Companies, and the Committee state that seat belt use is critically important.

Increasing seat belt use is the most productive and effective way to reduce ROV-related injuries and deaths because seat belt use is so low among those injured in ROV incidents. A major challenge is clearly how to get occupants to use the seat belt properly.

Response: The Commission agrees that the use of seat belts is important in restraining occupants in the event of a rollover or other accident. Results of the Commission's testing of belted and unbelted occupants in simulated ROV rollover events indicate that seat belt use is required to retain occupants within the vehicle. Without seat belt use, occupants experience partial to full ejection from the vehicle. This scenario has been identified as an injury hazard in the CPSC's review of ROV-related incidents. Of those incidents that involved occupant ejection, many occupants suffered crushing injuries caused by the vehicle.

After reviewing the literature regarding automotive seat belts, the Commission believes that an 8-second reminder light, as required in ANSI/ROHVA 1–2011 and ANSI/OPEI B71.9–2012, is not adequate to increase meaningfully seat belt use rates in ROVs because the system is not intrusive enough to motivate drivers and passengers to wear their seat belts. Results from past studies on automotive seat belt reminders conclude that visual reminders are ineffective. Numerous studies conclude further that effective reminder systems have to be intrusive enough to motivate users to buckle their seat belts. The more intrusive reminders are more effective at changing user behavior, as long as the reminder is not so intrusive that users bypass the system.

Based on literature and results from the Westat study, the Commission believes that a seat belt speed limiting system that restricts the maximum speed of the vehicle to 15 mph, if the driver seat and any occupied front seats are not buckled, is the most effective method to increase meaningfully seat belt use rates in ROVs. The system is transparent to users at speeds of 15 mph and below, and the system consistently motivates occupants to buckle their seat belts to achieve speeds above 15 mph.

2. *Comment:* Comments from CEI state that four-point and five-point seat belts are not appropriate for ROVs. In contrast, several individual comments state that five-point seat belts should be required on ROVs.

Response: The Commission identified lack of seat belt use as an injury hazard in the CPSC's review of ROV-related incidents. The majority of safety restraints in the ROV incidents were

⁴⁰ Olley, M. (1934). Independent Wheel Suspension—Its Whys and Wherefores. SAE 340080.; Stonex, K. A. (1941). Car Control Factors and Their Measurement. SAE 410092.; Segel, L. (1957). Research in the Fundamentals of Automobile Control and Stability. SAE 570044.; Bergman, W. (1965). The Basic Nature of Vehicle Understeer—Oversteer. SAE 650085.; Bundorf, R. T. and Leffert, R. L. (1976). The Cornering Compliance Concept for Description of Vehicle Directional Control Properties. SAE 760713.; and Milliken, William F., Jr., et al. (1976). The Static Directional Stability and Control of the Automobile. SAE 760712.

three-point restraints, and to some extent, two-point seat belts. Although four-point seat belts might be superior to three-point seat belts in retaining occupants in a vehicle, three-point seat belts have been shown to be effective in reducing the risk of death and serious injury in automotive applications. The Commission believes that it is unlikely that users who already do not use three-point seat belts will use the more cumbersome four-point and five-point seat belts.

A more robust seat belt reminder system than the current voluntary standard requirement for a visual reminder light is necessary to motivate users to wear their seat belts because automotive studies of seat belt reminders indicate that visual reminders do not increase seat belt use. Dynamic rollover tests of ROVs indicate that a three-point seat belt, in conjunction with a passive shoulder restraint, is effective in restraining an occupant inside the protective zone of the vehicle's ROPS during a quarter-turn rollover.

3. *Comment:* Comments from CEI state that occupant protection requirements should be based on meaningful tests.

Response: The Commission agrees that ROV occupant protection performance evaluations should be based on actual ROV rollovers or simulations of real-world rollovers. Occupant protection performance requirements for ROVs in the voluntary standard developed by ROHVA (ANSI/ROHVA 1-2011) and the voluntary standard developed by OPEI (ANSI/OPEI B71.9-2012) are not supported by data from rollover tests.

The SEA roll simulator is the most accurate simulation of an ROV rollover event because it has been validated by measurements taken during actual ROV rollovers. Rollover tests indicate that a seat belt, used in conjunction with a passive shoulder barrier, is effective at restraining occupants within the protective zone of the vehicle's ROPS during quarter-turn rollover events.

ROV Incident Analysis

1. *Comment:* Comments from CEI state that ROV rollover incidents are caused by a small minority of drivers who intentionally drive at the limits of the vehicle and the driver's abilities, and intentionally drive in extreme environments.

Response: Of the 224 reported ROV incidents that involved at least one fatality, 147 incidents involved lateral rollover of the vehicle. Of the 147 lateral rollover fatalities, it is reported that the ROV was on flat terrain in 56 incidents

(38 percent) and on a gentle incline in 18 incidents (12 percent). Of the 224 fatal ROV incidents, the vehicle speed is unknown in 164 incidents (73 percent); 32 incidents (14 percent) occurred at speeds of 20 miles per hour (mph) or less; and 28 incidents (13 percent) occurred at speeds more than 20 mph. (Vehicle speeds were reported (*i.e.*, not measured by instrumentation); so these speeds can be used qualitatively only and not as accurate values of speed at which incidents occurred.) Of the 224 fatal ROV incidents, the age of the driver was less than 16 years old in 61 incidents (27 percent). Of the 231 fatalities, 77 victims (33 percent) were children less than 16 years of age.

A review of the incident data shows no indication that the majority of rollover incidents are caused by drivers who "purposely push the vehicle to and beyond its limits by engaging in stunts, racing, and intentional use of extreme environments." An analysis of the reported ROV incidents indicates that many of the details of the circumstances of the event, such as vehicle speed or terrain slope, are not known. In cases in which details of the event are known, roughly 50 percent of the fatal lateral rollover incidents occurred on flat or gentle slope terrain; and 14 percent occurred at speeds below 20 miles per hour. Twenty-seven percent of the drivers in fatal rollover incidents are children under 16 years of age; and 33 percent of all ROV-related fatalities are children under 16 years of age.

2. *Comment:* Comments from the Companies state that the CPSC failed to use data from the NEISS in its analysis of ROV hazards. The comments suggest further that analysis of the NEISS data on utility-terrain vehicles (UTVs) indicate that UTVs, and therefore, ROVs, have a low hospitalization rate.

Response: The joint comment's conclusions based on the commenters' analyses of the NEISS UTV data are not technically sound because the NEISS results do not specifically identify ROVs. NEISS has a product code for UTVs and several product codes for ATVs, but there is no separate product code for ROVs. ATVs have a straddle seat for the operator and handlebars for steering. UTVs have bucket or bench seats for the operator/passengers, a steering wheel for steering, and UTVs may or may not have a ROPS. ROVs are a subset of UTVs and are distinguished by having a ROPS, seat belts, and a maximum speed above 30 mph. However, many official entities, news media, and consumers refer to ROVs as ATVs. Injuries associated with ROVs are usually assigned to either an ATV product category or to the UTV product

category in NEISS. At a minimum, ROVs can be thought of as a subset of UTVs and/or ATVs, and cannot be identified on a consistent basis through the NEISS case records because NEISS requires knowledge of the make/model of the vehicle (which is not coded in the NEISS for any product). Occasionally, the NEISS narrative contains make/model identification, but this cannot be used to identify ROVs accurately and consistently.

CPSC conducted a special study in 2010, in which all cases coded as ATVs or UTVs were selected for telephone interviews to gather information about the product involved. Sixteen of the 668 completed surveys had responses that identified the vehicle as an ROV. Staff's analysis shows that many ROVs are coded as ATVs; many UTVs are also coded as ATVs; and identification of ROVs and UTVs is difficult because the NEISS narratives often do not include enough information to identify the product. The miscoding rate for UTVs and ROVs is high, and most likely, the miscoding is due to consumer-reported information in the emergency department.

The CPSC added the UTV product code 5044 to the NEISS in 2005. In the years 2005 to 2008 (the years cited in the joint comment document), the UTV product code had mostly out-of-scope records, with a large number of utility trailers and similar records. After these out-of-scope records are removed, the only viable estimate is obtained by aggregating the cases across 2005 to 2008, to get an estimated 1,300 emergency department-treated injuries related to UTVs (see Tab K, Table 1). This estimate is considerably less than the estimate reported by Heiden in the joint comment. This estimate also does not include the UTV-related injuries that were miscoded as ATVs in the ATV product codes.

As the years have passed and the UTV product code is being used more as intended, a completely different picture is seen for UTVs. From 2009 to 2012, there are an estimated 6,200 emergency department-treated, UTV-related injuries (which can be attributed to an increase in the number of UTV-related injuries, a larger portion of injuries being identified in NEISS as UTVs, or a combination of all of these and other factors not identified). Of these estimated 6,200 injuries, only 80.2 percent are treated and released. The proportion of treated and released injuries for UTVs is significantly below the proportion of treated and released for all consumer products (92.0 percent of estimated consumer product-related, emergency department-treated injuries

were treated and released from 2009 to 2012). This illustrates a hazard of more severe injuries associated with UTVs.

In conclusion, data are insufficient to support the argument that UTV injuries are not as severe as those associated with other products. As more data have become available in recent years, it appears that about 80 percent of the injuries associated with UTVs have been treated and released as compared to about 92 percent of the injuries associated with all consumer products.

3. *Comment:* The Companies provided their own analysis of ROV-related reports that were used in the CPSC's ANPR analysis. In particular, the Companies criticize Commission staff's analysis because asserting that staff's analysis did not include factors related to incident conditions and user behavior.

Response: Commission staff's analysis of incidents for the ANPR was a preliminary review of reported incidents to understand the overall hazard patterns. For the NPR, Commission staff conducted an extensive, multidisciplinary review of 428 reported ROV-related incidents resulting in at least one death or injury. The results of this study are summarized in two reports in the NPR briefing package, along with analyses of victim characteristics, hazard patterns, environmental characteristics, and make and model characteristics. (The approach taken in the comments from the Companies, to remove reports from the analysis because there is unknown information, is not the Commission's approach in analyzing ROV-related incidents.) Unknowns from all reports are included with the knowns to ensure that the full picture is seen because every report will have at least one piece of unknown information, and every report will have at least one piece of known information. The unknowns are reported in all tables, if unknowns were recorded for the variables used.

The analysis of IDIs summarized in the comments from the Companies does not define "excessive speed," "dangerous maneuver," or "sharp turn." In fact, in other places in the comments, the companies mention: "There is also no evidence suggesting that speed is an important factor in preventing accidents." The companies also state: "Tight steering turn capability is an important feature in certain ROVs, particularly those for trail use, because of the need to respond quickly to avoid obstacles and trail-edge drop-offs, and otherwise navigate in these off-highway terrains" Thus, there is ambiguity in what the definitions could mean in the analysis of the IDIs (When is the vehicle

at an excessive speed? When is a turn too sharp? When is a maneuver dangerous?). The Commission's approach to analyzing the 428 incidents summarized in the reports available in the NPR briefing package is to consider the sequence of events, the vehicle, the driver, any passenger, and environment characteristics across all incidents. All definitions are set and used consistently by the multidisciplinary review team to understand the hazard patterns and incident characteristics across all incidents, not to set responsibility in one place or another.

4. *Comment:* Comments from CEI state that the CPSC should begin to address human factors that pertain to risk-taking behavior of the small minority of ROV users who operate the vehicles at their limits without crash-worthiness concerns. In particular, CEI proposes that the CPSC focus primarily on changing consumer behavior to wearing seat belts, wearing helmets, and refraining from driving ROVs irresponsibly.

Response: The Commission agrees that human factors and behavior affect the risk of death and injury for ROV users. However, the CPSC believes that establishing minimum requirements for ROVs can also reduce the hazards associated with ROVs. As explained in this preamble, the ANSI/ROHVA voluntary standard does not adequately address the risk of injury and death associated with lateral rollovers of ROVs because the standards do not have robust lateral stability requirements, do not have vehicle handling requirement to ensure understeer, and do not have robust occupant restraint requirements to protect occupants from vehicle rollover.

An analysis of the reported ROV incidents indicates that many of the details of an event, such as vehicle speed or terrain slope, are not known. Where details of the event are known, roughly 50 percent of the fatal lateral rollover incidents occurred on flat or gentle slope terrain, and 14 percent occurred at speeds below 20 miles per hour. Twenty-seven percent of the drivers in fatal rollover incidents are children under 16 years of age; and 33 percent of all ROV-related fatalities are children under 16 years of age. There is no indication that the majority of rollover incidents are caused by drivers who intentionally drive under extreme conditions.

Regarding seat belt use, results from past studies on automotive seat belt reminders conclude that visual seat belt reminders are ineffective. Numerous studies further conclude that effective reminder systems have to be intrusive

enough to motivate users to buckle their seat belts. The more intrusive reminders are more effective at changing user behavior, as long as the reminder is not so intrusive that users bypass the system.

The Commission believes that a seat belt speed-limiting system that restricts the maximum speed of the vehicle to 15 mph if the driver seat and any occupied front seats are not buckled is the most effective method to increase meaningfully seat belt use rates in ROVs. The system is transparent to users at speeds of 15 mph and below, and the system consistently motivates occupants to buckle their seat belts to achieve speeds above 15 mph.

IX. Description of the Proposed Rule

A. Scope, Purpose, and Compliance Dates—§ 1422.1

The proposed standard would apply to "recreational off-highway vehicles" (ROVs), as defined, which would limit the scope to vehicles with a maximum speed greater than 30 mph. The proposed standard would include requirements relating to lateral acceleration, vehicle handling, and occupant protection. The requirements are intended to reduce or eliminate an unreasonable risk of injury associated with ROVs. The proposed standard would specifically exclude "golf cars," "all-terrain vehicles," "fun karts," "go karts," and "light utility vehicles," as defined by the relevant voluntary standards. The Commission proposes two compliance dates: ROVs would be required to comply with the lateral stability and vehicle handling requirements (§§ 1422.3 and 1422.4) 180 days after publication of the final rule in the **Federal Register**. ROVs would be required to comply with the occupant protection requirements (§ 1422.5) 12 months after publication of the final rule in the **Federal Register**. The Commission recognizes that some ROV manufacturers will need to redesign and test new prototype vehicles to meet the occupant protection requirements. This design and test process is similar to the process that manufacturers use when introducing new model year vehicles. As described more fully in Section X, staff estimates that it will take approximately 9 person-months per ROV model to design, test, implement, and begin manufacturing vehicles to meet the occupant protection performance requirements. Therefore, the Commission believes that 12 months is a reasonable time period for manufacturers to comply with all of new mandatory requirements.

B. Definitions—§ 1422.2

The proposed standard would provide that the definitions in section 3 of the Consumer Product Safety Act (15 U.S.C. 2051) apply. In addition, the proposed standard would include the following definitions:

- “Recreational off-highway vehicle”—a motorized vehicle designed for off-highway use with the following features: Four or more wheels with pneumatic tires; bench or bucket seating for two or more occupants; automotive-type controls for steering, throttle, and braking; rollover protective structures (ROPS); occupant restraint; and maximum speed capability greater than 30 mph.

- “two-wheel lift”—point at which the inside wheels of a turning vehicle lift off the ground, or when the uphill wheels of a vehicle on a tilt table lift off the table. Two-wheel lift is a precursor to a rollover event. We use the term “two-wheel lift” interchangeably with “tip-up.”

- “threshold lateral acceleration”—minimum lateral acceleration of the vehicle at two-wheel lift.

C. Requirements for Dynamic Lateral Stability—§ 1422.3

1. Proposed Performance Requirement

a. Description of Requirement

The proposed rule would require that all ROVs meet a minimum requirement for lateral stability. The dynamic lateral stability requirement would set a minimum value for the lateral acceleration at rollover of 0.70 g, as determined by a 30 mph drop-throttle J-turn test. The 30 mph drop-throttle J-turn test uses a programmable steering controller to turn the test vehicle traveling at 30 mph at prescribed steering angles and rates to determine the minimum steering angle at which two-wheel lift is observed. These are the conditions and procedures that were used in testing with SEA. Under the proposed requirements, the data collected during these tests are analyzed to compute and verify the lateral acceleration at rollover for the vehicle. The greater the lateral acceleration value, the greater is the resistance of the ROV to tip or roll over.

b. Rationale

The J-turn test is the most appropriate method to measure the rollover resistance of ROVs because the J-turn test has been evaluated by NHTSA as the most objective and repeatable method for vehicles with low rollover resistance. As discussed previously, static metrics, such as SSF and TTR, cannot be used to evaluate accurately

ROV rollover resistance because static tests are unable to account fully for the dynamic tire deflections and suspension compliance exhibited by ROVs during a J-turn maneuver. The Commission also verified that the J-turn test is objective and repeatable for ROVs by conducting numerous J-turn tests on several ROVs.

As explained above, testing conducted by CPSC staff and SEA supports the proposed requirement that ROVs demonstrate a minimum threshold lateral acceleration at rollover of 0.70 g or greater in a J-turn. Results of J-turn tests performed on a sample of 10 ROVs available in the U.S. market indicate that six of the 10 ROVs tested measured threshold lateral accelerations below 0.70 g (values ranged from 0.625 g to 0.690 g). The Commission believes that minor changes to vehicle suspension and/or track width spacing, similar to the changes in the Yamaha Rhino repair program, can increase the threshold lateral acceleration of these vehicles to 0.70 g or greater. The Yamaha repair program improved the rollover resistance of the Yamaha Rhino from 0.670 g (unrepaired Yamaha Rhino) to 0.705 g (repaired Yamaha Rhino).

Based on CPSC’s evaluation of ROV testing and the decrease in injuries and deaths associated with Yamaha Rhino vehicles after the repair program was implemented, the Commission believes that improving the rollover resistance of all ROVs can reduce injuries and deaths associated with ROV rollover events.

2. Proposed Requirements for Hang Tag

a. Description of Requirement

The Commission is proposing a requirement that ROV manufacturers provide technical information for consumers on a hangtag at the point of purchase.

As discussed previously, the Commission is proposing a requirement that ROVs meet a minimum lateral acceleration of 0.70 g at rollover, as identified by J-turn testing. The Commission proposes requiring a hangtag on each ROV that would state the actual measured lateral acceleration at rollover (as identified by the J-turn testing) of each ROV model. The Commission believes that the hang tag will allow consumers to make informed decisions on the comparative lateral stability of ROVs when making a purchase and will provide a competitive incentive for manufacturers to improve the rollover resistance of ROVs.

The proposed rule specifies the content and format for the hang tag, and includes an example hang tag. Under the proposal, the hang tag must conform

in content, form, and sequence as specified in the proposed rule.

The Commission proposes the following ROV hangtag requirements:

- Content. Every ROV shall be offered for sale with a hangtag that graphically illustrates and textually states the lateral acceleration threshold at rollover for that ROV model. The hangtag shall be attached to the ROV and may be removed only by the first purchaser.

- Size. Every hangtag shall be at least 15.24 cm (6 inches) wide by 10.16 cm (4 inches) tall.

- Attachment. Every hangtag shall be attached to the ROV and be conspicuous to a person sitting in the driver’s seat; and the hangtag shall be removable only with deliberate effort.

- Format. The hang tag shall provide all of the elements shown in the example hangtag (see Figure 16).

b. Rationale

Section 27(e) of the CPSA authorizes the Commission to require, by rule, that manufacturers of consumer products provide to the Commission performance and technical data related to performance and safety as may be required to carry out the purposes of the CPSA, and to give notification of such performance and technical data at the time of original purchase to prospective purchasers and to the first purchaser of the product. 15 U.S.C. 2076(e). Section 2 of the CPSA provides that one purpose of the CPSA is to “assist consumers in evaluating the comparative safety of consumer products.” 15 U.S.C. 2051(b)(2).

Other federal government agencies currently require on-product labels with information to help consumers in making purchasing decisions. For example, NHTSA requires automobiles to come with comparative information on vehicles regarding rollover resistance. 49 CFR 575.105. NHTSA believes that consumer information on the rollover risk of passenger cars would influence consumers to purchase vehicles with a lower rollover risk and inspire manufacturers to produce vehicles with a lower rollover risk.⁴¹ A subsequent study of SSF trends in automobiles found that SSF values increased for all vehicles after 2001, particularly SUVs, which tended to have the worst SSF values in the earlier years.⁴²

⁴¹ Walz, M. C. (2005). Trends in the Static Stability Factor of Passenger Cars, Light Trucks, and Vans. DOT HS 809 868. Retrieved from <http://www.nhtsa.gov/cars/rules/regrev/evaluate/809868/pages/index.html>.

⁴² Walz, M.C. (2005). Trends in the Static Stability Factor of Passenger Cars, Light Trucks, and Vans.

EnergyGuide labels, required on most appliances, are another example of federally-mandated labels to assist consumers in making purchase decisions. 16 CFR part 305. Detailed operating cost and energy consumption information on these labels allows consumers to compare competing models and identify higher efficiency products. The EnergyGuide label design was developed based on extensive consumer research and following a two-year rulemaking process.

Like NHTSA rollover resistance information and EnergyGuide labels, the proposed ROV hang tags are intended to provide important information to consumers at the time of purchase. Providing the value of each ROV model vehicle's threshold lateral acceleration to consumers will assist consumers with evaluating the comparative safety of the

vehicles in terms of resistance to rollover. Requiring that ROV lateral acceleration test results be stated on a hangtag may motivate manufacturers to increase the performance of their ROV to achieve a higher reportable lateral acceleration, similar to incentives created as a result of NHTSA's NCAP program.

The proposed hangtag is based, in part, on the point-of-purchase hangtag requirements for ATVs. ATVs must have hangtags that include general warning information regarding operation and operator and passenger requirements, as well as behavior that is warned against. Most ROV manufacturers are also manufacturers of ATVs. Accordingly, ROV manufacturers are likely to be familiar with the hangtag requirements for ATVs. The ANSI/SVIA 1-2010 voluntary standard that applies to ATVs

requires ATVs to be sold with a hangtag that is to be removed only by the purchaser and requires ATV hangtags to be 6-inches tall x 4-inches wide. Because ROV manufacturers are likely to be familiar with the hangtag requirements for ATVs, the Commission is proposing the same size requirements for ROV hang tags.

The hang tag graph draws its format from well-recognized principles in effective warnings. When presenting graphical information, it is important to include labels so that the data can be understood. Graphs should have a unique title, and the axes should be fully labeled with the units of measurement. Graphs should also be distinguished from the text, by adding white space, or enclosing the graphs in a box.⁴³

Figure 16—Hang tag⁴⁴

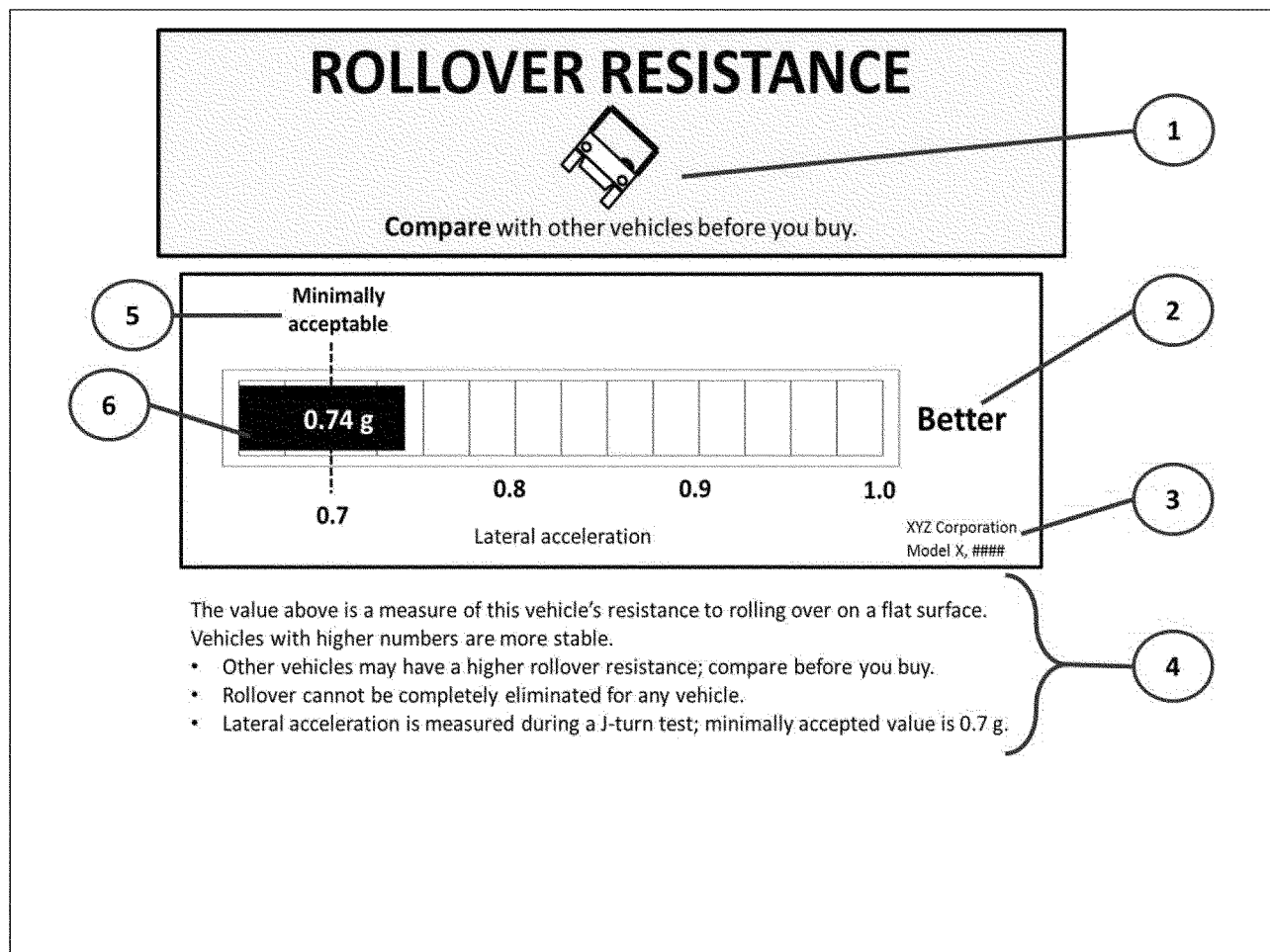

(1) The ROV icon helps identify the product. The icon is presented at a slight angle to help consumers readily identify the label as addressing ROV rollover characteristics. Research has shown that pictorial symbols and icons make warnings more noticeable and easier to detect than warnings without such symbols and icons.⁴⁵

(2) Graph label, "Better," indicates that the higher the value (as shading increases to the right), the higher the ROV's resistance to rolling over during a turn on a flat surface.

(3) The Manufacturer, Model, Model number, Model year help the consumer identify the exact ROV described by the label. Likewise, the EnergyGuide label provides information on the manufacturer, model, and size of the product so that consumers can identify exactly what appliance the label describes.⁴⁶ The Commission is proposing a similar identification of the ROV model on the hangtag so that consumers can compare values among different model ROVs.

(4) Textual information. Technical communication that includes graphs should also include text to paraphrase the importance of the graphic and explain how to interpret the information presented.⁴⁷ Additionally, including a graphic before introducing text may serve as a valuable reference for consumers, by maintaining attention and encouraging further reading.⁴⁸ The textual informational in the hangtag provides consumers with more definition of the values given in the graph.

(5) Linear scale, and anchor showing minimally acceptable value on the scale. Currently, the EnergyGuide label uses a linear scale with the lowest and highest operating costs for similar models so that consumers can compare products; the yearly operating cost for the specific model is identified on the linear scale.⁴⁹ The Commission is proposing a linear scale format for the ROV hangtag, as well. The text identifies the minimally accepted lateral acceleration at rollover as being 0.7 g. When providing this on the scale, people are able to determine

visually how a specific model compares to the minimal value.

(6) Scale starts at 0.65 g to allow a shaded bar for those ROVs meeting only the minimally acceptable lateral acceleration value.

D. Vehicle Handling—§ 1422.4

1. Description of Requirement

The proposed rule would require that all ROVs meet a vehicle handling requirement, which requires that ROVs exhibit understeer characteristics. The understeer requirement would mandate that ROVs exhibit understeer characteristics in the sublimit range of the turn circle test. The test for vehicle handling or understeer performance involves driving the vehicle around a 100-foot radius circle at increasing speeds, with the driver making every effort to maintain compliance of the vehicle path relative to the circle. SEA testing was based on a 100-foot radius circle. Data collected during these tests are analyzed to determine whether the vehicle understeers through the required range. The proposed rule would require that all ROVs exhibit understeer for values of ground plane lateral acceleration from 0.10 to 0.50 g.

2. Rationale

The CPSC believes that the constant radius test is the most appropriate method to measure an ROV's steering gradient because SAE J266, Surface Vehicle Recommended Practice, Steady-State Directional Control Test Procedures for Passenger Cars and Light Trucks, establishes the constant radius test as a method to measure understeer/oversteer in passenger cars. The test procedures are also applicable to ROVs because ROVs are similar to cars, have four steerable wheels and a suspension system, and thus, ROVs obey the same principles of motion as automobiles.

The Commission believes that the appropriate lateral acceleration range to measure steering gradient is from 0.10 g to 0.50 g because SEA test results indicate that spurious data occur at the beginning and end of a constant radius test conducted up to vehicle rollover. Data collected in the range of 0.10 g to 0.50 g of lateral acceleration provide the most accurate plots of the vehicle's steering characteristic.⁵⁰

Tests conducted by SEA show that ROVs in sub-limit oversteer transition to a condition where the lateral acceleration increases suddenly and exponentially. Based on testing and

relevant literature, the CPSC believes that this condition can lead to untripped ROV rollovers or may cause ROVs to slide into limit oversteer and experience tripped rollover. Ensuring sub-limit understeer eliminates the potential for sudden and exponential increase in lateral acceleration that can cause ROV rollovers.

The decrease in Rhino-related incidents after the repair program was initiated and the low number of vehicle rollover incidents associated with repaired Rhino vehicles are evidence that increasing the lateral stability of an ROV and correcting oversteer characteristics to understeer reduces the occurrence of ROV rollover on level terrain. In particular, the Commission believes the elimination of runaway lateral acceleration associated with oversteer contributed to a decrease in Rhino-related rollover incidents.

As mentioned previously, ROVs can be designed to understeer in sub-limit operation with minimum cost and without diminishing the utility or recreational value of this class of vehicle. Half of the vehicles CPSC tested already exhibit sub-limit understeer condition for the full range of the test, and this includes both utility and recreational model ROVs.

E. Occupant Retention System—§ 1422.5

The proposed rule includes two requirements that are intended to keep the occupant within the vehicle or the ROPs. First, each ROV would be required to have a means to restrict occupant egress and excursion in the shoulder/hip zone defined by the proposed rule. This requirement could be met by a fixed barrier structure or structure on the ROV or by a barrier or structure that can be put into place by the occupant using one hand in one operation, such as a door. Second, the proposed rule would require that the speed of an ROV be limited to a maximum of 15 mph, unless the seat belts for both the driver and any front seat passengers are fastened. The purpose of these requirements is to prevent deaths and injury incidents, especially incidents that involve full or partial ejection of the rider from the vehicle.

1. Speed Limitation

a. Requirement

The Commission proposes a performance requirement that limits the maximum speed that an ROV can attain to 15 mph or less when tested with unbuckled front seat belts during the maximum speed test. Section 5 of ANSI/

⁴⁴ Hang tag not shown to scale.

⁴⁵ Wogalter, M., Dejoy, D., and Laughery, K. (1999). Warnings and Risk Communication. Philadelphia, PA: Taylor & Francis, Inc.

⁴⁶ Guide to EnergyGuide label retrieved at <http://www.consumer.ftc.gov/articles/0072-shopping-home-appliances-use-energyguide-label>.

⁴⁷ Markel, M. 2001.

⁴⁸ Smith, T.P. (2003). Developing consumer product instructions. Washington, DC: U.S. Consumer Product Safety Commission.

⁴⁹ FTC. Retrieved from: <https://www.consumer.ftc.gov/articles/0072-shopping-home-appliances-use-energyguide-label>.

⁵⁰ Heydinger, G. (2011) Vehicle Characteristics Measurements of Recreational Off-Highway Vehicles. Retrieved from <http://www.cpsc.gov/PageFiles/96037/rov.pdf>. Page 18.

ROHVA 1–2011, “Maximum Speed,” establishes test protocols to measure maximum speed on level ground. Because ROV manufacturers are already familiar with these test procedures and the proposed test would add elements to a test procedure manufacturers already conduct to meet the voluntary standard, the CPSC believes that the maximum speed test from ANSI/ROHVA 1–2011 is the most appropriate method to measure the limited speed of an ROV.

b. Rationale

i. Importance of Seat Belts

As discussed in section V of this preamble, results of the CPSC’s exploratory testing of belted and unbelted occupants in simulated ROV rollover events indicate that seat belt use is required to retain occupants within the vehicle. This conclusion corresponds with the incident data for ROV rollovers, in which 91 percent of the fatal victims who were partially or fully ejected from the vehicle were not wearing seat belts. Of the incidents that involved occupant ejection, many occupants were injured when struck by the vehicle after ejection. The Commission believes that many of the ROV occupant ejection deaths and injuries can be eliminated if occupants wear seat belts.

Studies have shown that automobile seat belt reminders do not increase seat belt use, unless the reminders are aggressive enough to motivate users to buckle seat belts without alienating the user into bypassing or rejecting the system. Based on the Commission’s testing and literature review and the low seat belt use rates in ROV-related incidents, the Commission believes that a seat belt speed limiting system that restricts the maximum speed of the vehicle to 15 mph if any occupied front seats are not buckled, is the most effective method to increase seat belt use rates in ROVs.

ii. Likely Acceptance of Speed-Limitation Technology

The Commission believes that in-vehicle technology that limits the speed of the ROV if the front occupied seats are not buckled will be accepted by ROV users because the technology does not interfere with the operation of the ROV below the threshold speed, and users will be motivated to wear seat belts if they wish to exceed the threshold speed. This conclusion is based on automotive studies that show drivers accepted a system that reduced vehicle function (*i.e.*, requiring more effort to depress the accelerator pedal) after a threshold speed, if the driver’s

seat belt was not buckled. The system did not interfere with the operation of the vehicle below the threshold speed, and drivers were willing to buckle their seat belts to access unhindered speed capability of the vehicle.

The Commission also believes that speed-limitation technology will be accepted by ROV users because the technology is already included on the BRP Can-Am Commander and Can-Am Maverick model ROVs, and the manufacturer with the largest ROV market share, Polaris, announced that it will introduce the technology on model year 2015 Ranger and RZR ROVs.

The Commission’s literature review concludes that intrusive reminders are effective at changing user behavior, as long as the reminder is not so intrusive that users bypass the system. Limitation of vehicle speed is the intrusive reminder for ROV users to buckle their seat belt; therefore, the Commission believes that the threshold speed for a seat belt speed-limitation system should be as high as possible to gain user acceptance (and reduce bypass of the system), but low enough to allow relatively safe operation of the vehicle.

iii. Choice of 15 MPH

The Commission believes 15 mph is the appropriate speed threshold for a seat belt speed-limitation system. Based on information about ROVs and vehicles similar to ROVs, the Commission concludes that ROVs can be operated relatively safely at 15 mph. For example:

- ANSI/NGCMA Z130.1–2004, American National Standard for Golf Carts—Safety and Performance Specifications, specifies the maximum speed for golf carts at 15 mph. This standard establishes 15 mph as the maximum acceptable speed for unbelted drivers and passengers (golf carts do not have seat belts or ROPS) in vehicles that are often driven in off-road conditions.

- SAE J2258, Surface Vehicle Standard for Light Utility Vehicles, specifies a speed of 15 mph as acceptable for a vehicle, with a lateral stability of at least 25 degrees on a tilt table test, without seat belts or ROPS. This standard also establishes 15 mph as the maximum acceptable speed for unbelted drivers and passengers in vehicles that are driven in off-road conditions.

- Polaris Ranger and RZR model year 2015 ROVs will be equipped with a seat belt speed limiter that limits the vehicle speed to 15 mph if the driver’s seat belt is not buckled. The decision by the largest manufacturer of ROVs establishes 15 mph as the maximum

acceptable speed for unbelted ROV drivers.

Additionally, the principles of physics support this conclusion. The fundamental relationship between speed and lateral acceleration is:

$$A = V^2/R \text{ where } A = \text{lateral acceleration}$$

$$V = \text{velocity}$$

$$R = \text{radius of turn}$$

The minimum proposed lateral acceleration threshold at rollover for ROVs is 0.70 g, and the typical turn radius of an ROV is 16 feet.⁵¹ Therefore, without any additional effects of tire friction, the speed at which rollover would occur during a turn on level ground is 13 mph. (The CPSC recognizes that on a slope, the lateral acceleration due to gravity can cause ROV rollover at speeds below 15 mph. However, the CPSC believes that it is appropriate to use level ground as a baseline.) In reality, friction at the tires would increase the speed at which rollover occurs to above 13 mph.

iv. User Acceptance of 15 mph

Based on CPSC’s study and the experience of some ROVs that have speed limitations, the Commission believes that ROV users are likely to accept a 15 mph threshold speed limitation. The following reasons support this conclusion:

- Results of Westat’s Phase 1 focus group study of ROV users indicate that ROV users value easy ingress and egress from an ROV and generally drive around 15 mph to 30 mph during typical use of the ROV. Users had mixed reactions to a speed threshold of 10 mph and were more accepting of a speed-limitation technology if the threshold speed was 15 mph.

- There are many situations in which an ROV is used at slow speeds, such as mowing or plowing, carrying tools to jobsites, and checking property. The Commission believes that a speed-limitation threshold of 15 mph allows the most latitude for ROV users to perform utility tasks where seat belt use is often undesired.

- The Commission believes that ROV user acceptance of a seat belt speed-limitation system will be higher at 15 mph than the speed threshold of 9 mph on the Commander ROV. Although BRP continues to sell the Can-Am Commander and Can-Am Maverick ROVs with speed limitations set at around 10 mph, focus group responses indicate that many ROV users believe that 10 mph is too low a speed limit to

⁵¹ Turn radius values retrieved at: <http://www.atv.com/features/choosing-a-work-vehicle-atv-vs-utv-2120.html> and <http://www.utvunderground.com/2014-kawasaki-teryx-4-le-6346.html>.

be acceptable, and therefore, these users will bypass the system. The 15 mph threshold is 50 percent higher than a 10 mph threshold, and staff believes that the difference in the speed threshold will increase user acceptance of the system. Polaris's decision to include seat belt speed limiters with a 15 mph threshold speed in model year 2015 Ranger and RZR ROVs supports the Commission's belief that user acceptance of a speed-limitation system will be higher at 15 mph than 10 mph.

2. Shoulder Probe Test

a. Requirement

CPSC is proposing a performance requirement that ROVs pass a probe test at a defined area near the ROV occupants' shoulder. The probe test is the most appropriate method to measure the occupant protection performance in the shoulder area of the ROV because various forms of the probe test are already used in the voluntary standard for ROVs and ATVs to determine occupant protection performance.

The test applies a probe with a force of 163 lbs., to a defined area of the vehicle's ROPS near the ROV occupants' shoulder. The vertical and forward locations for the point of application of the probe are based upon anthropometric data. The probe dimensions are based on the upper arm of a 5th percentile adult female, and the dimensions of a 5th percentile adult female represent the smallest size occupant that may be driving or riding an ROV. The 163 lb. force application represents a 50th percentile adult male occupant pushing against the barrier during a rollover event. The probe is applied for 10 seconds and the vehicle structure must absorb the force without bending more than 1 inch.

b. Rationale

After exploring several methods to test occupant protection performance of ROVs during a rollover event, CPSC believes the SEA roll simulator is the most accurate simulation of a rollover because the roll simulator is able to reproduce the lateral acceleration and roll rate experienced by ROVs in rollover events. SEA conducted simulations of tripped and untripped rollovers on ROVs with belted and unbelted ATD occupants. CPSC's analysis of SEA's test results indicate that the best occupant retention performance results, where occupants remain within the protective zone of the vehicle's ROPS, occurred when a seat belt is used in conjunction with a passive shoulder barrier restraint.

F. Prohibited Stockpiling—§ 1422.6

The proposed rule contains anti-stockpiling provisions to prohibit excessive production or importation of noncomplying ROVs during the period between the final rule's publication and its effective date. Anti-stockpiling provisions typically exist to prevent the production or importation of significant numbers—significantly beyond typical rates—of noncomplying products that can be sold after the effective date of a safety standard, which could present an unreasonable risk of injury to consumers. In order to balance the protection of consumers and the burden to manufacturers and importers of compliance with the effective date of a rule, a production limit is typically set at some minimal percentage above a single year's production rate as selected by the manufacturer or importer. This allows the manufacturer or importer to select the date most conducive to compliance, even if production or importation occurs at an unusually robust pace during the selected period.

The prohibited stockpiling provision herein limits the production or importation of noncomplying products to 10% of the amount produced or imported in any 365-day period designated, at the option of each manufacturer or importer, beginning on or after October 1, 2009, and ending on or before the date of promulgation of the rule.

G. Findings—§ 1422.7

In accordance with the requirements of the CPSA, we are proposing to make the findings stated in section 9 of the CPSA. The proposed findings are discussed in section XVI of this preamble.

X. Preliminary Regulatory Analysis

The Commission is proposing to issue a rule under sections 7 and 9 of the CPSA. The CPSA requires that the Commission prepare a preliminary regulatory analysis and that the preliminary regulatory analysis be published with the text of the proposed rule. 15 U.S.C. 2058(c). The following discussion is extracted from staff's memorandum, "Draft Proposed Rule Establishing Safety Standard for Recreational Off-Road Vehicles: Preliminary Regulatory Analysis."

A. Introduction

The CPSC is issuing a proposed rule for ROVs. This rulemaking proceeding was initiated by an ANPR published in the **Federal Register** on October 28, 2009. The proposed rule includes: (1) Lateral stability and vehicle handling requirements that specify a minimum

level of rollover resistance for ROVs and requires that ROVs exhibit sublimit understeer characteristics, and (2) occupant retention requirements that would limit the maximum speed of an ROV to no more than 15 miles per hour (mph), unless the seat belts of both the driver and front passengers, if any, are fastened; and in addition, would require ROVs to have a passive means, such as a barrier or structure, to limit further the ejection of a belted occupant in the event of a rollover.

Following is a preliminary regulatory analysis of the proposed rule, including a description of the potential costs and potential benefits. Each element of the proposed rule is discussed separately. For some elements, the benefits and costs cannot be quantified in monetary terms. Where this is the case, the potential costs and benefits are described and discussed conceptually.

B. Market Information

1. Manufacturers and Market Shares

The number of manufacturers marketing ROVs in the United States has increased substantially in recent years. The first utility vehicle that exceeded 30 mph, thus putting the utility vehicle in the ROV category, was introduced in the late 1990s. No other manufacturer offered an ROV until 2003. In 2013, there were 20 manufacturers known to CPSC to be supplying ROVs to the U.S. market. One manufacturer accounted for about 60 percent of the ROVs sold in the United States in 2013. Another seven manufacturers, including one based in China, accounted for about 36 percent of the ROVs sold in the same year. None of these seven manufacturers accounted for more than 10 percent of the market. The rest of the market was divided among about 12 other manufacturers, most of which were based in China or Taiwan.⁵² Commission staff's analysis attempted to exclude vehicles that had mostly industrial or commercial applications and were not likely to be purchased by consumers. The Commission has identified more than 150 individual ROV models from among these manufacturers. However, this count includes some models that appear to be very similar to other models produced by the same manufacturer but sold through different distributors in the United States.

About 92 percent of ROVs sold in the United States are manufactured in North America. About 7 percent of the ROVs sold in the United States are

⁵² Market share is based upon Commission analysis of sales data provided by Power Products Marketing, Eden Prairie, MN (2014).

manufactured in China (by nine different manufacturers). Less than 1 percent of ROVs are produced in other countries other than the United States or China.⁵³

Seven recreational vehicle manufacturers, which together account for more than 90 percent of the ROV market, established ROHVA. The stated purpose of ROHVA is “to promote the safe and responsible use of recreational off-highway vehicles (ROVs) manufactured or distributed in North America.” ROHVA is accredited by the American National Standards Institute (ANSI) to develop voluntary standards for ROVs. ROHVA members have developed a voluntary standard (ANSI/ROHVA 1–2011) that sets some mechanical and performance requirements for ROVs. Some ROV manufacturers that emphasize the utility applications of their vehicles have worked with the Outdoor Power Equipment Institute (OPEI) to develop another ANSI voluntary standard that is applicable to ROVs (ANSI/OPEI B71.9–2012). This voluntary standard also sets mechanical and performance requirements for ROVs. The requirements of both voluntary standards are similar, but not identical.

2. Retail Prices

The average manufacturer’s suggested retail price (MSRP) of ROVs in 2013 was

⁵³This information is based upon a Commission analysis of sales data provided by Power Products Marketing, Eden Prairie, MN (2012).

approximately \$13,100, with a range of about \$3,600 to \$20,100. The average MSRP for the eight largest manufacturers (in terms of market share) was about \$13,300. The average MSRP of ROVs sold by the smaller, mostly Chinese manufacturers was about \$7,900.⁵⁴

The retail prices of ROVs tend to be somewhat higher than the retail prices of other recreational and utility vehicles. The MSRPs of ROVs are about 10 percent higher, on average, than the MSRPs of low-speed utility vehicles. A comparison of MSRPs for the major manufacturers of ATVs and ROVs indicates that ROVs are priced about 10 percent to 35 percent higher than ATVs offered by the same manufacturer.⁵⁵ Another source indicates that the price of one ROV or other utility vehicle is about two-thirds the price of two ATVs.⁵⁶ Go-karts usually retail for between \$2,500 and \$8,000.⁵⁷

⁵⁴MSRPs for ROVs were reported by Power Products Marketing, Eden Prairie, MN (2014).

⁵⁵This information is based upon a Commission analysis of data provided by Power Products Marketing, Eden Prairie, MN, (2014), and an examination of the suggested retail prices on several manufacturers’ Internet sites.

⁵⁶“2009 Utility Vehicle Review,” *Southern Sporting Journal*, October 2008, Vol. 14, Issue 5, pp. 58–70, accessed through: <http://web.ebscohost.com> on March 17, 2011.

⁵⁷Tom Behrens, “Kart Racing: Fast times out on the prairie,” *The Houston Chronicle*, November 27, 2008, p. 4. (accessed from <http://www.chron.com> on January 17, 2014).

3. Sales and Number in Use

Sales of ROVs have increased substantially since their introduction. In 1998, only one firm manufactured ROVs, and fewer than 2,000 units were sold. By 2003, when a second major manufacturer entered the market, almost 20,000 ROVs were sold. The only dip in sales occurred around 2008, which coincided with the worst period of the credit crisis and a recession that also started about the same time. In 2013, an estimated 234,000 ROVs were sold by 20 different manufacturers.⁵⁸ The chart below shows ROV sales from 1998 through 2013.

The number of ROVs available for use has also increased substantially. Because ROVs are a relatively new product, we do not have specific information on the expected useful life of ROVs. However, using the same operability rates that CPSC uses for ATVs, we estimate that there were about 570,000 ROVs available for use in 2010.⁵⁹ By the end of 2013, there were an estimated 1.2 million ROVs in use. (See Figure 17).

⁵⁸This information is based upon a Commission analysis of sales data provided by Power Products Marketing, Eden Prairie, MN.

⁵⁹CPSC Memorandum from Mark S. Levenson, Division of Hazard Analysis, to Susan Ahmed, Associate Executive Director, Directorate for Epidemiology, “2001 ATV Operability Rate Analysis,” U.S. Consumer Product Safety Commission, Bethesda Maryland (19 August 2003). “Operability rate” refers to the probability that an ATV will remain in operation each year after the initial year of production.

ROV Sales (units), 1998–2013

Figure 17

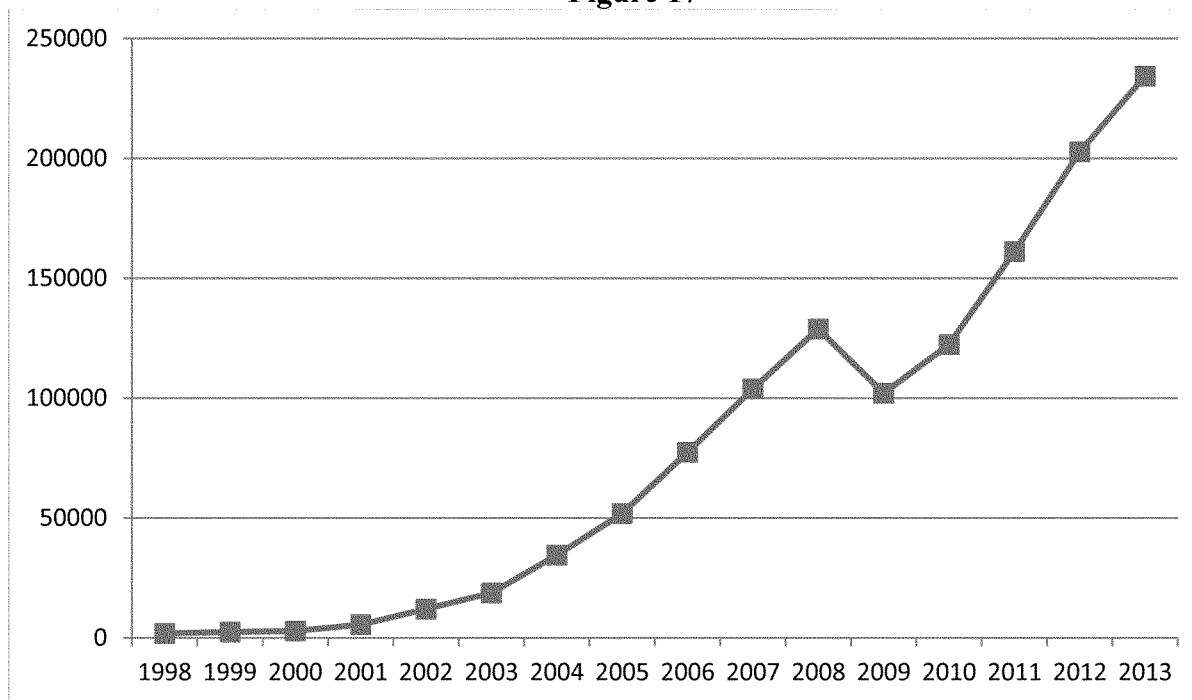

Source: CPSC analysis of data compiled by Power Products Marketing.

Most ROVs are sold through retail dealers. Generally, dealers that offer ROVs also offer other products, such as motorcycles, scooters, ATVs, and similar vehicles. ROVs are also sold through dealers that carry farm equipment or commercial turf management supplies.

While sales of ROVs have increased over the last several years, sales of competing vehicles have leveled off, or declined. Low-speed utility vehicles have been on the market since the early 1980s. Their sales increased from about 50,000 vehicles in 1998, to about 150,000 vehicles in 2007. In 2011, however, sales fell to about 110,000 vehicles. A substantial portion of these sales were for commercial applications rather than consumer applications.⁶⁰

After several years of rapid growth, U.S. sales of ATVs peaked in 2006, when more than 1.1 million ATVs were sold.⁶¹ Sales have declined substantially since then. In 2012, less than 320,000 ATVs were sold, including those intended for adults, as well as those

intended for children under the age of 16 years.⁶²

One factor that could account for part of the decline in ATV sales is that after many years of increasing sales, the market may be saturated. Consequently, a greater proportion of future sales will likely be replacement vehicles or vehicles sold due to population growth. Another factor could be the increase in sales of ROVs. Some riders find that ROVs offer a more comfortable or easier ride, and ROVs are more likely to appeal to people who prefer the bench or bucket seating on ROVs over the straddle seating of ATVs. It is also easier to carry passengers on ROVs. Most ATVs are not intended to carry passengers, and the side-by-side seating offered by ROVs appears to be preferred over the tandem seating on the few ATVs intended to carry passengers.⁶³ A disadvantage of an ROV compared to an ATV is that many ROVs are too wide to travel on some trail systems intended

for ATVs. However, some of the more narrow ROVs are capable of negotiating many ATV trails.⁶⁴

Of the several types of vehicles that could be substitutes for ROVs, go-karts appear to be the smallest market segment. After increasing sales for several years, go-kart sales peaked at about 109,000 vehicles in 2004. Sales of go-karts have since declined significantly. In 2013, fewer than 20,000 units were sold. However, many of these are aimed at young riders or intended for use on tracks or other prepared surfaces and would not be reasonable substitutes for ROVs for some purposes.⁶⁵ The decline in go-kart sales may be due to the influx of inexpensive ATVs imported from China, which may have led some consumers to purchase an ATV rather than a go-kart.⁶⁶

C. Societal Costs of Deaths and Injuries Associated With ROVs

The intent of the proposed rule is to reduce the risk of injury and death associated with incidents involving ROVs. Therefore, any benefits of the proposed rule could be measured as a

⁶⁰ This information is based upon a Commission analysis of information provided by Power Products Marketing of Eden Prairie, MN.

⁶¹ Mathew Camp, "Nontraditional Quad Sales Hit 465,000," *Dealer News*, April 28, 2008. Available at: <http://www.dealernews.com/dealernews/article/nontraditional-quad-sales-hit-465000?page=0,0>, accessed June 19, 2013.

⁶² Estimates of ATV sales are based on information provided by the Specialty Vehicle Manufacturers Association and on confidential data purchased from Power Products Marketing of Minneapolis, MN.

⁶³ "UTV Sales Flatten Out in 2008," *Dealer News*, August 2009, p. 40(4). "2009 Kawasaki Teryx 750 FI 4x4 Sport RUV Test Ride Review," article posted on: <http://www.atvriders.com>, accessed 20 August 2009 and Tom Kaiser, "Slowing sales: It's now a trend," *Powersports Business*, 12 February 2007, p. 44(1).

⁶⁴ Chris Vogtman, "Ranger shifts into recreation mode," *Powersports Business*, 12 February 2007, p. 46(2).

⁶⁵ "U.S. Go-Kart Market in Serious Decline," *Dealer News*, October, 2009, p. 38.

⁶⁶ ("Karts Feel the Chinese Crunch," *Dealer News*, November 2007, p. 44(2).

reduction in the societal costs of injuries and deaths associated with ROVs. This section discusses the societal costs of injuries and deaths.

1. ROV Injuries

a. Nonfatal Injuries

To estimate the number of nonfatal injuries associated with ROVs that were treated in hospital emergency departments, CPSC undertook a special study to identify cases that involved ROVs that were reported through the National Electronic Injury Surveillance System (NEISS) from January 1, 2010 to August 31, 2010. NEISS is a stratified national probability sample of hospital emergency departments that allows the Commission to make national estimates of product-related injuries. The sample consists of about 100 of the approximately 5,400 U.S. hospitals that have at least six beds and provide 24-hour emergency service.⁶⁷

NEISS does not contain a separate product code for ROVs. Injuries associated with ROVs are usually assigned to either an ATV product code (NEISS product codes 3286–3287) or to the utility vehicle category (NEISS product code 5044). Therefore, the Commission reviewed all NEISS cases that were coded as involving an ATV or a UTV that occurred during the first 8 months of 2010 and attempted follow-up interviews with each victim (or a relative of the victim) to gather more information about the incidents and the vehicles involved. The Commission determined whether the vehicle involved was an ROV based on the make and model of the vehicle reported in the interviews. If the make and model of the vehicle was not reported, the case was not counted as an ROV. Out of 2,018 NEISS cases involving an ATV or UTV during the study period, a total of 668 interviews were completed for a response rate of about 33 percent. Sixteen of the completed interviews were determined to involve an ROV. To estimate the number of ROV-related injuries initially treated in an emergency department in 2010, the NEISS weights were adjusted to account for both non-response and the fact that the survey only covered incidents that occurred during the first 8 months of the year. Variances were calculated based on the adjusted weights. Based on this work, the Directorate for Epidemiology estimated that there were about 3,000 injuries (95 percent confidence interval

of 1,100 to 4,900) involving ROVs in 2010 that were initially treated in hospital emergency departments.⁶⁸

NEISS injury estimates are limited to injuries initially treated in hospital emergency departments. NEISS does not provide estimates of the number of medically attended injuries that were treated in other settings, such as physicians' offices, ambulatory care centers, or injury victims who bypassed the emergency departments and were directly admitted to a hospital. However, the Injury Cost Model (ICM), developed by CPSC for estimating the societal cost of injuries, uses empirical relationships between cases initially treated in hospital emergency departments and cases initially treated in other medical settings to estimate the number of medically attended injuries that were treated outside of a hospital emergency department.⁶⁹ According to ICM estimates, based on the 16 NEISS cases that were identified in the 2010 study, injuries treated in hospital emergency departments accounted for about 27 percent of all medically treated injuries involving ROVs. Using this percentage, the estimate of 3,000 emergency department-treated injuries involving ROVs suggests that there were about 11,100 medically treated injuries involving ROVs in 2010 (*i.e.*, 3,000 injuries initially treated in emergency departments and 8,100 other medically attended injuries) or 194 medically attended injuries per 10,000 ROVs in use ($11,100 \div 570,000 \times 10,000$).⁷⁰

b. Fatal Injuries

In addition to the nonfatal injuries, there are fatal injuries involving ROVs each year. As of April 5, 2013, the Commission had identified 49 fatalities involving ROVs that occurred in 2010, or about 0.9 deaths per 10,000 ROVs in use ($(49 \div 570,000) \times 10,000$). The actual number of deaths in 2010 could be higher because reporting is ongoing for 2010. Overall, CPSC has counted 335

ROV deaths that occurred from January 1, 2003 to April 5, 2013. There were no reported deaths in 2003, when relatively few ROVs were in use. As of April 5, 2013, there had been 76 deaths reported to CPSC that occurred in 2012.⁷¹

2. Societal Cost of Injuries and Deaths Associated With ROVs

a. Societal Cost of Nonfatal Injuries

The CPSC's ICM provides comprehensive estimates of the societal costs of nonfatal injuries. The ICM is fully integrated with NEISS and provides estimates of the societal costs of injuries reported through NEISS. The major aggregated components of the ICM include: Medical costs; work losses; and the intangible costs associated with lost quality of life or pain and suffering.⁷²

Medical costs include three categories of expenditure: (1) Medical and hospital costs associated with treating the injury victim during the initial recovery period and in the long run, the costs associated with corrective surgery, the treatment of chronic injuries, and rehabilitation services; (2) ancillary costs, such as costs for prescriptions, medical equipment, and ambulance transport; and (3) costs of health insurance claims processing. Cost estimates for these expenditure categories were derived from a number of national and state databases, including the National Healthcare Cost and Utilization Project—National Inpatient Sample and the Medical Expenditure Panel Survey, both sponsored by the Agency for Healthcare Research and Quality.

Work loss estimates, based on information from the National Health Interview Survey and the U.S. Bureau of Labor Statistics, as well as a number of published wage studies, include: (1) The forgone earnings of parents and visitors, including lost wage work and household work, (2) imputed long term work losses of the victim that would be associated with permanent impairment, and (3) employer productivity losses, such as the costs incurred when employers spend time juggling schedules or training replacement workers. The earnings estimates were updated most recently with weekly earnings data from the Current

⁶⁸ Sarah Garland, Directorate for Hazard Analysis, "NEISS Injury Estimates for Recreational Off-Highway Vehicles (ROVs)," U.S. Consumer Product Safety Commission (September 2011).

⁶⁹ For a more complete discussion of the Injury Cost Model see Ted R. Miller, et al., *The Consumer Product Safety Commission's Revised Injury Cost Model*, (December 2000). Available at: <http://www.cpsc.gov/PageFiles/100269/costmodept1.PDF>. <http://www.cpsc.gov/PageFiles/100304/costmodept2.PDF>.

⁷⁰ Using the ICM estimates for all cases involving ATVs and UTVs, injuries that were initially treated in a hospital emergency department accounted for about 35 percent of all medically-attended injuries. If this estimated ratio, which is based on a larger sample, but that includes vehicles that are not ROVs, was used instead of the ratio based strictly on the 16 known ROV NEISS cases in 2010, the estimated number of medically-attended injuries would be 8,600.

⁷¹ Memorandum from Sarah Garland, Division of Hazard Analysis, "Additional ROV-related incidents reported from January 1, 2012 through April 5, 2013," U.S. Consumer Product Safety Commission, Bethesda, MD (8 April 2013).

⁷² A detailed description of the cost components, and the general methodology and data sources used to develop the CPSC's Injury Cost Model, can be found in Miller et al. (2000), available at <http://www.cpsc.gov/PageFiles/100269/costmodept1.PDF> and <http://www.cpsc.gov/PageFiles/100304/costmodept2.PDF>.

⁶⁷ Schroeder T, Ault K. *The NEISS Sample (Design and Implementation): 1999 to Present*. Bethesda, MD: U.S. Consumer Product Safety Commission; 2001. Available at: <http://www.cpsc.gov/neiss/2001d011-6b6.pdf>.

Population Survey conducted by the Bureau of the Census in conjunction with the Bureau of Labor Statistics.

Intangible, or non-economic, costs of injury reflect the physical and emotional trauma of injury as well as the mental anguish of victims and caregivers. Intangible costs are difficult to quantify because they do not represent products or resources traded in the marketplace. Nevertheless, they typically represent the largest component of injury cost and need to be accounted for in any benefit-cost analysis involving health outcomes.⁷³ The Injury Cost Model develops a monetary estimate of these intangible costs from jury awards for pain and suffering. While these awards can vary widely on a case-by-case basis, studies have shown them to be systematically related to a number of factors, including economic losses, the type and severity of injury, and the age of the victim.⁷⁴ Estimates for the Injury Cost Model were derived from a regression analysis of about 2,000 jury awards in nonfatal product liability cases involving consumer products compiled by Jury Verdicts Research, Inc.

In addition to estimating the costs of injuries treated in U.S. hospital emergency departments and reported through NEISS, the Injury Cost Model uses empirical relationships between emergency department injuries and those treated in other settings (e.g., physicians' offices, clinics, ambulatory surgery centers, and direct hospital admissions) to estimate the number, types, and costs of injuries treated outside of hospital emergency departments. Thus, the ICM allows us to expand on NEISS by combining (1) the number and costs of emergency department injuries with (2) the number and costs of medically attended injuries treated in other settings to estimate the total number of medically attended injuries and their costs across all treatment levels.

In this analysis, we use injury data from 2010, as a baseline from which to estimate the societal cost of injuries associated with ROVs. We use the year 2010 because 2010 is the year for which we have the most comprehensive estimates of both fatal and nonfatal

injuries associated with ROVs. According to ICM, the average societal cost of a medically attended injury associated with ROVs in 2010 was \$29,383 in 2012 dollars. Based on this estimate, the total societal costs of the medically attended injuries involving ROVs in 2010 was about \$326.2 million in 2012 dollars (11,100 injuries × \$29,383). About 75 percent of the cost was related to the pain and suffering. About 9 percent of the cost was related to medical treatment, and about 16 percent was related to work and productivity losses victim, caregivers, visitors, and employers. Less than 1 percent of the cost was associated with the costs of the legal and liability system.

These cost estimates are based on a small sample of only 16 NEISS cases. This sample is too small to reflect the full range of injury patterns (i.e., the different combinations of injury diagnoses, body parts, and injury dispositions) and rider characteristics (i.e., age and sex) associated with ROV injuries. In fact, because the 16 NEISS cases did not include any case in which the victim required admission to a hospital, the cost estimates are probably low. Nevertheless, this estimate will be used in this analysis with the knowledge that the estimate's use probably leads to an underestimate of the societal costs associated with ROVs and underestimates of the potential benefits of the proposed rule intended to reduce the risk of injury associated with ROVs.⁷⁵

b. Societal Cost of Fatal Injuries

As discussed above, there were at least 49 fatal injuries involving ROVs in 2010. If we assign a cost of \$8.4 million for each death, then the societal costs associated with these deaths would amount to about \$411.6 million (49 deaths × \$8.4 million). The estimate of \$8.4 million is the estimate of \$7.4 million (in 2006 dollars) developed by the U.S. Environmental Protection Agency (EPA) updated to 2012 dollars and is consistent with willingness-to-pay estimates of the value of a statistical life (VSL). According to OMB's 2013

⁷⁵ An alternative method for estimating the injury costs would be to assume that the patterns of injury associated with ROVs are similar to the injury patterns associated with all ATVs and UTVs. According to ICM estimates for all ATVs and UTVs (NEISS Product Codes 3285–3287 and 5044), injuries treated in hospital emergency departments accounted for about 35 percent of the medically attended injuries. This would suggest that the number of medically attended injuries involving an ROV was about 8,600. The average cost of a medically attended injury involving an ATV or UTV was \$42,737. Therefore, the total societal cost of medically attended injuries would be \$367.5 million.

Draft Report to Congress on the Benefits and Costs of Federal Regulations and Agency Compliance with the Unfunded Mandates Reform Act, willingness-to-pay estimates of the VSL generally vary from about \$1.3 million to \$12.2 million in 2010 dollars. In 2012 dollars, the range would be \$1.3 million to 13.0 million.⁷⁶

c. Societal Cost of Injuries per ROV in Use

Based on the previous discussion, the total estimated societal costs of deaths and injuries associated with ROVs were \$737.8 million in 2010 (expressed in 2012 dollars). The estimate does not include the costs associated with any property damage, such as property damage to the ROVs involved or other property, such as another vehicle or object that might have been involved in an incident.

Given the earlier estimate that about 570,000 ROVs were in use at the end of 2010, the estimated societal costs of deaths and medically attended injuries was about \$1,294 per ROV in use (\$737.8 million ÷ 570,000) in 2010. However, because the typical ROV is expected to be in use for 15 to 20 years, the expected societal cost of fatalities or deaths per ROV over the vehicle's useful life is the present value of the annual societal costs summed over the ROV's expected useful life. CPSC has not estimated the operability rates of ROVs as they age. However, CPSC has estimated the operability rates for ATVs as they age, based on the results of exposure surveys.⁷⁷ ROVs and ATVs are similar vehicles in that they are both off-road recreational vehicles generally produced by the same manufacturers. If ROVs have the same operability rates as they age as ATVs, the present value of the societal cost of injuries over the expected useful life of an ROV (at a 3 percent discount rate) is \$17,784.⁷⁸

⁷⁶ The estimate of the VSL developed by the EPA is explained EPA's *Guidelines for Preparing Economic Analysis*, Appendix B: Mortality Risk Valuation Estimates (Environmental Protection Agency, 2014) and is available at [http://yosemite.epa.gov/ee/epa/eeerm.nsf/vwAN/EE-0568-50.pdf/\\$file/EE-0568-50.pdf](http://yosemite.epa.gov/ee/epa/eeerm.nsf/vwAN/EE-0568-50.pdf/$file/EE-0568-50.pdf). The OMB's 2013 Draft Report to Congress is available at: http://www.whitehouse.gov/sites/default/files/omb/inforeg/2013_cb/draft_2013_cost_benefit_report.pdf. Both reports were accessed on August 6, 2014.

⁷⁷ CPSC Memorandum from Mark S. Levenson, Division of Hazard Analysis, to Susan Ahmed, Associate Executive Director, Directorate for Epidemiology, "2001 ATV Operability Rate Analysis," U.S. Consumer Product Safety Commission, Bethesda MD (19 August 2003).

⁷⁸ The choice of discount rate is consistent with research suggesting that a real rate of 3 percent is an appropriate discount rate for interventions involving public health (see Gold, Marthe R, Joanna E. Siegel, Louise B. Russell and Milton C.

⁷³ Rice, D.P. & MacKenzie, E.J. (1989). Cost of injury in the United States: A report to Congress, Institute for Health and Aging, San Francisco, CA: University of California and The Johns Hopkins University.

⁷⁴ Viscusi, W.K. (1988). Pain and suffering in product liability cases: Systematic compensation or capricious awards? *Int. Rev. Law Econ.* 8, 203–220 and Rodgers, G.B. (1993). Estimating jury compensation for pain and suffering in product liability cases involving nonfatal personal injury. *J. For. Econ.* 6(3), 251–262.

D. Requirements of the Proposed Rule: Costs and Benefits

The proposed rule would establish a mandatory safety standard for ROVs. The requirements of the proposed rule can be divided into two general categories: (1) Lateral stability and vehicle handling requirements, and (2) occupant-retention requirements. Following is a discussion of the costs and benefits that are expected to be associated with the requirements of the proposed rule. As discussed earlier, we use 2010 as the base year for this analysis because it is the only year for which we have estimates of both fatal and nonfatal injuries associated with ROVs. However, where quantified, the costs and benefits are expressed in 2012 dollars.

In general, the cost estimates were developed in consultation with the Directorate for Engineering Sciences (ES staff). Estimates are based on ES staff's interactions with manufacturers and knowledge related to ROV design and manufacturing process as well as direct experience with testing ROVs and similar products. In many cases, we relied on ES staff's expert judgment. Consequently, we note that these estimates are preliminary and welcome comments on their accuracy and the assumptions underlying their constructions. We are especially interested in data that would help us to refine our estimates to more accurately reflect the expected costs of the draft proposed rule as well as any alternative estimates that interested parties can provide.

1. Lateral Stability and Vehicle Handling Requirements

The lateral stability and vehicle handling requirements of the proposed rule would require that all ROVs meet a minimum level of rollover resistance and that ROVs exhibit sub-limit understeer characteristics. The dynamic lateral stability requirement would set a minimum value for the lateral acceleration at roll-over of 0.70 g (unit of standard gravity), as determined by a 30 mph drop-throttle J-turn test. The greater the lateral acceleration value, the greater the resistance of the ROV is to tipping or rolling over. The understeer requirement would mandate that ROVs exhibit understeer characteristics in the sublimit range of the turn circle test described in the proposed rule.

The proposed rule would also require manufacturers to place a hangtag on all new vehicles that provides the lateral acceleration at rollover value for the

model and provides information to the consumer about how to interpret this value. The intent of the hangtag is to provide the potential consumer with information about the rollover propensity of the model to aid in the comparison of ROV models before purchase. The content and format of the hangtag are described in Section IX.C.2.

The proposed rule describes the test procedures required to measure the dynamic rollover resistance and the understeering performance of the ROV, including the requirements for the test surface, the loading of test vehicles, and the instrumentation required for conducting the tests and for data-acquisition during the tests. The test for rollover resistance would use a 30 mph drop-throttle J-turn test. This test uses a programmable steering controller to turn the test vehicle traveling at 30 mph at prescribed steering angles and rates to determine the minimum steering angle at which two-wheel lift is observed. The data collected during these tests are analyzed to compute and verify the lateral acceleration at rollover for the vehicle.

The test for vehicle handling or understeer performance involves driving the vehicle around a 100-foot radius circle at increasing speeds, with the driver making every effort to maintain compliance of the vehicle path relative to the circle. Data collected during the tests are analyzed to determine whether the vehicle understeers through the required range. The proposed rule would require that all ROVs exhibit understeer for values of ground plane lateral acceleration from 0.10 to 0.50 g.

a. Cost of Lateral Stability and Vehicle Handling Requirements

All manufacturers would have to conduct the tests prescribed in the proposed rule to determine whether their models meet the requirements and to obtain the information on dynamic lateral stability that must be reported to consumers on the hangtag. If any model fails to meet one or both of the requirements, the manufacturer would have to make adjustments or modifications to the design of the model. After the model has been modified, the manufacturer would have to conduct tests on the modified models to check that the model meets the requirements.

There is substantial overlap in the conditions under which the tests for dynamic lateral stability and vehicle handling must be performed. The test surfaces are the same, and the vehicle condition, loading, and instrumentation required for both tests are virtually the

same. The one difference is that the test for dynamic lateral stability also requires that the test vehicle be equipped with a programmable steering controller. Because there is substantial overlap in the conditions under which the tests must be conducted, manufacturers likely will conduct both sets of tests on the same day. This would save manufacturers the cost of loading and instrumenting the test vehicle twice and renting a test facility for more than one day.

We estimate that the cost of conducting the dynamic lateral stability tests and the vehicle handling tests will be about \$24,000 per model.⁷⁹ This includes the cost of conducting both sets of tests, measuring the center of gravity of the test vehicle, which is required for the dynamic lateral stability test, transporting the test vehicle to and from the test site, outfitting the test vehicles with the needed equipment and instruments, and the cost of renting the test facility. This estimate also assumes that both tests are being conducted on the same day and that the manufacturer only needs to rent the test facility for one day and pay for loading and instrumenting the test vehicles once.

If the model meets the requirements of both tests, the manufacturer would have no additional costs associated with these requirements. The tests would not have to be conducted again, unless the manufacturer makes changes to the model that could affect the vehicle's performance in these tests.

If the model does not meet the requirements of one or both of the tests, the manufacturer will incur costs to adjust the vehicle's design. Engineers specializing in the design of utility and recreational vehicles are likely to have a good understanding of vehicle characteristics that influence vehicle stability and handling. Therefore, these engineers should be able to modify easily the design of a vehicle to meet the stability and handling requirements. The Yamaha Rhino repair program demonstrated that an ROV that did not meet the lateral stability and vehicle handling requirements was successfully modified to meet the requirements by increasing the track width and reducing the rear suspension stiffness (by removing the sway bar) of the ROV. Based on experience with automotive

⁷⁹This estimate is based on the rates that CPSC has most recently paid a contractor for conducting these tests. For example, see contract CPSC-D-11-0003, which provides the following costs estimates: \$3,000 for static measurement to determine center of gravity location, \$19,000 to perform dynamic test, and \$2,000 to ship vehicles. This amounts to approximately \$24,000.

manufacturing, ES staff believes that less than 1 or 2 person-months would be required to modify an ROV model that did not comply with the requirements. A high estimate would be that a manufacturer might require as many as 4 person-months (or about 700 hours) to modify. Assuming an hourly rate of \$61.75, which is the estimated total hourly compensation for management, professional, and related workers, the cost to modify the design of an ROV model to meet the stability and handling requirements, using the high estimate, would be about \$43,000.

The Commission believes that most modifications that might be required to meet the lateral stability and vehicle handling requirements will have minimal, if any, impact on the production or manufacturing costs because the assembly of an ROV already includes installation of a wheel axle and installing a longer wheel axle or wheel spacer would not change the current assembly procedure; likewise, the assembly of an ROV already includes installation of sway bars and shock absorbers and installing different variations of these suspension components would not affect the current assembly procedure.

Once an ROV model has been modified to comply with the requirements, the manufacturer will have to retest the vehicle to check that the model does comply with the requirements. Both the dynamic stability and vehicle handling tests will have to be conducted on the redesigned model, even if the original model failed only one of the tests. This is because the design changes could have impacted the ROVs ability to comply with either requirement. Therefore, the full cost of the proposed lateral stability and vehicle handling requirements could range from a low of about \$24,000 for a model that already met the requirements, up to \$91,000, for a scenario in which the model was tested, the manufacturer required 4 person-months to modify the vehicle, and the vehicle was retested to check that the modified vehicle complied with the requirements.⁸⁰

Although the plausible range for the cost of the lateral stability and vehicle handling requirement is \$24,000 to \$91,000 per model, the Commission believes that the average cost per model will be toward the low end of this range because CPSC tested 10 ROVs that

represented the recreational and utility oriented ROVs available in 2010, and found that four out of 10 ROVs met the lateral stability requirement and five out of 10 ROVs met the vehicle handling requirements. As discussed previously, for models that already meet the requirements, the manufacturer will incur no additional costs other than the cost of the testing. Based upon CPSC examination of models that do not meet the requirements, CPSC believes in most cases the manufacturers should be able to bring the model into compliance with the requirements by making simple changes to the track width, or to the suspension of the vehicle. These are relatively modest modifications that probably can be accomplished in less time than the high estimate of 4 months. However, the Commission welcomes comments on our underlying rationale for the estimates as well as the estimates themselves.

It is frequently useful to compare the benefits and costs of a rule on a per-unit basis. Based on 2011 sales data, the average unit sales price per ROV model was about 1,800.⁸¹ ROVs are a relatively new product and the average number of years a ROV model will be produced before being redesigned is uncertain. It is often observed that automobile models are redesigned every 4 to 6 years. If a ROV model is produced for about 5 years before being redesigned, then the cost of testing the model for compliance with the dynamic lateral stability and vehicle handling requirements, and, if necessary, modifying the design of the vehicle to comply with the requirements and retesting the vehicle would apply to about 9,000 units. (The Commission welcomes comments on this assumption.) Therefore, the average per-unit cost of the proposed dynamic lateral stability and vehicle handling requirements would be about \$3 per unit ($\$24,000 \div 9,000$), if the model already complies with the requirements. Using the high estimate of the time that it could take to modify a model that fails or one or both of the tests, the per-unit cost would be about \$10 per unit ($\$91,000 \div 9,000$).⁸²

⁸¹ In 2011, the average number of units sold per model was about 1,800. Depending on the particular model, the units sold ranged from less than 10 for some models, to more than 10,000 for others (based on an analysis by CPSC staff of a database obtained from Power Products Marketing of Eden Prairie, MN).

⁸² These per-unit cost estimates are an attempt to estimate the average per-unit costs across all ROV models. The actual per-unit cost for any ROV model would depend upon the sales volume for that model. If the sales were substantially more than 1,800 units annually, then the per-unit cost would be substantially lower than the estimate above. If

The proposed rule requires that the manufacturer attach a hangtag on each new ROV that provides the ROV's lateral acceleration at rollover value, which can be used by the consumer to compare the rollover resistance of different ROVs. We estimate that the cost of the hangtag, including the designing and printing of the hangtag, and attaching the hang tag to the vehicle, will be less than \$0.25 per vehicle. Our estimates are based on the following assumptions: (1) The cost of printing the hang tag and the wire for attaching the hang tag is about 8 cents per vehicle, (2) placing the hang tag on each vehicle will require about 20 seconds at an hourly rate of \$26.11⁸³ and (3) designing and laying out the hang tag for each model will require about 30 minutes at an hourly rate of \$61.75.⁸⁴ The estimate of 30 minutes for the hang tag design reflects that the proposed rule provides a sample of the required hang tag and guidance regarding the layout of the hang tag for manufacturers to follow. Also, if the manufacturer has multiple models, the same template could be used across models; the manufacturer would simply need to change the lateral acceleration number and model identification. In light of these considerations, CPSC believes that 30 minutes per model represents a reasonable estimate of the effort involved, but we welcome comments on this estimate, especially comments that will assist us in refining the estimate.

According to several ROV manufacturers, some ROV users "might prefer limit oversteer in the off-highway environment." This assertion appeared in a public comment on the ANPR for ROVs (Docket No. CPSC-2009-0087), submitted jointly on behalf of Arctic Cat, Inc., Bombardier Recreational Products, Inc., Polaris Industries, Inc., and Yamaha Motor Corporation, USA. To the extent that the requirements in the proposed rule would reduce the ability of these users to reach limit

sales were substantially less than 1,800 units annually, then the per-unit cost of the proposed requirements would be substantially higher.

⁸³ U.S. Bureau of Labor Statistics, Table 9 (Employer Costs for Employee Compensation (ECEC), total compensation for production, transportation, and material moving for all workers in private industry), June 2012. U.S. Department of Labor. Accessed on January 9, 2014. Available at: http://www.bls.gov/news.release/archives/ecec0c_09112012.pdf

⁸⁴ U.S. Bureau of Labor Statistics, Table 9 (Employer Costs for Employee Compensation (ECEC), total compensation for all management, professional, and related for all workers in private industry), June 2012. U.S. Department of Labor. Accessed on January 9, 2014. Available at: http://www.bls.gov/news.release/archives/ecec_09112012.pdf.

⁸⁰ If the ROV already met the lateral stability and vehicle handling requirements, the low estimate of \$24,000 could overstate the incremental cost of meeting the requirements if the manufacturer was already performing the tests prescribed in the proposed rule.

oversteer intentionally, the proposed rule could have some adverse impact on the utility or enjoyment that these users receive from ROVs. These impacts would probably be limited to a small number of recreational users who enjoy activities or stunts that involve power oversteering or limit oversteer.

Although the impact on consumers who prefer limit oversteer cannot be quantified, the Commission expects that the impact will be low. Any impact would be limited to those consumers who wish to engage intentionally in activities involving the loss of traction or power oversteer. The practice of power oversteer, such as the speed at which a user takes a turn, results from driver choice. The proposed rule would not prevent ROVs from reaching limit oversteer under all conditions; nor would the rule prevent consumers from engaging in these activities. At most, the proposed rule might make reaching limit oversteer in an ROV to be somewhat more difficult for users to achieve.

b. Benefits of the Lateral Stability and Vehicle Handling Requirements

The benefit of the dynamic lateral stability and vehicle handling or understeer requirements would be the reduction of injuries and deaths attributable to these requirements. The intent of the dynamic lateral stability requirement is to reduce rollover incidents that involve ROVs. A CPSC analysis of 428 ROV incidents showed that at least 68 percent involved the vehicle rolling sideways. More than half of the overturning incidents (or 35 percent of the total incidents) occurred during a turn. There were other incidents (24 percent of the total incidents) in which the vehicle rolled sideways, but it is not known whether the incident occurred during a turn.⁸⁵ The dynamic lateral stability requirement is intended to ensure that all ROVs on the market have at least a minimum level of resistance to rollover during turns, as determined by the test in the proposed rule. Additionally, by requiring through the use of hang tags that consumers be informed of the rollover resistance of ROV models, the proposed rule would make it easier for consumers to compare the rollover resistance of ROV models before making a purchase. Manufacturers might be encouraged to develop ROV models with greater resistance to rollover if consumers show a clear preference for

ROVs with the higher values for lateral acceleration threshold at rollover when they purchase new ROVs. As a similar example, in 2001, NHTSA began including rollover resistance information in its new car assessment program (NCAP).⁸⁶ NHTSA believed that consumer information on the rollover risk of passenger cars would influence consumers to purchase vehicles with a lower rollover risk and inspire manufacturers to produce vehicles with a lower rollover risk.⁸⁷ A subsequent study of static stability factor (SSF) trends in automobiles found that SSF values increased for all vehicles after 2001, particularly SUVs, which tended to have the worst SSF values in the earlier years.⁸⁷

The understeer requirement is intended to reduce the likelihood of a driver losing control of an ROV during a turn, which can lead to the vehicle rollover, striking another vehicle, or striking a fixed object. Oversteer is an undesirable trait because it is a directionally unstable steering response that leads to dynamic instability and loss of control. For this reason, automobiles are designed to exhibit understeer characteristics up to the traction limits of the tires. Sub-limit oversteer is also undesirable for off-highway vehicles due to the numerous trip hazards that exist in the off-highway environment and can cause the vehicles to roll over.

Although the Commission believes that the dynamic lateral stability and vehicle handling requirements will reduce the number of deaths and injuries involving ROVs, it is not possible to quantify this benefit because we do not have sufficient data to estimate the injury rates of models that already meet the requirements and models that do not meet the requirements. Thus, we cannot estimate the potential effectiveness of the dynamic lateral stability and vehicle handling requirements in preventing injuries. However, these requirements are intended to reduce the risk of an ROV rolling sideways when making a turn. Because the estimated societal cost of deaths and injuries associated with ROVs is \$17,784 over the useful life of an ROV, and because at least 35 percent of the injuries occurred when an ROV rolled sideways when making a turn, these requirements would address approximately \$6,224 in societal costs per ROV ($\$17,784 \times .35$). Consequently,

given that the estimated cost of the lateral stability and handling requirements is less than \$10 per ROV, the requirements would have to prevent less than about 0.2 percent of these incidents ($\$10 \div \$6,224$) for the benefits of the requirements to exceed the costs.

2. Occupant Retention Requirements

The occupant retention requirements of the proposed rule are intended to keep the occupant within the vehicle or within the rollover protective structure (ROPs). First, each ROV would be required to have a means to restrict occupant egress and excursion in the shoulder/hip zone, as defined by the proposed rule. This requirement could be met by a fixed barrier or structure on the ROV or by a barrier or structure that can be put into place by the occupant using one hand in one operation, such as a door. Second, the proposed rule would require that the speed of an ROV be limited to a maximum of 15 mph, unless the seat belts for both the driver and any front seat passengers are fastened. The purpose of these requirements is to prevent deaths and injuries, especially incidents involving full or partial ejection of the rider from the vehicle.

a. Costs of Occupant Retention Requirements

i. Means To Restrict Occupant Egress or Excursion

Most ROVs already have some occupant protection barriers or structures. In some cases, these structures might already meet the requirements of the proposed rule. In other cases, they could be modified or repositioned to meet the requirements of the proposed rule. A simple barrier that would meet the requirements of the proposed rule could be fabricated out of a length of metal tubing that is bent and bolted or welded to the ROVs or other suitable structure of the vehicle in the shoulder/hip zone of the vehicle, as defined in the proposed rule. ES staff believes that any additional metal tubing required to form such a barrier could be obtained for a cost of about \$2 per barrier. ES also believes that the additional time that would be required to bolt or weld the barrier to the vehicle would be less than 1 minute. Assuming an hourly labor cost of \$26.11, the labor time required would be less than \$0.50. ES staff also believes that it would take manufacturers only a few hours to determine how an existing ROV model would need to be modified to comply with the requirement and to make the necessary drawings to implement the change. When spread over the

⁸⁵ Sarah Garland, Ph.D., *Analysis of Reported Incidents Involving Deaths or Injuries Associated with Recreational Off-Highway Vehicles (ROVs)*, U.S. Consumer Product Safety Commission, Bethesda, MD (May 2012).

⁸⁶ 65 FR 34988 (June 1, 2000).

⁸⁷ Walz, M. C. (2005). Trends in the Static Stability Factor of Passenger Cars, Light Trucks, and Vans. DOT HS 809 868. Retrieved from <http://www.nhtsa.gov/cars/rules/regrev/evaluate/809868/pages/index.html>.

production of the model, this cost would only amount to a few cents per vehicle. Therefore, the estimated cost is expected to be less than \$3 per barrier.

Based on a cost of less than \$3 per barrier, the cost per vehicle would be less than \$6 for ROVs that do not have rear seats and \$12 for ROVs with rear seats. One exposure study found that about 20 percent of ROVs had a seating capacity of 4 or more, which indicates that these ROVs have rear seats. Therefore, if all ROV models required modification to meet the standard, the weighted average cost per ROV would be about \$7 ($\$6 \times 0.8 + \12×0.2). However, CPSC tested 10 ROVs that represented the recreational and utility oriented ROVs available in 2010, and found that four out of 10 ROVs had a passive shoulder barrier that passed a probe test specified in ANSI/ROHVA 1–2011. Therefore, this estimate of the average cost is high because there would be no additional cost for models that already meet the proposed requirement. We welcome comments on these costs and the assumptions underlying their constructions. We are especially interested in data that would help us to refine our estimates to more accurately reflect the expected costs of this proposed requirement as well as any alternative estimates that interested parties can provide.

ii. Requirement To Limit Speed If the Driver's Seat Belt Is Not Fastened

The requirement that the speed of the vehicle be limited if the driver's seat belt is unfastened does not mandate any specific technology. Therefore, manufacturers would have some flexibility in implementing this requirement. Nevertheless, based on staff's examination of and experience with speed-limiting technology, including examination of current ROV models with this feature, most systems to meet this requirement will probably include the following components:

1. A seat belt use sensor in the seat belt latch, which detects when the seat belt is fastened;
2. a means to limit the speed of the vehicle when the seat belt is not fastened;
3. a means to provide a visual signal to the driver of the vehicle when the speed of the vehicle is limited because the seat belt is not fastened;
4. wiring or other means for the sensor in the seat belt latch to send signals to the vehicle components used to limit the speed of the vehicle and provide feedback to the driver.

Before implementing any changes to their vehicles to meet the requirement, manufacturers would have to analyze

their options for meeting the requirement. This process would include developing prototypes of system designs, testing the prototypes, and refining the design of the systems based on this testing. Once the manufacturer has settled upon a system for meeting the requirement, the system will have to be incorporated into the manufacturing process of the vehicle. This will involve producing the engineering specifications and drawings of the system, parts, assemblies, and subassemblies that are required. Manufacturers will need to obtain the needed parts from their suppliers and incorporate the steps needed to install the system on the vehicles in the assembly line.

ES staff believes that it will take about nine person-months per ROV model to design, test, implement, and begin manufacturing vehicles that meet the requirements. The total compensation for management, professional, and related occupations as of 2012, is about \$61.75 per hour.⁸⁸ Therefore, if designing and implementing a system to meet the requirement entails about nine person months (or 1,560 hours), the cost to the company would be about \$100,000 per ROV model.⁸⁹

Manufacturers would be expected to perform certification tests, following the procedure described in the proposed rule, at least once for each model the manufacturer produces, to ensure that the model, as manufactured, meets the rule's requirements. Additionally, manufacturers would be expected to perform the certification testing again if they make any changes to the design or components used in a vehicle that could impact the ROV's compliance with this requirement. We estimate that the cost of this testing would be about \$4,000 per model. This estimate assumes that the testing will require three professional employees 4 hours to conduct the testing at \$61.75 per hour, per person. Additionally, the rental of the test facility will cost \$1,000; rental of the radar gun will cost \$400; and transportation to the test facility will cost \$1,400, and that the test vehicle can be sold after the testing is completed.

In addition to the cost of developing and implementing the system, manufacturers will incur costs to

⁸⁸ U.S. Bureau of Labor Statistics, Table 9 (Employer Costs for Employee Compensation (ECEC), total compensation for all management, professional, and related for all workers in private industry), June 2012. U.S. Department of Labor. Accessed on January 9, 2014. Available at: http://www.bls.gov/news.release/archives/eccec_09112012.pdf.

⁸⁹ The estimate has been rounded to the nearest \$10,000.

acquire any parts required for the system and to install the parts on the vehicles. We estimate the cost of adding a seat belt-use sensor to detect when the seat belt is fastened to be about \$7 per seat belt. This estimate is based on figures used by the National Highway Traffic Safety Administration (NHTSA) in its preliminary economic assessment of an advanced air bag rule.⁹⁰ This is a widely used technology; virtually all passenger cars have such sensors in their driver side seat belt latches to signal the seat belt reminder system in the car. The sensors and seat belt latches that would be expected to be used to meet this requirement in ROVs are virtually the same as the sensors used in passenger cars.

There is more than one method manufacturers could use to limit the maximum speed of the vehicle when the driver's seat belt is unfastened. One method would be to use a device, such as a solenoid, that limits mechanically the throttle opening. Based on observed retail prices for solenoid valves used in automotive applications, the cost to manufacturers of such a solenoid should be no more than about \$25 per vehicle. One retailer had 24 different solenoids available at retail prices ranging from about \$24 to \$102. We expect that a manufacturer would be able to obtain similar solenoids for substantially less than the retail price. Thus, using the low end of the observed retail prices suggests that manufacturers would probably be able to acquire acceptable solenoids for about \$25 each.

Manufacturers of ROVs equipped with electronic throttle control (ETC or "throttle by wire") would have at least one other option for limiting the maximum speed of the vehicle. Instead of using a mechanical means to limit the throttle opening, the engine control unit (ECU) of the vehicle, which controls the throttle, could be reprogrammed or "mapped" in a way that would limit the speed of the vehicle if the seat belt was not fastened. If the ECU can be used to limit the maximum speed of the ROV, the only cost would be the cost of reprogramming or mapping the ECU, which would be completed in the implementation stage of development, discussed previously. There would be no additional manufacturing costs involved.

There would be at least two options for providing a visual signal to the driver that the speed of the vehicle is limited because seat belts are not

⁹⁰ NHTSA estimated the cost of a seat belt use sensor to be \$2 to \$5 in 1997 dollars. The cost has been adjusted to 2012 dollars using the CPI Inflation Calculator at: http://www.bls.gov/data/inflation_calculator.htm.

fastened. One option would be to use an LCD display. Most ROV models already have an LCD display in the dashboard that could be used for this purpose. If an LCD display is present, the only cost would be the cost of the programming required for the display to show this message. This cost would be included in the estimated cost of the research and development, and there would be no additional manufacturing cost.

Another option for providing a visual signal to the driver that the speed of the vehicle is limited would be to use a lighted message or icon on the dashboard or control panel of the vehicle. Both voluntary standards already require a “lighted seat belt reminder.” To comply with this proposed requirement, the current visual reminder would have to be modified. For example, the wording or icons of the reminder would change, and the reminder would probably require a somewhat larger area on the dashboard or control panel. There could be some additional cost for an extra bulb or lamp to illuminate the larger area or icon. Based on its experience, ES staff believes that the cost of an additional bulb or lamp would be about \$1 or less per vehicle.

There will be some labor costs involved in installing the components needed to meet this requirement, including installing and connecting the wires. We expect that the components would be installed at the stage of assembly that would minimize the amount of labor required. If the amount of additional labor per vehicle was about 5 minutes, and assuming a total labor compensation rate of \$26.11 an hour,⁹¹ the labor cost is estimated to amount to approximately \$2 per vehicle.

In addition to the certification testing discussed previously, most manufacturers would be expected to conduct some quality assurance testing on vehicles as the vehicles come off the assembly line. Virtually all manufacturers already perform some quality control or quality assurance tests on their vehicles. The tests are intended to ensure, among other things, that the vehicle starts properly, that the throttle and brakes function properly, and that any lights function properly. Testing of the system limiting the maximum speed when the driver’s seat belt is not fastened would likely be incorporated

into this testing to ensure that the system is working as intended. These tests could simply involve running the vehicle once with the seat belt unfastened to determine whether speed was limited and running the vehicle again with the seat belt fastened to determine whether the maximum speed was no longer limited. If this testing added an additional 10 minutes to the amount of time it takes to test each vehicle, the cost would be about \$4 per vehicle, assuming a total hourly compensation rate of \$26.11.

The manufacturing costs that would be associated with meeting the seat belt reminder and speed limitation requirement of the proposed rule are summarized in Table 8. These costs include the cost of one seat belt-use sensor, the throttle or engine control, the visual feedback to the driver, and about 5 minutes of labor time and about 10 minutes for testing.

TABLE 8—ESTIMATED MANUFACTURING COSTS OF REQUIREMENT, PER ROV

Component	Cost
Seat Belt-Use Sensor	\$7.
Throttle or Engine Control	\$0 to \$25.
Visual Signal to Driver	\$1.
Labor	\$2.
Quality Control Testing	\$4.
Total	\$14 to \$39.

As discussed previously, we estimate the upfront research, design, and implementation costs to be about \$100,000 per model, and the certification testing costs are estimated to be about \$4,000 per model. Assuming, as before, that the average annual sales per model are 1,800 units, and assuming that the typical model is produced for 5 years, then the research, design, and certification testing costs would average about \$12 per vehicle. The average cost for models produced at lower volumes would be higher, and the average cost for models produced at higher-than-average volumes would be lower. Given the average cost of the design and development and the costs of the parts and manufacturing, we estimate that this requirement would cost between \$26 (\$14 + \$12) and \$51 (\$39 + 12) per vehicle.

Unquantifiable Costs to Users—The requirement could impose some unquantifiable costs on certain users who would prefer not to use seat belts. The cost to these users would be the time required to buckle and unbuckle their seat belts and any disutility cost, such as discomfort caused by wearing the seat belt. We cannot quantify these costs because we do not know how

many ROV users choose not to wear their seat belts. Nor do we have the ability to quantify any discomfort or disutility that ROV users would experience from wearing seat belts. However, the proposed rule does not require that the seat belts be fastened, unless the vehicle is traveling 15 mph or faster. This requirement should serve to mitigate these costs because many people who would be inconvenienced or discomforted by the requirement, such as people using the vehicle for work or utility purposes, or people who must get on and off the vehicle frequently, are likely to be traveling at lower speeds.

iii. Requirement To Limit Speed If Seat Belts for Front Passengers Are Not Fastened

The proposed rule would also require that the speed of the ROV be limited to no more than 15 mph if the seat belt of any front passenger, who is seated in a location intended by the manufacturer as a seat, is not fastened. Based on conversations with ES staff, designing a system that also limits the speed of the vehicle if the seat belt of a passenger is not fastened would require only minor adjustments to the system limiting the speed if the driver’s seat belt is not fastened. The speed-limiting system uses sensor switches (seat belt latch sensors and/or occupant presence sensors) to determine if seat belts are in use, and the speed-limiting system controls the vehicle’s speed based on whether the switch is activated or not. ES staff believes adding requirements for front passenger seat belt use will not add significant time to the research and design effort for a speed-limitation system because the system would only have to incorporate additional switches to the side of the system that determines whether vehicle speed should be limited.

However, incorporating the front passenger seats into the requirement would require additional switches or sensors. A seat belt-use sensor like the one used on the driver’s side seat belt latch, would be required for each passenger seat belt. The cost of a seat belt-use sensor was estimated to be about \$7. Additionally, there would likely be a sensor switch in each front passenger seat to detect the presence of a passenger. This switch could be similar to the seat switches in riding lawn mowers that shut off the engine if a rider is not detected. Similarly, in a ROV, if the presence of a passenger is not detected, the switch would not include the passenger seat belt sensor in circuit for determining whether the speed of the ROV should be limited. We

⁹¹ U.S. Bureau of Labor Statistics, Table 9 (Employer Costs for Employee Compensation (ECEC), total compensation for production, transportation, and material moving for all workers in private industry), June 2012. U.S. Department of Labor. Accessed on January 9, 2014. Available at: http://www.bls.gov/news.release/archives/ecec_09112012.pdf

estimate that the cost of this switch is \$13 per seat, based on the retail price of a replacement switch for the seat switch in a riding lawn mower.

There will be labor costs involved in installing the components needed to meet this requirement. The components would probably be installed at the stage of assembly that would minimize the amount of labor required and would probably not require more than about 5 minutes. Additionally, manufacturers will need to conduct tests of the system to ensure that the system functions as required. These tests could take an additional 5 minutes per vehicle. Assuming a total labor compensation rate of \$26.11 an hour,⁹² the labor cost would probably amount to about \$4 per vehicle. Therefore, the full cost of meeting this requirement would be about \$24 per passenger seat (\$7 for seat belt latch sensor + \$13 for seat switch + \$4 for labor). Therefore, the quantifiable cost of extending the seat belt/speed limitation requirement to include the front passenger seat belts would be \$24 for ROVs with only two seating positions in the front, (*i.e.*, the driver and right front passenger) and \$48 for ROVs that have three seating positions in the front. According to a survey by Heiden Associates, about 9 percent of ROVs were reported to have a seating capacity of three.⁹³ Therefore, the average cost of extending the seat belt/speed limitation requirement per ROV would be \$26 (\$24 + 0.09 x \$24).

An additional cost that is unquantifiable but should be considered nevertheless, is the impact that the failure of a component of the system could have on consumers. The more components that a system has, or the more complicated that a system is, the more likely it is that there will be a failure of a component somewhere in the system. A system that limits the speed of an ROV if a front passenger's seat belt is unbuckled would consist of more components and the system would be more complicated than a system that only limited the speed of the vehicle if the driver's seat belt is unfastened. Failure in one or more of the components would impose some costs on the consumer, and this failure could possibly affect consumer acceptance of the requirement. For example, if the

sensor in a passenger's seat belt failed to detect that the seat belt was latched, the speed of the vehicle could be limited, even though the seat belts were fastened. The consumer would incur the costs of repairing the vehicle and the loss in utility because the speed was limited until the repairs were made.

b. Benefits of the Occupant Retention Requirements

The benefit of the occupant-retention requirement is the reduction in the societal cost of fatal and nonfatal injuries that could be attributable to the requirements. In passenger cars, NHTSA assumes that a belted driver has a 45 percent reduction in the risk of death.⁹⁴ Research confirms the validity of that estimate.⁹⁵ The effectiveness of seat belts in reducing the number or severity of nonfatal injuries is less certain than in the cases resulting in deaths. Nevertheless, there is evidence that the use of seat belts is associated with a reduction in injury severity. A study by Robert Rutledge and others found statistically significant decreases in the severity of injuries in belted patients versus unbelted patients admitted to trauma center hospitals in North Carolina for variables such as the trauma scores, the Glasgow coma scale, days on a ventilator, days in an intensive care unit, days in a hospital, and hospital charges.⁹⁶ This study found, for example, that the mean stay in the hospital for belted patients was about 20 percent shorter than for unbelted patients: 10.5 days for belted patients as opposed to 13.2 days for unbelted patients. The hospital charges for belted patients were 31 percent less than the charges incurred by unbelted patients: \$10,500 versus \$15,250.⁹⁷

In this analysis, we assume that the effectiveness estimate that NHTSA uses for seat belts in automobiles is a reasonable approximation of the

effectiveness of seat belts at reducing fatalities in ROVs. However, according to Kahane (2000), the effectiveness of seat belts was significantly higher in accidents involving rollover and other incidents where the potential for ejection was high.⁹⁸ A significant portion of the fatal and nonfatal injuries associated with ROVs are associated with rollovers, which suggests that a higher effectiveness estimate could be warranted.

The work by Rutledge, et al., showed that mean hospital stays were about 20 percent less and hospital charges were 31 percent less for belted patients. This work provides some evidence that seat belts can reduce some components of the societal costs of nonfatal injuries by 20 to 31 percent. In this analysis we use the low end of this range, 20 percent, and assume that it applies to all components of the societal costs associated with nonfatal ROV injuries, including work losses and pain and suffering. The assumed 20 percent reduction in societal costs could come about because some injuries were prevented entirely or because the severity of some injuries was reduced.

These assumptions are justified because the seat belts used in ROVs are the same type of seat belts used in automobiles. Additionally, the requirement that ROVs have a passive means to restrict the egress or excursion of an occupant in the event of a rollover would ensure that there would be some passive features on ROVs that will help to retain occupants within the protective structure of the ROV just as there are in automobiles. We welcome comment on the accuracy of these estimates and underlying assumptions and will consider alternative estimates or assumptions that commenters wish to provide.

A separate estimate of the benefit of the requirement for a passive means to restrict occupant egress or excursion is not calculated. The primary benefit of this requirement is to ensure that ROVs have passive features that are more effective at retaining occupants within the protective zone of the vehicle in the event of a rollover. Therefore, the passive means to restrict occupant egress or excursion acts synergistically with the seat belt requirements to keep occupants within the protective zone of

⁹⁴ Charles J. Kahane, "Fatality Reduction by Safety Belts for Front-Seat Occupants of Cars and Light Trucks: Updated and Expanded Estimates Based on 1986–99 FARS Data," U.S. Department of Transportation, Report No. DOT HS 809 199, (December 2000).

⁹⁵ "Analysis of Reported Incidents Involving Deaths or Injuries Associated with Recreational Off-Highway Vehicles (ROVs)," U.S. Consumer Product Safety Commission, Bethesda, MD (May 2012).

⁹⁶ Robert Rutledge, Allen Lalor, Dale Oller, et al., "The Cost of Not Wearing Seat Belts: A Comparison of Outcome in 3396 Patients," *Annals of Surgery*, Vol. 217, No. 2, 122–127 (1993).

⁹⁷ Note that the Rutledge study looked only at the difference in the severity of cases involving belted, as opposed to unbelted victims. It did not estimate the number of injuries that were actually prevented. It should also be noted that the Rutledge study focused only on patients that were hospitalized for at least one day. It might not be as applicable to patients who were treated and released without being admitted to a hospital.

⁹⁸ In these incidents, the researchers found the effectiveness of seat belts was 74 percent in passenger cars and 80 percent in light trucks. Incidents involving overturning of the vehicle or the ejection of the victim are associated with a larger proportion of the fatal injuries involving ROVs. At least 65 percent of the fatalities were in incidents where the vehicle rolled sideways and at least 70 percent of those injured or killed were either fully or partially ejected.

⁹² U.S. Bureau of Labor Statistics, Table 9 (Employer Costs for Employee Compensation (ECEC), total compensation for production, transportation, and material moving for all workers in private industry), June 2012. U.S. Department of Labor. Accessed on January 9, 2014. Available at: http://www.bls.gov/news.release/archives/ecec_09112012.pdf.

⁹³ Heiden Associates et al. provided results from a 2009 ROV Survey, which is included in Appendix 2 of Docket No. CPSC—2009–0087.

the vehicle or ROPS, and in addition, provides justification for applying to the proposed rule for ROVs estimates from studies on the effectiveness of seat belts in automobiles.

i. Benefit of Limiting Speed If Driver's Seat Belt Is Not Fastened

As noted previously, the benefit of the occupant-retention requirements would be the reduction in the societal costs of fatal and nonfatal injuries that would be expected. The incremental benefit of applying the requirement to limit the speed of the vehicle if the driver's seat belt is not fastened is discussed below.

The incremental benefit of applying the same requirement to the front passengers is discussed separately.

Potential Reduction in Fatal Injuries

Table 9 shows the 231 fatality cases that CPSC has reviewed according to the seating location of the victim and whether the victim was wearing a seat belt. Ignoring the cases in which the location of the victim or the seat belt use by the victim is unknown (and thereby, erring on the side of underestimating the benefits), the data show that about 40 percent (92 ÷ 231) of the deaths happened to drivers who were not

wearing seat belts. If the pattern of deaths in 2010 is presumed to match the overall pattern of the deaths reviewed by CPSC, then about 20 of the reported 49 deaths associated with ROVs in 2010⁹⁹ would have been to drivers who did not have their seat belts fastened. (The actual pattern of deaths in any given year will likely be higher or lower than the overall or average pattern. In this analysis, we imposed the overall pattern to the reported fatalities in 2010, so that the results would be more representative of all reported ROV fatalities.)

TABLE 9—ROV FATALITIES BY VICTIM LOCATION AND SEAT BELT USE [2003 through 2011]

Location	Seat belt use			
	Yes	No	Unknown or N/A	Total
Driver	16	92	33	141
Right Front Passenger	10	33	6	49
Middle Front Passenger	0	6	0	6
Rear Passenger	0	3	1	4
Unknown Location	1	6	5	12
Cargo Area	1	8	1	10
Bystander or Other	0	3	6	9
Total	28	150	53	231

Source: CPSC Directorate for Epidemiology.

The requirement limiting the maximum speed would apply only to incidents involving unbelted drivers that occurred at speeds of greater than 15 mph. Of the ROV incidents that the Commission has reviewed, the speed of the vehicle was reported for only 89 of the 428 incidents. Therefore, estimates based on this data need to be used cautiously. Nevertheless, for victims who are known to have been injured and for which both their seat belt use and the speed of the vehicle are known, about 73 percent of the unbelted victims were traveling at speeds greater than 15 mph. (Victims who were involved in an ROV incident but were not injured, or whose injury status is not known, were not included in this analysis.) Consequently, if we assume that 73 percent of the fatalities occurred to unbelted drivers who were traveling at speeds greater than 15 mph, then about 15 (20 × 0.73) of the fatalities in 2010 would have been addressed, although not necessarily prevented, by the proposed requirement.

As discussed previously, in passenger cars, NHTSA assumes that a belted

driver has a 45 percent reduction in the risk of death. If seat belts have the same effectiveness in reducing the risk of death in ROVs, the seat belt/speed limitation requirement would have reduced the number of fatal injuries to drivers of ROVs by about 7 (15 × 0.45) in 2010, if all ROVs in use at the time had met this requirement.¹⁰⁰ This represents an annual risk reduction of 0.0000123 deaths per ROV in use (7 ÷ 570,000).

As discussed previously, in this analysis, we assume a value of \$8.4 million for each fatality averted. However, in this analysis, we assume that each fatal injury prevented by the use of seat belts still resulted in a serious, but nonfatal, injury. The average societal cost of a hospitalized injury involving all ATVs and UTVs in 2010 was about \$350,000 in 2012 dollars. (Based on the ICM estimates of the cost of a hospitalized injury using NEISS Product Codes 3285, 3286, 3287, and 5044.) Subtracting this from the assumed societal cost of \$8.4 million per death results in a societal cost reduction of \$8.05 million per death

averted. Thus, a reduction in societal costs of fatal injuries of about \$99 per ROV in use (0.0000123 × \$8.05 million) per year could be attributable to the seat belt/speed limitation requirement.

Potential Reduction in Societal Cost of Nonfatal Injuries

As discussed previously, for this analysis, we assumed that the seat belt/speed limitation requirement will reduce the societal cost of nonfatal ROV injuries by 20 percent. The assumed 20 percent reduction in societal costs could result because some injuries were prevented entirely, or because the severity of some injuries was reduced. The CPSC has investigated several hundred nonfatal injuries associated with ROVs. Table 10 summarizes the nonfatal injuries according to seating location and seat belt use. (Cases in which the occupant was not injured, or cases in which it is unknown whether the occupant was injured, were not included in this analysis.) Again, ignoring the cases in which the location of the victim or the seat belt use by the victim is unknown (and thereby, erring

⁹⁹The collection of fatalities associated with ROVs in 2010 was ongoing at the time this analysis was conducted. The actual number of deaths associated with ROVs in 2010 could be higher.

¹⁰⁰ Alternatively, the drivers could opt to leave their seat belts unfastened and accept the lower speed. Because the risk of having an accident is probably directly related to the speed of the vehicle,

this option would also be expected to reduce the number of fatal injuries.

on the side of underestimating the benefits), the data indicate that about 12 percent (46 ÷ 388) of the nonfatal injuries happened to drivers who were not wearing seat belts. This suggests that 1,332 (11,100 × 0.12) of the

approximately 11,100 medically attended injuries in 2010 would have involved unbelted drivers. Assuming, as with the fatal injuries, that 73 percent were traveling at a speed greater than 15 mph at the time of incident, 972 (1,332

× 0.73) of the injuries in 2010 could have been addressed by the proposed seat belt/speed limitation requirement. These 972 injuries in 2010 represent an injury rate of about 0.00170526 (972 ÷ 570,000) per ROV in use.

TABLE 10—NONFATAL ROV INJURIES BY VICTIM LOCATION AND SEAT BELT USE [2003 to 2011]

Location of victim	Seat belt use			
	Yes	No	Unknown or N/A	Total
Driver	23	46	51	120
Right Front Passenger	28	35	9	72
Middle Front Passenger	0	14	1	15
Rear Passenger	2	3	0	5
Unknown Location	8	21	128	157
Cargo Area	3	13	0	16
Bystander	0	0	3	3
Total	64	132	192	388

Source: CPSC Directorate for Epidemiology.

Based on estimates from the CPSC's ICM, the average societal cost of the injuries addressed is estimated to be \$29,383. Applying this cost estimate to the estimated injuries per ROV that could be addressed by the standard results in an annual societal cost of about \$50 per ROV in use (0.00170526 × \$29,383). If wearing seat belts could have reduced this cost by 20 percent (by reducing either the number or severity of injuries), the societal benefit, in terms of the reduced costs associated with nonfatal injuries, would be about \$10 per ROV in use.

Total Benefit Over the Useful Life of an ROV

The total benefit of the seat belt/speed limitation requirement per ROV would be the present value of the expected annual benefit per ROV in use, summed over the vehicle's expected useful life. Above, using 2010 as the base year, we estimated that the annual benefit per ROV was about \$99 in terms of reduced deaths and \$10 in terms of reduced nonfatal injuries, for a total of \$109 per ROV. Assuming that ROVs have the same operability rates as ATVs, the present value of the estimated benefit over the useful life of an ROV would be approximately \$1,498 per vehicle, at a 3 percent discount rate.

The cost of the requirement to limit the speed of the vehicle if the driver's seat belt is not fastened was estimated to be between \$26 and \$51 per vehicle. Additionally, the cost of the requirement for a means to restrict occupant egress and excursion via a passive method was estimated to be about \$7 per vehicle. Therefore, the total

cost would be between \$33 and \$58 per vehicle. The benefit of the requirement, estimated to be about \$1,498 per vehicle, is substantially greater than the estimated cost of the requirement.

ii. Benefit of Limiting Speed If a Front Passenger's Seat Belt Is Not Fastened

The potential incremental benefit of limiting the speed of an ROV if a front passenger's seat belt is not fastened can be calculated following the same procedure used to calculate the benefits of a requirement limiting the maximum speed when the driver's seat belt is not fastened. From the data presented in Table 9 (and ignoring the cases in which the seating location of the victim or the seat belt use is unknown), there were 33 victims seated in the right front passenger position, and six who were seated in the middle front passenger position were not using a seatbelt. However, some of the victims listed as a middle front seat passenger were not seated in places intended to be a seat. In some cases, the victim might have been seated on a console; in other cases, the victim might have been sharing the right front passenger seat and not a separate seat. Based on the information available about the incidents, we believe that only three of the six victims reported to be "middle front passengers," were actually in positions intended by the manufacturer to be middle seats. Therefore, about 16 percent (36 ÷ 231) of the fatal injuries involved front seat passengers who were not wearing seat belts.

Applying this estimate to the fatalities in 2010 suggests that about 8 of the 49 fatalities happened to front passengers

who were not wearing seat belts. Assuming that about 73 percent of the incidents involved vehicles traveling faster than 15 mph, about 6 of the fatalities would have been addressed, but not necessarily prevented, by the requirement. Assuming that seat belts reduce the risk of fatal injuries by 45 percent, about 3 fatalities might have been averted. This represents a risk reduction of 0.00000526 deaths per ROV in use (3 ÷ 570,000). Assuming a societal benefit of \$8.05 million for each death averted results in an estimated annual benefit of about \$42 per ROV in use (\$8.05 million × 0.00000526) in reduced fatal injuries.

Similarly, the data show that 35 of the victims who suffered nonfatal injuries were seated in the right front passenger location, and 14 were seated in the middle front position. However, we believe that only 8 of the 14 were actually seated in a position intended by the manufacturer to be a seat. Therefore, 43 of the 388 victims (or about 11 percent of the total) with nonfatal injuries were front passengers who were not wearing seat belts. This suggests that 1,221 of the estimated 11,100 medically attended injuries in 2010 involved unbelted front passengers. Using the assumption that 73 percent of these incidents occurred at speeds greater than 15 mph, then about 891 of the injuries might have been addressed by the requirement, or about 0.00156315 injuries per ROV in use (891 ÷ 570,000). Assuming that the average cost of a nonfatal injury involving ROVs is \$29383, the estimated societal cost of these injuries is about \$46 per ROV in use. If wearing seat belts could have

reduced the societal cost of the nonfatal injuries by 20 percent, then the benefits of the requirement would have been about \$9 per ROV in use, per year.

Combining the benefits of the reduction in the societal cost of deaths (\$42 per ROV in use) and the societal cost of injuries (\$9 per ROV in use) yields an estimated benefit of \$51 per ROV in use. Assuming that ROVs have the same operability rates as ATVs over time, and assuming a discount rate of 3 percent, the estimated benefit would be \$701 over the expected useful life of an ROV. This is greater than the expected cost of this potential requirement of \$26 per vehicle.

iii. Impact of Any Correlation in Seat Belt Use Between Driver and Passengers

The analysis above used a simplifying assumption that the use of seat belts by the passenger is independent of the use of seat belts by the driver. Therefore, we assumed that limiting the maximum speed of the ROV if the driver's seat belt was not fastened would have no impact on the seat belt use by any passenger. However, there is some evidence that the use of seat belts by passengers is correlated with the seat belt use of the

driver. In the incidents examined by the Commission, of the 121 right front passengers with known seat belt usage, the driver and right passenger had the same seat belt use status most of the time (about 82 percent). In other words, most of the time, the driver's and right passenger's seat belts were either both fastened or both unfastened. This suggests that if the drivers were required to fasten his or her seat belt, at least some of the passengers would also fasten their seat belts.

The implication that a correlation exists between seat belt use by drivers and by passengers indicates that the benefits of requiring the driver's seat belt to be fastened were underestimated and the benefits of extending the requirement to include the right front passenger are over estimated. For example, if 80 percent of the passengers who would not normally wear their seat belts were to wear their seat belts because the driver was required to wear his or her seat belt (for the ROV to exceed 15 mph), then 80 percent of the benefit, or \$561 ($\701×0.80) attributed above to extending the speed limitation requirement to the front passengers would be attributed rightfully to the

requirement that the driver's seat belt be fastened; and only 20 percent, or \$140 ($\701×0.20) would be attributable to the requirement that the front passengers' seat belts be fastened. In this example, the \$140 in benefits attributed to extending the speed limitation requirement to include the front passenger's seat belts would still exceed the quantifiable cost of doing so, which was estimated to be \$26.

E. Summary of the Costs and Benefits of the Proposed Rule

As described previously, manufacturers would incur costs of \$128,000 to \$195,000 per model to test ROV models for compliance with the requirements of the proposed rule and to research, develop, and implement any needed changes to the models so that they would comply with the requirements. These costs would be incurred before the model is brought to market. To express these costs on a per-unit basis, we assumed that, on average, 1,800 units of a model were produced annually and that a typical model is produced for 5 years. These costs are summarized in Table 11.

TABLE 11—SUMMARY OF CERTIFICATION TESTING AND RESEARCH AND DEVELOPMENT COSTS

Description	Cost per model	Cost per unit*
Lateral Stability and Vehicle Handling Requirements:		
Compliance Testing	\$24,000	\$3
Redesign of Noncomplying Models	\$43,000	\$5
Retesting of Redesigned Models	\$24,000	\$3
<i>Total Costs for Lateral Stability and Vehicle Handling</i>	<i>\$24,000 to \$91,000 ...</i>	<i>\$3 to \$10</i>
Occupant Retention Requirements:		
Research, Design, Implementation	\$100,000	\$11
Certification Testing	\$4,000	<\$1
<i>Total R&D and Testing Costs for Seat Belt Requirement</i>	<i>\$104,000</i>	<i>\$12</i>
<i>Total Certification Testing and Research and Development Costs</i>	<i>\$128,000 to \$195,000</i>	<i>\$14 to \$22</i>

* Per-unit costs are rounded to the nearest whole dollar. The sums might not equal the totals due to rounding.

In addition to the testing, research, and development costs described above, manufacturers will incur some additional manufacturing costs for extra parts or labor required to manufacture ROVs that meet the requirements for the proposed rule. These costs are summarized in Table 12. As for the vehicle handling requirements, some modifications to vehicles that do not

comply might increase manufacturing costs; other modifications could decrease manufacturing costs. Therefore, we have assumed, on average, that there will not be any additional manufacturing costs required to meet the vehicle handling requirements. However, most manufacturers will incur additional manufacturing costs to meet the

occupant-retention requirements. These costs are expected to average between \$47 and \$72 per vehicle. Adding the estimated upfront testing, research, development, and implementation costs per unit from Table 11 brings the total cost of the proposed rule to an estimated \$61 to \$94 per vehicle.

TABLE 12—SUMMARY OF PER-UNIT COSTS AND BENEFITS

Description	Value per unit
Costs	
Manufacturing Costs:	
Lateral Stability and Vehicle Handling Requirements	\$0
Passive Occupant Retention Requirement	\$7
Seat Belt/Speed Limitation Requirement—Driver Seats	\$14 to \$39
Seat Belt/Speed Limitation Requirement—Front Passenger Seats	\$26
<i>Total Manufacturing Costs</i>	<i>\$47 to \$72</i>
<i>Certification Testing and Research and Development Costs (from Table 4)</i>	<i>\$14 to \$22</i>
Total Quantifiable Cost	\$61 to \$94
Benefits	
Lateral Stability and Vehicle Handling Requirements	(not quantifiable)
Occupant Retention Requirements	\$2,199
Total Quantifiable Benefits	\$2,199
Net Quantifiable Benefits	\$2,105 to \$2,138

We were able to estimate benefits for the occupant retention requirement. Applying this requirement to just the driver's seat belt would result in benefits of about \$1,498 per unit. Applying the seat belt/speed limitation requirement to the front passenger seat belts could result in an additional benefit of \$701 per unit. Therefore, the quantifiable benefits of the proposed rule would be \$2,199 per unit. The benefit associated with the vehicle handling and lateral stability requirement could not be quantified. Therefore, the benefits of the proposed rule could exceed the \$2,199 estimated above.

The fact that the potential benefits of the lateral stability and vehicle handling requirements could not be quantified should not be interpreted to mean that they are low or insignificant. This only means that we have not developed the data necessary to quantify these benefits. The purpose of the occupant retention requirements is to reduce the severity of injuries, but this requirement is not expected to reduce the risk of an incident occurring. The lateral stability and vehicle handling requirement, on the other hand, is intended to reduce the risk of an incident occurring that involves an ROV, and therefore, prevent injuries from happening in the first place. At this time, however, we do not have a basis for estimating what would be the effectiveness of the lateral stability and vehicle handling requirements.

Notably, to the extent that the lateral stability and vehicle handling requirements are effective in reducing the number of incidents, the incremental benefit of the occupant

retention requirements also would be reduced. Additionally, if the lateral stability and vehicle handling requirements can reduce the number of accidents involving ROVs, there would be fewer resulting injuries whose severity would be reduced by the occupant retention requirements. However, the resulting decrease in the incremental benefit of the seat belt/speed limitation requirement would be less than the benefit attributable to the lateral stability and vehicle handling requirements. Again, this is largely because the benefit of preventing an injury from occurring in the first place is greater than the benefit of reducing the severity of harm of the injury.

Although some assumptions used in this analysis would serve to reduce the estimated benefit of the draft proposed rule (e.g., ignoring incidents in which the use of seat belts was unknown), the analysis also assumes that all drivers and front seat passengers would opt to fasten their seat belts if the speed of the vehicle was limited; and the analysis also would assume that no driver or passenger would attempt to defeat the system, which could be accomplished simply by passing the belt behind the rider, or passing the belt behind the seat before latching the belt. To the extent that consumers attempt to defeat the seat belt/speed limitation system, the benefits are overestimated.

The estimated costs and benefits of the rule on an annual basis can be calculated by multiplying the estimated benefits and costs per-unit by the number of ROVs sold in a given year. In 2013, 234,000 ROVs were sold. If the proposed rule had been in effect that year, the total quantifiable cost would

have been between \$14.3 million and \$22.0 million (\$61 and \$94 multiplied by 234,000 units, respectively). The total quantifiable benefits would have been at least \$515 million (\$2,199 × 234,000). Of the benefits, about \$453 million (or about 88 percent) would have resulted from the reduction in fatal injuries, and about \$62 million (or about 12 percent) of the benefits would have resulted from a reduction in the societal cost of nonfatal injuries. About \$47 million of the reduction in the societal cost of nonfatal injuries would have been due to a reduction in pain and suffering.

F. Alternatives

The Commission considered several alternatives to the requirements in the proposed rule. The alternatives considered included: (1) Not issuing a mandatory rule, but instead, relying on voluntary standards; (2) including the dynamic lateral stability requirement or the understeer requirement, but not both; (3) requiring a more intrusive audible or visual seatbelt reminder, instead of limiting the speed of the vehicle if the seatbelt is not fastened; (4) extending the seatbelt/speed limitation requirement to include rear seats; (5) requiring an ignition interlock if the seatbelts are not fastened instead of limiting the maximum speed; and (6) limiting the maximum speed to 10 mph, instead of 15 mph, if the seatbelts are not fastened. Each of these alternatives is discussed below. The discussion includes the reasons that the Commission did not include the alternative in the proposed rule as well as qualitative discussion of costs and benefits where possible.

1. No Mandatory Standard/Rely on Voluntary Standard

If CPSC did not issue a mandatory standard, most manufacturers would comply with one of the two voluntary standards that apply to ROVs. However, neither voluntary standard requires that ROVs understeer, as required by the proposed rule. According to ES staff, drivers are more likely to lose control of vehicles that oversteer, which can lead to the vehicle rolling over or causing other types of accidents.

Both voluntary standards have requirements that are intended to set standards for dynamic lateral stability. ANSI/ROHVA 1–2011 uses a turn-circle test for dynamic lateral stability that is more similar to the test in the proposed rule (for whether the vehicle understeers) than it is to the test for dynamic lateral stability. The dynamic stability requirement in ANSI/OPEI B71.9–2012 uses a J-turn test, like the proposed rule, but measures different variables during the test and uses a different acceptance criterion. However, ES staff does not believe that the tests procedures in either standard have been validated properly to be deemed capable of providing useful information about the dynamic stability of the vehicle. Moreover, the voluntary standards would find some vehicles to be acceptable, even though their lateral acceleration at rollover is less than 0.70 g, which is the acceptance criterion in the proposed rule.

Both voluntary standards require manufacturers to include a lighted seatbelt reminder that is visible to the driver and remains on for at least 8 seconds after the vehicle is started, unless the driver's seatbelt is fastened. However, virtually all ROVs on the market already include this feature; and therefore, relying only on the voluntary standards would not be expected to raise seatbelt use over current levels of use.

The voluntary standards include requirements for retaining the occupant within the protective zone of the vehicle if a rollover occurs, including two options for restraining the occupants in the shoulder/hip area. However, testing performed by CPSC identified weaknesses in the performance-based tilt table test option that allows unacceptable occupant head ejection beyond the protective zone of the vehicle ROPs. CPSC testing indicated that a passive shoulder barrier could reduce the head excursion of a belted occupant during quarter-turn rollover events. The Commission believes that this can be accomplished by a requirement for a passive barrier, based on the dimensions of the upper arm of

a 5th percentile adult female, at a defined area near the ROV occupants' shoulder, as contained in the proposed rule.

In summary, not mandating a standard would not impose any additional costs on manufacturers, but neither would it result in any additional benefits in terms of reduced deaths and injuries. Therefore, not issuing a mandatory standard was not proposed by the Commission.

2. Removing Either the Lateral Stability Requirement or the Handling Requirement

The CPSC considered including a requirement for either dynamic stability or vehicle handling, but not both. However, the Commission believes that both of these characteristics need to be addressed. According to ES staff, a vehicle that meets both the dynamic stability requirement and the understeer requirement should be safer than a vehicle that meets only one of the requirements. Moreover, the cost of meeting just one requirement is not substantially lower than the cost of meeting both requirements. The cost of testing a vehicle for compliance with both the dynamic lateral stability requirement and the vehicle handling/understeer requirement was estimated to be about \$24,000. However, the cost of testing for compliance with just the dynamic stability requirement would be about \$20,000, or only about 17 percent less than the cost of testing for compliance with both requirements. This is because the cost of renting and transporting the vehicle to the test site, instrumenting the vehicle for the tests, and making some initial static measurements are virtually the same for both requirements and would only have to be done once, if the tests for both requirements were conducted on the same day. Moreover, changes in the vehicle design that affect the lateral stability of the vehicle could also impact the handling of the vehicle. For these reasons, the proposed rule includes a dynamic stability requirement and a vehicle handling requirement.

3. Require Intrusive Seatbelt Reminder in Lieu of the Speed Limitation Requirements

Instead of seatbelt/speed limitation requirements in the proposed rule, the Commission considered a requirement for ROVs to have loud or intrusive seatbelt reminders. Currently, most ROVs meet the voluntary standards that require an 8-second visual seatbelt reminder. Some more intrusive systems have been used on passenger cars. For example, the Ford "BeltMinder" system

resumes warning the driver after about 65 seconds if his or her seatbelt is not fastened and the car is traveling at more than 3 mph. The system flashes a warning light and sounds a chime for 6 seconds every 30 seconds for up to 5 minutes so long as the car is operating and the driver's seatbelt is not fastened. Honda developed a similar system in which the warning could last for longer than 9 minutes if the driver's seatbelt is not fastened. Studies of both systems found that a statistically significant increase in the use of seatbelts of 5 percent (from 71 to 76 percent) and 6 percent (from 84 to 90 percent), respectively.¹⁰¹ However, these more intrusive seatbelt warning systems are unlikely to be as effective as the seatbelt speed limitation requirement in the proposed rule. The Commission believes that the requirement will cause most drivers and passengers who wish to exceed 15 mph to fasten their seatbelts. Research supports this position. One experiment used a haptic feedback system to increase the force the driver needed to exert to depress the gas pedal when the vehicle exceeded 25 mph if the seatbelt was not fastened. The system did not prevent the driver from exceeding 25 mph, but it increased the amount of force required to depress the gas pedal to maintain a speed greater than 25 mph. In this experiment all seven participants chose to fasten their seatbelts.¹⁰²

The more intrusive seatbelt reminder systems used on some passenger cars have been more limited in their effectiveness. The Honda system, for example, reduced the number of unbelted drivers by about 38 percent; the Ford system reduced the number of unbelted drivers by only 17 percent.¹⁰³ Additionally, ROVs are open vehicles and the ambient noise is likely higher than in the enclosed passenger compartment of a car. It is likely that some ROV drivers would not hear the warning and be motivated to fasten their seatbelts unless the warning was substantially louder than the systems used in passenger cars.

¹⁰¹ Caroleene Paul, "Proposal for Seatbelt Speed Limiter On Recreational Off-Highway Vehicles (ROVs)," CPSC Memorandum (2013).

¹⁰² Ron Van Houten, Bryan Hilton, Richard Schulman, and Ian Reagan, "Using Haptic Feedback to Increase Seatbelt Use of Service Vehicle Drivers," U.S. Department of Transportation, Report No. DOT HS 811 434 (January 2011).

¹⁰³ The Honda system increased seatbelt use from 84 percent to 90 percent. Therefore, the percentage of unbelted drivers was reduced by about 38 percent, or 6 percent divided by 16 percent. The Ford system increased seatbelt use from 71 percent to 76 percent. Therefore, the percentage of unbelted drivers was reduced by about 17 percent, or 5 percent divided by 29 percent.

The cost to manufacturers of some forms of more intrusive seat belt reminders could be less than the cost of the speed limitation requirement in the draft proposed rule. However, the cost of the seat belt/speed limitation requirement was estimated to be less than \$72 per ROV.¹⁰⁴ If the experience with the Honda and Ford systems discussed above are relevant to ROVs, the benefits of a more intrusive seat belt reminder system could be less than 38 percent of the benefits estimated for the requirement in the draft proposed rule or less than \$835 per ROV. Therefore, even if the cost of a more intrusive seat belt reminder system was close to \$0, the net benefits would be less than the seat belt/speed limitation requirement in the draft proposed rule, which were estimated to be at least \$2,105. Therefore, the alternative of a more intrusive seat belt reminder was not included in the proposed rule.

4. Extending the Seatbelt/Speed Limitation Requirement To Include Rear Seats

The Commission considered extending the seatbelt/speed limitation requirement to include the rear passenger seats, when present. According to one exposure survey, about 20 percent of the respondents reported that their ROVs had a seating capacity of at least four occupants, which indicates that the ROV had rear passenger seating locations.¹⁰⁵

The cost of extending this requirement to include the rear passenger seats would be expected to be the same per seat as extending the requirement to include the right-front and middle-front passengers, or \$24 per seat. Therefore, the cost of this requirement would be \$48 to \$72 per ROV, depending upon whether the ROV had two or three rear seating locations.

Three of the 231 fatalities (or 1.3 percent) involved a person in a rear seat who did not have their seatbelt fastened. Using the same assumptions used to calculate the benefits of the seatbelt/speed limitation for passengers in the front seats (*i.e.*, that 73 percent occurred

at speeds of 15 mph or greater and seatbelts would reduce the risk of death by 45 percent), extending the requirement to include the rear seats could have potentially reduced the number of fatalities in 2010 by 0.2 or about one death every 5 years, all other things equal. Therefore, extending the seatbelt/speed limitation requirement to the rear passenger seats could reduce the annual risk of fatal injury by 0.00000175 ($0.2 \div 114,000$) per ROV in use. Assuming a societal benefit of \$8.05 million per death averted results in an estimated annual benefit of about \$14 per ROV in use ($\$8.05 \text{ million} \times 0.00000175$) in terms of reduced fatal injuries.

Three of the 388 nonfatal injuries (or 0.8 percent) involved passengers in rear seats who did not have their seatbelts fastened. This suggests that about 89 of the estimated 11,100 medically attended injuries in 2010 may have happened to unbelted rear passengers. Again, assuming that 73 percent of these occurred at speeds of 15 mph or faster, about 65 medically attended injuries might have been addressed by the seatbelt/speed limitation requirement if applied to the rear seating locations. This represents a risk of a nonfatal, medically attended injury of 0.0005702 ($65 \div 114,000$) per ROV in use per year. The societal cost of this risk is \$17, assuming an average nonfatal, medically attended injury cost of \$29,383. If seatbelts could reduce the cost of these injuries by 20 percent, by reducing the number of injuries in their severity, the value of the reduction would be \$3 per ROV in use per year.

Combining the benefit of \$14 for the reduction in fatal injuries and \$3 for the reduced cost of nonfatal, medically attended injuries yields a combined benefit of \$17 per ROV in use per year. The present value of this estimated benefit over the expected useful life of a ROV is \$234. This is greater than the quantifiable cost of \$48 to \$72. However, these estimates of the costs and benefits are probably oversimplified the costs may have been understated and the benefits overstated. The Commission is hesitant to recommend this alternative for the several reasons.

First, as discussed earlier, a system that includes all passenger seats would comprise more parts than a system that included only the front passenger seats. A failure in only one of the parts could result in significant cost to the users for repairs, lost time and utility of the vehicle while it is being repaired, or the inability of the vehicle to reach its potential speed. These failures could occur because a faulty seat belt latch sensor does not detect or signal that a

seatbelt is latched or because a faulty seat switch incorrectly registers the presence of a passenger when a passenger is not present. This cost cannot be quantified. However, if such failures are possible, the costs of extending the seatbelt/speed limitation requirement to include the rear seats would be higher than the \$48 to \$72 estimated above.

Second, as discussed previously, there is some correlation between the seatbelt use of the driver and other passengers on the ROV. If the driver and front passengers fasten their seatbelts, there is reason to believe that some rear passengers will also fasten their seatbelts. If so, the benefits of including the rear seat passengers could be overestimated above. Moreover, even if there was no correlation, including only the driver and front seat passengers would still achieve about 98 percent of the total potential benefits from the seatbelt/speed limitation requirement.¹⁰⁶

5. Requiring an Ignition Interlock Instead of Limiting the Maximum Speed

The Commission considered whether an ignition interlock requirement that did not allow the vehicle to be started unless the driver's seatbelt was buckled would be appropriate for ROVs. However, the history of ignition interlock systems to encourage seatbelt use on passenger cars suggests that consumer resistance to an ignition interlock system could be strong. In 1973, NHTSA proposed requiring an interlock system on passenger cars. However, public opposition to the proposed requirement led Congress to prohibit NHTSA from requiring an ignition interlock system.¹⁰⁷ For this reason, the Commission is not proposing this alternative. Instead, the proposed rule would allow people to use ROVs at low speeds without requiring seat belts to be fastened.

¹⁰⁶ The potential net benefit of the seatbelt/speed limitation requirement resulting from its application to the driver and front passengers was estimated to be \$2,199 per ROV. The potential net benefit resulting from its application to the rear seats was estimated to be \$234 per ROV with rear seats. However, only about 20 percent of ROVs were assumed to have rear seats. Therefore, the weighted benefit over all ROVs of extending the seatbelt/speed limitation requirement to include the rear seats would be about \$47 per ROV ($\234×0.2). The potential weighted benefit would be \$2,246, of which about 2 percent ($\$47 \div \$2,246$) would be attributable to extending the requirement to the rear seats.

¹⁰⁷ Caroleene Paul, "Proposal for Seatbelt Speed Limiter on Recreational Off-Highway Vehicles (ROVs)," CPSC Memorandum (2013). U.S. Consumer Product Safety Commission, Bethesda MD (2013).

¹⁰⁴ This estimate is based on manufacturing cost estimates of \$39 to apply the requirement to the driver's seat and \$26 to apply the requirement to the front passenger's seat, plus \$12 for research, development and certification testing.

¹⁰⁵ Heiden Associates, Results from the 2008 ROV Exposure Survey (APPENDIX 2 to Joint Comments of Arctic Cat Inc., Bombardier Recreational Products Inc., Polaris Industries Inc., and Yamaha Motor Corporation, U.S.A regarding CPSC Advance Notice of Proposed Rulemaking-Standard for Recreational Off-Highway Vehicles: Docket No. CPSC-2009-0087), Alexandria Virginia (December 4, 2009.) This suggests that there were about 114,000 ROVs with rear passenger seats in 2010 ($0.2 \times 570,000$).

6. Limiting the Maximum Speed to 10 mph if the Driver's Seatbelt Is Not Fastened

The Commission considered limiting the maximum speed of the ROV to 10 mph if the driver's seatbelt was not fastened, instead of 15 mph, as in the proposed rule. In making this determination, we weigh some potentially quantifiable factors against some unquantifiable factors. The expected benefits of limiting the maximum speed to 10 mph are higher than the expected benefits of limiting the maximum speed to 15 mph. Based on the injuries reported to CPSC for which the speed was reported and the seatbelt use was known, about 15 percent of the people injured in ROV accidents who were not wearing seatbelts were traveling between 10 and 15 mph. Therefore, decreasing the maximum allowed speed of an ROV to 10 mph if the driver's or right front passenger's seatbelt is not fastened could increase the expected benefits of the requirement by up to 21 percent ($0.15 \div 0.73$). There would be no difference between the two alternatives in terms of the quantified costs.

Although the quantified benefits would be increased and the quantified costs would not be affected by this alternative, the Commission believes that the unquantifiable costs would be higher if the maximum speed allowed was set at 10 mph instead of 15 mph. Commission staff believes this could have a negative impact on consumer acceptance of the requirement. The unquantifiable costs include: The time, inconvenience, and discomfort to some users who would prefer not to wear seatbelts. These users could include: People using the ROVs for work or utility purposes, who might have to get on and off the ROV frequently, and who are likely to be traveling at lower rates of speed, but who occasionally could exceed 10 mph. Some of these users could be motivated to defeat the requirement (and this could be done easily), which could reduce the benefits of the proposed rule. Allowing ROVs to reach speeds of up to 15 mph without requiring the seatbelt to be fastened would mitigate some of the inconvenience or discomfort of the requirement to these users, and correspondingly, consumers would have less motivation to attempt to defeat the requirement.

ROV manufacturers would have the option of setting the maximum speed that their models could reach without requiring the seatbelts to be fastened—so long as the maximum speed was no greater than 15 miles per hour.

Therefore, manufacturers could set a maximum speed of less than 15 mph if they believed this was in their interest to do so. One ROV manufacturer has introduced ROV models that will not exceed 9.3 mph (15 km/hr.) unless the driver's seatbelt is fastened.

G. Conclusion

We estimate the quantifiable benefits of the proposed rule to be about \$2,199 per ROV, and we estimate the quantifiable costs to be about \$61 to \$94 per ROV. Therefore, the benefits would exceed the costs by a substantial margin. However, the only benefits that could be quantified would be the benefits associated with the seat belt/speed limitation requirement. The lateral stability and vehicle handling requirements would also be expected to reduce deaths and injuries and so result in additional benefits, but these were not quantifiable.

There could be some unquantifiable costs associated with the rule. Some consumers might find the requirement to fasten their seat belts before the vehicle can exceed 15 mph to be inconvenient or uncomfortable. The 15 mph threshold as opposed to a 10 mph threshold was selected for the requirement to limit the number of consumers who would be inconvenienced by the requirement and might be motivated to defeat the system. Some consumers might prefer an ROV that oversteers under more conditions than the proposed rule would allow. However, the number of consumers who have a strong preference for oversteering vehicles is probably low.

Several alternatives to requirements in the proposed rule were considered, including relying on voluntary standards or requiring more intrusive seat belt reminders (as opposed to the speed limitation requirement). However, the Commission determined that the benefits of the requirements in the proposed rule would probably exceed their costs, considering both the quantifiable and unquantifiable costs and benefits.

XI. Paperwork Reduction Act

This proposed rule contains information collection requirements that are subject to public comment and review by OMB under the Paperwork Reduction Act of 1995 (44 U.S.C. 3501–3521). In this document, pursuant to 44 U.S.C. 3507(a)(1)(D), we set forth:

- A title for the collection of information;
- a summary of the collection of information;

- a brief description of the need for the information and the proposed use of the information;

- a description of the likely respondents and proposed frequency of response to the collection of information;

- an estimate of the burden that shall result from the collection of information; and

- notice that comments may be submitted to the OMB.

Title: Safety Standard for Recreational Off-Highway Vehicles (ROVs).

Number of Respondents: We have identified 20 manufacturers of ROVs.

Number of Models: We estimate that there are about 130 different models of ROVs, or an average of 6.5 models per manufacturer. This estimate counts as a single model, all models of a manufacturer that do not appear to differ from each other in terms of performance, such as engine size, width, number of seats, weight, horsepower, capacity, and wheel size. In other words, if the models differed only in terms of accessory packages, or in the case of foreign manufacturers, differed only in the names of the domestic distributors, then they were counted as the same model.

Number of Reports per Year: Manufacturers will have to place a hang tag on each ROV sold. In 2013, about 234,000 ROVs were sold, or about 1,800 units per model. This would be a reasonable estimate of the number of responses per year. On average, each manufacturer would have about 11,700 responses per year.

Burden Estimates per Model: The reporting burden of this requirement can be divided into two parts. The first is designing the hang tag for each model. The second is printing and physically attaching the hang tag to the ROV. These are discussed in more detail below.

Designing the Hang tag: We estimate that it will take about 30 minutes to design the hang tag for each model. The first year the rule is in effect, manufacturers will have to design the hang tag for each of their models. However, the same model might be in production for more than one year. If ROV models have a production life of about 5 years before being redesigned, then the same hang tag might be useable for more than 1 year. Therefore, in year 1, on average, the burden on each manufacturer will be about 3.25 hours to design the hang tag (0.5 hours per model \times 6.5 models). In subsequent years, the burden on each manufacturer will be about 0.65 hours assuming that manufacturers will have to redesign the hang tag only when they redesign the

ROV and that ROVs are redesigned, on average, about every 5 years. Assuming this work will be performed by a professional employee, the cost per manufacturer will be \$206 the first year and \$41 in each subsequent year.¹⁰⁸

Printing and Placing the Hang tag on Each Vehicle: Based on estimates for printing obtained at <http://www.uprinting.com> and estimates for the ties obtained from <http://blanksusa.com>, we estimate that the cost of the printed hang tag and wire for attaching the hang tag to the ROV will be about \$0.08. Therefore, the total cost of materials for the average manufacturer with 6.5 models, producing 1,800 units of each model, would be about \$936 per year ($\$0.08 \times 6.5 \text{ models} \times 1,800 \text{ units}$).

We estimate that it will take about 20 seconds to attach a hang tag to each vehicle. Assuming an annual production of 1,800 units of each model, on average, this comes to 10 hours per model or an average of 65 hours per manufacturer or respondent, assuming an average of 6.5 models per manufacturer. Assuming a total compensation of \$26.12 per hour, the cost would be \$261 per model or \$1,698 per manufacturer, assuming an average of 6.5 models per manufacturer.¹⁰⁹

Total Burden of the Hang tag Requirement: The total burden of the hang tag requirement the first year will consist of the following components:

Designing the Hang tags: 65 hours (0.5 hours \times 130 models). Assuming a total compensation rate of \$63.36 per hour (professional and related workers), the cost would be \$4,118.

Placing the Hang tags on the Vehicles: 1,300 hours (234,000 vehicles \times 20 seconds). Assuming a total compensation rate of 26.12 per hour (production, transportation, and material moving workers), the total cost is \$33,956.

Total Compensation Cost: The total compensation cost for this requirement would be \$38,074 in the first year. In subsequent years, the burden of designing the hang tag is estimated to be about one-fifth the burden in the initial

year, or 13 hours, assuming that each ROV model either undergoes a significant design change or is replaced by a different model every 5 years. Therefore, the compensation cost of designing the hang tag in subsequent years would be about \$824 ($\$4,118/5$). The total compensation cost in subsequent years would be \$34,780.

Total Material Cost: The cost of the printed hang tags and ties for attaching the hang tag to the vehicles is estimated to be about 8 cents each. Therefore, the total material cost would be \$18,720 ($\$0.08 \times 234,000 \text{ units}$).

Total Cost of Hang tag Requirement: Based on the above estimates, the total cost of the hang tag requirement in the initial year is estimated to be about \$56,794. In subsequent years, the total cost would be slightly less, about \$53,500.

In compliance with the Paperwork Reduction Act of 1995 (44 U.S.C. 3507(d)), we have submitted the information collection requirements of this rule to the OMB for review. Interested persons are requested to submit comments regarding information collection by December 19, 2014, to the Office of Information and Regulatory Affairs, OMB (see the **ADDRESSES** section at the beginning of this notice).

Pursuant to 44 U.S.C. 3506(c)(2)(A), we invite comments on:

- Whether the collection of information is necessary for the proper performance of the CPSC's functions, including whether the information will have practical utility;
- the accuracy of the CPSC's estimate of the burden of the proposed collection of information, including the validity of the methodology and assumptions used;
- ways to enhance the quality, utility, and clarity of the information to be collected;
- ways to reduce the burden of the collection of information on respondents, including the use of automated collection techniques, when appropriate, and other forms of information technology; and
- the estimated burden hours associated with label modification, including any alternative estimates.

XII. Initial Regulatory Flexibility Analysis

This section provides an analysis of the impact on small businesses of a proposed rule that would establish a mandatory safety standard for ROVs. Whenever an agency is required to publish a proposed rule, section 603 of the Regulatory Flexibility Act (5 U.S.C. 601–612) requires that the agency prepare an initial regulatory flexibility analysis (IRFA) that describes the

impact that the rule would have on small businesses and other entities. An IRFA is not required if the head of an agency certifies that the proposed rule will not have a significant economic impact on a substantial number of small entities. 5 U.S.C. 605. The IRFA must contain:

(1) A description of why action by the agency is being considered;

(2) a succinct statement of the objectives of, and legal basis for, the proposed rule;

(3) a description of and, where feasible, an estimate of the number of small entities to which the proposed rule will apply;

(4) a description of the projected reporting, recordkeeping and other compliance requirements of the proposed rule, including an estimate of the classes of small entities which will be subject to the requirement and the type of professional skills necessary for preparation of the report or record; and

(5) an identification to the extent practicable, of all relevant Federal rules which may duplicate, overlap or conflict with the proposed rule.

An IRFA must also contain a description of any significant alternatives that would accomplish the stated objectives of the applicable statutes and that would minimize any significant economic impact of the proposed rule on small entities. Alternatives could include: (1) Establishment of differing compliance or reporting requirements that take into account the resources available to small businesses; (2) clarification, consolidation, or simplification of compliance and reporting requirements for small entities; (3) use of performance rather than design standards; and (4) an exemption from coverage of the rule, or any part of the rule thereof, for small entities.

A. Reason for Agency Action

ROVs were first introduced in the late 1990s. Sales of ROVs increased substantially over the next 15 years. The number of deaths associated with ROVs has substantially increased over the same period, from no reported deaths in 2003, to at least 76 reported deaths in 2012. As explained in this preamble, some ROVs on the market have hazardous characteristics that could be addressed through a mandatory safety standard.

B. Objectives of and Legal Basis for the Rule

The Commission proposes this rule to reduce the risk of death and injury associated with the use of ROVs. The rule is promulgated under the authority

¹⁰⁸ This estimate is based on the total compensation for management, professional, and related workers in private, goods producing industries, as reported by the Bureau of Labor Statistics (March 2014), available at <http://www.bls.gov/ncs/>. Please note, in the draft regulatory analysis, we are using 2010 as the base year with all values expressed in 2012 dollars. Therefore, these estimates might be slightly higher than estimated in the regulatory analysis.

¹⁰⁹ Estimate is based on the total compensation for production, transportation, and material-moving workers, private, goods-producing industries, as reported by the Bureau of Labor Statistics (March 2014), available at: <http://www.bls.gov/ncs/>.

of the Consumer Product Safety Act (CPSA).

C. Small Entities to Which the Rule Will Apply

The proposed rule would apply to all manufacturers and importers of ROVs. Under criteria set by the U.S. Small Business Administration (SBA), manufacturers of ROVs are considered small businesses if they have fewer than 500 employees. We have identified one ROV manufacturer with fewer than 500 employees.

Importers of ROVs could be wholesalers or retailers. Under the criteria set by the SBA, wholesalers of ROVs and other motor vehicles or powersport vehicles are considered small businesses if they have fewer than 100 employees; and retail dealers that import ROVs and other motor or powersport vehicle dealers are considered small if their annual sales volume is less than \$30 million. We are aware of about 20 firms in 2013 that import ROVs from foreign suppliers that would be considered small businesses.¹¹⁰ (There may be other small firms that manufacture or import ROVs of which we are not aware.)

D. Compliance, Reporting, and Record Keeping Requirements of Proposed Rule

The proposed rule would establish a mandatory safety standard consisting of several performance requirements for ROVs sold in the United States. The proposed rule would also establish test procedures through which compliance with the performance requirements would be determined. The proposed rule includes: (1) Lateral stability and vehicle handling requirements that specify a minimum level of rollover resistance for ROVs and a requirement that ROVs exhibit sub-limit understeer characteristics; and (2) occupant retention requirements that would limit the maximum speed of an ROV to no more than 15 miles per hour (mph), unless the seat belts of the driver and front passengers are fastened, and would require ROVs to have a passive means, such as a barrier or structure, to limit the ejection of a belted occupant in the event of a rollover.

Manufacturers would be required to test their ROV models to check that the models comply with the requirements of the proposed rule, and if necessary, modify their ROV models to comply. The costs of these requirements are discussed more fully in the preliminary regulatory analysis. Based on that

analysis, we expect that the test for lateral stability and the test for vehicle handling will be conducted at the same time, and we estimate that the cost of this combined testing would be about \$24,000 per model. In many cases, we expect that this testing will be performed by a third party engineering consulting or testing firm. If an ROV model must be modified to comply with the requirement and then retested, we estimate that the cost to manufacturers could reach \$91,000 per model, including the cost of the initial testing, the cost of modifying design of the model, and the cost of retesting the model after the model has been modified. We estimate that the cost of implementing the occupant retention requirements will be about \$104,000 per model. This includes the cost to research, develop, implement, and test a system that will limit the speed of the ROV when the seat belts are not fastened, as well as an occupant protection barrier or structure. Therefore, the total cost of certification testing and research and design could range from about \$128,000 to \$195,000. (Costs are expressed in 2012 dollars.)

In addition to the upfront testing and research and development costs, there will be some ongoing manufacturing costs associated with the proposed rule. These manufacturing costs include the cost of the parts required to meet any of the requirements of the proposed rule, such as seat belt use sensors and the necessary wiring and the cost of installing these parts on the vehicles during assembly. As estimated in the preliminary regulatory analysis, the ongoing manufacturing costs would be \$47 to \$72 per vehicle.

The proposed rule includes a requirement that manufacturers report the lateral acceleration at rollover value of an ROV model to potential consumers through the use of a hang tag attached to the ROV. Manufacturers would obtain the rollover resistance value when they conduct the lateral stability and vehicle handling tests to determine compliance with both requirements. The required format of the hangtag is described in the proposed rule. We estimate that it will cost manufacturers less than \$0.25 per vehicle to print the hangtags with the rollover resistance values and to attach the hangtags to the vehicles.

E. Federal Rules That May Duplicate, Overlap, or Conflict With the Proposed Rule

In accordance with Section 14 of the Consumer Product Safety Act (CPSA), manufacturers would have to issue a general conformity certificate (GCC) for each ROV model, certifying that the

model complies with the proposed rule. According to Section 14 of CPSA, GCCs must be based on a test of each product or a reasonable testing program; and GCCs must be provided to all distributors or retailers of the product. The manufacturer would have to comply with 16 CFR part 1110 concerning the content of the GCC, retention of the associated records, and any other applicable requirement.

F. Potential Impact on Small Entities

One purpose of the regulatory flexibility analysis is to evaluate the impact of a regulatory action and determine whether the impact is economically significant. Although the SBA allows considerable flexibility in determining "economically significant," CPSC staff typically uses one percent of gross revenue as the threshold for determining "economic significance." When we cannot demonstrate that the impact is lower than one percent of gross revenue, we prepare a regulatory flexibility analysis.¹¹¹

1. Impact on Small Manufacturers

The sole, small ROV manufacturer may need to devote some resources to bringing its ROV models into compliance with the proposed rule. This is a relatively new manufacturer of ROVs and other utility vehicles. We do not have information on the extent to which the models offered by this manufacturer would meet the requirements of the proposed rule or the extent to which this particular manufacturer would be impacted by the proposed rule.

2. Impact on Small Importers

CPSC is aware of about 20 firms that import ROVs from foreign suppliers that would be considered small businesses. As explained more fully below, a small importer could be adversely impacted by the proposed rule if its foreign supplier does not provide testing reports or a GCC and the small importer must conduct the testing in support of a GCC. Additionally, a small importer could experience a significant impact if the foreign supplier withdraws from the U.S. market rather than conduct the necessary testing or modify the ROVs to comply with the proposed rule. If sales

¹¹⁰ The Commission made these determinations using information from Dun & Bradstreet, Reference USA.gov, company Web sites, and regional business publications.

¹¹¹ The one percent of gross revenue threshold is cited as example criteria by the SBA and is commonly used by agencies in determining economic significance (see U.S. Small Business Administration, Office of Advocacy, *A Guide for Government Agencies: How to Comply with the Regulatory Flexibility Act and Implementing the President's Small Business Agenda and Executive Order 13272*, May 2012, pp. 18–20. http://www.sba.gov/sites/default/files/rfaguide_0512_0.pdf).

of ROVs are a substantial source of the importer's business, and the importer cannot find an alternative supplier of ROVs, the impact could be significant. However, we do not expect a widespread exodus of foreign manufacturers from the U.S. market. The U.S. market for ROVs has been growing rapidly in recent years, and at least some foreign manufacturers will likely want to continue taking advantage of these business opportunities by maintaining a U.S. presence. In addition, most of these importers also import products other than ROVs, such as scooters, motorcycles, and other powersport equipment. Therefore, ROVs are not their sole source of revenue. Importers may be able to reduce any impact on their revenue by increasing imports and sales of these other products.

Small importers will be responsible for issuing a GCC certifying that their ROVs comply with the proposed rule if the rule becomes final. However, importers may issue GCCs based upon certifications provided by or testing performed by their suppliers. The impact on small importers should not be significant if their suppliers provide the certificates of conformity or testing reports on which the importers may rely to issue their own GCCs.

If a small importer's supplier does not provide the GCC or testing reports, then the importer would have to test each model for conformity. Importers would likely contract with an engineering consulting or testing firm to conduct the certification tests. As discussed in the regulatory analysis, the certification testing could cost more than \$28,000 per model (\$24,000 for the lateral stability and vehicle handling requirements and \$4,000 for the seat belt/speed limitation requirement). This would exceed 1 percent of the revenue for about one-half of the small importers, assuming that they continue to import the same mix of products as in the pre-regulatory environment.

G. Conclusion

We do not know how many, if any, foreign suppliers might exit the market rather than comply with the proposed rule. Nor do we know the number of foreign suppliers that may not be willing to provide small importers with testing reports or GCCs. A small importer could experience a significant impact if the importer has to conduct testing in support of a GCC. We expect that most importers, however, will rely upon certifications or testing performed by their suppliers. Thus, although uncertainty exists, the proposed rule will not likely have a significant direct

impact on a substantial number of small firms.

H. Alternatives for Reducing the Adverse Impact on Small Businesses

The Commission welcomes comments on this IRFA. Small businesses that believe they will be affected by the proposed rule are especially encouraged to submit comments. The comments should be specific and describe the potential impact, magnitude, and alternatives that could reduce the impact of the proposed rule on small businesses.

Several alternatives to the proposed rule were considered, some of which could reduce the potential impact on some small firms. These include: (1) Not issuing a mandatory standard; (2) dropping the lateral stability requirement or the vehicle handling requirement; (3) requiring a more intrusive seat belt reminder instead of the speed limitation requirement; and (4) requiring an ignition interlock if a seat belt is not fastened, instead of limiting the maximum speed. For the reasons discussed below, the CPSC did not include these alternatives in the proposed rule.

1. Not Issuing a Mandatory Standard

If CPSC did not issue a mandatory standard, most manufacturers would comply with one of the two voluntary standards that apply to ROVs and there would be no impact on the small manufacturer or small importers. However, neither voluntary standard requires that ROVs understeer, as required by the proposed rule. According to ES staff, drivers are more likely to lose control of vehicles that oversteer, which can lead to the vehicle rolling over or to other types of accidents. Additionally, although both voluntary standards have requirements for dynamic lateral stability or rollover resistance, ES staff does not believe that the test procedures in these standards have been properly validated as being capable of providing useful information about the dynamic stability of the vehicle.

The voluntary standards require that manufacturers include a lighted seat-belt reminder that is visible to the driver and remains on for at least 8 seconds after the vehicle is started, unless the driver's seat belt is fastened. However, virtually all ROVs on the market already include this feature; and therefore, relying only on the voluntary standards would not be expected to raise seat belt use over its current level. Moreover, the preliminary regulatory analysis showed that the projected benefits of the seat belt/speed limitation requirement

would be substantially greater than the costs.

Finally, the Commission believes that the occupant retention barrier in the current ROVs could be improved at a modest cost per ROV. For these reasons, the Commission believes that relying on compliance with voluntary standards is not satisfactory and is adopting the requirements in the proposed rule.

2. Dropping the Lateral Stability Requirement or the Understeer Requirement

The Commission considered including a performance requirement for either lateral stability or vehicle handling, but not both. As mentioned previously, the vehicle handling requirement is designed to allow ROVs to understeer. However, the Commission believes that both of these characteristics need to be addressed. According to ES staff, a vehicle that meets both the lateral stability requirement and the understeer requirement should be safer than a vehicle that meets only one of the requirements. Moreover, the cost of meeting just one requirement is not substantially lower than the cost of meeting both requirements. The cost of testing a vehicle for compliance with both the dynamic lateral stability and vehicle handling requirements was estimated to be about \$24,000. The cost of testing for compliance with the lateral stability requirement would be about \$20,000, and the cost of testing for compliance with just the vehicle handling requirement would be about \$17,000. Moreover, changes in the vehicle design that affect the lateral stability of the vehicle could also impact the handling of the vehicle. For these reasons, the proposed rule includes both the lateral stability and understeer requirements in the proposed rule.

3. Require ROVs To Have Loud or Intrusive Seat Belt Reminders in Lieu of the Speed Limitation Requirements

Instead of seat belt/speed limitation requirements in the proposed rule, the Commission considered requiring ROVs to have loud or intrusive seat belt reminders. Most ROVs currently have a seat belt reminder in the form of a warning light that comes on for about 8 seconds. Most do not include any audible warning. As discussed in the preliminary regulatory analysis, staff considered requiring a more intrusive seat belt reminder, such as a loud audible warning that would sound for a minute or more. Manufacturers would incur some costs to comply with a requirement for a more intrusive seat belt reminder. For example, the seat belt

use sensors (estimated to cost about \$7 per seat) and sensor switches (estimated to cost about \$13 per seat) would still be required. However, the research and development costs to design and implement a more intrusive seat belt reminder system would probably be less than the estimated cost to develop a system that limited the maximum speed of the vehicle.

Some intrusive systems have been used on passenger cars and have been found to be effective in increasing seat belt use. One system reduced the number of unbelted drivers by 17 percent and another by about 38 percent.¹¹² However, a more intrusive seat belt warning system is unlikely to be as effective as the seat belt/speed limitation requirement in the proposed rule. ROVs are open vehicles and the ambient noise is likely higher than in the enclosed passenger compartment of a car. It is likely that some ROV drivers would not hear the warning and be motivated to fasten their seat belts, unless the warning was substantially louder than the systems used in passenger cars. The Commission believes that the requirement will cause most drivers and passengers who want to exceed 15 mph to fasten their seat belts. Moreover, the analysis in the preliminary regulatory analysis showed that the societal benefits of the seat belt/speed limitation requirement in the proposed rule would exceed the costs by a substantial margin. Because CPSC does not believe that a more intrusive seat belt reminder would be effective in a ROV, and because Commission staff believes that the seat belt/speed limitation requirement would result in substantial net benefits, this alternative was not included in the proposed rule.

4. Requiring an Ignition Interlock Instead of Limiting the Maximum Speed

CPSC considered whether an ignition interlock requirement that did not allow the vehicle to be started unless the driver's seat belt was buckled would be appropriate for ROVs. However, the history of ignition interlock systems as a way to encourage seat belt use on passenger cars suggests that consumer resistance to an ignition interlock system that prevents starting the vehicle could be strong. For this reason, CPSC rejects this alternative, and instead, proposes a rule that allows people to use ROVs at low speeds without having to fasten their seat belts. However, manufacturers who believe that the cost

of an ignition interlock system will be substantially lower than a system that limits the maximum speed of the vehicle, and who do not believe that consumer rejection of an ignition interlock system will be a problem, can use an ignition interlock system to comply with the seat belt speed limitation requirement.

XIII. Environmental Considerations

The Commission's regulations address whether we are required to prepare an environmental assessment or an environmental impact statement. If our rule has "little or no potential for affecting the human environment," the rule will be categorically exempted from this requirement. 16 CFR 1021.5(c)(1). The proposed rule falls within the categorical exemption.

XIV. Executive Order 12988 (Preemption)

As required by Executive Order 12988 (February 5, 1996), the CPSC states the preemptive effect of the proposed rule, as follows:

The regulation for ROVs is proposed under authority of the CPSA. 15 U.S.C. 2051–2089). Section 26 of the CPSA provides that "whenever a consumer product safety standard under this Act is in effect and applies to a risk of injury associated with a consumer product, no State or political subdivision of a State shall have any authority either to establish or to continue in effect any provision of a safety standard or regulation which prescribes any requirements as the performance, composition, contents, design, finish, construction, packaging or labeling of such product which are designed to deal with the same risk of injury associated with such consumer product, unless such requirements are identical to the requirements of the Federal Standard". 15 U.S.C. 2075(a). Upon application to the Commission, a state or local standard may be excepted from this preemptive effect if the state or local standard: (1) Provides a higher degree of protection from the risk of injury or illness than the CPSA standard, and (2) does not unduly burden interstate commerce. In addition, the federal government, or a state or local government, may establish and continue in effect a non-identical requirement that provides a higher degree of protection than the CPSA requirement for the hazardous substance for the federal, state or local government's use. 15 U.S.C. 2075(b).

Thus, with the exceptions noted above, the ROV requirements proposed in today's **Federal Register** would preempt non-identical state or local

requirements for ROVs designed to protect against the same risk of injury if the rule is issued in final.

XV. Certification

Section 14(a) of the CPSA imposes the requirement that products subject to a consumer product safety rule under the CPSA, or to a similar rule, ban, standard or regulation under any other act enforced by the Commission, must be certified as complying with all applicable CPSC-enforced requirements. 15 U.S.C. 2063(a). A final rule on ROVs would subject ROVs to this certification requirement.

XVI. Effective Date

The CPSA requires that consumer product safety rules take effect not later than 180 days from their promulgation unless the Commission finds there is good cause for a later date. 15 U.S.C. 2058(g)(1). The Commission proposes that this rule would take effect 180 days after publication of the final rule in the **Federal Register** and would have two compliance dates. ROVs would be required to comply with the lateral stability and vehicle handling requirements (§§ 1411.3 and 1422.4) 180 days after publication of a final rule in the **Federal Register**. ROVs would be required to comply with the occupant protection requirements (§ 1422.5) 12 months after publication of a final rule in the **Federal Register**. The requirements would apply to all ROVs manufactured or imported on or after the applicable date.

CPSC believes ROV models that do not comply with the lateral stability and vehicle handling requirements can be modified, with changes to track width and suspension, in less than 4 person-months (a high estimate) and can be tested for compliance in one day. Therefore, CPSC believes 180 days is a reasonable time period for manufacturers to modify vehicles if necessary, conduct necessary tests, and analyze test results to ensure compliance with the lateral stability and vehicle handling requirements.

The Commission is proposing the longer compliance date for the occupant protection requirements because we understand that some manufacturers will need to redesign and test new prototype vehicles to meet these requirements. This design and test process is similar to the process that manufacturers use when introducing new model year vehicles. We also estimate that it will take approximately 9 person-months per ROV model to design, test, implement, and begin manufacturing vehicles to meet the occupant protection performance

¹¹²Memorandum from Caroleene Paul, "Proposal for Seat Belt Speed Limiter on Recreational Off-Highway Vehicles (ROVs)," U.S. Consumer Product Safety Commission, Bethesda, MD 8 December 2013).

requirements. Therefore, staff believes that 12 months from publication of a final rule would be sufficient time for ROVs to comply with all of the proposed requirements.

XVII. Proposed Findings

The CPSA requires the Commission to make certain findings when issuing a consumer product safety standard. Specifically, the CPSA requires that the Commission consider and make findings about the degree and nature of the risk of injury; the number of consumer products subject to the rule; the need of the public for the rule and the probable effect on utility, cost, and availability of the product; and other means to achieve the objective of the rule, while minimizing the impact on competition, manufacturing, and commercial practices. The CPSA also requires that the rule must be reasonably necessary to eliminate or reduce an unreasonable risk of injury associated with the product and issuing the rule must be in the public interest. 15 U.S.C. 2058(f)(3).

In addition, the Commission must find that: (1) If an applicable voluntary standard has been adopted and implemented, that compliance with the voluntary standard is not likely to reduce adequately the risk of injury, or compliance with the voluntary standard is not likely to be substantial; (2) that benefits expected from the regulation bear a reasonable relationship to its costs; and (3) that the regulation imposes the least burdensome requirement that would prevent or adequately reduce the risk of injury. *Id.* These findings are discussed below.

Degree and nature of the risk of injury. CPSC received 428 reports of ROV-related incidents from the Injury and Potential Injury Incident (IPII) and In-Depth Investigation (INDP) databases that occurred between January 1, 2003 and December 31, 2011, and were received by December 31, 2011. There were a total of 826 victims involved in the 428 incidents. Among the 428 ROV-related incidents, there were a total of 231 reported fatalities and 388 reported injuries. Seventy-five of the 388 injuries (19 percent) could be classified as severe; that is, the victim has lasting repercussions from the injuries received in the incident, based on the information available. The remaining 207 victims were either not injured or their injury information was not known. Of the 428 ROV-related incidents, 76 involved drivers under 16 years of age (18 percent); 227 involved drivers 16 years of age or older (53 percent); and 125 involved drivers of unknown age (29 percent).

Using data reported through NEISS from January 1, 2010 to August 31, 2010, the Commission conducted a special study to identify cases that involved ROVs that were reported through NEISS. Based on information obtained through the special study, the estimated number of emergency department-treated ROV-related injuries occurring in the United States between January 1, 2010 and August 31, 2010, is 2,200 injuries. Extrapolating for the year 2010, the estimated number of emergency department-treated ROV-related injuries is 3,000, with a corresponding 95 percent confidence interval of 1,100 to 4,900.

Number of consumer products subject to the rule. Sales of ROVs have increased substantially since their introduction. In 1998, only one firm manufactured ROVs, and fewer than 2,000 units were sold. By 2003, when a second major manufacturer entered the market, almost 20,000 ROVs were sold. The only dip in sales occurred around 2008, which coincided with the worst of the credit crisis and a recession that also started about the same time. In 2013, an estimated 234,000 ROVs were sold by about 20 different manufacturers.

The number of ROVs available for use has also increased substantially. Because ROVs are a relatively new product, we do not have any specific information on the expected useful life of ROVs. However, using the same operability rates that CPSC uses for ATVs, we estimate that there were about 570,000 ROVs available for use in 2010. By the end of 2013, there were an estimated 1.2 million ROVs in use.

The need of the public for ROVs and the effects of the rule on their utility, cost, and availability.

Currently there are two varieties of ROVs: Utility and recreational. Early ROV models emphasized the utility aspects of the vehicles, but the recreational aspects of the vehicles have become very popular.

Regarding the effects of the rule on ROVs utility, according to comments on the ANPR provided by several ROV manufacturers, some ROV users “might prefer limit oversteer in the off-highway environment.” To the extent that the requirements in the proposed rule would reduce the ability of these users to reach limit oversteer intentionally, the proposed rule could have some adverse impact on the utility or enjoyment that these users receive from ROVs. These impacts would probably be limited to a small number of recreational users who enjoy activities or stunts that involve power oversteering or limit oversteer.

Although the impact on consumers who prefer limit oversteer cannot be quantified, the Commission expects that the impact will be low. Any impact would be limited to consumers who wish to engage intentionally in activities involving the loss of traction or power oversteer. The practice of power oversteer, such as the speed at which a user takes a turn, is the result of driver choice. The proposed rule would not prevent ROVs from reaching limit oversteer under all conditions; nor would the proposed rule prevent consumers from engaging in these activities. At most, the proposed rule might make it somewhat more difficult for users to reach limit oversteer in an ROV.

The seat belt speed limiter requirement could have an effect on utility and impose some unquantifiable costs on some users who would prefer not to use seat belts. The cost to these users would be the time required to buckle and unbuckle their seat belts and any disutility cost, such as discomfort caused by wearing the seat belt. We cannot quantify these costs because we do not know how many ROV users choose not to wear their seat belts; nor do we have the ability to quantify any discomfort or disutility that they would experience from wearing seat belts. However, the proposed rule does not require that the seat belts be fastened unless the vehicle is traveling faster than 15 mph. This should serve to mitigate these costs because many people who would be inconvenienced or discomforted by the requirement, such as people using the vehicle for work or utility purposes, or who must frequently get on and off the vehicle, are likely to be traveling at lower speeds.

The effect of the rule on cost and availability of ROVs is expected to be minimal. The average manufacturer's suggested retail prices (MSRP) of ROVs, weighted by units sold, was about \$13,100 in 2013, with a range of about \$3,600 to \$20,100. The Commission estimates the per-unit cost to ROVs of the rule to be \$61 to \$94. Because this per-unit cost resulting from the rule is a very small percentage of the overall retail price of an ROV, it is unlikely that the rule would have much of an effect on the cost or availability of ROVs.

Other means to achieve the objective of the rule, while minimizing the impact on competition and manufacturing. The Commission does not believe the rule will have adverse impact on competition. The preliminary regulatory analysis estimates the per-unit cost to ROVs of the rule to be \$61 to \$94. The average manufacturer's suggested retail prices (MSRP) of ROVs, weighted by

units sold, was about \$13,100 in 2013, with a range of about \$3,600 to \$20,100. The per-unit cost resulting from the rule is a very small percentage of the overall retail price of an ROV. With such a relatively low impact, it is unlikely that ROV companies would withdraw from the market or that the number of ROV models will be affected. Therefore, the preliminary regulatory analysis supports a finding that the proposed rule is unlikely to have an impact on competition.

The Commission believes that some, but not all, ROV models already meet the rule's requirement that the speed of the vehicle be limited if the driver's seat belt is not fastened. Before implementing any changes to their vehicles to meet the requirement, manufacturers whose ROVs do not meet the seatbelt speed limiter requirement would have to analyze their options for meeting the requirement. This process would include developing prototypes of system designs, testing the prototypes, and refining the design of the systems based on this testing. Once the manufacturer has settled on a system for meeting the requirement, the system will have to be incorporated into the manufacturing process of the vehicle. This will involve producing the engineering specifications and drawings of the system, parts, assemblies, and subassemblies that are required. Manufacturers will need to obtain the needed parts from their suppliers and incorporate the steps needed to install the system on the vehicles in the assembly line. The Commission believes that manufacturers should be able to complete activities related to meeting the lateral stability and handling requirements within 180 days after publication of the final rule and activities related to meeting the occupant protection requirements within 12 months after publication of the final rule. The Commission's proposed effective date of 12 months for the occupant protection requirements may reduce the impact of the proposed requirements on manufacturing.

Unreasonable risk. CPSC received 428 reports of ROV-related incidents from the Injury and Potential Injury Incident (IPII) and In-Depth Investigation (INDP) databases that occurred between January 1, 2003 and December 31, 2011, and were received by December 31, 2011. There were a total of 826 victims involved in the 428 incidents. Among the 428 ROV-related incidents, there were a total of 231 reported fatalities and 388 reported injuries. Seventy-five of the 388 injuries (19 percent) could be classified as severe; that is, the victim has lasting repercussions from the

injuries received in the incident based on the information available.

The estimated cost and benefits of the rule on an annual basis can be calculated by multiplying the estimated benefits and costs per unit by the number of ROVs sold in a given year. In 2013, 234,000 ROVs were sold. If the proposed rule had been in effect that year, the total quantifiable cost would have been between \$14.3 million and \$225.0 million (\$61 and \$94 multiplied by 234,000 units, respectively). The total quantifiable benefits would have been at least \$515 million (\$2,199 × 234,000). Of the benefits, about \$453 million (or about 88 percent) would have resulted from the reduction in fatal injuries, and about \$62 million (or about 12 percent) of the benefits would have resulted from a reduction in the societal cost of nonfatal injuries. The reduction in the societal cost of nonfatal injuries, which amounts to about \$47 million, would represent a reduction in pain and suffering. The Commission concludes preliminarily that ROVs pose an unreasonable risk of injury and finds that the proposed rule is reasonably necessary to reduce that unreasonable risk of injury.

Public interest. This proposed rule is intended to address identified aspects of ROVs, ROV design, and ROV use, which are believed to contribute to ROV deaths and injuries, with a goal of reducing such incidents. The CPSC believes that adherence to the requirements of the proposed rule will reduce ROV deaths and injuries in the future; thus the rule is in the public interest. Specifically, the Commission believes that improving lateral stability (by increasing rollover resistance) and improving vehicle handling (by correcting oversteer to understeer) are the most effective approaches to reducing the occurrence of ROV rollover incidents. ROVs with higher lateral stability are less likely to roll over because more lateral force is necessary to cause rollover. ROVs exhibiting understeer during a turn are also less likely to roll over because lateral acceleration decreases as the path of the ROV makes a wider turn, and the vehicle is more stable if a sudden change in direction occurs.

Furthermore, the Commission believes that when rollovers do occur, improving occupant protection performance (by increasing seat belt use) will mitigate injury severity. CPSC analysis of ROV incidents indicates that 91 percent of fatally ejected victims were not wearing a seat belt at the time of the incident. Increasing seat belt use, in conjunction with better shoulder retention performance, will significantly

reduce injuries and deaths associated with an ROV rollover event.

In summary, the Commission finds preliminarily that promulgating the proposed rule is in the public interest.

Voluntary standards. The Commission is aware of two voluntary standards that are applicable to ROVs, ANSI/ROHVA 1, *American National Standard for Recreational Off-Highway Vehicles*, and ANSI/B71.9, *American National Standard for Multipurpose Off-Highway Utility Vehicles*. As described previously in detail in the preamble, the Commission believes that the current voluntary standard requirements do not adequately reduce the risk of injury or death associated with ROVs. Neither voluntary standard requires that ROVs understeer, as required by the proposed rule. Based on testing and experience with the Yamaha Rhino repair program, the Commission believes that drivers are more likely to lose control of vehicles that oversteer, which can lead to the vehicle rolling over or to other types of accidents.

Both voluntary standards have requirements that are intended to set standards for dynamic lateral stability. ANSI/ROHVA 1–2011 uses a turn-circle test for dynamic lateral stability. That is more similar to the test in the proposed rule for determining whether the vehicle understeers, than it is to the test for dynamic lateral stability. The dynamic stability requirement in ANSI/OPEI B71.9–2012 uses a J-turn test, like the proposed rule, but measures different variables during the test and uses a different acceptance criterion. The Commission does not believe that the tests procedures in either standard have been validated properly as being capable of providing useful information about the dynamic stability of the vehicle. Moreover, the voluntary standards would find some vehicles acceptable, even though their lateral acceleration at rollover is less than 0.70 g, which is the acceptance criterion in the proposed rule.

Both voluntary standards require that manufacturers include a lighted seatbelt reminder that is visible to the driver and that remains on for at least 8 seconds after the vehicle is started, unless the driver's seatbelt is fastened. However, virtually all ROVs on the market already include this feature, and therefore, relying only on the voluntary standards would not be expected to raise seatbelt use over its current level.

The voluntary standards include requirements for retaining the occupant within the protective zone of the vehicle in the event of a rollover, including two options for restraining the occupants in the shoulder/hip area. However, testing

performed by CPSC identified weaknesses in the performance-based tilt table test option that allows unacceptable occupant head ejection beyond the protective zone of the vehicle Rollover Protective Structure (ROPS). CPSC testing indicated that a passive shoulder barrier could reduce the head excursion of a belted occupant during quarter-turn rollover events. The Commission believes that this can be accomplished by a requirement for a passive barrier based on the dimensions of the upper arm of a 5th percentile adult female, at a defined area near the ROV occupants' shoulder, as contained in the proposed rule.

Relationship of benefits to costs. The estimated costs and benefits of the rule on an annual basis can be calculated by multiplying the estimated benefits and costs per unit, by the number of ROVs sold in a given year. In 2013, 234,000 ROVs were sold. If the proposed rule had been in effect that year, the total quantifiable cost would have been between \$14.3 million and \$22.0 million (\$61 and \$94 multiplied by 234,000 units, respectively). The total quantifiable benefits would have been at least \$515 million (\$2,199 × 234,000).

On a per-unit basis, we estimate the total cost of the proposed rule to be \$61 to \$94 per vehicle. We estimate the total quantifiable benefits of the proposed rule to be \$2,199 per unit. This results in net quantifiable benefits of \$2,105 to \$2,138 per unit. Quantifiable benefits of the proposed rule could exceed the estimated \$1,329 per unit because the benefit associated with the vehicle handling and lateral stability requirement could not be quantified.

Based on this analysis, the Commission finds preliminarily that the benefits expected from the rule bear a reasonable relationship to the anticipated costs of the rule.

Least burdensome requirement. The Commission considered less-burdensome alternatives to the proposed rule on ROVs, but we concluded that none of these alternatives would adequately reduce the risk of injury:

(1) Not issuing a mandatory rule, but instead relying upon voluntary standards. If CPSC did not issue a mandatory standard, most manufacturers would comply with one of the two voluntary standards that apply to ROVs. As discussed previously, the Commission does not believe either voluntary standard adequately addresses the risk of injury and death associated with ROVs.

(2) Including the dynamic lateral stability requirement or the understeer requirement, but not both. The

Commission believes that both of these characteristics need to be addressed. A vehicle that meets both the dynamic stability requirement and the understeer requirement should be safer than a vehicle that meets only one of the requirements. Moreover, the cost of meeting just one requirement is not substantially lower than the cost of meeting both requirements. The cost of testing a vehicle for compliance with both the dynamic lateral stability and vehicle handling/understeer requirement was estimated to be about \$24,000. However, the cost of testing for compliance with just the dynamic stability requirement would be about \$20,000, or only about 17 percent less than the cost of testing for compliance with both requirements. This is because the cost of renting and transporting the vehicle to the test site, instrumenting the vehicle for the tests, and making some initial static measurements are virtually the same for both requirements and would only have to be done once if the tests for both requirements were conducted on the same day. Moreover, changes in the vehicle design that affect the lateral stability of the vehicle could also impact the handling of the vehicle. For these reasons, the proposed rule includes both a dynamic stability and vehicle handling requirement.

(3) Instead of seatbelt/speed limitation requirements in the proposed rule, the Commission considered a requirement for ROVs to have loud or intrusive seatbelt reminders. Currently, most ROVs meet the voluntary standards that require an 8-second visual seatbelt reminder. Some more intrusive systems have been used on passenger cars. For example, the Ford "BeltMinder" system resumes warning the driver after about 65 seconds if his or her seatbelt is not fastened and the car is traveling at more than 3 mph. The system flashes a warning light and sounds a chime for 6 seconds every 30 seconds for up to 5 minutes as long as the car is operating and the driver's seatbelt is not fastened. Honda developed a similar system in which the warning could last for longer than 9 minutes if the driver's seatbelt is not fastened. Studies of both systems found that a statistically significant increase in the use seatbelts of 5 percent (from 71 to 76 percent) and 6 percent (from 84 to 90 percent), respectively.

However, these more intrusive seatbelt warning systems are unlikely to be as effective as the seatbelt speed limitation requirement in the proposed rule. The Commission believes that the seatbelt speed limitation requirement will cause most drivers and passengers who desire to exceed 15 mph to fasten their seatbelts. Research supports this

position. One experiment used a haptic feedback system to increase the force the driver needed to exert to depress the gas pedal when the vehicle exceeded 25 mph if the seatbelt was not fastened. The system did not prevent the driver from exceeding 25 mph, but the system increased the amount of force required to depress the gas pedal to maintain a speed greater than 25 mph. In this experiment, all seven participants chose to fasten their seatbelts. A follow-up study on the haptic feedback study focused on 20 young drivers ranging in age from 18 to 21, and a feedback force set at 20 mph instead of 25 mph. The study results showed that the mean seat belt use increased from 54.7 percent to 99.7 percent, and the few instances in which seat belts were not worn were on trips of 2 minutes long or less. Most significantly, participants rated the system as very acceptable and agreeable (9 out of a 10-point scale).

The more intrusive seatbelt reminder systems used on some passenger cars have been more limited in their effectiveness. The Honda system, for example, reduced the number of unbelted drivers by about 38 percent; the Ford system reduced the number of unbelted drivers by only 17 percent. (The Honda system increased seatbelt use from 84 percent to 90 percent. Therefore, the percentage of unbelted drivers was reduced by about 38 percent, or 6 percent divided by 16 percent. The Ford system increased seatbelt use from 71 percent to 76 percent. Therefore, the percentage of unbelted drivers was reduced by about 17 percent, or 5 percent divided by 29 percent.) Additionally, ROVs are open vehicles and the ambient noise is likely higher than in the enclosed passenger compartment of a car. It is likely that some ROV drivers would not hear the warning, and therefore, they would be motivated to fasten their seatbelts, unless the warning was substantially louder than the systems used in passenger cars. Therefore, the Commission believes that the loud or intrusive seat belt reminders would not be as effective as the seat belt speed limiter requirement.

For the reasons set forth above, the Commission finds preliminarily that the rule imposes the least burdensome requirement that prevents or adequately reduces the risk of injury for which promulgation of the rule is proposed.

XVIII. Request for Comments

We invite all interested persons to submit comments on any aspect of the proposed rule. In particular, the Commission invites comments regarding the estimates used in the

preliminary regulatory analysis and the assumptions underlying these estimates. The Commission is especially interested in data that would help the Commission to refine its estimates to more accurately reflect the expected costs of the proposed rule as well as any alternate estimates that interested parties can provide. The Commission is also interested in comments addressing whether the proposed compliance dates of 180 days after the publication of the final rule to meet the lateral stability and vehicle handling requirements and 12 months after the publication of the final rule to meet the occupant protection requirements are appropriate. The Commission also seeks comments on the following:

- Additional key issues related to seatbelts for ROVs, including: available technology to prevent any hazards from the application of a passenger seatbelt requirement (such as sudden speed reductions if a passenger unbuckles); whether CPSC should extend the phase-in period for the seat-belt requirement; and any other relevant information related to the proposed seatbelt requirements.

- Whether CPSC should allow the use of doors or other mechanisms capable of meeting specified loading criteria to meet the shoulder restraint requirement.

- Whether there are further consistent and repeatable testing requirements that should be added to the proposed rule that would capture off-road conditions drivers experience in ROVs. If so, set forth the specifics of such further requirements.

- Whether CPSC should establish separate requirements for utility vehicles, including: definitions, scope, additional standards, and/or exemptions that would be suitable for requirements specific to utility vehicles.

The Commission seeks comment, data testing parameters and testing results concerning:

- Oversteer and understeer, dynamically unstable handling, and minimal path-following capabilities; and

- Whether there is a need for supplemental criteria in addition to specific lateral stability acceleration limits to avoid potential unintended consequences of a single criterion.

The public is invited to submit additional information about any other issues that stakeholders find relevant. Comments should be submitted in accordance with the instructions in the **ADDRESSES** section at the beginning of this notice.

XIV. Conclusion

For the reasons stated in this preamble, the Commission proposes requirements for lateral stability, vehicle handling, and occupant protection to address an unreasonable risk of injury associated with ROVs.

List of Subjects in 16 CFR Part 1422

Consumer protection, Imports, Information, Labeling, Recreation and Recreation areas, Incorporation by reference, Safety.

For the reasons discussed in the preamble, the Commission proposes to amend Title 16 of the Code of Federal Regulations as follows:

■ 1. Add part 1422 to read as follows:

PART 1422—SAFETY STANDARD FOR RECREATIONAL OFF-HIGHWAY VEHICLES

Sec.

1422.1 Scope, purpose and compliance dates.

1422.2 Definitions.

1422.3 Requirements for dynamic lateral stability.

1422.4 Requirements for vehicle handling.

1422.5 Requirements for occupant protection performance.

1422.6 Prohibited stockpiling.

1422.7 Findings.

Authority: 15 U.S.C. 2056, 2058 and 2076.

§ 1422.1 Scope, purpose and compliance dates.

(a) This part 1422, a consumer product safety standard, establishes requirements for recreational off-highway vehicles (ROVs), as defined in § 1422.2(a). The standard includes requirements for dynamic lateral, vehicle handling, and occupant protection. These requirements are intended to reduce an unreasonable risk of injury and death associated with ROVs.

(b) This standard does not apply to the following vehicles, as defined by the relevant voluntary standards:

- (1) Golf carts
- (2) All-terrain vehicles
- (3) Fun karts
- (4) Go karts
- (5) Light utility vehicles

(c) Any ROV manufactured or imported on or after [date that is 180 days after publication of a final rule] shall comply with the lateral stability requirements stated in § 1422.3 and the vehicle handling requirements stated in § 1422.4. Any ROV manufactured or imported on or after [date that is 12 months after publication of final rule] shall comply with the occupant protection requirements stated in § 1422.5.

§ 1422.2 Definitions.

In addition to the definitions in section 3 of the Consumer Product Safety Act (15 U.S.C. 2051), the following definitions apply for purposes of this part 1422.

(a) *Recreational off-highway vehicle (ROV)* means a motorized vehicle designed for off-highway use with the following features: Four or more wheels with pneumatic tires; bench or bucket seating for two or more people; automotive-type controls for steering, throttle, and braking; rollover protective structure (ROPS); occupant restraint; and maximum speed capability greater than 30 mph.

(b) *Two-wheel lift* means the point at which the inside wheels of a turning vehicle lift off the ground, or when the uphill wheels of a vehicle on a tilt table lift off the table. Two-wheel lift is a precursor to a rollover event. We use this term interchangeably with the term “tip-up.”

(c) *Threshold lateral acceleration* means the minimum lateral acceleration of the vehicle at two-wheel lift.

§ 1422.3 Requirements for dynamic lateral stability.

(a) *General.* The Recreational Off-Highway Vehicle (ROV) requirement for lateral stability is based on the average threshold lateral acceleration at rollover, as determined by a 30 mph dropped throttle J-turn test. This threshold lateral acceleration is measured parallel to the ground plane at the center of gravity (CG) of the loaded test vehicle and occurs at the minimum steering wheel angle required to cause the vehicle to roll over in a 30 mph dropped throttle J-turn test on a flat and level, high-friction surface. Rollover is achieved when all of the wheels of the ROV that are on the inside of the turn lift off the ground. For convenience, this condition is referred to as two-wheel lift, regardless of the number of wheels on the ROV. Testing shall be conducted on a randomly selected representative production vehicle.

(b) *Test surface.* Tests shall be conducted on a smooth, dry, uniform, paved surface constructed of asphalt or concrete. The surface area used for dynamic testing shall be kept free of debris and substances that may affect test results during vehicle testing.

(1) *Friction.* Surface used for dynamic testing shall have a peak braking coefficient greater than or equal to 0.90 and a sliding skid coefficient greater than or equal to 0.80 when measured in accordance with ASTM E 1337, Standard Test Method for Determining Longitudinal Peak Braking Coefficient of Paved Surfaces Using Standard

Reference Tire, approved December 1, 2012, and ASTM E274, Standard Test Method for Skid Resistance of Paved Surfaces Using a Full-Scale Tire, approved January 2011, respectively. The Director of the **Federal Register** approves these incorporations by reference in accordance with 5 U.S.C. 552(a) and 1 CFR part 51. You may obtain a copy from ASTM International, 100 Bar Harbor Drive, P.O. Box 0700, West Conshohocken, PA 19428; <http://www.astm.org/cpsc.htm>. You may inspect a copy at the Office of the Secretary, U.S. Consumer Product Safety Commission, Room 820, 4330 East West Highway, Bethesda, MD 20814, telephone 301-504-7923, or at the National Archives and Records Administration (NARA). For information on the availability of this material at NARA, call 202-741-6030, or go to: http://www.archives.gov/federal_register/code_of_federalregulations/ibr_locations.html.

(2) *Slope*. The test surface shall have a slope equal to or less than 1 degree (1.7% grade).

(3) *Ambient conditions*. The ambient temperature shall be between 0 degrees Celsius (32 °Fahrenheit) and 38 °C (100 °F). The maximum wind speed shall be no greater than 16 mph (7 m/s).

(c) *Test conditions*. (1) *Vehicle condition*. An ROV used for dynamic testing shall be configured in the following manner:

(i) The test vehicle shall be a representative production vehicle. The ROV shall be in standard condition. Adjustable seats shall be located in the most rearward position.

(ii) The ROV shall be operated in two-wheel drive mode, with selectable differential in its most-open setting. The tires shall be the manufacturer's original-equipment tires intended for normal retail sale to consumers. The tires shall be new when starting the tests, then broken-in by conducting a minimum total of ten J-turns with five in the right-turning direction and five in the left-turning direction. The J-turns conducted for tire break-in shall be conducted at 30 mph and steering angles sufficient to cause two-wheel lift.

(iii) Springs or shocks that have adjustable spring or damping rates shall be set to the manufacturer's recommended settings for delivery.

(iv) Tires shall be inflated to the ROV manufacturer's recommended settings for normal operation for the load condition specified in paragraph (c)(vi) of this section. If more than one pressure is specified, the lowest value shall be used.

(v) All vehicle operating fluids shall be at the manufacturer's recommended

level, and the fuel tank shall be full to its rated capacity.

(vi) The ROV shall be loaded, such that the combined weight of the test operator, test equipment, and ballast, if any, shall equal 430 lbs. ± 11 lbs. (195 kg ± 5 kg).

(vii) The center of gravity (CG) of the equipped test vehicle shall be no more than 0.5 inch below (and within 1.0 inch in the x-axis and y-axis directions) the CG of the vehicle as it is sold at retail and loaded according to paragraph (c)(vi) of this section.

(2) *Vehicle test equipment*. (i) *Safety equipment*. Test vehicles shall be equipped with outriggers on both sides of the vehicle. The outriggers shall be designed to minimally affect the loaded vehicle's center of gravity location, shall permit the vehicle to experience two-wheel lift during dynamic testing, and shall be capable of preventing a full vehicle rollover.

(ii) *Steering controller*. The test vehicle shall be equipped with a programmable steering controller (PSC), capable of responding to vehicle speed, with a minimum steering angle input rate of 500 degrees per second, and accurate within + 0.25 degree. The steering wheel setting for 0.0 degrees of steering angle is defined as the setting which controls the properly aligned vehicle to travel in a straight path on a level surface. The PSC shall be operated in absolute steering mode, where the amount of steering used for each test shall be measured relative to the PSC reading when the vehicle steering is at zero degrees.

(iii) *Vehicle instrumentation*. The vehicle shall be instrumented to record lateral acceleration, vertical acceleration, longitudinal acceleration, forward speed, steering wheel angle, steering wheel angle rate, vehicle roll angle, roll angle rate, pitch angle rate, and yaw angle rate. See Table 1 for instrumentation specifications. Ground plane lateral acceleration shall be calculated by correcting the body-fixed acceleration for roll angle. A roll motion inertia measurement sensor that provides direct output of ground plane lateral acceleration at the vehicle CG may also be used in lieu of manual correction to obtain ground plane lateral acceleration. Roll angle may be calculated from roll rate data.

TABLE 1—INSTRUMENTATION SPECIFICATION FOR J-TURN AND CONSTANT RADIUS TESTING OF ROVS

Parameter	Accuracy
Vehicle Speed	± 0.10 mph

TABLE 1—INSTRUMENTATION SPECIFICATION FOR J-TURN AND CONSTANT RADIUS TESTING OF ROVS—Continued

Parameter	Accuracy
Acceleration (x, y, and z directions)	± 0.003 g
Steering Wheel Angle	± 0.25 deg.
Steering Wheel Angle Rate ..	± 0.5 deg./sec.
Pitch, Roll, and Yaw Rates ...	± 0.10 deg./sec.
Roll Angle*	± 0.20 deg.

* For constant radius testing, roll angle must be measured directly or roll rate accuracy must be ± 0.01 deg./sec.

(d) *Test procedure*. (1) 3.3.1. Set the vehicle drive train in its most-open setting. For example, two-wheel drive shall be used instead of four-wheel drive, and a lockable differential, if so equipped, shall be in its unlocked, or "open," setting.

(2) Drive the vehicle in a straight path to define zero degree (0.0) steer angle.

(3) Program the PSC to input a 90-degree turn to the right at a minimum of 500 degrees per second as soon as the vehicle slows to 30 mph. Program the PSC to hold steering angles for a minimum of 4 seconds before returning to zero steer angle. The steering rate when returning to zero may be less than 500 degrees per second.

(4) Conduct a 30 mph dropped throttle J-turn.

(i) Accelerate the vehicle in a straight line to a speed greater than 30 mph.

(ii) As the vehicle approaches the desired test location, engage the PSC and fully release the throttle.

(iii) The PSC shall input the programmed steering angle when the vehicle decelerates to 30 mph. Verify that the instrumentation recorded all of the data during this J-turn event.

(5) Conduct additional J-turns, increasing the steer angle in 10-degree increments, as required, until a two-wheel lift event is visually observed.

(6) Conduct additional J-turns, decreasing the steering angle in 5-degree increments to find the lowest steering angle that will produce two-wheel lift. Additional adjustments, up or down, in 1-degree increments may be used.

(7) Repeat the process of conducting J-turns to determine minimum steer angle to produce two-wheel lift in left turn direction.

(8) Start the data acquisition system.

(9) Conduct J-turn test trials in the left and right directions using the minimum steering angles determined in paragraphs (d)(6) and (d)(7) of this section to verify that the steering angle

produces two-wheel lift in both directions.

(10) Conduct five J-turn test trials with two-wheel lift in the left and right turn directions in one direction heading on the test surface (10 total trials). On the same test track, but in the opposite heading on the test surface, conduct five more J-turn test trials with two-wheel lift in the left and right turn directions (10 total trials). A minimum data set will consist of 20 total J-turn test trials with half of the tests conducted in one direction on the test surface and half of the tests conducted in the opposite direction. Review all data parameters for each trial to verify that the tests were executed correctly. Any trials that do not produce two-wheel lift should be diagnosed for cause. If cause is identified, discard the data and repeat the trial to replace the data. If no cause can be identified, repeat actions stated in paragraphs (d)(5) through (d)(7) of this section to ensure that the correct steering angle has been determined. Additional J-turn tests may be added to the minimum data set in groups of four, with one test for each left/right turn direction and one test for each direction heading on the test surface.

(11) Determine value of threshold lateral acceleration at rollover.

(i) Data recorded as required in paragraph (d)(10) of this section shall be

digitally low-pass filtered to 2.0 hertz, using a phaseless, eighth-order, Butterworth filter to eliminate noise artifacts on the data.

(ii) Plot the data for ground plane lateral acceleration corrected to the test vehicle CG location, steering wheel angle, and roll angle recorded for each trial conducted under paragraph (d)(10) of this section.

(iii) Find and record the peak ground plane lateral acceleration occurring between the time of the PSC input and the time of two-wheel lift.

(iv) If a body-fixed acceleration sensor is used, correct the lateral acceleration data for roll angle, using the equation:

$$A_y \text{ ground} = A_y \cos \Phi - A_z \sin \Phi$$

(Φ = vehicle body roll angle)

(v) Calculate the threshold lateral acceleration at rollover value, which is the average of the peak values for ground plane lateral acceleration for all of the trials conducted under paragraph (d)(10) of this section that produced two-wheel lift.

(e) *Performance requirements.* The minimum value for the threshold lateral acceleration at rollover shall be 0.70 g or greater.

(f) *Consumer information requirements.* The manufacturer shall provide a hang tag with every ROV that is visible to the driver and provides the value of the threshold lateral

acceleration at rollover of that model vehicle. The label must conform in content, form, and sequence to the hang tag shown in Figure 1.

(1) *Size.* Every hang tag shall be at least 6 inches (152 mm) wide x 4 inches (102 mm) tall.

(2) *Content.* Every hang tag shall contain the following:

(i) Value of the threshold lateral acceleration at rollover of that model vehicle displayed on a progressive scale.

(ii) The statement—“Compare with other vehicles before you buy.”

(iii) The statement—“The value above is a measure of this vehicle’s resistance to rolling over on a flat surface. Vehicles with higher numbers are more stable.”

(iv) The statement—“Other vehicles may have a higher rollover resistance; compare before you buy.”

(v) The statement—“Rollover cannot be completely eliminated for any vehicle.”

(vi) The statement—“Lateral acceleration is measured during a J-turn test; minimally accepted value is 0.7 g.”

(vii) The manufacturer’s name and vehicle model, e.g., XYZ corporation, Model x, ####.

(3) *Format.* The hang tag shall be formatted as shown in Figure 1.

(4) *Attachment.* Every hang tag shall be attached to the ROV and conspicuous to the seated driver.

Figure 1. Hang tag

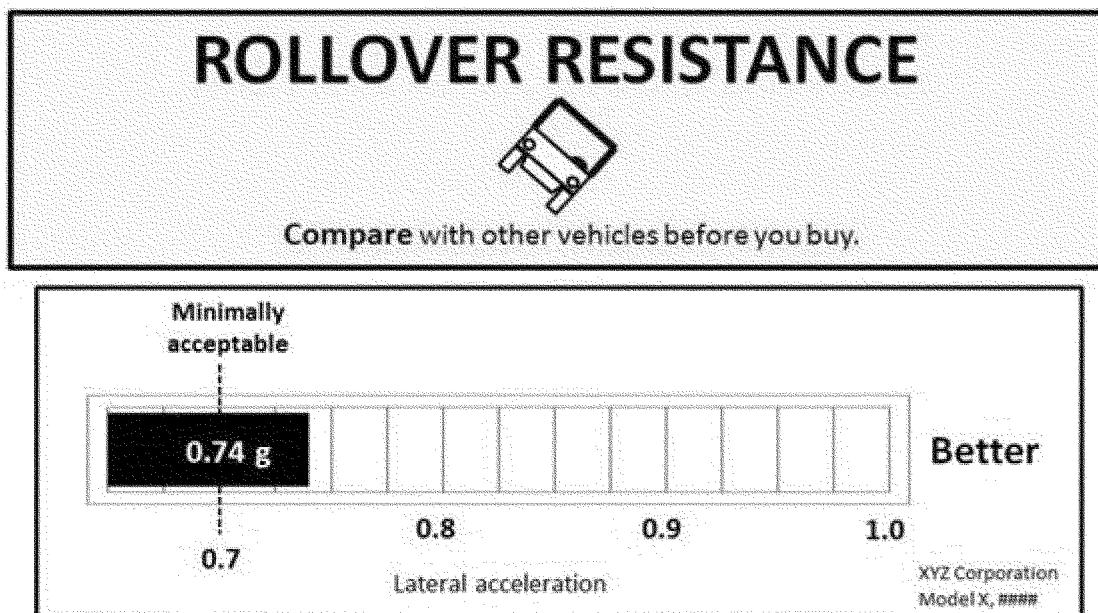

The value above is a measure of this vehicle's resistance to rolling over on a flat surface. Vehicles with higher numbers are more stable.

- Other vehicles may have a higher rollover resistance; compare before you buy.
- Rollover cannot be completely eliminated for any vehicle.
- Lateral acceleration is measured during a J-turn test; minimally accepted value is 0.7 g.

§ 1422.4 Requirements for vehicle handling.

(a) *General.* The ROV requirement for vehicle handling shall be based on the vehicle's steering gradient, as measured by the constant radius test method described in SAE Surface Vehicle Recommended Practice J266, published January 1996. The Director of the Federal Register approves this incorporation by reference in accordance with 5 U.S.C. 552(a) and 1 CFR part 51. You may obtain a copy from ASTM International, 100 Bar Harbor Drive, P.O. Box 0700, West Conshohocken, PA 19428; <http://www.astm.org/cpsc.htm>. You may inspect a copy at the Office of the Secretary, U.S. Consumer Product Safety Commission, Room 820, 4330 East West Highway, Bethesda, MD 20814, telephone 301-504-7923, or at the National Archives and Records Administration (NARA). For information on the availability of this material at NARA, call 202-741-6030, or go to: http://www.archives.gov/federal_register/code_of_federal_regulations/ibr_locations.html.

(b) *Test surface.* Tests shall be conducted on a smooth, dry, uniform, paved surface constructed of asphalt or concrete. The surface area used for

dynamic testing shall be kept free of debris and substances that may affect test results during vehicle testing.

(1) *Friction.* Surface used for dynamic testing shall have a peak braking coefficient greater than or equal to 0.90 and a sliding skid coefficient greater than or equal to 0.80 when measured in accordance with ASTM E 1337 and ASTM E274, respectively.

(2) *Slope.* The test surface shall have a slope equal to or less than 1 degree (1.7% grade).

(3) *Ambient conditions.* The ambient temperature shall be between 0 degrees Celsius (32 °Fahrenheit) and 38 °C (100 °F). The maximum wind speed shall be no greater than 16 mph (7 m/s).

(c) *Test conditions.*—(1) *Vehicle condition.* A vehicle used for dynamic testing shall be configured in the following manner. (i) The test vehicle shall be a representative production vehicle. The ROV shall be in standard condition. Adjustable seats shall be located in the most rearward position.

(ii) The ROV shall be operated in two-wheel drive mode with selectable differential in its most-open setting. The tires shall be the manufacturer's original-equipment tires intended for normal retail sale to consumers. The tires shall be new when starting the tests, then broken-in by conducting a

minimum total of ten J-turns with five in the right-turning direction and five in the left-turning direction. The J-turns conducted for tire break-in shall be conducted at 30 mph and steering angles sufficient to cause two-wheel lift. Tires used for the full test protocol to establish the threshold lateral acceleration at rollover value for the test vehicle are acceptable for use in the handling performance test protocol.

(iii) Springs or shocks that have adjustable spring or damping rates shall be set to the manufacturer's recommended settings for delivery.

(iv) Tires shall be inflated to the ROV manufacturer's recommended settings for normal operation for the load condition specified in paragraph (c)(vi) of this section. If more than one pressure is specified, the lowest value shall be used.

(v) All vehicle operational fluids shall be at the manufacturer's recommended level and the fuel tank shall be full to its rated capacity.

(vi) The ROV shall be loaded, such that the combined weight of the test operator, test equipment, and ballast, if any, shall equal 430 lbs. ± 11 lbs. (195 kg ± 5 kg).

(vii) The center of gravity (CG) of the equipped test vehicle shall be no more than 0.5 inch below (and within 1.0

inch in the x-axis and y-axis directions) the CG of the vehicle as it is sold at retail and loaded according to paragraph (c)(vi) of this section.

(2) *Vehicle test equipment.* Test vehicles shall be equipped with outriggers on both sides of the vehicle. The outriggers shall be designed to minimally affect the loaded vehicle's center of gravity location, shall permit the vehicle to experience two-wheel lift during dynamic testing, and shall be capable of preventing a full vehicle rollover.

(ii) *Vehicle instrumentation.* The vehicle shall be instrumented to record lateral acceleration, vertical acceleration, longitudinal acceleration, forward speed, steering wheel angle, steering wheel angle rate, vehicle roll angle, roll angle rate, pitch angle rate, and yaw angle rate. See Table 1 in § 1422.3(c) for instrumentation specifications. Ground plane lateral acceleration shall be calculated by correcting the body-fixed acceleration for roll angle. A roll motion inertia measurement sensor that provides direct output of ground plane lateral acceleration at the vehicle CG may also be used in lieu of manual correction to obtain ground plane lateral acceleration.

(d) *Test Procedure.* (1) Handling performance testing shall be conducted using the constant radius test method described in SAE Surface Vehicle Recommended Practice J266. The minimum radius for constant-radius testing shall be 100 feet. In this test method, the instrumented and loaded vehicle is driven while centered on a 100-ft. radius circle marked on the test surface, with the driver making every effort to maintain the vehicle path relative to the circle. The vehicle is operated at a variety of increasing speeds, and data are recorded for those various speed conditions to obtain data to describe the vehicle handling behavior across the prescribed range of ground plane lateral accelerations. Data shall be recorded for the lateral acceleration range from 0.0 g to 0.5 g.

(2) Start the data acquisition system.

(3) Drive the vehicle on the circular path at the lowest possible speed. Data shall be recorded with the steering wheel position and throttle position fixed to record the approximate Ackermann angle.

(4) Continue driving the vehicle to the next speed at which data will be taken. The vehicle speed shall be increased and data shall be taken until it is no longer possible for the driver to maintain directional control of the vehicle. Test shall be repeated at least three times so that results can be

examined for repeatability and then averaged.

(5) *Data collection, method 1—discrete data points.* In this data acquisition method, the driver maintains a constant speed while maintaining compliance with the circular path, and data points are recorded when a stable condition of speed and steering angle is achieved. After the desired data points are recorded for a given speed, the driver accelerates to the next desired speed setting, maintains constant speed and compliance with the path, and data points are recorded for the new speed setting. This process is repeated to cover the speed range from 0.0 mph to 28 mph, which will map the lateral acceleration range from near 0.0 g to 0.50 g. Increments of speed shall be 1 to 2 miles per hour, to allow for a complete definition of the understeer gradient. Data shall be taken at the lowest speed practicable to obtain an approximation of the vehicle's Ackermann steering angle.

(6) *Data collection, method 2—continuous data points.* In this data acquisition method, the driver maintains compliance with the circular path while slowly increasing vehicle speed; and data from the vehicle instrumentation is recorded continuously, so long as the vehicle remains centered on the intended radius. The rate of speed increase shall not exceed 0.93 mph per second. Initial speed shall be as low as is practicable, in order to obtain an approximation of the vehicle's Ackermann steering angle. The speed range shall be 0.0 mph to 28.0 mph, which will be sufficient to produce corrected lateral accelerations from near 0.0 g to 0.50 g.

(7) *Vehicle dimension coordinate system.* The coordinate system described in SAE Surface Vehicle Recommended Practice J670, published in January 2008, shall be used. The Director of the Federal Register approves this incorporation by reference in accordance with 5 U.S.C. 552(a) and 1 CFR part 51. You may obtain a copy from ASTM International, 100 Bar Harbor Drive, P.O. Box 0700, West Conshohocken, PA 19428; <http://www.astm.org/cpsc.htm>. You may inspect a copy at the Office of the Secretary, U.S. Consumer Product Safety Commission, Room 820, 4330 East West Highway, Bethesda, MD 20814, telephone 301-504-7923, or at the National Archives and Records Administration (NARA). For information on the availability of this material at NARA, call 202-741-6030, or go to: <http://www.archives.gov/>

[federalregister/code_of_federalregulations/ibr_locations.html](http://www.federalregister.gov/code_of_federalregulations/ibr_locations.html).

(8) *Data analysis.* The lateral acceleration data shall be corrected for roll angle using the method described in § 1422.3(11)(iv). To provide uniform and comparable data, the ground plane lateral acceleration shall also be corrected to reflect the value at the test vehicle's center of gravity. The data shall be digitally low-pass filtered to 1.0 Hz, using a phase-less, eighth-order, Butterworth filter, and plotted with ground plane lateral acceleration on the abscissa versus hand-wheel steering angle on the ordinate. A second-order polynomial curve fit of the data shall be constructed in the range from 0.01 g to 0.5 g. The slope of the constructed plot determines the understeer gradient value in the units of degrees of hand-wheel steering angle per g of ground plane lateral acceleration (degrees/g). Using the coordinate system specified in paragraph (d)(7) of this section, positive values for understeer gradient are required for values of ground plane lateral acceleration values from 0.10 g to 0.50 g.

(e) *Performance requirements.* Using the coordinate system specified in section 1422.4(d)(7), values for the understeer gradient shall be positive for values of ground plane lateral acceleration values from 0.10 g to 0.50 g. The ROV shall not exhibit negative understeer gradients (oversteer) in the lateral acceleration range specified.

§ 1422.5 Requirements for occupant protection performance.

(a) *General.* The ROV requirement for occupant protection shall be based on the maximum vehicle speed limitation when the seat belt of any occupied front seat is not buckled, and on passive coverage of the occupant shoulder area as measured by a probe test.

(b) *Vehicle speed limitation.* (1) *Test surface.* Tests shall be conducted on a smooth, dry, uniform, paved surface constructed of asphalt or concrete. The surface area used for dynamic testing shall be kept free of debris and substances that may affect test results during vehicle testing.

(i) *Friction.* Surface shall have a peak braking coefficient greater than or equal to 0.90, and a sliding skid coefficient greater than or equal to 0.80, when measured in accordance with ASTM E 1337 and ASTM E274, respectively.

(ii) *Slope.* The test surface shall have a slope equal to or less than 1 degree (1.7% grade).

(2) *Test condition 1.* Test conditions shall be as follows:

(i) The test vehicle shall be a representative production vehicle. The

ROV shall have a redundant restraint system in the driver's seat.

(ii) ROV test weight shall be the vehicle curb weight plus the test operator, only. If the test operator weighs less than 215 lbs. \pm 11 lbs. (98 kg \pm 5 kg), then the difference in weight shall be added to the vehicle to reflect an operator weight of 215 lbs. \pm 11 lbs. (98 kg \pm 5 kg).

(iii) Tires shall be inflated to the pressures recommended by the ROV manufacturer for the vehicle test weight.

(iv) The driver's seat belt shall not be buckled; however, the driver shall be restrained by the redundant restraint system for test safety purposes.

(3) *Test condition 2.* Test conditions shall be as follows:

(i) The test vehicle shall be a representative production vehicle, in standard condition.

(ii) ROV test weight shall be the vehicle curb weight, plus the test operator and a passenger surrogate that will activate the seat occupancy sensor. If the test operator weighs less than 215 lbs. \pm 11 lbs. (98 kg \pm 5 kg), then the difference in weight shall be added to the vehicle to reflect an operator weight of 215 lbs. \pm 11 lbs. (98 kg \pm 5 kg).

(iii) Tires shall be inflated to the pressures recommended by the ROV manufacturer for the vehicle test weight.

(iv) The driver's seat belt shall be buckled. The front passenger's seat belt(s) shall not be buckled.

(4) *Test procedure.* Measure the maximum speed capability of the ROV under Test Condition 1, specified in paragraph (b)(2) of this section, and Test Condition 2, specified in paragraph (b)(3) of this section using a radar gun or equivalent method. The test operator shall accelerate the ROV until maximum speed is reached, and shall maintain maximum speed for at least 15 m (50 ft.). Speed measurement shall be made

when the ROV has reached a stabilized maximum speed. A maximum speed capability test shall consist of a minimum of two measurement test runs conducted over the same track, one each in opposite direction. If more than two measurement runs are made, there shall be an equal number of runs in each direction. The maximum speed capability of the ROV shall be the arithmetic average of the measurements made.

(5) *Performance requirement.* The maximum speed capability of a vehicle with an unbuckled seat belt of the driver or any occupied front passenger seat shall be 15 mph or less.

(c) *Passive coverage of shoulder area.*

(1) *General test conditions.*

(i) Probes shall be allowed to rotate through a universal joint.

(ii) Forces shall be quasi-statically applied and held for 10 seconds.

(2) *Shoulder/Hip performance requirement.* The vehicle structure or restraint system must absorb the force specified in § 1422.5(c)(5) with less than 25 mm (1 inch) of permanent deflection along the horizontal lateral axis.

(3) *Location of applied force.* Locate point R on the vehicle, as shown in Figure X of ANSI/ROHVA 1-2011, American National Standard for Recreational Off-Highway Vehicles, approved July 11, 2011. The Director of the Federal Register approves this incorporation by reference in accordance with 5 U.S.C. 552(a) and 1 CFR part 51. You may obtain a copy from ASTM International, 100 Bar Harbor Drive, P.O. Box 0700, West Conshohocken, PA 19428; <http://www.astm.org/cpsc.htm>. You may inspect a copy at the Office of the Secretary, U.S. Consumer Product Safety Commission, Room 820, 4330 East West Highway, Bethesda, MD 20814, telephone 301-504-7923, or at

the National Archives and Records Administration (NARA). For information on the availability of this material at NARA, call 202-741-6030, or go to: http://www.archives.gov/federal_register/code_of_federalregulations/ibr_locations.html. All measurements for the point shall be taken with respect to the base of the seatback. The base of the seatback lies on the surface of the seat cushion along the centerline of the seating position and is measured without a simulated occupant weight on the seat. Point R is located 432 mm (17 inches) along the seat back above the base of the seatback. The point is 152 mm (6 inches) forward of and perpendicular to the seatback surface as shown in the figure. For an adjustable seat, Point R is determined with the seat adjusted to the rear-most position. Point R2 applies to an adjustable seat and is located in the same manner as Point R except that the seat is located in the forward-most position.

(4) *Barriers.* Remove all occupant protection barriers that require action on the part of the consumer to be effective (i.e. remove nets). Passive barriers that do not require any consumer action are allowed to remain.

(5) *Shoulder/Hip test method.* Apply a horizontal, outward force of 725 N (163 lbf.). Apply the force through the upper arm probe shown in Figure 2. The upper arm probe shall be oriented so that Point Q on the probe is coincident with Point R for a vehicle with a fixed seat, or Point Q shall be coincident with any point between R and R2 for a vehicle with an adjustable seat. The probe's major axis shall be parallel to the seatback angle at a point 17 inches along the seat back above the base of the seatback.

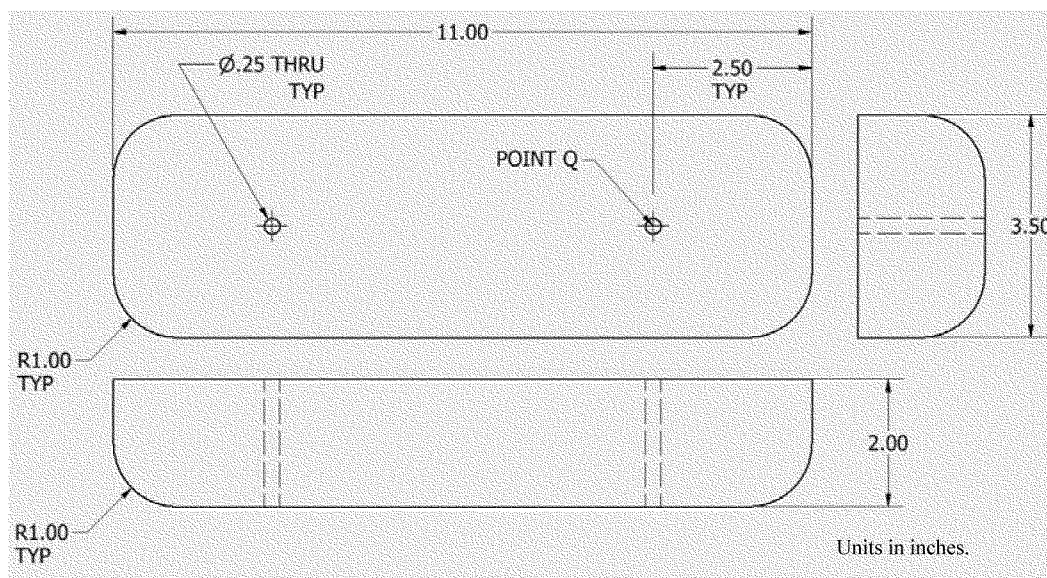

Figure 2. Shoulder/Hip Zone Probe

§ 1422.6 Prohibited stockpiling.

(a) *Stockpiling.* *Stockpiling* means manufacturing or importing a product which is the subject of a consumer product safety rule between the date of issuance of the rule and its effective date at a rate that is significantly greater than the rate at which such product was produced or imported during a base period prescribed by the Consumer Product Safety Commission.

(b) *Base period.* The base period for ROVs is, at the option of each manufacturer or importer, any period of 365 consecutive days beginning on or after October 1, 2009, and ending on or before [the date of promulgation of the rule].

(c) *Prohibited acts.* Manufacturers and importers of ROVs shall not manufacture or import ROVs that do not comply with the requirements of this part between [the date of promulgation of the rule] and [the effective date of the rule] at a rate that exceeds 10 percent of the rate at which this product was produced or imported during the base period described in paragraph (b) of this section.

§ 1422.7 Findings.

(a) *General.* In order to issue a consumer product safety standard under the Consumer Product Safety Act, the Commission must make certain findings and include them in the rule. 15 U.S.C. 2058(f)(3). These findings are discussed in this section.

(b) *Degree and nature of the risk of injury.* (1) CPSC received 428 reports of ROV-related incidents from the Injury and Potential Injury Incident (IPII) and In-Depth Investigation (INDP) databases that occurred between January 1, 2003

and December 31, 2011, and were received by December 31, 2011. There were a total of 826 victims involved in the 428 incidents. Within the 428 ROV-related incidents, there were a total of 231 reported fatalities and 388 reported injuries. Seventy-five of the 388 injuries (19 percent) could be classified as severe, that is, the victim has lasting repercussions from the injuries received in the incident, based on the information available. The remaining 207 victims were either not injured or their injury information was not known. Of the 428 ROV-related incidents, 76 involved drivers under 16 years of age (18 percent); 227 involved drivers 16 years of age or older (53 percent); and 125 involved drivers of unknown age (29 percent).

(2) Using data reported through the National Electronic Injury Surveillance System (NEISS) from January 1, 2010 to August 31, 2010, the Commission conducted a special study to identify cases that involved ROVs that were reported through NEISS. (NEISS is a stratified national probability sample of hospital emergency departments that allows the Commission to make national estimates of product-related injuries.) Based on information obtained through the special study, the estimated number of emergency department-treated ROV-related injuries occurring in the United States between January 1, 2010 and August 31, 2010, is 2,200 injuries. Extrapolating for the year 2010, the estimated number of emergency department-treated ROV-related injuries is 3,000, with a corresponding 95 percent confidence interval of 1,100 to 4,900.

(c) *Number of consumer products subject to the rule.* (1) Sales of ROVs have increased substantially since their introduction. In 1998, only one firm manufactured ROVs, and fewer than 2,000 units were sold. By 2003, when a second major manufacturer entered the market, almost 20,000 ROVs were sold. The only dip in sales occurred around 2008, which coincided with the worst of the credit crisis and recession that also started about the same time. In 2013, an estimated 234,000 ROVs were sold by about 20 different manufacturers. (This information is based upon a Commission analysis of sales data provided by Power Products Marketing, Eden Prairie, MN.)

(2) The number of ROVs available for use has also increased substantially. Because ROVs are a relatively new product, we do not have any specific information on the expected useful life of ROVs. However, using the same operability rates that CPSC uses for ATVs, we estimate that there were about 570,000 ROVs available for use in 2010. By the end of 2013, there were an estimated 1.2 million ROVs in use.

(d) *The need of the public for ROVs and the effects of the rule on their utility, cost, and availability.* (1) Currently there are two varieties of ROVs: Utility and recreational. Early ROV models emphasized the utility aspects of the vehicles, but the recreational aspects of the vehicles have become very popular.

(2) In terms of the effects of the rule on ROVs utility, according to several ROV manufacturers, some ROV users "might prefer limit oversteer in the off-highway environment." (This assertion was contained in a public comment on

the ANPR for ROVs (Docket No. CPSC–2009–0087) submitted jointly on behalf of Arctic Cat, Inc., Bombardier Recreational Products, Inc., Polaris Industries, Inc., and Yamaha Motor Corporation, USA.) To the extent that the requirements in the proposed rule would reduce the ability of these users to intentionally reach limit oversteer, the proposed rule could have some adverse impact on the utility or enjoyment that these users receive from ROVs. These impacts would probably be limited to a small number of recreational users who enjoy activities or stunts that involve power oversteering or limit oversteer.

(3) Although the impact on consumers who prefer limit oversteer cannot be quantified, the Commission expects that it will be low. Any impact would be limited to those consumers who wish to intentionally engage in activities involving the loss of traction or power oversteer. The practice of power oversteer is the result of driver choices, such as the speed at which a user takes a turn. The proposed rule would not prevent ROVs from reaching limit oversteer under all conditions; nor would the rule prevent consumers from engaging in these activities. At most, the proposed rule might make it somewhat more difficult for users to reach limit oversteer in an ROV. Moreover, consumers who have a high preference for vehicles that oversteer would be able to make aftermarket modifications, such as adjustments to the suspension of the vehicle, or using different wheels or tires to increase the potential for oversteering.

(4) The seat belt speed limiter requirement could have a negative effect on utility and impose some unquantifiable costs on some users who would prefer not to use seat belts. The cost to these users would be the time required to buckle and unbuckle their seat belts and any disutility cost, such as discomfort caused by wearing the seat belt. We cannot quantify these costs because we do not know how many ROV users choose not to wear their seat belts, nor do we have the ability to quantify any discomfort or disutility that they would experience from wearing seat belts. However, the proposed rule does not require that the seat belts be fastened unless the vehicle is traveling 15 mph or faster. This should serve to mitigate these costs because many people who would be inconvenienced or discomforted by the requirement, such as people using the vehicle for work or utility purposes or who must frequently get on and off the vehicle are likely to be traveling at lower speeds.

(5) The effect of the rule on cost and availability of ROVs is expected to be minimal. The average manufacturer's suggested retail prices (MSRP) of ROVs, weighted by units sold, was about \$13,100 in 2013, with a range of about \$3,600 to \$20,100. The preliminary regulatory analysis estimates the per-unit cost to ROVs of the rule to be \$61 to \$94. Because this per-unit cost resulting from the rule is a very small percentage of the overall retail price of a ROV, it is unlikely that the rule would have more than a minimal effect on the cost or availability of ROVs.

(e) *Other means to achieve the objective of the rule, while minimizing the impact on competition and manufacturing.* (1) The Commission does not believe the rule will have adverse impact on competition. The preliminary regulatory analysis estimates the per-unit cost to ROVs of the rule to be \$61 to \$94. The average manufacturer's suggested retail prices (MSRP) of ROVs, weighted by units sold, was about \$13,100 in 2013, with a range of about \$3,600 to \$20,100. The per-unit cost resulting from the rule is a very small percentage of the overall retail price of a ROV and is unlikely to have any impact on competition.

(2) The Commission believes that some but not all ROV models already meet the rule's requirement that the speed of the vehicle be limited if the driver's seat belt is not fastened. Before implementing any changes to their vehicles to meet the requirement, manufacturers whose ROVs do not meet the seatbelt speed limiter requirement would have to analyze their options for meeting the requirement. This process would include developing prototypes of system designs, testing the prototypes and refining the design of the systems based on this testing. Once the manufacturer has settled upon a system for meeting the requirement, the system will have to be incorporated into the manufacturing process of the vehicle. This will involve producing the engineering specifications and drawings of the system, parts, assemblies, and subassemblies that are required. Manufacturers will need to obtain the needed parts from their suppliers and incorporate the steps needed to install the system on the vehicles in the assembly line. The Commission believes that manufacturers should be able to complete all of these activities and be ready to produce vehicles that meet the requirement within 12 calendar months. The Commission is proposing a 12-month effective date for the occupant protection requirements to minimize the burden on manufacturing.

(f) *Unreasonable risk.* (1) CPSC received 428 reports of ROV-related incidents from the Injury and Potential Injury Incident (IPII) and In-Depth Investigation (INDP) databases that occurred between January 1, 2003 and December 31, 2011, and were received by December 31, 2011. There were a total of 826 victims involved in the 428 incidents. Within the 428 ROV-related incidents, there were a total of 231 reported fatalities and 388 reported injuries. Seventy-five of the 388 injuries (19 percent) could be classified as severe, that is, the victim has lasting repercussions from the injuries received in the incident, based on the information available.

(2) The estimated cost and benefits of the rule on an annual basis can be calculated by multiplying the estimated benefits and costs per unit by the number of ROVs sold in a given year. In 2013, 234,000 ROVs were sold. If the proposed rule had been in effect that year, the total quantifiable cost would have been between \$14.3 million and \$22.0 million (\$61 and \$94 multiplied by 234,000 units, respectively). The total quantifiable benefits would have been at least \$515 million ($\$2,199 \times 234,000$). Of the benefits, about \$453 million (or about 88 percent) would have resulted from the reduction in fatal injuries, and about \$62 million (or about 12 percent) of the benefits would have resulted from a reduction in the societal cost of nonfatal injuries. About \$47 million of the reduction in the societal cost of nonfatal injuries would have been due to a reduction in pain and suffering. We conclude preliminarily that ROVs pose an unreasonable risk of injury and that the proposed rule is reasonably necessary to reduce that risk.

(g) *Public interest.* (1) This proposed rule is in the public interest because it may reduce ROV-related deaths and injuries in the future. The Commission believes that improving lateral stability (by increasing rollover resistance) and improving vehicle handling (by correcting oversteer to sub) are the most effective approaches to reduce the occurrence of ROV rollover incidents. ROVs with higher lateral stability are less likely to roll over because more lateral force is necessary to cause rollover. ROVs exhibiting understeer during a turn are also less likely to rollover because lateral acceleration decreases as the path of the ROV makes a wider turn, and the vehicle is more stable if a sudden change in direction occurs.

(2) The Commission believes that, when rollovers do occur, improving occupant protection performance (by increasing seat belt use) will mitigate

injury severity. CPSC analysis of ROV incidents indicates that 91 percent of fatally ejected victims were not wearing a seat belt at the time of the incident. Increasing seat belt use, in conjunction with better shoulder retention performance, will significantly reduce injuries and deaths associated with an ROV rollover event.

(h) *Voluntary standards.* (1) The Commission is aware of two voluntary standards that are applicable to ROVs, ANSI/ROHVA 1, *American National Standard for Recreational Off-Highway Vehicles* and ANSI/B71.9, *American National Standard for Multipurpose Off-Highway Utility Vehicles*. As described in detail in the preamble, the Commission believes that the current voluntary standard requirements not adequately reduce the risk of injury or death associated with ROVs. Neither voluntary standard requires that ROVs understeer, as required by the proposed rule. According to the ES staff, drivers are more likely to lose control of vehicles that oversteer, which can lead to the vehicle rolling over or to other types of accidents.

(2) Both voluntary standards have requirements that are intended to set standards for dynamic lateral stability. ANSI/ROHVA 1–2011 uses a turn-circle test for dynamic lateral stability that is more similar to the test in the proposed rule for whether the vehicle understeers than it is to the test for dynamic lateral stability. The dynamic stability requirement in ANSI/OPEI B71.9–2012 uses a J-turn test, like the proposed rule, but measures different variables during the test and uses a different acceptance criterion. However, ES staff does not believe that the tests procedures in either standard have been properly validated as being capable of providing useful information about the dynamic stability of the vehicle. Moreover, the voluntary standards would find some vehicles acceptable even though their lateral acceleration at rollover is less than 0.70 g, which is the acceptance criterion in the proposed rule.

(3) Both voluntary standards require that manufacturers include a lighted seat-belt reminder that is visible to the driver and remains on for at least 8 seconds after the vehicle is started, unless the driver's seatbelt is fastened. However, virtually all ROVs on the market already include this feature and, therefore, relying only on the voluntary standards would not be expected to raise seatbelt use over its current level.

(4) The voluntary standards include requirements for retaining the occupant within the protective zone of the vehicle in the event of a rollover including two options for restraining the occupants in

the shoulder/hip area. However, testing performed by CPSC identified weaknesses in the performance-based tilt table test option that allows unacceptable occupant head ejection beyond the protective zone of the vehicle Rollover Protective Structure (ROPS). CPSC testing indicated that a passive shoulder barrier could reduce the head excursion of a belted occupant during quarter-turn rollover events. The Commission believes that this can be accomplished by a requirement for a passive barrier based on the dimensions of the upper arm of a 5th percentile adult female, at a defined area near the ROV occupants' shoulder as contained in the proposed rule.

(i) *Relationship of benefits to costs.* (1) The estimated cost and benefits of the rule on an annual basis can be calculated by multiplying the estimated benefits and costs per unit by the number of ROVs sold in a given year. In 2013, 234,000 ROVs were sold. If the proposed rule had been in effect that year, the total quantifiable cost would have been between \$14.3 million and \$22.0 million (\$61 and \$94 multiplied by 234,000 units, respectively). The total quantifiable benefits would have been at least \$515 million (\$2,199 × 234,000).

(2) On a per unit basis, we estimate the total cost of the proposed rule to be \$61 to \$94 per vehicle. We estimate the total quantifiable benefits of the proposed rule to be \$2199 per unit. This results in net quantifiable benefits of \$2105 to \$2138 per unit. Quantifiable benefits of the proposed rule could exceed the estimated \$2199 per unit because the benefit associated with the vehicle handling and lateral stability requirement could not be quantified.

(j) *Least burdensome requirement.* The Commission considered less burdensome alternatives to the proposed rule regarding ROVs, but concluded that none of these alternatives would adequately reduce the risk of injury.

(1) *Not issuing a mandatory rule, but instead relying upon voluntary standards.* If CPSC did not issue a mandatory standard, most manufacturers would comply with one of the two voluntary standards that apply to ROVs. The Commission does not believe either voluntary standard adequately addresses the risk of injury and death associated with ROVs.

(2) *Including the dynamic lateral stability requirement or the understeer requirement, but not both.* The Commission believes that both of these characteristics need to be addressed. According to CPSC's Directorate for Engineering Sciences, a vehicle that

meets both the dynamic stability requirement and the understeer requirement should be safer than a vehicle that meets only one of the requirements. Moreover, the cost of meeting just one requirement is not substantially lower than the cost of meeting both requirements. The cost of testing a vehicle for compliance with both the dynamic lateral stability and vehicle handling/understeer requirement was estimated to be about \$24,000. However, the cost of testing for compliance with just the dynamic stability requirement itself would be about \$20,000, or only about 17 percent less than the cost of testing for compliance with both requirements together. This is because the cost of renting and transporting the vehicle to the test site, instrumenting the vehicle for the tests, and making some initial static measurements are virtually the same for both requirements and would only have to be done once if the tests for both requirements were conducted on the same day. Moreover, changes in the vehicle design that affect the lateral stability of the vehicle could also impact the handling of the vehicle. For these reasons, the proposed rule includes both a dynamic stability and vehicle handling requirement.

(3) *Loud or intrusive seatbelt reminders instead of seatbelt/speed limitation requirements.* (i) Currently, most ROVs meet the voluntary standards that require an 8-second visual seatbelt reminder. Some more intrusive systems have been used on passenger cars. For example, one system resumes warning the driver after about 65 seconds if his or her seatbelt is not fastened and the car is traveling at more than 3 mph. The system flashes a warning light and sounds a chime for 6 seconds every 30 seconds for up to 5 minutes so long as the car is operating and the driver's seatbelt is not fastened. A similar system is used in which the warning could last for longer than 9 minutes if the driver's seatbelt is not fastened. Although studies of both systems found an increase in the use of seatbelts, the systems' effectiveness was limited. Moreover, audible warnings are not likely to be effective in ROVs. ROVs are open vehicles and the ambient noise is higher than in the enclosed passenger compartment of a car. ROV drivers would not hear the warning and be motivated to fasten their seatbelts unless the warning was substantially louder than the systems used in passenger cars.

(ii) In contrast, these more intrusive seatbelt warning systems are unlikely to be as effective as the seatbelt speed limitation requirement in the proposed rule. The Commission believes that the

requirement in the proposed rule will cause most drivers and passengers that desire to exceed 15 mph to fasten their seatbelts. Research supports this position. One experiment used a haptic feedback system to increase the force the driver needed to exert to depress the gas pedal when the vehicle exceeded 25

mph if the seatbelt was not fastened. The system did not prevent the driver from exceeding 25 mph, but it increased the amount of force required to depress the gas pedal to maintain a speed greater than 25 mph. In this experiment all 7 participants chose to fasten their seatbelts.

Dated: October 31, 2014.

Todd A. Stevenson,
*Secretary, Consumer Product Safety
Commission.*

[FR Doc. 2014-26500 Filed 11-18-14; 8:45 am]

BILLING CODE 6355-01-P