

WHEELS AND WHEELING



Wheels and Wheeling

**THE SMITHSONIAN
CYCLE COLLECTION**

**Smith Hempstone Oliver
and Donald H. Berkebile**



SMITHSONIAN STUDIES IN HISTORY AND TECHNOLOGY • NUMBER 24

SMITHSONIAN INSTITUTION PRESS

City of Washington

1974

COVER: Smith Star bicycle of 1884, as restored by Henry W. Mathis of the Southeast Cycle Shop in 1960. Rider is *Smithsonian* magazine staff member Meredith White Riegle. Photo appeared on the cover of the February 1972 issue of the magazine.

FRONTISPIECE: This photo, from about 1888, shows the Copeland steam-propelled tricycle in front of the Smithsonian building on the Mall. Driver of the tricycle is its inventor, Lucius D. Copeland; the passenger is Frances Benjamin Johnston, who later became a noted Washington photographer. Standing to the left are patent attorney B. C. Poole and an associate, and the builder and promoter of the tricycle, Sandford Northrop. To the right are E. H. Hawley of the Smithsonian staff, W. H. Travis, and J. Elfreth Watkins, curator of the section of transportation in the Smithsonian's U.S. National Museum, 1885–1903.

OFFICIAL PUBLICATION DATE is handstamped in a limited number of initial copies and is recorded in the Institution's annual report, *Smithsonian Year*. SI PRESS NUMBER 4793.

Library of Congress Cataloging in Publication Data

Oliver, Smith Hempstone.

Wheels and wheeling: The Smithsonian Cycle Collection
(Smithsonian studies in history and technology, no. 24)

First published in 1953 under title: Catalog of the cycle collection of the
Division of Engineering, United States National Museum.

Bibliography: p.

1. Bicycles and tricycles—Catalogs. 2. Motorcycles—Catalogs. 3. National Museum of History and Technology. I. Berkebile, Donald H., joint author. II. Title. III. Series: Smithsonian Institution. Smithsonian studies in history and technology, no. 24.

TL410.043 1974 388.34'7'09034 73–16103

CONTENTS

	PAGE
Development of the Bicycle	1
The Smithsonian Cycle Collection	25
30 HOBBY HORSE, ABOUT 1818	
31 HOBBY HORSE OF 1818 (REPRODUCTION)	
32 VELOCIPEDE, ABOUT 1868	
33 VELOCIPEDE, ABOUT 1868	
34 VELOCIPEDE, ABOUT 1869	
35 VAN ANDEN DEXTER VELOCIPEDE, 1869	
36 LAUBACH VELOCIPEDE, 1869	
38 ROPER STEAM VELOCIPEDE, ABOUT 1869	
40 GREENE AND DYER MONOCYCLE, 1869	
42 ADULT'S TRICYCLE, ABOUT 1875	
43 CHILD'S TRICYCLE, 1876	
44 UNZICKER TRICYCLE (MODEL), 1878	
45 SHIRE VELOCIPEDE, 1879	
46 VELOCIPEDE, ABOUT 1879	
47 HAMMELMANN TRICYCLE (MODEL), 1880	
48 FOWLER TRICYCLE (MODEL), 1880	
49 LONG STEAM TRICYCLE, ABOUT 1880	
52 STANDARD COLUMBIA ORDINARY, 1881	
53 KLAHR BICYCLE (MODEL), 1883	
54 SMITH STAR BICYCLE, 1884	
55 BOY'S ORDINARY, 1885	
56 COLUMBIA LIGHT ROADSTER ORDINARY, 1886	
57 OVERMAN VICTOR ORDINARY, ABOUT 1886	
58 HUMBER "GENUINE BEESTON" RACING ORDINARY, 1886	
59 STARLEY PSYCHO SAFETY BICYCLE, ABOUT 1887	
60 RUDGE RACING ORDINARY, ABOUT 1887	
61 TWO-TRACK TRICYCLE, ABOUT 1887	
63 COLUMBIA LIGHT ROADSTER ORDINARY, 1888	
64 SMITH TRICYCLE, 1888	
65 ST. GEORGE'S NEW RAPID BICYCLE, 1889	
66 OVERMAN VICTORIA BICYCLE, 1889	
68 SMITH PONY STAR BICYCLE, 1891	
69 COLUMBIA MODEL 41 BICYCLE, 1896	
71 COLUMBIA MODEL 43 TANDEM BICYCLE, 1896	
73 CHILD'S SAFETY BICYCLE, ABOUT 1897	
74 CLARKE GASOLINE TRICYCLE, 1897	
76 REX CYCLE, 1898	
78 PIERCE BICYCLE, ABOUT 1900	
80 ANDERSON "MILITARY BICYCLE," ABOUT 1900	
82 WABASH CHILD'S IRISH MAIL QUADRICYCLE, ABOUT 1900	
83 INDIAN MOTORCYCLE, 1902	
85 HARLEY-DAVIDSON MODEL 9-B MOTORCYCLE, 1913	
87 POPE MODEL L MOTORCYCLE, 1913	
89 CLEVELAND MOTORCYCLE, 1918	
91 AUTOPED MOTOR SCOOTER, 1918	
93 IVER JOHNSON BICYCLE, 1925	
94 SNYDER BICYCLE, 1927	
95 REINHARDT BICYCLE, 1935	
97 SIMPLEX SERVI-CYCLE, 1935	
98 WHALEN AND JANSSEN LAMINATED-WOOD- FRAME BICYCLE, 1942	
99 RALEIGH BICYCLE, ABOUT 1949	
101 SCHWINN VARSITY TOURIST BICYCLE, 1965	
102 SCHWINN SUPER DELUXE STING-RAY BICYCLE, 1965	
Bibliography	103

DEVELOPMENT OF THE BICYCLE

The bicycle, with a history that spans nearly two centuries, has frequently been looked upon in the United States as a child's plaything. Recent trends seem to indicate that Americans may come to follow the example of those other nations where the bicycle is an important means of transportation, extensively used by businessmen and workers traveling to and from their jobs. In the United States, during the late 19th century, the cycle's greatest use was likewise among adults, and this use sparked the early good-roads movement. Of equal importance was the role of the bicycle in demonstrating the possibilities of independent personal transportation, thus creating a demand that facilitated the introduction of the automobile.

The first known bicycle was shown by the Comte de Sivrac, who in 1791 was seen riding a two-wheel "wooden horse" in the gardens of the Palais Royal in Paris. Called a *célérierifère*, the machine had two rigidly mounted wheels, so that it was incapable of being steered. To change direction, it was necessary to lift, drag, or jump the front wheel to one side. In 1793 the name was changed to *vélocifère*, and, as these machines became increasingly popular among the sporting set of Paris, clubs were formed and races were run along the Champs Elysées.

At some time during the first decade of the 19th century the *vélocifère* lost favor temporarily until, in 1816, Nicéphore Niepce of Chalons, better known as the "Father of Photography," demonstrated an improved type in the Luxembourg Gardens. Niepce's machine, still not steerable, was considerably lighter, and the larger wheels helped smooth the ride and permitted greater speed.

A revolutionary improvement in the *vélocifère* occurred in 1817, when Charles, Baron von Drais, of Sauerbrun, devised a front wheel capable of being steered. As chief forester for the Grand Duke of Baden, von Drais found the machine useful in traversing the forest land under his supervision. He also gave it a padded saddle, and an armrest in front of his body, which assisted him in exerting force against the ground. Granted a patent in 1818, he took his *Draisienne* to Paris, where it was again patented and acquired the name *vélocipède*, a term that was to continue in use until about 1869 when the word "bicycle" came into use.

The velocipede gained rapid popularity in France, and almost immediately migrated to England, where it was known variously as a

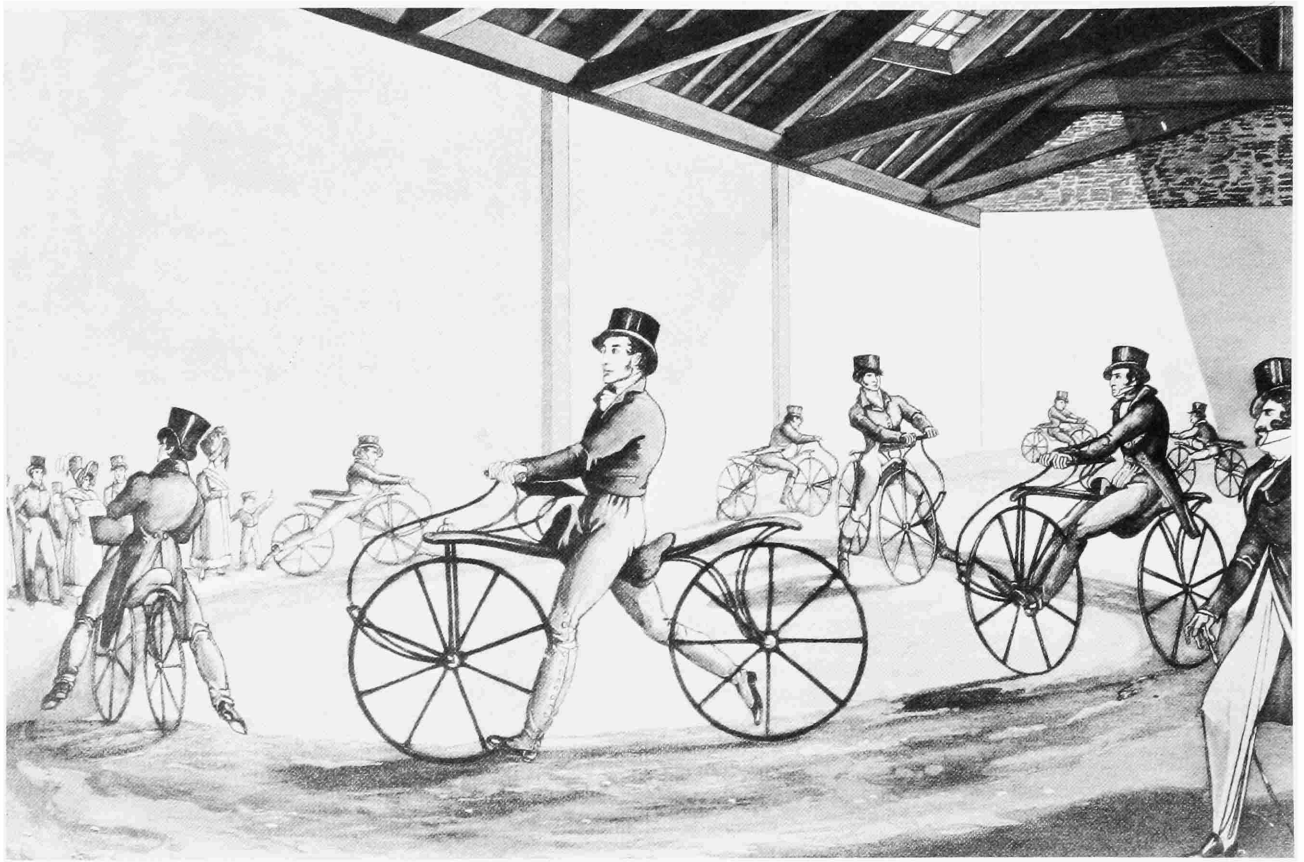

"Johnson's Pedestrian Hobby Horse Riding School in London," an 1819 aquatint by H. Alken.



"The Ladies' Hobby, 1819," contemporary aquatint showing a hand-and-foot-operated tri-cycle.

Draisine, Swiftwalker, Hobby Horse, Dandy Horse, or Pedestrian Curricule. In England one of its chief exponents was the London coachmaker, Denis Johnson, who not only added improvements, but even designed a woman's drop-frame model. Riding academies were established to teach the fine points of balance and management, and soon many riders were seen in the streets and parks about London; yet the pastime declined almost as rapidly as it had risen, and after the early 1820s velocipedes were rarely seen.

In the United States, W. K. Clarkson, Jr., of New York, was granted a patent for a velocipede on 26 June 1819, but it is no longer known what this patent covered, for the records were destroyed in the Patent Office fire of 1836. There is no evidence that the sport gained much popularity here, yet it is known that Charles Willson Peale, the noted American portrait painter, was an enthusiastic rider of one in 1819, at the age of 78.

As early as 1819 attempts were made to have mechanical devices assist the rider in propelling the velocipede, but these efforts failed due to over-complication. Lewis Gompertz, of Surrey, England, in 1821 developed a workable device whereby the steering handle was pulled backwards to work a toothed quadrant against a pinion on the front hub, the pinion containing a free-wheeling device that permitted the handle to return to its forward position.

Then followed a lengthy period of inactivity in velocipede development and use, punctuated by only one significant improvement.

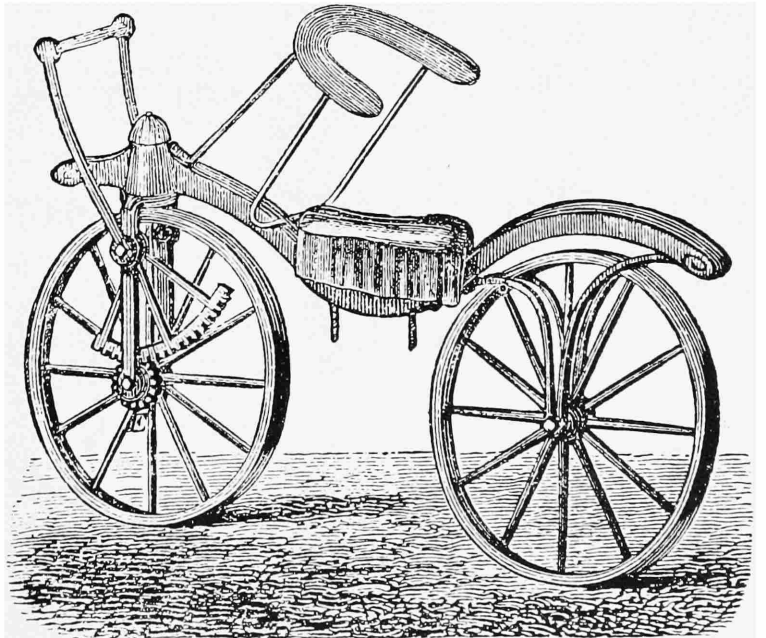

Hand-operated velocipede designed in 1821 by Gompertz in England. From J. T. Goddard, The Velocipede: Its History, Varieties, and Practice (Cambridge: Riverside Press, 1869), page 11.

This fier of 1869, advertising the Lallement velocipede, is from the scrapbook, now in the Museum's collection, of Charles E. Pratt, first president of the League of American Wheelmen.

THE PATENT VELOCIPEDE MANUFACTORY
P. LALLEMENT
 ORIGINAL PATENTEE AND MANUFACTURER

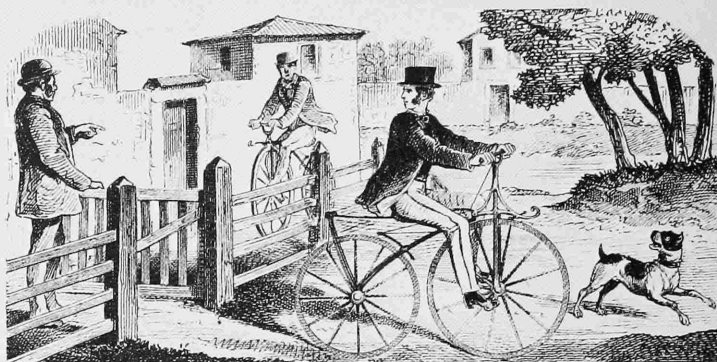

OFFICES & WHAREHOUSE: 79, Avenue de Wagram. 79 PARIS
 WHOLESALE: Retail and for Exportation
 STEAM WORKS: In the Ardennes NEAR CHARLEVILLE

PRICE LIST FOR 1869

N ^o	BICYCLE OR TWO WHEELS	HEIGHT	PRICE
1	STRONG WROUGHT IRON, fitted with Break, Iron Pedals, Turning in Brasses, Grease Boxes and Leather Saddle. (Good Quality)	2 10 3 00 3 2	6 10 0
2	SAME MODEL, Extra Finish, — Varnished Wheels, — Polished Steel, Bronze Pedals		8 0 0
3	SAME MODEL, Best quality. — Highly Finished.		10 0 0



An 1869 Pickering velocipede in a rare contemporary photo that shows the rear saddle brace supported by a spring, so that a backward movement of the rider's body brings a brake-shoe down against the rear wheel.

This was the treadle-operated machine of the Scottish blacksmith, Kirkpatrick Macmillan, who in 1839 attached cranks to the rear axle of a velocipede, and turned them by means of treadles hung from the front of the frame. Macmillan's velocipede performed well, operating at between ten and fourteen miles an hour, yet he is not known to have sold any, and his work was copied to only a limited extent. One of the copiers was another Scot, Gavin Dalzell, who moved the treadles slightly to the rear in 1845, so that they were more nearly under the operator.

An important milestone in velocipede development was the addition of pedals to the front axle. This occurred in Paris about 1863 in the workshop of Pierre Michaux, but to this day it cannot certainly



A veloped riding school as depicted in the frontispiece to volume 10 (1869) of The New York Coach-Maker's Magazine.

be said whether he or his employee Pierre Lallement is entitled to the credit. The use of the veloped increased modestly but steadily in Paris during the mid-1860s, but the disgruntled Lallement left Michaux and took up residence in New Haven, Connecticut. Here, on 20 November 1866, he was granted U.S. Patent 59,915, covering an "improvement in velopedes." The patent drawing reveals a saddle attached to a spring mounted above the frame of the machine, as well as weighted, pivoting pedals.

The Hanlon brothers of New York City, a popular team of traveling acrobats, on 7 July 1868 were granted Patent 79,654 for an improved version of the Lallement vehicle, their patent covering adjustable pedals and seat. In addition, they suggested that rubber

TO W^M P. SARGENT & CO.

VELOCIPEDS



GALOP. 5

BOSTON.

Published by KOPPIZ, PRÜFER & CO. 30 West Ch. Mason Street.

NEW YORK.

W^M A POND & CO.

rings could be used on the wheels to make them noiseless and to prevent their slipping. Here was an early use, suggested at least, of the rubber tire. Another Hanlon patent (No. 86,834, granted 9 February 1869) covered a mudguard over the front wheel, and a brakeshoe operating against a wheel and controlled by twisting the handlebars. The Hanlon machine helped promote the velocipede in America, and, oddly, in Great Britain, where an illustration was shown in the *English Mechanic* in 1868, though the French machines were known there slightly earlier.

Americans paid little attention to the velocipede for several years after Lallement's patent, but in December of 1868 began to show an immense enthusiasm for it. By early 1869 a number of carriage builders were making cycles, since the services of the blacksmith and wheelwright were essentially those required. Likewise, numerous riding schools were established in many of the eastern cities, and the sport of riding became suddenly popular, especially among the students of Harvard and Yale Universities. "Boneshakers," as velocipedes came to be known, were at first priced around 125 dollars, though before long cheaper models were available for as little as 75 dollars, still a rather costly novelty for 1869. They were usually brightly finished in red, blue, white, etc., frequently with heavy striping that was similar to that of horse-drawn commercial vehicles. Iron parts of the better machines were not plated, but were sometimes highly burnished, and polished bronze castings were also evident. Early in 1869 J. T. Goddard published his manual *The Velocipede*, and in the same year W. C. King edited a journal entitled *The Velocipedist*.

The craze ended as suddenly as it had begun. By the end of May in 1869 the sport was dying, and by August the *Coach-Makers' International Journal* was advising its readers that the bicycle was a drug on the market in New York, where machines that would normally be selling for 75 dollars were bringing no more than 12. The reasons for the decline were that the cycles were heavy and cumbersome, and the rider's position far behind the pedals created an awkward angle of thrust for the legs, which tended to push him back and away from the pedals when the going became heavy. The final blow came when cities began to pass ordinances against cycle riding on pedestrian walks, and the roads of the period did not encourage riders to prove the reason why their machines were called **boneshakers**. Further use and development in the United States remained nearly at a standstill during the 1870s.

At least one early inventor, S. H. Roper, of Roxbury, Massachusetts, constructed a steam-powered velocipede, and his machine (now in the collections of the National Museum of History and Technology) appeared about 1869 at fairs and circuses in New England. Resembling a Hanlon-type velocipede, with wooden wheels and iron tires, the machine is described and illustrated on pages 38–39.

A number of poems and songs such as this were published during the brief reign of the velocipede in the late 1860s.



Alfred D. Chandler of Boston, an early American rider of an Ordinary, shown on the Duplex-Excelsior he purchased from Timms & Lawford, of Baltimore, at the close of the Philadelphia Centennial Exposition. Photo was made in 1877.

Participants in one of America's first organized bicycle tours lined up with their Ordinaries on the road outside Readville, Massachusetts, 11 September 1879. The first rider is Charles E. Pratt, noted bicycle author, coorganizer, and first president of the League of American Wheelmen, and later attorney for the Pope Manufacturing Co. The second man is Col. Albert A. Pope, president of the famed company bearing his name, manufacturer of the Columbia bicycle.

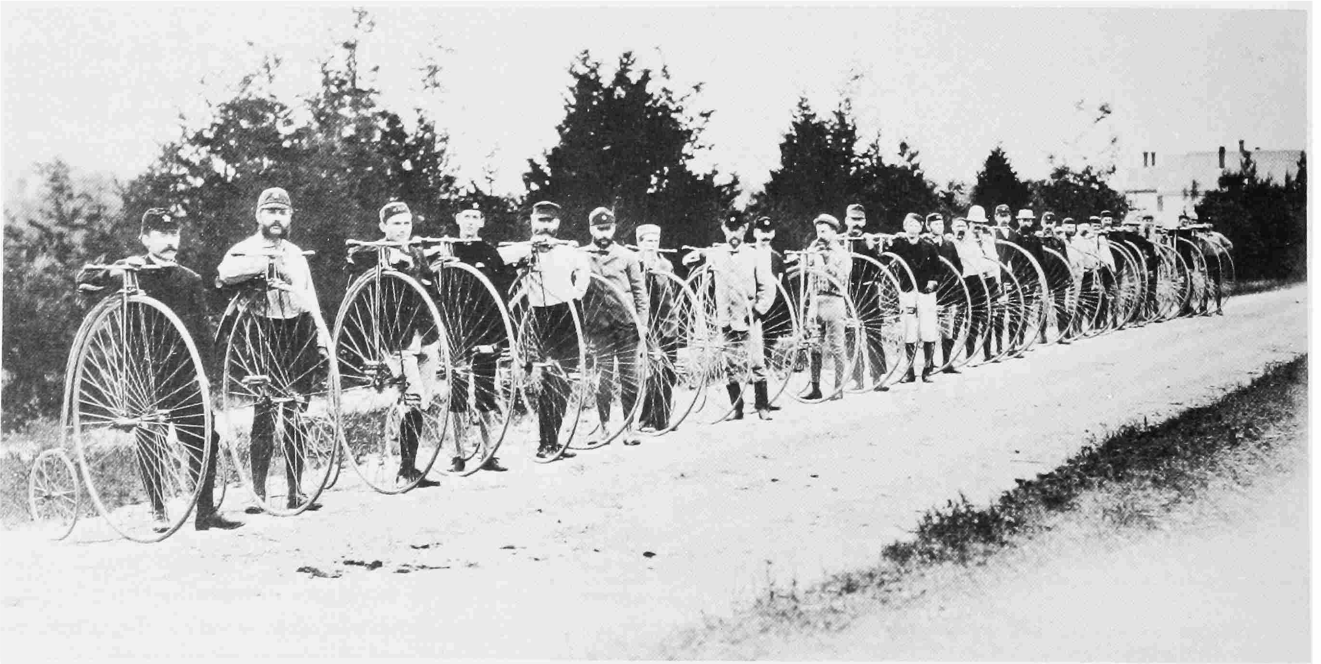

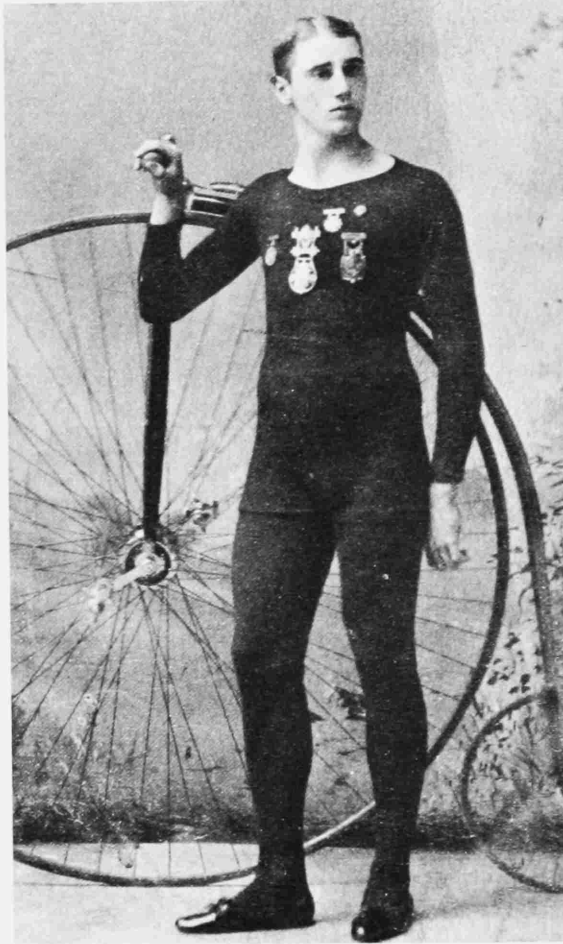

George M. Hendee, American amateur champion racer, 1883-1885, with his 55-inch Rudge. In 1901 his Hendee Manufacturing Co. began the manufacture of a motorcycle designed by another noted bicycle racer, Oscar Hedstrom. The firm was later renamed the Indian Motorcycle Co. Photo is from the scrapbook, now in the Museum's collection, of Abbot Bassett, secretary, 1887-1924, of the League of American Wheelmen.



The man astride the 1882 Columbia Expert in this posed studio portrait is believed to be W. H. Miller, of Columbus, Ohio, second president of the League of American Wheelmen. The young boy, possibly his son, is on a child's Ordinary of unknown manufacture. Uniforms such as they are wearing were commonly used by bicycle club members.

The English also began to use the velocipede in the late 1860s, but unlike the Americans, they did not develop an initial wild enthusiasm, nor did the sport there die a sudden death. Instead, a rapid development of the bicycle began, and England soon took the lead away from France, where unfortunately the Franco-Prussian War arrested cycle development in 1870, though French innovations of 1869 showed them to have been clearly in the lead. At a Paris bicycle show in November of 1869, for example, were seen such radical features as wire wheels, solid rubber tires, tubular frames, front-wheel brakes, mudguards, and primitive types of change-gears. The French are also credited with having in 1869 a chain-driven bicycle, and one of the high-wheel variety.

By the early 1870s, bicycles and tricycles using wire-spoke wheels were commonly seen, notably in England. James Starley of Coventry was one of the pioneers in this field, and, until his death in 1881, fathered many new and ingenious features pertaining to cycling, earning for himself the title "Father of Cycle Industry." His famous Ariel, introduced in 1871, a high-wheel bicycle with wire spokes, was to be

Few ladies rode Ordinaries, but some of the more competitive types excelled as riders. Annie Sylvester (left) was a noted trick and fancy rider in 1885. Louise Armaindo, shown here (right) with her full-nickeled Royal Mail, was famed as a racing and long-distance rider who defeated men and women alike. From The Springfield Wheelmen's Gazette of, respectively, April and February 1885.

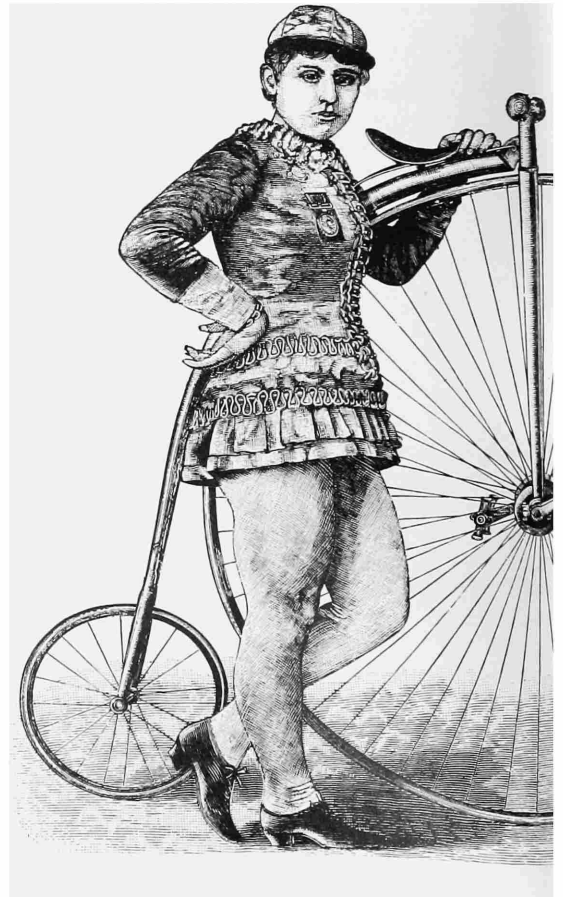

A tricycling family (top) from Lowell, Massachusetts, on wheels in 1885. Junior will learn how later. The 1887 Boston-area tour (center) shows a variety of cycles, single and tandem tricycles, an Ordinary, and a Sociable (see eleventh and twelfth persons from left). In another 1887 tour (bottom), this one from Swampscott, Massachusetts, all are riding tandem tricycles. Seen in the wagonette is the style-setting 1886 Rover Safety Dwarf Roadster, manufactured by the English firm, Starley & Sutton, of Coventry. All photos from the Abbot Bassett scrapbook.



AMERICAN BICYCLE LAMPS.

Manufactured Expressly for us.

These lamps are unquestionably the best in the market. They are strongly made, riveted or locked (instead of soldered), and they are a thorough piece of workmanship. Being of large size they throw a very powerful light, and they are provided with red side lights. The improvements are: Wind up burner by which the light may be regulated from the outside, to avoid the annoyance of opening the lamp. Adjustable axle bearings or attachments, adjustable for length and diameter of axle without difficulty on the part of the purchaser.

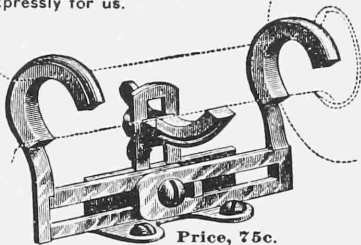

Price, 75c.

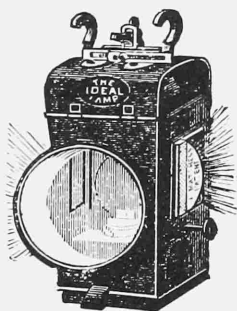

THE IDEAL LAMP

Will fit all sizes from 30 inch upwards, or any other make of boy's or youth's bicycle. See cut.

Price, japanned \$2.25
" nickeled 3.00

The Challenge Lamp

Fits any size except smaller sizes of "Ideal." See cut.

Price, japanned \$3.00
" nickeled 3.75

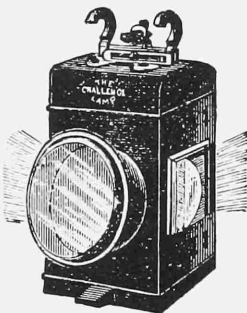

The Champion Lamp

Fits any size over 50 inch. See cut.

Price, japanned \$5.00
" nickeled 6.00

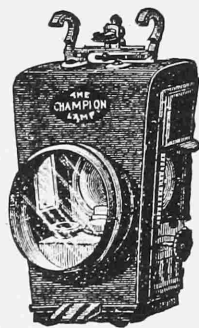

Ideal Tricycle Lamp.

Useful also as a bicycle head lamp.

Price, japanned \$2.25
" nickeled 3.00

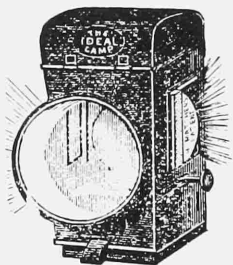

In 1887, an oil lamp of this type could be suspended from the hub, inside the front wheel, of an Ordinary for night tours, as shown on the Columbia advertising card (right).

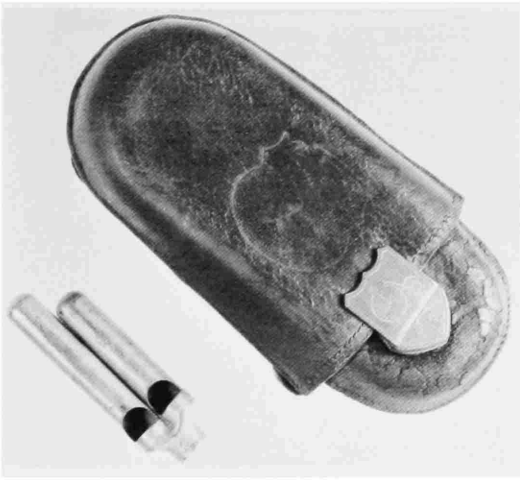

Important cycling accessories of the 1880s, from the Museum's collection, were this warning whistle and the telescoping tool case, the latter being suspended under the saddle.

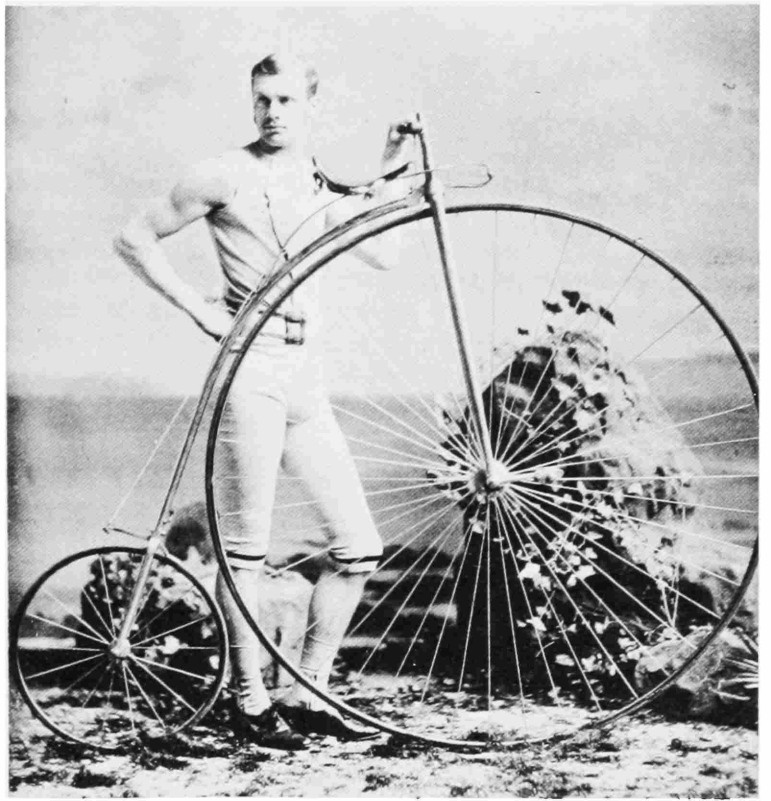

M. W. Wright, famous English bicycle racer of the 1870s, with his Arab Ordinary. Note the rear-wheel brake.

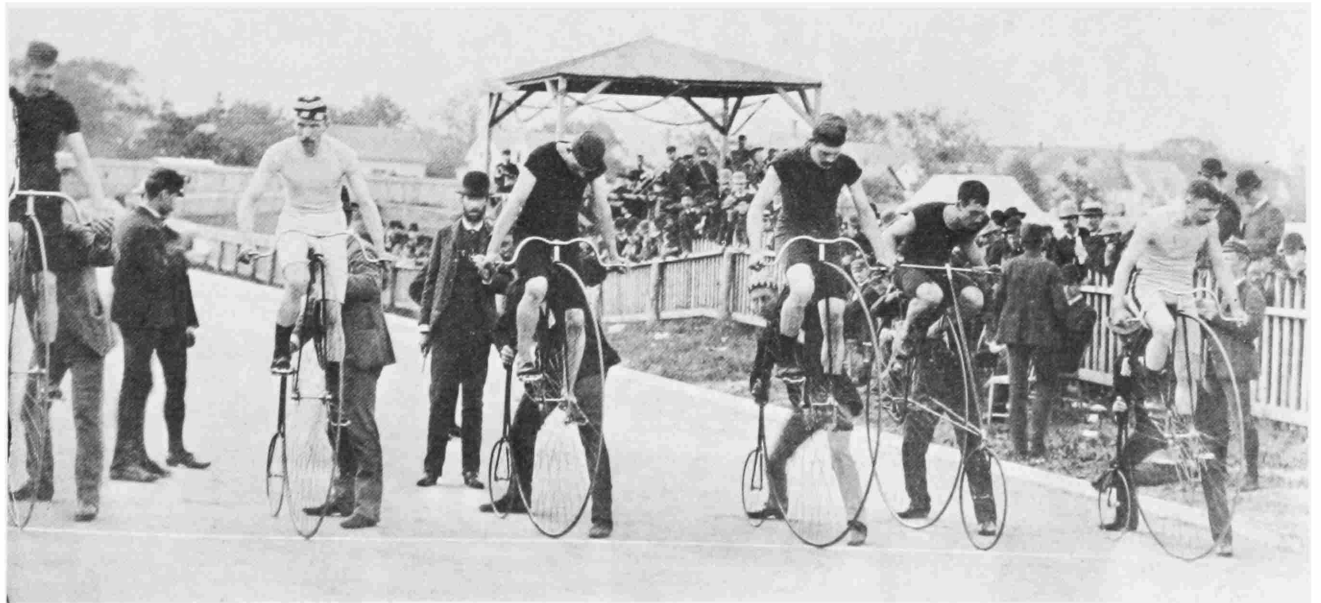

A group of professional racing cyclists at Springfield, Massachusetts, in 1886. From Abbot Bassett scrapbook.

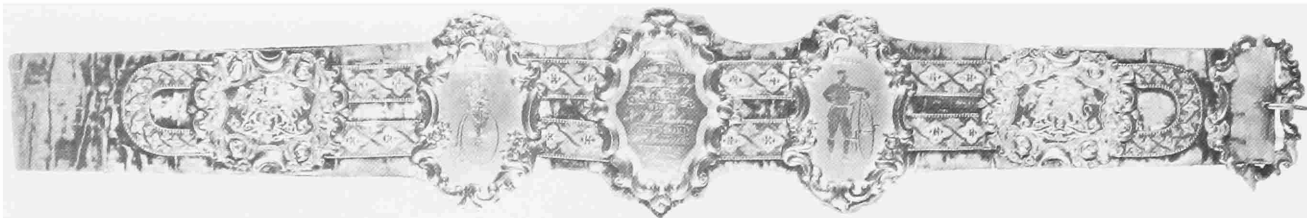

This silver-and-velvet 6-day bicycle championship belt of Scotland now in the Museum's collection was won at Glasgow on 19 June 1880 by H. W. Higham of Nottingham.



A pair wearing the uniforms of Washington's Capitol Bicycle Club (left), pedal along on a Sociable, or side-by-side tricycle, in the 1880s. The fashionable couple (right), photographed behind the White House in Washington, D.C., ride what appears to be a Club (Coventry Machinists' Co., Ltd.) tandem convertible quadricycle roadster of about 1885. It could be converted into a single tricycle by separating it in the center, and detaching either the front or the rear portion.

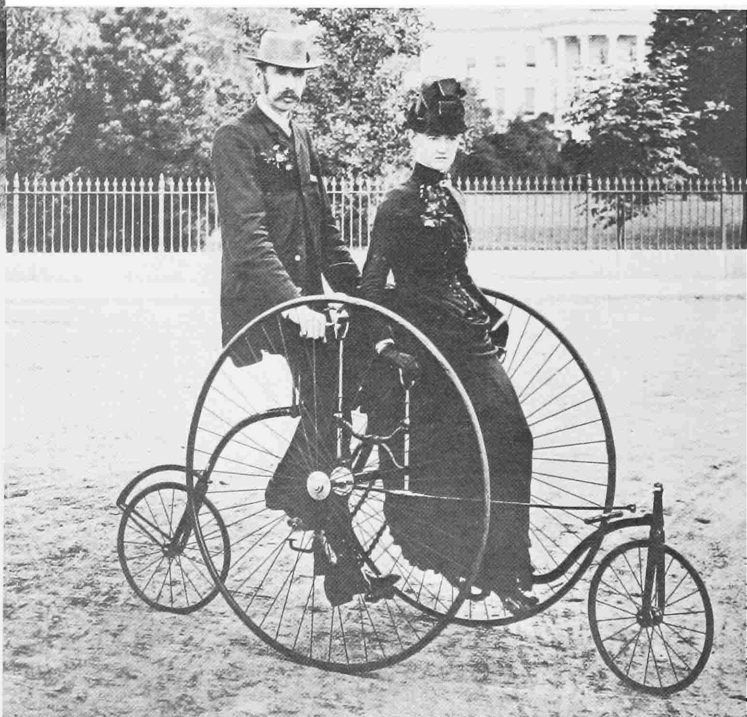

copied for two decades. Its design offered higher speed through the greater circumference of the large front wheel, while putting the rider more directly over the pedals. This type, rapidly improved by Starley and others until it became, in comparison to the old bone-shaker, a comfortable, lightweight machine, gained quick popularity and eventually became known as an "Ordinary."

At the Centennial Exposition at Philadelphia in 1876, several English firms exhibited these Ordinaries. At the close of the Exposition the unsold Ordinaries were taken by the Baltimore firm of Timms and Lawford, and most of them were soon sold to the newly organized Cunningham Co., of Boston, Massachusetts, which, in



Though a Columbia sign appears in the background and the man in this picture also appears on the back of an 1883 Columbia catalog (riding a different tricycle), the machine shown here does not appear to have been a regular Columbia model. It is probably an experimental Columbia, an English tricycle, or half of an English convertible quadricycle.

A Georgetown, D.C., tricycling tradesman, believed to have been photographed about 1941. The machine is an 1884 Victor Rotary, made by the Overman Wheel Co., Chicopee, Massachusetts.



"Wheeling on Riverside Drive," a wood engraving appearing in Harper's Weekly, 17 July 1886. The machine in the foreground is a Sociable.

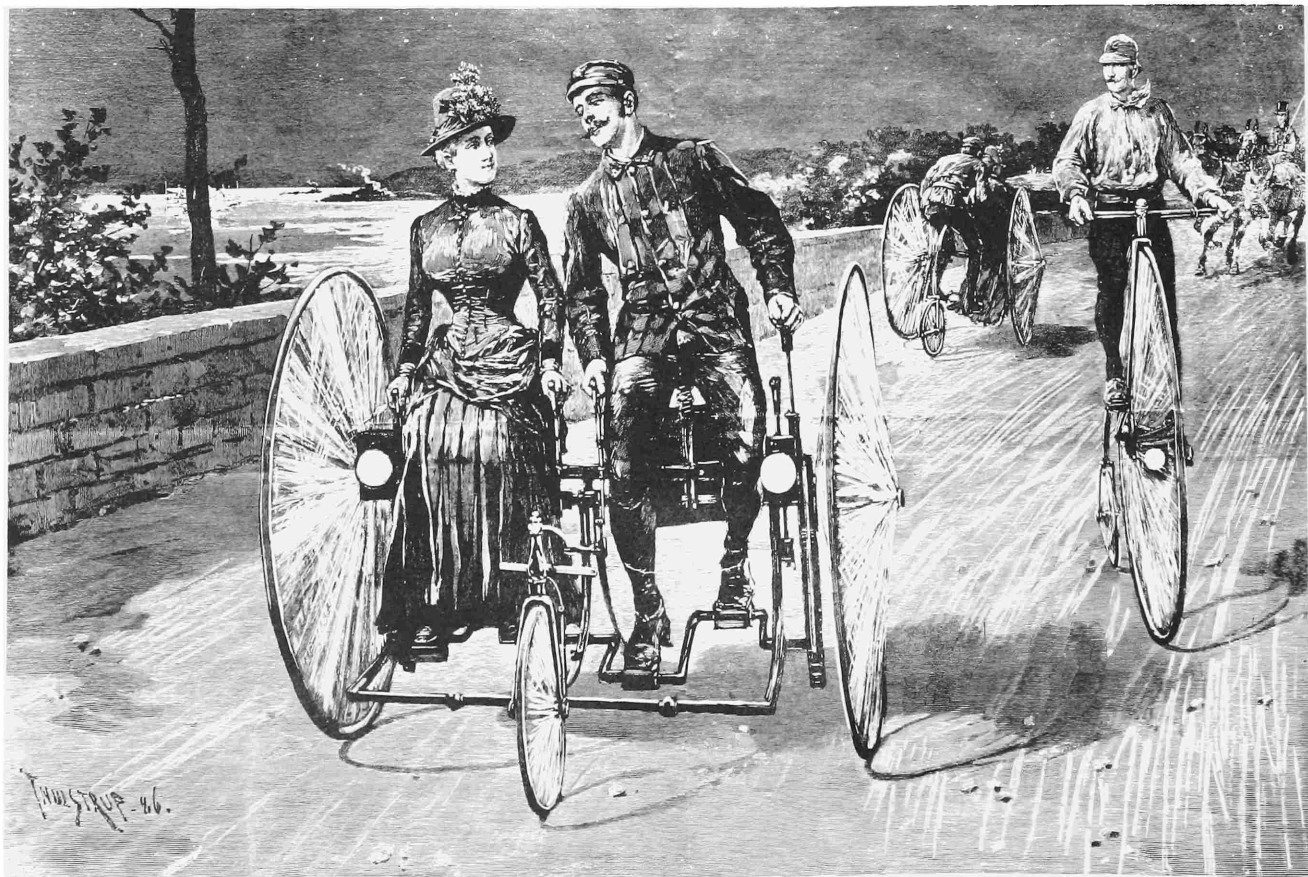

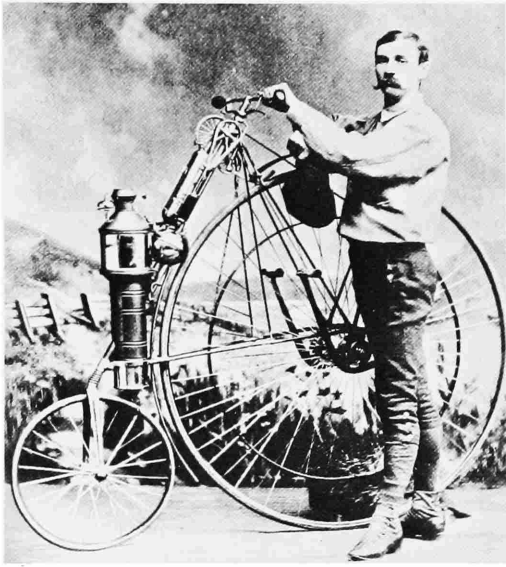

Lucius D. Copeland with his steam-driven Star bicycle, which he operated successfully in the mid-1880s. The engine and boiler of this vehicle are in the Arizona Museum at Phoenix.

1877, was the first bicycle-importing firm in America. In the same year Albert A. Pope also began importing English bicycles, and in 1878 his company, as the Pope Manufacturing Co., of Boston, became the first manufacturer of bicycles in America. In that year Pope began building bicycles under the trade name "Columbia" in the factory of the Weed Sewing Machine Co. at Hartford, Connecticut, and by 1895 all of his interests were concentrated in that city, including the offices formerly located in Boston.

In Boston during 1877, Frank W. Weston began publication of *The American Bicycling Journal*, which two years later was merged with *The Bicycling World*, also of Boston. As many of the early bicycle riders in America were Bostonians, and since the first bicycle club in America was the Boston Bicycle Club, jointly founded by Charles E. Pratt and Frank W. Weston on 11 February 1878, Boston soon became the center of bicycling in this country.

The Ordinary, or high-wheel bicycle, was especially hazardous, since the rider's center of gravity was only slightly behind the large front wheel and the rider was in danger of taking what came to be called a "header." This common accident occurred when the front wheel struck an obstruction in the road, or when the brake was applied too quickly, causing the rider to be thrown head-first onto the road, as his cycle tipped over forward. Serious injury, and occasionally even death, resulted. Partially because of the Ordinary's height, few women were attracted to riding, yet there were some who not only rode, but even became known as racers. Soon, the costume of both men and women was modified to suit the sport.

Because of the Ordinary's inherent danger, early efforts were made to design a safer bicycle. Many of these efforts were modifications of the high-wheeler, with the large wheel slightly reduced in size, and the speed thus lost being compensated for by the use of such indirect-drive methods as chains, levers, or other mechanical devices. The rider's center of gravity was also shifted slightly backward.

In the United States, one of these early efforts produced the well-known Star bicycle, which had the large wheel in the rear, driven by treadles instead of pedals. This design eliminated the danger of taking headers, and became relatively popular, though it never approached the popularity of the Ordinary.

Lucius D. Copeland, in 1884 or 1885, equipped one of these Stars with a small steam engine and a boiler, and successfully operated the machine. Two or three years later a tricycle was similarly equipped for Copeland by the Northrop Manufacturing Co., of Camden, New Jersey. Articles on these machines appeared in many engineering magazines of that time, and Sandford Northrop issued advertising brochures publicizing the formation of his Moto-Cycle Manufacturing Co. (of which J. Elfreth Watkins, then curator of the Smithsonian's section of transportation, was president), but the venture proceeded no further. It was, nevertheless, another one of the many

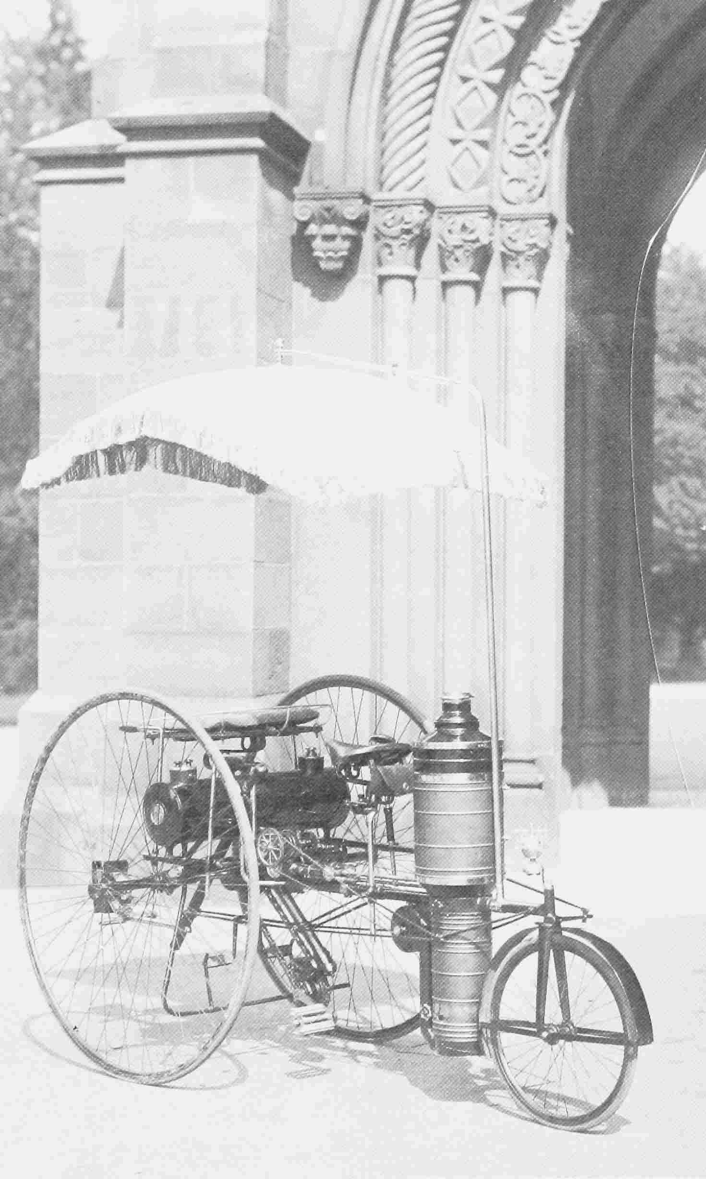

On the Copeland steam tricycle, shown also in the frontispiece, the passenger sat directly in front of the operator, over the tank holding fuel and water (see photo, right). A headlamp was mounted on the passenger's footrest. The operator sat with his back against the boiler (left photo), steering by means of the single rear wheel, over which a jingling warning bell was mounted.

pioneer attempts in America to produce a commercially successful self-propelled vehicle.

While on the subject of self-propelled vehicles, it would be appropriate to mention that the early efforts of the German inventors, Gottlieb Daimler and Karl Benz, are in reality a part of cycle history. In 1885 Daimler produced a two-wheel, gasoline-powered velocipede, while Benz produced in 1886 a large gasoline-powered tricycle with wire-spoke wheels, the single front one being the steerable wheel.

The back of this photo of an unidentified quadricycle carries the name of the Moto-Cycle Manufacturing Co. Possibly it was a vehicle which the firm had hoped to motorize with one of Copeland's steam engines.



A group of early Safeties and a Star (far left) on an 1889 Boston area tour. Those with wood wheels are believed to have been made by The Sterling Cycle Co., Newton, Massachusetts. From Abbot Bassett scrapbook.





Arthur A. Zimmerman, noted American bicycle racer of the early 1890s, with his trainer. From Abbot Bassett scrapbook.

Simultaneously with efforts to make the high-wheeler safer by means of modifications came other efforts to completely redesign the bicycle into what became known as the “Safety.” In England, H. J. Lawson produced his Bicycleette in 1879, this being a comparatively low-profile safety design, with a chain-driven rear wheel and indirect steering. Unattractive, and apparently too far advanced for its time, the Bicycleette was a commercial failure.

By the mid-1880s, a number of British manufacturers were producing various types of Safety bicycles, the object of which was to bring the rider closer to the ground. The most successful were the several machines of John Kemp Starley (nephew of James Starley), whose third model Rover of 1885, with chain drive, diamond frame, and low wheels, influenced bicycle design to the present day. Curiously, this was a return, after many years of evolution, to the proportions of the old Hobby Horse, which also had two wheels of equal or nearly equal size.

Soon after the advent of the Safety bicycle, another important development assured the success and popularity of the bicycle. In 1888 and 1889, John Boyd Dunlop, a veterinary surgeon of Belfast, Ireland, obtained English patents on a pneumatic tire, and in 1890, a United States patent. Despite criticism and ridicule, the increase in



“Have Dinner at One, Dear.” Stereoscopic view, from 1897, of women’s lib on a bicycle—which happens to be a man’s Safety.

speed and comfort quickly established the value of Dunlop's invention, and the pneumatic tire rapidly gained acceptance in the United States during 1891 and 1892.

Another important improvement was the development of the coaster brake. By 1898, bicycles were occasionally being equipped with braking mechanisms that were associated with the driving systems, whereby the brake was operated by a backward pressure on the pedals. In most instances, however, these devices did not include coasting or free-wheeling features. During 1898, free-wheeling brakes began to appear, and the added safety and convenience provided by this innovation caused it to gain quickly in popularity.

The closing years of the century offered one final mechanical advancement, this being a multiple-speed driving system. The idea was

An early group of Safety cyclists using rail attachments to enjoy a smooth ride on a spur line of the Pittsburgh and Western Railroad, between Cluffs Mills and McCrays, Pennsylvania, in the 1890s.

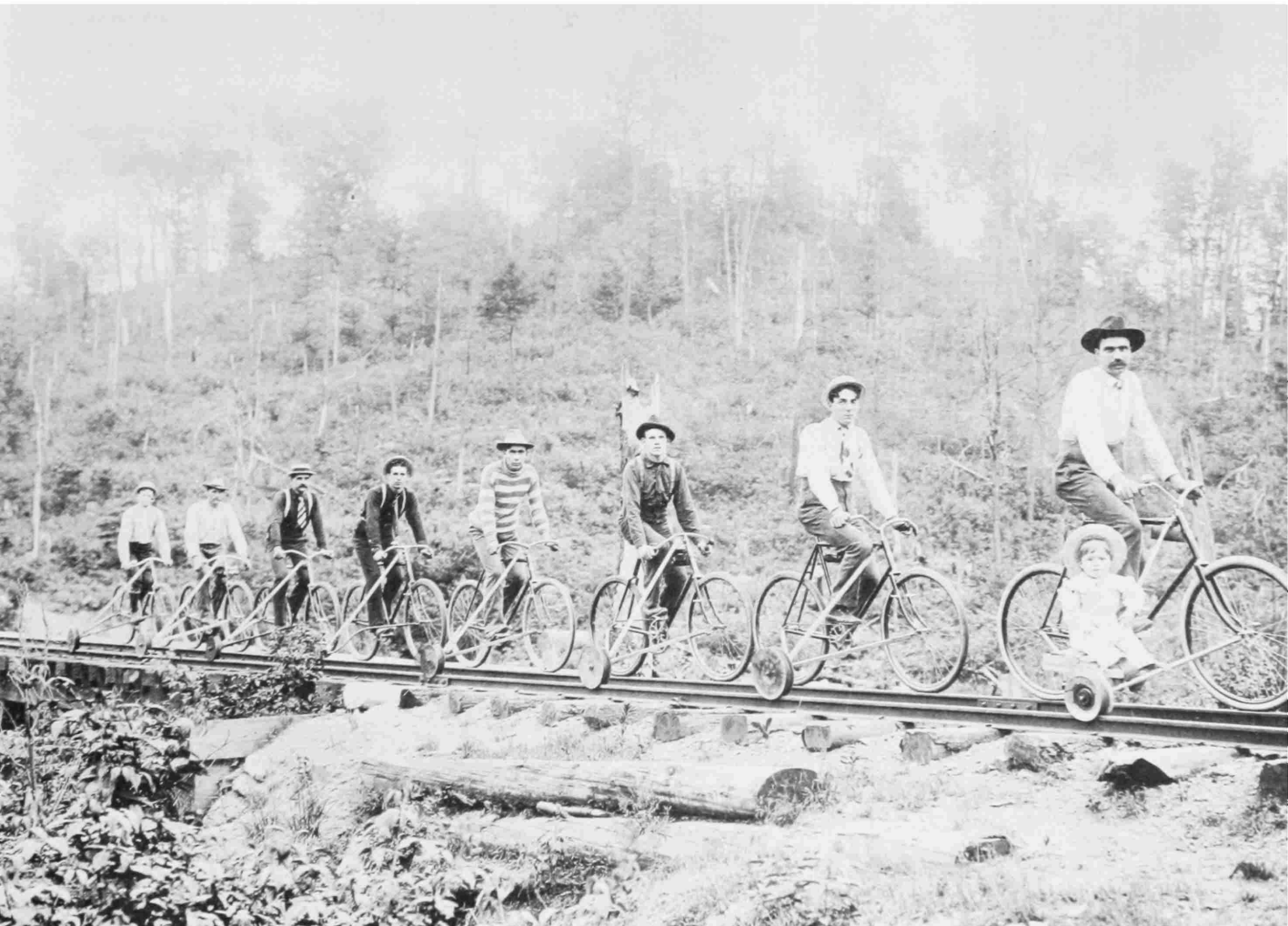



Medals, in the Museum's collection, awarded to Frederick L. Oliver, father of coauthor Smith Hempstone Oliver, for racing events in 1897.

not new, it having been applied years earlier in more unsophisticated forms, such as the device that changed the operative length of the Star bicycle's treadle-levers. Effective though they were, these devices did not receive immediate acceptance in the United States, possibly because of the cost. While they were more widely accepted in England, many years were to pass before multiple-speed devices became common on American bicycles.

During the 1890s, interest in bicycling reached boom proportions. Production rose from an estimated 200,000 bicycles in 1889 to 1,000,000 in 1899, and the machine attained an importance in America that it is only now regaining. By 1899, only a few score automobiles had been built, horses and carriages were expensive to maintain in crowded cities, and urban public transportation was, with few exceptions, slow and frequently inadequate. The bicycle met the need for inexpensive individual transportation—much as the automobile has in recent times—for going to and from business, for business deliveries, for recreational riding, and for sport.

What to us seems a simple device of modest and limited performance was, in the relatively unmechanized 1890s, a swift vehicle and a fine machine. Owners were drawn together by their interest in it as a mechanism, as well as in its use for riding or racing, and bicycle clubs were a part of the social and sporting scene. A nationwide bicycle club, the League of American Wheelmen, was formed on 30 May 1880 at Newport, Rhode Island, through the joint efforts of Kirk Munroe, of New York, and Charles Pratt. Membership reached 150,000 in 1900, and the influence of its numbers was an effective promoter of the good-roads movement that was to be so important an element in the acceptance of the early automobiles.

Bicycle racing as an international sport had a large and enthusiastic following in the United States 70 years ago, and the demand for lighter and faster bicycles accelerated many of the improvements made by the manufacturers. The successful racers were the sports heroes of the day. Charles M. Murphy was one who attained lasting fame by an amazing performance on 30 June 1899. On a board surface laid between the rails of the Long Island Rail Road, Murphy, riding within a hood built at the rear of a car, kept up with the car as it was pulled by a locomotive going just over 60 miles an hour. For this feat he became known as "Mile-a-minute Murphy." His record was surpassed on 17 May 1941, when Alfred Letourner pedaled a mile in 33.05 seconds on a highway in California, traveling at the rate of 108.92 miles an hour in the wake of a shield attached to the rear of a midget racing automobile. Many well-known bicycle racers of the early days ultimately became famous in the automobile racing field, Ralph DePalma and Barney Oldfield probably being the best known of the converts.

Directly and indirectly the bicycle had a decided influence on the introduction and ready acceptance of the automobile. In addition to

A selection of oil lamps and self-generating acetylene lamps on a page from the 1916 cycle catalog of J. W. Grady & Co., Worcester, Massachusetts.

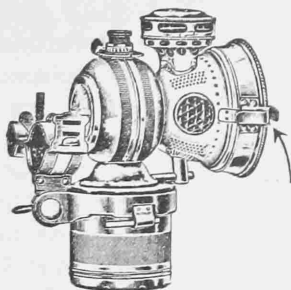

NO. 2 20TH CENTURY GAS LAMP

Made of brass, nickel plated, height 7", weighs 22 oz., has carbide capacity of 4 oz., fitted with a $\frac{1}{4}$ " burner. Burns from 4 to 6 hours. **Price complete \$3.00**

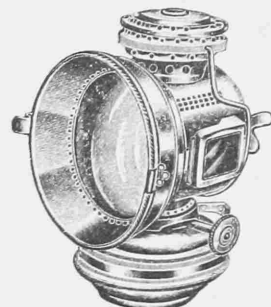

The 20th Century Oil Lamp has been a great seller in the past; made of brass, nickel and polished, measures $3\frac{1}{2}$ x $2\frac{3}{4}$ "; burns 12 hours on one filling. **Price \$2.00 each**

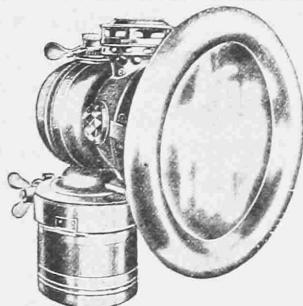

NO. 6 20TH CENTURY GAS LAMP

A self-contained lamp, but especially reinforced for motorcycle and carriage service. Has extension reflector 6" in diameter and gives about 125 candle power light. Equipped with same improvements as No. 2. **Price \$5.00**

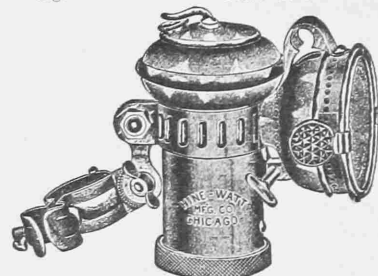

COLUMBIA GAS LAMP

Is made of brass, nickel plated, has a good double convex lens and a gas valve for regulating flame. **Price complete \$2.75 each**



THE SEARCHLIGHT GAS LAMP

This lamp has been on the market for years and has always made good, stands $7\frac{1}{2}$ " high with $2\frac{1}{2}$ " double convex lens, all parts nickel-plated. **Price \$2.50 each**

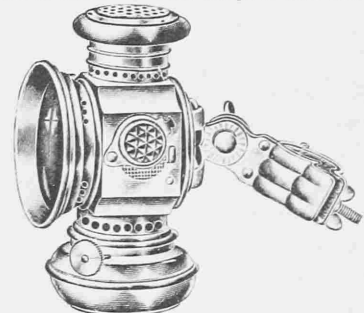

COLUMBIA OIL LAMP

Made of brass, nickel and polished, stands 6" high and has a $2\frac{3}{4}$ " heavy, bent lens. **Price \$1.50 each**

introducing thousands of persons to individual and independent mechanical transportation, the bicycle proved the value of many materials and parts that were subsequently taken over by the automobile designers. Ball bearings found one of their earliest uses in the bicycles of 1880 or earlier. The differential unit was employed in tricycles, and various forms of free-wheeling and gear-shifting devices were in use. Steel tubing, developed largely for cycle frame construc-

tion, was adopted by some early automobile builders. Pneumatic tires, previously mentioned, and wire wheels were also in use on bicycles prior to the introduction of the gasoline automobile in America.

Many pioneer automobile builders were at first bicycle manufacturers. Among these were Charles E. Duryea, Alexander Winton, Colonel Albert A. Pope, H. A. Lozier, and George N. Pierce, all of whom manufactured automobiles bearing their names. Furthermore, Wilbur and Orville Wright were bicycle manufacturers in Dayton, Ohio, before they turned their attention to the aeronautical field, and Glenn H. Curtiss, another aviation pioneer, started out as a bicycle manufacturer.

As the 19th century closed, the bicycle industry began a rapid decline. Between 1900 and 1905 the number of bicycle manufacturers in the United States shrank from 312 to 101. Interest in the automobile was only partly responsible for this. Additional factors were a switch to other forms of recreation, and the fact that a considerable number of electric railways took over the sidepaths originally constructed for bicycle use. Thereafter, for over half a century, the bicycle was used largely by children, although tire and gasoline rationing brought it into temporary use as adult transportation during World War II.

Recent cycle development has not involved significant changes in construction, but rather a refinement of earlier features, resulting in today's durable, lightweight, comfortable and easy riding machine. During the late 1960s there began a reawakening of adult interest in cycling as a non-polluting, non-congesting means of transportation and recreation. Increasingly, too, members of the medical profession have pointed to the bicycle as one of the best means of obtaining physical exercise for sedentary, coronary-prone Americans. A century earlier an 1869 velocipedist's manual, in a chapter entitled "Velocipathy," had pointed the way with the statement that the bicycle gave "a natural exercise and general development to every muscle of the body."

In 1970 nearly 5 million bicycles were manufactured in the United States, and an estimated 75 million riders shared 50 million bicycles, making cycling the nation's leading outdoor recreation. Growing numbers of commuters ride bicycles today, and bikeways continue to spread in both rural and urban areas. With some dealers barely able to meet customer demands, one wonders whether the present boom will suddenly slacken or cease entirely—as has happened before in cycle history—or whether, one hopes, it will become a permanent and important factor in American transportation.

THE SMITHSONIAN CYCLE COLLECTION

The Smithsonian's cycle collection began in 1889 when a velocipede was presented by Joseph Z. Collings. Received when it was about 10 years old by J. Elfreth Watkins, curator, from 1885 to 1903, of the section of transportation, in the division of technology, this was the third wheeled vehicle to be accessioned, having been preceded by a steam locomotive and a horse-drawn carriage. Though not the donor, the man who was instrumental in bringing the velocipede to the collection was Lucius D. Copeland, inventor and builder of experimental steam-propelled road vehicles. Copeland also was an associate of Watkins', who, in addition to his museum curatorial duties, was president of the Moto-Cycle Manufacturing Co., of Philadelphia, a firm organized to manufacture steam vehicles following Copeland's designs. Several other velocipedes and early-type Safety bicycles also were taken into the collection during the years of Watkins' curatorship.

From 1893 to 1897 two bicycles were loaned to the museum by Herbert S. Owen, a Washington, D.C., bicycle dealer and manufacturer who had employed the automotive pioneering Duryea brothers, Charles E. and J. Frank, as mechanics in his bicycle shop in Washington, during the late 1880s. Owen claimed that one of the cycles, built by him in October 1887, was the first woman's Safety bicycle to be made in the United States. Regretfully, he withdrew it from the collection in February 1897 when it was needed as evidence in New York in the legal proceedings of Owen vs. the Pope Manufacturing Co. His other loan, an 1885 Starley and Sutton Safety, was withdrawn at the same time.

Following Watkins' death in 1903, George C. Maynard's responsibilities in the museum's division of technology included that of curator of the transportation collection until his own death in 1918. During these 15 years the cycle collection grew by only two velocipedes and two H. B. Smith bicycles.

Subsequent responsibility for the transportation collection was borne by the late Carl W. Mitman, Paul E. Garber, and Frank A. Taylor. The position of curator of land transportation was created in 1946 and was filled by Smith Hempstone Oliver during a 10-year tenure. John H. White assumed this position in 1958.

ANATOMY OF THE BICYCLE.

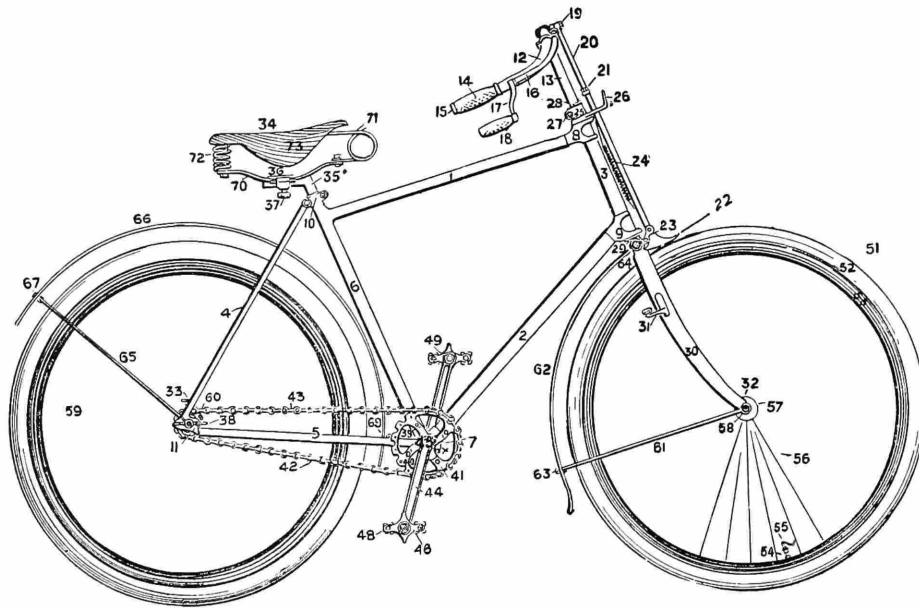

The following caption accompanied this illustration, which appeared in a newspaper some time after the introduction of the modern Safety.

This description applies to an ordinary diamond frame wheel. There are many extra attachments, and different makers have different ways of putting a wheel together, so that they may differ in one or two minor details. The description given, however, is in the main correct. It includes mud-guards and their fittings, which are used but little here, but are on all wheels made in England. They are used generally on drop-frame wheels in this country.

- | | | |
|--|--|--|
| 1. Upper main tube. | 24. Brake spring. | 48. Pedal pin. |
| 2. Lower main tube. | 25. Handle-bar clip and ball head cone. | 49. Nut and washer. |
| 3. Front frame tube. | 26. Lamp bracket. | 51. Steering wheel. |
| 4. Back stays. | 27. Lock nut for handle-bar clip. | 52. Tire. |
| 5. Back forks. | 28. Ball head adjusting nut. | 53. Rim. |
| 6. Centre stay. | 29. Front fork crown, with brake lug in front. | 54. Air valve. |
| 7. Crank bracket. Contains cones at outer ends, crank axle, with ball-bearings and adjustment clip bolt. | 30. Fork sides, right and left. | 55. Valve cap. |
| 8. Upper ball head race, or cup. | 31. Coasters. | 56. Spokes. |
| 9. Lower ball head race, or cup. | 32. Fork ends. | 57. Hub, which comprises outside shell with bushes, axle, and ball bearings. |
| 10. Saddle post adjustment clip. | 33. Step. | 58. Washers for fixing to forks. |
| 11. Back fork end. | 34. Saddle. | 59. Driving wheel. |
| 12. Handle-bar. | 35. Saddle post. | 60. Driving wheel hub. |
| 13. Handle-bar stem. | 36. Saddle clip. | 61. Front mud-guard stays. |
| 14. Handle. | 37. Set screw. | 62. Front mud-guard. |
| 15. Ferrule, or nickel tip. | 38. Chain adjustment bolt. | 63-4. Front mud-guard screws. |
| 16. Brake lever. | 39. Crank axle. | 65. Back mud-guard stays. |
| 17. Brake lever crank. | 40. Detachable sprocket wheel. | 66. Back mud-guard. |
| 18. Brake lever handle. | 41. Sprocket bolts. | 67. Back mud-guard screws. |
| 19. Brake plunger connecting bolt. | 42. Chain. | 69. Back mud-guard screws. |
| 20. Brake plunger. | 43. Detachable link in chain. | 70. Saddle frame. |
| 21. Brake plunger adjustment nut. | 44. Crank. | 71. Front saddle spring. |
| 22. Brake shoe. | 45. Cotter pin nut and washer for detachable crank on other side of machine. | 72. Rear saddle spring. |
| 23. Brake shackles, bolts and nuts. | 46. Pedal. | 73. Leather top, with tension adjustment screw in front, underneath. |

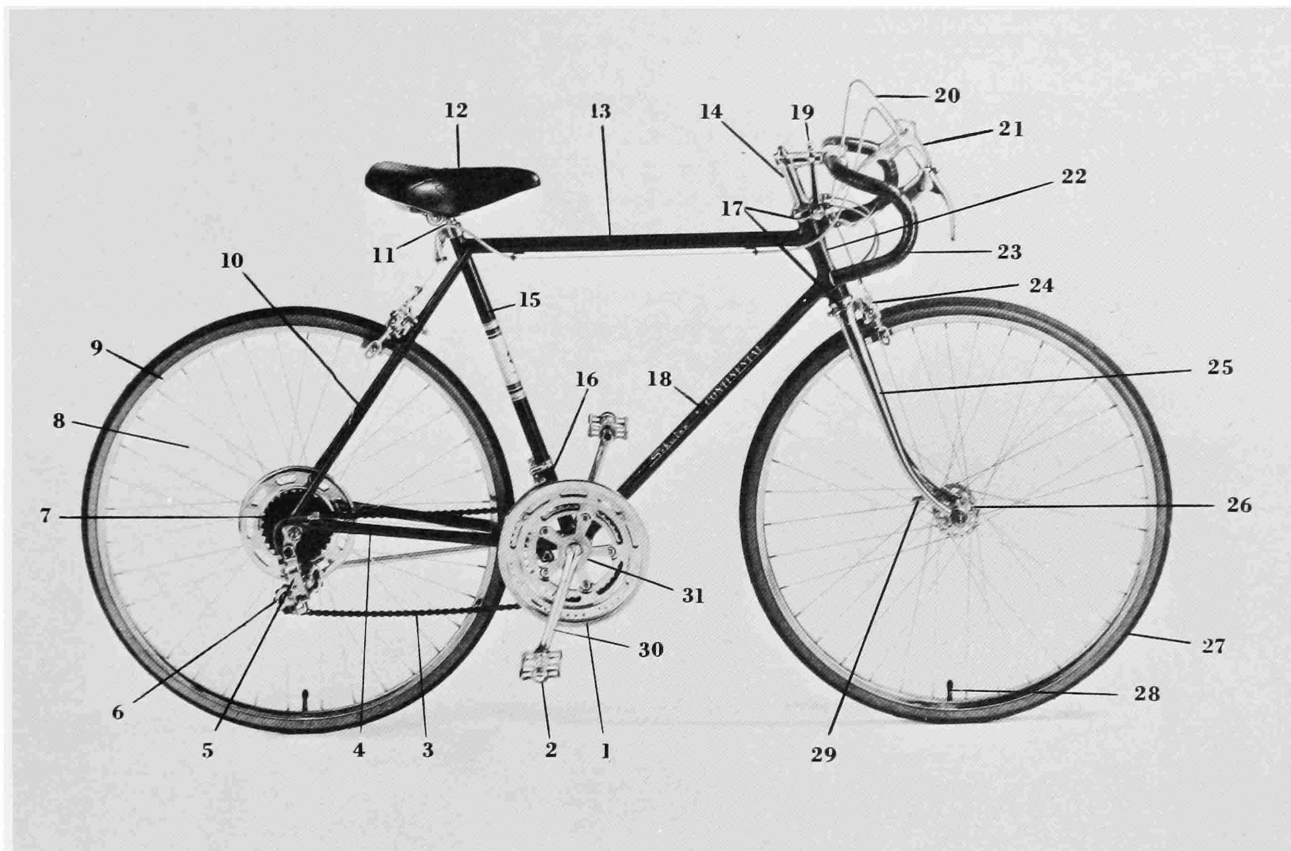

For purposes of comparison with the early diamond-frame Safety, the nomenclature of the 1971 Schwinn 10-speed Continental is shown. Photo from Schwinn Bicycle Co.

- | | |
|--------------------------------------|---|
| 1. Chainwheel (or front sprocket) | 17. Headset (top and bottom) |
| 2. Pedal | 18. Bottom tube (or down tube) |
| 3. Chain | 19. Gearshift lever |
| 4. Chainstay | 20. Brake cable |
| 5. Rear <i>derailleur</i> | 21. Brake lever |
| 6. <i>Deraillleur</i> tension roller | 22. Steering head |
| 7. Freewheel gear cluster | 23. Handlebars |
| 8. Spoke | 24. Caliper brake |
| 9. Rim | 25. Fork |
| 10. Seat stay | 26. Hub (high-flange type) |
| 11. Seat post | 27. Tire |
| 12. Saddle (or seat) | 28. Valve |
| 13. Top tube | 29. Quick-release lever |
| 14. Handlebar stem | 30. Crank |
| 15. Seat mast (or tube) | 31. Bottom bracket, or crank hanger (behind sprocket) |
| 16. Front <i>derailleur</i> | |

This photo of an unidentified early bicycle, apparently taken in the Museum, is believed to be of the 1887 woman's bicycle built by Herbert S. Owen (see page 25).

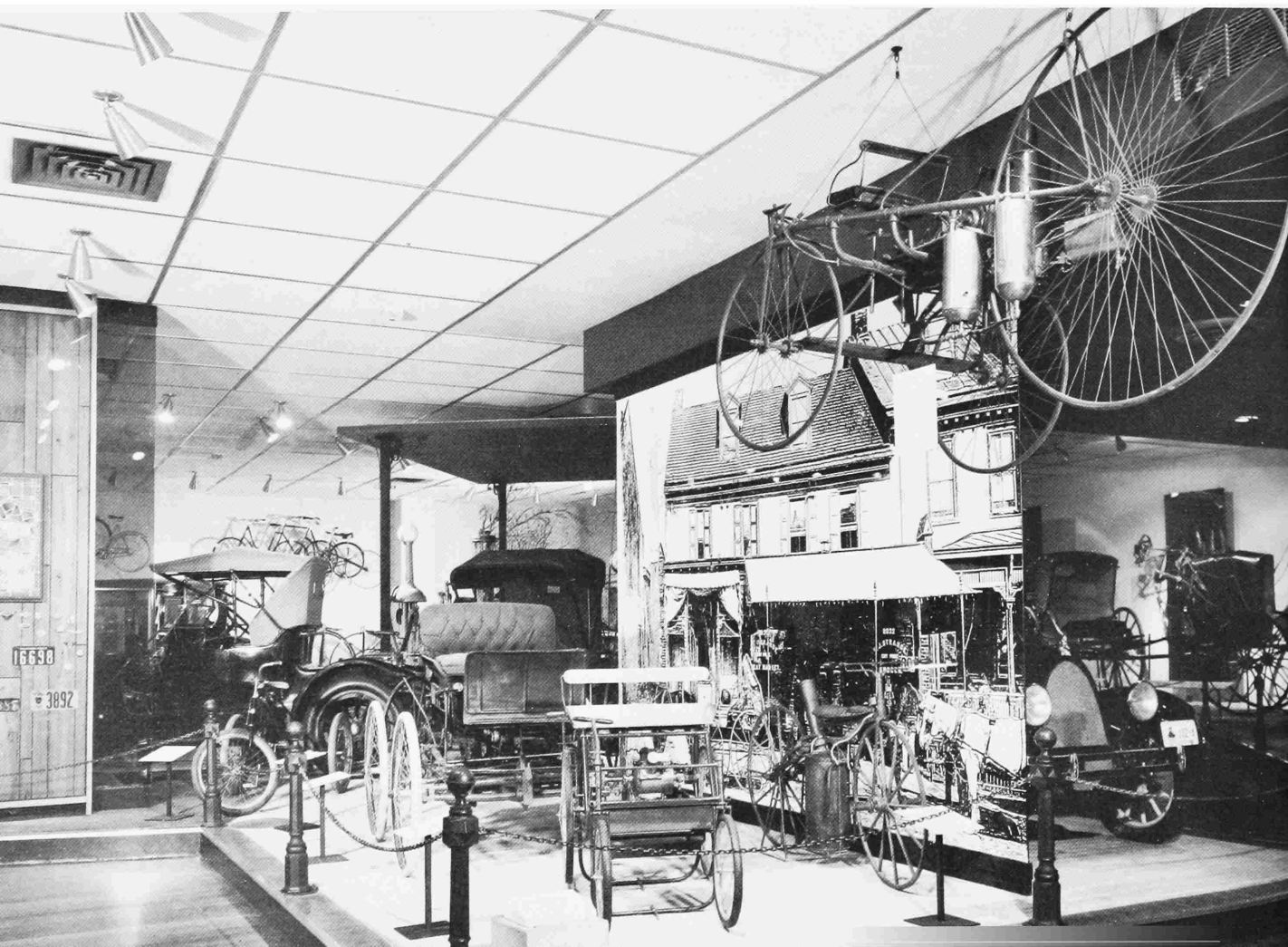

Prominent among donors during the years of these last-mentioned curators is the late Albert E. Schaaf, of Cleveland, Ohio, who not only restored and presented two high-wheelers to the collection, but also collected and presented a valuable library of early bicycle literature that includes rare historic scrapbooks and unbroken runs of trade magazines.

Not on public exhibit is an important adjunct of the collection in the form of an interesting assortment of reference material composed of early manufacturer's catalogs, trade journals, and photographs, as well as the aforementioned Schaaf library collection.

Significant examples from the museum's comprehensive collection of cycles, most of them restored, are exhibited in the Vehicle Hall in the east end of the first floor of the National Museum of History and Technology.



← →
The Vehicle Hall in the National Museum of History and Technology, showing part of the cycle collection on exhibition.

Hobby Horse, about 1818

Gift of Preston R. Bassett in 1964

One of only a few original Hobby Horses to be found in the United States, this machine is unidentified, but is believed by the donor to be possibly of French origin.

The frame, or backbone, is a 47-inch wooden bar, curving upward at the rear. This bar was probably originally made of one piece, but now has a splice near the front, and is reinforced at this point with iron plates. The saddle is mounted on a separate bar which is elevated above the main bar by three adjusting screws, the two forward screws being fixed between two short crossbars situated near the front of the saddle. On the saddle bar is a firmly padded seat, covered with maroon mohair that is believed to be either original, or an early replacement that is contemporary with the machine's use. An upright post at the front of the saddle supports the rest for the rider's forearms. Three curving iron rods brace this rest. The saddle assembly can be elevated from 30 to 33 inches above the ground.

A two-arm iron fitting is bolted to each side of the frame in the rear, thus forming the fork in which the rear wheel is mounted. The front wheel is held by an iron fork that terminates above in a long, backward-curving stem on which the curved wooden handlebar is mounted. A coil spring around the stem bears upward against a pin through the stem, to take up any vertical play in the steering head. Both of the 10-spoke wooden wheels are 24 inches in diameter, and carry a 1-inch iron tire. Wheelbase is 38 inches.

Traces of the original light green finish are visible, bearing both yellow and black striping.



This Hobby Horse was probably made about 1818.

Hobby Horse of 1818 (reproduction)

Gift of Buster Keaton in 1924

This reproduction of the Pedestrian Curricle, or Hobby Horse, popularized in England in 1818 by Denis Johnson, was used about 1924 in the motion picture *Our Hospitality*.

A wooden bar, 55 inches long, and curved downwards slightly in the center, supports by means of iron braces a wheel in the rear. A vertical iron fork, supporting another wheel, is pivoted at the front of the bar. The fork is steered by means of a curved tongue attached to the bottom of the fork. A wooden armrest for the rider is mounted upon iron braces at the front of the bar. A felt saddle is carried on the center of the bar.

Each wheel is 30 inches in diameter and contains eight spokes. The spokes, hubs, and felloes are of wood, with the spokes staggered in the hubs. Narrow iron tires are fitted to the felloes.



Reproduction (1924) of an 1818 Hobby Horse.

Velocipede, about 1868

Gift of William R. Beisel in 1894

This velocipede, made about 1868, originally had a white frame and red wheels.



This velocipede, which is of the Hanlon type noted on page 5, is believed to have been manufactured by J. N. Hazelip, otherwise unidentified, for his name is uniformly stamped into it in two places. On the left front fork the name is accompanied by the number "43" which possibly could be a size, for the distance from the ground, underneath the front wheel, to the centerline of the frame, is 43 inches. No date appears on the machine.

A forged-iron frame, terminating in a polished bronze casting at the front, supports a forged-iron front fork. The top of the fork is fitted with curved iron handlebars that undoubtedly were originally fitted with wooden grips, now missing.

The wheels of the vehicle are of wood, each with 12 spokes slightly staggered in the hub. The 41¼-inch front wheel and the 36-inch rear wheel carry iron tires. On the front axle, wooden, spool-shaped pedals are fitted to nonadjustable cranks having a throw of 6½ inches.

A thin metal saddle, probably originally covered with leather, is suspended on a broad, curved, single-leaf steel spring directly over the center of the frame. Originally this machine, now under a coarse, later finish, had a white frame striped with red, and red wheels, the striping of which cannot now be discerned.

Velocipede, about 1868

Gift of William Sturgis Bigelow in 1907

The donor of this machine, which is of the French pattern, stated that it was made by either Sargent or French, carriage builders of Boston, Massachusetts, about 1868, and that it sold for 160 dollars. An illustration of an almost identical machine is captioned "American velocipede of 1869" on page 22 of Charles Pratt's *The American Bicyclist* (1880). Another similar machine, illustrated on page 28 of Harry Griffin's *Cycles and Cycling* (1890), is described as an "Improved Boneshaker of 1870," made by Charles Pomeroy Button, of 142 Cheapside, London.

A heavy forged bar, terminating in a fork at its lower end, serves as a frame. A vertical iron fork, topped by a horizontal handlebar mounted in brackets, swivels in the front of the frame. A forward projection of the frame carries a pair of footrests for use while coasting, and ends in an ornamental scroll. Wood-spoke wheels with $1\frac{3}{16}$ -inch-wide iron tires have, respectively, diameters of 37 inches in front and 31½ inches in the rear, and 16 and 14 staggered spokes. Weighted bronze pedals hang from the cranks, adjustable from 4½ to 7 inches, that are secured to the live front axle.

Twisting the handlebars in the mounting brackets winds up a cord which presses a brake shoe against the tire of the rear wheel. A padded, pigskin-covered metal saddle is mounted on a flat steel spring, on which it can be adjusted forward or backward to suit the length of the rider's legs.

This velocipede was restored in 1972 by Dale C. Price, of Cambridge, Maryland, who duplicated the original finish, which was typical of the better machines of the period. The frame and wheels are a rich, medium blue, heavily striped with gold leaf. The long spring supporting the seat, the front fork, handlebars, and pedal cranks are highly burnished. The wooden grips of the handlebars are fitted with brass ferrules and brass tips, and the counterbalanced pedals are of polished bronze. There is little doubt that this is the finest velocipede in the Museum's collection.

Velocipede believed to have been made in Boston, Massachusetts, about 1868. It was restored in 1972.



Velocipede, about 1869

Gift of S. R. Sturdevant in 1889

As with several of the other velocipedes, no identifying marks can be found on this machine, but the donor apparently believed it was made in Dayton, Ohio. His personal knowledge of the machine may be correct, for the velocipede was one of the first vehicles to come to the Museum's transportation collection, being only 20 years old when he presented it.

The mechanical description of the 1868 velocipede made in Boston will suffice for this cycle, for the two are nearly identical. This one is slightly larger; its 14-spoke wheels have diameters of 38 and 32½ inches and ¾-inch tires. The adjustable pedal cranks are also longer, giving a throw of from 6 to 9 inches. The absence of two features, foot rests and a brake mechanism, distinguish this velocipede from the 1868 model. Oddly, the handlebars turn and have an eye, as if for a brake, yet there is no evidence that this accessory was ever added, nor is there a passageway through which a brake cord could pass.

The finish, now almost gone, was originally red, with a ⅞-inch black stripe split with a fine gold line, reminiscent of the decoration applied to commercial horse-drawn vehicles.



Velocipede of about 1869, believed to have been made in Dayton, Ohio.

Van Anden Dexter Velocipede, 1869

Gift of Mrs. William M. Van Anden in 1930

William Van Anden, of Poughkeepsie, New York, was granted Patent 88,238 on 23 March 1869, covering an "improvement in velocipedes." This improvement, well ahead of its time, consisted of a "ratchet device," or free-wheeling unit, in the hub of the front wheel, that enables the rider's feet to remain motionless while the velocipede continues to move by momentum, as will a bicycle equipped with a coaster brake. Use of the device is optional, however, for the movement of a small plunger in the hub joins the pedal cranks fast to the axle, as in the conventional velocipede.

This velocipede, built by Van Anden, contains the above feature. A notice in the *Brooklyn Daily Eagle* of 20 February 1869 describes the velocipede and mentions that it had been on exhibition the previous week at Burnham's velocipede school.

The frame and fork are of iron, and are supported by wooden wheels with staggered spokes and the usual iron tires. Diameter of the front wheel is $36\frac{1}{4}$ inches and of the rear, $32\frac{1}{4}$ inches. Attached to the $4\frac{1}{2}$ -inch cranks are spool-shaped cast-iron pedals of peculiar design. Weight is 55 pounds.

The handlebars twist to actuate a linkage connected to a friction brake operating against the rear tire. A pierced cast-iron saddle is mounted on leather straps attached to curved iron supports in the center of the frame.

Finished in red with cream striping, this velocipede was restored in 1973 by Dale C. Price, of Cambridge, Maryland, who duplicated the original finish. The several cast bronze fittings are highly polished.



The Van Anden velocipede of 1869 has a free-wheeling device in the front hub that permits the rider to coast, as with a coaster brake.

Laubach Velocipede, 1869

Gift of Mrs. William J. J. Manning in 1971

One of the few departures from conventional velocipede construction that achieved any appreciable popularity was this machine invented by Dr. William H. Laubach, of Philadelphia. Assigned U.S. Patent 86,235 on 26 January 1869, Laubach's velocipede also came to be known as the Pearsall velocipede after Laubach sold his patent to the Pearsall brothers, who operated New York City's first and most successful velocipede school. *The New York Coach-Maker's Magazine*, the *Coach-Makers' International Journal*, and the *Eclectic Medical Journal* all were profuse in their praise of the "most scientific velocipede." Among the claims made for it were the statements that both wheels were always in the same arc when turning and that, due to its peculiar construction, the rider's weight kept it running in a naturally straight line. The many favorable comments made of it seem unwarranted, however, for it proved to be far less manageable than velocipedes of the usual design. Dr. Laubach is said to have traveled one hundred miles in five hours on one of these velocipedes, seemingly a rather unlikely feat. The Pearsalls were so impressed with the design that they reportedly formed a stock company with a capital of 300,000 dollars to manufacture Laubach patent velocipedes, but it is not known to what extent they produced them, or used them in their riding school. Laubach velocipedes cost 125 dollars.

The value of the velocipede for purposes of physical exercise was early discovered, as evidenced by this comment concerning Laubach's cycle in the January 1869 *Eclectic Medical Journal*: "We look upon this mode of exercise with this physiologically constructed machine as one of the most brilliant discoveries of the nineteenth century; the grand desideratum that will emancipate our youth from muscular lethargy and atrophy that is so common."

The construction of this velocipede differs from the more common variety in that this one is articulated, being constructed of two separate frames, one for each wheel, pivoted together in the center. Each frame consists of four iron rods, secured together by cast bronze fittings. The fittings securing the axles are split, and are held together by two bolts. The central fittings of the two frames pivot on a verti-

The 1869 Laubach velocipede is turned by pivoting the wheels upon a vertical pin under the rider's seat.

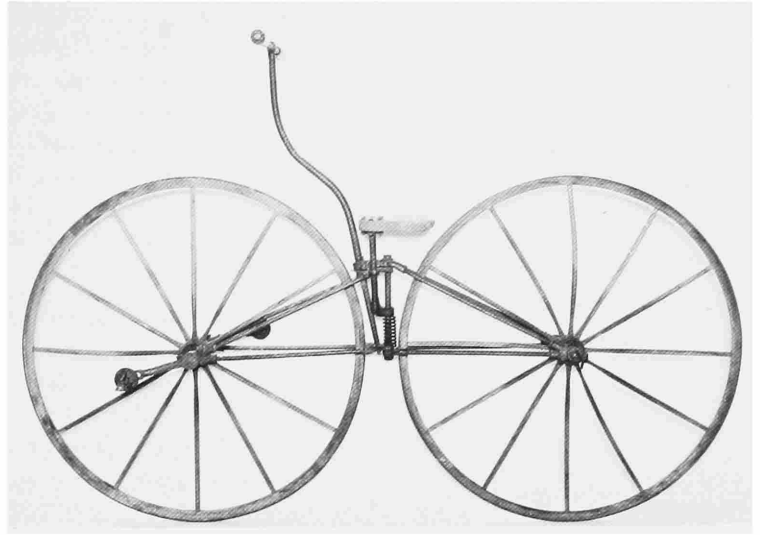

cal iron pin. A gear segment, integral with the upper pivot joint of the rear section, engages a gear segment on the steering column, the latter being mounted in the forward frame section. Turning the wood-grip handlebars causes both wheels to swing, so that both assist in steering, yet the rear wheel appears to be doing the greater portion of the work since the seat remains in the same plane with the front wheel.

The 12-spoke wheels are both $36\frac{1}{2}$ inches in diameter, and carry a $\frac{3}{4}$ -inch iron tire. The pedal cranks are in the conventional position on the front wheel, and carry 3-sided bronze pedals that can be fitted in either of two holes in the cranks, giving a throw of either $5\frac{1}{2}$ or $6\frac{1}{2}$ inches.

The wooden seat is old, but may not be original, for it does not agree with three contemporary illustrations of the cycle. Tack holes on the underside indicate that the seat was once covered. The seat support rests on a coil spring around the central pivot pin, allowing the seat to move freely up and down.

Two of the three existing drawings of this velocipede show some type of footrest beneath the rider, just in front of the pivot joint, but there is no evidence that this machine was ever fitted with such rests. Neither is there evidence of any finish on this velocipede, yet in view of the existing finishes on other velocipedes, it does not seem unlikely that this one, too, was once brightly painted and striped.

Roper Steam Velocipede, about 1869

Gift of John H. Bacon in 1956

The oldest self-propelled road vehicle in the Museum's collection is the steam-powered velocipede built in the late 1860s by Sylvester H. Roper, of Roxbury, Massachusetts, and demonstrated by him at fairs and circuses.

At first glance the machine appears to be a converted velocipede, but examination reveals that its frame was forged expressly for this self-powered vehicle.

The two 34-inch-diameter wooden-spoke wheels have wooden feloes and iron-band tires. The front wheel is supported in a forged wrought-iron fork having a straight handlebar with wooden grips. Footrests are provided at the bottom of the fork. The wheelbase is 49 inches.

A vertical, fire-tube boiler is suspended between the wheels, and a chimney angles back from the top of the boiler housing. The lower half of the housing served as the firebox (the grate of which is missing). Charcoal was fed through a small circular door on the left side of the firebox. The housing is suspended from the center of the frame by means of a spring-loaded hanger (intended to absorb some of the road shock) and is braced at the bottom by two stay rods connected to the rear of the frame.

A hand-operated water pump is mounted vertically on the left forward side of the boiler housing. Three water-level cocks are located nearby, and there is a drain valve at the left rear of the boiler's base.

Oscillating steam cylinders are pivoted on each side of the frame, next to the chimney. From outside measurements, it is estimated that the bore of the cylinders is about two and one-quarter inches. The piston rods worked on 2½-inch cranks on the ends of the rear axle. Piston valves for the cylinders were operated by eccentrics adjacent to their cranks, and a feed-water pump was operated by the left-cylinder crank. The exhaust steam, carried by tubing into the base of the chimney, provided forced draft. Apparently, while the machine was at rest a forced draft was provided by a tiny steam pipe that leads from the safety valve at the top rear of the boiler to the base of the chimney. There is a damper valve within the chimney.

The throttle, located at the top front of the boiler housing, was actuated by forward twisting of the handlebar. A friction brake was applied against the rim of the front wheel when the handlebar was twisted toward the driver. Heavy tubing leads from the throttle to the steam chests of the cylinders, and other tubing leads from the boiler to a steam gauge at the front of the frame.

The water supply for the boiler was contained in tank that also served as the saddle. The filler opening is at the front of the tank. Water was supplied to the hand pump and the feedwater pump by means of tubing that leads from the bottom of the tank.

It is clear that the builder of this early self-propelled vehicle was an ingenious as well as an accomplished machinist.



Steam velocipede built by Sylvester H. Roper about 1869. Below, arrangement of cylinders, valve chests, and the feed-water pump on the left cylinder.

Greene and Dyer Monocycle, 1869

Gift of W. Easton Louttit, Jr., in 1944

During 1869 a number of patents were granted covering various types of monocycles or unicycles. One of these, Patent 91,535, was granted on 22 June 1869 to Allen Greene and Elisha Dyer, of Providence, Rhode Island, for an “improvement in velocipede.” This incomplete monocycle, built by them, represents their invention. The donor stated that it was reported that the vehicle had crashed badly on its first trial run, and proved to be unsatisfactory.

The 24 spokes and the felloe are of wood, and a thin metal band attached to the felloe serves as a tire. The diameter of the wheel is 8 feet, and its thickness at the center, 4 feet. The bowed spokes radiating in from the rim connect alternately to hubs on each side, composed of two metal discs bolted together, so that 12 of the spokes are clamped between each pair of discs.

Within the center of the cage thus formed a framework is suspended from short shafts extending inwards from the two hubs, and to the framework is attached a swinging seat for the operator. Small hand-crankes are also attached to the framework near the short shaft extensions, but it is not clear how they worked, for the cranks are now inoperative. The patent specifications refer to hand-crankes and foot-treadles jointly providing the motive power, but no treadles now exist, nor is there evidence of how they might have functioned. No other parts of the mechanism remain, and it is uncertain whether the vehicle was ever completed.

Outer extensions of the hub shafts carry an iron fitting from which two trailing legs hung on either side. These were intended to support the monocycle when it was at rest and to assist the operator in starting from a standstill. As do several other unicycle patents, this patent specification shows a sunshade fitted over the operator’s seat. It is doubtful that the improvement was ever added.

Greene and Dyer monocycle of 1869, shown alongside the Smithsonian’s Arts and Industries building, where the collection was displayed until 1965. Holding the cycle is Smith Hempstone Oliver, curator, 1946-56.



Adult's Tricycle, about 1875

Acquired in 1972

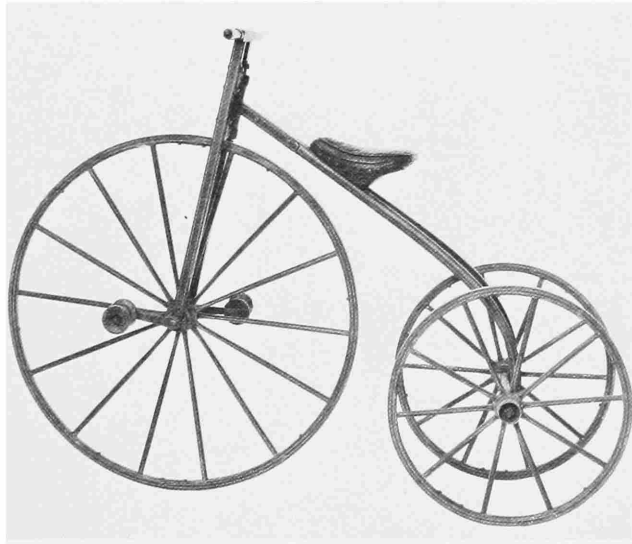

This adult's tricycle probably dates from around 1875.

This unusual, unidentified tricycle is one of the few adult machines of the velocipede era to be found in United States collections. It has tentatively been dated at about 1875 because its general construction agrees with that of early velocipedes and with patent drawings of the early and middle 1870s. It has not been possible, however, to identify it with any specific patent.

It is a simple, yet well-constructed machine. The wheels, front fork, handlebars, and twin backbones are of wood. The backbones join together at the front ends with an iron steering pin that engages a pair of iron fittings on the forks. The lower ends of the forks have split bronze bearings, with oil holes that are neatly inletted in the wood. Wooden spool-pedals are attached to the 5-inch iron cranks, as on a common velocipede. In the rear, the lower ends of the backbones are attached to the iron axle with a pair of ordinary axle clips of the type employed in the carriage-building trade. A leather-covered saddle stuffed with horsehair is mounted on the backbones, these being of bent wood to provide the only spring action for the rider's comfort.

The diameter of the front wheel, $38\frac{1}{2}$ inches, is comparable with that of a velocipede; that of the rear wheels is $24\frac{1}{2}$ inches. All wheels carry $\frac{3}{4}$ -inch iron tires. The saddle is 37 inches above the ground, and is so positioned behind the pedals that a rider's leg length of about 30 inches is indicated. Overall length is 67 inches. Undoubtedly the maker of this tricycle patterned it on the velocipedes so popular in 1869, and added the third wheel for stability. However, the narrow track of $16\frac{1}{2}$ inches, in contrast to the machine's height, results in a vehicle that feels less stable to ride than does the two-wheeler. Thus, since it is an impractical conveyance, it appears likely that it was little used, and this, in turn, could account for its remarkably fine original condition.

The tricycle retains its original finish, which is black (though it sometimes appears to be a very dark green), striped with fine lines of light yellow, while the handlebar grips are unpainted. Black leather covers the lower part of the saddle, but the upper leather is tinted green, which lends some support to the possibility that the true color of the tricycle may be a dark Brewster green.

Child's Tricycle, 1876

Gift of Mrs. Harold Allen in 1930

Patent 171,623 was issued on 28 December 1875 to George W. Marble, of Chicago, Illinois, for an "improvement in velocipedes." One half his right was assigned to Adolph Shoening, also of Chicago. This small tricycle, constructed principally of wood, bears the above patent date, and is similar to the drawing accompanying the patent application.

Two wooden bars form the sloping frame, and two others form the fork which pivots at the front of the frame. Metal fittings at each end of each rod serve as pivots for the fork, and as bearings for the wheels. Straight wooden handlebars and a cast-iron saddle are provided.

The hubs, spokes, and felloes of the three wheels are of wood. The tires are thin metal rims. The diameter of the front wheel is 24 inches, that of the rear wheels, 20 inches. Spool-shaped wooden pedals are attached to the crank arms of the front wheel. The distance between the two rear wheels is 11 inches, making it an inherently unstable vehicle.

Child's 1876 tricycle.



Unzicker Tricycle (model), 1878

Transferred from the U. S. Patent Office

The Patent Office model of the 1878 Unzicker tricycle, equipped with ladies' sidesaddle, is markedly similar to the child's tricycle of 1876.

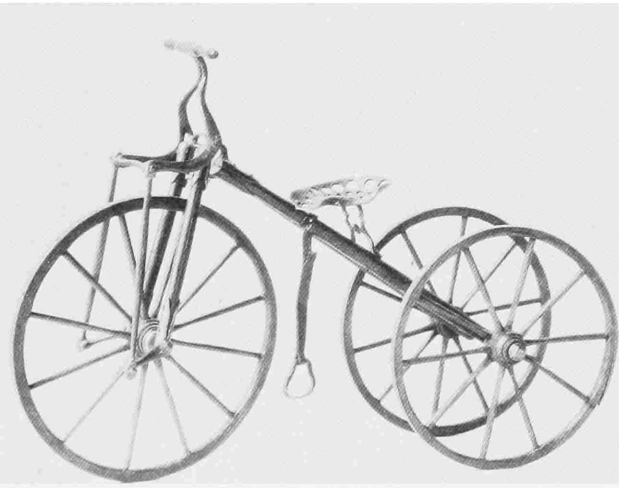

Patent 204,636 was issued on 4 June 1878 to Otto Unzicker, of Chicago, Illinois, for an “improvement in velocipedes.” It is interesting to note the similarity in design of the main components of this tricycle and those of the 1876 child’s tricycle velocipede in the collection. Some connection between the two may well have existed, as Unzicker’s patent was assigned in its entirety to the same Adolph Shoeninger associated with Marble.

This model shows a tricycle propelled by the back-and-forth motion of the wooden handlebars, which are also used to steer the tricycle. They are fastened to the upright arm of a bell-crank attached to the top of the fork, and the motion of the bell-crank is transmitted by connecting rods to cranks on the ends of the front-wheel axle.

The model, measuring 11 inches long, 7½ inches high, and 3½ inches wide, is constructed of wood and brass, except for the steel rear axle and the leather strap for the single stirrup. The sloping frame and the fork are of wood, with fittings connecting the two. The wheels are of wood, the 5-inch diameter front one containing 12 spokes, and the 4½-inch diameter rear ones each containing 10 spokes. The spokes are staggered in the wooden hubs.

The sidesaddle places the rider on the left side of the vehicle. Because of the mechanical disadvantage accompanying this method of propulsion, and the relatively narrow track of the rear wheels, it is thought that a full-sized vehicle, if one was ever built, would not have proven very satisfactory on the poor roads of the nineteenth century.

Shire Velocipede, 1879

Gift of C. Howard Buckler in 1907



1879 Shire velocipede, as photographed in 1914 with George C. Maynard, one-time curator of the division of technology.

Built at a rather late date for this type of vehicle, this “bone-shaker” bears a brass plate marked “J. Shire, Patent Reallowed May 10, 1879, Detroit, Mich.” Patent Office records reveal the fact that John Shire of Detroit on 3 June 1879 was granted Patent 216,231 covering “improvement in velocipedes.” The Shire velocipede in the collection is similar to the drawing accompanying the patent application. No patents were granted to Shire on the date appearing on the plate attached to the machine. The high, wire-wheeled Ordinary was already on the market by 1879, and for such a specimen as this crude machine to have been built at the same time seems anachronistic. It is interesting to note that it was built in the future capital of the automotive world.

The forked frame and the front-wheel fork are both made of wood with iron reinforcements. The front-wheel fork pivots at the front of the frame, straight wooden handlebars surmounting it. Also serving as a pivot point for the front fork is the upper end of a nearly vertical wooden brace, the lower end of which is connected by iron bars to the lower extremity of the frame.

Both the wheels have wooden hubs, spokes, and felloes, with thin metal tires. Each wheel has 14 spokes staggered in the hub. The diameter of the front wheel is 38 inches and of the rear, 28¾ inches. Wooden crank arms, having a 5-inch throw but not adjustable as to their working length, are attached to the front axle. Spool-shaped wooden pedals are mounted at the ends of the arms.

Oil cups are mounted at each end of the two axles. A wide wooden mudguard is affixed above the rear wheel. The saddle is made of wood, canvas, and leather. There is no brake.

The finish on this velocipede is black with both gold and red striping. The mudguard bears a large piece of gold-leaf scrollwork similar to that found on Concord coaches and other horse-drawn commercial vehicles, and the front fork bears gold-leaf scrollwork that is more delicate.

Velocipede, about 1879

Gift of Joseph Z. Collings in 1889

No marks of identification have been found on this velocipede, yet the general construction very strongly resembles that of the 1879 Shire, while the steering head is very much like that of an early Columbia. For these reasons its date is believed to be the same as that of the Shire, which is rather late for this type of machine.

The frame consists of two wooden members attached to an iron fitting at the front, a broad wooden mudguard, and a steel single-leaf spring reminiscent of the lower part of the nearly vertical wooden brace of the Shire velocipede. Similarly, from a point near the rear hub a pair of iron braces runs to the rear mudguard and another pair to the lower end of the steel spring. Thus, the wooden frame alone does not bear the rider's weight, being assisted by the mudguard and spring. A Shire-type suspended saddle has horsehair padding on a heavy canvas base, and is covered with enameled cloth. The front fork of this velocipede, unlike the Shire, is of iron, having an open head that accomodates a long steering spindle. There is evidence that there was once a brake, operated by the right hand, similar in design to that of a Columbia Ordinary, but none of the parts remain. The 24-inch handlebar is of turned wood.

The 30-inch rear wheel has 14 staggered spokes and the 40-inch front wheel has 16 spokes. Both have $\frac{7}{8}$ -inch iron tires. The spokes, unlike those of carriages and most other velocipedes, are turned round over their entire length, and are slightly tapered. The axles of both wheels are fixed in the hubs, and turn in split bronze bushings equipped with oil holes. These bushings are retained in the clevis-like ends of the front fork, and in iron fittings bolted to the rear frame, but a single bolt for each. Triangular wooden pedal-blocks are fitted to the $5\frac{1}{2}$ -inch cranks on the front wheel.

The finish of this machine, now in very poor condition, appears to have been red, ornamented by gold striping.

This velocipede has tentatively been dated 1879 because of its similarity to the 1879 Shire.

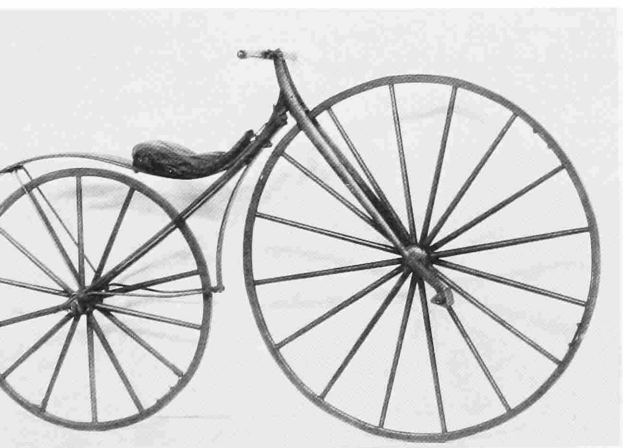

Hammelmann Tricycle (model), 1880

Transferred from the U. S. Patent Office

Patent 225,010 was issued on 2 March 1880, to Charles Hammelmann, of Buffalo, New York, for a velocipede. This model shows a tricycle propelled by two foot-operated, spring-returned levers that rock sector-racks meshed with ratchet gears on the front-wheel axle.

The model, measuring $8\frac{3}{4}$ inches long, $8\frac{1}{2}$ inches high, and $4\frac{3}{4}$ inches wide, is constructed of metal, with the exception of the wooden saddle. The frame consists of a curved bar at the rear, terminating in a fork at its lower end, and a vertical fork at the front, this fork pivoting in the steering head of the bar. A saddle is attached to the curved bar by means of a spring. At the top of the front fork are the handlebars. An axle at the bottom of the rear fork mounts two wheels, each $2\frac{1}{8}$ inches in diameter and having six spokes. The centers of the wide treads of these two wheels are $3\frac{1}{4}$ inches apart.

The front wheel is 6 inches in diameter and has 10 spokes. Its perimeter is grooved as if to mount a solid rubber tire, though it is not known if a tire was mounted on this model. Mounted on each side of the front-wheel hub are ratchet gears. The wheel and gears rotate as one unit on the stationary front axle.

Two foot-operated levers, spring-returned to their upper positions, are pivoted at the lower ends of the front fork, one on each side of the wheel. To each lever is attached a rack meshed with a gear that is mounted free on the front axle and next to the ratchet gear on its side of the wheel hub. A pawl on the free gear rotates the ratchet gear and the wheel in a forward direction when the foot lever is depressed. The two levers are independent of each other and are intended to be depressed alternately.

It is not known whether a full-scale version of this tricycle was ever manufactured.

Patent Office model of the Hammelmann tricycle, 1880.



Fowler Tricycle (model), 1880

Transferred from the U. S. Patent Office

Patent 224,165 was issued 3 February 1880, to Francis Fowler, of New Haven, Connecticut, for a tricycle equipped with a ratchet connection in the hub of each driving wheel. The purpose was to enable the outer of the two driving wheels to rotate freely on the crankshaft when the machine was making a sharp turn, thus performing the function of a modern automobile differential unit.

This model, measuring 11 inches long, 10 inches high, and 11 inches wide, is constructed of metal, with the exception of wooden grips on the handle bars and leather straps on the pedals of the cranks on the front axle. The frame consists of a curved bar at the rear, upon which a saddle is located, and a vertical forked frame at the front, pivoting in the steering head of the bar. At the top of the fork a horizontal bracket supports a rod serving as the handle-bars. This rod is free to be rotated within its supports in the bracket. Rotating the rod tightens a cord running down the curved bar and causes a brake shoe to bear against the single rear wheel mounted at the lower end of the bar. This wheel is $2\frac{3}{4}$ inches in diameter and has eight spokes.

On each end of an axle mounted at the bottom of the fork is a wheel $7\frac{3}{4}$ inches in diameter and having 10 spokes. The wheels are $8\frac{3}{4}$ inches apart. Cranks connect the axle and the wheel hubs.

Each front-wheel hub incorporates a pair of double-crown ratchet gears held together by a spring in the hub. Forward movement of the axle drives the wheels, but when the cranking is halted and the axle is stationary the ratchets open and the wheels coast. Also, as stated before, the outer wheel slips when the machine is making a sharp turn. Each intermittent opening of the ratchets would cause the wheels to be forced slightly apart and would occasion considerable wear of the teeth, as well as a clicking noise, deficiencies not found in the 1869 Van Anden velocipede, with its pawl-and-ratchet device in the hub of the front wheel.

It is not known that this tricycle was ever manufactured.

Patent Office model of the Fowler tricycle, 1880.



Long Steam Tricycle, about 1880

Gift of John H. Bacon in 1956

The oldest completely operable self-propelled road vehicle on display in the Museum is a steam tricycle built about 1880 by George A. Long, of Northfield, Massachusetts. After a period of disuse following its construction, Long's original tricycle was disassembled and its parts scattered. In 1946, however, the donor of the vehicle obtained the engine, along with its feed-water pump and driving pulleys, from the 96-year-old builder who then was living in Boston. At that time Long recalled that many years earlier he had seen other parts of the machine in Northfield. A search by Mr. Bacon resulted in his obtaining most of the missing parts, and, subsequently led to the machine's restoration, which involved the use of some replacement parts.

George Eli Whitney of Bridgeport, Connecticut, constructed the replacement fire-tube boiler and its appurtenances, and Russell Davis of Leominster, Massachusetts, performed other important work in the tricycle's restoration. Whitney is well known as a designer and builder of pioneer steam automobiles in the mid-1890s, and his work greatly influenced the Stanley brothers of later steam fame.

Long designed and built the tricycle's engine at Northfield in 1879, and a year or so later he constructed the framework and running gear in Albert A. Pope's Columbia bicycle plant, located in the factory of the Weed Sewing Machine Company at Hartford, Connecticut.

On 29 August 1882 Long applied for a patent on a "steam road-vehicle" consisting of a 2-seated, self-propelled tricycle powered by a 2-cylinder steam engine using gasoline as fuel. For it he was granted Patent 281,091 on 10 July 1883. Drawings on the patent papers reveal a tricycle that closely resembles the Museum's restored vehicle. Interestingly, gasoline was specified as the fuel.

Long wanted to provide the front-wheel forks with improved steering heads that used small balls, such as those that appeared later on the steering heads of bicycles and motorcycles. At the time he constructed his tricycle, however, Long was unable to make such small balls, so he equipped the two steering heads with plain bushings.

The rear wheel, 5 feet in diameter, is the driving wheel. The two

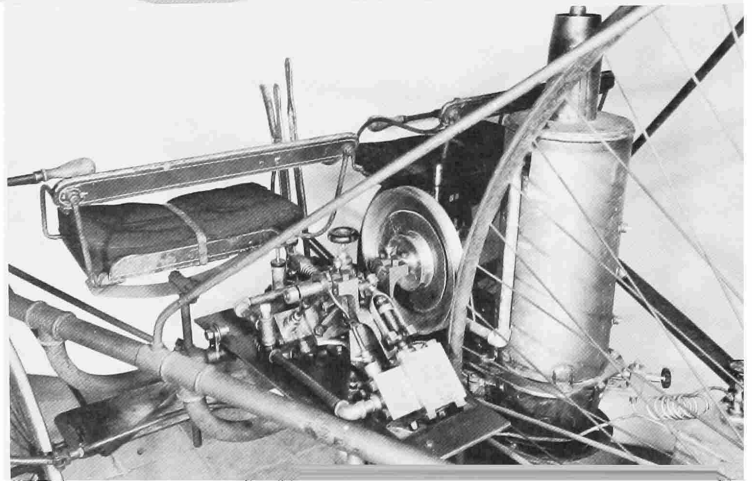
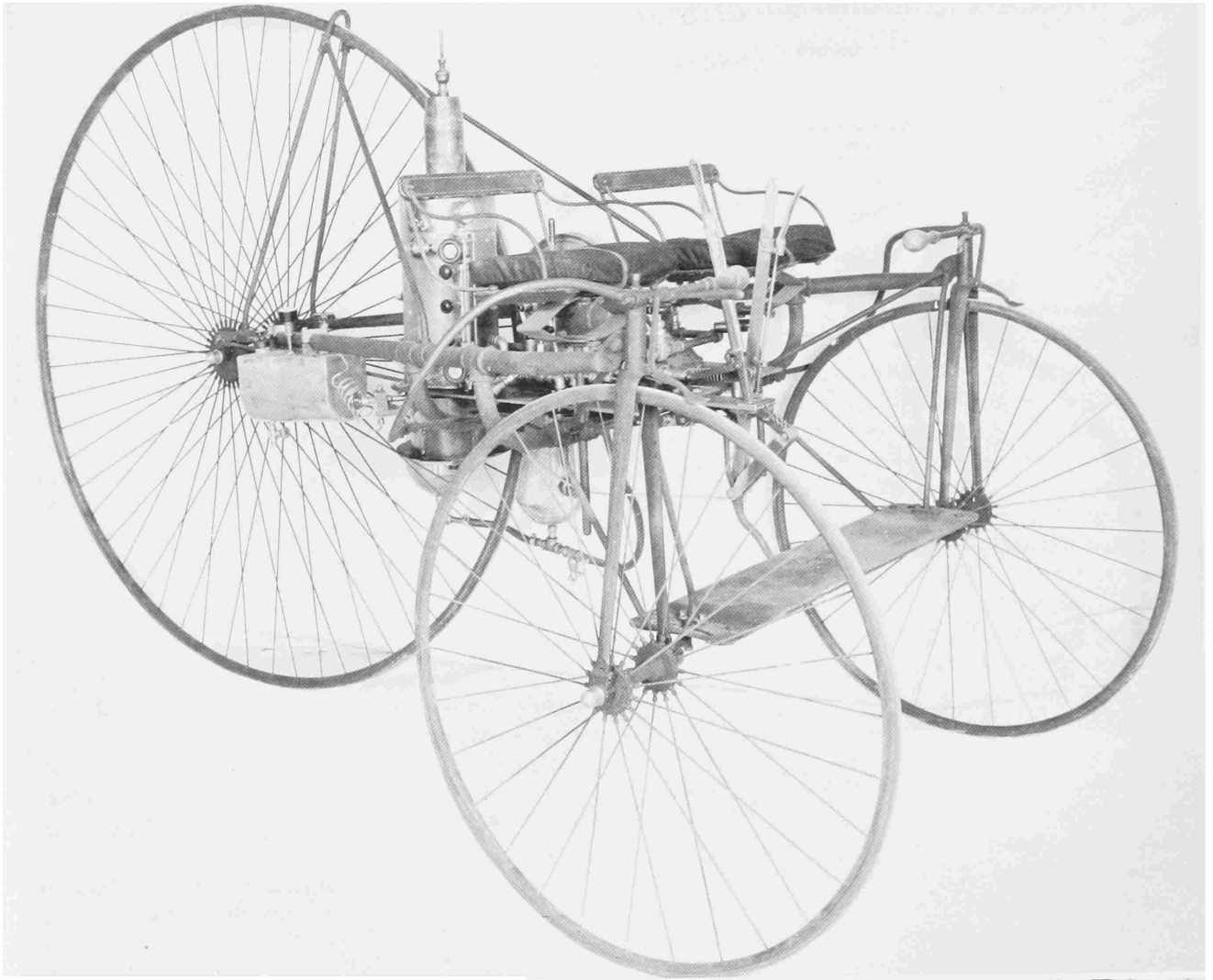

This steam tricycle, built by George A. Long about 1880, has been restored and is operable, but some of its parts are modern replacements. Below, left side, showing details of the 2-cylinder, V-type steam engine.

G. A. LONG,
STEAM ROAD VEHICLE.

No. 281,091.

Patented July 10, 1883.

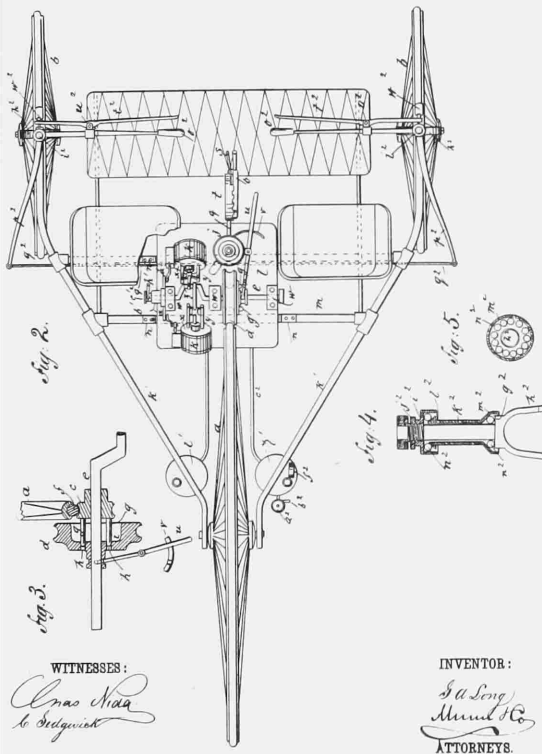

Drawing from the United States patent granted in 1883 to George A. Long for his steam tricycle.

front wheels, 3 feet in diameter, are mounted in steering forks whose heads are connected by a curved tie rod. Spoon brakes operate against each of the solid tires on the front wheels. The design of the steering and braking systems indicates that Long intended that the machine would be operated by two persons. A single driver would have difficulty in steering only one of the handlebars and in operating both brake levers. Each seat is mounted on a full-elliptic spring, and its height is adjustable.

The 2-cylinder, 90-degree, V-type engine has a stroke of $15\frac{1}{8}$ inches. It is attached to a steel plate that is mounted in the framework on small rollers so that it can be moved backwards and forwards by means of a lever pivoted in front of the seats. There are two pulleys on the crankshaft. The larger pulley is splined and can move lengthwise on the shaft. When the engine plate is brought backward, one of the driving pulleys is brought into contact with the tire of the rear wheel. As the pulleys have different diameters, two driving ratios are provided. The boiler and one of the two water tanks also are mounted on the engine plate, an arrangement which requires that the tube between the fuel tank and the burner (beneath the boiler) and the one between the two water tanks be flexible.

The vehicle's replaced parts include the boiler, burner, engine mounting plate, fuel and water tanks, all gauges and piping, the hand-operated air pump, and the water pump, which is from an early steam automobile.

The restored tricycle, weighing about 350 pounds, operates at a steam pressure of approximately 100 pounds per square inch.

Standard Columbia Ordinary, 1881

Gift of Paul E. Waring in 1970

This Standard Columbia Ordinary was originally owned by the donor's father, Mr. Frank E. Waring, in whose memory it was presented. Mr. Waring used this machine to participate in cycling activities in the Washington, D.C., area.

The Standard Columbia, built by the Pope Manufacturing Co., was available in models with front-wheel diameters ranging from 42 to 58 inches. This one, having a 54-inch front wheel with 44 radial spokes, and an 18-inch rear wheel with 18 radial spokes, weighs 49 pounds and sold for 95 dollars. The wheels have V-shaped steel rims, and now carry only remnants of the original red Pará rubber tires, which are of 1-inch diameter on the front wheel and 3/4-inch on the rear. The 1881 catalog states that this model was painted in two colors. The condition of this cycle is now such that its color is barely discernible, but it apparently was black, with no visible traces of the striping shown in the catalog illustration.

The tapering backbone, or frame, of this cycle is made of 1 1/4-inch tubular steel, to which are brazed the forged-steel rear fork and the steering spindle. The step for mounting is located on the left lower side of the backbone. The saddle apparently is not original, for it is a suspension type that differs considerably from that shown in the catalog. On the left side of the backbone, under the seat, is a brass manufacturer's nameplate.

At the upper end of the forged-steel front fork is the open steering head containing the long steering spindle, which can be adjusted by means of a bolt passing through the top of the head. Straight handlebars carry pear-shaped grips of Siamese buffalo horn, and a brake lever on the right side that operates the spoon brake on the front tire.

The front-wheel bearings are adjustable double cones, fitting into hardened boxes in the hubs. They are adjusted for wear by an eccentric in the bottom of the fork. The adjustable pedal cranks allow the throw to vary from 5 to 6 inches. The pedals are equipped with cone bearings and dust caps.



Standard Columbia.

Our Columbia, in its hitherto well-known form, has proved itself an excellent and reliable roadster, but in order to keep abreast with the best improvements and the demands of experienced riders we have introduced some improvements, at considerable expense, yet without additional price to our patrons; and this form, which is more nearly like the old, and is especially adapted for road use, we now distinguish by the name of STANDARD COLUMBIA; and we recommend it to all beginners and to all who want a first-class substantial road machine.

(8)

Illustration of the 1881 Standard Columbia from the catalog of its maker, the Pope Manufacturing Co., of Hartford, Connecticut.

Klahr Bicycle (model), 1883

Transferred from the U. S. Patent Office

Patent 285,821 was issued on 2 October 1883 to William Klahr, of Myerstown, Pennsylvania, for a bicycle of the Star type, propelled by single-acting pedal levers in combination with racks, pinions, and clutches on the rear axle. No evidence has been found to indicate that it was ever manufactured.

The model, measuring 6 inches long, $4\frac{1}{2}$ inches high, and 1 inch wide, is constructed entirely of metal with the exception of the tires. The triangular frame supports a vertical steering fork with a small wheel at the front, and a large driving wheel at the rear. Both wheels are radially wire-spoked and are $1\frac{1}{2}$ inches and $3\frac{1}{2}$ inches in diameter, respectively. The upper extension of the fork is at an angle to the fork itself, and is fitted with handle bars at its upper end. A coil spring tends to keep the fork centered, with the wheel headed straight ahead on the machine.

A rear extension of the lower, horizontal forked member of the frame extends back of the rear-wheel axle, on each side of that wheel. The long curved arms, with pedals at their front ends, are pivoted from the rear ends of these extensions. Extending upwards from each arm are slightly curved racks that mesh with a gear on the axle of the rear wheel. Each of these gears incorporates an over-running clutch, so that when the arms are depressed by foot pressure the gears will drive the rear wheel forward. When the arms return by spring pressure to their upper positions, the overrunning clutches operate, and so do not hinder the forward motion of the machine. The two arms are independent of each other but are intended to be depressed alternately. Parts of the gearing is missing from the right side of the model.

A saddle is located on a leaf spring over the rear wheel. A spring-returned foot brake, operated by the left foot, is mounted in front of the rear wheel, and rubs against the rear tire.

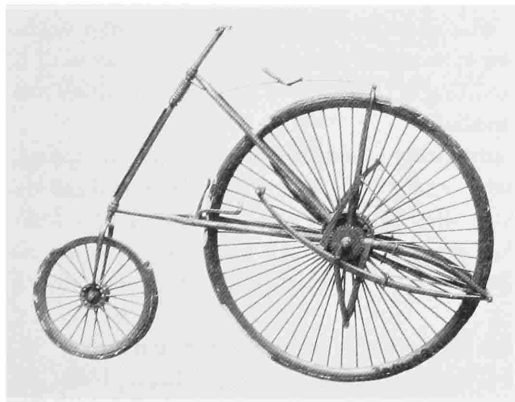

Patent Office model of the Klahr bicycle, 1883.

Smith Star Bicycle, 1884

Gift of Thomas M. Wilkins in 1908

1884 Star bicycle as restored in 1960, held by A. A. Balunek, aide in the division of transportation, 1959-61. This is the cycle shown on the cover.



Built by the H. B. Smith Machine Company, of Smithville, New Jersey, this cycle bears the serial number 1200, and patent dates of 1880 and 1884. According to the donor, this machine was given to his father, B. F. Wilkins, around 1900. Mr. Wilkins, a member of the Capitol Bicycle Club of Washington, D.C., never rode it, as it was considered a relic when he acquired it.

One side of the triangular metal frame consists of a tube for the steering post, at the lower end of which is a fork supporting the front wheel. Straight handlebars are attached to the upper end of the post. The metal front wheel, fitted with a solid rubber tire 23 inches in diameter, has 28 radial wire spokes. The rear wheel, also fitted with a solid rubber tire, is 55 inches in diameter and has 64 radial wire spokes.

Spring-returned, overrunning clutches are attached to the ends of the rear axle. The wheel is turned by leather straps wound on the clutches and attached to pedal levers (see the description of the Smith tricycle of 1888). The effective attachment point of the straps to the levers can be adjusted to either of two positions by means of a pivotal linkage, thus providing a “gear shift,” so to speak, since two driving ratios are made available.

The leather saddle is adjustably mounted upon a broad flat spring. A brake, bearing against the rear tire, is operated by a linkage on the handlebars and is controlled by the rider’s right hand. The linkage is returned by a coil spring to the “off” position. Another coil spring, located at the base of the steering post, serves as a shock absorber.

Finished in black, the Star bicycle was restored by Henry W. Mathis of the Southeast Cycle Shop, Washington, D.C., in 1960.

Boy's Ordinary, 1885

Gift of Elbert C. Wood in 1959



Boy's Ordinary of 1885, as restored in 1961.

This boy's Ordinary was purchased in New York City in 1885 by the father of the donor. No markings can be found that identify the maker, and it is not safe to make assumptions, yet the similarity to it of the 10-dollar Otto cycle of this size, made in 1887 by the Western Toy Company of Chicago, suggests that this could be an earlier model of the Otto.

The 32-inch and 12-inch wire-spoke wheels have half-round iron rims, $\frac{5}{8}$ inch and $\frac{7}{16}$ inch wide, respectively, that also serve as the tires. A backbone of T-iron joins the malleable-iron rear fork to an adjustable spindle in an open steering head similar to that of the 1881 Standard Columbia. The step on the left side of the frame, the front fork, and the wheel hubs, all appear to be of malleable iron.

The iron handlebars have wooden grips, and a leather-covered iron saddle is suspended on a single-leaf spring, the rear end of which slides in a keeper on the backbone.

This machine was restored by Henry W. Mathis of the Southeast Cycle Shop in 1961, at which time the present black finish was applied.

Columbia Light Roadster Ordinary, 1886

Gift of Lawrence Worstall in 1921



Columbia Light Roadster Ordinary of 1886, made by the Pope Manufacturing Co., of Hartford, Connecticut. It was restored in 1968.

Owned in turn by Herschal Mulford and Lawrence Worstall, of Millville, New Jersey, this early Columbia Ordinary is the Light Roadster model of 1886.

Sold originally for approximately 135 dollars, the Light Roadster is a lighter version of the Expert model and weighs approximately 36 pounds with all equipment, as compared to 45 pounds for the Expert.

The Light Roadster was available with seven sizes of front wheel, from 47 to 59 inches, and two sizes of rear wheel, 16 or 18 inches, depending on the size of the front wheel. This example is fitted with a 60-spoke, 53-inch front wheel, and a 20-spoke, 18-inch rear wheel, these dimensions including the thickness of the solid rubber tires.

The felloes of the wheels are of seamless steel tubing rolled into a hollow crescent, the spokes are of steel wire, and the hub flanges are of light forged steel rigidly secured to steel axles. The axles are mounted on adjustable ball bearings.

Adjustable, detachable cranks providing from 4¼ to 5¼ inches of throw are fitted to the front axle, with rubber-covered pedals attached to the cranks.

The curved perch has a tapering, circular cross section and is made of imported, cold-drawn, seamless steel tubing; the front fork is of the same material but elliptical in cross section; and the rear fork is semitubular.

The steering head is cylindrical and slightly tapered. The handlebar lug is forged solid with it.

The machine is equipped with a Kirkpatrick-type leather saddle suspended on fore-and-aft springs; hollow, curved handlebars of steel tubing fitted with pear-shaped vulcanite handles; a step attached to the lower left of the perch; a steel leg guard; and a friction brake, operated by the rider's right hand, that works against the tire of the front wheel.

This Ordinary was restored by Henry W. Mathis of the Southeast Cycle Shop in 1968, at which time the present black finish was applied.

Overman Victor Ordinary, about 1886

Gift of Edward Hosea Sithens in 1921

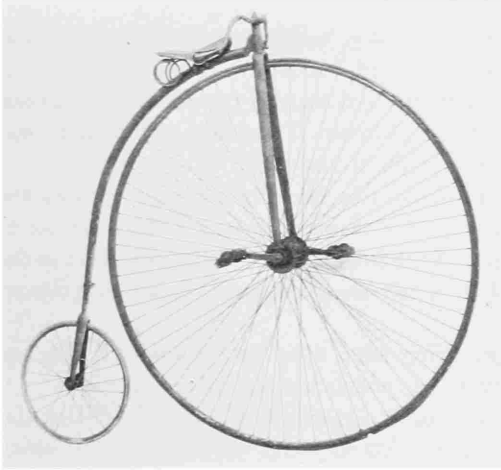

*This Overman Victor Ordinary was used
for racing in the late 1880s.*

This Ordinary, built by the Overman Wheel Co., of Boston, Massachusetts, was their Victor model, and was ridden to many racing victories in the late 1880s by Stacy Cassady, of Millville, New Jersey. It was probably built in 1886, as the latest patent date on its nameplate is 1 December 1885.

In appearance it is very similar to the Columbia Light Roadster, though larger and of heavier construction. The front wheel is 54 inches in diameter and contains 72 wire spokes, while the rear wheel is 18 inches in diameter, with 24 wire spokes. The spokes are tangentially laced to the hubs.

Adjustable cranks with rubber-covered pedals provide for a throw of from 5 to 5¾ inches.

The machine is equipped with a leather saddle, a step attached to the lower left of the curved perch, and curved handlebars. The lever-operated spoon brake that once operated against the tire of the front wheel is now missing.

Humber "Genuine Beeston" Racing Ordinary, 1886

Gift of Albert E. Schaaf in 1934

Humber "Genuine Beeston" lightweight racing Ordinary, made in England in 1886, as restored by donor.

This lightweight racing Ordinary, weighing only 24 pounds, was built by Humber and Co., Ltd., of Beeston, Nottingham, England, in 1886 and was completely restored to new condition by its donor before being presented to the Museum. This make of Ordinary was ridden by many world's champions in the 1880s.

As does the Overman Victor, this Humber closely resembles the Columbia Light Roadster of 1886 in general shape. The diameter of the front wheel, with its solid rubber tire, is 52 inches, and that of the rear wheel, 18 inches. The wheels are fitted, respectively, with 60 and 20 radial wire spokes.

Adjustable cranks, providing from 4 to 5½ inches of throw, are attached to the front axle. The pedals are not rubber covered.

The leather saddle is secured directly to the perch without the benefit of springs, and there is no step and no brake, all of which aided in keeping the weight to a minimum. The curved handlebars are fitted with smooth, white grips.

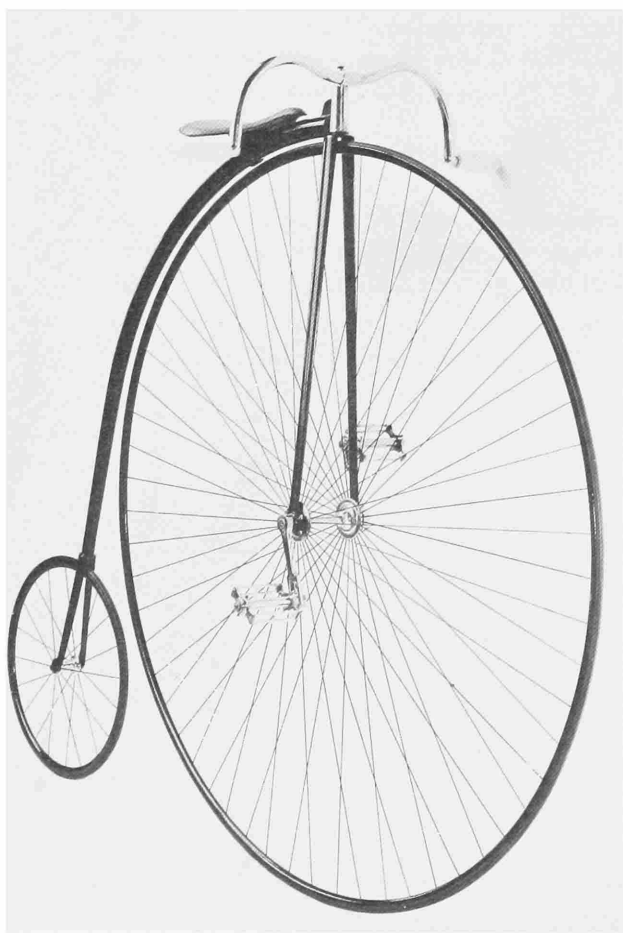

Starley Psycho Safety Bicycle, about 1887

Gift of J. E. Hosford in 1903

This bicycle, built by Starley Brothers, St. John's Works, Coventry, England, is of the improved cross-frame, Safety type, with a crank-bracket stay, a stay between the steering head and the top of the saddle post, and a pair of stays from the rear end of the rear fork to the top of the saddle post. For it, the manufacturers of this machine were awarded a gold medal at the International Exhibition at Toulouse, France, in 1887.

The frame is of metal tubing, the handlebars are metal with wooden grips on each end, and the Brooks saddle, of leather over coil springs, is adjustable both vertically and fore and aft.

Each wheel, 30 inches in diameter, has a thin solid rubber tire and 48 radial wire spokes. The rear-wheel sprocket, on the right side of the wheel, is driven by a block chain from the front sprocket, which is equipped with pedals adjustable in throw from 5½ to 6½ inches. The chain tension is adjusted by moving the rear axle backwards or forwards in slots at the rear end of the rear fork. There is no coaster attachment, the pedals always turning while the bicycle is in motion. Oil cups are provided in the hub of each wheel.

A metal mudguard is secured over the rear of the front wheel, but only the lower portion of the rear mudguard remains. A small foot-rest is attached to each side of the front-wheel fork, for use while coasting, and a step is attached to the left side of the rear fork for use when mounting the machine. A warning bell is affixed to the left handlebar, and a lever for hand operation of the front-wheel brake spoon is pivoted on the right handlebar. A flat leaf spring normally holds the spoon away from the tire. A support for a headlamp, now missing, is mounted on the upper part of the front fork so that the lamp's rays would always be thrown in the direction of the front wheel's travel.

The attractive original finish—black with red and gold striping—was duplicated in 1968 when the Psycho was restored in the Museum's shop.

Starley Brothers Psycho Safety bicycle of about 1887. It was restored in 1968.



Rudge Racing Ordinary, about 1887

Gift of Carl and Freda Von Sothen in 1960



Rudge racing Ordinary of about 1887, with its original owner, Godfrey A. S. Wieners.

One of England's prominent bicycle manufacturers was D. Rudge & Co., of Coventry. This racing model, undoubtedly sold by their U.S. agents, Stoddard, Lovering & Co., of Boston, Massachusetts, was originally owned by Godfrey A. S. Wieners who used it in racing events held by the Manhattan Athletic Club.

The backbone and front fork are of seamless steel tubing, the latter being oval in cross section. The back fork is semitubular. An adjustable Andrews-pattern long-center steering head joins the backbone to the front fork. Adjustable ball bearings are fitted into the front fork and the rear wheel hub. Cow-horn handlebars carry spade handles with vulcanite grips. As is common with racing cycles, there is neither a brake nor a mounting step.

The 58-inch front wheel has 52 tangential spokes brazed together at the points where they cross one another and a Clement hollow steel rim made from seamless tubing. According to the manufacturer's claims, this rim could supposedly carry the weight of a normal rider even before the spokes were put in. The 16-inch rear wheel has 20 radial spokes. Tires of red Pará rubber are of $\frac{5}{8}$ -inch diameter in front and $\frac{1}{2}$ -inch in the rear, the unusually thin tires being typical of a racing cycle. Ball-bearing pedals with corrugated white rubber pads turn on cranks that adjust from $4\frac{1}{2}$ to 5 inches.

The saddle now on the bicycle appears to be the Townsend patent suspension saddle shown in the catalog, yet the springs are not identical. A long, sliding leaf spring now carries the saddle, though the rear slide loop is missing. Obviously this saddle is incorrect, for not only is it ill-fitting, but the catalog shows a simplified unsuspended type for the racing cycle. Further, the spring bears the name of Stoddard, Lovering & Co., along with the words, "Rudge Light Roadster."

Nickel plating once covered the handlebars, hubs, cranks, and pedals. The other parts, including the spokes, were black. Two shield-type emblems, once mounted on the backbone behind the seat, are now missing.

Two-Track Tricycle, about 1887

Gift of Mr. and Mrs. Grover C. Richards in 1968

No markings of identification have been found on this tricycle, yet it is so nearly identical to the Ideal tricycle shown in the 1887 catalog of the Gormully & Jeffery Mfg. Co., of Chicago, Illinois, that it may not be unreasonable to assume that this is one of their products. It was used by Mrs. Richards during her childhood.

This is known as a two-track tricycle, meaning that the single front wheel is in line with one of the rear wheels—in this case, the right wheel—so that fewer obstacles are encountered than with the symmetrical three-track tricycle with its front wheel in the center. The rear wheels are 34 inches in diameter, each having 36 radial spokes and $\frac{3}{4}$ -inch red Pará rubber tires on steel rims. The front wheel is 16 inches in diameter, with 18 radial spokes and a $\frac{5}{8}$ -inch tire. Rear wheel track is 24 inches. The framework is of seamless steel tubing, tapered where necessary, and consists of the rear axle housing, two members angling downward to support the pedal cranks, another angling toward the rear to prevent tipping over backward, and the arm leading to the front wheel.

The steering head has a long spindle similar to that found in many of the Ordinaries, such as the Columbia. On the left side of the fork is an arm, from which a rod runs backward to the rack-and-pinion steering assembly located to the right of the rider. To either side of the rider is a vertical arm on which a vulcanite handlegrip is fitted, the right one serving as the steering control, while the left one serves merely to steady the rider. Both handles are adjustable for height, as is the spring-mounted suspension saddle; the latter can also be adjusted forward and backward.

The pedal shaft is mounted in front of the rider in adjustable bearings so that the slack of the chain may be taken up. The throw of the cranks is $3\frac{1}{2}$ inches. Both the front sprocket and the wheel sprocket have 16 teeth, so that the tricycle is, in effect, direct-drive. A bronze chain guard is provided for the now missing 1-inch-pitch block chain. Driving force was applied to both rear wheels, which was a practical advantage, for if the power is transmitted to one wheel only, the tricycle tends to turn toward the opposite side. Since both rear wheels are driven, a small differential is necessary, this being attached to the hub of the left wheel.

This illustration from an 1887 Gormully & Jeffery catalog shows a tricycle nearly identical with that in the Museum's collection.

26 GORMULLY & JEFFERY MFG. CO., CHICAGO, ILL.

THE IDEAL TRICYCLE.

(TWO TRACK.)

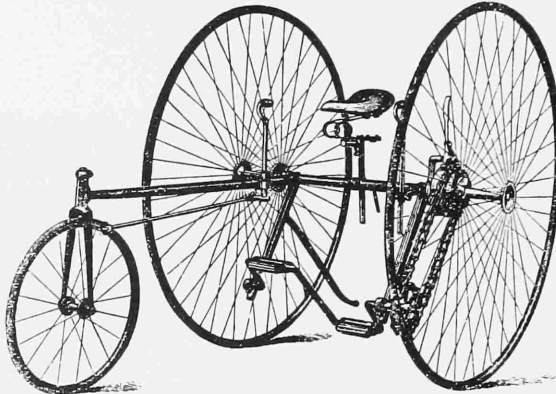

Diameter Drivers	Price Standard Finish.	Price Full Nickeled.	Weight.	Weight of Crate.
30 inches	\$40 00	\$55 00	47 lbs.	24 lbs.
34 "	45 00	60 00	51 "	25 "

Ball Bearings to Driving Wheels	Extra, \$14 00
" " " Steering Wheel	" 4 00
" " " Cranks	" 10 00

This really beautiful little machine has received every care and is listed now for its second season with a well-earned reputation of being just what we claimed for it when we introduced it to the cycling public last year, and of a quality both in material and manufacture that will compare very favorably with larger and costlier machines. It is and was as a tricycle what its

A brake drum, 4 inches in diameter and $\frac{7}{8}$ inch wide, is attached to the sprocket of the left wheel, a vertical hand lever operating a leather-lined steel band against the drum.

Lubrication is provided through oil cups on the front hub, pedal shaft bearings, rear axle bearings, and the left hub. The right hub requires none since it is fixed permanently to the axle.

Though many cycles that were made for children were inferior in quality, an examination of this one reveals that it has been carefully engineered and finely constructed. While it has not yet been restored, it is obvious that nickel plating originally covered the hubs, seat springs and support post, handle posts, brake, steering parts, and pedals, though the pedal cranks appear to have been painted black. The wheel rims, front fork, and frame were finished in black, and traces of fine gold striping can still be seen on the frame.

Columbia Light Roadster Ordinary, 1888

Gift of Albert E. Schaaf in 1949



This Ordinary, a Columbia Light Roadster of 1888, is very similar, both in design and appearance, to the corresponding model of 1886, though it was sold for slightly less, approximately 125 dollars. Its weight, with all equipment, is 42 pounds.

This example is fitted with a 68-spoke, 53-inch front wheel, and a 20-spoke, 18-inch rear wheel. The wire spokes are tangentially laced to the hubs.

The adjustable cranks, attached to the front axle, provide a throw of from 5 to 6 inches. The pedals are rubber covered.

The slight differences between this and the 1886 model include the method of springing the saddle, the shape of the handlebars and of the grips, and the fact that the step is adjustable.

This machine was completely restored to new condition by its donor before being presented to the Museum. It is finished in black paint and chromium plate.

Columbia Light Roadster Ordinary, 1888 model, as restored by the donor. Catalogs of the Pope Manufacturing Co. reveal that 1892 was the last year it offered high-wheeled bicycles and that it never made machines of the Star type.

Smith Tricycle, 1888

Gift of Robert Atwater Smith in 1901

This tricycle was made by the H. B. Smith Machine Co. in about 1888. It was restored in 1961.

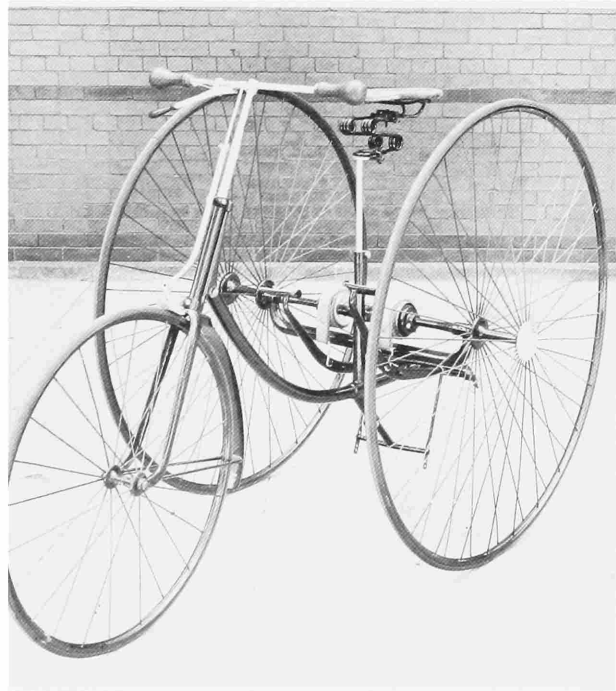

According to the donor, this vehicle was called the American Lever tricycle, yet there is no evidence in any of the Smith catalogs to substantiate this statement. It was made by the H. B. Smith Machine Co., of Smithville, New Jersey, the well-known manufacturer of Star bicycles, who apparently offered tricycles during 1887 and 1888. The wheel size of this one seems to date it in the latter year.

The rear wheels of the tricycle have separate axles, each independent of the other, and they are rotated by pedal levers that, when depressed, pull on straps wound around overrunning clutches on the axles. Springs return the drums of the clutches to rewind the straps when the pedal levers are allowed to rise. Each wheel is provided with its own axle, clutch, strap, and lever combination. The straps can be easily attached to either of two positions on the levers to provide two different mechanical advantages, or driving ratios.

The frame is of metal tubing. The three wheels have metal rims with radial wire spokes, and are of the type used by Smith. Diameter of the rear wheels is 40 inches and of the front wheel, 25½ inches. The track of the rear wheels is 29½ inches. Thin, solid rubber tires are mounted on the wheels.

A wooden saddle (not original) mounted on springs is attached to the upper end of a rod that can be raised or lowered to suit the rider. A lever, actuating a friction brake that rubs against the tire on the front wheel, is pivoted on the right handlebar. A small metal mudguard is secured over the rear of the front wheel.

This tricycle was restored by Henry W. Mathis of the Southeast Cycle Shop in 1961. At that time, the original black finish was duplicated.

St. George's New Rapid Bicycle, 1889

Gift of H. K. Griffith in 1899

This bicycle is one of the improved cross-frame, Safety type, with a chain strut, a crank-bracket stay, and a stay between the steering head and the top of the saddle post. It is an example of one of the many makes of English bicycles of the 1880s and was manufactured by the St. George's Engineering Co., of Birmingham, England.

The frame is of metal tubing, the tangentially wire-spoked wheels are of metal with thin solid rubber tires, the handlebars are metal with wooden grips on each end, and the leather saddle is mounted on springs. The lower end of the vertical section of the frame is articulated, the single chain strut being to the left of the rear wheel, as is the chain itself. Both this strut and the crank-bracket stay required adjusting in order to swing forward the articulated section of the frame for tightening the chain tension.

The diameter of the rear wheel is $31\frac{1}{2}$ inches, and that of the front wheel is 30 inches. Each contains 48 spokes. The rear-wheel sprocket is driven by a block chain from the front sprocket, which is equipped with pedals adjustable in throw from $4\frac{3}{4}$ to about 6 inches. There is no coaster attachment, the pedals always turning while the bicycle is in motion. Oil cups are provided in the hub of each wheel.

A small metal mudguard is secured over the rear wheel, and it is thought that originally another was located over the rear part of the front wheel. A small footrest is attached to each side of the front-wheel fork, for use while coasting. A step is attached to the left side of the rear fork, for use by the rider in mounting the machine. A warning bell is attached to the left handlebar, and a lever for hand operation of the front-wheel brake spoon is pivoted on the right handlebar. A coil spring normally holds the spoon away from the tire.

A small leather tool bag hangs from the steering-head stay. Attached to a bracket on the front of the steering head is an oil lamp marked "Zacharias & Smith, Bicycle Sundries, Newark, N. J." In addition to the round clear glass in front, the lamp is fitted with a green glass in the right side and a red glass in the left side.



*New Rapid Safety bicycle, made in
England in 1889.*

Overman Victoria Bicycle, 1889

Gift of Miss May H. Mead in 1903

Made by the Overman Wheel Co., of Boston, Massachusetts, this Safety bicycle was their Victoria model, for women. It bears a nameplate carrying patent dates ranging from 20 November 1877 to 9 July 1889.

This type of bicycle with a drop frame was invented so that a woman could sit astride without having her skirt caught on the cross bar. Its adoption greatly increased the popularity of the bicycle and helped make cycling a sociable recreation as well as a sport and a means of transportation.

The frame is of metal tubing, the wheels are of metal with tangential wire spokes, the thin tires are of solid rubber, and the curved handlebars are of metal with spade handles on each end. The saddle, made of leather stretched across several sets of coil springs, is adjustable vertically and fore and aft. A curved brace at the bottom of the frame serves to strengthen it.

The front wheel is 28 inches in diameter and contains 24 spokes. The rear wheel has the same diameter but contains 32 spokes. The rear-wheel sprocket, which is on the right side of the wheel, is driven by a block chain from the front sprocket, the latter being equipped with pedals having a nonadjustable throw of $5\frac{3}{4}$ inches. Adjustment of the chain tension is obtained by moving the rear axle backwards or forwards in slots at the rear end of the rear fork. There is no coaster attachment, the pedals always turning while the bicycle is in motion. Oil cups are provided in the hub of each wheel.

The front fork of the machine is of interesting construction, being designed to reduce the road shocks transmitted to the handlebars. It consists of a pair of hinged, straight arms and a set of four curved spring arms, so arranged that the straight arms, which are compression members, act to steady the movement of the spring arms, which carry the load and reduce the road shocks. Footrests are attached to the outer sides of the spring arms, for use while coasting. A small mudguard is secured at the rear of the front wheel.

A large mudguard is mounted over the rear wheel, a chain guard surrounds the chain almost completely, and twine laced on the mudguard and the chain guard protects the rider's skirts from becoming entangled in the wheel spokes or the chain.

On the right handlebar is a pivoted lever that controls a rear-wheel spoon brake by means of a system of wires and pivoted arms. A wire spring at the spoon normally holds it away from the tire. A headlamp support is mounted on the upper part of the front fork.

Finished in black, this cycle was restored in 1960 by Henry W. Mathis of the Southeast Cycle Shop.



Overman Victoria woman's Safety bicycle of 1889. It was restored in 1960.

Smith Pony Star Bicycle, 1891

Gift of Robert Atwater Smith in 1913

This Star bicycle bears the nameplate of the H. B. Smith Machine Co. with the serial number 3025 and patent dates of 1880, 1884, and 1885. Known as a Pony Star, it is believed to have been made in 1891, the year after J. B. Dunlop's invention of the pneumatic tire had found its way to America.

Patent Office records reveal that Patents 321,819 and 321,932 were both issued on 7 July 1885 to William S. Kelley, of Smithville, New Jersey. Both show bicycles of the Star type, and claim improvements in bicycles and tricycles.

This bicycle is very similar in appearance to the full-size 1884 Star previously described, its method of steering and operation being the same. The steering post is not within a tube, however. The front wheel, fitted with a solid rubber tire, is 23 inches in diameter and contains 24 spokes. The rear wheel contains 72 tangential spokes and is fitted with a 40-inch-diameter single-tube pneumatic tire, undoubtedly the earliest pneumatic tire in the Museum's collections.

The leather saddle, mounted on springs, is adjustable fore and aft. The handlebars are of the cow-horn variety and have spade-grips. A linkage operated by the rider's right hand causes a spoon brake to bear against the rear tire, the linkage being returned to the "off" position by a flat leaf spring. As on the earlier Star, two driving ratios are available by shifting the effective attachment points of the straps to the foot levers.



Smith Pony Star bicycle of 1891.

Columbia Model 41 Bicycle, 1896

Gift of Col. N. J. Wiley in 1950

This highly decorated, drop-frame bicycle was formerly the possession of Mrs. M. N. Wiley, mother of the donor, of Montgomery, Alabama. The frame is nickel plated, with gold-plated decorations. On the steering head appear the initials "MNW" in gold, emblazoned with small cut diamonds and emeralds.

High-carbon-steel tubing and 4½ percent nickel-steel tubing are used in the frame, the joints and brackets of which are machined forgings. Unlike the 1889 Overman bicycle, this Columbia machine has a double-drop frame, and two small gussets connect the bars for additional strength.

"Customized" Columbia woman's Safety bicycle of 1896.



The wheel rims, of laminated wood, are approximately 25 inches in diameter and have 28 and 36 tangential steel spokes, respectively, front and rear. They are fitted with 28-inch, single-tube, pneumatic tires. The tires are not original, but are replacements of about 1930. The hubs are machined from solid drop forgings of steel, and are fitted with detachable ball cases for the bearings. Each end of the front and rear axles is supported on a ball bearing. Lubrication is through oil holes in the wheel hubs.

The rear-wheel sprocket is driven from the front sprocket by a block chain on the right side of the machine. The tension of the chain is adjusted by moving the rear axle backwards or forwards in slots at the rear end of the rear fork. There is no coaster attachment, the pedals always turning while the bicycle is in motion. The nonadjustable crank throws are 6 inches in length, and the pedals are rubber covered and mounted on ball bearings. The two halves of the crank assembly are dovetailed together within the crank hanger, yet can be easily separated and removed from the hanger, which is fitted with two covered oil holes for lubrication of the crank ball bearings.

The curved, tubular handlebars, tipped with ivory grips bordered with wide silver bands, are embellished with gold-plated, flowerlike decorations, as is the frame.

A rear mudguard and a chain guard, also nickel-plated and decorated, are supplied, as is a hand-operated spoon brake operating on the front tire and controlled by a lever pivoted on the right handlebar. Twine is laced across the chain guard and the rear mudguard to protect the rider's clothing.

The decorated leather saddle is the Columbia Model 22, introduced in 1896. It consists of a black leather seat resting on a flat spring, with a spiral spring at the rear. It is adjustable vertically, as well as backwards and forwards.

An oil lamp marked "Aladdin, Tiffany & Co., sterling," fitted with a large clear lens in the front, and small red and green lenses in the left and right sides, is attached to a bracket at the front fork. Footrests are not provided on the fork. A decorated warning bell is fitted to the left handlebar.

This machine, a Model 41 Columbia, made by the Pope Manufacturing Co., of Hartford, Connecticut, weighs approximately 30 pounds, and bears the serial number 12877.

Columbia Model 43 Tandem Bicycle, 1896

Gift of Mr. and Mrs. Goldwin Goldsmith in 1928

After the drop frame, adapting the bicycle to women's use, was invented, the combination of the diamond frame and the drop frame, thus forming a tandem bicycle, became very popular.

This Model 43 Columbia bicycle, manufactured by the Pope Manufacturing Co., Hartford, Connecticut, was purchased in Washington, D.C., in the spring of 1896 for 150 dollars and was then used by the donors for a honeymoon tour through Europe.

The frame is made of high-carbon steel and nickel-steel tubing, the handlebars are tubular with vulcanite-tipped cork handles, and the wheel rims are of laminated wood.

The diameter of each wheel with tire is the same, 28 inches, the front wheel containing 36 tangentially laced steel spokes and the rear, 44. The hubs are machined from solid drop forgings of steel; and are fitted with detachable ball cases for the bearings. The tires on the cycle when it was presented to the Museum were 1¾-inch single-tube pneumatics made by the Hartford Rubber Works Co., a subsidiary of the Pope Manufacturing Co. These were in such deteriorated condition that they were replaced when the bicycle was restored in 1961 by Henry W. Mathis of the Southeast Cycle Shop.

The rear-wheel sprocket, on the right side of the hub, is driven by a block chain from the larger of the two-center sprockets. Another block chain connects the smaller sprocket of the center pair to the front sprocket. Tension of the rear chain is adjusted by moving the rear axle backward or forward in slots at the rear ends of the rear fork and that of the front chain, by turning the eccentrically mounted front-crank bearing bushing in the frame, thus moving the front sprocket backward or forward. The throw of the pedals is not adjustable, that of the front pedals being 6 inches and of the rear, 7½ inches.

There is no coaster attachment and the pedals always turn while the bicycle is in motion. No footrests are attached to the front fork for use while coasting.

The rear handlebars turn in unison with the front, a drag link connecting short arms attached to the lower ends of the steering posts.

A warning bell is secured to the left front handlebar, and a lever for hand operation of the front-wheel brake spoon is pivoted on the right handlebar. A small coil spring at the pivot normally holds the spoon away from the tire.

The two saddles are fully adjustable for position, and are made of leather and metal. In addition, the front saddle has a wooden base. A hand-operated tire pump is secured to the center section of the diamond part of the frame. There are no mudguards and no chain guard for the front sprocket, though both were originally available as optional equipment. The machine weighs approximately 46 pounds.

Columbia Model 43 tandem bicycle of 1896, as restored in 1961. Inset, the donors, Mr. and Mrs. Goldsmith, in Paris on their 1896 honeymoon tour of Europe with this bicycle.



Child's Safety Bicycle, about 1897

Gift of J. Ralph Cline in 1938

Safety bicycles built in small children's sizes were somewhat uncommon during the 1890s. This cycle, however, is a fairly typical example of those that were made, and was used by the donor in October of 1897 when he was 3½ years old. While no markings identify the maker, it is believed to have been built by the A. O. Smith Co., of Milwaukee, Wisconsin, makers (1914–19) of the well-known Smith Motor Wheel.

The frame, of steel tubing, is the conventional diamond type. The handlebars of bent wood are fitted with cork grips having brass ferrules that bear the inscription, "Made in Plymouth, Ind., U.S.A.," but this undoubtedly refers only to the grips. A hand-operated warning bell is mounted on the right handlebar. The saddle has a wood-and-metal frame with numerous web straps, adjustable for tension, and is covered with felt and leather. The badly deteriorated leather bears the date, or number, 1898 in several places, and some initials not decipherable.

The wheels are 12 inches in diameter and carry single-tube pneumatic tires. Drive is by the conventional chain and sprockets; no brake is provided.

Child's Safety bicycle of about 1897.



Clarke Gasoline Tricycle, 1897

Gift of Louis S. Clarke in 1947

In 1897, Louis S. Clarke of Pittsburgh, Pennsylvania, founded the Pittsburg Motor Vehicle Company, with himself as president and engineer, and constructed this experimental motor tricycle. With the experience thus gained, in the following year the company built a 4-wheel automobile, which is now in the Henry Ford Museum. The name of Clarke's firm was changed in 1899 to the Autocar Company—one of the few pioneer automobile companies surviving today.

Clarke's 1897 vehicle, which is known as the first Autocar, is a conventional tricycle equipped with a gasoline engine that drives the rear wheels. The frame consists of standard bicycle parts and some special parts designed and made by Clarke. The 1-cylinder engine has a mechanically operated exhaust valve and an automatic intake valve. On its crankshaft extension is a gear that meshes directly with



the ring gear of the differential. No gear changes are provided. A single lever operates both the clutch (located on the crankshaft extension between the engine and the driving gear) and a band brake on the drum of the clutch.

There is no throttle, but the engine speed can be varied by means of a spark-advance lever, and there is a fuel-flow regulator on the exhaust-heated, gasoline vaporizer. The main exhaust pipe leads into a small muffler. The gasoline tank is in the frame beneath the saddle, and the batteries and high-tension coil are in a box farther forward in the frame.

Bicycle pedals, with the usual sprockets and chain, enable the rider to start the engine and, in event of a breakdown, to propel the vehicle. An overrunning clutch is built into this gearing so that the pedals are not driven by the engine while the tricycle is in motion. The front wheel is supported in a steering fork equipped with handlebars.

The wire-spoke, bicycle-type wheels carry 26-by-2½-inch single-tube pneumatic tires, and Clarke has stated that the tire on the front wheel is an original.

The tricycle was restored in 1963 by Dale C. Price of Cambridge, Maryland. Some of the original parts have been replaced—the saddle, handlebar grips, spark plug, rear tires, and a relief pipe and valve on the engine's crankcase.

The 1897 Clarke single-cylinder gasoline tricycle was the first motor vehicle built by Louis S. Clarke, founder of the Autocar Company.

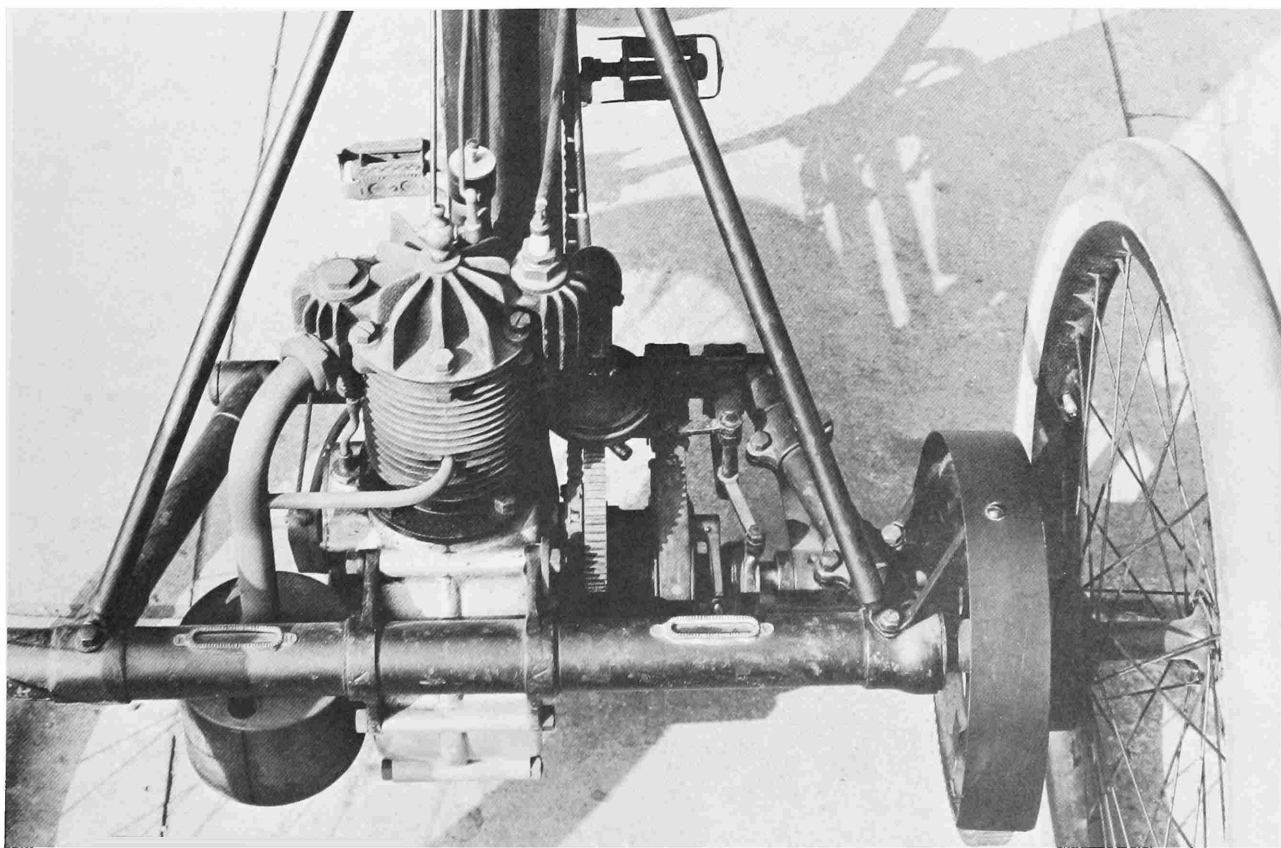

Rex Cycle, 1898

Gift of Anne Bray Schmidt, Margaret Wightman Schmidt, Katherine Greene Schmidt, and Nicholas Ward Schmidt in 1972

While it might seem inconsistent to apply the term “bicycle” to a 3-wheel machine, this is not a tricycle in the usual sense of the word. It was the invention of Bohn C. Hicks of Chicago, Illinois, who assigned his rights to the Rex Cycle Company, of the same city. Mr. Hicks obtained three patents on this type of machine in 1896, and another on a four-wheel “tricycle” in 1897. While this cycle does not entirely agree with the patent drawings, and there is no name plate on it, the diary of its original owner, Robert Wightman (great-grandfather of the donors), of Will County, Illinois, states that he went to Chicago on 23 June 1898 and bought a Rex cycle. Just two months later he made an entry to the effect that he “enlarged the bike house,” possibly to accommodate the greater length of this cycle.

The unusual construction of the Rex cycle resulted from Hicks' efforts to produce a machine “particularly adapted to absorb or minimize the shocks incident to riding over obstructions.” This objective, stated in the patents, was accomplished by mounting the seat near the front of a long tube, extending from a pivot near the front wheel to the smaller rear wheel.

Consequently, the successive upward movements of the front and driving wheels, as they passed over a bump, caused minimal upward movement of the pivot point and, hence, of the seat. Likewise, by reason of the distance from the small rear wheel to the seat being greater than that from the seat to the pivot, the subsequent upward movement of that wheel was also minimized. The cycle, in effect, undulated over bumps, leaving the level of the seat relatively unaffected.

The Rex cycle displays some of the conventional construction of a common Safety bicycle, except that it does not have the diamond frame. Instead, it is the cross-frame type, wherein the top tube is not horizontal but inclines downward in a straight line towards the rear hub, with those parts normally called back stays continuing to the hub from the point where the top tube terminates. From a point near the front of the down tube, a long, arching backbone is pivoted,

terminating between the rear and driving wheels at a double-pivoted fitting that surmounts a post from which forks extend to both of these wheels.

The present wheels are not the originals, though two of the original wheels accompanied the machine, and will eventually be reinstalled. The wood-rim wheels originally carried 28-inch single-tube tires, and the small wheel probably had a 16-inch tire. When these tires wore out and could not be replaced, a pair of 26-inch wheels and a 14-inch wheel were substituted. The present driving wheel has a New Departure coaster brake, whereas the cycle originally was not provided with a brake. The seat and pedals are later replacements, but the now fragile cork grips are original. Black enamel and the usual nickel-plated parts complete the finish of the Rex cycle.

Rex cycle of 1898. The original wheels were two inches larger in diameter.



Pierce Bicycle, about 1900

Gift of Barton A. Bean in 1928

This bicycle was built by the Geo. N. Pierce Co., of Buffalo, New York, also known as the makers of the early Pierce Motorette automobiles. In time, the Pierce automobile became known as the Pierce-Arrow, while the Pierce bicycles and Pierce 1- and 4-cylinder motorcycles were built by the Pierce Cycle Co., a subsidiary of the original company. The Pierce Cycle Co. was headed by Percy Pierce, son of George, when receivers were appointed for it in 1910.

To attain the utmost in simplicity and cleanliness a shaft-and-gear drive, having a pair of bevel gears at each end of the shaft, was used

The Museum's Pierce bicycle, built about 1900, was restored in 1961.



in place of the usual chain drive of the period. The drive shaft is contained in the right member of the lower rear fork. The elimination of sprockets and chain protected the rider's clothing from grease and damage, while the enclosing of the gears protected the mechanism from dirt. The rear hub is equipped with a New Departure coaster brake, a feature that began to be introduced on various cycles about 1898.

The wooden rims, 24 inches in diameter, mount single-tube, pneumatic tires. The front wheel contains 32 tangentially laced wire spokes, and the rear wheel contains 36. An oil hole with a sliding cover is provided in the rear hub. The nonadjustable pedal throw is 7 inches. The rear wheel is turned approximately three revolutions for each turn of the pedals.

The frame is sprung, both front and rear, for easier riding. Each side of the front fork is composed of several spring leaves, while the upper end of the upper rear fork incorporates a telescopic section containing a coil spring. The housing of the spring is marked "Pierce hygienic cushion frame, licensed by Hygienic Wheel Co.," and bears patent dates ranging from 21 July 1896 to 31 January 1899.

The curved, tubular, nonadjustable handlebars are fitted with grips which appear to be of leather. The saddle is a "Christy No. 3" and bears patent dates ranging from 15 January 1895 to 21 June 1898.

On the steering head of the frame appears a nameplate marked "The Geo. N. Pierce Co., Makers, Buffalo, N.Y., U. S. A.—Tried and True." The name "Pierce" also appears, backed by the design of an arrow. Patent dates on the plate range from 28 April 1895 to 10 May 1898.

In 1961 the Pierce bicycle was restored by Henry W. Mathis of the Southeast Cycle Shop, at which time the tires were replaced and the present black finish applied.

Anderson "Military Bicycle," about 1900

Gift of James C. Anderson, through Russell A. Conn in 1929

Patent 633,745 for a "military bicycle" was granted to James C. Anderson of Highland Park, Illinois, on 26 September 1899. Subsequently such a machine was built, following closely but not exactly the drawings of the patent application. The application says of it:

In a machine for personal locomotion, propelled wholly by the human body, whether used for transportation of the rider only or for the additional service of a carrier, especially for carrying the necessary equipments of a soldier, it is not only desirable that the machine should be compact and small as possible, but it should, as it were, fit the rider mounted thereon in an upright soldierly position, which position is manifestly best suited to the human anatomy and best conserves the human force of the body in propelling the machine, as well as in maintaining the proper equilibrium. In other words, the articulation of the body of the rider and of the machine should compensate each other, and in such a wheel it is also desirable that the rider should be able to mount in front, and when occasion requires to dismount forwardly or in the direction of the motion of the wheel, and hence it is important that his movements should not be obstructed by the usual arrangement of handlebars in front of him.

Actually the machine is somewhat like a small Star bicycle designed to go backwards, as the tubular, triangular frame has two wheels of different sizes, with the small one mounted in a fork for steering purposes. However, the fork and steering wheel are at the rear of the machine, rather than at the front as on the Star. The upper end of the steering post is fitted with a small gear sector worked by a similar sector fitted to the axis of the curved, tubular handlebars, so that turning the handlebars will turn the small wheel. Adjustable cork-covered grips are fitted to the handlebars, which are located behind the rider's legs.

A Christy saddle, bearing patent dates ranging from 15 January 1895 to 19 April 1898 is located directly above the gear sectors. The saddle is made of leather and horsehair on a metal frame, and faces in the direction of the larger wheel. A rider, seated on the saddle, would find his hands on the handlebars at a level slightly below that of the saddle. On the patent application appears the suggestion that the saddle post be geared to the steering post, so that by swinging the body and saddle the machine could be steered. The example, however, does not employ this interesting feature.

The wheel rims are made of laminated wood and are fitted with single-tube, pneumatic tires. Tangentially laced wire spokes are used. The front wheel is 20 inches in diameter and the rear, 11 inches. Each is marked "Fairbanks Boston laminated wood rim, Bradford, Penn., Bedford, Mass., Pat. May 9, 1893." The original tires, bearing a patent date of 23 May 1893 and the words, "Newton Upper Falls, Mass.," were so badly deteriorated that they were replaced in 1969, with tires donated by Henry W. Mathis, of the Southeast Cycle Shop.

The front wheel is driven by means of pedals and gearing, three revolutions of the wheel occurring for each turn of the pedals. The convertible pedals have both serrated steel edges and rubber pads, either of which may be turned upward at the discretion of the rider. Manufactured by the Lavigne and Scott Manufacturing Co., of New Haven, Connecticut, the pedals bear a patent date of 21 July 1896. The pedal throw, nonadjustable, is $6\frac{3}{4}$ inches. There is no operating brake, the machine being retarded by holding back on the pedals, but a parking brake, the lever of which is accessible only when the rider is dismounted, can be flipped against the tread of the front tire. This brake was necessary to prevent the cycle from drifting forward or backward off the free swiveling, telescoping tubular stands, located on each side of the cycle.

Within the triangular frame is a sheet-metal hanger for carrying a rifle, pointed forward and so situated that the rifle can be quickly seized by the rider. The framework of adjustable tubes and braces attached to the upper rear of the frame was apparently intended to carry equipment. A leather tool bag marked "Eclipse" is located beneath the framework.

It is apparently the only bicycle of its kind, and was probably built for Mr. Anderson by a local machinist who was obviously an expert craftsman, for the cycle is finely constructed. In spite of the quality of the workmanship, this is a most awkward machine, and those accustomed to riding conventional cycles find it almost impossible to balance. Its weight is approximately 45 pounds. The color, black, is customary for the period.

Anderson "military bicycle" of about 1900.



Wabash Child's Irish Mail Quadricycle, about 1900

Gift of Robert C. King in 1945

Used about 1900 by the donor when a child, this small quadricycle, or Irish Mail, as it was popularly called, was made by the Wabash Manufacturing Co., of Wabash, Indiana.

Of simple and inexpensive construction, the vehicle is made primarily of strap steel. The arched frame supports a pivoted axle at the front, and at the rear a crank axle to which only the right wheel is pinned, the left running free on it. The rear wheels, of metal with solid rubber tires, are 15 inches in diameter and have a tread of 16 inches. The rear axle and right wheel are driven by the fore-and-aft motion of a pivoted lever at the front of the frame, the lower end of the lever being connected to the crank of the axle. A wooden handle is at the top of the lever.

The front wheels, similar in construction to the rear, are 11 inches in diameter and have a tread of 15¼ inches. The axle is steered by the feet of the rider.

The wheelbase is 23½ inches. A rectangular wooden seat is secured to the top of the frame. The machine is painted red with white decorations.

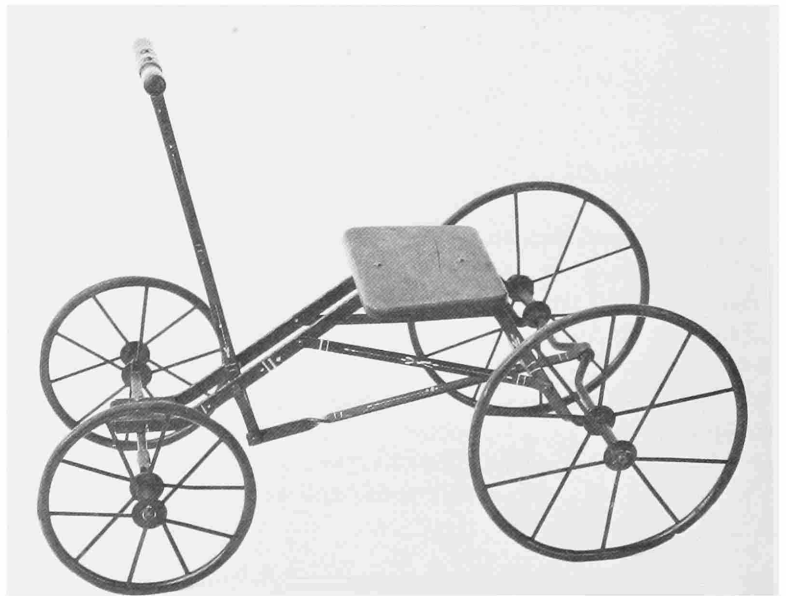

*Wabash quadricycle, popularly known as an
Irish Mail, of about 1900.*

Indian Motorcycle, 1902

Gift of B. E. Andre, through Indian Motorcycle Company in 1930

This motorcycle was designed in 1901 by the noted bicycle racer Oscar Hedstrom for the Springfield, Massachusetts, firm of Hendee Manufacturing Company, later (1924) known as the Indian Motorcycle Company. It is one of the 143 built in 1902, the year that the model was first offered for sale.

The 1¾-horsepower, 1-cylinder, 4-cycle, air-cooled engine, bearing the number 150, has an automatic intake valve and a cam-actuated exhaust valve.

The ignition system consists of dry cells and a coil, timer, and spark plug. The timer is advanced and retarded by means of a small

Indian motorcycle of 1902, the first year of production for its maker, the Hendee Manufacturing Company.



lever at the front of the frame to the right of the steering head. The same lever is also used to release compression—when moved to the retard position it lifts the exhaust valve from its seat—and it serves as the ignition switch.

Fuel adjustment is controlled by means of a lever attached to the crossbar of the frame. A two-sectioned tank on the rear fender supplies gasoline to a float-equipped Hedstrom carburetor and oil to the crankcase. The oil flows by gravity through a sight glass. A small exhaust pipe leads to a muffler beneath the crankcase.

A double-reduction sprocket-and-chain drive (on the left side of the frame) transmits power from the engine to the rear wheel. Since the machine has no clutch or change gear, the engine is connected to the wheel at all times. Supplementary power is available from a pedal-and-chain drive (on the right side) incorporating a New Departure coaster brake that engages when a slight backward pressure is applied on the pedals. The pedals remain at rest when the engine is propelling the machine.

The diamond-type frame is of tubular construction; the wood-rimmed wheels carry 28-by-1½-inch, single-tube, pneumatic tires; and the complete machine weighs just under 100 pounds.

Harley-Davidson Model 9-B Motorcycle, 1913

Gift of Paul Edward Garber in 1947

The Museum's 1913 Harley-Davidson, bearing engine number 4336-D and known as the Model 9-B, "5-35" (5 horsepower; 35 cubic inches displacement), originally sold for 235 dollars at the factory in Milwaukee, but it was purchased secondhand in 1918 by the donor, who used it for several years. It was restored in 1947 by the Harley-Davidson Motor Company.

The 1-cylinder, 4-cycle, air-cooled engine has a $3\frac{5}{16}$ -inch bore and a 4-inch stroke. The cylinder casting and its integral head are of heat-treated gray iron, and the heat-treated, ground piston is fitted with three rings and a hollow steel wrist pin. An I-beam section of chrome-vanadium steel, fitted at both ends with phosphor-bronze

*Harley-Davidson Model 9-B motorcycle of 1913,
as restored in 1947.*

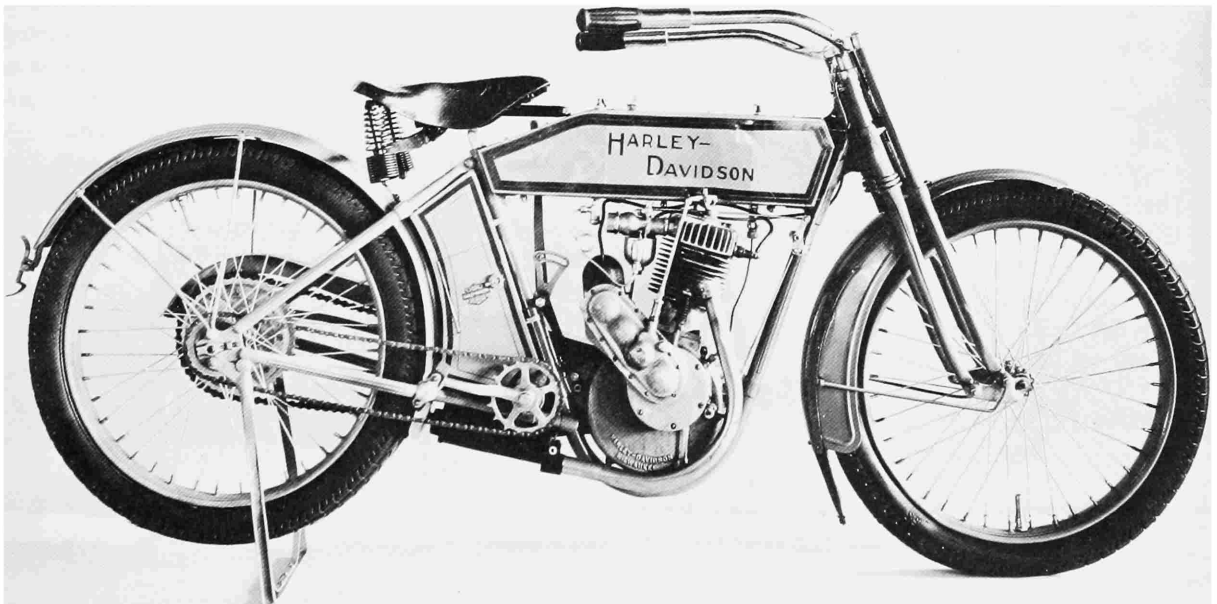

bushings, serves as the connecting rod. Separate camshafts for the intake and exhaust valves are driven by gears in the magneto drive train. The overhead intake valve is of nickel steel; and the exhaust valve has a cast-iron head and a nickel-steel stem. The crankcase is of polished aluminum, and the hardened, tool-steel crankshaft is mounted in the crankcase on phosphor-bronze bearings. The crankcase has an oil-drain plug and an overflow pipe.

Ignition is effected by a Bosch high-tension magneto with spark plug, and the fuel is vaporized by a constant-level, float-equipped Schebler carburetor. A priming petcock is in the left side of the cylinder head. A compartmented tank, with one section for gasoline and the other for oil, is mounted at the upper bars of the frame, above the engine. On top of each compartment of the tank are a filler cap and a shut-off metering valve. The oil for the engine passes by gravity through a sight glass into the crankcase. The spark timing is controlled by twisting the grip of the left handlebar, and the throttle, by twisting the right grip.

The loop-type frame of brazed tubing forms a cradle that supports and protects the motor. The handlebars are tubular, and the steering fork is fitted with both main and recoil springs. A narrow, metal toolbox is mounted vertically on the frame below the saddle, and the curved exhaust pipe culminates in a muffler below the toolbox. The wheels, with wire spokes and metal rims, originally carried 28-by-2½-inch clincher tires, but 28-by-3-inch tires (contributed by Harvey S. Firestone, Jr.) were installed when the motor-cycle was restored in 1947. The wheelbase is 57 inches.

The drive is furnished by a double-reduction roller chain (covered by metal guards) that runs from a sprocket on the engine crankshaft to a sprocket at the hub of the rear wheel. The clutch, which is on the rear-wheel hub, is operated by means of a lever on the left side of the machine, and is engaged by moving the lever forward.

A pedal-and-chain drive, on the right side, incorporates a New Departure coaster brake. With the rear wheel raised free by the stand and with the clutch engaged, the pedals are used to crank the motor. The brake is engaged by a slight backward pressure on the pedals. The pedals are not driven by the forward motion of the machine, but can be used for propulsion in an emergency, in which case the clutch is disengaged.

Pope Model L Motorcycle, 1913

Gift of Mr. and Mrs. William L. Conners in 1964

This motorcycle was purchased late in 1913 by the father of Mrs. William L. Conners, John R. Beattie of New Haven, Connecticut, and was used by him for about eight years. It was then placed in storage, where it remained until it came to the Museum in 1964. Built by the Pope Manufacturing Company of Westfield, Massachusetts, it was known as the Model L and sold for 250 dollars.

The two-cylinder engine, bearing the number 246, is secured to the frame at four points. It is rated as having between seven and eight horsepower, although a chart of its performance in tests by the Worcester Polytechnic Institute shows that at 50 miles per hour it developed 15.4 horsepower, with 13.9 horsepower delivered to the rear wheel. The $3\frac{2}{64}$ -inch bore and $3\frac{1}{2}$ -inch stroke give a displacement of 61 cubic inches. The vehicle's maximum speed was between 60 and 65 miles an hour.

The gray-iron cylinders have separate heads containing nickel-steel valves operated by rocker arms attached to the heads. The intake and exhaust valves are interchangeable. The camshaft and the roller-bearing connecting rods are of nickel steel; the main bearings are of phosphor-bronze; and the crankcase is of aluminum.

An oil tank having a capacity of two quarts is compartmented with a toolbox beneath the seat. A mechanically operated oiler, worm-and-gear-driven from the motor shaft, supplies oil from the tank to the top of the crankcase. A spur from the main oil line leads to the front cylinder, thus insuring equal distribution of oil to both cylinders and overcoming the movement of the main body of oil toward the rear while the machine is running forward. A window in the left side of the crankcase shows the oil level. An auxiliary hand pump at the side of the oil tank is used to supply extra oil for hard pulling or high-speed operation.

A Schebler carburetor is located on the right side of the engine. Ignition is furnished by a Bosch magneto shaft-driven from the motor shaft through a worm-and-gear drive.

The gas tank has two sections, each with a capacity of a gallon and a half. Fuel lines and shut-offs are arranged so that the sections may be used independently or as one tank. The fuel line leading to the engine is equipped with a small metal screen strainer.

Pope Model L motorcycle of 1913. It was restored in 1966.

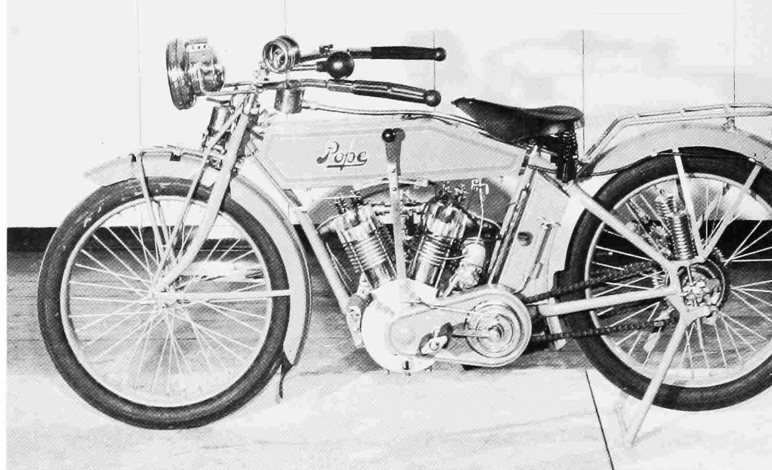

The muffler runs beneath the oil tank and has a pedal-operated cut-out at the rear.

The driving mechanism consists of a chain running from the engine sprocket to the larger sprocket of the clutch assembly, a chain from a smaller sprocket of the clutch assembly to a sprocket on the left of the rear wheel, and a chain from a sprocket on the right of the rear wheel to a sprocket on the pedal shaft. The latter chain operates the Corbin Duplex V-band brake when backward pressure is applied to the pedals, and it puts the machine in motion when forward pressure is applied. When sufficient forward speed has been attained the engine is started by engaging the Eclipse multiple-disk clutch, which is controlled by a hand lever on the left side.

The handlebars have a twin stem as a safety feature. The right grip controls the carburetor and the left grip serves as a compression release by controlling the opening of the exhaust valves. A small lever on the right side of the gas tank serves as the spark control. The ignition switch is mounted on the right handlebar.

The front hub is a ball-bearing type by Corbin. The wheels carry 28-by-3-inch clincher tires. Suspension is by a leaf spring at the front and twin coil springs at the rear. The saddle is of Troxel manufacture. Wheelbase is 56½ inches.

Additional equipment consists of a bulb horn, front and rear acetylene lights having a separate acetylene generator, a Corbin-Brown speedometer geared to the rear wheel, and a luggage rack over the rear fender. The cylindrical toolbox now on the rear fender is an added attachment introduced by the Pope Manufacturing Company in 1915.

This cycle was restored in 1966 by Dale C. Price of Cambridge, Maryland. New tires were installed to replace the missing originals, and the horn and acetylene generator, also missing, were replaced with appropriate types from the Museum's collection. It is possible that the acetylene gas originally may have been furnished from a Prest-O-Lite tank rather than a generator.

Cleveland Motorcycle, 1918

Gift of Richard and Russell Fiedler in 1951

This motorcycle, bearing engine number 5283, cost 175 dollars in 1918 at the Cleveland Motorcycle Company in Cleveland, Ohio. Advertisements of the period claimed this machine could travel 75 miles on a gallon of gasoline and that it had a top speed of from 35 to 40 miles an hour. This make of motorcycle, introduced in August 1915, when the price at the factory was 150 dollars, was one of the most popular lightweight motorcycles of the period.

The 2½-horsepower, 1-cylinder, 2-cycle, air-cooled engine has a 2½-inch bore and a 2¾-inch stroke, providing a total piston displacement of 13½ cubic inches. A Brown and Barlow float-feed, single-jet carburetor, with auxiliary air control, is bolted to the inlet port at the front of the cylinder and is controlled by a pair of levers on the right handlebar. The motor is lubricated by a mixture of oil and gasoline in the fuel tank. A Bosch high-tension magneto, with spark plug, supplies the ignition.

Cleveland motorcycle of 1918, restored in 1951.

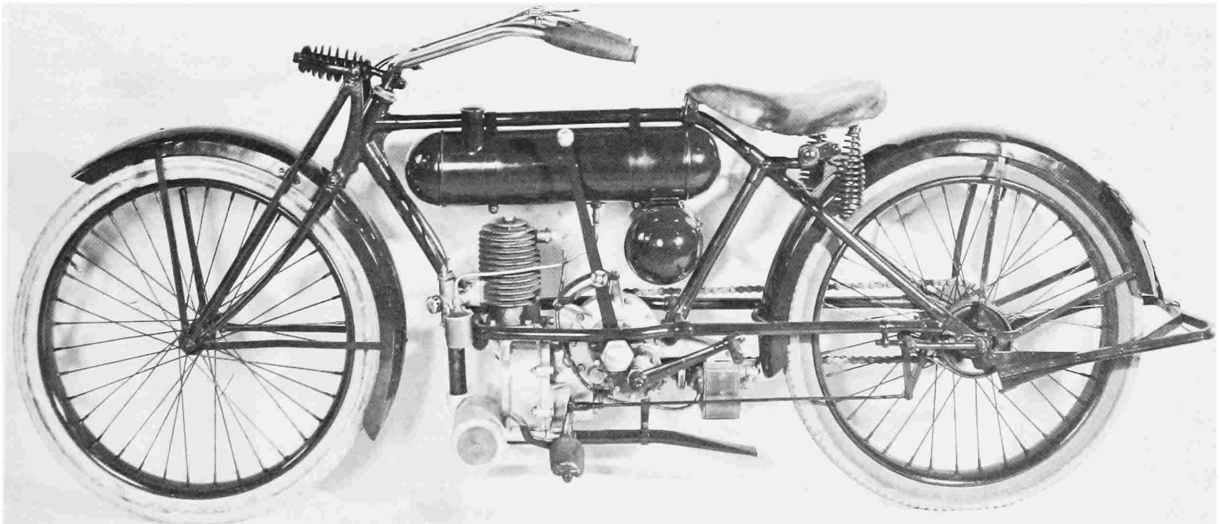

The cycle's frame is of heavy-gauge, seamless steel tubing, brazed at the joints; wheelbase is 54 inches. The engine and gear box are secured in the frame by two large suspension bolts. The gear box, which is integral with the aluminum crankcase, contains a set of two-speed sliding gears of chrome-nickel steel, a heat-treated, alloy-steel worm with a titanium-bronze worm gear, and a clutch composed of 13 disks of hardened and ground steel. Low ratio of the gear box is 10 to 1; high ratio, 6.1 to 1. The transmission gears run in an oil bath.

The clutch is engaged by moving forward a lever on the left. The brake is operated by depressing a foot pedal, also on the left, which contracts a band on a drum on the left side of the rear wheel; and the gears are changed by means of a foot pedal on the right side. A kick starter is attached to the left side of the gear box. The rear wheel is driven by a roller chain from a sprocket on the output shaft of the transmission, on the right side of the machine. There is no guard over the chain.

The steering fork is fitted with a coil spring and its tubular handlebars have rubber grips. A cylindrical muffler, of cast aluminum, is mounted in front of the crankcase. The wire-spoke wheels have metal rims and mount 26-by-2½-inch clincher tires (of the 1920s) that have been equipped with new butyl-rubber inner tubes. Each wheel has a mudguard, and there is a stand at the rear of the frame. A cylindrical fuel tank, equipped with a shut-off valve at the bottom, is suspended from the frame over the engine; and a small, metal toolbox is attached to the rear underside of the tank. The footrests, adjacent to the brake and gear-shift pedals, are rubber covered. The saddle is a Mesinger "Auto Cushion." The motorcycle has no battery, generator, lighting equipment, or warning signal. Its total weight is about 150 pounds.

In 1951 the motorcycle was disassembled, cleaned, refinished, and reassembled. The 1926 District of Columbia license plate—on the vehicle when it was given to the Museum—was then refinished in its original colors.

Autoped Motor Scooter, 1918

Gift of Lawrence Bourgeois in 1964

This lightweight scooter was built in 1918 by the Autoped Company of America, Long Island City, New York. It bears the number D3201 on the left side of the engine.

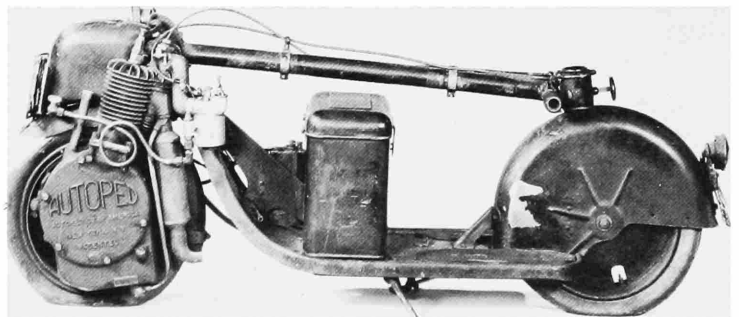

Autoped motor scooter of 1918 with its steering column in the driving position and, below, with steering column folded for storage.

The 4-cycle engine, mounted on the left side of the front wheel, has an air-cooled integral-head cylinder bolted to a circular crankcase. In front of the cylinder is a breather tube that protrudes from the top of the crankcase; the carburetor and muffler are behind the cylinder. The Breeze carburetor has a screw-adjusted air intake, and its needle valve is operated by a small knob bearing numbers for convenience in adjustment. A shutter serves as a throttle control. On the side of the intake manifold is a small priming cup. The intake valve is automatic and the exhaust valve is cam operated. The engine is geared to the wheel by means of a disk clutch.

The flywheel, on the right side of the front wheel, contains a 6-volt lighting generator that originally furnished current for lighting and ignition, but the system later was altered by the addition of an ignition coil and four dry-cell batteries. The ignition switch is mounted on the right side of the frame, and the gasoline tank is above the front fender.

All control of the vehicle is through the steering column. Turning the column steers the machine in the conventional manner; pushing it forward engages the clutch; and pulling it back operates the internal, expanding brake on the front wheel. Turning the left grip operates the throttle, and turning the right grip operates the compression release through a wire controlling the opening and closing of the intake valve. A hand Klaxon is mounted on the left grip. The steering column can be folded down and secured to the rear fender for compactness in storage.

A headlamp is mounted at the right of the front wheel, and a tail lamp, on the rear fender.

The operator stands on rubber pads on the frame of the vehicle. A two-pronged stand, attached to the underside of the frame, is operated by means of a pedal that extends through the floor. A utility box, mounted toward the front of the machine, now contains the batteries that were added to the electrical system; an ignition coil is mounted just in front of the utility box.

The 15-by-2 $\frac{1}{4}$ -inch pneumatic tires, made expressly for this vehicle by the Empire Rubber and Tire Company, Trenton, New Jersey, bear the inscription "Auto Ped Tire, Empire red, non-skid."

Iver Johnson Bicycle, 1925

Gift of Mrs. Powhatan Moncure, Jr., in 1961

Made by the Iver Johnson Arms and Cycle Works, of Fitchburg, Massachusetts, this drop-frame woman's cycle is completely typical of its era. The frame is of comparatively heavy steel tubing, with the customary additional drop bar and cross member for the extra strength that a drop-frame requires.

Hollow steel wheel rims are fitted with 28-by-1½-inch Gillette Ambassador single-tube tires. Each wheel has 36 tangential wire spokes and ball-bearing hubs, with a Morrow coaster brake in the rear hub.

The usual drive by roller chain is employed, with 22 teeth in the front sprocket and 9 in the rear. Nonadjustable pedal cranks have a throw of 6½ inches, and the ball-bearing pedals have rubber pads.

Handlebar grips are of black rubber. The saddle, a Mesinger No. 1, is fully adjustable. This cycle is equipped with front and rear mudguards, the rear one having a red reflector and holes through which a cord skirt guard is laced, a rear luggage rack, chain guard, and kick-stand.

The finish is a medium blue with white striping and decoration; the wheel rims are yellow with dark blue striping.

Iver Johnson woman's bicycle of 1925.



Snyder Bicycle, 1927

Gift of the Homer P. Snyder Manufacturing Co., Inc., in 1927

This tubular, diamond-frame bicycle was made by the Homer P. Snyder Manufacturing Co., Inc., of Little Falls, New York. At the time of its receipt at the Museum it was new and was among the most modern types of bicycles then manufactured in this country.

The hollow steel wheel rims carry the original 28-by-1½-inch, single-tube tires, No. 66 E. H., made by the Fisk Rubber Co., of Chicopee Falls, Massachusetts. Each wheel contains 36 tangentially laced wire spokes, and the rear-wheel hub incorporates a Model C New Departure coaster brake. Both wheel hubs run on ball bearings. Adjustment of the chain tension is obtained by moving the rear axle backward or forward in slots at the rear of the frame.

The drive to the rear wheel is by sprockets and a Diamond roller chain, located to the right of the wheel. The pedal throw, 6¾ inches, is nonadjustable. The two pedal cranks are in one piece, unlike the two-piece construction of the 1896 Columbia bicycle in the collection. The rubber-covered pedals are mounted on ball bearings.

The curved, tubular metal handlebars, with Grip-Well rubber grips, are strengthened with a crossbrace. A hand-operated Klaxon-type horn is mounted on the brace, and a McKeelite electric lamp is attached to the front of the bars.

The frame is strengthened at the top by means of an additional horizontal member, while the fork is supplemented with two vertical bars at its front. A metal toolbox is placed between the two horizontal members of the frame. Beneath it hangs a metal container for the dry cell for the lamp. A switch is built into the cover at the front of the container.

The Troxel saddle of wood, leather, and coil springs is adjustable in all directions.

Front and rear mudguards, a luggage rack over the rear guard, which carries a red glass reflector, and a stand are provided, but no chain guard is supplied. The bicycle is finished with orange and black paint and with nickel plate. Its weight is approximately 50 pounds.



Snyder bicycle of 1927.

Reinhardt Bicycle, 1935

Gift of Fred A. Birchmore in 1938

The donor, a resident of Athens, Georgia, bought this bicycle in Gotha, Germany, in July 1935. An "Original Reinhardt," it was made by Fahrradfabrik Otto Reinhardt, Bielefeld, Germany, and was bought for 67 reichsmarks. In the course of the next two years Mr. Birchmore rode it through western Europe, eastern Europe, Crete, Cyprus, Egypt, Iraq, Iran, Afghanistan, India, Siam, Indochina, and the Philippines, before pedaling his bicycle home across the United States from California. It has been estimated that his travels covered approximately 40,000 miles, of which about 25,000 were on the bicycle, and the rest by boat. Approximately four saddle covers and seven sets of tires were worn out during the journey. The present tires were purchased from a shop in Calcutta, India.

The German-made Reinhardt bicycle that Fred A. Birchmore rode on his around-the-world journey in the mid-1930s.



The tubular frame is of the diamond, Safety type, and is supported on metal-rimmed wheels, each containing 36 tangentially laced wire spokes and fitted with 26-by-2.00-inch tires with inner tubes. The rear-wheel hub incorporates a coaster brake inscribed "Torpedo-System Sachs." Both wheel hubs run on ball bearings, and an oil cup is fitted to each. Adjustment of the chain tension is obtained by moving the rear axle backward or forward in slots at the rear of the frame.

The drive to the rear wheel is by sprockets and roller chain, located to the right of the wheel. The driving sprocket is mounted on a 3-piece crank assembly supported in two ball bearings in the crank hanger, which has an oil hole for lubrication. The pedal throw is $6\frac{7}{8}$ inches and is nonadjustable. The pedals are rubber covered and are mounted on ball bearings.

The curved, tubular metal handlebars carry composition grips, and mount a warning bell on the left side. A Radsonne front lamp is attached to the front fork, just below the handlebars, and turns with it. The light switch is contained in the lamp. An Energie generator is clamped to the left side of the fork.

The presently installed saddle cover, a Luxus, is mounted on a metal-and-coil-spring base that is fully adjustable. Front and rear mudguards, a Pallas luggage rack over the rear guard, a tire pump, and a small leather tool bag are provided. The front brake, which formerly rubbed against the tire, is now missing. No chain guard is supplied. An American pennant is attached to the front mudguard. The weight of the machine is approximately 43 pounds.

Simplex Servi-Cycle, 1935

Gift of Paul Treen in 1960

The Museum's Servi-Cycle, designed by Paul Treen and built by the Simplex Manufacturing Corporation, of New Orleans, Louisiana, features simplicity in every respect. The motor bears the number 19351, indicating that it was built in 1935 and was the first of the series.

The single-cylinder, 2-cycle, 2-horsepower engine is air cooled and equipped with a rotary valve. The tiny carburetor on the back of the motor is controlled by a wire operating from a knob located behind the steering head, and a lever near the right grip operates a compression release. To start the engine, the operator opens the compression release with his right hand, pushes the cycle to gain speed, then closes the release. A V-belt drive transmits power to the rear wheel.

There is no clutch, so the engine must be switched off in stopping. This is accomplished by pressing an electric button, of the type generally used to operate a bicycle horn, located near the left grip. This apparently shorts the low-tension side of the magneto, an Eisemann Model 71L bearing the serial number 2003.

The tires bear the name of the Simplex Manufacturing Company and are marked "26 x 2.250." An ordinary cycle coaster brake, made by Morrow, is operated by a pedal at the left of the engine. The bicycle's stand can be moved up to form a footrest.

The gasoline tank is in front of the seat, and the muffler is to the left of the rear wheel. An electric headlamp, mounted on the cycle's spring fork, receives current from the magneto.

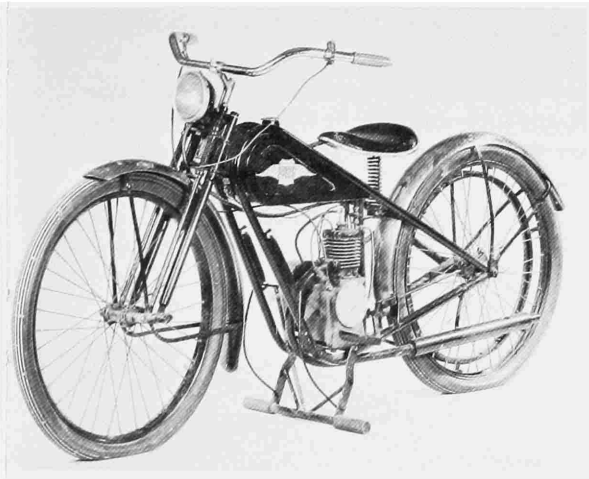

*First production model Simplex
Servi-Cycle, 1935.*

Whalen and Janssen Laminated-Wood-Frame Bicycle, 1942

Gift of Webster E. Janssen in 1946

At the beginning of World War II, John T. Whalen, with Webster E. Janssen of the Janssen Piano Co., Inc., developed this laminated-wood-frame bicycle to conserve critical materials yet provide essential transportation. Wood subsequently proved to be more critical than metal, so the bicycle was not marketed.

The fork, saddle, handlebars, and elliptical frame are of laminated wood. The wheels are of metal, with 36 tangential steel spokes, and are 24 inches in diameter, mounting 26-by-1.375-inch Goodyear tires and tubes.

A New Departure Model D coaster brake is incorporated in the rear-wheel hub, and the drive, by roller chain with metal sprockets and wooden pedals, is on the right side of the frame. Ball bearings are used throughout the machine.

The saddle is unsprung but is adjustable. There are no mudguards or chain guard, and no grips on the handlebars. The machine's weight is approximately 31 pounds.

Experimental wood-frame Whalen & Janssen bicycle of 1942.



Raleigh Bicycle, about 1949

Gift of Alvaro Zabala in 1950

On 3 January 1950 Alvaro Zabala left Bogotá, Colombia, on this bicycle, and headed for New York City. After pedaling through Colombia, Panama, Costa Rica, Nicaragua, Honduras, El Salvador, Guatemala, Mexico, the Mississippi Valley, and Ontario, Canada, he reached New York City on 2 June, five months later. It is estimated that about 8,000 miles were covered during the trip. Subsequently, Mr. Zabala pedaled the bicycle to Washington, where the machine was presented by him to the Museum.

The Raleigh bicycle, made in Nottingham, England, is a well-known machine. The lightweight, tubular frame of this example is of the modern diamond type and is supported on two Dunlop metal-rimmed wheels, with 32 tangentially laced steel spokes in the front wheel and 40 in the rear. Each wheel runs on a pair of ball bearings, an oil hole being provided in each hub for lubrication. Large wing nuts are provided on each wheel axle to facilitate the removal of the wheels. The 26-by-1¼-inch tires are equipped with inner tubes.

The fork, also of lightweight tubular construction, is mounted on

This British-made Raleigh bicycle was used by Alvaro Zabala on his trip from Bogotá, Colombia, to New York City in 1950.



a pair of ball bearings, while the curved handlebars are made of tubular aluminum and are provided with rubber grips.

The sprockets and the Perry roller chain are on the right side of the frame. The 46-tooth driving sprocket is mounted on a 3-piece crank assembly supported in two ball bearings in the crank hanger. An oil hole in the crank hanger permits their lubrication. The 6½-inch crank arms are detachable from the center section of the crank assembly, but are not adjustable. A ball-bearing-mounted, all-metal pedal with a metal toe clip is fitted to each crank arm. Attached to the rear wheel is a 3-gear, compound sprocket, made by Cyclo, of Birmingham, England, that contains 16, 20, and 24 teeth, respectively, in its three gear sections. These turn as a unit with respect to the wheel, and contain an overrunning clutch between the hub of the unit and the hub of the wheel so as to permit coasting. In use, the chain is engaged with one of the three gear sections, depending on the terrain to be covered. Changing is accomplished by loosening the wing nuts of the rear axle, placing the chain over the gear section desired, adjusting the chain tension by moving the wheel and axle within slots provided at the rear of the frame, and tightening the wing nuts. Another 16-tooth gear is rigidly attached to the other side of the wheel. By removing the wheel and turning it around in the frame, this gear, which allows no coasting, can be used.

Front and rear brakes are provided, and each consists of a pair of rubber-faced, metal shoes which clamp against the metal rim of its wheel. Each pair of shoes is controlled by a cable and hand lever attached to the handlebars, the right lever for the front wheel, and the left lever for the rear wheel. A heavy wire spring keeps each pair of shoes normally away from the rim.

Lighting equipment consists of a tail light, a Lucifer "Aero B1" front lamp with two bulbs and a built-in switch to select the bulb that is to be used, and a Lucifer "Baby 700" generator, clamped to the left side of the front fork, that operates through contact with the side of the revolving front tire. Both of the Lucifer items were made in Switzerland.

A Brooks B-17 Champion Narrow saddle, made of heavy leather on a wire framework, is attached to a tubular aluminum post adjustable for height. The saddle is fully adjustable.

There are no mudguards on the machine. A removable aluminum tire pump bearing the name "Britannialloy" is secured to the lower tube of the frame. Carried on the handlebars are a pair of aluminum water flasks and a tool bag. Small flags of the 10 countries through which Mr. Zabala travelled are draped from the handlebars to the saddle. The complete machine weighs approximately 33 pounds.

Schwinn Varsity Tourist Bicycle, 1965

Gift of Arnold, Schwinn & Co. in 1966

Designated by Schwinn as the Varsity Tourist, this cycle is interesting because of the 10-speed, French-made Sprint *derailleur* with which it is equipped. This is so named because the chain can be “de-railed” from one sprocket to another, offering ten different gear ratios. The rear hub is fitted with five sprockets (14, 16, 20, 24, and 28 teeth), and the 6½-inch pedal cranks have two sprockets (39 and 50 teeth). Two small levers mounted on the lower main tube of the frame move cables that operate the derailing devices, the left one moving the chain sideways behind the pedal sprocket and the right one moving the chain sideways below the wheel sprocket. This lateral movement causes the chain to crawl up or down to the next sprocket as the cycle is pedaled forward. With this type of drive, Weinmann caliper brakes are used, the pairs of brake shoes gripping the rims of the wheels when hand levers are squeezed—the left one operating the front brake, and the right one, the rear.

The 36-spoke wheels have tubular chrome rims and carry 27-by-1¼-inch nylon sports touring tires. The frame is of the usual lightweight diamond pattern. The frame and forks have a coppertone finish, the tourist-style handlebars have white plastic grips, and the spring saddle is in white and coppertone. The fenders are chrome plated, the rear one carrying a red reflector. A built in kick-stand is mounted on the left, just behind the pedals.

Schwinn 10-speed Varsity Tourist of 1965.



Schwinn Super Deluxe Sting-Ray Bicycle, 1965

Gift of Arnold, Schwinn & Co. in 1966

Used primarily by youngsters as a fun bike rather than for serious road work, this Super Deluxe Sting-Ray is Schwinn's "sports car" model. Sturdy and durable to stand the abuse often given it by children, this cycle has a cantilever frame in which all members but the center stay are curved. The back stays sweep forward in a continuous curve, drop below the upper main tube, and are secured to the sides of the lower main tube.

Chrome-rimmed 28-spoke wheels carry 20-inch whitewall tires, the front being $1\frac{3}{4}$ inches in diameter and the studded rear, 2.125 inches. The front wheel is mounted in Schwinn's spring-fork. A 36-tooth front sprocket and a 20-tooth rear sprocket carry the driving chain, and the pedals turn on $5\frac{1}{2}$ -inch cranks. The rear hub contains a Bendix automatic 2-speed coaster brake, which is shifted from one speed to another by back-pedaling slightly, while the brake is applied in the usual manner by back-pedaling more firmly. A chain guard protects the rider's clothing.

Handlebars of the high-rise type have white plastic grips. A white, padded "banana" seat is unsprung, but adjusts to three different heights at 1-inch increments.

Finished in a metallic sky-blue, this Sting-Ray has a short chrome-plated rear fender, and an even shorter front fender. Since the rear fender does not extend far enough downward to carry a reflector, a large red reflector is mounted under the rear of the seat. The cycle is supported when not in use by a built-in kick-stand to the left rear of the pedals.



Schwinn Super Deluxe Sting-Ray of 1965.

BIBLIOGRAPHY

- BARTLEET, HORACE WILTON. *Bartleet's Bicycle Book*. London: Ed. J. Burrow & Co., Ltd., 1931.
- BOWDEN, KEN, AND JOHN MATTHEWS. *Cycle Racing*. London: Temple Press Books, Ltd., 1965.
- BURY, VISCOUNT, AND G. LACY HILLIER. *Cycling*. London: Longmans, Green & Co., 1887.
- CAUNTER, C. F. *The History and Development of Cycles*. London: Her Majesty's Stationery Office, 1955.
- . *Cycles: Handbook of the Collection*. Science Museum. London: Her Majesty's Stationery Office, 1958.
- GODDARD, J. T. *The Velocipede: Its History, Varieties, and Practice*. Cambridge: Riverside Press; New York: Hurd and Houghton, 1869.
- GRIFFIN, HARRY HEWITT. *Bicycles and Tricycles of the Year 1886*. London: L. Upcott Gill, 1886.
- . *Cycles and Cycling*. New York: Frederick A. Stokes Co., 1890.
- HOUGH, RICHARD, AND L. J. K. SETRIGHT. *A History of the World's Motorcycles*. New York: Harper & Row, 1966.
- MCGONAGLE, SEAMUS. *The Bicycle in Life, Love, War and Literature*. London: Pelham Books, 1968.
- PAGE, VICTOR W. *Motorcycles and Side Cars*. New York: The Norman W. Henley Publishing Co., 1924.
- PALMER, ARTHUR JUDSON. *Riding High*. New York: E. P. Dutton & Co., Inc., 1956.
- PORTER, LUTHER H. *Wheels and Wheeling*. Boston: Wheelman Co., 1892.
- PRATT, CHARLES E. *The American Bicyclist: A Manual for the Observer, the Learner, and the Expert*. Boston: Rockwell and Churchill, 1880.
- SCHWINN, FRANK W. *Fifty Years of Schwinn-built Bicycles*. Chicago: Arnold, Schwinn & Co., 1945.
- SCOTT, ROBERT P. *Cycling Art, Energy and Locomotion*. Philadelphia: J. B. Lippincott Co., 1889.
- SHARP, ARCHIBALD. *Bicycles and Tricycles*. London: Longmans, Green & Co., 1896.
- SHELDON, JAMES. *Veteran and Vintage Motor Cycles*. London: B. T. Batsford, Ltd., 1961.
- SLOANE, EUGENE A. *The Complete Book of Bicycling*. New York: Trident Press, 1970.
- SMITH, ROBERT A. *A Social History of the Bicycle: Its Early Life and Times in America*. New York: American Heritage Press, 1972.
- TRAGATSCHE, ERWIN. *The World's Motorcycles, 1894-1963*. London: Temple Press Books, Ltd., 1964.
- WOODFORDE, JOHN. *The Story of the Bicycle*. New York: Universe Books, 1970.

In addition to these publications there are many periodicals, most of which are no longer being published, that provide contemporary descriptions of many cycles and contests. Among these are the following:

American Bicycling Journal, The (Boston), 1877–79, then merged into *The Bicycling World*.

American Bicyclist and Motorcyclist (New York), 1906 to present (various titles).

Bearings (Chicago), 1890–97, then merged into *The Cycle Age and Trade Review*.

Bicycling World, The (Boston), 1879–1915 (various titles).

Cycle (Boston), 1886–87.

Cycle Age and Trade Review, The (Chicago), 1888–1901 (various titles).

Cyclist, The (London and Coventry), 1879–1911 (various titles).

L.A.W. Bulletin, The (Philadelphia and Boston), 1885–88, then merged into *The Bicycling World*.

Springfield Wheelmen's Gazette, The (Springfield, Massachusetts), 1883–86, succeeded by *The Wheelmen's Gazette*.

Wheel, The (New York), 1880–88, published by the League of American Wheelmen.

Wheel and Cycling Trade Review, The (New York), 1888–1900, then merged into *Bicycling World and Motorcycle Review*.

Wheeling (London), 1884–1901.

Wheelman, The (Boston), 1882–83, then merged into *Outing*.

Wheelmen's Gazette, The (Springfield, Massachusetts), 1886–1908, succeeded *The Springfield Wheelmen's Gazette*.