

# The Future of Diving:

## 100 Years of Haldane and Beyond

*Michael A. Lang  
and Alf. O. Brubakk*

Editors

*A Smithsonian Contribution to Knowledge*



Smithsonian Institution  
Scholarly Press

WASHINGTON, D.C.  
2009

This publication of the proceedings of “The Future of Diving: 100 Years of Haldane and Beyond” is co-sponsored by the Smithsonian Institution and Trondheim University. The symposium was convened by the Baromedical and Environmental Physiology Group of the Norwegian University of Science and Technology in Trondheim, Norway, on 18–19 December 2008.

---

Published by SMITHSONIAN INSTITUTION SCHOLARLY PRESS

PO Box 37012  
MRC 957  
Washington, D.C. 20013-7012  
[www.scholarlypress.si.edu](http://www.scholarlypress.si.edu)

Compilation copyright © Smithsonian Institution

All rights reserved. No part of this publication may be reproduced, stored in a retrieval system, or transmitted in any form or by any means, electronic, mechanical, photocopying, recording, or otherwise, without the prior permission of the publisher.

Cover image: Photo by Hans Wild//Time Life Pictures/Getty Images.

**Library of Congress Cataloging-in-Publication Data**

[CIP data to come]

**ISBN-13:** 978-0-9788460-5-3

**ISBN-10:** 0-9788460-5-2

∞ The paper used in this publication meets the minimum requirements of the American National Standard for Permanence of Paper for Printed Library Materials Z39.48—1894.

# Contents

---

FOREWORD <i>by David H. Elliott</i>	vii
ACKNOWLEDGMENTS <i>by Michael A. Lang and Alf O. Brubakk</i>	ix
EXECUTIVE SUMMARY	xi
<b>INTRODUCTION</b>	
Introductory Remarks <i>Alf O. Brubakk</i>	1
Welcoming Remarks <i>Stig A. Slordahl</i>	3
J. S. Haldane, the First Environmental Physiologist <i>Alf O. Brubakk and Michael A. Lang</i>	5
Environmental Physiology of the Future <i>Richard E. Moon</i>	11
<b>DECOMPRESSION PHYSIOLOGY</b>	
An Introduction to Clinical Aspects of Decompression Illness (DCI) <i>Costantino Balestra</i>	17
Haldane Still Rules! <i>David J. Doolette</i>	29
Biochemical Approach to Decompression <i>Susan R. Kayar</i>	33
Exercise and Decompression <i>Russell S. Richardson</i>	41
Diving Medicine and the Cellular Stress Response <i>George A. Perdrizet</i>	47
Individual Risk of Decompression Sickness: Possible Effects of Genomic or Epigenomic Variation Altering Gene Expression <i>Andreas Møllerløkken and Ingrid Eftedal</i>	53
Inducing HSP for Protection against DCS: Heat Exposure before Diving Reduces Bubble Formation in Man <i>Jean-Eric Blatteau, Emmanuel Gempp, Jean-Michel Pontier, Costantino Balestra, Tony Mets, and Peter Germonpré</i>	59

Lack of Signs of Brain Injury in Rats on MRI after Decompression <i>Marianne B. Havnes, Marius Widerøe, Marte Thuen, Andreas Møllerløkken, and Alf O. Brubakk</i>	65
Exercise, Endothelium, and Diving Physiology <i>Željko Dujic</i>	71
Animal Experiments for Evaluating Decompression: Development of the Modern Submarine Escape Method <i>Mikael Gennser</i>	77
<b>DECOMPRESSION METHODOLOGY</b>	
Ultrasound for Evaluating Decompression <i>Olav S. Eftedal</i>	83
Current Trends in Ultrasound Imaging Technology, SURF Imaging, and Decompression Induced Microbubbles <i>Lasse Løvestakken, Andreas Møllerløkken, and Svein-Erik Måsøy</i>	87
The Future of Dive Computers <i>Michael A. Lang and Sergio Angelini</i>	91
<b>Discussion: Decompression Physiology and Methodology</b>	101
<b>STRATEGIC APPROACHES</b>	
Breeding Diving Scientists: Cloning, Spawning, or Cultivation? <i>Øyvind Ellingsen</i>	109
National Centre for Hyperbaric and Diving Medicine <i>Marit Grønning</i>	111
Baromedical and Environmental Physiology Group (BAREN) <i>Alf O. Brubakk</i>	113
Physiopathology of Decompression (PHYPODE) Network <i>Francois Guerrero, Jacek Kot, Peter Germonpré, Jean-Michel Pontier, Alessandro Marroni, Adel Taber, Frans Cronje, Bernard Gardette, D. Nicola, and Costantino Balestra</i>	117
International Cooperation in Diving Research <i>Matthew Swiergosz</i>	119
<b>Discussion: Diving Researcher Recruitment</b>	123
<b>ENVIRONMENTAL PHYSIOLOGY</b>	
How Do Marine Mammals Avoid DCS? <i>Andreas Fahlman</i>	129
Does Diving Destroy the Brain? <i>Stephen Daniels</i>	137
Effects of Diving on the Lung <i>Einar Thorsen</i>	145
The Limits of Breath-Hold Diving <i>Peter Lindholm</i>	147



Parameters of Extreme Environment Diving <i>Michael A. Lang</i>	153
Creativity and Improvisation As Phenomena and Acting Potential in Different Contexts <i>Bjørn Alterhaug</i>	161
<b>Discussion: Environmental Physiology and Strategies for the Next 100 Years</b>	171
APPENDIX A: <i>The Prevention of Compressed-Air Illness</i> (1908)	175
APPENDIX B: Symposium Speakers	281
APPENDIX C: Symposium Participants	285



# Foreword

---

It was a disappointment for me not to be able to attend this conference, but it is an honour to write its preface. While a postgraduate student in Oxford I had a period of using the Lloyd-Haldane gas-analysis apparatus<sup>1</sup>. My contribution to respiratory research was negligible<sup>2</sup> but some serious effects arose in a colleague from chronic exposure to the mercury that had spilt from the apparatus and was trapped between the laboratory floorboards. Mercury poisoning was notifiable even in Haldane's time but while this incident introduced me to inhalation toxicology and health protection (another area in which Haldane excelled), it also shows that an important lesson does not necessarily remain in the spotlight for a hundred years.

One hundred years ago John Scott Haldane was already a Fellow of New College, Oxford, the Reader in Physiology at Oxford University and a Fellow of the Royal Society (FRS). In the opening review Michael Lang and Alf Brubakk illustrate the breadth of his scientific output and his philosophical criticisms. We should also remember that, like many other researchers, he was often his own subject and once after breathing a carbon monoxide mixture for nearly a half hour, he felt "distinctly abnormal".

This international meeting covers what has happened since Haldane's publications and focuses on the hyperbaric aspect of his contributions to physiology. The soldiers exposed to poison gas in the trenches and the coal miners exposed to 'after-damp' in the mines may still out-number divers as the beneficiaries of Haldane's investigations into respiratory physiology and health protection, but these two major problems which Haldane solved, occur within an otherwise physiologically-normal body.

In contrast, there are additional factors in diving that arise from the effects of a unique physiological variable, that of environmental pressure. Haldane investigated the decompression problems of deep air diving for the Admiralty and made immense progress in providing a practical outcome for the diver and a foundation for the further development of decompression tables. The additional complexity of the effects of raised environmental pressure on the whole body affects many cellular and physiological mechanisms, some of which in turn may influence the body's response to the presence of bubbles. All these developments and revelations have catalysed the researches reviewed here and have inspired the convenors of this meeting to reprint for us the original paper of 1908. This paper is the foundation of what follows in these proceedings, more than a hundred years later.

*Professor David H. Elliott O.B.E., D.Phil (Oxon), F.R.C.P., F.F.O.M.*

## NOTES

<sup>1</sup>Lloyd, B.B. *J. Physiol.* 1958; 143:5P.

<sup>2</sup>Cunningham, D.J.C., Elliott D.H., Lloyd B.B., Miller J.P., Young J.M. A comparison of the effects of oscillating and steady alveolar partial pressures of oxygen and carbon dioxide on the pulmonary ventilation. *J. Physiol* 1966; 179:498–508.

# Acknowledgments

---

In 1908 John Scott Haldane and coworkers published *The Prevention of Compressed-Air Illness*, which has formed the basis of modern decompression procedures. One century later it was fitting to try to look into the future to better understand the physiological effects of the underwater environment on man. To that end, a large number of friends and colleagues agreed to gather in Trondheim, Norway just days before Christmas, December 18–19, 2008.

All participants contributed significantly by agreeing to speak at this symposium that celebrated Haldane's seminal achievements, by taking part in the discussions, and by contributing papers to this volume. As co-editors, we deemed the content of the Haldane symposium and the speakers to be of such quality to warrant publication of enduring materials in the form of a proceedings volume. Because this decision was made shortly before the event, we are grateful to all authors for their responsive collaboration on this project. We thank David Elliott in particular for his fitting foreword.

The Faculty of Medicine of the Norwegian University of Science and Technology kindly offered conference facilities. The Baromedical and Environmental Physiology Group at NTNU provided technical and organizational support. In particular, we thank Astrid Hjelde, Svein-Erik Gaustad, Marianne Havnes, Andreas Møllerløyken, and Kim-Vidar Rasdal for their assistance with symposium logistics.

Although he was not able to attend the symposium due to unforeseen last-minute circumstances, we give a special thank you to our friend, colleague, diver, physiologist, and NASA astronaut Mike Gernhardt for providing his special videotaped presentation "Diving in Space", which was a symposium highlight.

Financial support was provided by the IMCA (International Marine Contractors Association); ACERGY Norway; TECHNIP Norway; StatoilHydro Norway; and HELPRO AS, Trondheim. This publication was supported in part by the U.S. Navy, Office of Naval Research, Undersea Medicine Research Program (award number XXX).

We also thank Ginger Strader and Deborah Stultz of the Smithsonian Institution Scholarly Press for their expert assistance in the timely compilation and production of these proceedings.

*Michael A. Lang*  
Washington, D.C., USA

*Alf O. Brubakk*  
Trondheim, Norway



# Executive Summary

---

The symposium results of *The Future of Diving: 100 Years of Haldane and Beyond*, convened by the Baromedical and Environmental Physiology Group of the Norwegian University of Science and Technology, 18–19 December 2008, in Trondheim, Norway, are reported in 30 papers and 3 discussion sessions in this volume. These proceedings include a wide range of environmental research studies demonstrating the breadth and diversity of decompression physiology studies. The first section treats an overview of the Norwegian University of Science and Technology, John Scott Haldane's life and work and environmental physiology of the future. Subsequent proceedings papers represent findings by international workers on overarching topics of decompression physiology, decompression methodology, strategic approaches to decompression research, and environmental physiology. The volume includes contributions on clinical aspects of decompression illness, biochemical approach to decompression, the cellular stress response, and individual risk of decompression sickness and the possible effects of epigenomic variation altering gene expression; on inducing heat-shock proteins for protection against decompression sickness, lack of brain injury after decompression in rats; on exercise, endothelium and diving physiology, and animal experiments for evaluating decompression; on ultrasound decompression methodologies and the future of dive computers; on decompression research strategies, collaborative networks, and recruiting new researchers to the field; on marine mammal adaptations to avoid decompression sickness, whether diving destroys the brain, diving in space, and effects of diving on the lung; on the limits of breath-hold diving and parameters of extreme environment diving; and, on creativity in science. As we are preparing to face challenges of new ideas, methodologies, and interdisciplinary approaches to studies of decompression sickness, we are reminded of the limited increase in knowledge of decompression sickness as a systemic disease since Haldane's seminal work 100 years ago.





# Introductory Remarks

*Alf O. Brubakk*

---

W elcome everyone. I am very pleased to see so many people fill up this auditorium. I never expected that the idea of this Haldane symposium would catch on and encourage so many of you to attend. Our thoughts were that organizing a symposium to honor Haldane one hundred years after his seminal publication in 1908 would be a good idea, because since that time we should have a better grasp of what has happened in the field of decompression and, more importantly, what should happen in the future. We will try to discuss some of the issues that we think are important for the future and how we might approach them. In particular, how can we get young people interested in this rather limited field of science? There are quite a lot of interesting biological and practical diving problems that need to be addressed.

The interactions at this symposium are going to be important. Hopefully many people will take this opportunity to talk with each other and by making their contributions, lead to a useful result. We have asked all speakers to submit a manuscript by March 31, 2009 and we will hopefully not have to hound you about this since it is difficult to do after we have already paid for the airline tickets. Speaker forms need to be filled out and submitted to us for reimbursement.

The chairman of today's session is Otto Molvaer of Deep-X whom I have chosen because of his excellent ability to keep speakers within their time limits. Even though speakers may have a lot to say, we ask you to stay within your time limit because of our full program schedule.

The discussions will be recorded because our goal is to publish this volume. My good friend Michael Lang from the Smithsonian has done a lot publishing and he has convinced me that, although this will be much work, this Haldane symposium is such an event that we need to record it for posterity and disseminate the results. In order to do that, we have supplied two roving microphones. It is important that when you make a comment or ask a question you state your name in order to attribute the remark to the appropriate speaker. Otherwise, we will not know who said what, which might be an advantage in some cases. In others, some speaker might say "I didn't say that" for which we will have a video tape back up to prove that they did! There are several NTNU people in the audience and we will try to help you in any way we can. I now welcome Stig Slørdahl, Dean of the NTNU Medical Faculty, to share some welcoming remarks. Once again, welcome to the Haldane Symposium.



# Welcoming Remarks

*Stig A. Slørdahl*

---

Ladies and gentlemen, it is an honor for me to welcome you to this symposium, to Trondheim, and to the Norwegian University of Science and Technology (NTNU) Faculty of Medicine, your host.

Trondheim is the number one student city of Norway. Every fifth inhabitant in Trondheim is a student, in total there are about 30,000 students. About 20,000 are enrolled in the university and about 10,000 in the county college. Trondheim has a long tradition of being a student city. We can state that we have the oldest school in Scandinavia, dating back to 1030, an optimistic figure that was related to the church and the cathedral.

The Norwegian University of Science and Technology, as a university, is a fairly new construction, dating back to 1996. Several institutions were merged to establish the new university: the Engineering School of Norway, the Norwegian Institute of Technology, the Medical School, and the University for Social Sciences and Humanities. We are proud to say that our university enrolls the best students in Norway. Of the top 1% of students graduating from high school in Norway, NTNU enrolls more than 60%, and of the top 10% of high school graduates, NTNU enrolls around 50%. As you know, Norway is a social democratic country, so I will not comment on this any further. Internationally, universities work really hard to attract the best students, providing the chance of producing the best research with those really good brains.

The Faculty of Medicine has 720 registered medical students, around 250 PhD students, and 250 students attending seven different Master programs. Altogether, around 900 people are employed by the faculty.

Alf Brubakk started working here at the very beginning of the Medical School, which at the time constituted only a small part of the university, but which is now one of the largest faculties. The proximity between the Engineering School and the hospital has been very important for the Medical School's research activities. Alf was actually one of the professors who initiated this collaboration. In 1970, he had lunch with a fellow from the Engineering School, and being a very creative individual, immediately after this lunch Alf started to collaborate with him on the cardiovascular system. In order to estimate what happens in the cardiovascular system, they agreed that more information was needed, and this triggered the first discussions on Doppler ultrasound and instrumentation. This was the beginning of the establishment of a business called Vingmed, later purchased by GE, which entered into the international market of echocardiography. Since then, the collaborations between the Medical School and the Engineering School have increased considerably and Alf continues to be part of this.

The Faculty has conducted a population-based health survey in a county near Trondheim. For the third time we have invited the entire population of the county to participate. The HUNT study (Helse-undersøkelsen i Nord-Trøndelag) started in 1984, when more than 90% of the population showed up. Ten years later, 70% of the

population participated, and in 2006, 56% of the population showed up to give blood samples, go through an examination, and provide other vital data on health and occupational background. People working in the oil industry also participated. In total, over 100,000 individuals were invited to participate in the HUNT 3 study, one of the world's largest health studies. The Principal Investigator of the HUNT projects has been Jostein Holmen, and the HUNT 3 Project Director was Steinar Krokstad.

Research related to diving has been an ever-increasing undertaking within our faculty. I came here as a research fellow in 1987, working in the same Department as Alf, and I have, since then, been following the development of the diving research activities. I am quite impressed with the scope of Alf's work and his creativity and success in this process.

Again, I wish you a warm welcome and I expect you will have two interesting symposium days. I also hope you will have an opportunity to see more of Trondheim. We are currently building a new university hospital here on campus, a \$2.5 billion dollar project. The Faculty of Medicine will be housed inside the hospital buildings and basic scientists will be moved to the academic floor within the new hospital with interconnecting skywalks between the buildings. Our vision is that more frequent interaction between basic scientists, clinical colleagues and engineers will stimulate exciting collaborative research. The entire construction project should be finalized by 2013. Hopefully we can reconvene the 200-year Haldane symposium in the new venue.

# J. S. Haldane, the First Environmental Physiologist

*Alf O. Brubakk and Michael A. Lang*

---

**ABSTRACT.** John Scott Haldane was born in 1860 in Edinburgh, Scotland and can truly be called the first environmental physiologist. He studied poisonous gases occurring in coal mines and wells, sunstroke, the physiological action of carbon monoxide and the use of a caged canary for early CO detection, the regulation of lung ventilation (with J. G. Priestley, 1905), and devised the haemoglobinometer, the apparatus for blood-gas analysis. He also described the effects of oxygen deficiency and exercise on breathing. During the First World War he worked on effects of poisonous gases and designed a portable oxygen administration apparatus. His work on hypoxia and the acclimatization of the human body to high altitude revolutionized concepts in respiratory physiology. Haldane published some landmark books on his philosophical ideas about the true significance of biology. Most importantly, however, Haldane investigated the problems of deep diving for the British Admiralty, developing the 'stage decompression' method, a lasting contribution to the diving world. This elaborate experimental investigation was conducted in part in a steel pressure chamber at the Lister Institute and with divers in Scottish deep-water lochs. In 1908, J.S. Haldane published those results in his seminal paper "Prevention of Compressed-Air Illness" in the *Journal of Hygiene* with Dr. A. E. Boycott and Lieutenant G. C. C. Damant. Stage decompression allowed divers to be safely brought to the surface and made it possible to conduct 120 fsw salvage operations on the LAURENTIC to recover over £5,000,000 of gold ingots without recordable incident.

## INTRODUCTION

John Scott Haldane can be considered the first environmental physiologist. As such, he was interested in how the human body functioned during normal life. To study that, he took his physiological insight to various extreme environments like coal mines, high altitudes, and under the ocean. Thus, using man as his subject, he showed how theoretical and experimental physiology could have direct applied uses. In modern terms, it could be said that he was the first to show the value of translational research, demonstrating for instance that the sensitivity of canaries to carbon monoxide (CO) could be used to prevent CO toxicity in man.

He was born in Edinburgh on 3 May, 1860, fourth son of Robert Haldane by his second wife Mary Elizabeth and died March 16, 1936, of pneumonia. Few pictures of J. S. Haldane actually exist. Haldane believed that "the aim of the science of physiology is to deliver general principles which shall enable us to predict behaviour of the living body under various physiological conditions." He was also considered the father of oxygen therapy: "The first step in good practice is to know what the oxygen is aiming at, where it is going, and in what quantities."

We know about Haldane from his work on developing decompression tables, but his contribution can only be understood if one considers his previous work and interests. First of all, Haldane was an observer and an experimentalist, who always pointed out that careful observation and experiments had to be the basis of any theoretical analysis.

*Alf O. Brubakk, Norwegian University of Science and Technology, Department of Circulation and Medical Imaging, 7491, Trondheim, Norway. Michael A. Lang, Smithsonian Institution, Office of the Under Secretary for Science, P.O. Box 37012, MRC 009, Washington, D.C. 20013-7012 U.S.A.*

“Why think when you can experiment” and “Exhaust experiments and then think.” His passion for obtaining data was demonstrated by the fact that during his medical studies in Jena, he carefully observed the amount of beer being drunk, noting that the students on the average drank about 20 pints per evening.

Haldane received his education at the Edinburgh Academy, University of Edinburgh (1884), and University of Jena in central Germany, after which he was a Demonstrator at University College, Dundee. From 1907-1913 he was a Reader in Physiology at Oxford University where his uncle, John Burdon-Sander-son, was Waynflete Professor of Physiology. J. S. Haldane became member of the Royal Society in 1897 but had issues such as “The Royal Society system of selecting papers and excluding ‘speculative’ ones makes the meetings, Proceedings and Transactions as dull as ditch water and quite unrepresentative of the progress of British Science” (Goodman, 2007). Regardless, he was awarded Royal Medallist of the Society in 1916, Copley Medallist in 1934, and in 1928 he was appointed Companion of Honour for his scientific work in connection with industrial disease.

J. S. Haldane was personally gifted with a unique power of encouraging the faculty for research and his teaching was characterized by his efforts to make the students observe and think for themselves. He had the great ability to add both force and charm or character, the effect of which was securing the attachment of his pupils. Haldane had a profound sense of public service and he believed passionately that the world could be made a better place through the application of science. From miners dying of carbon monoxide poisoning and soldiers being gassed like rats in the trenches, to mountaineers and aviators coping with high altitudes, Haldane showed that science could bring light into the darkness. A friend described him as “almost quixotically anxious to do good to all mankind – and to teach them all a thing or two” (Goodman, 2007).

Haldane was also a philosopher of science and many of his lectures were published in books, such as *The Sciences and Philosophy* in 1929, *The Philosophical Basis of Biology* in 1931, and *The Philosophy of a Biologist* in 1935.

## THE SELF-EXPERIMENTER

Haldane was “himself such a coalmine canary, putting his own health and life on the line to protect others” (Goodman, 2007). Haldane’s own philosophy was “All life is a physiological self experiment.” Once, on his way home from his laboratory after such an experiment, he was stopped by an Oxford policeman who had observed the scientist’s stumbling progress. Haldane explained that it was not due to alcohol, but gas. His housekeeper offered her sympathies to his wife, Kathleen: “I know how you feel, ma’am. My husband’s just the same on a Friday night.”

Haldane liked nothing better than to explore dangerous mine shafts and sewers. But it was in the specially constructed, air-tight chamber in his lab that the effects of gases on people were revealed. In an age before risk assessments, Institutional

Review Boards and Human Subjects Ethics Committees, Haldane was a serial self-experimenter. He also thought nothing of exposing his own son Jack to dangerous doses of chlorine and other noxious gases. His young daughter Naomi once told a 6-year-old friend outside their house: “You come in. My father wants your blood.” Her friend screamed and ran away.

## FIRST PAPER

Haldane’s first essay in 1883 with his brother Lord Haldane contributed to “Essays in Philosophical Criticism” examined the relationship of philosophy to science and attempted to answer the questions: “What is man; discover man’s relationship to his environment; and, knowing man’s relationship to his environment, determine his function, what is he most suited to do in the world?” His real interest was the study of the relationship between the organism and the environment. This, as well as his deep feeling for social issues, would determine the focus of his professional life.

## FIRST STUDY

Haldane as Sherlock Holmes, environmental investigator, asked a) What is bad air? b) What makes air dangerous to breathe? c) How can its bad effects be prevented? He proceeded by studying the air in overcrowded Dundee slums, turning up without warning in the middle of the night to collect air in bedrooms where eight people were sleeping. His results indicated that rooms of 180 cubic feet had 65% more carbon dioxide, twice as many molds, 254% more organic matter, including hydrogen sulfide (0.07% can be fatal), and 1000% more bacteria than normal.

## SELF EXPERIMENTS

Some of Haldane’s rebreathing experiments revolved around the concept of the good air being used up. His findings included that oxygen was a gas that supported life longer than an equal amount of air; that carbon dioxide spoils pure air once it was breathed; that after seven hours, O<sub>2</sub> was down to 13% and CO<sub>2</sub> was up to 6.5% accompanied by symptoms of heavy panting, severe headache, and vomiting; and, that after breathing O<sub>2</sub> of 2%, he went unconscious after 40 seconds. Word of his propensity for experimentation got out prompting one neighbor to knock on his door asking “My wife’s cat has been lost and we thought that possibly... it might be here.” Haldane invented the haemoglobinometer, the apparatus for blood-gas analysis and also designed an apparatus for the accurate and fast analysis of air or mixtures of gases (Snyder, 1937).

## THE STINK

When a Select Committee called upon him to “delve inside the lower depths of government and analyse the stink that flowed beneath,” Haldane ventured into the sewers below Westminster

Palace. A born iconoclast, he successfully challenged the idea that “sewer air” was a cause of typhoid and other diseases.

## COAL MINE CANARIES

*Serinus canaria* is affected by gas 20 times faster than man, prompting Haldane to hold canaries in cages in the mines. Being fundamentally a kind man and concerned about the animal’s well being, Haldane modified the cage so that only the front was open and could be o-ring sealed when closed. He had mounted a small oxygen bottle on top of the cage. When the canary fell off its perch from breathing toxic gas, he would shut the front door and open the oxygen bottle, ensuring the canary’s survival.

## MINE ACCIDENT EXPERIMENTS

In 1896, a mine explosion occurred in Tylorstown Colliery, Rhondda Valley, South Wales, with over 100 men below. Enter J. S. Haldane, “medical detective.” The toxic gas after the explosion (afterdamp) had not extinguished miners’ lamps, leading Haldane to believe that oxygen was present and suffocation needed to be ruled out. His diagnosis was accurate: 75% of the deaths were attributed not to blast injuries, but to CO poisoning as evidenced by pink and red skin coloration and carmine-red blood samples.

Further refinement of Haldane’s curiosity about why the miners died led to more self-experimentation. Breathing 0.2% CO for 71.5 minutes, Haldane’s vision became dim, his limbs weak, he had some difficulties in waking up or walking without assistance, and his movements were very uncertain. Afterwards he confessed feeling confused, making spelling mistakes, experiencing indistinct vision, and not recognizing what he saw. Oxygen breathing made dramatic improvements. On another occasion, after 29 minutes of breathing CO, Haldane calmly noted that he felt distinctly abnormal: he was panting, breathing 18 times a minute, his limbs shook and his pulse was racing. Soon, he began to feel unsteady on his feet.

## RESPIRATION STUDIES

Haldane and Priestly (1905) showed that the regulation of the breathing is normally determined by the tension of carbon dioxide in the respiratory center in the brain, and that this nervous center is sensitive to variations in the tension of carbon dioxide supplied in the arterial blood. Since carbon dioxide is one of the principal products of the metabolism of the tissues, an explanation was afforded of the automatic changes in breathing rates which occur with alteration in bodily activity.

## MORE ENVIRONMENTAL STUDIES

Haldane conducted other environmental studies on the effects of hyperthermia, nutrition, and in particular lung disease

mechanisms (lack of sunlight, poor ventilation, ladder climbing, infections, smoke, high and low temperatures, unsanitary conditions and breathing of stone dust - silicosis). Acott (1999) referred to Haldane as “the father of the salt tablet” for his recommendation of salt replacement during excessive sweating.

Haldane’s altitude studies consisted of work at Pikes Peak (1911) and Mount Everest of which he said “the highest points of the Earth could be reached without the help of oxygen, providing they had the right men and the right weather.” He was further involved with the design of the first prototype space suit (1921) and balloon flights to 90,000 feet (27,430 m) in 1933.

Also, the identification of nitrite ( $\text{NO}_2^-$ ) as the active ingredient in red meat curing procedures dates to the late 19th century. J.S. Haldane was the first to demonstrate that the addition of nitrite to hemoglobin produced a nitric oxide (NO)-heme bond, called iron-nitrosyl-hemoglobin ( $\text{HbFe}^{\text{II}}\text{NO}$ ). The reduction of nitrite to NO by bacteria or enzymatic reactions in the presence of muscle myoglobin formed iron-nitrosyl-myoglobin. It is nitrosylated myoglobin that gives cured meat, including hot dogs, their distinctive red color, and protects the meat from oxidation and spoiling (Gladwin, 2004).

## DECOMPRESSION STUDIES AND DIVING TABLES

Haldane found that it was not pressure that damaged the body, but differences in pressure. Paul Bert (1878) dived 24 dogs to 290 fsw with rapid decompression, resulting in death by nitrogen bubbles. In his studies using goats (Figs. 1a, b) at the Lister Institute of Preventive Medicine, Haldane used slow ascent rates of 5 feet/min. The decompression studies results were published in the seminal paper by Boycott, Damant, and Haldane (1908), one hundred years ago.

Haldane made the important observation that no diver had “the bends” after rapid decompression from 42 feet to the surface leading to the general principle that a 2 to 1 pressure difference could be tolerated. A staged-decompression technique was developed and tables describing uptake and elimination of nitrogen were developed by his son Jack Haldane at age 13. The body was divided into six compartments with different half times and the deepest dive tested to 210 fsw (64 msw).

Haldane also suggested that oxygen should be used to shorten decompression provided the pressure was kept less than 2 bar because of the fear of oxygen toxicity. However, Haldane made little contribution to the therapy of decompression sickness although he recognized that recompression was the treatment of choice. Haldane had doubts about the safety and efficacy of uniform decompression practice. Haldane’s experiments were conducted at the Lister Institute of Medicine in a recompression chamber and he assumed the following: a) for bubbles to form, the pressure of gas in the tissues must exceed the external pressure; b) that body tissues will hold gas in a supersaturated state unless a certain limit is reached; d) that any decompression is free from risk only if the degree of supersaturation “can be



borne with safety”; and, d) that tissue perfusion was the limiting factor in inert gas uptake (Boycott et al., 1908).

His decompression experiments examined the depth and pressure exposure, its duration, and the mode and decompression rate. Initially, a few experiments were conducted on rabbits, guinea pigs, rats and mice but it was difficult to detect symptoms in these smaller animals. The goat (Figs. 1a,b) was chosen as the experimental model “because they were the largest animals which could be conveniently dealt with” and “those who are familiar with them can detect slight abnormalities with a fair degree of certainty.” The dog was rejected because they had noted that Heller et al. (1900) had previously used them to produce “safe” decompression profiles that had failed in humans.

Goats were excluded from the experiments if they were ill. Only 5-8 goats were used per experiment. The chamber was not ventilated because they believed CO<sub>2</sub> to have a minimal effect on the susceptibility to decompression sickness. The chamber temperature was not controlled and no allowance was made for any variation in atmospheric pressure. Large pressure variations were used to produce minor to severe symptoms. The compression time of 6 minutes was neglected in short exposures but included in longer, deeper exposures.

At the time of the experiments, Haldane knew from Naval diving data that decompression from 2 bar produced no symptoms irrespective of the time of exposure. However, decompression from 2.25 bar produced the “occasional slight case” hence Haldane’s assumption that halving the pressure would not produce symptoms. He used a “perfusion” mathematical model of gas uptake, the half lives of which were calculated from data available at that time (Acott, 1999).

The most common bends symptoms in goats were limb pain where the affected limb, often the foreleg, was raised (Fig. 1a); pain was detected by “urgent bleating and continual

restlessness” with the goat often gnawing at the affected area “such as the testicles”; temporary paralysis noted about 15 min after decompression with improvement within 30 min and the animal being “quite well” the next day; permanent post-decompression paralysis where the hind legs were noted to be paralyzed immediately with any spontaneous improvement followed by a permanent relapse (urinary retention and an acute gut distension were also noted); “obviously ill” goats were noted to be apathetic and ill, refused “to move or to be tempted with corn (of which goats are inordinately fond)”; dyspnoea, a sinister symptom usually occurring just before the animal died; and, death. Importantly, Haldane’s data showed that goats had an individual variability and susceptibility to decompression sickness.

Diving tables were published in 1907, the Royal Navy adopted them for military divers in 1908, and the U.S. Navy in 1912. They became the Blue Book for civilian divers who felt no discomfort from working at 210 feet. Referring to applied physiology, Richard Haldane, John Scott’s brother, stated “Dr. Haldane has shown yet one more instance of the application of science to practical work.” Haldane continued to think about the decompression problem for the rest of his life, considering how to extend and extrapolate the tables.

The S.S. LAURENTIC (White Star Lines), built by Harland & Wolff at their Belfast yard, went down the slipway on 29 April 1909 at the time that construction on the TITANIC started. Captain Reginald Norton was chosen to carry 43 tons of gold bullion from Great Britain to Canada. On 25 January 1917, she struck a mine and sank within an hour in 40 m of water in Lough Swilly, Donegal, Ireland, with a huge loss of life and all the gold bullion. In 1906, Commander Guybon C.C. Damant had set a world diving record of 210 feet during Naval endurance diving tests. His experiences as a salvage diver were

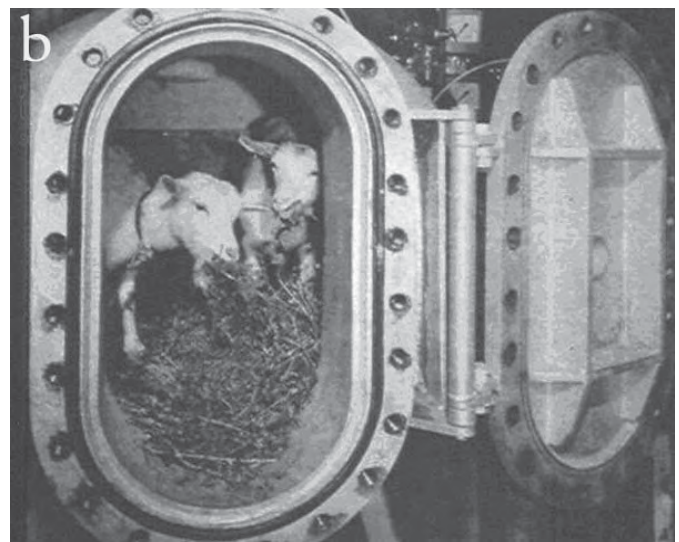

**FIGURE 1.** Bends in the foreleg of a goat (a) and goat chamber dives (b). Both figures from Boycott et al. (1908) and reprinted with permission from Cambridge University Press.



well known to the Admiralty. In 1917, the 36-year-old Damant and his team included Augustus Dent, a diver and aboard S.S. LAURENTIC when she sank, who knew where the bullion room was. An incredible salvage feat between 1917 and 1924 recovered 3,186 gold bars of the missing 3,211 with a further 5 being recovered in 1932 by another salvage operation, leaving 20 gold bars still unaccounted for at the bottom of Lough Swilly worth some £10 million at current prices. Over 5,000 salvage dives were conducted using Haldane's tables in a 200 square-yard working area at 120 feet with no loss of life or serious problems.

### HALDANE'S ENDURING LEGACY

Apart from his many important contributions to physiology, where perhaps the description of the principles of breathing control is the most significant, Haldane demonstrated that environmental physiology was a scientific discipline of considerable theoretical and practical value. By studying the intact organism in various extreme environments, he was able to determine how the environment influenced normal physiological variables as well as disease processes. This approach is still controversial, even in our own field, diving, where there is considerable support for focusing on "what works, works" and where studies of basic mechanisms are considered more of academic rather than practical value. Haldane, with his strong focus on science as the basis for his practical approach, demonstrated that real progress for improving health can only be achieved by combining the two. This is even clearer today as we increasingly are understanding how the environment may even influence gene expression.

### ACKNOWLEDGMENTS

We wish to thank the Haldanes and their enduring effect, the Baromedical and Environmental Physiology Group at the Norwegian University of Science and Technology in Trondheim, and the Smithsonian Office of the Under Secretary for Science.

### LITERATURE CITED

- Acott, C. J. 1999. J. S. Haldane, J. B. S. Haldane, L. Hill, and A. Siebe: A brief resume of their lives. *South Pacific Undersea Medical Society Journal* 29(3):161–165.
- Bert, P. 1878. *Barometric pressure*. Translation by Hitchcock, M. A. and F. A. Hitchcock. Columbus, Ohio: College Book Company, 1943. Republished Bethesda, Maryland: Undersea Medical Society, 1978
- Boycott, A. E., G. C. C. Damant, and J. S. Haldane. 1908. Prevention of compressed air illness. *Journal of Hygiene, Cambridge* 8:342–425.
- Gladwin, M. T. 2004. Haldane, hot dogs, halitosis, and hypoxic vasodilation: the emerging biology of the nitrite anion. *Journal of Clinical Investigations* 113(1):19–21.
- Goodman, M. 2007. *Suffer and Survive. Gas Attacks, Miners' Canaries, Space-suits and the Bends: The Extreme Life of J. S. Haldane*. London: Simon and Schuster. 320 pp.
- Haldane, J. S., and J. G. Priestley. 1905. **The regulation of the lung-ventilation.** *Journal of Physiology* 32:225–266.
- Heller, R., W. Mager, and H. von Schrötter. 1900. *Luftdruckerkrankungen. Mit Besonderer Berücksichtigung der Sogenannten Caissonkrankheit*. Vienna: Hölder.
- Snyder, J. C. 1937. A note on the use of the Haldane apparatus for the analysis of gases containing ether vapor. *Journal of Biological Chemistry* 122:21–25.



# Environmental Physiology of the Future

*Richard E. Moon*

---

**ABSTRACT.** Environmental physiology consists of the varied responses and adaptations of organisms to environmental stresses. These include cold, heat, water immersion, high and low ambient pressure and microgravity. Why should environmental physiology be studied? First of all, understanding of the human response to the environment can lead to protective strategies in adverse conditions. A second reason is that humans often voluntarily expose themselves to conditions in the field that would never be allowed by any human ethics committee. Studying people under such circumstances can elucidate and lead to understanding of basic mechanisms. Systematic study of humans under different environmental conditions began in earnest in the 19th century, when exemplary experiments were conducted in hypo- and hyperbaria. Hypoxia, hyperoxia, high and low G, and high ambient pressure have been extensively studied. However, much remains to be learned. For instance, exposure to altitude hypoxia is known to cause several clinical syndromes. While strategies to prevent and treat these conditions are well known, their etiologies are obscure. Procedures for compressing and decompressing divers have also been worked out, at least to a degree of safety that is acceptable. We know that bubbles instigate decompression illness. However, we know little about the biochemical connections between bubbles and syndromes. The almost exclusive focus on bubble formation, growth, and resolution has blinkered investigators to molecular pathways that bubbles may trigger, the understanding of which could lead to improved prevention and treatment. I propose two approaches that need greater emphasis. (1) Most physiology is based upon studies of the steady state, but there is much to be learned by studying physiological transients. (2) While studies of macro-physiology are crucial, they alone will not lead to a complete understanding of environmental physiology, which can only be achieved by parallel study of cellular and molecular mechanisms.

## INTRODUCTION

**E**nvironmental physiology can be defined as the study of adaptation to environmental conditions, which are often adverse. These include the following conditions: altitude, hyperbaria, immersion, extremes of temperature, dehydration, and altered G force: microgravity or increased G.

Environmental physiology is worthy of study for at least two reasons. The first is that because humans and other animals live in, or voluntarily expose themselves to, such adverse conditions, an understanding of the biological effects is of intrinsic interest and importance. The second is that for those interested in understanding human physiology, environmental physiology in the field consists of an experiment in which people willingly expose themselves for fun to the kind of condition that might, for classic experimental purposes, be considered unethical.

Like most areas of science, environmental physiology received its major start in the 19th century. An example is the series of observations that were made during high altitude balloon flights. Glaisher, in 1871, reported that “the number of heart beats per minute increases with the altitude ... at 10,000 feet, certain persons are of a flaming

purplish red, while others are hardly affected. At 17,000 feet my lips were blue” (Doherty, 2003). Amongst other things, Glaisher’s observations pointed out the variability of the biological response to hypoxia.

## ALTITUDE PHYSIOLOGY: FROM THE FIELD TO THE LAB

An understanding of the effects of varying degrees of hypoxia on oxidative capacity has been obtained from field measurements by Pugh et al. (1964). Field observations then led to laboratory studies of acclimatization in a hypobaric chamber, where sophisticated measurements can be obtained such as arterial and mixed venous blood gases, cardiac output, and ventilation-perfusion relationships using the multiple inert-gas elimination technique (Sutton et al., 1988). Exposure to extreme levels of hypoxia and hyperoxia in a laboratory setting has also given us an understanding of vasoregulation in the pulmonary circulation. While hypoxia causes an increase in pulmonary vascular resistance, hyperoxia at 3 atmospheres absolute (ATA) actually reduces pulmonary vascular resistance (McMahon et al., 2002).

It has been pointed out that the warm, comfortable environment in the laboratory setting does not accurately represent conditions in the field. This has led to application of monitoring techniques previously available only in the lab to the mountain environment with often spectacular results (Scherrer et al., 1996; Maggiorini, 2006). Ear oximetry under field conditions has revealed evidence of exceptionally low hemoglobin-oxygen saturations (Hackett and Roach, 1987) (see Fig. 1). End-tidal  $PCO_2$  measurements atop Mount Everest revealed values lower than expected from the laboratory environment (Sutton et al.,

1988; Malconian et al., 1993). More recently, arterial blood gas analysis has been obtained from climbers very close to the summit of Mount Everest, with yet different values (Grocott et al., 2009).

Of course, arterial and mixed venous blood gas analysis represents only surrogate measurements of processes at the level of the cell (see Fig. 2). We have learned from near infrared absorption that there is variability in the response of tissue to the type of changes that occur during altitude exposure. For example, Hampson and Piantadosi (1990) observed measurable changes in cytochrome  $a_3$  redox level in the brain during manipulation of arterial  $PCO_2$ . During hypocapnia cytochrome  $a_3$  redox in the brain moves towards a reduced state, presumably due to a reduction in cerebral blood flow and oxygen delivery. At the same time, only minimal changes occur in muscle (see Fig. 3). This may explain how the profound hypocapnia that occurs during high altitude exposure may adversely affect brain oxygenation while muscle oxygenation is maintained within acceptable limits. As yet, estimates of tissue oxygenation using needle electrodes or near infrared optical techniques have had limited field use.

The clinical conditions associated with prolonged hypoxia have been well described from field observations. Acute mountain sickness (AMS) consists of nausea, headache, and malaise. While this disorder is poorly understood, the time course of its spontaneous resolution even when hypoxia is maintained (Sampson and Kobrick, 1980) and development of appropriate prophylactic measures have also been developed from observations in the field. Headache and progressive encephalopathy are the hallmarks of high altitude cerebral edema (HACE), in which, despite its name, there is scant evidence for significant cerebral edema (see below).

High altitude pulmonary edema (HAPE) is a condition of generally healthy people, which became well-known during the India-China border conflict of 1962, where the incidence of HAPE was noted to be 13-15% among Indian army recruits transported rapidly from sea level to altitudes above 3,350 m (Menon, 1965; Singh et al., 1965). The condition was initially believed to be due to acute left heart failure induced by hypoxia, a hypothesis that was quickly dismissed by right heart catheterization measurements. Pulmonary artery wedge pressure in patients afflicted with HAPE was shown to be normal, although

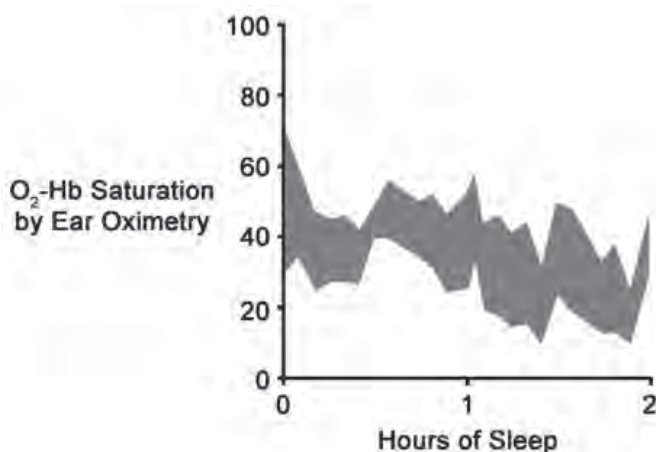

FIGURE 1. Ear oximeter in a sleep study of a climber at 4,400 m on Mt. McKinley. When he attempted to climb to a higher altitude he developed severe AMS. The severe degree of his hypoxemia may have been explained by a negligible increase in ventilation when exposed to hypoxia (absent hypoxic ventilatory response). Redrawn from Hackett and Roach (1987), with permission.

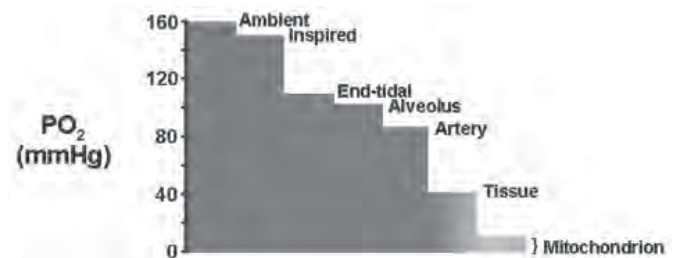
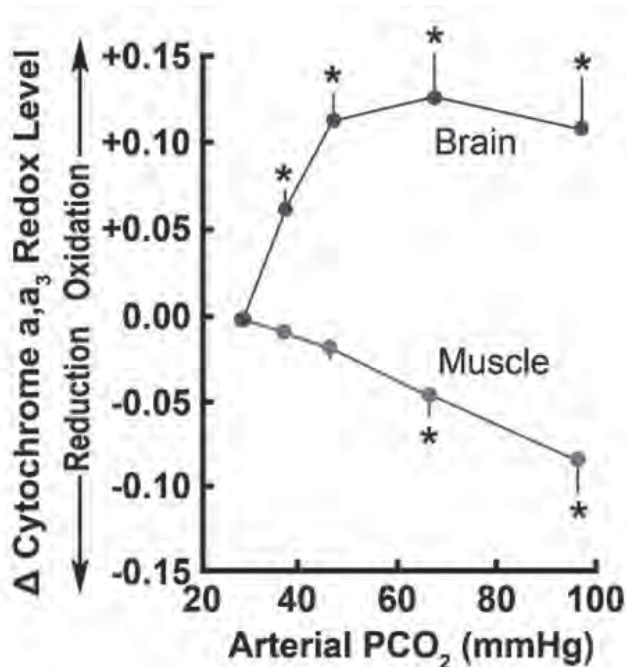

FIGURE 2. Oxygen transport cascade from atmosphere to mitochondrion. From Moon and Camporesi (2004), with permission.



**FIGURE 3.** Muscle and brain redox as a function of PCO<sub>2</sub>. During hypocapnia cytochrome a, a<sub>3</sub> redox in the brain becomes more reduced, presumably due to reduced cerebral blood flow and oxygen delivery. Hypocapnia induces only minimal changes in muscle. Redrawn from Hampson and Piantadosi (1990), with permission.

pulmonary artery pressure was high (Fred et al., 1962; Hultgren et al., 1964).

This provided a clue, since the previously described increase in pulmonary artery pressure with hypoxia (hypoxic pulmonary vasoconstriction, HPV) tends to be greater in people susceptible to HAPE (Hultgren et al., 1971). Furthermore, reducing PA pressure with vasodilators can prevent and treat HAPE (Scherrer et al., 1996; Maggiorini et al., 2006; Anand, 1998). Observations using the balloon occlusion method to estimate pulmonary capillary pressure have further implicated high intravascular pressure as a cause of HAPE (Maggiorini et al., 2001). A genetic predisposition to HAPE has been suggested by evidence implicating polymorphisms of the eNOS gene (Dehnert et al., 2007).

While the mechanisms of HPV are incompletely understood, recent advances have been based upon molecular evidence implicating nitric oxide as a mediator. Observations by McMahon et al. (2002) have demonstrated the relationship between blood PO<sub>2</sub> and S-nitrosohemoglobin. In low PO<sub>2</sub> situations, NO is released from its binding to reactive thiols (Cys β<sub>93</sub>) of hemoglobin. A genetic factor is suggested by racial differences in the degree of HPV. The rise in pulmonary artery pressure in response to hypoxia is greatest in North Americans, somewhat attenuated in South Americans, and significantly less in Tibetans, a population adapted to high altitude (Groves et al., 1993). Recently it has been observed that Tibetans have a significant higher concentration of nitroso proteins in the blood

than low altitude US residents, yet during hypoxia their forearm blood flow is twice as high (Erzurum et al., 2007).

## DIVING PHYSIOLOGY AND MEDICINE

As in altitude physiology, high pressure physiology began as a result of the adverse effects of large numbers of caisson and tunnel workers during and after exposure to compressed air. Musculoskeletal and neurological syndromes occurring after decompression from high pressure were initially not understood and not treatable. In 1878, Bert (1978) provided the first clues as to pathophysiology by demonstrating that decompression of animals after a hyperbaric exposure produced bubbles in the blood, and that administration of oxygen would resolve them. We now know that bubble formation in tissues can occur either via *de novo* formation of bubbles *in situ* due to supersaturation of inert gas (usually N<sub>2</sub> or He) in tissue or due to pulmonary barotrauma during decompression. Treatment of so-called decompression illness (DCI) was developed entirely empirically on the basis of men experiencing relief of symptoms upon re-entering the compressed air environment during a following shift. This was eventually systematized by Ernest Moir, an engineer, who instituted regular recompression for afflicted men working in the Hudson River tunnel project in New York City. Moir's approach of recompression using air reduced the death rate from 25% per annum to 2 deaths of 120 men at work in 15 months (1.3%) (Moir, 1896). This therapeutic success was followed by successful strategies to prevent compressed air illness, in which staged decompression was proposed by Boycott et al. (1908).

While it is generally agreed that bubbles are the instigators of decompression illness, little is known about the downstream events that produce decompression sickness. One mechanism for which there is some evidence is related to bubble-induced damage to the endothelium. Once believed to be nothing more than the lining of blood vessels, the endothelium is now understood to play a major role in maintenance of fluid homeostasis and regulation of vascular tone. In the endothelium, the enzyme nitric-oxide synthase catalyzes the reaction of oxygen and L-arginine to produce nitric oxide (NO) and citrulline. Nitric oxide can then diffuse into the bloodstream where it can inhibit adhesion of platelets and leucocytes. It can also diffuse into the adjacent smooth muscle cell. There, it activates the enzyme guanylyl cyclase, which facilitates the conversion of GTP to cyclic GMP (cGMP). This initiates a series of reactions that result in relaxation of vascular smooth muscle. This mechanism underlies the effect of agonists that interact with receptors on the endothelium cell, such as catecholamines. It has been demonstrated that vascular bubbles can injure the endothelium and reduce the vasoactive effects of compounds such as substance P and acetylcholine (Nossum et al., 1999). Nitric oxide production can be up-regulated by exercise. Indeed, studies in animals (Wisløff et al., 2004) and humans (Dujic et al., 2004) have provided preliminary evidence that appropriately timed exercise prior to



a decompression stress may reduce the number of intravascular bubbles. Similarly, administration of nitroglycerine to animals prior to decompression stress can reduce venous gas embolism (Møllerløkken et al., 2006). Whether either of these interventions will reduce decompression sickness in humans remains to be investigated.

## FROM BODY TO MOLECULE: ORTHOSTATIC INTOLERANCE AFTER SPACE FLIGHT

Orthostatic intolerance is commonly experienced after spaceflight (Buckey et al., 1996). This was initially believed to be mostly caused by relative hypovolemia induced in space by diuresis due to central translocation of blood from the extremities (Blomqvist and Stone, 1983). If this were the sole mechanism the syndrome should be preventable by volume loading prior to re-entry and landing. However, evidence has accumulated suggesting impaired vasoconstrictive response to standing (Buckey et al., 1996). Using a rat model designed to simulate weightlessness (hind limb unloading with head down position) impairment of the arterial vasoconstrictor response to norepinephrine was observed (Delp et al., 1993; Purdy et al., 1998). Another possible mechanism involves up-regulation of eNOS (Nyhan et al., 2002). Such observations not only provide a more complete understanding of the problem, but will undoubtedly lead to more effective pharmacological or physiological countermeasures.

## STEADY STATE MEASUREMENTS: BLINDERS ON

While advanced technology is facilitating increasingly sophisticated measurements in environmental physiology, our understanding is thus far largely built on steady state measurements. However, significant transients can be missed by steady state techniques. For example, in primary pulmonary hypertension, indwelling pulmonary artery catheters have shown that mean pulmonary artery pressure and pulmonary vascular resistance may change substantially from hour to hour (Rich et al., 1985). Similarly, during acute immersion in cold water, quite large transient changes occur in both systemic and pulmonary artery pressure (Wester et al., 2009). Another example is “normal pressure” hydrocephalus, a condition consisting of gait disturbance, cognitive decline and incontinence. In this condition enlarged ventricles suggest that intracranial pressure (ICP) is elevated. Static measurements of ICP in this condition are usually normal, however long term observations of intracranial pressure in these patients reveal cyclical variations, with periodic elevations to high levels (McGirt et al., 2005).

The pathophysiology of high altitude headache is unknown, but the possibility has been raised that it may be due to increased intracranial pressure, although with some contrary

evidence. For example, a study in which normal volunteers breathed 12% oxygen for 18 hours induced either severe headache or clinical acute mountain sickness (AMS) (Bailey et al., 2006). However, there was neither MRI evidence of brain edema nor elevation of lumbar CSF pressure. The possibility that transients may be important has been suggested by a remarkable field study, in which ICP was directly measured in three subjects during an expedition to Hagshu Peak in the Himalayas (altitude 6,330 m) (Wilson and Milledge, 2008). While under resting conditions CSF pressure was normal, intermittent pressure elevations occurred in two of three subjects studied. Of these three subjects the only one to develop headaches was a subject in whom elevated CSF pressure was observed.

## SUMMARY

Measurements at the level of the whole organism provide fundamental observations and remain the bedrock of our descriptions of environmental physiology. Whole human or animal studies should provide the impetus to look beyond our original observations into the cellular and molecular mechanisms. By so doing, we may gain an understanding of not only phenomena of immediate interest, but of physiology in general. Further advances will require widening of the scope of research (traditionally based on steady state methods) to include techniques that can detect and measure transients. By implementing a wider array of investigative techniques to include transient phenomena and cellular and molecular methodologies, a clearer understanding might be obtained of hitherto elusive phenomena such as high altitude pulmonary edema and decompression sickness.

## LITERATURE CITED

- Anand, I.S., B.A. Prasad, S.S. Chugh, K.R. Rao, D.N. Cornfield, C.E. Milla, N. Singh, S. Singh, W. Selvamurthy. 1998. Effects of inhaled nitric oxide and oxygen in high-altitude pulmonary edema. *Circulation* 98:2441–2445.
- Bailey, D.M., R. Roukens, M. Knauth, K. Kallenberg, S. Christ, A. Mohr, J. Genius, B. Storch-Hagenlocher, F. Meisel, J. McEneny, I.S. Young, T. Steiner, K. Hess, and P. Bartsch. 2006. Free radical-mediated damage to barrier function is not associated with altered brain morphology in high-altitude headache. *Journal of Cerebral Blood Flow and Metabolism* 26:99–111.
- Bert, P. 1978. *Barometric Pressure (La Pression Barométrique)*. Bethesda, MD: Undersea Medical Society.
- Blomqvist, C.G., and H.L. Stone. 1983. Cardiovascular adjustments to gravitational stress. In Shepher, J.T., and F.M. Abboud, eds. *The Cardiovascular System*. Bethesda, MD: American Physiological Society. pp. 1025–1063.
- Boycott, A.E., G.C.C. Damant, and J.S. Haldane. 1908. Prevention of compressed air illness. *Journal of Hygiene (Cambridge)* 8:342–443.
- Buckey, J.C., Jr., L.D. Lane, B.D. Levine, D.E. Watenpaugh, S.J. Wright, W.E. Moore, F.A. Gaffney, and C.G. Blomqvist. 1996. Orthostatic intolerance after spaceflight. *Journal of Applied Physiology* 81:7–18.
- Dehnert, C., M.M. Berger, H. Mairbaurl, and P. Bartsch. 2007. High altitude pulmonary edema: a pressure-induced leak. *Respiratory Physiology and Neurobiology* 158:266–273.
- Delp, M.D., T. Holder-Binkley, M.H. Laughlin, and E.M. Hasser. 1993. Vasoconstrictor properties of rat aorta are diminished by hindlimb unweighting.

- Journal of Applied Physiology* 75:2620–2628.
- Doherty, M.J. 2003. James Glaisher's 1862 account of balloon sickness: altitude, decompression injury, and hypoxemia. *Neurology* 60:1016–1018.
- Dujić, Ž., D. Duplančić, I. Marinović-Terzić, D. Baković, V. Ivančev, Z. Valic, D. Eterović, N.M. Petri, U. Wisloff, and A.O. Brubakk. 2004. Aerobic exercise before diving reduces venous gas bubble formation in humans. *Journal of Physiology* 555(3):637–642.
- Erzurum, S.C., S.Ghosh, A.J. Janocha, W. Xu, S. Bauer, N.S. Bryan, J. Tejero, C. Hemann, R. Hille, D.J. Stuehr, M. Feelisch, and C.M. Beall. 2007. Higher blood flow and circulating NO products offset high-altitude hypoxia among Tibetans. *Proceedings of the National Academy of Sciences* 104:17593–17598.
- Fred, H.L., A.M. Schmidt, T. Bates, and H.H. Hecht. 1962. Acute pulmonary edema of altitude. *Circulation* 25:929–937.
- Grocott, M.P., D.S. Martin, D.Z. Levett, R. McMorrow, J. Windsor, and H.E. Montgomery. 2009. Arterial blood gases and oxygen content in climbers on Mount Everest. *New England Journal of Medicine* 360:140–149.
- Groves, B.M., T. Droma, J.R. Sutton, R.G. McCullough, R.E. McCullough, J. Zhuang, G. Rapmund, S. Sun, C. Janes, and L.G. Moore. 1993. Minimal hypoxic pulmonary hypertension in normal Tibetans at 3,658 m. *Journal of Applied Physiology* 74:312–318.
- Hackett, P.H., and R.C. Roach. 1987. Medical therapy of altitude illness. *Annals of Emergency Medicine* 16:980–986.
- Hampson, N.B., and C.A. Piantadosi. 1990. Near-infrared optical responses in feline brain and skeletal muscle tissues during respiratory acid-base imbalance. *Brain Research* 519:249–254.
- Hultgren H.N., C.E. Lopez, E. Lundberg, and H. Miller. 1964. Physiologic studies of pulmonary edema at high altitude. *Circulation* 29:393–408.
- Hultgren, H.N., R.F. Grover, and L.H. Hartley. 1971. Abnormal circulatory responses to high altitude in subjects with a previous history of high-altitude pulmonary edema. *Circulation* 44:759–770.
- Maggiorini, M., C. Melot, S. Pierre, F. Pfeiffer, I. Greve, C. Sartori, M. Lepori, M. Hauser, U. Scherrer, and R. Naeije. 2001. High-altitude pulmonary edema is initially caused by an increase in capillary pressure. *Circulation* 103:2078–2083.
- Maggiorini, M., H.P. Brunner-La Rocca, S. Peth, M. Fischler, T. Bohm, A. Bernheim, S. Kiencke, K.E. Bloch, C. Dehnert, R. Naeije, T. Lehmann, P. Bartsch, and H. Mairbaurl. 2006. Both tadalafil and dexamethasone may reduce the incidence of high-altitude pulmonary edema: a randomized trial. *Annals of Internal Medicine* 145:497–506.
- Malconian, M.K., P.B. Rock, J.T. Reeves, A. Cymerman, and C.S. Houston. 1993. Operation Everest II: gas tensions in expired air and arterial blood at extreme altitude. *Aviation, Space, and Environmental Medicine* 64:37–42.
- McGirt, M.J., G. Woodworth, A.L. Coon, G. Thomas, M.A. Williams, and D. Rigamonti. 2005. Diagnosis, treatment, and analysis of long-term outcomes in idiopathic normal-pressure hydrocephalus. *Neurosurgery* 57:699–705.
- McMahon, T.J., R.E. Moon, B.P. Luschinger, M.S. Carraway, A.E. Stone, B.W. Stolp, A.J. Gow, J.R. Pawloski, P. Watke, D.J. Singel, C.A. Piantadosi, and J.S. Stamler. 2002. Nitric oxide in the human respiratory cycle. *Nature Medicine* 8:711–717.
- Menon, N.D. 1965. High-altitude pulmonary edema: a clinical study. *New England Journal of Medicine* 273:66–73.
- Moir, E.W. 1896. Tunnelling by compressed air. *Journal of the Society of Arts* 44:567–585.
- Møllerlökken, A., V.J. Berge, A. Jørgensen, U. Wisloff, and A.O. Brubakk. 2006. Effect of a short-acting NO donor on bubble formation from a saturation dive in pigs. *Journal of Applied Physiology* 101:1541–1555.
- Moon, R.E., and E.M. Camporesi. 2004. Respiratory monitoring. In Miller, R.D., ed. *Anesthesia*. 6th ed. Philadelphia: Churchill Livingstone. pp. 1437–1481.
- Nossum, V., S. Koteng, and A.O. Brubakk. 1999. Endothelial damage by bubbles in the pulmonary artery of the pig. *Journal of Undersea and Hyperbaric Medicine* 26:1–8.
- Nyhan, D., S. Kim, S. Dunbar, D. Li, A. Shoukas, and D.E. Berkowitz. 2002. Impaired pulmonary artery contractile responses in a rat model of microgravity: role of nitric oxide. *Journal of Applied Physiology* 92:33–40.
- Pugh, L.G., M.B. Gill, S. Lahiri, J.S. Milledge, M.P. Ward, and J.B. West. 1964. Muscular exercise at great altitudes. *Journal of Applied Physiology* 19:431–440.
- Purdy, R.E., S.P. Duckles, D.N. Krause, K.M. Rubera, and D. Sara. 1998. Effect of simulated microgravity on vascular contractility. *Journal of Applied Physiology* 85:1307–1315.
- Rich, S., G.E. D'Alonzo, D.R. Dantzker, and P.S. Levy. 1985. Magnitude and implications of spontaneous hemodynamic variability in primary pulmonary hypertension. *American Journal of Cardiology* 55:159–163.
- Sampson, J.B., and J.L. Kobrick. 1980. The environmental symptoms questionnaire: revisions and new filed data. *Aviation, Space, and Environmental Medicine* 51:872–877.
- Scherrer, U., L. Vollenweider, A. Delabays, M. Savcic, U. Eichenberger, G.R. Kleger, A. Fikrl, P.E. Ballmer, P. Nicod, and P. Bartsch. 1996. Inhaled nitric oxide for high-altitude pulmonary edema. *New England Journal of Medicine* 334:624–629.
- Singh, I., C.C. Kapila, P.K. Khanna, R.B. Nanda, and B.D. Rao. 1965. High-altitude pulmonary oedema. *Lancet* 1:229–234.
- Sutton, J.R., J.T. Reeves, P.D. Wagner, B.M. Groves, A. Cymerman, M.K. Malconian, P.B. Rock, P.M. Young, S.D. Walter, and C.S. Houston. 1988. Operation Everest II: oxygen transport during exercise at extreme simulated altitude. *Journal of Applied Physiology* 64:1309–1321.
- Wester, T.E., A.D. Cherry, N.W. Pollock, J.J. Freiburger, M.J. Natoli, E.A. Schinazi, P.O. Doar, A.E. Boso, E.L. Alford, A.J. Walker, D.M. Ugucioni, D. Kernagis, and R.E. Moon. 2009. Effects of head and body cooling on hemodynamics during immersed prone exercise at 1 ATA. *Journal of Applied Physiology* 106:691–700.
- Wilson, M.H., and J. Milledge. 2008. Direct measurement of intracranial pressure at high altitude and correlation of ventricular size with acute mountain sickness: Brian Cummins' results from the 1985 Kistwar expedition. *Neurosurgery* 63:970–975.
- Wisloff, U., R.S. Richardson, and A.O. Brubakk. 2005. Exercise and nitric oxide prevent bubble formation: a novel approach to the prevention of decompression sickness? *Journal of Physiology* 555:825–829.





# An Introduction to Clinical Aspects of Decompression Illness (DCI)

*Costantino Balestra*

---

**ABSTRACT.** Decompression Illness (DCI), Decompression Sickness (DCS), Dysbaric Illness (DI), disorder, syndrome are terms associated with the clinical signs or symptoms originally generated by a reduction of absolute pressure surrounding the patient. For 100 years the definition of the “disease” is a matter of “disputes” or “consensi”. We understand nowadays that it is not enough to know how to cure evident clinical manifestations, but also to reduce or virtually eliminate the primary physical cause for the physiological damages: the gas separation phase from saturated tissues – stationary or circulating bubbles. To achieve this goal, research is more oriented on the decompression procedures or the diver pre-conditioning (heat exposure, physical activity, whole body vibration, antioxidant medication, oxygen breathing, hyperbaric oxygen therapy, hydration or dehydration) and post-conditioning (different decompression procedures or models, deep stops, shallow stop followed by a deeper one, post exposure hydration, speed of ascent, exercise during decompression). Some factors that were believed to be crucial, such as patency of the cardiac Foramen Ovale or gender, are considered less important than modified decompression procedures that are studied today with sharper technology.

## INTRODUCTION

**D**ecompression Illness (DCI) is a complex condition that can appear with a wide variety of signs and symptoms. Any significant organic or functional decrement in individuals who have been exposed to a reduction in environmental pressure must be considered as possibly being DCI until proven otherwise. This applies to acute, sub-acute and chronic changes related to decompression and may be related to acute clinical symptoms or to situations that may develop subclinically and insidiously. It is in fact generally accepted that subclinical forms of DCI, with little or no reported symptoms, may cause changes in the bones, the central nervous system and the lungs (Kelemen, 1983; Shinoda et al., 1997; Wilmshurst and Ross, 1998).

Generally, a disorder is a physical derangement, frequently slight and transitory in nature. A disease is considered a condition of an organ, part, structure, or system of the body in which there is abnormal function resulting from genetic predisposition, diet, or environmental factors. A disease is typically a more serious, active, prolonged and deep-rooted condition. DCI should be considered a disorder due to a physical primary cause that can transform into a disease unless adequate and timely action is undertaken to abort or to minimize the pathophysiological effects of bubbles on the body tissues.

The predominant physical cause of DCI is the separation of gas in the body's tissues, due to inadequate decompression, leading to an excessive degree of gas supersaturation (Kumar et al., 1990). Rapid decompression (rate of ascent or omission of decompression stops) is a primary cause of gas separation in tissues (Figure 1).

The most obvious prevention strategy for DCI is, therefore, determining and observing appropriate ascent and decompression procedures (Marroni and Zannini, 1981;

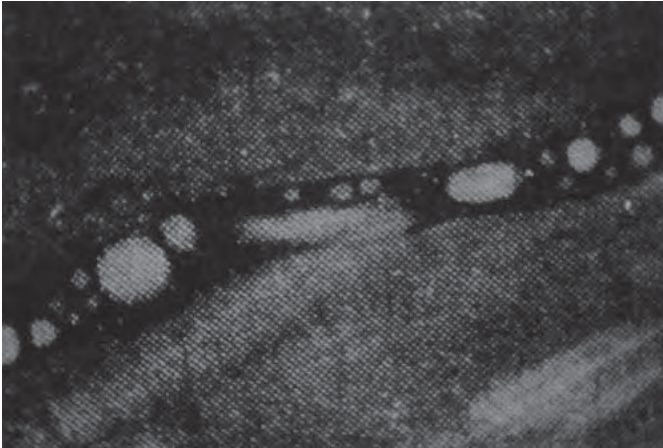

**FIGURE 1. Intravascular bubbles in rodent submaxillary capillaries (Courtesy of Divers Alert Network)**

Marroni et al., 2001). Unfortunately, the recommendations for decompression are largely empirical and not always reliable. This is confirmed by the finding that more than half of the DCI cases managed by Divers Alert Network (DAN) worldwide over the past several years have not been associated with an obvious violation of decompression procedures, dive table or dive computer limits; they have been “unpredictable”. This has led to a search for other contributing factors to the development of DCI, such as a Patent Foramen Ovale, in an effort to explain the wide variation in individual susceptibility to DCI. Other factors include complement activation in the presence of gas bubbles as well as an uncertain relationship between gas bubbles, blood cells, and the capillary endothelial lining in response to bubble presence and development of DCI.

The manifestations of DCI are sometimes trivial and subtle. These are likely to be ignored or denied by individual divers, training organizations, and emergency physicians unless they are made aware of them and offered specific information on the manifestations of DCI. However, there appears to be growing evidence that under-reported, under-estimated and under-treated signs and symptoms of DCI may result in permanent organic or functional damage so that raising the level of suspicion amongst divers and physicians alike becomes increasingly important.

Although the presence of Doppler-detectable gas bubbles in the blood is not necessarily predictive of clinically evident DCI, the appearance of DCI in the absence of detectable pulmonary artery and venous bubbles is rare. There is even growing experimental and clinical evidence that suggests that asymptomatic “silent” bubbles in the body may be causing cellular and biological reactions that release secondary potentially damaging biochemical substances in the blood.

## DEFINING DCI

The previously adopted classification criteria, i.e., Type I or Type II DCS (decompression sickness) and AGE (Arterial Gas Embolism), are inadequate in that they presume that the

underlying pathophysiology is fully appreciated. Unfortunately, there is great disparity in the application of this classification of DCI amongst specialists when asked to define similar cases of decompression disorders using this traditional classification. Consequently, a descriptive form of classification has appeared that uses the common term “DCI”, followed by a description of the clinical signs and symptoms and their onset and development characteristics. The latter has been considered both more universally understandable and simpler to teach. It also shows a much higher degree of correlation among specialists describing the same DCI cases. For purposes of clarity and consistency, DCI refers to disorders of decompression that are clearly due to DCS or where the origin or embolized gas cannot be definitively attributed to pulmonary barotrauma. Where the cause of arterial embolization is the direct consequence of pulmonary overexpansion, the term AGE is used.

Epidemiologically, there is universal consensus among the international diving medical community that the incidence of DCI is generally very low and that there is no significant gender-related susceptibility. There is also consensus that neurological manifestations are by far the most common form of DCI amongst recreational divers.

Many yet unknown aspects of DCI are the subject of ongoing international studies. These include: the relationship between gas separation and DCI injury, the relationship between clinical symptoms and the severity of the disease, the relationship between initial clinical onset, treatment results, and permanent sequelae, the reason for the large variation in individual susceptibility to DCI, the lifespan of gas bubbles; and the true incidence of DCI.

## DCI HISTORY

Boyle (1670) demonstrated that DCI could be produced in a reptile by a sudden lowering of atmospheric pressure. The first clinical recording of DCI was in compressed-air workers. Triger (1845) reported that two men had suffered “very sharp pain” in the left arm and another had pain in the knees and left shoulder 30 minutes after emerging from a seven-hour exposure at pressure (the pressure could have ranged between 2.4 and 4.25 atm). Although not knowing what it was, Triger also reported the clinical treatment for DCI as “rubbing with spirits of wine soon relieved this pain in both men and they kept working on the following days”. Pol and Wattle (1854) wrote that they were “justified in hoping that a sure and prompt means of relief would be to recompress immediately, then decompress very carefully”. Yet it was only many years later that their advice was heeded.

In 1878, Paul Bert demonstrated that the cause of DCI was dissolved nitrogen going into gas phase in body tissues and that this bubble formation was responsible for symptoms. Bert also highlighted the existence of “silent bubbles” in the venous blood. He understood that recompression was the key treatment of value and that it should be applied promptly. He also used oxygen at one atmosphere following very rapid decompression

and observed that cardiopulmonary symptoms, but not spinal cord paralysis, could be relieved by normobaric oxygen breathing (Bert et al., 1943).

Moir (1896) published his work on the 1889 excavations of the Hudson River tunnel. Facing a tragic fatality rate of 25% of the employed workers due to DCI, he installed a recompression chamber at the work site. Following this intervention there were only a further two deaths out of 120 men employed over the following 15 months. Moir wrote:

With a view to remedying the state of things an air compartment like a boiler was made in which the men could be treated homeopathically, or reimmersed in compressed air. It was erected near the top of the shaft, and when a man was overcome or paralyzed, as I have seen them often, completely unconscious and unable to use their limbs, they were carried into the compartment and the air pressure raised to about 1/2 or 2/3 of that in which they had been working, with immediate improvement. The pressure was then lowered at the very slow rate of one pound per minute or even less. The time allowed for equalization being from 25 to 30 minutes, and even in severe cases the men went away quite cured.

Unknowingly, Moir was recording both the means of prevention and treatment of DCI. Variations of his techniques, now called surface decompression, are currently still used.

Even though few subsequent publications appeared on recompression treatment for the next 30 years, it was the widely accepted notion that, to be effective, recompression should commence promptly followed by slow decompression. These principles remain in effect to this day even though the pressures used, breathing gases applied, and rates of decompression observed, have undergone much modification.

## ETIOLOGY AND PATHOPHYSIOLOGY OF DCI

DCI is a disease with protean clinical manifestations. It follows the appearance of gas bubbles produced by the excessively rapid lowering of ambient pressure. This reduction enables inert gas dissolved in tissue to enter the gas phase causing the formation of gas bubbles in tissues and body fluids.

The clinical syndrome is known by a multitude of names including decompression sickness, DCI, decompression injury, caisson disease, bends, chokes, staggers, dysbarism and gas bubble injury. Although arterial gas embolism is usually associated with pulmonary barotraumas, decompression bubbles can also lead to embolization if there is shunting between the venous drainage and systemic circulation (e.g., intracardiac and intrapulmonary shunting). This blurs the boundaries between decompression sickness and arterial gas embolism, which is why the term DCI was created. Many languages do not differentiate between “sickness” and “illness” so that the terms “dysbarism”, “dysbaric illness”, or “dysbaric injury” have become equivalent terms for DCI. Clinical settings of DCI include diving, aviation, hyperbaric oxygen therapy (i.e., nurses, chamber assistants, and

medical personnel), caisson work and tunneling under pressure.

### PREDISPOSING FACTORS

Whereas the primary factor causing DCI is undisputedly the reduction in ambient pressure causing a rapid inert gas desaturation of tissues, several factors have been identified that can increase an individual's susceptibility to DCI.

### EXERCISE

Exercise during exposure to increased ambient pressure (during the bottom phase of the dive) appears to increase the incidence of DCI. The probable explanation is that increased perfusion during exercise leads to a corresponding increase in inert gas uptake, which must be subsequently eliminated during decompression.

Exercise during ascent has differential effects. During decompression stops, mild exercise appears to be helpful. On the other hand, increased activity during pressure change appears to increase the DCI risk. At least three mechanisms may help to explain this effect:

1. The formation of gas micronuclei. Rapidly flowing blood, especially in the area of vessel bifurcation, may create foci of relative negative pressure through a venturi effect. Molecules of gas from the surrounding supersaturated blood may then diffuse into these foci down a partial-pressure gradient. The resulting localized collections of small numbers of gas molecules called micronuclei are thought to act as a nidus for further bubble growth formation;
2. Increased local CO<sub>2</sub> production by exercising muscle may play a role since CO<sub>2</sub> is a highly diffusible gas that could contribute to the formation of gas micronuclei. Even small increases in F<sub>I</sub>CO<sub>2</sub> seem to increase the incidence of DCI. The mechanism of this effect is not clearly understood; and,
3. Increases in core body temperature due to increased muscle activity may reduce the solubility of gas in body tissues leading to bubble formation.

However, very recent research results are questioning some of these assumptions regarding exercise and diving, in particular that of exercise prior to diving. The latter appears to lower DCI incidence depending on when the exercise is performed. The explanation of these findings is still hypothetical, although nitrous oxide seems to be protective when it is produced by an increase in physical exercise 20 hours before diving (Wisloff and Brubakk, 2001; Wisloff et al., 2003; Dujic et al., 2004; Wisloff et al., 2004). There is an association between recent local musculoskeletal injuries and an increased incidence of DCI at or near the site of the injury. The mechanism responsible for this phenomenon is unclear. Changes in local perfusion and increased gas micronuclei formation in injured tissue are postulated mechanisms.

## COLD WATER

Diving in cold water tends to increase the incidence of DCI. Inert gas uptake is generally not affected because the exercising diver is usually warm and has increased tissue perfusion due to exercise (Martini et al., 1989; Gerriets et al., 2000). However, as the diver cools during the dive and at the safety or decompression stops, the diver's tissues experience a reduction in blood flow due to the cold and an increase in solubility tends to retain more gas. As the diver rewarms after the dive, the excess gas may be released as bubbles.

## AGE

Advancing age increases the incidence of DCI for reasons that are not yet clearly known but may be related to the reduction in pulmonary function or the reduction of tissue microvascularization.

## DEHYDRATION

Dehydration was reported as a factor that increases the risk of DCI during studies on aviators during World War II. The mechanism is again unclear. Changes in the surface tension in serum favoring bubble formation have been postulated. Anecdotal reports suggest that prior alcohol ingestion increases the incidence of DCI, possibly through this mechanism. Some recent papers add insight on the mechanism and advocate new approaches, considering hydration of the tissues more important than plasmatic volume or surface tension (Gempp et al., 2009).

## FATIGUE

As with alcohol, there is anecdotal evidence suggesting that significant fatigue preceding a dive increases the incidence of DCI. It is uncertain whether the fatigue is a subtle indicator of some unidentified biochemical factor or a non-specific warning of general hemodynamic factors.

## PATHOGENESIS OF DCI

### VASCULAR OBSTRUCTION

Vascular obstruction by bubbles or bubble-formed complexes may occur in the systemic or pulmonary circulation, a most important element in the pathogenesis of DCI. Vascular obstruction may occur as bubbles enter the circulation from supersaturated tissues and slow down venous return or due to embolization of vascular beds by bubbles formed elsewhere. Such disturbances may be clinically invisible in non-critical areas such as fatty tissue, but may be life-threatening in critical organs such as the central nervous system and heart.

Diffuse peripheral vascular obstruction and stasis with resultant tissue hypoxia or anoxia may lead to metabolic acidosis

and hypovolemia due to increased capillary permeability. Acidosis and hypovolemia may considerably impair cardiovascular function. Vascular obstruction of pulmonary capillaries, secondary to embolization of bubbles or bubble-formed complexes in venous blood, results in increased pulmonary vascular resistance, bronchiolar constriction and peribronchiolar oedema. These changes may lead to alterations in ventilation-perfusion ratios with resultant arterial hypoxemia, a condition called the chokes.

### BLOOD-BUBBLE INTERACTIONS: COAGULATION

Much attention has been devoted to the possible consequences of blood-bubble interaction. Bubbles are thought to be capable of activating Hageman Factor (Factor XII) with activation of coagulation, contributing to vascular obstruction. Bubbles constitute a foreign element in the blood and activate the complement and coagulation cascades. They may even cause "denaturation" of lipoproteins with the release of large quantities of lipid. Electron-micrographic studies in animals have shown vascular obstruction by a complex that appears to be composed of a gas bubble surrounded by a layer of lipid, to which platelets are agglutinated. This and similar observations have given rise to a variety of experimental work investigating *inter alia* the possible usefulness of anticoagulants in DCI. To date there is no firm experimental evidence to indicate that disseminated intravascular coagulation occurs in DCI, nor that routine anti-coagulation is therapeutically useful. Enhanced coagulation at local sites in tissue, however, may contribute to the pathogenesis of DCI. Coagulation Factor XIIa is, however, capable of triggering the reaction of the complement system. The sequence of reactions of this system produces factors that increase capillary permeability and factors that are chemotactic to leukocytes. Factor XIIa is also capable of activating the Kinin-Bradykinin System with liberation of bradykinin and histamine. Bradykinin may cause local pain. Both are capable of increasing capillary permeability.

### LOCAL VERSUS VASCULAR BUBBLES

There is little reason to doubt that the localized pain in a joint is the result of local gas formation. Webb et al. (1944a; 1944b) and Ferris and Engel (1951) showed that gas could be seen in periarticular and perivascular tissue spaces. They also demonstrated a correlation between the presence of gas and the occurrence of localized pain. The effectiveness of local pressure in relieving such pain, such as by inflating a blood-pressure cuff, adds legitimacy to the hypothesis. Importantly, DCI often occurs simultaneously in several sites and limb pain may distract physicians from more sinister neurological abnormalities (Figure 2).

While bubbles within tissues are clearly a cause for concern, significant numbers of venous gas emboli may be recorded without any clinical manifestations. In fact, precordial Doppler



detection of bubbles in the right ventricle or pulmonary arteries is not considered to have significant positive predictive value for DCI. However, high degrees of bubbling are associated with an increased risk of developing symptoms. On the other hand, Brubakk et al. (1984) have not observed DCI symptoms in individuals with no bubbles in the pulmonary artery and in the muscles of the thigh. Nevertheless, Nishi (1993) has reported that DCI is always accompanied by bubbles, if all monitoring sites are considered. Brubakk et al. (1991) have argued that Doppler detection, which is performed at intervals, may miss occasional bubbles and that the exceptional cases that have presented with DCI symptoms in the absence of Doppler bubble signals, may have fallen in this category (Table 1).

**BIOCHEMICAL EFFECT OF VASCULAR BUBBLES**

Gas bubbles affect cells and disrupt biochemical processes as has been demonstrated by *in vitro* studies. Thorsen et al. (1986) showed that gas bubbles are associated with the aggregation of thrombocytes. The degree of aggregation seems to be independent of the gas content of the bubble, but rather is related to its surface properties. Independently, Ward (1967) and Bergh et al. (1993) have also reported that gas bubbles activate complement *in vitro*, and that the response is unrelated to the content of the bubble. This also supports the hypothesis that the bioactive properties of bubbles are related to their surface characteristics. Ward (1967) and Bergh et al. (1993) also differentiated between “sensitive” and “non-sensitive” individuals, depending on the degree of complement activation in response to bubbles. The latter was also related to clinical manifestations of DCI. Individuals with low C5a levels before dives produced many gas bubbles and a single air dive seemed to reduce C5a levels suggesting that gas bubbles may activate both C5a and C5a receptors. This phenomenon has been confirmed by Stevens et al. (1993) in divers up to 14 hours after treatment for DCI.

Complement activation (Kilgore et al., 1994) triggers the activation of neutrophils and the formation of multiple

membrane-attack complexes (MAC) that eventually lead to cellular destruction. This also causes the leukocytes to adhere to the endothelium as they circulate over damaged endothelium. Such neutrophil activation has been demonstrated during decompression (Benestad et al., 1990).

C5a activation may be related to some of the skin changes seen in DCI: erythema, edema and infiltration of inflammatory cells (Swerlick et al., 1988). Another important effect of C5a is vasoconstriction and blood flow reduction (Martin et al., 1988). If circulation of blood is restricted during decompression, gas elimination is similarly reduced leading to possible critical supersaturation local bubble formation. Post ischemic hyperemia is not seen, possibly due to C5a activation, leukocyte adherence or even persisting vascular or perivascular bubbles (Bergh et al., 1993).

Vik et al. (1990) also observed that pulmonary changes in pigs following decompression were similar to those observed after complement activation. Lungs exposed to significant amounts of bubbles for approximately 100 minutes after decompression developed considerable leukocyte invasion. Complement activation was therefore considered to be the most important mechanism for acute lung injury (Ward, 1967; Ward et al., 1995).

Certain pulmonary function changes have been observed in divers. These include a reduction in carbon monoxide diffusion capacity and compliance (Thorsen et al., 1986). They are believed to support the growing evidence that inflammatory processes may follow decompression. In fact, the reduction in carbon monoxide diffusion capacity is rapid and is associated with the development of bubbles (Dujic et al., 1992; 1993).

Vik et al. (1990) consider the lungs to be a primary target organ for gas bubbles that are probably exposed to their effects in all decompressions. Indeed, the concept of the lungs serving as a “bubble trap” has been purported for many years, but we are only now looking at the impact that this function has on the “filter” itself. Although removal of bubbles by the lungs prevents more harmful distribution of bubbles to the arterial system, the process of doing so also has consequences for the lung. In addition, the filtering mechanism is not foolproof: if the gas load on

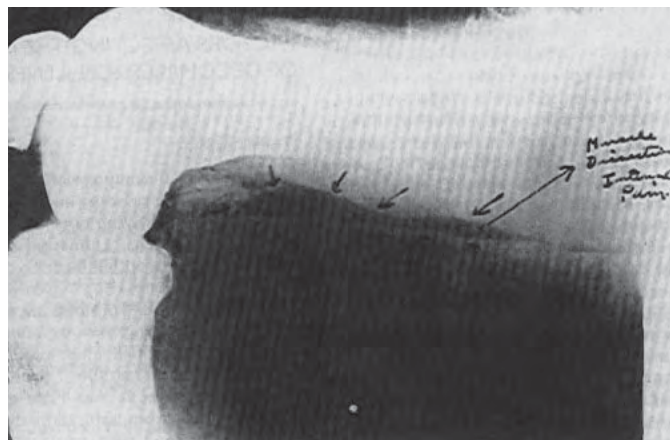

**FIGURE 2. Huge bubble found in an aviator in 1945 (Courtesy of R.D. Vann)**

**TABLE 1. Doppler grades (precordial) in different studies and DCI incidence (Modified after Brubakk et al., 1991).**

		Bubble grade	
		0	I-IV
Spencer and Johanson (1974)	N	110	64
	DCI inc (%)	1.0	22
Gotoh and Nashimoto (1977)	N	64	88
	DCI inc (%)	0	19
Marroni and Zannini (1981)	N	64	33
	DCI inc (%)	0	9
Nishi (1993)	N	1265	331
	DCI inc (%)	0.6	8
Brubakk et al. (1991)	N	68	40
	DCI inc (%)	1.5	7.5

the lungs is large, the filtering capabilities of the lungs will be exceeded and gas will enter the arterial circulation. An increase in pulmonary artery pressure of only about 30% is considered sufficient to cause arterialization of venous gas bubbles

Central nervous system alterations in DCI are believed to result from multiple mechanisms, including intra- and extra-vascular (tissue) bubbles (Francis et al., 1990). Vascular bubbles do not seem to be an important pathophysiological feature of spinal cord DCI. In a group of 10 amateur and 10 professional divers, five of whom had neurological DCI, no changes could be seen (Morild and Mork, 1994). However, the same authors reported changes in the endothelial layer of the brain ventricles in a group of divers (Morild and Mork, 1994; Mork et al., 1994).

Brubakk (1994) has entertained the possibility that this may not so much be evidence of intravascular gas bubbles in the brain as it may be indicative of an increase in venous pressure due to venous gas embolism of the lung interfering with venous return. Another possible explanation may be gas bubbles in the spinal fluid adhering to the lining of the ventricles and causing changes in the adjacent endothelium. Chrissanthou et al. (1977) has indeed shown that animals exposed to decompression show changes in the integrity of the blood-brain barrier and Broman et al. (1966) has also confirmed that even short contact between gas bubbles and endothelium (i.e., 1-2 mins) leads to such changes. Further studies in rabbits have shown that bubble-endothelium contact causes endothelial damage and progressive reduction of cerebral blood flow and function (Helps and Gorman, 1991).

## CLINICAL MANIFESTATIONS OF DCI

There is ongoing controversy about the best way to classify decompression disorders. Until 1990, these disorders were divided into DCS and AGE. DCS was then divided into two broad categories based on the severity of symptoms and the associated treatment regimens. However, today we recognize that certain forms of DCS may be the result of paradoxical or even frank AGE. Therefore, in the application of the traditional classification that follows, a modifier (DCS or DCI) is added to indicate where such pathophysiological ambiguity exists. Certain manifestations of decompression disorders are known never to be associated with arterial gas embolism and therefore can confidently be classified as decompression sickness. These include limb “bends” and lymphatic DCS.

Time of symptom onset in cases (all manifestations):

- 50% occur within 30 minutes of surfacing;
- 85% occur within 1 hour of surfacing;
- 95% occur within 3 hours of surfacing;
- 1% are delayed more than 12 hours; and,
- Some symptoms have been reported to begin as late as 24 hours and more after surfacing and even longer if there is subsequent altitude exposure (e.g., flying or mountaineering).

## 1. TYPE I

### PAIN ONLY - DCS

In recreational compressed-air diving the upper extremities are involved three times more often than the lower limbs. This is reversed for caisson workers and in commercial saturation diving. The pain can range from slight discomfort to a dull, deep, boring or even unbearable pain. It is usually unaffected by movement of the joint and there may be overlying edema and regional numbness.

### LYMPHATIC MANIFESTATIONS - DCS

The lymphatic manifestations of DCS presumably result from obstruction of lymphatics by bubbles. The manifestations can include pain and swelling of lymph nodes, with lymphedema of the tissues drained by the obstructed lymph nodes. New data are suggesting that normobaric oxygen may improve the flow of lymph and may assist in resolving inert gas bubbles contained within the lymphatic system or even to remove some tiny micronuclei that can behave like proteins and thus be captured by the lymphatics (Balestra et al., 2004). Oxygen preconditioning is a known factor to reduce venous gas emboli post diving, which may be explained by micronuclei elimination by the lymphatic system. Some recent results show a reduction in post-diving bubble grades after a known boosting of lymphatic captation by whole body vibration (Figure 3); more evidence is needed to assess the hypothesis

### CUTANEOUS MANIFESTATIONS - DCI

Itching is common following decompression from dry chamber dives where the skin is in direct contact with the chamber atmosphere rather than with water. This condition, sometimes called “diver’s lice”, is thought to be the result of gas dissolving directly into the skin and causing cutaneous irritation and the release of histamines with subsequent itchiness upon decompression. This is not a true or systemic form of DCI and does not require recompression. On the other hand, itchiness of the skin following a dive in which the skin was wet, is more likely to be true cutaneous DCI. Note that some in-water dives are performed in drysuits. Under these conditions the skin is in direct contact with compressed gas and “diver’s lice” may appear. However, this is usually accompanied by some degree of skin rash or visible skin change.

*Cutis marmorata* is a form of DCI which is thought to result from a complex interaction between bubbles, venous congestion and the immune system. It usually manifests itself as bluish-red “blotches”, frequently affecting the upper back and chest. Prominent linear purple markings are also frequently observed. These manifestations are a systemic form of DCI and suggest significant bubble formation that may also be affecting other areas of the body. As a result, prompt recompression is

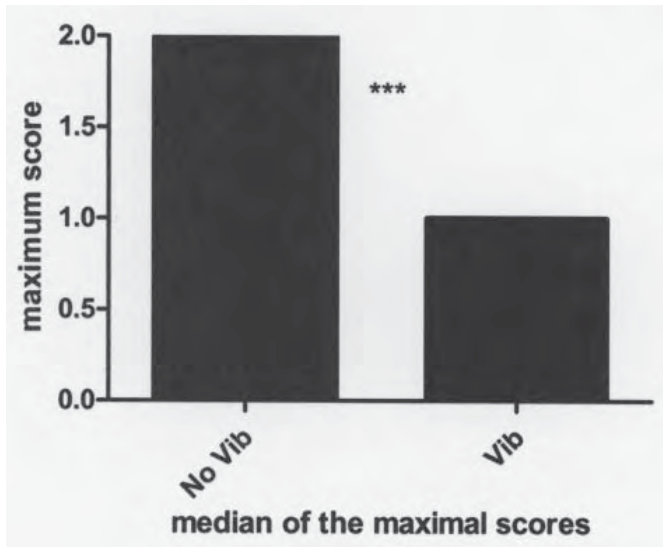

**FIGURE 3. Bubble score after 30 min. of whole-body vibration preconditioning 2 hours before the dive (25 m/25 min), n = 6.**

recommended, which usually leads to prompt resolution. This sign frequently heralds more serious forms of DCI and there is a statistical association with PFO even if the physiopathological link is currently not fully understood.

## 2. TYPE II DCI

### PULMONARY DCI

This is a syndrome usually presenting with a triad of symptoms:

- Substernal pain that usually burns and progressively increases. Initially, the pain may be noted only when coughing or with deep inspiration. Over time the pain may become constant;
- Cough that is initially intermittent and provoked by cigarette smoking (Behnke's sign). Paroxysms of coughing may become intractable; and,
- Progressive respiratory and dyspnea.

The manifestations of pulmonary DCI are believed to result from the combined effects of gas emboli in the pulmonary artery and obstruction of the vascular supply to the bronchial mucosa. Untreated pulmonary DCI may be fatal.

### NEUROLOGICAL DCI

Although the exact mechanisms of neurological DCI are not fully understood, they are believed to include embolism, autochthonous (i.e., spontaneous interstitial bubble formation), venous stasis and immunological phenomena. These mechanisms have different latencies and show different responses to

recompression. The neurological manifestations of DCI are therefore unpredictable, and any focal neurological symptom or sign may be a manifestation of its presence. Any neurological abnormality following a dive should always be assumed to be of central origin and treated accordingly.

### CEREBRAL DCI

Brain involvement in DCI appears to be especially common in high altitude aviators (i.e., flying in excess of 25,000 feet in unpressurized aircraft). In this group pulmonary venous gas embolism is also common and hypoxia and positive-pressure breathing may facilitate the transfer of bubbles or immunological products into the systemic circulation. Not surprisingly, a migraine-like headache accompanied by visual disturbances is a common manifestation of DCI. In divers, brain involvement usually presents more overtly with stroke-like symptoms. Collapse with unconsciousness is a rare presentation of DCS but common in AGE. If it does occur, it represents a very grave form of DCI.

### SPINAL CORD DCI

Paraplegia is a "classic" symptom of DCI in divers and clearly represents spinal cord involvement. Bladder paralysis with urinary retention and fecal incontinence frequently accompany such paraplegia. Recent years have seen a decline in both the proportion and absolute number of cases of serious paralysis in recreational divers (from 13.4 percent in 1987 to only 2.9 percent in 1997). Similarly, loss of consciousness has dropped from 7.4 percent to 3.9 percent during the same period. The incidence of loss of bladder function has dropped from 2.2 percent to 0.4 percent during this period (DAN Diving Accident Reports). Interestingly, the reduction in severe neurological symptoms has not been balanced by a proportional rise in pain-only or skin manifestations. Rather, there has been an unexpected appearance of mild, ambiguous neurological manifestations, such as paresthesia or tingling, which appear to respond well to oxygen administration and recompression.

### INNER EAR DCI

Audiovestibular DCI is a not an uncommon manifestation of CNS involvement. Usually both the cochlea and vestibular apparatus are involved and the presenting symptoms include tinnitus, deafness, vertigo, nausea, vomiting, and ataxia. Nystagmus may be present on physical examination. It is not clear whether the situation depends predominantly on bubble formation in the perilymph or is due to embolization of the auditory vestibular Inner ear DCI is a serious medical emergency and must be treated immediately to avoid permanent damage. Since the nutrient arteries of the inner ear are very small, rapid reduction in bubble diameter, with immediate 100% oxygen

administration and prompt recompression is essential.

**SHOCK - DCI**

Shock occasionally occurs in DCI and is usually associated with serious pulmonary manifestations indicating a hyperacute form of DCI. Multiple mechanisms may contribute to the pathogenesis of shock in DCI, including loss of vascular tone from spinal cord involvement, myocardial depression from hypoxemia and acidosis, pulmonary embolization, and hypovolemia due to increased capillary permeability resulting in loss of plasma water and hemoconcentration.

**BACK, ABDOMINAL, OR CHEST PAIN - DCI**

Pain in these areas, in contrast to limb pain, should be considered with great attention, as it frequently represents spinal cord involvement.

**EXTREME FATIGUE - DCI**

Fatigue, out of proportion from that normally occurring after a dive, has long been regarded as a serious manifestation of DCI. However, the biochemical and pathophysiological mechanism of this symptom are unknown.

**NEW DCI CLASSIFICATION**

The simple classification into Type I and Type II DCI implies that the different categories are well defined disease entities and that there is reasonable agreement about the classification (Brubakk, 1994; Brubakk and Eftedal, 2001).

However, two separate studies (Kemper et al., 1992; Smith et al., 1992), showed considerable uncertainty between experts using the classical classification system. For instance, cerebral

DCI could not in many cases be distinguished from arterial gas embolism or vestibular barotrauma. Other studies have shown that solely articular symptoms are rare, as they are usually accompanied by central nervous system symptoms (Vann et al., 1993; Freiburger et al., 2002). Extreme fatigue can be classified as a minor symptom, but could also be a sign of subclinical pulmonary embolism (Hallenbeck et al., 1975). Francis and Smith (1991) therefore suggested the currently widely adopted term “DCI”, to include the two previously used definitions of decompression sickness and arterial gas embolism. They also suggested avoidance of the classifications of Type I and Type II, while adopting instead a descriptive classification method according to the clinical manifestations (signs and/or symptoms) and their evolution in time. Using this classification scheme, a very high degree of concordance between different specialists was possible (Pollard et al., 1995). Francis and Smith (1991) proposed the following Classification Table for Decompression Injuries (Table 2), which is a useful guideline to correctly describe the various possible manifestations of a decompression disorder.

**DCI TREATMENT**

Air was nearly always used as the breathing gas and oxygen treatment was not really explored until Yarbrough and Behnke’s (1939) preliminary experiments. The early treatment theory was conceptually homeopathic in trying to decide how deep to take the injured diver. The original depth of the dive was used as a guide. For example, if decompression from a depth of 40 meters caused the symptoms, recompression to the same pressure should alleviate them. However, there were controversies as others thought that the situation of the diver should lead the decision and that the depth of relief should mark the initial treatment pressure. Still others argued that bubbles may be compressed but never disappear and should always be assumed

**TABLE 2. Classification of DCI symptoms.**

DEFINITION →		ABRUPT	EVOLVING	STATIC	
ONSET TIME →		IMMEDIATE	FIRST DAY	DAYS TO YEARS	
LOCALIZATION	SOMATIC	PAINFUL	Limb bend: Periarticular pain	Limb Bend: fluctuating pain after dive	Osteonecrosis
		PARESTHETIC	Tingling or numbness, may herald spinal DCI	Tingling or numbness, may be combined with pain	Recurrent or episodic after treatment; probably benign
		ASYMPTOMATIC	Skin changes or painless swelling	Skin changes or painless swelling	Asymptomatic osteonecrosis
	CEREBRAL	Loss of consciousness, hemiplegia, “air embolism”	Hemiparesis, delirium, brainstem signs, vertigo	Chronic neuropsychological changes	
	SPINAL	Girdle pain, loss of leg movement and bladder control	Waxing and waning weakness, bladder dysfunction, sensory levels	Chronic gait and bladder disturbances	
	CEREBRO-SPINAL	Unconscious diver with spinal findings	Combined spinal and cerebral signs, varying	Combined cerebral and spinal disability; spinal predominates	
SYSTEMIC	Chokes; acute systemic respiratory collapse	Fatigue, rare visceral DCI	Rare cases of ARDS and lung damage		



to be present. For these reasons the recommendation was to compress the patient to the depth of relief plus at least one atmosphere. The rationale was that if a bubble became extremely small, surface tension may cause it to collapse and disappear. It was generally realized that bubbles remaining in the tissues and circulation would continue to take up inert gas, as more nitrogen was absorbed during the recompression treatment.

In the 1924 edition of the U.S. Navy Diving Manual, a suggested recompression treatment procedure was first published, but more than 50% of the treatments were unsuccessful. The U.S. Navy published treatment tables again in 1942 without much improvement in the results.

Van Der Aue and Behnke (1945) experimented with better treatment methods that resulted in the publication of the U.S. Navy Air Recompression Tables I to IV that became the universal standard for the next 20 years. The outcome improvement over the previous approach was dramatic and over 90%. The principles of these tables were:

- Recompression to depth of relief plus at least one atmosphere. In practice, this meant going to a minimal depth of 30 meters;
- A maximum treatment depth of 50 meters. This depth was considered a good compromise between optimal recompression of any bubble while minimizing nitrogen narcosis risk and subsequent decompression;
- The use of a 12-hour stop at 9 meters before surfacing. Theoretically, this “overnight soak” was intended to allow all the tissues to saturate or desaturate to the 9-meter level, from where, according to Haldane, direct decompression to the surface would be safe; and,
- The use of intermittent oxygen breathing during the last hours of treatment.

These tables were at first considered very successful, with a failure rate on the initial recompression of only 6% in 1946. Despite their great length, from 6 hours 20 minutes for Table I to 38 hours 11 minutes for Table IV, they represented the only available therapeutical solution at the time. In 1963, however, the observed failure rate for serious symptoms cases was 46% on the initial recompression, and it became 47.1% in 1964. The reason for the failure of these tables, which had initially been so successful, was that more and more civilian recreational scuba diving cases were being treated. The civilians had often dived in total ignorance of decompression requirements, not to speak about the pre-treatment intervals, which were significantly longer than with the military divers.

Goodman and Workman (1965) started investigating the use of oxygen at moderate depths (2.8 ATA) for the treatment of DCI. Oxygen treatment had first been suggested by Behnke and Shaw (1937). At that time, however, the U.S. Navy Bureau of Medicine and Surgery was concerned that oxygen breathing in the chamber may be dangerous and not “sailor proof” and that the risks of oxygen toxicity and fire were too great (Kindwall,

1998). For this reason Behnke’s excellent results were ignored. End (1937) had also noted that treating DCI with compressed air was inefficient and had introduced oxygen breathing with excellent results in over 250 cases of DCI in compressed air workers (Kindwall, 1998). The first 52 cases treated with the “new” Goodman and Workman oxygen schemes showed that at least 30 minutes at the maximum depth of 18 meters and a total oxygen breathing treatment time of 90 minutes could be considered “adequate” treatment, allowing for a 3.6% failure rate. Treatment schedules were lengthened to two hours and four hours of oxygen breathing, with air breathing intervals of 5 to 15 minutes, to avoid oxygen toxicity. The two- and four-hour schemes were called U.S. Navy Table 5 and 6 respectively and were officially published in 1967. The most significant conceptual difference, with respect to the previous approach, was the importance given to the time of relief, instead of the depth of relief (Kindwall, 1998). Compression ceased to be limited to the scope of reducing the bubbles until they could disappear and then decompressing the diver according to a safe profile.

The concept of a real “therapeutical” treatment scheme was introduced where compression is just the vehicle for a therapeutical drug (oxygen) that exerts its treating action during the entire treatment schedule while also offering a double tool for the reduction of the offending gas bubbles, both by pressure and by a favorable diffusion gradient. Serial treatment of DCI had been advocated by many, until, at a meeting of the North Sea offshore diving groups at the Royal Society of Medicine in London in 1976, a consensus was reached that if the diver had residual symptoms after the initial treatment, daily hyperbaric oxygen treatment should be continued for at least two weeks or until the patient’s signs and symptoms had plateaued (Elliott et al., 1974a, b; Elliott and Moon, 1993; Eke et al., 2000).

Ancillary pharmacological treatment to recompression began to be emphasized in the late 60’s and 1970’s. In 1979, the Undersea Medical Society organized a workshop on the management of severe and complicated cases of DCI, where the importance of hydration, steroids, heparin, aspirin and other agents were discussed. Several modifications to treatment schemes were then introduced, such as the Comex Table 30, using mixed gas at a maximum pressure of four atmospheres, and the concept of saturation treatment. This was first introduced by Miller et al. (1978) with saturation treatment to start at four atmospheres while the patient breathed oxygen at 0.35 to 0.5 bar.

Currently, many different treatment protocols are in use, while the U.S. Navy Table 6 probably enjoys the most universal use. Available evidence indicates that this table is adequate in the majority of cases where treatment is initiated immediately (DAN Diving Accident Reports). Unfortunately there is often considerable delay in initiating treatment, and many of the secondary effects of the bubbles on blood and tissues become important. Kelleher et al. (1996) has shown that initial treatment is effective in only about 66% of the cases. Leitch and Barnard (1982) and Leitch (1985) have demonstrated, however, that

none of the alternative proposed protocols, including saturation decompression, are superior to U.S. Navy Table 6

The severity of symptoms should not be the only variable considered. Heliox and trimix dives may differ from air dives due to the differences in partition coefficients of helium and nitrogen in the tissues (Brubakk et al., 1986). The use of different gas mixes, particularly heliox for the treatment of DCI, also for compressed air diving, is controversial. Some reports seem to indicate that helium is beneficial. Air bubbles in tissue have been observed to disappear faster from the spinal cord if heliox is used instead of pure oxygen at 1 ATA, but the reverse is true at the pressure of 2.8 ATA (Hyldegaard and Madsen, 1989; Hyldegaard et al., 1991; Hyldegaard and Madsen, 1994). Brubakk (1994) believes, having shown an increased shunt in the lung and a reduction of gas elimination at increased oxygen tensions, that there is actually little benefit in using high oxygen tensions and that lower tensions may be more advantageous.

Over the years, many attempts have been made to improve the treatment of DCI with certain drugs, generally, with little success. Some of these possibilities have not been sufficiently studied and may deserve further attention, such as the use of fluorocarbons, which have a higher solubility for nitrogen than plasma. Lutz and Herrmann (1984) were able to substantially reduce the mortality of rats undergoing rapid decompression from 8 ATA when fluorocarbon was infused after decompression. A further point that deserves attention and study is complement activation and its effect on the leukocyte-endothelium adhesion, which appears to have a certain role in DCI, and for which drugs could have a role. In 1994, the European Committee for Hyperbaric Medicine organized its first European Consensus Conference, where DCI was one of the topics. In 1996 a second, more specific Consensus Conference was organized, the theme of which was "The Treatment of Decompression Accidents in Recreational Diving". Following both Conferences, and after extensive presentations by leading international experts, the two International Juries formulated recommendations that have since been adopted as the current standards for the definition and treatment of DCI in Europe.

## CONCLUSION

DCI is generally considered a rather benign condition, if adequate treatment is promptly started, with a success rate in excess of 80%. There is universal consensus that 100% oxygen should be administered immediately as the single most important first aid treatment of any DCI case related to surface-oriented diving and that rehydration is a valuable adjunct during diving first aid treatment in the field.

Hyperbaric treatment should be started within the shortest possible timeframe from surfacing or from the onset of the first DCI signs and symptoms. Hyperbaric treatment tables using 100% oxygen at environmental pressures not exceeding 2.8 bars, with various depth/time profiles, demonstrate very good results in more than 80% of the treated cases. There is

no significant evidence that any other therapeutical schemes provide better results and would therefore be preferable as the hyperbaric treatment of first choice for DCI related to surface-oriented diving.

It is accepted by many specialists that the use of high pressure (generally 4 bars maximum) treatment tables using a gas mixture of 50% Helium and 50% Oxygen may prove highly effective and provide good results in the cases that do not quickly and satisfactorily respond to the standard low pressure hyperbaric oxygen treatment tables.

Although conclusive scientific evidence suggesting the use of any pharmacological treatment other than oxygen is missing, the administration of adjunctive fluid therapy is considered very important and generally recommended by diving-hyperbaric medicine specialists, whereas the role of other drugs, such as steroids and anticoagulants, although widely used without any apparent adverse effect, is still controversial.

The continuation of hyperbaric oxygen therapy, combined with a specific rehabilitation protocol in neurological cases when the initial DCI treatment tables are not totally successful, is considered important and there is growing scientific evidence that it can significantly contribute to eventually achieving a better functional recovery.

## LITERATURE CITED

- Balestra, C., P. Germonpre, T. Snoeck, M. Ezquer, A. Leduc, O. Leduc, F. Willeput, A. Marroni, R. Cali Corleo, and R.D. Vann. 2004. Normobaric oxygen can enhance protein captation by the lymphatic system in healthy humans. *Journal of Undersea and Hyperbaric Medicine* 31:59–62.
- Behnke, A.R., and A. Shaw. 1937. The use of oxygen in the treatment of compressed-air illness. *United States Naval Medical Bulletin* 35:1–12.
- Benestad, H.B., I.B. Hersleth, H. Hardersen, and O.I. Molvaer. 1990. Functional capacity of neutrophil granulocytes in deep-sea divers. *Scandinavian Journal of Clinical Laboratory Investigation* 50:9–18.
- Bergh, K., A. Hjelde, O.J. Iversen, and A.O. Brubakk. 1993. Variability over time of complement activation induced by air bubbles in human and rabbit sera. *Journal of Applied Physiology* 74:1811–1815.
- Bert, P., M.A. Hitchcock, and F.A. Hitchcock. 1943. *Barometric pressure: researches in experimental physiology (1878)*. College Book Co., Columbus, Ohio.
- Boyle, R. 1670. New pneumatical experiments about respiration. *Philosophical Transactions* 5:2011–2058.
- Broman, T., P.L. Branemark, B. Johansson, and O. Steinwall. 1966. Intravital and postmortem studies on air embolism damage of the blood-brain barrier tested with trypan blue. *Acta Neurologica Scandinavica* 42:146–152.
- Brubakk, A.O. 1994. Decompression illness. What we do know, what we don't know. In *First European Consensus Conference on Hyperbaric Medicine, ECHM*, Wattel, F. and D. Mathieu, eds. Université de Lille, CRAM.
- Brubakk, A.O., and O. Eftedal. 2001. Comparison of three different ultrasonic methods for quantification of intravascular gas bubbles. *Journal of Undersea and Hyperbaric Medicine* 28:131–136.
- Brubakk, A.O., J. Davies, and S. Daniels. 1984. Monitoring of saturation decompression by combined use of ultrasonic scanning and Doppler techniques. Annual Scientific Meeting Abstracts of the Undersea and Hyperbaric Medical Society, May 29–June 4, 1984, San Antonio, Texas.

- Brubakk, A.O., R. Peterson, A. Grip, B. Holand, J. Onarheim, K. Segadal, T.D. Kunkle, and S. Tonjum. 1986. Gas bubbles in the circulation of divers after ascending excursions from 300 to 250 msw. *Journal of Applied Physiology* 60:45–51.
- Brubakk, A.O., H. Torp, and B.A. Angelsen. 1991. Noninvasive evaluation of flow changes and gas bubbles in the circulation by combined use of color-flow-imaging and computer postprocessing. *Acta Astronautica* 23:311–319.
- Dujic, Z., D. Duplancic, I. Marinovic-Terzic, D. Bakovic, V. Ivancev, Z. Valic, D. Eterovic, N.M. Petri, U. Wisloff, and A.O. Brubakk. 2004. Aerobic exercise before diving reduces venous gas bubble formation in humans. *Journal of Physiology* 555:637–642.
- Dujic, Z., D. Eterovic, P. Denoble, G. Krstacic, and J. Tocilj. 1992. Lung diffusing capacity in a hyperbaric environment: assessment by a rebreathing technique. *British Journal of Industrial Medicine* 49:254–259.
- Dujic, Z., D. Eterovic, P. Denoble, G. Krstacic, J. Tocilj, and S. Gosovic. 1993. Effect of a single air dive on pulmonary diffusing capacity in professional divers. *Journal of Applied Physiology* 74:55–61.
- Eke, A., P. Herman, J.B. Bassingthwaight, G.M. Raymond, D.B. Percival, M. Cannon, I. Balla, and C. Ikrenyi. 2000. Physiological time series: distinguishing fractal noises from motions. *Pflügers Archiv: European Journal of Physiology* 439:403–415.
- Elliott, D.H., J.M. Hallenbeck, and A.A. Bove. 1974a. Acute decompression sickness. *Lancet* 2:1193–1199.
- . 1974b. Venous infarction of the spinal cord in decompression sickness. *Journal of the Royal Naval Medical Service* 60:66–71.
- Elliott, D.H., and R.E. Moon. 1993. Manifestation of the decompression disorders. In *The Physiology and Medicine of Diving*, Bennett, P.B. and D.H. Elliott, eds. pp. 481–505. Saunders Company Ltd., London.
- End, E. 1937. Rapid decompression following inhalation of Helium-Oxygen mixtures under pressure. *American Journal of Physiology* 120:712–718.
- Ferris, E., and G. Engel. 1951. The clinical nature of high altitude decompression sickness. In: *Decompression Sickness*, Fulton, J., ed.. Saunders, London.
- Francis, T.J.R., J.L. Griffin, L.D. Homer, G.H. Pezeshkpour, A.J. Dutka, and E.T. Flynn. 1990. Bubble-induced dysfunction in acute spinal cord decompression sickness. *Journal of Applied Physiology* 68:1368–1375.
- Francis, T.J.R., and D.J. Smith, eds. 1991. *Describing decompression illness*. 42nd Undersea and Hyperbaric Medical Society Workshop. UHMS Publication Number 79(DECO) 5-15-91. Bethesda: Undersea and Hyperbaric Medical Society;
- Freiberger, J.J., P.J. Denoble, C.F. Pieper, D.M. Ugucioni, N.W. Pollock, and R.D. Vann. 2002. The relative risk of decompression sickness during and after air travel following diving. *Aviation, Space, and Environmental Medicine* 73:980–984.
- Gempp, E., J.E. Blatteau, J.M. Pontier, C. Balestra, and P. Louge. 2009. Preventive Effect Of Pre-Dive Hydration On Bubble Formation In Divers. *British Journal of Sports Medicine* 43:224–228.
- Gerriets, T., K. Tetzlaff, T. Liceni, C. Schafer, B. Rosengarten, G. Kopske, C. Algermissen, N. Struck, and M. Kaps. 2000. Arteriovenous bubbles following cold water sport dives: Relation to right-to-left shunting. *Neurology* 55:1741–1743.
- Goodman, M.W., and R.D. Workman. 1965. Minimal Recompression, Oxygen Breathing Approach to Treatment of Decompression Sickness in Divers and Aviators. U.S. Navy Experimental Diving Unit, NEDU Report 5-65, Washington, D.C. 49 p.
- Gotoh, Y., and I. Nashimoto. 1977. [Decompression bubbles in caisson workers (author's transl)]. *Nippon Eiseigaku Zasshi* 32:529–533.
- Hallenbeck, J.M., A.A. Bove, and D.H. Elliott. 1975. Mechanisms underlying spinal cord damage in decompression sickness. *Journal of Neurology* 25:308–316.
- Helps, S.C., and D.F. Gorman. 1991. Air embolism of the brain in rabbits pretreated with mechlorethamine. *Stroke* 22:351–354.
- Hyldegaard, O., and J. Madsen. 1989. Influence of heliox, oxygen, and N<sub>2</sub>O-O<sub>2</sub> breathing on N<sub>2</sub> bubbles in adipose tissue. *Undersea Biomedical Research* 16:185–193.
- . 1994. Effect of air, heliox, and oxygen breathing on air bubbles in aqueous tissues in the rat. *Journal of Undersea and Hyperbaric Medicine* 21:413–424.
- Hyldegaard, O., M. Moller, and J. Madsen. 1991. Effect of He-O<sub>2</sub>, O<sub>2</sub>, and N<sub>2</sub>O-O<sub>2</sub> breathing on injected bubbles in spinal white matter. *Undersea Biomedical Research* 18:361–371.
- Kelemen, G. 1983. Temporal bone findings in cases of salt water drowning. *Annals of Otolaryngology, Rhinology, and Laryngology* 92:134–136.
- Kelleher, P.C., R.J. Pethybridge, and T.J.R. Francis. 1996. Outcome of neurological decompression illness: development of a manifestation-based model. *Aviation, Space, and Environmental Medicine* 67:654–658.
- Kemper, G.B., B.J. Stegman, and A.A. Pilmanis. 1992. Inconsistent classification and treatment of Type I / Type II decompression sickness. *Aviation, Space, and Environmental Medicine* 63(5): 386–410.
- Kilgore, K.S., G.S. Friedrichs, J.W. Homeister, and B.R. Lucchesi. 1994. The complement system in myocardial ischaemia/reperfusion injury. *Cardiovascular Research* 28:437–444.
- Kindwall, E.P. 1998. Compressed air work. In *The Physiology and Medicine of Diving*, Bennett, P.B., and D.S. Elliott, eds. pp. 1–18. W B Saunders Company Ltd., London.
- Kumar, K.V., J.M. Waligora, and D.S. Calkins. 1990. Threshold altitude resulting in decompression sickness. *Aviation, Space, and Environmental Medicine* 61:685–689.
- Leitch, D.R. 1985. Complications of saturation diving. *Journal of the Royal Society of Medicine* 78:634–637.
- Leitch, D.R., and E.E. Barnard. 1982. Observations on no-stop and repetitive air and oxynitrogen diving. *Undersea Biomedical Research* 9:113–129.
- Lutz, J., and G. Herrmann. 1984. Perfluorochemicals as a treatment of decompression sickness in rats. *Pflügers Archiv: European Journal of Physiology* 401:174–177.
- Marroni, A., R. Cali-Corleo, C. Balestra, P. Longobardi, P. Germonpre, E. Voelml, M. Pieri, and R. Pepoli. 2001. The Speed of Ascent Dilemma: “Instant Speed of Ascent” or “Time to Surface” - Which one really matters? In *27th Annual Meeting of The European Underwater and Baromedical Society on Diving and Hyperbaric Medicine*, Van Laak, U., ed. pp. 74–78. Gesellschaft für Tauch und Überdruckmedizin, Frankfurt, Hamburg, Germany.
- Marroni, A., and D. Zannini. 1981. Effects of variations in the ascending speed on the production of circulating gas bubbles after compressed-air diving. *Minerva Medica* 72:3567–3572.
- Martin, S.E., D.E. Chenoweth, R.L. Engler, D.M. Roth, and J.C. Longhurst. 1988. C5a decreases regional coronary blood flow and myocardial function in pigs: implications for a granulocyte mechanism. *Circulation Research* 63:483–491.
- Martini, S., A.O. Brubakk, and C. Bech. 1989. Effect of high pressure on metabolic response to cold in rats. *Acta Physiologica Scandinavica* 135:359–366.
- Miller, J.N., L. Fagraeus, P.B. Bennett, D.H. Elliott, T.G. Shields, and J. Grimstad. 1978. Nitrogen-oxygen saturation therapy in serious cases of compressed-air decompression sickness. *Lancet* 2:169–171.
- Moir, E.W. 1896. Tunneling by compressed air. *Journal of the Society of Arts* 44:567.
- Morild, I., and S.J. Mork. 1994. A neuropathologic study of the ependymoventricular surface in diver brains. *Journal of Undersea and Hyperbaric Medicine* 21:43–51.
- Mork, S.J., I. Morild, A.O. Brubakk, S. Eidsvik, and H. Nyland. 1994. A histopathologic and immunocytochemical study of the spinal cord in amateur and professional divers. *Journal of Undersea and Hyperbaric Medicine* 21:391–402.
- Nishi, R. 1993. Doppler and ultrasonic bubble detection. In *The Physiology and Medicine of Diving*, Bennett, P.B., and D.H. Elliott, eds. pp. 433–453. W.B. Saunders, London, UK.
- Pol, M., and M. Wattelle. 1854. Mémoire sur les effets de la compression de l'air appliquée au creusement des puits à Houille. *Annales d'Hygiène Publique et de Médecine Légale* Second series, 241.
- Pollard, G.W., P.L. Marsh, C.E. Fife, L.R. Smith, and R.D. Vann. 1995. Ascent rate, post-dive exercise, and decompression sickness in the rat. *Journal of Undersea and Hyperbaric Medicine* 22:367–376.

- Shinoda, S., Y. Hasegawa, S. Kawasaki, N. Tagawa, and H. Iwata. 1997. Magnetic resonance imaging of osteonecrosis in divers: comparison with plain radiographs. *Skeletal Radiology* 26:354–359.
- Smith, D.J., T.J.R. Francis, R.J. Tehybridge, J.M. Wright, and J.J. Sykes. 1992. Concordance: A problem with the current classification of diving disorders. *Undersea and Biomedical Research* 19 (suppl.), 40.
- Spencer, M.P., and D.C. Johanson. 1974. Investigation of new principles for human decompression schedules using the Doppler ultrasonic blood bubble detector. Institute for Environmental Medicine and Physiology, Seattle, Washington, USA.
- Stevens, D.M., S.L. Gartner, R.R. Pearson, E.T. Flynn, R.B. Mink, D.H. Robinson, and A.J. Dutka. 1993. Complement activation during saturation diving. *Journal of Undersea and Hyperbaric Medicine* 20:279–288.
- Swerlick, R.A., K.B. Yancey, and T.J. Lawley. 1988. A direct *in vivo* comparison of the inflammatory properties of human C5a and C5a des Arg in human skin. *Journal of Immunology* 140:2376–2381.
- Thorsen, E., A.O. Brubakk, T. Ovstedal, M. Farstad, and H. Holmsen. 1986. A method for production of N<sub>2</sub> microbubbles in platelet-rich plasma in an aggregometer-like apparatus, and effect on the platelet density *in vitro*. *Undersea Biomedical Research* 13:271–288.
- Triger, M.. 1845. Letter to Monsieur Arago. In: *Comptes rendus De l'Académie des Sciences*, pp. 445–449. Paris.
- Van Der Aue, O.E., W.A. White, R. Hayter, F.S. Brinton, R.J. Kellar, and A.R. Behnke. 1945. Physiological factors underlying the prevention and treatment of decompression sickness. U.S. Navy Experimental Diving Unit, NEDU Report 4–45, Washington, D.C.
- Vann, R.D., P. Denoble, M.N. Emmerman, and K.S. Corson. 1993. Flying after diving and decompression sickness. *Aviation, Space, and Environmental Medicine* 64:801–807.
- Vik, A., A.O. Brubakk, T.R. Hennessy, B.M. Jessen, M. Ekker, and S.A. Slordahl. 1990. Venous air embolism in swine: transport of gas bubbles through the pulmonary circulation. *Journal of Applied Physiology* 69:237–244.
- Ward, C.L. 1967. Scuba diving - biologic and physical aspects. *Aeromedical Reviews* 1:1–25.
- Ward, R., D. Jones, and E.F. Haponik. 1995. Paradoxical embolism. An under recognized problem. *Chest* 108:549–558.
- Webb, J., G. Engel, and J. Romano. 1944a. The mechanism of pain in aviators: "Bends". *Journal of Clinical Investigation* 23:934–935.
- Webb, J., E. Ferris, and G. Engel. 1944b. Radiographic studies of the knee during bends, pp. 305. U.S. NRC Committee on Aviation Medicine report, Washington, D.C.
- Wilmschurst, P., and K. Ross. 1998. Dysbaric osteonecrosis of the shoulder in a sport scuba diver. *British Journal of Sports Medicine* 32:344–345.
- Wisloff, U., and A.O. Brubakk. 2001. Aerobic endurance training reduces bubble formation and increases survival in rats exposed to hyperbaric pressure. *Journal of Physiology* 537:607–611.
- Wisloff, U., R.S. Richardson, and A.O. Brubakk. 2003. NOS inhibition increases bubble formation and reduces survival in sedentary but not exercised rats. *Journal of Physiology* 546:577–582.
- . 2004. Exercise and nitric oxide prevent bubble formation: a novel approach to the prevention of decompression sickness? *Journal of Physiology* 555:825–829.
- Yarbrough, O.D., and A.R. Behnke. 1939. The treatment of compressed air illness utilising oxygen. *Journal of Industrial Hygiene and Toxicology* 21:213–218.

# Haldane Still Rules!

*David J. Doolette*

---

**ABSTRACT.** To minimize the risk of decompression sickness, dives are conducted according to depth/time/breathing gas decompression schedules derived from algorithms that minimize bubble formation through controlling tissue gas supersaturation. John Scott Haldane developed the first practical decompression algorithm in 1908. Haldane's decompression model featured multiple parallel perfusion-limited compartments, limits of tolerable supersaturation using a 2:1 ratio, and a maximized tissue-alveolar gas partial pressure gradient for inert gas washout. More recent bubble models may skew decompression time towards deeper stops than gas content models. Gas content models that are direct descendants of the original Haldane model remain the most prevalent approach to decompression.

## BACKGROUND

**D**ecompression sickness (DCS) is thought to arise from intracorporeal bubble formation during reduction in ambient pressure (decompression). During underwater compressed gas diving, alveolar inert gas partial pressures change as a result of the change in total pressure and blood and tissues take up inert gas in accord with Henry's law. During subsequent ascent to sea level, the ambient pressure may drop below the sum of the partial pressures of all gases dissolved in tissue. This state, referred to as supersaturation, is a necessary condition for bubbles to form and grow from the excess dissolved gas. Sufficient bubble formation may result in DCS from as yet unidentified pathophysiological mechanisms. To minimize the risk of DCS, dives are conducted according to depth/time/breathing gas decompression schedules derived from decompression algorithms that implicitly (gas content models) or explicitly (bubble models) minimize bubble formation through controlling tissue gas supersaturation. Haldane developed the first practical decompression algorithm (Boycott et al., 1908) and a century later this gas content approach remains the most prevalent form of decompression algorithm. The key features of the Haldane decompression approach are illustrated in Figures 1 and 2.

## LANDSCAPE AT THE TIME OF HALDANE

DCS in humans was first described by Triger (1845), and by the time of Haldane the hypothesis was well established that DCS resulted from bubble formation from excess dissolved nitrogen taken up while breathing compressed air pressure (see Bert, 1878, for historical summary and relevant experiments). It was also known that the risk of DCS could be minimized by limiting time under pressure or using a slow decompression. Zuntz and von Schrotter, applying the Fick principle, had developed an expression for nitrogen uptake and washout, in which body – alveolar nitrogen partial pressure



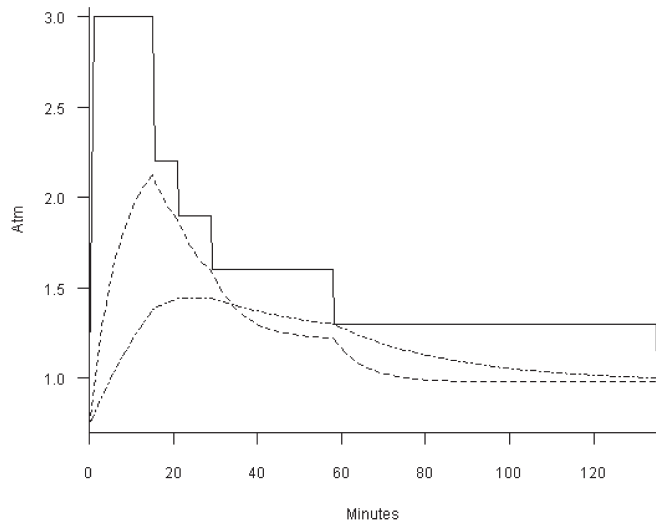

**FIGURE 1.** Ambient pressure (solid line) versus time and the corresponding total gas pressures ( $\Sigma P_{tis inert}$ ) in two compartments (half-times of 5 and 20 minutes) for an air breathing dive. Classical decompression is scheduled to keep dissolved gas pressure in  $k$  modeled compartments less than or equal to a maximum permissible value,  $P_{tis,maxk} \leq a_k P_{amb} + b_k$ . For simplicity, the above figure shows only two compartments and sets  $a = 1$  and  $b = 0$ , so that the ‘safe ascent depth’,  $P_{amb,min} = \max((P_{risk} - b)/a)$ , is equal to  $\max(P_{risk})$ . In Haldane and colleagues algorithm, compartment half times were 5, 10, 20, 40, and 75. The Haldane “2:1 tissue ratio” arises from treating air as an inert gas and setting the safe ascent depth as  $P_{amb} = \max(P_{risk}/2)$ . By convention, decompression stops are taken at increments of 10 fsw (0.3 atm abs) deeper than sea level.

difference declines exponentially with approximately an 8-minute half-time (see Kety, 1951, for review). On this basis, von Schrotter and colleagues hypothesized that linear decompression at 20 minutes per atmosphere would allow sufficient washout of nitrogen to avoid DCS.

### THREE KEY FEATURES OF HALDANE’S MODEL

Haldane’s decompression model provided the following three key advanced in decompression theory:

#### 1. MULTIPLE PARALLEL COMPARTMENTS

Haldane modeled the uptake and washout of nitrogen in the body using a collection of parallel perfusion-limited compartments in which gas uptake and washout are symmetrical and each compartment is characterized by a different half-time. Differing half-times were based on the premise that different body tissues receive variable blood flows and have differential solubilities for nitrogen. His slowest half time was based on observations and experiments indicating that the risk of DCS increases with exposure duration for many hours, and his fastest half-time was in accord with experimental measurement of the

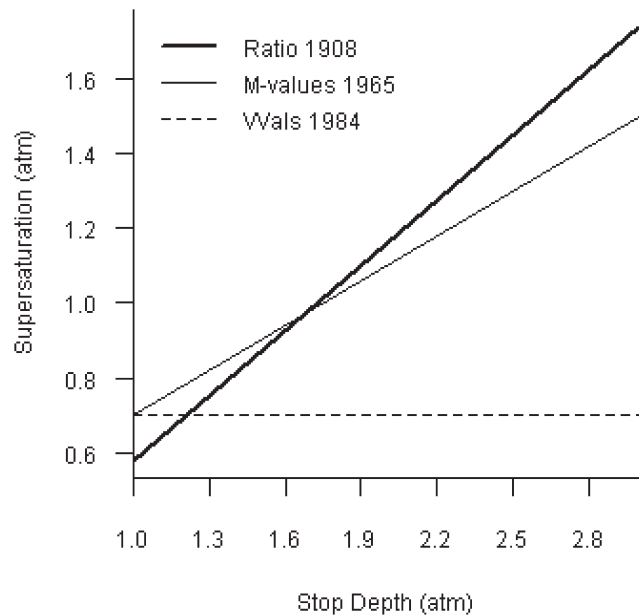

**FIGURE 2.** Tolerable supersaturation. Although decompression algorithms use a maximum permissible tissue tension ( $P_{tis,max}$ ) to control ascent to each decompression stop, it is informative to examine the tolerable supersaturation ( $P_{tis,max} - P_{amb,stop}$ ). For a 40 minute half-time compartment, the thick line shows the relationship for the Haldane 2:1 tissue ratio; the thin, solid line shows the relationship for the Workman m-values (Workman, 1965); and the dashed line shows the relationship for the Thalmann VVal-18 m-values (Thalmann, 1984). Note that gas content model development during the 20th century resulted in progressively less tolerable supersaturation at depth, which results in deeper and longer decompression stops.

rate of saturation of urine with nitrogen (Hill and Greenwood, 1907).

#### 2. TOLERABLE SUPERSATURATION

Observations of DCS in caisson workers and Haldane and colleagues’ experimental work with goats indicated that a compressed air exposure of greater than 2 atm abs was required to provoke DCS upon return to 1 atm abs – suggesting that some degree of supersaturation can be tolerated without developing DCS. Without then available evidence to the contrary, Haldane hypothesized that bubbles did not form unless this tolerable supersaturation was exceeded. Contradicting his own premise, he further hypothesized that a decompression from, for instance, 6 to 3 atm abs would be equally as safe as decompression from 2 to 1 atm abs because the different amounts of supersaturation represented the same potential volume of gas bubbles according to Boyle’s law. Haldane used a “2:1 tissue ratio” (ratio of maximum allowed tissue-dissolved gas pressure to ambient pressure) to define safe ascent depths. This “2:1 tissue ratio” allowed a greater tolerable supersaturation at depth (Fig. 2). Haldane’s

experimental evidence supporting a greater tolerable supersaturation at depth was slim, consisting primarily of 10 goats that were decompressed on one occasion from 4.5 to 1 atm abs with 8/10 DCS and on another occasion decompressed from 6.1 to 2.6 atm abs with no DCS. However, in the later experiments goats were only held at 2.6 atm abs for one hour and 3/10 suffered DCS following subsequent decompression to 1 atm abs. Development of gas-content models in conjunction with mantrials subsequent to Haldane's work has tended to limit the extent to which the tolerable supersaturation increases with depth (Fig. 2) which results in deeper and longer decompression stops, but all define a safe ascent depth based on some degree of tolerable supersaturation.

### 3. MAXIMIZE GRADIENT FOR WASHOUT — THE CONTENTIOUS ISSUE

The classical shape of decompression schedules - initial rapid decompression that slows as the surface is approached - follows from the previous two features of Haldane's model. Under such models, the most efficient decompression is to effect the maximum tolerable decompression to maximize the tissue - alveolar gas partial pressure gradient for inert gas washout. The decompression is slowed as successively slower half-time compartments govern the safe ascent depth (Fig. 1). This shape of decompression was shown to be more efficient than linear decompression by Haldane and colleagues.

### BUBBLE MODELS

Bubble decompression models (models that explicitly limit the formation and growth of bubbles) have been developed since the time of Haldane (e.g., Hills, 1966; Yount and Hoffman, 1986; Gernhardt, 1991; Gerth and Vann, 1997). Bubble models may prescribe decompression schedules that depart substantially from the classical shape described above. Since the publication of Haldane and colleagues' classical work, it has been firmly established that bubbles often form even during safe decompression. A large decompression and accompanying supersaturation increases the probability/rate of bubble nucleation and bubble growth. Balancing these effects against maximizing the tissue - alveolar gas partial pressure gradient for inert gas washout, bubble models may prescribe deeper initial decompression stops or skew decompression time towards deeper stops than gas content models. Only recently (Gerth et al., 2009) has such deep skew of decompression time been directly compared to classically shaped decompression, and the latter found to be more efficient (Fig. 3).

This is not to say that bubble models are without advantage. Bubble models provide better descriptions of certain aspects of decompression than gas content models. For instance, because the peak supersaturation occurs immediately following ascent but peak bubble volume can be delayed, bubble models

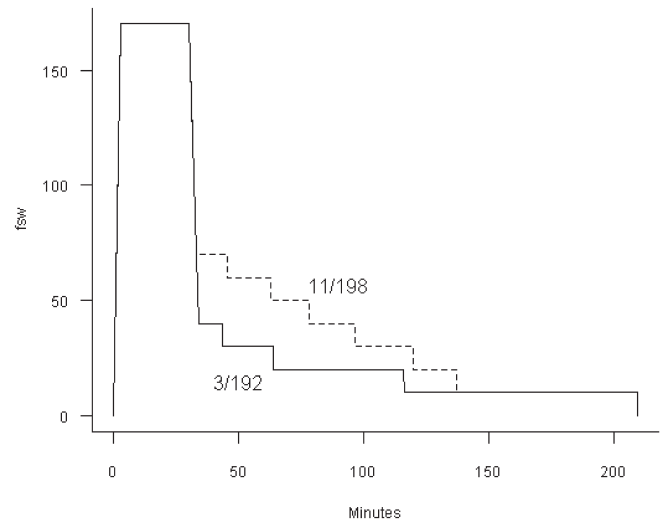

**FIGURE 3. A recent manned evaluation of two decompression schedules that differed only in the depth distribution of decompression stop time (Gerth *et al.*, 2009). A gas content model decompression schedule (solid line) was compared to a schedule of equal length predicted by a bubble model (dashed line). Number of DCS / number of dives are indicated next to the schedules. The greater incidence of DCS was observed on the bubble model schedule which had deeper initial decompression stops. The deeper initial decompression stops must result in less initial bubble formation, but to explain greater incidence of DCS, also in less efficient gas washout and subsequent bubble growth.**

can provide better description of time of symptom onset than gas content models (Gerth and Vann, 1997). Also, outcome of some unconventional dive profiles may be better predicted by bubble models. For instance, intermittent recompression during decompression reduces bubble formation (Mollerlokken et al., 2007) something that is predicted by bubble models (Gernhardt, 1991), but not gas content models.

### CONCLUSIONS

Despite some potential advantages of bubble models and some deficiencies in Haldane's original model, gas content models that are direct descendants of the original Haldane model remain the most prevalent approach to decompression. In addition, the general shape of decompression stop distribution promoted by Haldane is demonstrated to be the most efficient for decompression from typical dives. Haldane still rules!

### LITERATURE CITED

- Bert, P. 1878 *La Pression barométrique, recherches de physiologie expérimentale*. Paris: G. Masson, Éditeur. 1168 pp.  
 Boycott, A.E., G.C.C. Damant, and J.S. Haldane. 1908. The prevention of compressed-air illness. *Journal of Hygiene (Cambridge)* 8:342-443.  
 Gernhardt, M.L. 1991. Development and evaluation of a decompression stress index based on tissue bubble dynamics. Ph.D. Dissertation, University of

- Pennsylvania. 328 pp.
- Gerth, W.A., and R.D. Vann. 1997. Probabilistic gas and bubble dynamics models of decompression sickness occurrence in air and N<sub>2</sub>-O<sub>2</sub> diving. *Journal of Undersea and Hyperbaric Medicine* 24:275–292.
- Gerth, W.A., D.J. Doolette, and K.A. Gault. 2009. Deep stops and their efficacy in decompression: U.S. Navy research. In Bennett, P.B., B.R. Wienke, and S.J. Mitchell, eds. *Decompression and the deep stop*, 24–25 June 2008. Durham: Undersea and Hyperbaric Medical Society. p. 165–85.
- Hill, L. and M. Greenwood. 1907. The influence of increased barometric pressure on man.-II. *Proceedings of the Royal Society of London B - Biological Sciences* 79:21–27.
- Hills, B.A. 1966. A thermodynamic and kinetic approach to decompression sickness. Doctoral Thesis, the University of Adelaide, Australia. 370 pp.
- Kety, S.S. 1951. The theory and applications of the exchange of inert gas at the lungs and tissues. *Pharmacological Reviews* 3:1–40.
- Møllerløkken, A., C. Gutvik, V.J. Berge, A. Jorgensen, A. Loset, and A.O. Brubakk. 2007. Recompression during decompression and effects on bubble formation in the pig. *Aviation, Space, and Environmental Medicine* 78:557–560.
- Thalmann, E.D. 1984. Phase II testing of decompression algorithms for use in the U.S. Navy underwater decompression computer. NEDU Report No.1-84. Washington, DC: Navy Experimental Diving Unit. 134 pp.
- Workman, R.D. 1965. Calculation of decompression schedules for nitrogen-oxygen and helium-oxygen dives. NEDU Report No. 6-65. Washington, DC: Navy Experimental Diving Unit.
- Yount, D.E., and D.C. Hoffman. 1986. On the use of a bubble formation model to calculate diving tables. *Aviation, Space, and Environmental Medicine* 57:149–156.



# Biochemical Approach to Decompression

*Susan R. Kayar*

---

**ABSTRACT.** Haldane envisioned that decompression sickness (DCS) risk is eliminated by obeying rules for time at depth in order to manage inert gas fluxes. But New Millennium divers want more: longer dives, faster decompressions, shorter surface intervals between dives, and lower residual risk of DCS that resists management by time at depth. Can DCS risk be further reduced, or dive profiles safely stretched, by something provided in an oral capsule? If we knew the chain of biological events starting with bubbles and leading to DCS, then we might find a pharmacological approach to blocking that chain. While there is hope for someone identifying such an approach, we currently do not have one. Alternatively, we could place inside an oral capsule the enzymatic ability to remove some of the gas taken up by the body during the hyperbaric exposure. Biochemical decompression has been demonstrated in small and large animal models with H<sub>2</sub> as the diluent to O<sub>2</sub>, in a breathing mixture designed for ultra-deep (>350 m) diving. Hydrogen-metabolizing microbes (the archae *Methanobrevibacter smithii*) are placed in the large intestine where they create a chemical scrubber unit. The metabolism of *M. smithii* converts H<sub>2</sub> and CO<sub>2</sub> to methane and water. The release of one molecule of methane for every four molecules of H<sub>2</sub> consumed provides a non-invasive marker of the metabolic rate. By gas chromatographic sampling of the environment around the dive subject for methane, we have demonstrated that removing approximately 5-10% of the body burden of H<sub>2</sub> reduces the risk of DCS by approximately 50%. Nitrogen biochemical decompression would be far more useful but far more difficult to implement, both biologically and energetically. We will need a New Millennium Haldane to make the capsule that lowers DCS risk from air dives a reality, whatever it may contain.

## INTRODUCTION

Pills and capsules to solve health problems are ubiquitous. What about swallowing a capsule to reduce the risk of DCS? What indeed might we put into a capsule that would have this benefit? By now, it is generally agreed among DCS researchers that we have all been missing something critical in the sequence of events starting with gas supersaturation in blood or other tissues, progressing to bubbles, and culminating in manifestations of DCS. Haldane was of course correct that most of DCS risk can be eliminated by establishing and following rules for compression and decompression pressure and time sequences in order to manage inert gas loads and fluxes (Boycott et al., 1908). But there is a residual component of DCS risk that defies these time at depth rules (Weathersby et al., 1984), suggesting that there is more that we need to know than gas burdens alone. The same conclusion is drawn from the recognition that almost all excursions in barometric pressure lead to some degree of bubbling, but there is a poor correlation between bubbling and subsequent DCS incidence and manifestations (Eftedal et al., 2007), until the bubbling reaches extraordinary levels. Many lines of evidence suggest that there is a variable biological response to bubbles that may include a cascade of inflammatory activations (Little and Butler, 2008; Nyquist et al., 2007). It may thus be possible to reduce the risk of DCS by oral treatments

of anti-inflammatory medications. However, highly successful pharmaceuticals of this nature have yet to be identified (Little and Butler, 2008; Montcalm-Smith et al., 2007).

There is another potential approach to lowering the risk of DCS by means of swallowing a capsule. This approach, which we have called biochemical decompression (Kayar et al., 1998; Fahlman et al., 2001; Kayar and Fahlman, 2001; Kayar et al., 2001), involves placing in the capsule the enzymatic capacity, provided by live microbes, to remove some of the inert gas load in the body. The capsule travels to the large intestine where it releases the microbes. These microbes remove from their surrounding environment, and then from the blood passing through the walls of the intestines, molecules of gas that are inert to the diver but metabolites to the microbe. Removing a small but critical fraction of the inert gas load during the dive lowers the subsequent risk of DCS. The feasibility of biochemical decompression has been demonstrated in a rodent and a swine model, using ultra-deep diving gas mixtures containing H<sub>2</sub> as the diluent to O<sub>2</sub>. We present here a short description of the demonstration of H<sub>2</sub> biochemical decompression, and a discussion of its place in DCS research and the future of diving. Other pharmacological approaches may ultimately be more practical and far easier to attain in the quest for a capsule or pill against DCS. But the study of H<sub>2</sub> biochemical decompression, useful in its own right for ultra-deep H<sub>2</sub> dives, had important lessons to teach about DCS and inert gas loads, even if it did not lead to a bottle of capsules in a dive store or a Navy dive locker.

## MATERIALS AND METHODS

### MICROBES USED IN H<sub>2</sub> BIOCHEMICAL DECOMPRESSION

The microbes used to eliminate H<sub>2</sub> from inside the rats and pigs were the methanogenic archae, *Methanobrevibacter smithii*, strain PS. The *M. smithii* were obtained from the stock culture collection of the Wadsworth Center for Laboratories and Research, New York State Department of Health. Culture and handling of *M. smithii* are described in detail elsewhere (Kayar et al., 1998). The metabolism of *M. smithii* converts:

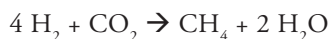

in which the H<sub>2</sub> breathed by the experimental animal combines with carbon dioxide released by the aerobic metabolism of the animal to form water and methane; this process generates energy for the microbes. The methane released by *M. smithii* becomes the tracer gas for the metabolic rate of the microbes, which can be detected non-invasively by sampling the atmosphere around the experimental animal by gas chromatography.

Although we envision that *M. smithii* would be provided to people via oral capsules, for expedience in these experiments with animals, cultures of *M. smithii* were surgically injected into their intestines as described below.

### EXPERIMENTS WITH RATS

These experiments have been described in detail elsewhere (Kayar et al., 1998). Male Sprague-Dawley rats (*Rattus norvegicus*, body mass range 215-324 g) were used for all experiments. The rats were housed before experiments in an accredited animal care facility with *ad libitum* access to food and water. All procedures were approved by an Animal Care and Use Committee and were conducted according to the principles presented in the *Guide for the Care and Use of Laboratory Animals* (National Research Council, 1996).

Two milliliters of the *M. smithii* cultures were injected directly into the upper end of the large intestine under sterile surgical conditions. A total of 63 rats received injections of *M. smithii*, 40 rats underwent the same surgical procedure but received 2-ml injections of 10% sodium bicarbonate in the intestine, and 60 rats served as untreated controls.

For each of the dive experiments to test for *M. smithii* activity, four or five rats were placed together in a clear box inside a large hyperbaric chamber (5.6 m<sup>3</sup> internal volume). A stream of chamber gas passed continuously through the animals' box and was sampled by a gas chromatograph every 12 min for He, H<sub>2</sub>, O<sub>2</sub>, and CH<sub>4</sub> content. The chamber was pressurized with helium to an absolute pressure of 11 atm for 1 h. (This initial pressurization with He, prior to introducing H<sub>2</sub>, is necessary to create a gas mix in the chamber that has the 0.2 atm PO<sub>2</sub> that is breathable to the animal, but below the explosivity limit of less than 5% O<sub>2</sub> in H<sub>2</sub>). The helium in the chamber was then replaced with H<sub>2</sub> at constant total pressure to a final concentration of 85 – 92% H<sub>2</sub>, while adding O<sub>2</sub> as needed to maintain 2-4% O<sub>2</sub>; this flushing procedure was completed in ~ 2 h. The chamber was further pressurized with H<sub>2</sub> to a total pressure of 23.7 atm (91-98% H<sub>2</sub>, 2% O<sub>2</sub>, balance He), and maintained at this pressure for 2.5 h. The chamber was then depressurized to 11 atm at 0.2 – 0.45 atm · min<sup>-1</sup>, which was intended to be slow enough to be unlikely to cause DCS in the rats (Lillo et al., 1997). After 45 min at 11 atm, the H<sub>2</sub> in the chamber was replaced with He at constant total pressure. To reduce the H<sub>2</sub> concentration to < 4% (to remain below the explosivity limit for H<sub>2</sub> in combination with air) typically required 2 – 2.5 h of He flushing. The chamber was then further depressurized at 0.1 – 0.25 atm · min<sup>-1</sup> until the chamber had returned to 1 atm. The animals were removed from the chamber, observed for signs of DCS (which were rare), and left in cages with food and water overnight for further observation after 12 h.

A second dive procedure was used to test for DCS risk in rats. In this procedure, we used some animals that appeared in normal health after 12 h in air following the dive to measure *M. smithii* activity (19 rats with *M. smithii* and 18 surgical controls), and also animals that were either treated with *M. smithii* (n = 20), surgical controls (n = 20), or untreated controls (n = 50) that had not previously been compressed. For this dive, a small chamber (140 l internal volume) was pressurized with He to 10 atm. The chamber was flushed with a mixture of 2%

O<sub>2</sub>, 98% H<sub>2</sub> until He was less than 10%. The chamber was further pressurized to 23.7 atm and a final gas composition of 2% O<sub>2</sub>, 94% H<sub>2</sub>, 4% He. The rats remained at this pressure for 20 min, which was sufficient to saturate them with H<sub>2</sub> (Lillo et al., 1997). The rats were then decompressed within 36–40 s to a pressure of 10.8 atm and observed for signs of DCS over the next 30 min. Throughout their stay in the chamber, the animals walked inside a slowly rotating drum mill of wire mesh; DCS was diagnosed as a change of gait or inability to walk inside the mill for at least 1 min, as agreed upon by two or three observers. At the end of the observation period, all animals were euthanized in the chamber by introducing 2 atm CO<sub>2</sub>.

### EXPERIMENTS WITH PIGS

Pigs (*Sus scrofa*, male Yorkshires, 19–22 kg body mass) were housed before experiments in an accredited animal care facility, had *ad libitum* access to water, and were fed once daily (laboratory animal chow, 2% of body weight). All procedures were approved by an Animal Care and Use Committee and conducted according to the principles presented in the *Guide for the Care and Use of Laboratory Animals* (National Research Council, 1996).

Experiments with pigs were described in detail elsewhere (Kayar et al., 2001). The treated pigs (n = 16) received injections of *M. smithii* in the caecum and upper end of the large intestine under sterile surgery. The volume of *M. smithii* culture injected in an animal varied with the volume and activity of microbes that were successfully cultured that week. This volume ranged from 12 to 116 ml, and represented an activity range from 200 – 2,200 μmol CH<sub>4</sub> · min<sup>-1</sup>. Surgical control animals (n = 10) underwent the same sterile surgical procedures as treated animals, but received injections into the intestine of sterile saline solution. Untreated control animals (n = 10) were also studied. All animals were trained to walk on a treadmill and acclimated to being in the dive chamber at 1 atm prior to dive experiments.

A single dive protocol was followed with pigs for measuring methane release rate and DCS incidence. For each dive, one pig was placed inside a large hyperbaric chamber (5.7 m<sup>3</sup> internal volume). The pig could stand, walk a distance of several body lengths, or recline at will, and could access containers of pellet food and water. A stream of gas passed continuously from the chamber to a gas chromatograph for automatic sampling every 12 min for He, H<sub>2</sub>, O<sub>2</sub> and CH<sub>4</sub> content. The chamber was pressurized with He to an absolute pressure of 11 atm, adding O<sub>2</sub> as necessary to maintain approximately 0.2 – 0.4 atm PO<sub>2</sub>. The chamber was then flushed with H<sub>2</sub> at constant total pressure to a concentration of 60–75% H<sub>2</sub>, 2 – 4% O<sub>2</sub>, balance He. The chamber was further pressurized with H<sub>2</sub> and O<sub>2</sub> to a final pressure of 24 atm absolute pressure (0.3 – 0.5 atm PO<sub>2</sub>), which was maintained for 3 h. The chamber was then depressurized at a rate of 0.9 atm·min<sup>-1</sup> to 11 atm, while observing the animal closely.

After arrival at 11 atm, the animal was made to stand and walk on a treadmill (which formed the floor of the chamber

on which the animal stood or reclined throughout the dive) at 5-min intervals, interspersed with 5-min rest intervals. The animal was examined for its ability to stand and walk with normal gait for up to 1 h or until clear signs of DCS were identified by at least three observers (inability to stand, difficulty maintaining normal posture, failure to right after falling, labored breathing). Animals were quickly euthanized in the chamber by asphyxiation with He as soon as DCS was diagnosed or the observation hour had passed without DCS. The chamber was further flushed with He near 1 atm to remove remaining H<sub>2</sub> before opening the chamber door.

## RESULTS

### EXPERIMENTS WITH RATS

The release rate of methane from rats treated with *M. smithii* is presented in Figure 1. Methane was detected in the atmosphere around the treated rats from the beginning of the dive as animals breathed He, due to native intestinal microbes producing H<sub>2</sub> and supplying it as a metabolic substrate to the *M. smithii*, even before H<sub>2</sub> was introduced into the chamber. Methane release rate increased as the chamber was pressurized with increasing amounts of H<sub>2</sub>, and decreased as H<sub>2</sub> pressure fell during chamber depressurization. Notably, there was a spike in methane release rate at the beginning of depressurization, which may reflect a period of supersaturation and release of bubbles of H<sub>2</sub> in the intestine that gave more rapid access to H<sub>2</sub> for the metabolism of *M. smithii*.

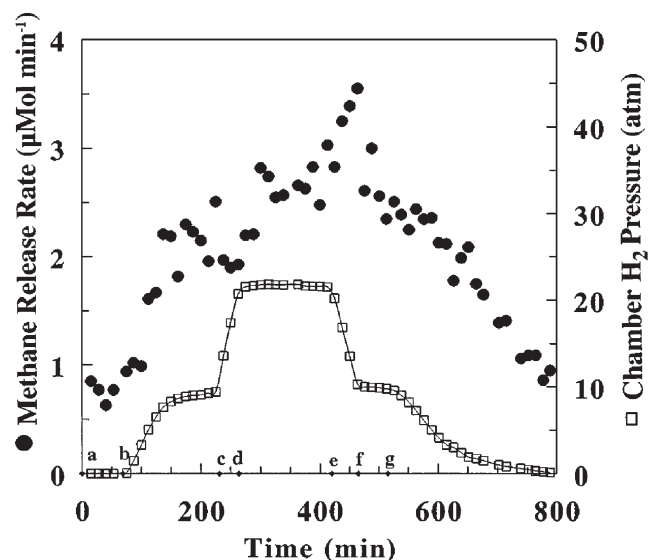
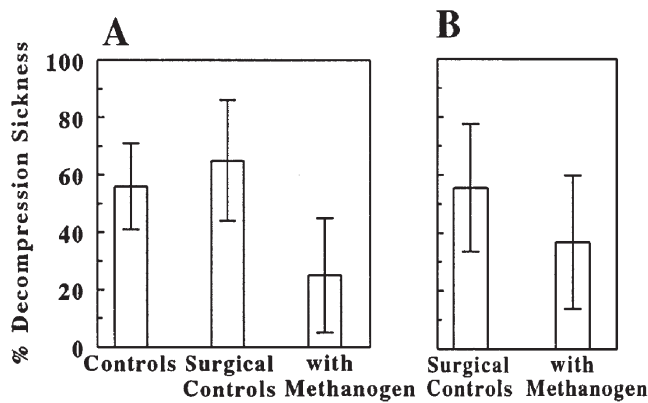

FIGURE 1. Average methane release rate per rat (●) from 5 rats with *Methanobrevibacter smithii* (50 μmol H<sub>2</sub> uptake · min<sup>-1</sup> activity) in their large intestines as they breathed H<sub>2</sub> (□) at various pressures (Kayar et al., 1998).

Rats treated with *M. smithii* and tested immediately for DCS risk had a 25% incidence of DCS (Fig. 2a). This was significantly lower ( $P < 0.01$ , Chi-squared one-sided test) than the incidence of DCS for untreated rats of 56% and surgical control rats of 65%. The incidence of DCS did not differ for these two control groups compared to each other ( $P = 0.34$ , Fisher's exact test). A similar result was obtained for the rats that first underwent the dive exposure to measure methane release rate, and were then decompressed and allowed to stay at one atmosphere over night before their second dive to test for DCS incidence (Fig. 2b).

Animals treated with *M. smithii* had a 36.8% DCS incidence, which was significantly lower ( $P < 0.05$  Chi squared



**FIGURE 2.** Incidence of decompression sickness for rats with and without *Methanobrevibacter smithii* placed in their intestines, following a standardized compression and decompression sequence (Kayar et al., 1998). (A) Animals with no treatment (controls), and with a bicarbonate solution (surgical controls) or *M. smithii* (with methanogen) placed surgically in their intestines and tested within 1–3 h of surgery. (B) Animals with surgically implanted bicarbonate solution or *M. smithii* tested for DCS ~24 h after the surgery and 12 h after completion of an exposure to hyperbaric  $H_2$  to measure methane release rate. Error bars represent 95% binomial confidence limits.

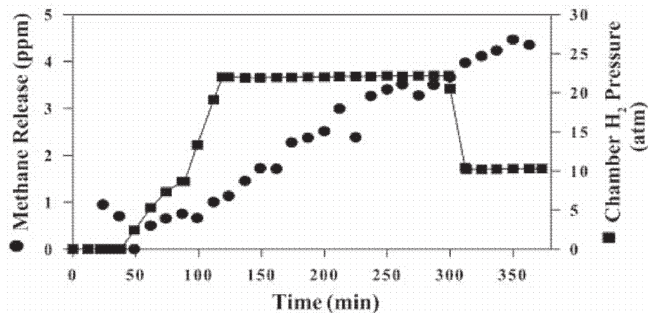

**FIGURE 3.** Methane release rate data from one pig that had received surgical injections of *Methanobrevibacter smithii* ( $795 \mu\text{mol CH}_4 \cdot \text{min}^{-1}$  activity) 1–2 h prior to an exposure to hyperbaric  $H_2$  (Kayar et al., 2001).

one-sided test) than the 55.6% incidence of the surgical control rats that also underwent the two dive procedures.

#### EXPERIMENTS WITH PIGS

Pigs, as in the experiments with rats, released methane from the beginning of the dive protocol, with methane release rate increasing as the chamber was pressurized with  $H_2$  (Fig. 3). Methane release rate continued to climb following the decompression to 11 atm, which we again speculate is due to bubbles of  $H_2$  in the intestine allowing more rapid access of *M. smithii* to this metabolic substrate during tissue supersaturation with  $H_2$ . Since the dive with pigs was terminal at 11 atm (for reasons related to gas safety and economy), there was no opportunity to observe a subsequent fall in methane release rate from pigs as the chamber was depressurized to 1 atm, as there had been with rats (compare the later time periods of Fig. 3 to Fig. 1).

Methane release rate from pigs was significantly correlated with activity of *M. smithii* injected into them ( $P < 0.001$ ,  $R = 0.70$ , slope =  $0.046$ , least squares linear regression; Fig. 4). Since pigs, unlike rats but similar to humans, have a native intestinal flora that includes *M. smithii*, there was variable but detectable methanogenic activity even in the surgical control and untreated control pigs (Fig. 4).

Addition of *M. smithii* to pigs significantly lowered their incidence of DCS during decompression. The treated animals had a DCS incidence of 44%, compared to 90% of untreated controls and 70% of surgical controls ( $P < 0.05$ , Chi-squared two-tailed test comparing treated animals to untreated control and surgical control groups combined; untreated controls and surgical controls not different from each other,  $P > 0.50$ , Chi-squared two-tailed test; Fig. 5).

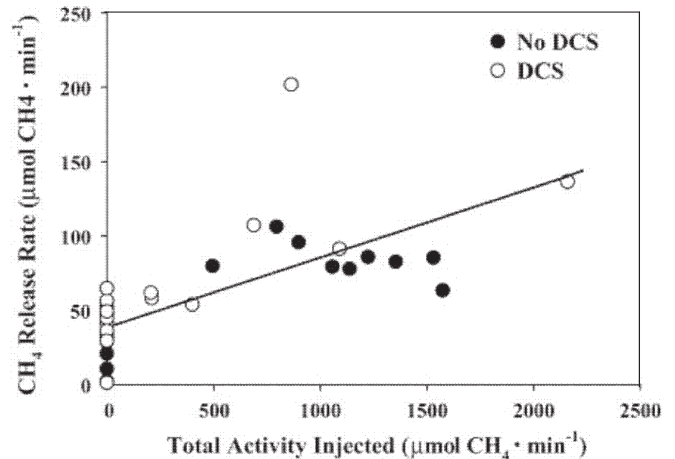

**FIGURE 4.** Activity of *Methanobrevibacter smithii* injected into the intestines of pigs versus mean rate of release of methane from these animals during a 3-h exposure to hyperbaric  $H_2$  (21.7 atm  $\text{PH}_2$ ). Decompression sickness (DCS) outcome is indicated for each animal. The line represents least squares linear regression ( $Y = 40.1 + 0.046X$ ;  $R = 0.70$ ,  $P < 0.001$ ; Kayar et al., 2001).



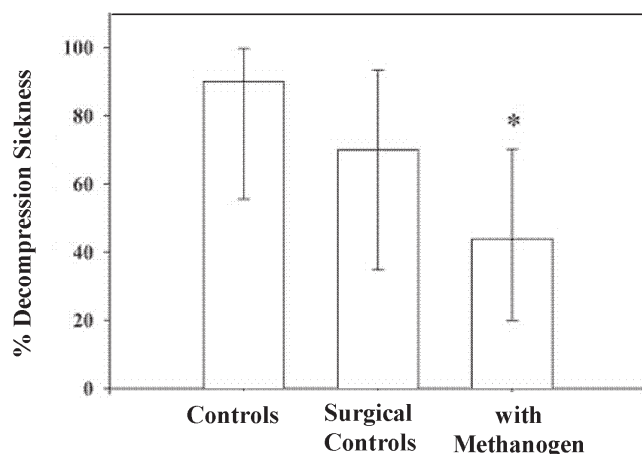

FIGURE 5. Decompression sickness incidence (%) for pigs that were untreated controls, treated with intestinal injections of saline solution (surgical controls), or treated with intestinal injections of *Methanobrevibacter smithii* (methanogens). Error bars represent 95% confidence limits on binomial distributions. \*Significantly lower than in pooled control groups ( $P < 0.05$ , Chi-squared test; Kayar et al., 2001).

## DISCUSSION

The increasing evolution of methane from *M. smithii*-treated rats (Fig. 1) and pigs (Fig. 3) during the course of a hyperbaric  $H_2$  exposure demonstrated that these methanogenic microbes did indeed extract  $H_2$  from the blood of the animals while inside the intestines. We envision that gradients for  $H_2$  in arterial and venous bloodstreams and across the lung can be modeled as illustrated in Figure 6 (Fahlman et al., 2001). A sink for  $H_2$  anywhere in the animal, particularly in an organ with a large surface area and excellent perfusion such as the intestine, can extract  $H_2$  down a pressure gradient from the arterial blood perfusing the intestine. This sink would result in lower mixed venous return of  $H_2$  to the lungs. During compression, the sink would prevent the animal from reaching full saturation with  $H_2$ . During decompression, the lower mixed venous  $PH_2$  would create slightly lower alveolar  $PH_2$ . Since alveolar gas exchange with the environment is never 100% efficient, the slightly lower alveolar  $PH_2$  would allow arterial  $PH_2$  to be lower with versus without *M. smithii*, thus accelerating the washout of  $H_2$  throughout the animal. We believe this process of gas elimination by *M. smithii* during biochemical decompression can be described in terms similar to those for a chemical scrubber unit in a mechanical system.

The treatments with *M. smithii* unambiguously lowered the animals' risk of DCS for both rats and pigs (Figs. 2 and 5). In fact, we discovered serendipitously while establishing our basic dive protocol with pigs that their native gut flora of methanogens can provide enough  $H_2$  scrubbing activity to reduce DCS risk (Kayar and Fahlman, 2001). We made some

simplifying assumptions regarding  $H_2$  solubility in the tissues of animals and thus total  $H_2$  content in rats and pigs of the body masses we used (Kayar et al., 1998; Kayar et al., 2001), and the estimated amount of  $H_2$  eliminated by the *M. smithii* in each case (four times the amount of methane evolved; Equation 1). Based on these calculations, we estimated that the *M. smithii* removed approximately 5-10 % of the body burden of  $H_2$  acquired during the hyperbaric  $H_2$  exposure; this gas removal resulted in a roughly 50% decrease in DCS risk in both the rats and the pigs (Kayar et al., 1998; Kayar et al., 2001; Fahlman et al., 2001).

It is important to note that although DCS risk was significantly negatively correlated with increasing methanogenic activity in our large animal model, eliminating more tissue  $H_2$  was not completely deterministic of reduced DCS risk (Fig. 4). The two animals shown in this figure that released more than  $130 \mu\text{mol CH}_4 \cdot \text{min}^{-1}$  during the simulated dive both had subsequent DCS. This may well represent the same phenomenon that has puzzled diving physiologists for years; namely, that grades of vascular bubbles as measured by Doppler ultrasound and other means of bubble detection are not deterministic of DCS risk or severity (Eftedal et al., 2007). Thus, while we have definite evidence that increasing the elimination of tissue inert gas is significant in lowering DCS risk, there must be one or more other risk factors that we have yet to identify.

It is feasible with existing technology to freeze-dry or otherwise concentrate and suspend the metabolism of *M. smithii*, then pack the inactive microbes into enteric-coated capsules. With customized coating, the capsules can be designed to break open only in the environment of the large intestine, allowing the microbes to be released and reactivated. Since *M. smithii* is a normal constituent of the human intestinal flora for people on a western diet and is well characterized as non-pathogenic (Miller, 1991), it would be a minor step to making such capsules ready for human safety testing.

If the remaining steps to achieving safer and/or faster decompression by taking a capsule are currently within our reach, why is it that a decade after the original demonstrations of  $H_2$  biochemical decompression were published are we not all popping capsules before our dives?

The answer is of course because we are not all diving with  $H_2$ . Hydrogen as a low narcotic potency diving gas was originally studied in Sweden in response to being cut off from access to He during the Second World War (Brauer and Naquet, 1987). The inclusion of  $H_2$  in an ultra-deep diving gas mixture reduces High-Pressure Neurologic Syndrome (HPNS) and decreases breathing resistance, thus making possible the record dive to 700 m in Marseille in 1991 (Imbert, 2006). The U.S. Navy's motivation for investing in ultra-deep  $H_2$  diving involved Cold War spying (Sontag and Drew, 1998). However, the Herculean efforts needed for working safely with hyperbaric  $H_2$  are barely hinted at by the descriptions above of the complex gas mixing and dive profiles used in these experiments, not to mention the added levels of complexity added when human subjects are

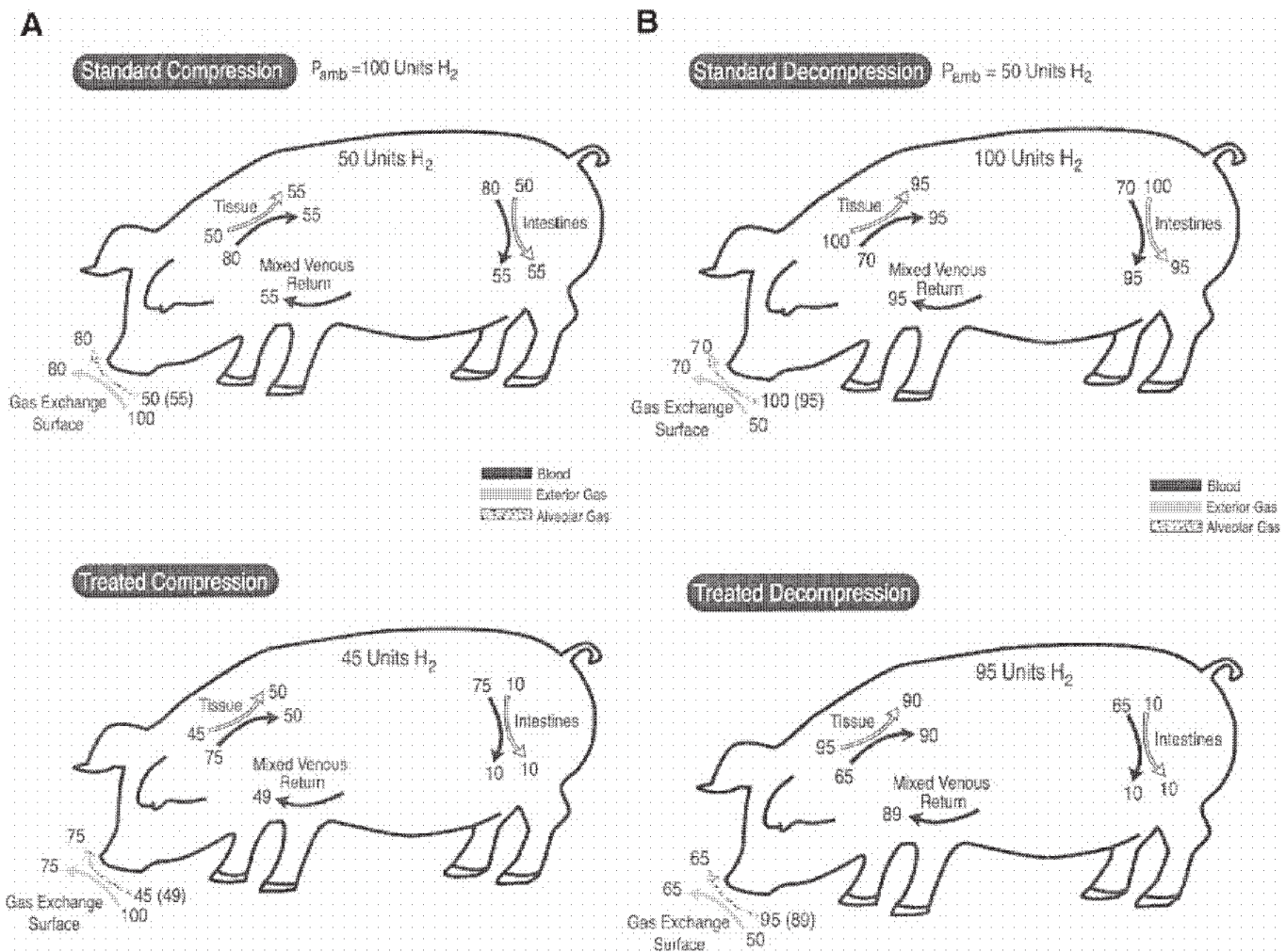

**FIGURE 6.** Proposed physiological mechanism for  $H_2$  biochemical decompression (Fahlman et al., 2001). In each figure, the number in parentheses represents the net result of the process of gas uptake (compression) or elimination (decompression) by the body at the end of a circulatory pass from the gas exchange surface throughout the body and returning to the gas exchange surface. Units in these figures are hypothetical and are used only to describe the current working hypothesis. See Fahlman et al., 2001 for a detailed description of this figure.

used. Nitrogen can also supplement heliox to reduce HPNS, along with slower compression (Imbert, 2006). There is thus little motivation for using  $H_2$  as a diving gas when He is readily available or in operations in which submersibles can perform the tasks. The experimental  $H_2$  diving in France of the 1980's and early 90's (e.g., Abraini et al., 1994; Fontanari et al., 2000) is no longer taking place.

Can the experience gained from these experiments with  $H_2$  biochemical decompression be translated into something more practical, such as  $N_2$  biochemical decompression? Theoretically,  $N_2$  biochemical decompression should be possible (Kayar et al., 1998). The processes of metabolizing  $N_2$  and  $H_2$  have similarities (Lehninger, 1970). There are microbes that metabolize atmospheric  $N_2$  to ammonia, nitrites or nitrates, a chemical process referred to as "fixing" nitrogen, some of which are present in the native gut flora of humans and other mammals. However, there

are multiple practical impediments to  $N_2$  biochemical decompression. Nitrogen fixation is a biochemically complex process that requires an input of energy, as compared to the metabolism of  $H_2$  that liberates energy (Lehninger, 1970). Consequently, most microbes will only fix significant amounts of atmospheric  $N_2$  in the absence of fixed nitrogen compounds in their environment. Feces are a major source of fixed nitrogen, hence their common use as plant fertilizer, giving the plants their needed precursors for making proteins. In order for a microbe to fix a significant amount of  $N_2$  while inside the intestines of a diver, we would have to select or create a mutant microbial strain that is constitutive for fixing  $N_2$  with high concentrations of fixed nitrogen compounds in its environment. Nitrogen fixation is a relatively slow process, much slower than metabolizing  $H_2$ ; identifying or engineering a mutant strain that is constitutive for fixing nitrogen at a rate that would be practical for diving,

and in a volume of microbes convenient to introduce into the intestines, will be a challenge.

Then would come the challenge of tracking the nitrogen fixation reaction inside the diver. Unlike  $H_2$  metabolism that conveniently allows stoichiometric quantities of methane to escape and be tested in the atmosphere around the diver, nitrogen compounds fixed by  $N_2$  biochemical decompression processes would be in the aqueous phase and mixed with fixed nitrogen compounds from multiple other biological processes. One would probably have to work with an isotopic  $N_2$  and look for the label in feces and possibly the intestinal wall or other tissues in order to track this reaction. All these steps would be difficult, but not impossible.

We believe that there are benefits to diving research from having completed the demonstrations of  $H_2$  biochemical decompression, despite the negligible role of  $H_2$  diving today. It seems little likely that anyone would want to face all the obstacles to  $N_2$  biochemical decompression without evidence of the feasibility of the concept of the intestine as a chemical scrubber unit for the inert gases acquired during diving. Our analyses from  $H_2$  biochemical decompression demonstrated that removing only a few percent of the estimated total inert gas load of a diver can have a major impact on DCS risk. This finding not only made some of the obstacles to  $N_2$  biochemical decompression less daunting, but also gave us a new way to examine our underlying assumptions about inert gas loads and DCS risk. The  $H_2$  biochemical decompression research also reconfirmed our speculation that while inert gas load is the primary factor to DCS risk, it is not exclusive.

It may indeed one day in the not-so-distant future be possible to mitigate the risk of DCS before a dive by swallowing a capsule. The best current bet on that capsule's content would be an anti-inflammatory drug. It remains to be seen if that capsule alone suffices for all our demands on diving and all our aversions to occupational hazards that we will want to place on it, or whether someone will have to rise to the challenges of  $N_2$  biochemical decompression.

#### ACKNOWLEDGMENTS

Andreas Fahlman made amazing and enormous contributions to this research, through his critical insights, his mathematical and scientific gifts, his unflagging determination, and his congenial nature. Erich C. Parker made several of the figures presented here, provided expert guidance in data analysis and DCS modeling, and gave the unconditional moral support of a loving and patient husband. The quality and quantity of work on this project, and the perfect safety record throughout hazardous duty, are also directly attributable to the dedication, professionalism, and friendship of our support team members, Richard Ayres, Jerry Morris, Roland Ramsey, and Chiefs Anthony Ruopoli and Scott Ario, U.S. Navy.

#### LITERATURE CITED

- Abraini, J.H., M.C. Gardette-Chauffour, E. Martinez, J.C. Rostain, and C. Le-maire. 1994. Psychophysiological reactions in humans during an open sea dive to 500 m with a hydrogen-helium-oxygen mixture. *Journal of Applied Physiology* 76:1113–1118.
- Boycott, A.E., G.C.C. Damant, and J.S. Haldane. 1908. The prevention of compressed-air illness. *Journal of Hygiene, Cambridge* 8:342–443.
- Brauer, R.W., and R. Naquet. 1987. Contributions of animal experimentation to the establishment of appropriate conditions for ethical use of hydrogen as a component of deep diving atmospheres. In: *Hydrogen as a Diving Gas*, R.W. Brauer, ed. Bethesda, MD: 33<sup>rd</sup> Undersea and Hyperbaric Medical Society Workshop. pp. 3–12.
- Eftedal, O.S., S. Lydersen, and A.O. Brubakk. 2007. The relationship between venous gas bubbles and adverse effects of decompression after air dives. *Journal of Undersea and Hyperbaric Medicine* 34:99–105.
- Fahlman, A., P. Tikuisis, J.F. Himm, P.K. Weathersby, and S.R. Kayar. 2001. On the likelihood of decompression sickness during  $H_2$  biochemical decompression in pigs. *Journal of Applied Physiology* 91:2720–2729.
- Fontanari, P., M. Badier, C. Guillot, C. Tomei, H. Burnet, B. Gardette, and Y. Jammes. 2000. Changes in maximal performance of inspiratory and skeletal muscles during and after the 7.1-MPa Hydra 10 record human dive. *European Journal of Applied Physiology* 81:325–328.
- Imbert, J.P. 2006. Deep diving: the Comex experience. In: *Long-Term Health Effects of Diving*, Hope, A., and J. Risberg, eds. Bodoni Press, Bergen, Norway, pp. 155–164.
- Kayar, S.R., and A. Fahlman. 2001. Decompression sickness risk reduced by native intestinal flora in pigs after  $H_2$  dives. *Journal of Undersea and Hyperbaric Medicine* 28:89–97.
- Kayar, S.R., T.L. Miller, M.J. Wolin, E.O. Aukhert, M.J. Axley, and L.A. Kiewow. 1998. Decompression sickness risk in rats by microbial removal of dissolved gas. *American Journal of Physiology* 275:R677–R682.
- Kayar, S.R., A. Fahlman, W.C. Lin, and W.B. Whitman. 2001. Increasing activity of  $H_2$ -metabolizing microbes lowers decompression sickness risk in pigs during  $H_2$  dives. *Journal of Applied Physiology* 91:2713–2719.
- Lehninger, A.L. 1970. *Biochemistry*. New York: Worth Publishers, pp. 559–562.
- Lillo, R.S., E.C. Parker, and W.R. Porter. 1997. Decompression comparison of helium and hydrogen in rats. *Journal of Applied Physiology* 82:892–901.
- Little, T., and B.D. Butler. 2008. Pharmacological intervention in the inflammatory response from decompression sickness in rats. *Aviation, Space, and Environmental Medicine* 79:87–93.
- Miller, T.L. 1991. Biogenic sources of methane. In *Microbial Production and Consumption of Greenhouse Gases: Methane, Nitrogen Oxides, and Halomethanes*, Rogers, J.E. and W.B. Whitman, eds. Washington, DC: American Society of Microbiology, p. 298.
- Montcalm-Smith, E.A., A. Fahlman, and S.R. Kayar. 2008. Pharmacological interventions to decompression sickness in rats: comparison of five agents. *Aviation, Space, and Environmental Medicine* 79:7–13.
- National Research Council. 1996. *Guide for the Care and Use of Laboratory Animals*. Washington, D.C.: Institute of Laboratory Animal Resources, National Academy Press.
- Nyquist, P., R. Ball, and M. Sheridan. 2007. Complement levels before and after dives with a high risk of DCS. *Journal of Undersea and Hyperbaric Medicine* 34:191–197.
- Sontag, S., and C. Drew. 1998. *Blind Man's Bluff*. New York: Perseus Books PublicAffairs™, 349 pp.
- Weathersby, P.K., L.D. Homer, and E.T. Flynn. 1984. On the likelihood of decompression sickness. *Journal of Applied Physiology* 57:815–825.





# Exercise and Decompression

*Russell S. Richardson*

---

**ABSTRACT.** This overview focuses upon the relationship between exercise and decompression. Specifically, studies that examine vascular bubble detection and the consequences for the endothelium, the relationship between exercise and decompression sickness (DCS), and finally, diving, vascular function, and the role of nitric oxide are discussed. It is concluded from both animal and human models that exercise performed 24 hours prior to decompression and potentially after a dive is not harmful as once thought, but appears instead to protect from DCS. A reduction in the number of venous gas bubbles may be related to the reduced risk of DCS. There is convincing evidence that the mechanism responsible for these interactions is related to NO bioavailability and thus the administration of an NO donor may be a reasonable pharmacologic alternative to exercise to protect against DCS.

## INTRODUCTION

This overview focuses upon the relationship between exercise and decompression. I was fortunate enough to be involved in some of the first studies that Drs. Alf Brubakk and Ulrik Wisloff engaged in to find the links between exercise and decompression, at least those of bubble formation and decompression sickness (DCS).

There are multiple components that ultimately may yield DCS, starting with a reduction in pressure that leads to a gas phase separation; gas bubbles generated in the vascular circulation that lead to adverse reaction to these bubbles; and, a large array of other physiological responses that are quite variable including epidermal rash, seizures, and even death. Predominantly, these features of DCS manifest when the diver exits the water upon completion of the hyperbaric exposure.

## BUBBLE DETECTION AND CONSEQUENCES FOR THE ENDOTHELIUM

The use of ultrasound Doppler facilitates the detection and ultimately the quantification of bubbles within the human vasculature, as can be seen in Figure 1, with the left panel as an example of cardiac image with a large number of venous gas bubbles (no pre-dive exercise) and the right panel with significantly less bubbles evident (pre-dive exercise) Dujic et al. (2004). With this ultrasound Doppler approach, allowing one to actually quantify the degree of bubbles formation it is possible to compare and contrast the prevalence of bubbles with differing interventions (e.g., a dive with and without prior exercise).

Systemically, there are significant deleterious consequences of bubbles passing

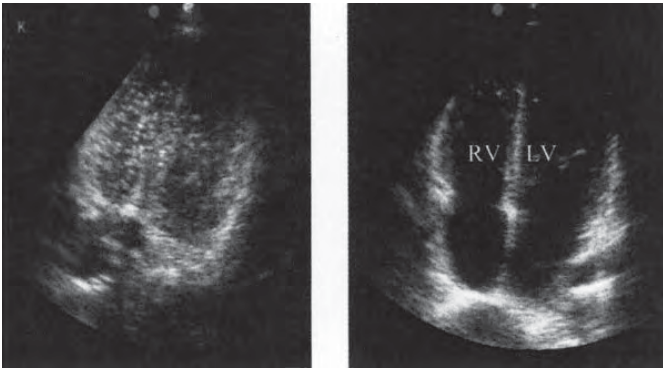

**FIGURE 1. Evidence of bubbles in the heart after a dive without prior exercise (left) and with prior exercise (right), from Dujic et al. (2004).**

through the vasculature. Histological slides from the endothelium of the pulmonary artery (Fig. 2) illustrate the typical healthy condition (left) compared to the damaging effect of bubble laden blood passing through the vasculature due to rapid decompression.

### RELATIONSHIP BETWEEN EXERCISE AND DCS

The risk factors for decompression sickness are diver specific (i.e., age, gender, body mass index, fitness, dehydration, patent foramen ovale, and previous DCS), dive related (i.e., duration, depth, ascent protocol, frequency, exercise, and temperature) or post-dive related (i.e., exercise, ascent to altitude, and surface environment). It is clear that there are several mentions of exercise as a risk factor and depending on its timing and intensity could play a role in the DCS phenomenon.

Carturan et al. (2002) detected a strong relationship between the number of bubbles formed and the maximum capacity to consume oxygen ( $VO_{2max}$ ) invoked by an graded exercise test. After similar dive exposure, reasonably fit individuals with a  $VO_{2max}$  of  $\sim 46$  ml/kg/min exhibited only  $\sim 0.07$  bubbles/cm<sup>2</sup>, whereas less fit individuals with an average  $VO_{2max}$  of  $\sim 35$  ml/kg/min exhibited  $\sim 0.5$  bubbles/cm<sup>2</sup>. Thus, “fitness” appears to afford some sort of protection from post-dive bubble formation. Recreational divers include not only younger healthy individuals but also older people who tend to have a lower  $VO_{2max}$ , likely due to both decreased activity and aging per se. Indeed, there is a reasonably robust relationship between age and exercise capacity, specifically, as one ages, approximately 8% of  $VO_{2max}$  is lost per decade (Fig. 3).  $VO_{2max}$  can be improved by exercise training notwithstanding significant genetic components of this variable. However, the somewhat disappointing observation has been made, that if one is well trained when young, although starting higher in terms of metabolic capacity, it is likely that the loss of this capacity still occurs at the same rate even in the face of continued efforts to remain physically active. Therefore, for all, ultimately the line of decaying  $VO_{2max}$  intersects the

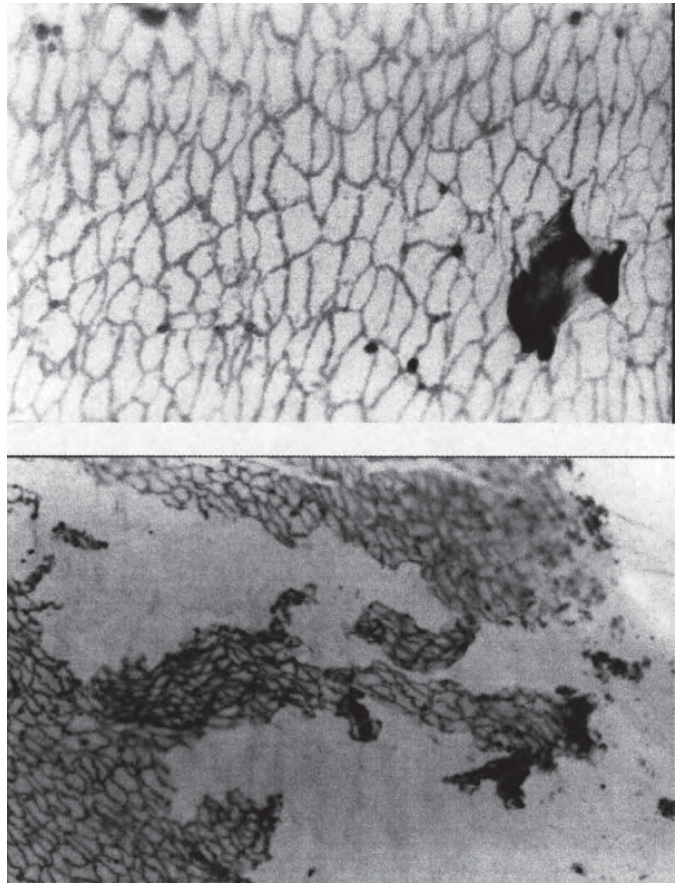

**FIGURE 2. Endothelium of the pulmonary artery in a healthy state (top) and damaged by bubbles (bottom).**

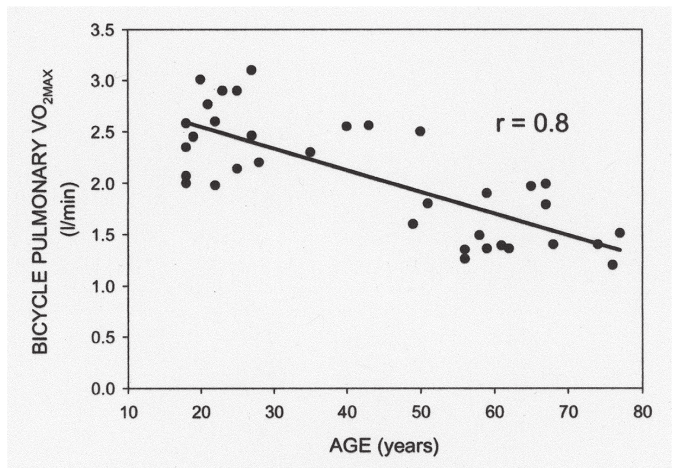

**FIGURE 3. Age and exercise capacity.**

x-axis and, at least conceptually, signals the end of life as we know it. However, the good news for the promotion of physical activity is that this does suggest that the upward shifted and parallel line of decay for exercise trained individuals will intersect the x-axis at a greater age, suggestive of longevity associated

with regular exercise. As a brief aside, it has been reported that the English Nobel laureate Professor A.V. Hill, who studied the limitations to maximal exercise at University College, London, plotted his  $\text{VO}_2\text{max}$  many times throughout his life and was subsequently able to predict his own death to within several years. Returning to the link between exercise capacity and DCS, based upon the work of Carturan et al. (2002), the implication here is that other factors, such as age, may play into the equation that links physical activity with the susceptibility to dive induced DCS.

In 2001 Drs. Wisloff and Brubakk were conducting decompression studies in rats without any real thought to the role of exercise in this process. While in the midst of these typical terminal studies (due to DCS), they experienced an acute shortage of animals and acquired some rats which were by happenchance exercise trained. When these animals were exposed to the same physiologically challenging decompression regimen that had killed the majority of other rats they found that intravascular bubble formation was dramatically reduced and all the animals survived. Ultimately, the take-home message from these somewhat serendipitous experiments was that aerobic endurance exercise training reduced bubble formation in rats exposed to hyperbaric pressure (Wisloff and Brubakk, 2001). It was here that my laboratory became involved in these studies, having an interest in exercise, endothelial function, and nitric oxide.

Exercise training results in a myriad of adaptations, one such adaptation is an increase in  $\text{VO}_2\text{max}$ . This is facilitated by adaptations that lead to greater capillary growth factors and elements that improve performance. With our laboratory's interest in oxygen transport and utilization we have documented morphometric differences between trained and untrained subjects showing an increased capillarity and coupled these structural findings with functional measurements that reveal elevated oxygen extraction across the muscle bed. This is the result of an increased diffusional conductance for oxygen and reflects a greater ease of passage for oxygen from blood to tissue. Interestingly, as the result of exercise training and the aforementioned angiogenesis, the vascular endothelial growth factor signal in response to acute exercise is now attenuated. This makes sense teleologically, for as you repeatedly exercise in the form of training, there needs to be some limit to the capillary growth, as ultimately there has to be balance achieved between contractile and vascular structures in skeletal muscle (Richardson et al. 1999). However, what exactly links these complex exercise-induced adaptations and the apparent protection from DCS afforded by physical activity are not yet completely understood.

Looking for the link between exercise adaptations and DCS, again utilizing the rat model, revealed that although exercise training and the subsequent increase in "fitness" per se may be beneficial, it was recognized that an acute bout of exercise exhibited the same protective effect against DCS (Wisloff et al., 2004). Indeed, it was determined that progressive long-term training is not necessary to elicit this phenomenon. The stimulus is simply a single exercise session, which can be repeated, but

does not have to be to yield this reduction in bubble formation and a reduced incidence and severity of DCS (Wisloff et al., 2004). Dujic et al. (2004) took these experiments into the human realm where a single exercise bout prior to a dive produced extremely clear, bubble free, ultrasound images of the ventricles compared to the bubble-laden images from dives that were preceded by inactivity. Thus, there is clearly a protective effect of acute exercise, but what is the optimum timeframe for acute exercise before a dive? With our current knowledge it seems that there may be some species differences. Specifically, in rats the optimum time for exercise prior to a dive to yield protection from bubble formation and improve survival is approximately 20 hours prior to submersion (Wisloff et al., 2004). Interestingly, in the animals, survival time was elongated when the exercise occurred 48 hours prior to the dive, but there was not a large reduction in bubble formation. In humans, on the other hand, the optimum time to exercise prior to a dive appears to be much shorter, with acute exercise just 2 hours prior to a dive providing a protective effect Dujic et al. (2004). To truly separate species-specific differences from varying methodologic approaches, more work is needed in this area.

## DIVING, VASCULAR FUNCTION, AND NITRIC OXIDE

Hyperbaric pressure, induced by diving puts a significant stress upon the cardiovascular system. Recently, Dujic et al. (2006) examined central cardiovascular responses, in terms of cardiac function, to a single air dive to 30 m for 30 min. Following the dive there were significant increases in end diastolic and end systolic volumes and a reduction in ejection fraction. In combination, these variables provide evidence that the dive exposure resulted in greater total peripheral resistance, against which the heart has to work. Endothelial dysfunction, a major mediator of vascular resistance, could be the cause of this increase in cardiac work. An additional link between DCS and the endothelium is the recognition that the bubbles associated with this disorder may originate in or around the endothelium. Of endothelial micronuclei, Harvey (1951) stated "if bubbles come from nuclei they must arise from gas nuclei sticking to or formed on or within the endothelial linings of the vascular system or extravascular spaces, and only when they have enlarged to the point of instability do they pass into the blood stream". Thus, although circumstantial at best, evidence is growing that the endothelium may play a role in the development of DCS.

Although, as discussed, exercise training results in significant adaptations, even a single bout of exercise is a powerful stimulus that will elicit a multitude of responses. With respect to the endothelium, nitric oxide production, free radical generation, and antioxidants to protect from free radicals, are all the result of an acute exercise bout (Kojda and Hambrecht, 2005). Among many other ideas, this raised the question, does nitric oxide blockade ablate the effect of exercise on bubble formation and what is the impact of such a blockage on survival time?



Wisloff et al. (2003) exercised two groups of rats and then administered an NO blocker (L-NAME) prior to the dive simulation (Fig. 4). The previously exercised control group demonstrated very little bubble formation after the dive because of the prior exercise, and after 60 minutes were sacrificed, as there was no sign that they were going to die from DCS. The other group infused with L-NAME, the nitric oxide synthase inhibitor, exhibited far greater bubble formation and only survived, on average, for approximately 25 minutes following the dive (Wisloff et al., 2003) (fig. 4). This study provided substantial evidence that nitric oxide does play a role in both bubble formation and susceptibility to DCS. In a follow-up to this rodent work Dujic et al., (2006) turned their attention to humans. Intravascular nitroglycerin which exogenously elevates nitric oxide bioavailability was used to assess the importance of NO levels. In control dives there was much greater bubble formation than when divers were provided with nitroglycerin (Dujic et al., 2006). Thus, providing additional support for the role of nitric oxide and subsequently endothelial function in the process of post-dive bubble formation and DCS.

Flow-mediated dilation (FMD) is a common bioassay used to assess vascular function and has recently been employed to better understand the interaction between exercise, vascular function, and DCS. To study FMD, an area of ischemia is created, often in the lower arm, by clamping off the blood flow with a suprasystolic cuff for approximately 5 minutes. The cuff release causes a hyperemia, after which the dilation of the vessel under scrutiny is measured by ultrasound Doppler, yielding both vessel diameter and blood velocity. The latter variable is likely of importance in addition to the assessment of diameter, as it has recently been recognized that the shear stress experienced by the vessel because of the hyperemia is perhaps the predominant determinant of the observed dilation and therefore blood velocity should be measured and taken into account. Thus, taking shear into account, the vasodilation resulting from an FMD test is thought to reflect nitric oxide bioavailability. Utilizing this FMD approach, Dujic et al. (2007) revealed a significant attenuation in endothelial function following a dive with post-dive function starting to be restored after 24 hours. This is further evidence that nitric oxide may be a major player in the development of DCS.

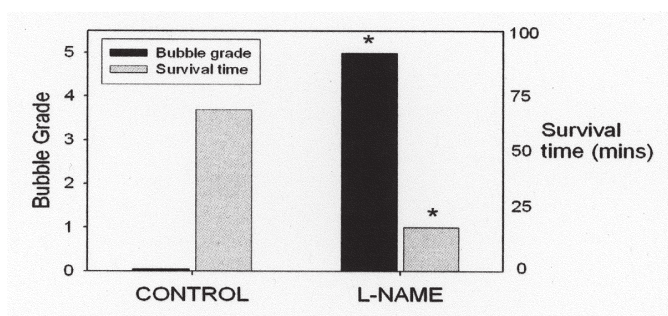

**FIGURE 4. Effect of NO on bubble formation and survival time.**

Within endothelial cells, Arginine is converted to Citrulline by the phosphorylation of endothelial nitric oxide synthase (eNOS), the production of NO, and subsequent smooth muscle relaxation (vasodilation). Prior to this final step, NO can be “intercepted” from its target of the smooth muscle by reacting with superoxide, a form of oxidative stress. This is a very rapid reaction (proposed to be the fastest in the body) that results in peroxynitrite and reduces NO bioavailability. The recent use of antioxidants to study the role of oxidative stress and NO bioavailability in the post-dive scenario provides more evidence that nitric oxide is a major player. Specifically, Dujic et al. (2006) revealed that FMD is attenuated as a consequence of a dive but the prophylactic treatment with antioxidants lessened this effect, presumably by increasing nitric oxide bioavailability, again supportive of an interaction between NO, vascular function and diving.

## CONCLUSION

Both animal models and studies in humans suggest that exercise performed 24 hours prior to decompression, after a dive, and even during decompression stops is not harmful as once thought, but appears instead to protect from DCS. A reduction in the number of venous gas bubbles may be related to the reduced risk of DCS. There is convincing evidence that the mechanism responsible for these interactions is related to NO bioavailability and thus the administration of an NO donor may be a reasonable pharmacologic alternative to exercise to protect against DCS.

## ACKNOWLEDGMENTS

Funding for Dr. Richardson and his laboratory was provided by The National Institute of Health, Heart Blood and Lung (PO1 HL 09183-01A1), The Tobacco-Related Disease Research Program (15RT-0100), and the Francis Family Foundation.

## LITERATURE CITED

- Carturan, D., A. Boussuges, P. Vanuxem, A. Bar-Hen, H. Burnet, and B. Garette. 2002. Ascent rate, age, maximal oxygen uptake, adiposity, and circulating venous bubbles after diving. *Journal of Applied Physiology* 93:1349–1356.
- Dujic, Z., D. Duplančić, I. Marinović-Terzić, D. Baković, V. Ivančev, Z. Valic, D. Eterović, N.M. Petri, U. Wisloff, and A.O. Brubakk. 2004. Aerobic exercise before diving reduces venous gas bubble formation in humans. *Journal of Physiology* 555(3):637–642.
- Dujic, Z., A. Obad, I. Palada, Z. Valic, and A.O. Brubakk. 2006. A single open sea air dive increases pulmonary artery pressure and reduces right ventricular function in professional divers. *European Journal of Applied Physiology* 97(4):478–485.
- Dujic, Z., Z. Valic, and A.O. Brubakk. 2008. Beneficial role of exercise on scuba diving. *Exercise and Sport Sciences Reviews* 36:38–42.
- Harvey, E.N. 1951 Physical factors in bubble formation. In: Fulton, J.F., ed. *Decompression Sickness*. Philadelphia and London: W.B. Saunders. pp. 90–114.
- Kojda, G., and R. Hambrecht. 2005. Molecular mechanisms of vascular adaptations to exercise. Physical activity as an effective antioxidant therapy?

*Cardiovascular Research* 67:187–97.

- Richardson, R.S., B. Grassi, T.P. Gavin, L.J. Haseler, K. Tagore, J. Roca, and P.D. Wagner. 1999. Evidence of O<sub>2</sub> supply-dependent VO<sub>2max</sub> in the exercise-trained human quadriceps. *Journal of Applied Physiology* 86:1048–1053.
- Wisloff, U., and A.O. Brubakk. 2001. Aerobic endurance training reduced bubble formation and increases survival in rats exposed to hyperbaric pressure. *Journal of Physiology* 537:607–611.

- Wisloff, U., R.S. Richardson, and A.O. Brubakk. 2003. NOS inhibition increases bubble formation and reduces survival in sedentary but not exercised rats. *Journal of Physiology* 546:577–582.
- . 2004. Exercise and nitric oxide prevent bubble formation: a novel approach to the prevention of decompression sickness? *Journal of Physiology* 555:825–829.



# Diving Medicine and the Cellular Stress Response

*George A. Perdrizet*

---

**ABSTRACT.** Divers and their physicians are well acquainted with the physiologic and medical implications of transient excursions into extreme environments. Exertion, hypothermia, anxiety and exposure to various breathing mixtures under pressure are all components of this complex equation. The physiologic responses that characterize these exposures have been extensively studied, including that of oxygen toxicity. The pathophysiologic changes associated with decompression illness have likewise been extensively studied but remain poorly understood. More recently, investigative attention has begun to focus upon the roles played by the cellular and biochemical changes underlying these phenomena. The complex processes of inflammation, oxidant stress, and vascular endothelial cell activation are becoming recognized as playing a major, albeit obscure, role in the physiologic and pathologic responses of divers to their environment. All of cellular life has preprogrammed within its genome the ability to respond in an adaptive way to noxious stimuli. This complex cellular response is referred to as the Cellular Stress Response (CSR) and is the focus of attention in a wide range of medical investigations, including cardiovascular disease, diabetes, cancer and trauma. The activation of the genes controlling this CSR (heat shock and molecular chaperone genes) can dramatically alter the physiologic outcome following exposure to extreme cellular environments, such as acute inflammation, hypoxia, or ischemia. This paper aims to introduce and review the history and development of the CSR as we know it today, relate the CSR to diving and hyperbaric medicine, and introduce the potential of hyperbaric oxygen to trigger and control the CSR.

## INTRODUCTION

The Cellular Stress Response (CSR) has its early beginnings linked closely to a phenomenon known as the Heat Shock Response (HSR). The initial description of the HSR was made, unexpectedly, by investigators using the polytene chromosome of the *Drosophila* fruit fly as a model for studying gene expression (Ritossa, 1964). Tremendous growth in the fields of molecular and cell biology have occurred since the initial description of the HSR by Feruccio Ritossa in 1962 (Welch, 1993). The discovery and characterization of the heat-shock genes initiated the rapidly expanding field of molecular medicine that we are experiencing today (Schlesinger et al., 1982). Early on it became clear that the heat-shock (HS) gene expression could alter cellular physiology in a predictable fashion. Increased HS gene expression conferred a state of protection to cells, permitting them to resist potentially lethal insults such as, hyperthermia and acute ischemia (Horowitz and Robinson, 2007; Rokutan et al., 1998). Furthermore it quickly became apparent that there were many “noxious insults” that could induce HS gene expression besides the original example of hyperthermia. One of the original, non-thermal, biochemical inducers of HS genes was 2,4-dinitrophenol a potent blocker of the electron transport chain and aerobic respiration (Ritossa, 1964). Since that time, the list of known inducers of the HS genes continues to grow and now includes exposure to diving environments and

hyperbaric oxygen (HBO<sub>2</sub>) (Kregel, 2002). Current models suggest that the common denominator through which these seemingly unrelated agents trigger this protective response is via the appearance of denatured intra-cellular proteins (Bensaude et al., 1996; Kim et al., 2007). It is now clear that the CSR can be induced by a wide array of conditions and agents which, in turn, can provide protection from an equally wide array of harmful or even potentially lethal insults.

A second major characteristic of the CSR is that it is a time-sensitive phenomenon and thus its onset, duration and resolution are potentially predictable events. This predictable time course lends itself to useful integration into many medically relevant applications, including the fields of diving and hyperbaric medicine. The time course of this HS-gene expression and associated state of cytoprotection was initially mapped out within the context of hyperthermic treatment of cancer and became known as thermotolerance (Herman et al., 1982). The early association of new HS-gene expression with the phenomenon of thermotolerance represents the first association of heat-shock proteins (HSPs) with a biological function, i.e., acquired resistance to lethal thermal injury (Landry et al., 1982). Since that time, understanding of the molecular and biological behaviors of the HSR has steadily progressed. It is now widely appreciated that the functional outcomes of HS-gene expression are the induction of the transient states of cytoprotection and anti-inflammation. These altered physiologic states are temporally associated with the synthesis of HSPs, especially the 70kD protein, HSP70. The HSPs belong to a larger class of proteins, the molecular chaperones, which have now been assigned basal as well as stress-related functions.

Since the initial application of the HSR to the problem of organ preservation in 1986 (Perdrizet et al., 1989) significant advances have been made in all levels of HS-related research (Wheeler and Wong, 2007). The body of knowledge surrounding the molecular chaperones and CSR has grown, now being represented by an international society (International Cell Stress Society), a dedicated journal (*Cell Stress and Chaperones*) and annual scientific meetings. A detailed description of the HSR, HSPs and CSR is beyond the scope of this paper, but excellent reviews provided by (Csermely, 1998; Nover, 1991; Maresca and Lindquist, 1991; Morimoto et al., 1994, 1997; Rokutan et al., 1998). For this review of CSR and HSPs with an emphasis on models relevant to the science and practice of diving and hyperbaric medicine, four questions are addressed.

## IS DIVING STRESSFUL?

The concept of stress was originally defined with great difficulty by Selye (1946) as “stress is any stimulus to which the system is not adapted”. He further notes that not all stress is harmful and differentiated between good stress (“eustress”) and harmful stress (“distress”). This latter distinction clearly recognizes the existence of an intrinsic and adaptable state of resistance to stress. A stimulus that is harmful to one cell or organism

may not be harmful to another and, furthermore, by manipulating the state of resistance of the individual a potentially harmful stimulus can be made less harmful. Thus, taking a person unfamiliar with diving and asking them to dive to 200 feet in the cold North Sea would be certainly distressful, perhaps even lethal. However, for the same individual with proper diver training such excursion would not be stressful but exhilarating or addictive! Diving is a clear psychological stressor. Managed appropriately, the response to stress is adaptive, but if overwhelmed, it can become lethal. Psychological stress has been shown to induce the CSR in humans, including induction of the HSP (Flerov et al., 2003). Simply studying for, or taking, an important professional examination can reach the threshold for the induction of the CSR (Morita, 2005). Relevant to diving and decompression illness, this stress-induced CSR is associated with a state of anti-inflammation, including down-regulation of inflammatory cytokine release and vascular endothelial cell activation (House et al., 2001). No one would argue that excursions to any extreme environment are not stressful on both psychological and physiological levels. But is “routine” or recreational diving stressful? Psychological stress aside, uncomplicated, routine diving presents at least three potential stressors to human biology: a) exposure to increased partial pressures of dissolved gases, especially nitrogen and oxygen, b) thermal stresses, both hot and cold, and c) weightlessness or microgravity. This last factor is counterintuitive, weightlessness would appear to be the antithesis of stress). One may also add to this list sleep deprivation, dehydration and the fasted state as variable but real contributors to the total stress related to routine diving activities. Is there scientific evidence at the cellular level that diving is stressful?

A brief literature review reveals that a myriad of examples exist in which diving is associated with cellular stress, as evidenced by increased synthesis of HSPs. Monocytes sampled from saturation divers on day 40 at 400 msw demonstrated a 175-fold increase in HSP70 and 210-fold increase in HSP27 protein expression (Matsuo et al., 2000). Lymphocytes taken from experienced SCUBA divers demonstrated elevated baseline expression of HSP70 protein and mRNA and reduced CD18 mRNA compared to non-diving volunteers (Cameron et al., 2008). Lymphocytes taken from humans three hours following a single dive (n = 7 male divers, 40msw, 25min, breathing air) demonstrated elevated heme-oxygenase-1 (HO-1, also known as HSP32) and the neutrophils showed a reduction in myeloperoxidase activity (Ferrer et al., 2007). The authors attributed these changes in white blood cells to the presence of oxidant stress. They also noted elevated markers of damage to red blood cells (LDH-lactate dehydrogenase) and skeletal muscle cells (CPK-creatinine phosphokinase) consistent with cellular stress from the single dive.

Interestingly, the apparently stressless environment of weightlessness provided by neutral buoyancy may in fact be a significant cellular stressor. A review of the published literature demonstrates multiple studies that confirm the ability of microgravity states to induce synthesis of stress proteins in both



animal and human tissues and cells. Zebra fish exposed to microgravity during development demonstrated an increased expression of HSP70 within lens tissue (Shimada and Moorman, 2006). Adult zebra fish exposed to microgravity demonstrated elevated synthesis of HSP70 within splenic tissues (Ohnishi et al., 1998). Human vascular endothelial cells, the monocytic cell line (U937) and human lymphocytic cell line (Jurkat), demonstrated an increased synthesis of HSP70 following exposure to microgravity *in vitro* (Cotrupi and Maier, 2004; Maier, 2006; Carlsson et al., 2003; Cubano and Lewis, 2001). The stress response to microgravity appears to be highly conserved across species as *E. coli* up-regulates sigma factor in response to microgravity and is consistent with the universal nature of the CSR (Lynch et al., 2004). Finally, the occurrence of a diving complication, like DCI, expectedly induced the synthesis of stress proteins in the rodent (Montcalm-Smith et al., 2007).

### IS HBO<sub>2</sub> STRESSFUL?

Hyperbaric oxygen therapy (HBO<sub>2</sub>T) is widely practiced throughout the world and has been for many years. HBO<sub>2</sub>T is provided by highly trained personnel in very controlled, clinical environments. It is without question that the practice of hyperbaric medicine is very safe, but is HBO<sub>2</sub> stressful? Modern hyperbaric medicine programs routinely expose hundreds of very frail and debilitated patients to HBO<sub>2</sub> on a daily basis for the purposes of aiding the wound healing response and do so with very low complication rates. It is therefore, from a clinical perspective, an unexpected notion that HBO<sub>2</sub>T might be stressful to humans as it appears so very well tolerated by individuals whose physiologic reserve has been compromised by years of chronic disease (i.e., obesity, diabetes, cardiovascular disease).

As with the submersion example in diving, entry into a hyperbaric chamber can provoke acute anxiety and as such likely induces the synthesis of stress proteins. Aside from this psychological stress, does the respiration of high partial pressures of oxygen also induce a CSR? Humans have clear limits to the amount of oxygen they can be exposed to before direct organ toxicity occurs (Clark et al., 2006). The doses of oxygen currently used in the practice of hyperbaric medicine have been adjusted to minimize gross end-organ toxicity. Current algorithms used in HBO<sub>2</sub>T rarely produce organ injury, but is it stressful at the cellular level?

A review of the published literature reveals a consistent finding: mammalian tissues exposed to HBO<sub>2</sub> produce large amounts of stress proteins. This new protein synthesis indicates that HBO<sub>2</sub>T is triggering a CSR in animal and human cells and tissues for both *in vitro* and *in vivo* settings. Several recent reports in the medical literature serve as examples. HBO<sub>2</sub> induces: expression of HSP70 in a murine neuroblastoma cell line *in vitro* (Shyu et al., 2004); HSP90 and NOS in rodent brain and is consistent with a response to oxidant stress (Thom et al., 2002); lens epithelial stress protein expression (Padgaonkar et al., 1997); DNA damage and stress proteins in human lymphocytes

*in vitro* (Dennog et al., 1999); HSP72 in human lymphocytes (Shinkai et al., 2004); and, HO-1 in human lung cell line *in vitro* (Speit and Bonzheim, 2003). Despite these cellular and biochemical findings, patients exposed to HBO<sub>2</sub> generally do not experience any acute discomfort or harm. Contrast this to the experience of using classical whole-body hyperthermia to achieve the same end. Whole-body hyperthermia (core body temperature of 102 - 108°F) is extremely uncomfortable for humans and poses a severe cardiovascular stress. Thus, the relative clinical ease by which HBO<sub>2</sub>T (whole-body hyperoxia) induces a CSR stands in stark contrast to whole-body hyperthermia. By virtue of its tolerability by humans it is a very attractive agent by which to manipulate the CSR in patients. The mechanism by which HBO<sub>2</sub>T induces the CSR is currently unknown but will likely involve the denaturation of intracellular proteins by the increased production of reactive oxygen species during exposure to hyperoxic stress.

### CAN DIVING OR HBO<sub>2</sub>T INDUCE PROTECTION AGAINST LETHAL OXIDANT INJURY?

A logical next question to ask is if HBO<sub>2</sub> can induce the CSR, can it also induce tissue-level protection? A state of cytoprotection against numerous noxious insults is known to temporarily associate with the CSR and HSR gene expression. Specific examples exist in a wide array of models and attest to the robustness of this phenomenon. The published literature contains models describing ischemic preconditioning, endotoxin tolerance, thermotolerance, and stress conditioning, demonstrating the fundamental similarity of these seemingly unrelated phenomena (Perdrizet, 1995). The unifying concept was first described by Hans Selye as the triphasic nature of the stress response. Selye's observations were made on the organismal level and have now been confirmed to be active at the cellular level (Perdrizet, 1997). The phenomenon of "acclimatization" described as an adaptive resistance to decompression illness in caisson workers would appear to represent yet one more example of the triphasic nature of the stress response (Walder, 1968). Furthermore, a prior sub-lethal episode of DCI appears to confer protection against a subsequent DCI episode in rabbits and is associated with increased synthesis of HSP70 (Su et al., 2004). Exposure of rodents to whole-body hyperthermia in a model of DCI protected the lungs and was associated with increased pulmonary expression of HSP70 (Huang et al., 2003).

HBO<sub>2</sub> exposure has been shown to confer protection against numerous noxious insults. This should come as no surprise given the consistent observation that HBO<sub>2</sub> exposure induces the CSR and HSR gene expression in animal and human cells and tissues. The ability to protect tissues against acute ischemia would have wide potential application and benefit in medical and surgical therapies. There is extensive evidence in experimental animal models of acute ischemia that preconditioning with HBO<sub>2</sub> can increase ischemic tolerance of many

tissues. Prior exposure of rodents to clinically relevant HBO<sub>2</sub> confers a state of ischemic tolerance in brain (Wada, 2001), heart (Kim, 2001), and spinal cord (Dong, 2002). The mechanism of this protection is under investigation and may involve HSP32 (a.k.a., heme-oxygenase-1) (Li et al., 2007). HBO<sub>2</sub> protects rodent lungs from LPS toxicity and increases HO-1 expression (Huang et al., 2005). HBO<sub>2</sub> protects rodent liver and is associated with increased expression of hepatic HSP70 (Yu et al., 2005). HBO<sub>2</sub> can protect rodent brain from acute ischemia and increases stress protein expression (Konda et al., 1996).

It is important to recognize that given the universal nature of the CSR and the highly conserved nature of its genetic apparatus, a phenomenon of cross-protection exists. Thus, the stressor used to induce tissue protection need not be the same agent against which protection is desired. For example, heat acclimatization can delay the onset of CNS oxygen toxicity in rodents and is associated with elevated HSP70 (Arieli et al., 2003). Heat shock can protect against DCI, oxygen pre-breathing can reduce the incidence of DCI, HBO<sub>2</sub> protects against LPS-induced lung injury (Huang et al., 2005).

### CAN PRE-EXPOSURE OF HUMAN CELLS, TISSUES OR ORGANS TO HBO<sub>2</sub> INCREASE RESISTANCE TO ACUTE ISCHEMIA?

HBO<sub>2</sub> protects human lymphocytes from DNA damage by oxidant injury (hydrogen peroxide). This protection was associated with increased synthesis of HSP32 (Gröger et al., 2005). To date, there is only one study that has tested the ability of HBO<sub>2</sub> pre-treatment to protect humans from acute ischemia during coronary artery bypass grafting procedure employing cardiopulmonary bypass (Alex et al., 2005; Yogaratnam et al., 2006). Sixty-four patients were randomized to receive (n = 33) or not receive (n = 31) three pre-treatments of HBO<sub>2</sub>T (100% oxygen, 2.4 ata, 90 min per treatment) at 24, 12, and 2 hours prior to the surgical bypass procedure. Patients receiving the HBO<sub>2</sub>T were found to have significantly less cognitive impairment when tested four months following surgery as compared to the controls (HBO<sub>2</sub>T: 30% versus Control: 55%, p < 0.05). The observed protection of neurocognitive function was associated with significantly less HSP70 in the serum from those patients treated with HBO<sub>2</sub>T as measured at 2 hours following completion of the surgical procedure.

### CONCLUSION

Humans exposed to the routine diving environment are exposed to significant biological stressors as evidenced by increased synthesis of stress proteins, the hallmark of a cellular response to stress. Clearly important factors such as the degree, duration, and innate host resistance all contribute to determine the ultimate impact these environments have on diver health and

disease. In short, diving is stressful. Humans exposed to HBO<sub>2</sub>T demonstrate an increased synthesis of stress proteins. The increased synthesis of stress proteins is the biochemical signature of the triggering of a CSR and as such may have wide-ranging potential for medical application. But are these changes in gene expression associated with cellular protection from oxidant injury such as that which occurs with acute ischemia? Exposure to both diving and hyperbaric oxygen environments results in the up-regulation of the CSR and HSR genes and these changes are predictably related to a transient period of cellular resistance to oxidant injury. Because HBO<sub>2</sub> is so well tolerated on a clinical level, it may represent the ideal pharmacologic agent to stress condition human beings prior to exposure to anticipated stressful events, such as invasive medical or surgical procedures. Can HBO<sub>2</sub>T precondition humans? The clinical need to provide robust protection from acute ischemic injuries associated with common medical and surgical procedures is great. Additional interventional trials which can test the HBO<sub>2</sub>T-stress conditioning hypothesis need to be performed and the nature of the potential benefit for future medical care determined.

### LITERATURE CITED

- Alex, J., G. Laden, A.R. Cale, S. Bennett, K. Flowers, L. Madden, E. Gardiner, P.T. McCollum, and S.C. Griffin. 2005. Pretreatment with hyperbaric oxygen and its effect on neuropsychometric dysfunction and systemic inflammatory response after cardiopulmonary bypass: a prospective randomized double-blind trial. *Journal of Thoracic and Cardiovascular Surgery* 130(6):1623–1630.
- Arieli, Y., M. Eynan, H. Gancz, R. Arieli, and Y. Kashi. 2003. Heat acclimation prolongs the time to central nervous system oxygen toxicity in the rat. Possible involvement of HSP72. *Brain Research* 962:15–20.
- Bensaude, O., S. Bellier, M.F. Dubois, F. Giannoni, and V.T. Nguyen. 1996. Heat-shock induced protein modifications and modulation of enzyme activities. *EXS* 77:199–219.
- Cameron, B.A., T.M. McLellan, D.J. Eaton, and S.G. Rhind. 2008. Inflammatory gene expression in the leukocytes of naïve subjects and experienced divers following acute hyperbaric stress. *Journal of Undersea and Hyperbaric Medicine* 35(4):243 Abstract A6.
- Carlsson, S.I., M.T. Bertilaccio, E. Ballabio, and J.A. Maier. 2003. Endothelial stress by gravitational unloading: effects on cell growth and cytoskeletal organization. *Biochimica et Biophysica Acta* 1642:173–179.
- Clark, J.M., C.J. Lambertsen, R. Gelfand, and A.B. Troxel. 2006. Optimization of oxygen tolerance extension in rats by intermittent exposure. *Journal of Physiology* 100:869–879.
- Cotrupi, S., and J.A. Maier. 2004. Is HSP70 up regulation crucial for cellular proliferative response in simulated microgravity? *Journal of Gravitational Physiology* 1:P173–176.
- Csermely, P. ed. 1998. Stress of Life from Molecules to Man. *Annals of the New York Academy of Sciences* 851:entire volume.
- Cubano, L.A., and M.L. Lewis. 2001. Effect of vibrational stress and spaceflight on regulation of heat shock proteins HSP70 and HSP27 in human lymphocytes (Jurkat). *Journal of Leukocyte Biology* 69:755–761.
- Denno, C., P. Radermacher, Y.A. Barnett, and G. Speit. 1999. Antioxidant status in humans after exposure to hyperbaric oxygen. *Mutation Research* 428:83–89.
- Dong, H., L. Xiong, Z. Zhu, S. Chen, L. Hou, and T. Sakabe. 2002. Preconditioning with hyperbaric oxygen and hyperoxia induces tolerance against

- spinal cord ischemia in rabbits. *Anesthesiology* 96:907-912
- Ferrer, M.D., A. Surenda, J.M. Batle, P. Tauler, J.A. Tur, and A. Pons. 2007. Scuba diving enhances endogenous antioxidant defenses in lymphocytes and neutrophils. *Free Radical Research* 41:274-281.
- Flerov, M.A., N.E. Ordyan, B.A. Margulis, I.V. Guzhova, A.V. V'yushina, S.G. Pivina, and I.A. Gerasimova. 2003. The use of HSP70 for prevention of consequences of unavoidable stress in rats. *Bulletin of Experimental Biology and Medicine* 136:120-122.
- Gröger, M., G. Speit, P. Radermacher, and C.M. Muth. 2005. Interaction of hyperbaric oxygen, nitric oxide, and heme oxygenase on DNA strand breaks *in vivo*. *Mutation Research* 572:167-172.
- Herman, T.S., C.C. Sweets, D.M. White, and E.W. Gerner. 1982. Effect of heating on lethality due to hyperthermia and selected chemotherapeutic drugs. *Journal of the National Cancer Institute* 68:487-491.
- Horowitz, M., and S.D. Robinson. 2007. Heat shock proteins and the heat shock response during hyperthermia and its modulation by altered physiological conditions. *Progress in Brain Research* 162:433-446.
- House, S.D., P.T. Guidon Jr, G.A. Perdrizet, M. Rewinski, R. Kyriakos, R.S. Bockman, T. Mistry, R.A. Gallagher, and L.E. Hightower. 2001. Effects of Heat Shock, Stannous Chloride, and Gallium Nitrate on the Rat Inflammatory Response. *Cell Stress and Chaperones International* 6:164-171.
- Huang, K.L., C.P. Wu, Y.L. Chen, B.H. Kang, and Y.C. Lin. 2003. Heat stress attenuates air bubble-induced acute lung injury: a novel mechanism of diving acclimatization. *Journal of Applied Physiology* 94:1485-1490.
- Huang, T.Y., P.S. Tsai, T.Y. Wang, C.L. Huang, and C.J. Huang. 2005. Hyperbaric oxygen attenuation of lipopolysaccharide-induced acute lung injury involves heme oxygenase-1. *Acta Anaesthesiologica Scandinavica* 49:1293-1301.
- Kim, C.H. 2001. Hyperbaric oxygenation pretreatment induces catalase and reduces infarct size in ischemic rat myocardium. *Pflugers Archiv, European Journal of Physiology* 442:519.
- Kim, H.J., N.R. Hwang, and K.J. Lee. 2007. Heat shock responses for understanding diseases of protein denaturation. *Molecules and Cells* 23:123-131.
- Konda, A., S. Baba, T. Iwaki, H. Harai, H. Koga, T. Kimura, and J. Takamatsu. 1996. Hyperbaric oxygenation prevents delayed neuronal death following transient ischaemia in the gerbil hippocampus. *Neuropathology and Applied Neurobiology* 22:350-360.
- Kregel, K.C. 2002. Heat shock proteins: modifying factors in physiological stress responses and acquired thermotolerance. *Journal of Applied Physiology* 92:2177-2186.
- Landry, J., D. Bernier, P. Chrétien, L.M. Nicole, R.M. Tanguay, and N. Marceau. 1982. Synthesis and degradation of heat shock proteins during development and decay of thermotolerance. *Cancer Research* 42:2457-2461.
- Li, Q., J. Li, L. Zhang, B. Wang, and L. Xiong. 2007. Preconditioning with hyperbaric oxygen induces tolerance against oxidative injury via increased expression of heme oxygenase-1 in primary cultured spinal cord neurons. *Life Sciences* 80:1087-1093.
- Lynch, S.V., E.L. Brodie, and A. Matin. 2004. Role and regulation of sigma S in general resistance conferred by low-shear simulated microgravity in *Escherichia coli*. *Journal of Bacteriology* 186:8207-8212.
- Maier, J.A. 2006. Impact of simulated microgravity on cell cycle control and cytokine release by U937 cells. *International Journal of Immunopathology and Pharmacology* 19:279-286.
- Maresca, B., and S. Lindquist, eds. 1991. *Heat Shock*. Berlin: Springer-Verlag.
- Matsuo, H., N. Shinomiya, and S. Suzuki. 2000. Hyperbaric stress during saturation diving induces lymphocyte subset changes and heat shock protein expression. *Journal of Undersea and Hyperbaric Medicine* 27:37-41.
- Montcalm-Smith, E., J. Caviness, Y. Chen, and R.M. McCarron. 2007. Stress biomarkers in a rat model of decompression sickness. *Aviation, Space, and Environmental Medicine* 78(2):87-93.
- Morimoto, R.I., A. Tissières, and C. Georgopoulos, eds. 1994. *The Biology of Heat Shock Proteins and Molecular Chaperones*. Cold Spring Harbor: Cold Spring Harbor Laboratory Press. 610 pp.
- Morimoto, R.I., M.P. Kline, D.N. Bimston, and J.J. Cotto. 1997. The heat-shock response: regulation and function of heat-shock proteins and molecular chaperones. *Essays in Biochemistry* 32:17-29.
- Morita, K. 2005. Expression analysis of psychological stress-associated genes in peripheral blood leukocytes. *Neuroscience Letters* 381:57-62.
- Nover, L. 1991. *Heat Shock Response*. Boca Raton: CRC Press.
- Ohnishi, T., K. Tsuji, T. Ohmura, H. Matsumoto, X. Wang, A. Takahashi, S. Nagaoka, A. Takabayashi, and A. Takahashi. 1998. Accumulation of stress protein 72 (HSP72) in muscle and spleen of goldfish taken into space. *Advances in Space Research* 21:1077-1080.
- Padgaonkar, V.A., F.J. Giblin, K. Fowler, V.R. Leverenz, J.R. Reddan, and D.C. Dziedzic. 1997. Heme oxygenase synthesis is induced in cultured lens epithelium by hyperbaric oxygen or puromycin. *Experimental Eye Research* 65:435-443.
- Perdrizet, G.A. 1995. Heat Shock and Tissue Protection. *New Horizons* 3:312-320.
- . 1997. Hans Selye and Beyond: Responses to Stress. *Cell Stress and Chaperones* 2:1-6.
- Perdrizet, G.A., T.G. Heffron, F.C. Buckingham, P.J. Salciunas, A.O. Gaber, F.P. Stuart, and J.R. Thistlethwaite. 1989. Stress conditioning: A novel approach to organ preservation. *Current Surgery* 46:23-25.
- Ritossa, F. 1964. Experimental activation of specific loci in polytene chromosomes of *Drosophila*. *Experimental Cell Research* 35:601-607.
- Rokutan, K., T. Hirakawa, S. Teshima, Y. Nakano, M. Miyoshi, T. Kawai, E. Konda, H. Morinaga, T. Nikawa, and K. Kishi. 1998. Implications of heat shock/stress proteins for medicine and disease. *Journal of Medical Investigation* 44:137-147.
- Schlesinger, M.J., J. Ashburner, and A. Tissières, eds. 1982. *Heat Shock from Bacteria to Man*. Cold Spring Harbor: Cold Spring Harbor Laboratory Press.
- Selye, H. 1946. The general adaptation syndrome and the diseases of adaptation. *Journal of Clinical Endocrinology* 6(2):117-230.
- Shimada, N., and S.J. Moorman. 2006. Zebra fish lens: changes in gravitational force cause changes in gene expression in the lens of developing zebra fish. *Developmental Dynamics* 235:2686-2694.
- Shinkai, M., N. Shinomiya, S. Kanoh, K. Motoyoshi, and H. Kobayashi. 2004. Oxygen stress effects on proliferation rates and heat shock proteins in lymphocytes. *Aviation, Space, and Environmental Medicine* 75:109-113.
- Shyu, W.C., S.Z. Lin, K. Saeki, A. Kubosaki, Y. Matsumoto, T. Onodera, M.F. Chiang, P. Thajeb, and H. Li. 2004. Hyperbaric oxygen enhances the expression of prion protein and heat shock protein 70 in a mouse neuroblastoma cell line. *Cellular and Molecular Neurobiology* 24(2):257-268.
- Speit, G., and I. Bonzheim. 2003. Genotoxic and protective effects of hyperbaric oxygen in A549 lung cells. *Mutagenesis* 18:545-548.
- Su, C.L., C.P. Wu, S.Y. Chen, B.H. Kang, K.L. Huang, and Y.C. Lin. 2004. Acclimatization to neurological decompression sickness in rabbits. *American Journal of Physiology* 287:R1214-1218.
- Thom, S.R., V. Bhopale, D. Fisher, Y. Manevich, P.L. Huang, and D.G. Buerk. 2002. Stimulation of nitric oxide synthase in cerebral cortex due to elevated partial pressures of oxygen: an oxidative stress response. *Journal of Neurobiology* 51(2):85-100.
- Wada, K. 2001. Preferential conditions for and possible mechanisms of induction of ischemic tolerance by repeated hyperbaric oxygenation in gerbil hippocampus. *Neurosurgery* 49:160.
- Walder, D.N. 1968. Adaptation to decompression sickness in caisson work. *Bio-meteorology* 11:350-359.
- Welch, W.J. 1993. How cells respond to stress. *Scientific American* 268(May):56-64.
- Wheeler, D.S., and H.R. Wong. 2007. Heat shock response and acute lung injury. *Free Radical Biology and Medicine* 42:1-14.
- Yogarathnam, J.Z., G. Laden, L. Guvendik, M. Cowen, A. Cale, and S. Griffin. 2006. Hyperbaric oxygen: a new drug in myocardial revascularization and protection? *Cardiovascular Revascularization Medicine* 7:146-154.
- Yu, S.Y., J.H. Chiu, S.D. Yang, H.Y. Yu, C.C. Hsieh, P.J. Chen, W.Y. Lui, and C.W. Wu. 2005. Preconditioned hyperbaric oxygenation protects the liver against ischemia-reperfusion injury in rats. *Journal of Surgical Research* 128:28-36.



# Individual Risk of Decompression Sickness: Possible Effects of Genomic or Epigenomic Variation Altering Gene Expression

*Andreas Møllerløkken and Ingrid Eftedal*

---

**ABSTRACT.** Changes in the physical or chemical surroundings of any organism, such as the pressure changes experienced on ascent from diving, are likely to trigger adaptive changes in gene expression patterns. However, the molecular responses are not necessarily uniform. Considerable variation in both constitutive and inducible gene expression is seen between and even within individuals at different times. The expression of a specific gene is regulated both by the DNA-sequence of the gene itself and by epigenetic modifications that alter a gene's availability for transcription without changing the sequence of DNA. A diver's capacity for adaptation to decompression may vary according to his or her individual genetic and epigenetic make up. Some of the genes involved in nitric oxide homeostasis in the endothelium display considerable individual differences in activity, which is known to trigger susceptibility to a number of diseases. This could indicate a link between endothelial dysfunction and decompression sickness (DCS) making the endothelium a highly interesting organ to study. We plan to examine alterations in genetic expression profiles of RNA in vascular endothelium in situ following decompression using rats as experimental models. We further plan to look for epigenomic variations between individual animals by examining the methylation pattern of cytosine in genomic DNA. By doing so, we hope to gain knowledge of genetic responses to the physical and biochemical changes experienced in diving. Ultimately the goal is to be able to better predict individual risk of developing DCS, and possibly also to prevent or relieve disease by means of preconditioning or pharmacological intervention.

## INTRODUCTION

During recent years there has been considerable focus on the risk of injury and dysfunction to the central nervous system in professional diving, commonly known as decompression illness. Different models have been developed to prevent the adverse effects of decompression for more than 100 years, but still the mechanisms behind the clinical manifestations are not completely understood. What we do know is that the initial step in the cascade of pathophysiological events leading to decompression sickness (DCS) is the formation of gas bubbles (Francis and Mitchell, 2003), and that most health hazards experienced in diving are consequences of changes in gas volume and formation of gas bubbles due to reduction in the ambient pressure during a diver's ascent. The Godøysund conference in 1993 highlighted the possible detrimental long term health effects of diving. This consensus conference was followed by a second conference in 2005 in Bergen. Both concluded that long term detrimental health effects of diving may occur and can represent a threat to occupational divers' quality of life (Hope and Risberg, 2006).

Recently, two epidemiological studies from the North Sea have verified the presence of functional changes following dives. One showed that there was a relationship between decompression and these changes (Irgens et al., 2007) and the other also showed additional risk for welders who dived (Ross et al., 2006). In a previous study we found



a correlation between manifestation of DCS and the number of times the diver underwent decompressions (Jacobsen et al., 1997; Brubakk and Eftedal, 2000). We have further found that a significant number of experienced professional divers (70%) have had symptoms of DCS without ever reporting them (Brubakk and Eftedal, 2000) and that signs of minor brain dysfunction were detectable in these divers. Even if clinical symptoms of DCS are relative rare in professional diving today, it seems well documented that decompression is still the major inducer of long-term effects on the central nervous system.

## THE PATHOPHYSIOLOGY OF GAS BUBBLES

The symptomatology of DCS is heterogeneous. Peripheral symptoms are frequently seen, but several central organ systems, including the central nervous system (CNS) and the respiratory system, may also be affected. It is quite possible that the pathogenesis of DCS at least in part is of an inflammatory origin as there is significant inter-individual susceptibility to decompression trauma. Furthermore, repetitive dives have resulted in greater tolerance to DCS due to acclimatization (Bergh et al., 1993; Hjelde et al., 1995; Ersson et al., 2002; Buttolph et al., 1998). Bubbles may further lead to a tissue response with activation of platelets, the coagulation cascade (Eckmann and Diamond, 2004; Nyquist et al., 2004; Thorsen et al., 1993), and complement (Hjelde et al., 1995).

The pathological effects of bubbles may originate from a mechanical disruption of the tissue concerned, for example the endothelium (Nossum et al., 1999), with compression of non-compliant tissue or blood vessels and lymphatic tissue, or from simply obstructing blood vessels. Signs and symptoms of DCS also differ with the pressure profile and breathing gas. Neurological symptoms are most common after short deep dives or altitude exposures with little or no pre-oxygenation. It is generally assumed that localized gas bubbles are responsible for all DCS incidents in the CNS. However, Wilmshurst and Bryson (2000) showed that a large PFO can be found in about 50% of divers having central nervous symptoms. They have also observed that large shunts correlate well with spinal cord DCS. Wilmshurst et al. (2001) demonstrated further that there is a relationship between right-to-left shunts and cutaneous DCS, which often is associated with more serious DCS involving the CNS and the lung (Conkin, 1999; Zwart, 2000). Gas bubbles can cause changes in barrier permeability even in the absence of clinical manifestations of DCS. Breakdown of the blood-brain-barrier (BBB) and blood-lung-barrier (BLB) may allow proteins and leukocytes to move into the extravascular brain tissue, with subsequent formation of oedema (Hjelde, et al., 2002; Chrysanthou et al., 1977; van Hulst et al., 2003). Leukocytes have been implicated in the progressive fall in cerebral blood flow and decreased cerebral function in animal models of gas embolism (Dutka et al., 1989; Helps and Gorman, 1991). Various plasma proteins including the coagulation system, complement

and kinins are also activated by bubbles (Ward et al., 1987; Pekna et al., 1993).

While bubbles in the venous system can explain pulmonary symptoms of DCS, there are other manifestations of DCS that can only be explained by bubble formation within the tissue themselves (Francis and Mitchell, 2003). Extravascular bubbles may form in tissue that is aqueous or lipid, and except for extreme decompression bubbles are seldom observed in heart, liver and skeletal muscle (Wienke, 1994). Daniels (1984) reported that the earliest bubbles detected were intravascular, but that substantial accumulation of stationary bubbles would occur before any signs of DCS were seen. In the periphery of the body, small intravascular bubbles may grow to sufficient size to occlude small vessels and thereby give rise to stationary intravascular bubbles. Blocking of the microcirculation causes not only tissue ischemia but also retards the elimination of dissolved gas and produces local areas with gas tensions higher than the surrounding tissue (Davies, 1983). Once formed, extravascular bubbles persist for long periods of time. Gas bubbles have been shown to persist up to two days after the original decompression (Davies, 1983).

## ENDOTHELIUM

The endothelium plays a key role in the short- and long-term regulation of the cardiovascular system and harbours many factors that influence blood flow, blood coagulation as well as angiogenesis (Triggle et al., 2003). The vascular endothelium consists of a monolayer of cells lining the luminal surface of all blood vessels in the body (Fig. 1). The endothelium functions by sensing various physiologic stimuli and triggering release of multiple vasoactive substances, including nitric oxide (NO). Such physiologic stimuli can be for example substances present in the blood or the shear stress associated with the blood flow. A large number of vasoactive substances are produced and secreted from endothelial cells to act on the underlying vascular smooth muscle cells. The balance between dilating and contracting factors is critical for maintaining vascular homeostasis (Cockcroft, 2005).

During resting conditions, the endothelial lining of the blood vessels forms a relatively inert surface that regulates and secures unhindered flow of cellular elements through the capillary beds. In response to an inflammatory signal initiated by bubbles, endothelial cells may be converted from an inactivated to an activated state inducing cellular functional changes. These changes may in turn destabilize pre-existing nuclei and make them expand into bubbles. Activation of the endothelium generates endothelial microparticles (EMP), which are fragments of activated endothelial cells. These may in turn reduce the endothelial function, possibly by increasing expression of the endothelial adhesion molecules such as vascular cell adhesion molecule-1 (VCAM-1), intracellular adhesion molecule-1 (ICAM-1) and E-selectin, and by influencing NO production (Jimenez et al., 2003; Brodsky et al., 2004). Following a decompression, this activation could be caused by endothelial damage from gas bubbles.

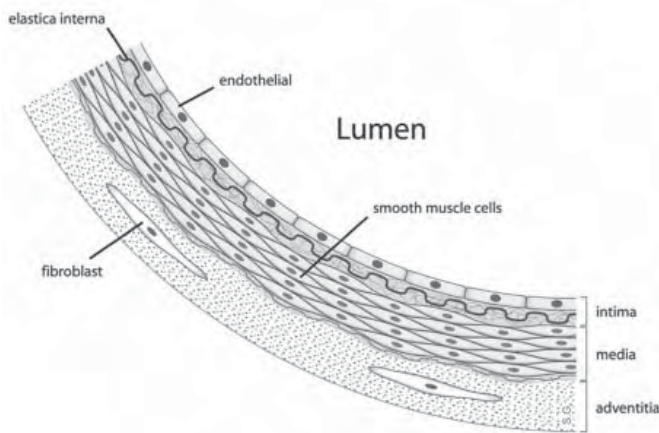

**FIGURE 1. The structure of the blood vessel wall with the three layers intima, media and adventitia. The figure is reproduced in agreement to conditions given by Stijn A. I. Ghesquiere, <http://creativecommons.org/licenses/by-sa/2.5/>.**

## FROM BUBBLES TO ALTERED GENE EXPRESSION

It is well documented that gas bubbles occur both on the arterial and venous side of the circulation following decompression from a dive, and we have increasing knowledge of the damaging effects these bubbles have on the endothelium (Brubakk et al., 2007). Changes in the physical or chemical surroundings of any organism, such as those experienced on ascent from diving, are likely to trigger adaptive changes in gene expression patterns. The observation that some of the genes known to be involved in the nitric oxide (NO) homeostasis display considerable individual difference in activity (Kojda et al., 2001), and that NO is an important mechanism in gas bubble formation (Wisloff et al., 2004; Møllerløkken et al., 2006) points towards possible genetic links between endothelial dysfunction and DCS.

When exposing the body to extreme physical or chemical conditions, such as the rapid alterations in surrounding pressure experienced by divers during and immediately after compression and decompression, what is usually sufficient in terms of protein expression and interactions may no longer be enough to ensure health. The amount and rate of changes in pressure experienced by divers is a challenge not normally experienced under basal life conditions, and the genes needed to cope with these alterations thus may not have been subject to strong selective forces to retain high activity of expression. Haploinsufficiency is a condition where the capability to adjust the level of RNA-expression in response to a stimulus is lowered due to partial or complete inactivation of one copy of an otherwise diploid gene. Since decompression is not a phenomenon normally experienced by humans or most mammals, it may well be that individual variation in susceptibility to DCS is reflected in levels of RNA-expression. We propose to examine alterations in genetic expression profiles in the endothelium *in situ* following

decompression using rats as experimental models. By doing so we aim to gain knowledge of how specific genes respond to the physical and biochemical changes experienced in diving. Ultimately, the goal is to be able to better predict individual risk of developing DCS and possibly also to prevent or relieve disease by means of preconditioning or pharmacological interventions.

Large-scale techniques developed for transcriptomics and systems biology are useful for examining how genetic variations in complex biological pathways contribute to variable phenotypes such as disease susceptibility. In this study we plan to use micro arrays for cDNA and global DNA methylation to study both genetic and epigenetic variation, since both may contribute to phenotypic variability. Mutations to the DNA sequence can cause changes in gene expression by altering the affinity for transcription factors, changing the catalytic properties of a translated protein, or abolishing expression altogether. Epigenetic patterns such as methylation of cytosine to 5-methylcytosine by imprinting during embryogenesis are also involved in regulation of gene expression. These patterns may be altered later in life by environmental factors such as diet, infections and age. Epigenetic changes have been shown to be involved in the development of malignant disease through altering the rate of transcription of tumor suppressor genes or proto-oncogenes (Lopez et al., 2009) and similarly may be involved in susceptibility to other diseases (Jirtle and Skinner, 2007). Considering the apparent increased susceptibility to DCS with the diver's age, it is interesting to note that both genome-wide and gene specific methylation patterns have been shown to change with age (Bjornsson et al., 2008; Richardson, 2003).

## THE RAT AS A MODEL SYSTEM FOR ENDOTHELIAL FUNCTION

Rats are generally considered to be genetically closer to humans than mice and its genome was recently sequenced. Global RNA expression arrays that are highly suited for studies of gene expression patterns in rats, mice and humans are commercially available. By using full genome cDNA expression arrays, global alterations in expression patterns that may be subscribed to altered DNA translation can be examined simultaneously.

A key first step in any genomic study is precisely defining responders and non-responders to any controlled influence. One approach is to identify candidate genes that may determine the action of the bubbles by screening for RNAs that are significantly differentially transcribed in animals that have undergone decompression. Then the candidate may be screened for genetic variants and altered biological activity.

## FUTURE RESEARCH

The first part of our study will be a pilot involving a relatively small number of animals. We will extract RNA from the endothelial lining of rat aortas following dives using well



established diving protocols. RNA extraction will take place immediately after decompression to best preserve the true expression pattern of genes. Genetically similar animals not subjected to decompression but otherwise identically treated animals will serve as controls and RNA will be extracted and analysed using the same protocol.

The second part of the study will take into account the results of the RNA expression studies, further examining genes and pathways found to be significantly altered in animals during decompression. We also have access to a rat strain that we have found to be more susceptible to decompression-related adverse effects than other strains and plan to compare their genetic profiles with the profiles of less susceptible animals. Knock-out animals are now commercially available for thousands of mouse genes, and a limited number of rat knock-outs are also emerging. They may supply models for further studies.

Finally, we seek to examine genetic variation in humans that may explain variable susceptibility to DCS. A bio-bank consisting of blood samples drawn from divers may form the basis for studies in which individuals who present with specific adverse effects of decompression are examined retrospectively for the presence of genetic variants suspected to be involved in susceptibility to disease. If clinically relevant genetic alterations are found, we seek to prevent or treat disease by preconditioning or pharmacological intervention, or to facilitate information in advance for those who may be at particularly high risk of DCS.

## LITERATURE CITED

- Bergh, K., A. Hjelde, O.J. Iversen, and A.O. Brubakk. 1993. Variability over time of complement activation induced by air bubbles in human and rabbit sera. *Journal of Applied Physiology* 74:1811–1815.
- Bjornsson, H.T., M.I. Sigurdsson, M.D. Fallin, R.A. Irizarry, T. Aspelund, H. Cui, W. Yu, M.A. Rongione, T.J. Ekström, T.B. Harris, L.J. Launer, G. Eiriksdottir, M.F. Leppert, C. Sapienza, V. Gudnason, and A.P. Feinberg. 2008. Intra-individual change over time in DNA methylation with familial clustering. *Journal of the American Medical Association* 299:2877–2883.
- Brodsky, S.V., F. Zhang, A. Nasjletti, and M.S. Goligorsky. 2004. Endothelium-derived microparticles impair endothelial function *in vitro*. *American Journal of Physiology* 286:H1910–1915.
- Brubakk, A.O., and O.S. Eftedal. 2000. Evaluation of reverse dive profiles. In Lang, M.A., and C.E. Lehner, eds. *Proceedings of the Reverse Dive Profiles Workshop*. Washington: Smithsonian Institution. pp. 111–121.
- Brubakk, A.O., O.S. Eftedal, and U. Wisløff. 2007. Endothelium and diving. In Aird, W., ed. *Endothelial Biomedicine*. Cambridge University Press. pp. 497–505.
- Buttolph, T.B., E.J. Dick, Jr., C.B. Toner, J.R. Broome, R. Williams, Y.H. Kang, and N.L. Wilt. 1998. Cutaneous lesions in swine after decompression: histopathology and ultrastructure. *Journal of Undersea and Hyperbaric Medicine* 25:115–121.
- Chryssanthou, C., M. Springer, and S. Lipschitz. 1977. Blood-brain and blood-lung barrier alteration by dysbaric exposure. *Undersea Biomedical Research* 4:117–129.
- Cockcroft, J.R. 2005. Exploring vascular benefits of endothelium-derived nitric oxide. *American Journal of Hypertension* 18:1775–1835.
- Conkin, J. 1999. How should cutis marmorata be treated? *Aviation, Space, and Environmental Medicine* 70:939–940.
- Daniels, S. 1984. Ultrasonic monitoring of decompression procedures. *Philosophical Transactions of the Royal Society of London* 304:153–175.
- Davies, J.M. 1983. Studies on bubble formation after decompression with special reference to the development and testing of the integrating ultrasonic pulse-echo imaging system for bubble detection. Oxford: University of Oxford Press.
- Dutka, A.J., P.M. Kochanek, and J.M. Hallenbeck. 1989. Influence of granulocytopenia on canine cerebral ischemia induced by air embolism. *Stroke: A Journal of Cerebral Circulation* 20:390–395.
- Eckmann, D.M., and S.L. Diamond. 2004. Surfactants attenuate gas embolism-induced thrombin production. *Anesthesiology* 100:77–84.
- Ersson, A., M. Walles, K. Ohlsson, and A. Ekholm. 2002. Chronic hyperbaric exposure activates proinflammatory mediators in humans. *Journal of Applied Physiology* 92:2375–2380.
- Francis, T.J.R., and S.J. Mitchell. 2003. Manifestations of Decompression Disorders. In Brubakk, A.O., and T.S. Neuman, eds. *Bennett and Elliott's Physiology and Medicine of Diving*, 5th ed: Saunders. pp. 578–600.
- . 2003. Pathophysiology of Decompression Sickness. In Brubakk, A.O., and T.S. Neuman, eds. *Bennett and Elliott's Physiology and Medicine of Diving*, 5th ed. Saunders. pp. 530–557.
- Helps, S.C., and D.F. Gorman. 1991. Air embolism of the brain in rabbits pretreated with mechlorethamine. *Stroke: A Journal of Cerebral Circulation* 22:351–354.
- Hjelde, A., G. Bolstad, and A.O. Brubakk. 2002. The effect of air bubbles on rabbit blood-brain barrier. *Journal of Undersea and Hyperbaric Medicine* 29:31–38.
- Hjelde, A., K. Bergh, A.O. Brubakk, and O.J. Iversen. 1995. Complement activation in divers after repeated air/heliox dives and its possible relevance to DCS. *Journal of Applied Physiology* 78:1140–1144.
- Hope, A., and J. Risberg. 2006. *Long Term Health Effects of Diving. The Godoyssund 1993 consensus conference revisited*. Bergen: BODONI. 302 pp.
- Irgens, A., M. Gronning, K. Troland, E. Sundal, H. Nyland, and E. Thorsen. 2007. Reduced health-related quality of life in former North Sea divers is associated with decompression sickness. *Occupational Medicine (London)* 57(5):349–354.
- Jacobsen, G., J.E. Jacobsen, R.E. Peterson, J.H. McLellan, S.T. Brooke, T. Nome, and A.O. Brubakk. 1997. Decompression sickness from saturation diving: a case control study of some diving exposure characteristics. *Journal of Undersea and Hyperbaric Medicine* 24:73–80.
- Jimenez, J.J., W. Jy, L.M. Mauro, C. Soderland, L.L. Horstman, and Y.S. Ahn. 2003. Endothelial cells release phenotypically and quantitatively distinct microparticles in activation and apoptosis. *Thrombosis Research* 109:175–180.
- Jirtle, R.L., and M.K. Skinner. 2007. Environmental epigenomics and disease susceptibility. *Nature Reviews* 8:253–262.
- Kojda, G., Y.C. Cheng, J. Burchfield, and D.G. Harrison. 2001. Dysfunctional regulation of endothelial nitric oxide synthase (eNOS) expression in response to exercise in mice lacking one eNOS gene. *Circulation* 103:2839–2844.
- Lopez, J., M. Percharde, H.M. Coley, A. Webb, and T. Crook. 2009. The context and potential of epigenetics in oncology. *British Journal of Cancer* 100:571–577.
- Møllerlökken, A., V.J. Berge, A. Jorgensen, U. Wisløff, and A.O. Brubakk. 2006. Effect of a short-acting NO donor on bubble formation from a saturation dive in pigs. *Journal of Applied Physiology* 101:1541–1545.
- Nossum, V., S. Koteng, and A.O. Brubakk. 1999. Endothelial damage by bubbles in the pulmonary artery of the pig. *Journal of Undersea and Hyperbaric Medicine* 26:1–8.
- Nyquist, P.A., E.J. Dick, Jr., and T.B. Buttolph. 2004. Detection of leukocyte activation in pigs with neurologic decompression sickness. *Aviation, Space, and Environmental Medicine* 75:211–214.
- Pekna, M., L. Nilsson, K. Nilsson-Ekdahl, U.R. Nilsson, and B. Nilsson. 1993. Evidence for iC3 generation during cardiopulmonary bypass

- as the result of blood-gas interaction. *Clinical and Experimental Immunology* 91:404–409.
- Richardson, B. 2003. Impact of aging on DNA methylation. *Ageing Research Reviews* 2:245–261.
- Ross, J.A.S., J.I. Macdiarmid, C.L. Taylor, L.M. Osman, A. Murray, G. Waiter, S. Semple, S.J. Watt, D.J. Godden, A. Lawson, W.R. Adie, and J. Crawford. 2006. Long-term Health Effects in United Kingdom Professional Divers. In Hope, A., and J. Risberg, eds. *Long-term Health Effects of Diving: The Godoyssund 1993 consensus conference revisited*. Bergen: BODONI. pp. 26–45.
- Thorsen, T., H. Klausen, R.T. Lie, and H. Holmsen. 1993. Bubble-induced aggregation of platelets: effects of gas species, proteins, and decompression. *Journal of Undersea and Hyperbaric Medicine* 20:101–119.
- Triggle, C.R., M. Hollenberg, T.J. Anderson, H. Ding, Y. Jiang, L. Ceroni, W.B. Wiehler, E.S. Ng, A. Ellis, K. Andrews, J.J. McGuire, and M. Pannirselvam. 2003. The endothelium in health and disease—a target for therapeutic intervention. *Journal of Smooth Muscle Research* 39:249–267.
- Van Hulst, R.A., J. Klein, and B. Lachmann. 2003. Gas embolism: pathophysiology and treatment. *Clinical Physiology and Functional Imaging* 23:237–246.
- Ward, C.A., D. McCullough, and W.D. Fraser. 1987. Relation between complement activation and susceptibility to decompression sickness. *Journal of Applied Physiology* 62:1160–1166.
- Wienke, B.R. 1994. *Basic Diving Physics and Applications*. Flagstaff: Best Publishing Company.
- Wilmshurst, P., and P. Bryson. 2000. Relationship between the clinical features of neurological decompression illness and its causes. *Clinical Science (London)* 99:65–75.
- Wilmshurst, P.T., M.J. Pearson, K.P. Walsh, W.L. Morrison, and P. Bryson. 2001. Relationship between right-to-left shunts and cutaneous decompression illness. *Clinical Science (London)* 100:539–542.
- Wisloff, U., R.S. Richardson, and A.O. Brubakk. 2004. Exercise and nitric oxide prevent bubble formation: a novel approach to the prevention of decompression sickness? *Journal of Physiology* 555:825–829.
- Zwart, B.P. 2000. Treatment of *cutis marmorata* (cutis). *Aviation, Space, and Environmental Medicine* 71(4):457.



# Inducing HSP for Protection against DCS: Heat Exposure before Diving Reduces Bubble Formation in Man

*Jean-Eric Blatteau, Emmanuel Gempp, Jean-Michel Pontier,  
Costantino Balestra, Tony Mets, and Peter Germonpré*

---

**ABSTRACT.** Heat stress is a non-pharmacological preconditioning strategy which can lead to protection against various types of subsequent insults, such as ischemia, hypoxia, inflammation, drugs, and even bubble-induced injury from decompression. It has been suggested that the protective effect of heat exposure against DCS in rats could be related to biochemical processes involving heat shock proteins (HSP) of the 70-kDa range. The purpose of this study was to determine the efficacy of sauna-induced heat exposure prior to a simulated dive on bubble reduction and to examine the adjustments in Hsp70 concentration and hemodynamic parameters. Sixteen divers were compressed in a hyperbaric chamber to 400 kPa for 25 min and decompressed at a rate of 100 kPa. min<sup>-1</sup> with a 4 min stop at 130 kPa. Each diver performed two dives, one with and one without pre-dive FIR dry sauna session for 30 min at 65°C, ending 1 hour prior to the dive. Brachial artery flow mediated dilation (FMD), blood pressure, and bodyweight measurements were taken before and after the sauna session along with blood samples for analysis of plasma volume, protein concentrations, plasma osmolality, and plasma Hsp70. Circulating venous bubbles were detected with a precordial Doppler after surfacing. This study shows that a single pre-dive sauna session significantly decreases circulating bubbles after a chamber dive. Plasma Hsp70 significantly increased 2 h after sauna completion. The sauna session led to an extracellular dehydration, resulting in hypovolemia and bodyweight loss. A significant rise in FMD and a reduction in systolic blood pressure and pulse pressure were observed. Inducing HSP from heat stress could offer a new way of reducing decompression sickness risk. Sweat dehydration and NO pathway could be also involved in this protective effect. Further investigation is required to elucidate the preponderant mechanism underlying this heat exposure induced reduction in bubble formation.

## INTRODUCTION

Preventive measures to reduce the risk of decompression sickness (DCS) can involve several pre-dive procedures reported in some experimental studies such as oxygen breathing (Butler et al., 2006), exercise before diving (Dujic et al., 2004; Blatteau et al., 2005), intake of exogenous nitric oxide (Dujic et al., 2006) or prehydration (Gempp et al., 2008).

Activation of the stress protein response (heat-shock protein, HSP) by mild hyperthermia allows cells to resist subsequent metabolic insults that would otherwise be lethal, a phenomenon referred to as preconditioning. HSP induction can lead to protection against various types of stress such as ischemia, hypoxia, hyperoxia, inflammation (Kregel, 2002), and even bubble-induced injury from decompression (Huang et al., 2003; Medby et al., 2008).

HSP are involved in many regulatory pathways and have an important function in controlling the folding and structure of proteins acting as chaperones. The most abundantly and best studied HSP are the 70 kDa families. Hsp70 are the most temperature sensitive and are highly inducible. Moderate increases in temperature (>38°C) produce elevated Hsp70 levels which are dependent on the duration of heat stress. The

*Jean-Eric Blatteau, Emmanuel Gempp, and Jean-Michel Pontier, Département de Médecine Hyperbare, Hôpital d'Instruction des Armées Sainte-Anne, 83800, Toulon Armées, France. Costantino Balestra, Environmental and Occupational Physiology Laboratory, I.S.E.K. Haute Ecole Henri Spaak, 1160, Brussels, Belgium. Tony Mets, Akademisch Ziekenhuis, Vrije Universiteit, 1120, Brussels, Belgium. Peter Germonpré, Centre d'Oxygénothérapie Hyperbare, Hôpital Militaire Reine Astrid, 1120, Brussels, Belgium.*

protective effect of heat exposure against DCS in rats could be related to increased expression of Hsp70 (Huang et al., 2003; Medby et al., 2008). Hsp70 induction could also be involved in the mechanisms responsible for diving acclimatization after repeated compression-decompression cycles (Su et al., 2004).

Moreover, it has been demonstrated that heat-inducible proteins are also able to interact with endothelial nitric oxide (NO) pathway (Harris et al., 2003) which may influence the degree of bubble formation in hyperbaric conditions (Wisloff et al., 2003, 2004).

It is well recognized that high environmental temperatures lead to sweat response resulting in dehydration. In a previous work, we have also shown that moderate dehydration resulting in stroke volume (SV) reduction induced by a pre-dive exercise could decrease venous circulating bubbles in divers (Blatteau et al., 2007).

The purpose of this study was to determine the effectiveness of sauna-induced heat exposure prior to a simulated dive on bubble formation and to examine the adjustments in Hsp70 concentrations and haemodynamic parameters.

## METHODS

### DIVING PROCEDURE

16 military divers (38.4 years avg. and BMI of 25 kg.m<sup>-2</sup>) underwent a simulated dive in a dry hyperbaric chamber to 400 kPa (30 m) for 25 min and a stop at 3 m for 4 min. Each diver performed two dives five days apart, one dive without sauna and one preceded by a sauna session. The order of the two dives was randomly allocated. Divers were instructed to avoid physical exertion during the 2 days that preceded each trial.

### SAUNA PROCEDURE

Subjects were seated for 30 min at 65°C with the head out of the cabin in a Far Infrared-Ray dry sauna system. In similar conditions, deep body temperature rises about 1°C during sauna exposure (Tei et al., 1995). The sauna session ended 1 hour before the simulated dive. The divers were not allowed to drink water during the entire protocol.

### BUBBLE DETECTION

Circulating bubbles were detected using a pulsed Doppler on the precordial area at 20, 40 and 60 min after surfacing (at rest and after 2 flexions). The bubble signals were graded according to the Spencer scale before conversion to the Kissman Integrated Severity Score (KISS). This score takes into account the kinetics of the bubbles at the different recording times and is assumed to be a meaningful linearised measure of post-decompression intravascular bubble activity status that may be treated statistically (Nishi et al., 2003).

## PHYSIOLOGICAL PARAMETERS

Blood samples were collected by venipuncture for hematocrit (Hct), hemoglobin (Hb), plasma proteins and osmolality after resting in a supine position for 20 min; measurements were determined before and 30 min after the sauna session. Percent changes in plasma volume (PV) were calculated using an Hb-Hct transformation equation (Harrison et al., 1982). Heart rate (HR) and blood pressure (BP) were obtained immediately before each venipuncture by using a portable monitoring system. Pulse pressure and mean arterial BP were calculated from the systolic and diastolic arterial BP. Weight measurements have been achieved immediately before and 35 min after the end of sauna. Additional measurements were taken to evaluate the sauna exposure (without diving) in 10 divers for 1) arterial response to reactive hyperaemia (flow-mediated dilatation-FMD); 2) plasma HSP70 levels.

FMD was determined before and 60 minutes after the sauna session, at the level of the right brachial artery, according to a protocol previously described (Corretti et al., 2002). This indirect method evaluates nitric oxide-dependent endothelial function.

HSP70 measurements were done at 30 min, 2 h, 8 h and 24 h after sauna completion. Venous blood samples were separated from blood cells and stored at -70°C. HSP70 in serum was detected using an in-house sandwich ELISA method previously described (Njemini et al., 2005).

## STATISTICAL ANALYSIS

Data are presented as mean ± S.D. Data were analysed using non-parametric statistics because of the small sample size. Wilcoxon signed rank test was used for paired data, whereas comparisons in different times for HSP70 kinetics were evaluated by Friedman test (repeated measures ANOVA on ranks). Differences between groups were considered significant at  $p < 0.05$ .

## RESULTS

None of the divers suffered from DCS after the dives. The maximum bubble count was observed 40 minutes after surfacing following the respective protocol (with or without sauna). A single session of sauna ending 1 hour before the dive significantly reduced - 27.2% KISS bubble grades at rest (mean KISS 1.95 versus 7.17,  $p = 0.031$ ) and - 35.4% after flexions (mean KISS 3.6 versus 10.18,  $p = 0.039$ ). Only one diver showed a slight increase in venous bubble grade after performing sauna (Figure 1).

Subjects performing a single sauna session had significantly elevated plasma HSP70 concentrations from baseline values 2 hours after the sauna completion (mean HSP values 1939 versus 729 ng.l<sup>-1</sup>,  $p = 0.005$ ) with no significant differences at 30 min, 8h and 24 h (Fig. 2).

We observed a significant reduction of body weight by 0.6% after sauna ( $-450 \pm 18$  g, mean ± S.D.  $p < 0.001$ ). Plasma

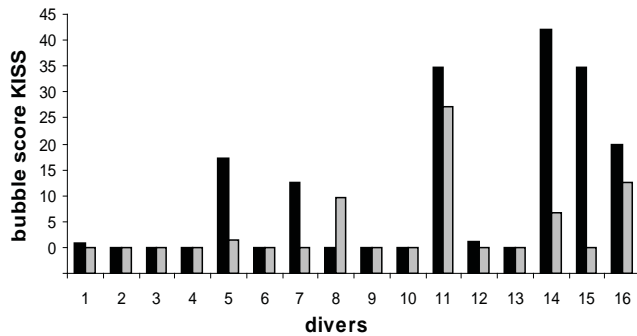

FIGURE 1. Individual KISS bubble scores (after flexions), following hyperbaric exposure to 400 kPa for 25 min. Black bars represent controls and grey bars conditions with sauna ending 1h prior to the dives.

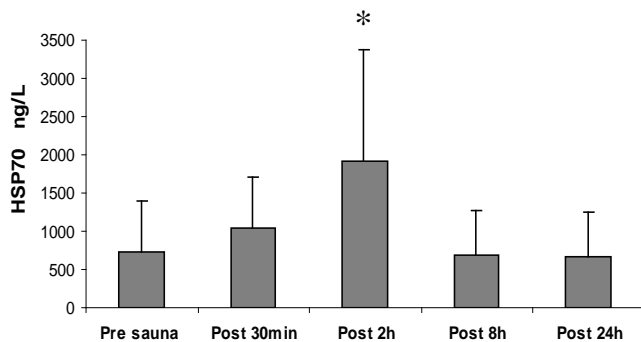

FIGURE 2. Expression of plasma HSP70 (mean  $\pm$  sem) before and after FIR sauna exposure (65°/30min) in 10 subjects. \* denotes  $p < 0.05$ .

volume decreased by 2.7 % after sauna ( $p < 0.001$ ). Plasma proteins significantly increased by 3% after sauna ( $73.1 \pm 2.9$  versus  $70.9 \pm 2.8$  mg.l<sup>-1</sup>, mean  $\pm$  S.D.  $p < 0.001$ ) whereas there were no significant differences in plasma osmolality before and after sauna (Fig. 3)

Systolic blood pressure and pulse pressure decreased significantly ( $112 \pm 10$  versus  $119 \pm 13$  mmHg,  $p = 0.013$  and  $40 \pm 17$  versus  $46 \pm 19$  mmHg, mean  $\pm$  S.D.  $p = 0.005$  respectively) whereas diastolic and mean blood pressure remained unchanged after sauna. HR was not modified by sauna.

We found a significant increase of FMD (Fig. 4) observed 1 hour after the sauna completion from baseline values measured 15 min before the sauna exposure ( $13 \pm 2.8\%$  versus  $7.7 \pm 3\%$ , mean  $\pm$  S.D.  $p = 0.002$ ).

## DISCUSSION

The main result of our study is that a single pre-dive sauna session significantly decreased circulating bubbles. Our working hypothesis is that heat preconditioning could contribute to reduce bubble burden by reducing nitrogen load during the dive

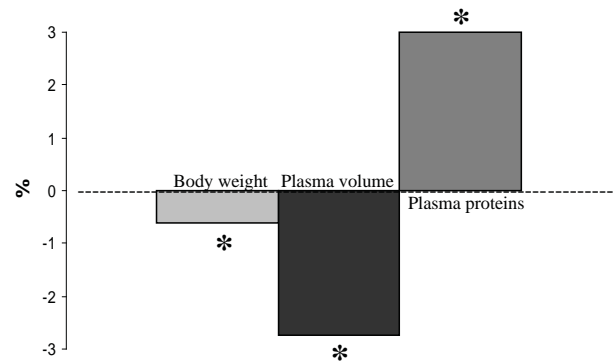

FIGURE 3. The sauna session led to an extracellular dehydration resulting in hypovolemia (- 2.7% of plasma volume) and body weight loss (- 0.6%).

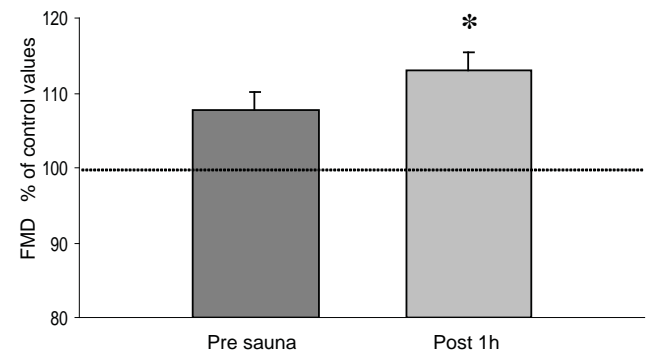

FIGURE 4. Brachial artery Flow Mediated Dilation (mean  $\pm$  sem) before and 1h after FIR sauna exposure (65°/30min) in 10 subjects. \* denotes  $p < 0.05$ .

and/or alter the population of gaseous nuclei from which bubbles form (Blatteau et al., 2006, 2007).

## DEHYDRATION

Although dehydration is commonly proposed as a risk factor for DCS in divers, there are no data that support this assertion in man. Animal studies are few and give contradictory results (Broome et al., 1995; Leni et al., 2001; Fahlman and Dromsky, 2006; Skogland et al., 2008). We have recently shown that moderate dehydration and hypovolemia induced by a pre-dive exercise might be involved in reducing post-dive circulating bubbles (Blatteau et al., 2007). From the above findings, we hypothesize that moderate dehydration could be beneficial on bubble formation, while severe dehydration appears to increase the risk of DCS. The uptake or release of gas by a particular tissue depends on both the rate of blood flow to the tissue and the rate of gas diffusion into the tissue from blood. It may be seen that if the blood flow is lower, the rate of inert gas uptake would be slower and consequently bubble formation would be reduced (Francis et al, 1990). Dehydration-induced



hypovolemia reduces stroke volume (Jimenez et al., 1999; Blatteau et al., 2007). Because heart rate was unchanged after the sauna session in our study, we hypothesized that blood flow was reduced at the start and during the dive, thus limiting inert gas load and bubble formation afterwards.

#### NITRIC-OXIDE (NO) PATHWAY

It has been demonstrated that endothelial NO, an important vasodilator with anti-atherogenic properties, can attenuate bubble formation and DCS incidence probably by reducing gaseous nuclei from which bubbles form (Wisloff et al., 2003; 2004). We observed a 50% increase in FMD, suggesting an NO-mediated effect on endothelial function after a single sauna session. This was partially reflected in the observed reduction of systolic blood pressure and pulse pressure observed 30 minutes after the sauna. It remains however unclear whether this NO-mediated endothelial function improvement is directly related to the HSP increase, or whether a different process is involved.

#### HEAT-SHOCK PROTEINS

Numerous regulatory pathways may be considered in the real bioprotective mechanisms of HSP (Fig. 5). It is assumed that endothelial nitric oxide synthase is regulated by inducible HSP. Moderate heat shock (core temperature: 42°C, 15 min) in rats increases HSP90 and HSP70 protein levels and vascular eNOS expression (Harris et al., 2003). However, this study also demonstrates that a longer heat exposure (42°C, 1 hour) of endothelial cells results in an increase in eNOS protein content with no change in HSP70 and HSP90 expression, suggesting that the heat-induced change in eNOS expression could be induced by other mechanisms. Recent studies demonstrate in animals models of acute lung injury that the activation of HSP may attenuate the damage caused by oxidative stress in the lung by a direct inhibition of proinflammatory mediators (including adhesion molecules such as ICAM-1), and also by an inhibition in the sequestration of neutrophils in pulmonary capillaries

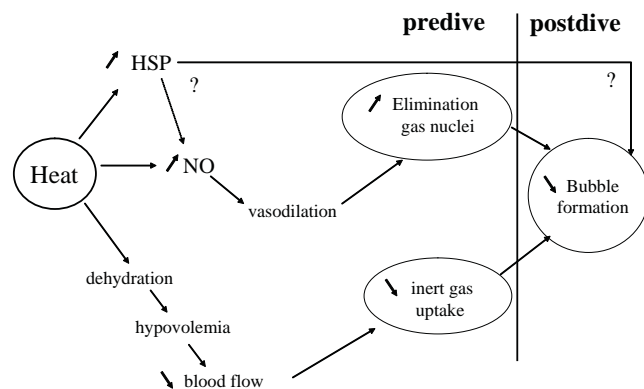

**FIGURE 5. Regulatory pathways of bioprotective HSP mechanisms.**

(Pespeni et al., 2005). From the above findings, the role of HSP appears more related to the attenuation of tissue reaction to vascular bubbles, than in a direct bubble reduction process.

## CONCLUSION

This study shows that a single pre-dive sauna session significantly decreases circulating bubbles after a chamber dive, which may reduce the risk of decompression sickness. Heat exposure induced-dehydration and NO pathway could be involved in this protective effect. It is unclear whether HSP act directly on the bubble formation process or influence the attenuation of tissue reaction to vascular bubbles (Fig. 5). In this way, a pre-dive aerobic exercise performed within 2 hours, including sweat dehydration, a potential increase in body temperature and HSP and a rise in endothelial NO may therefore provide some of the observed benefits as identified in this paper.

#### ACKNOWLEDGMENTS

We would like to thank the participating divers for their patience and sweat (special thanks to Daniel Caturan and Julien Hugon); the students helping out by the experiments (Amandine Caveau and Jennifer Jérôme) and the team of the hyperbaric center Sainte-Anne for their excellent technical assistance during the course of the study. This study was previously published in *Aviation, Space, and Environmental Medicine* (Blatteau J-É, Gempp E, Balestra C, Mets T, Germonpre P. Pre-dive sauna and venous gas bubbles upon decompression from 400 kPa. *Aviat Space Environ Med* 2008; 79:1100–1105).

#### LITERATURE CITED

- Blatteau, J.E., E. Gempp, F.M. Galland, J.M. Pontier, J.M. Sainty, and C. Robinet. 2005. Aerobic exercise 2 hours before a dive to 30msw decreases bubble formation after decompression. *Aviation, Space, and Environmental Medicine* 76:666–669.
- Blatteau, J.E., J.B. Souraud, E. Gempp, and A. Boussuges. 2006. Gas nuclei, their origin, and their role in bubble formation. *Aviation, Space, and Environmental Medicine* 77:1068–1076.
- Blatteau, J.E., A. Boussuges, E. Gempp, J.M. Pontier, O. Castagna, C. Robinet, F.M. Galland, and L. Bourdon. 2007. Haemodynamic changes induced by submaximal exercise before a dive and its consequences on bubble formation. *British Journal of Sports Medicine* 41(6):375–379.
- Broome, J.R., C.L. Kittel, and E.J. Dick. 1995. Failure of pre-dive hydration status to influence neurological DCI rate in pigs. *Journal of Undersea and Hyperbaric Medicine* 22:52.
- Butler, B.D., T. Little, V. Cogan, and M. Powell. 2006. Hyperbaric oxygen pre-breathe modifies the outcome of decompression sickness. *Journal of Undersea and Hyperbaric Medicine* 33:407–417.
- Corretti, M.C., T.J. Anderson, E.J. Benjamin, D. Celermajer, and F. Charbonneau. 2002. Guidelines for the ultrasound assessment of endothelial-dependent flow-mediated vasodilation of the brachial artery: a report of the International Brachial Artery Reactivity Task Force. *Journal of the American College of Cardiology* 39:257–265.
- Dujic, Z., D. Duplancic, I. Marinovic-Terzic, D. Bakovic, V. Ivancev, Z. Valic, D. Eterovic, N.M. Petri, U. Wisloff, and A.O. Brubakk. 2004. Aerobic

- exercise before diving reduces venous gas bubble formation in humans. *Journal of Physiology* 555:637–642.
- Dujic, Z., I. Palada, Z. Valic, D. Duplancic, A. Obad, U. Wisloff, and A.O. Brubakk. 2006. Exogenous nitric oxide and bubble formation in divers. *Medicine and Science in Sports and Exercise* 38:1432–1435.
- Fahlman A., and D.M. Dromsky. 2006. Dehydration effects on the risk of severe decompression sickness in a swine model. *Aviation, Space, and Environmental Medicine* 77(2):102–106.
- Francis, T.J.R., A.J. Dutka, and J.M. Hallenbeck. 1990. Pathophysiology of decompression sickness. In Bove, A.A., and J.C. Davis, eds. *Diving Medicine*. Philadelphia: Saunders. Pp. 170–187.
- Gempp, E., J.E. Blatteau, J.M. Pontier, C. Balestra, and P. Louge. In press. Preventive effect of pre-dive hydration on bubble formation in divers. *British Journal of Sports Medicine* (accepted 2008).
- Harris, M.B., M.A. Blackstone, H. Ju, V.J. Venema, and R.C. Venema. 2003. Heat-induced increases in endothelial NO synthase expression and activity and endothelial NO release. *American Journal of Physiology - Heart and Circulatory Physiology* 285:333–340.
- Harrison, M.H., M.J. Graveney, and L.A. Cochrane. 1982. Some sources of error in the calculation of relative change in plasma volume. *European Journal of Applied Physiology* 50:13–21.
- Huang, K.L., C.P. Wu, and Y.L. Chen. 2003. Heat stress attenuates air bubble-induced acute lung injury: a novel mechanism of diving acclimatization. *Journal of Applied Physiology* 94:1485–1490.
- Jimenez, C., B. Melin, N. Koulmann, A.M. Allevard, J.C. Launay, and G. Savourey. 1999. Plasma volume changes during and after acute variations of body hydration level in humans. *European Journal of Applied Physiology and Occupational Physiology* 80:1–8.
- Kregel, K.C. 2002. Invited review: Heat shock proteins: modifying factors in physiological stress responses and acquired thermotolerance. *Journal of Applied Physiology* 92:2177–2186.
- Leni, P., J.P. Menu, F. Laforest, B. Zouani, and J.L. Méliet. 2001. Extracellular dehydration induces functional motor spinal deficit after severe decompression in the rabbit. *Proceedings of the XXVIIth Annual Meeting of the European Underwater and Baromedical Society*, Hamburg, Germany. pp. 13–17.
- Medby, C. A. Bye, U. Wisloff, and A.O. Brubakk. 2008. Heat shock increases survival in rats exposed to hyperbaric pressure. *Diving and Hyperbaric Medicine* 38(4):189–193.
- Nishi, R.Y., A.O. Brubakk, and O.S. Eftedal. 2003. Bubble detection. In Brubakk, A.O., and T.S. Neuman, eds. *Bennett and Elliot's Physiology and Medicine of Diving*, 5<sup>th</sup> edn. London: WB Saunders. pp. 501–529.
- Njemini, R., C. Demanet, and T. Mets. 2005. Comparison of two ELISAs for the determination of Hsp70 in serum. *Journal of Immunological Methods* 306:176–182.
- Pespeni, M, M. Hodnett, and J.F. Pittet. 2005. In vivo stress preconditioning. *Methods* 35:158–164.
- Skogland, S., L.B. Stuhr, H. Sundland, R.E. Olsen, and A. Hope. 2008. Venous gas emboli in normal and dehydrated rats following decompression from a saturation dive. *Aviation, Space, and Environmental Medicine* 79:565–569.
- Su, C.L., C.P. Wu, S.Y. Chen, B.H. Kang, K.L. Huang, and Y.C. Lin. 2004. Acclimatization to neurological decompression sickness in rabbits. *American Journal of Physiology - Regulatory, Integrative and Comparative Physiology* 287:1214–1218.
- Tei, C., Y. Horikiri, J.C. Park, J.W. Jeong, K.S. Chang, Y. Toyama, and N. Tanaka. 1995. Acute hemodynamic improvement by thermal vasodilation in congestive heart failure. *Circulation* 91(10): 2582–2590.
- Wisloff, U, R.S. Richardson, and A.O. Brubakk. 2003. NOS inhibition increases bubbles formation and reduces survival in sedentary but not exercised rats. *Journal of Physiology* 546(2):577–582.
- . 2004. Exercise and nitric oxide prevent bubble formation: a novel approach to the prevention of decompression sickness? *Journal of Physiology* 555(3):825–829.



# Lack of Signs of Brain Injury in Rats on MRI after Decompression

*Marianne B. Havnes, Marius Widerøe, Marte Thuen, Andreas Møllerløkken, and Alf O. Brubakk*

---

**ABSTRACT.** In serious decompression sickness (DCS Type II), neurological symptoms dominate. However, not much is known about brain injury after decompression. This pilot experiment was done to establish a method for evaluation of central nervous system (CNS) effects of decompression using magnetic resonance imaging (MRI) techniques. Rats were compressed on air in a hyperbaric chamber and decompressed following a decompression profile known to give considerable bubble production. The pulmonary arteries were monitored for bubbles by ultrasound and the brains were scanned by MRI. No signs of injury in the brain were seen on MRI after decompression.

## INTRODUCTION

Decompression sickness is a clinical diagnosis associated with a number of different symptoms. However, in serious decompression sickness (DCS Type II), neurological symptoms dominate (Moon and Gorman, 2003). Francis and Mitchell (2003) state that if emboli are responsible for the pathologic findings in DCS, the brain rather than the spinal cord should be embolized since it constitutes more than 98 % of the mass of human CNS and receives 75-85 times the blood flow of the spinal cord. However, the most common site for Type II DCS is in the spinal cord which is affected in as many as 20-50% of cases that develop Type II DCS (Jallul et al., 2007). The spinal cord white matter is especially vulnerable to bubble formation because nitrogen is highly soluble in myelin in addition to the poor collateral blood supply of the spinal cord (Barratt et al., 2002). Even though damage is more commonly observed in the spinal cord, bubbles seen in the carotid artery in divers 4 hours after decompression raises concern (Brubakk et al., 1986).

Reversibility of blood brain barrier (BBB), cerebral microcirculation, and histological changes after decompression were shown in a study using rats (Nohara and Yusa, 1997). Immediately after decompression there were changes in the brain. These findings were not seen after 1 and 3-6 hours, but reappeared between 48-72 hours after decompression

Histological examinations have also been performed on goats, where *Glial fibrillary acidic protein* (GFAP) immunohistochemistry staining revealed that lesions following decompression sickness in CNS material are more likely to be found in animals exhibiting clinical signs of decompression sickness than those that do not (Woodger et al., 2001). These results are, however, based on 3 out of 17 animals that had signs of DCS and the general conclusion from this study is that there are no significant correlations between DCS and neuropathological lesions in the brain or spinal cord (Blogg et al., 2004). The same conclusion was reached by Mørk et al. (1994), who were unable to detect any neuropathological changes in the spinal cord of 10 amateur divers and 10 experienced divers.

Jallul et al. (2007) reported no signs of MRI abnormalities in the spinal cord or brain of a male human diver from MRI scans taken within 24 hours after injury (paraplegic after recompression). In MRI scans taken three weeks after injury, areas of abnormal high intensity appeared both in the spinal cord and the brain. Another diver with serious neurological DCS had abnormally high signals in the white matter in the brain from MRI scans taken 3 days after the accident. This was not visible on the MRI scan performed 8 weeks after the injury.

Based on the observation that MRIs of divers with DCS show multiple cerebral infarctions in the terminal and border zones of the brain arteries, Kohshi and Wong (2001) proposed that following decompression, arterialized bubbles pass the lungs and heart to the brain.

Ultrasound has previously been applied in order to evaluate vascular gas bubble formation in the vascular system. However, the sensitivity of the method is limited by the resolution of the instrument and the amount and size of bubbles formed. The technology has been well suited for moving bubbles, but lately new ultrasound technology is capable of detecting stationary bubbles as well (Masoy et al., 2008). Thus, MRI would appear to be a superior method. The presence of gas bubbles in the CNS may cause localized inhomogeneity of the magnetic field, that can be detected on  $T_2^*$ -weighted MR images.  $T_2$ -weighted images are commonly used to detect oedema, brain infarctions, and structural changes in the brain.

Manganese-enhanced MRI (MEMRI) has previously been used to detect ongoing ischemic neuronal death from stroke in adult rats (Aoki et al., 2003; 2004) and recent studies suggest that MEMRI can be used to detect inflammatory processes with activated microglia/macrophages and reactive astrocytes in the rat brain (Haapanen et al., 2007; Wideroe et al., 2009; Yang and Wu, 2007). Another MRI technique is Diffusion Tensor Imaging (DTI) where the diffusion of water is measured in several directions in 3 dimensions. This method can be used to differentiate between brain tissues and is particularly useful for visualization and evaluation of white brain matter. Diffusion along the white matter tracts has little restrictions, whereas diffusion perpendicular to the tracts is highly restricted by the myelin sheets and cell walls. This results in fast diffusion mainly along the tracts and can be calculated and expressed as a high Fractional Anisotropy (FA). A change or difference in FA value in a white matter area indicates axonal damage or rearrangement (Mori and Zhang, 2006).

In the present preliminary study, injury to the brain after decompression was investigated with MRI and ultrasound. Our hypothesis was that neurological decompression sickness (Type II DCS) is caused by the organism's response to vascular gas bubbles. It follows that if vascular gas bubble formation can be reduced or eliminated, neurological DCS will be less likely to occur and also reduce the risk of long term sequelae. Previous studies have demonstrated that vascular bubble formation can be significantly reduced or eliminated by physical exercise and nitric oxide in rat, pig, and man (Dujic et al.,

2004; Mollerlokken et al., 2006; Wisloff and Brubakk, 2001; and Wisloff et al., 2004).

## METHODS

A total of 9 rats were compressed on air in a hyperbaric chamber and decompressed following a decompression profile known to give considerable bubble production. Ultrasound was used to monitor and grade bubbles in the pulmonary artery for 30 minutes after decompression, using the grading method of Eftedal and Brubakk (1997). Five animals served as controls on the MRI scan.

After observation the rats were transferred to the MR Facility, NTNU. Before the MRI acquisition, the rats were anesthetized (4% isoflurane induction) and a 25 Ch neoflon was inserted in the tail vein of the rats. MRI was performed on a 7 Tesla magnet (Biospec 70/20 AS, Bruker Biospin MRI, Ettlingen, Germany) with water-cooled (BGA-12, 400 mT/m) gradients. A 72-mm volume resonator was used for RF transmission and an actively decoupled rat head surface coil was used for RF reception (Bruker Biospin MRI). During scanning the anaesthetized (2% isoflurane in 30%  $O_2$ , 70%  $N_2$ ) rats lay prone in the dedicated water-heated rat bed and the head of every animal was fixed in the same position with inbuilt earplugs, tooth bar and nose-mask. This assured the same placement of the head of the animals within the magnet from scan to scan.

After a gradient echo FLASH pilot scan (acquisition time 1 min) a series of  $T_2^*$ -weighted images were obtained using a Multi-gradient echo (MGE) sequence with the following parameters: TE = 4/11/18/25/32/39/46/53/60/67/74/81 ms; TR = 1650 ms; 2 averages; Acquisition time 7 min 55 sec.  $T_2$ -maps were then obtained using a RARE sequence with RARE-factor = 4; TE = 25/50/75 ms; TR = 4000 ms; 3 averages; Acquisition time 7 min 12 sec. Apparent Diffusion Coefficient maps were obtained using a Echo Planar Imaging (EPI) sequence with 3 directions and 6 b-values (100/200/400/600/800/1000 ms); TE = 53.47 ms; TR = 3000 ms; 6 averages; Acquisition time 8 min 24 sec. For all these scans 17 coronal slices were acquired with slice thickness of 1 mm. The field of view (FOV) was 40 × 30 mm and the acquisition matrix (MTX) was 256 × 144 giving an isotropic in-plane resolution of 156 × 156  $\mu m^2$ .

The animals were then returned to the animal facility and closely observed for any signs of decompression sickness. The next day, animals were injected with a single dose of 40 mg  $MnCl_2$  (# 7773-01-5, Sigma-Aldrich Inc., St. Louis, USA) per kg bodyweight (~318  $\mu mol Mn^{2+}/kg$ ) at a concentration of 100 mM intraperitoneally to serve as MRI contrast for later scans.

Surviving animals were returned to the MR Facility after 7 and 14 days for new MRIs. At both time-points  $T_2$ -maps and  $T_2^*$ -weighted images were acquired with the same parameters as described above. To evaluate manganese-uptake and inflammation a 3D data set was obtained on day 7 using a  $T_1$ -weighted gradient echo FLASH sequence with flip-angle = 30°, TR = 12 ms, TE = 3.25 ms. FOV = 30 × 35 × 20 mm and acquisition



matrix was  $192 \times 168 \times 96$  with zero-filling to  $192 \times 224 \times 128$ , the interpolated resolution was  $156 \mu\text{m}$  isotropic. Acquisition time was 52 min with 16 averages. The B1-field of the volume-coil was considered homogeneous within the field of view, while the spatially inhomogeneous sensitivity of the surface-coil used in the 3D  $T_1$ -weighted FLASH acquisition was corrected for using two additional scans in coupled and single coil operation: 3D  $T_1$ -weighted FLASH sequences: Flip-angle =  $30^\circ$ , TR = 12 ms, TE = 3.25 ms, matrix size  $32 \times 32 \times 32$ , acquisition-time was 2 min for each scan. FOVs were the same as those used to obtain the 3D data set.

On both 7 and 14 days after the decompression, Diffusion-tensor imaging (DTI) was performed to evaluate specific white matter injury and to look for changes in white matter. The DTI was acquired with an EPI sequence using 30 directions and  $b = 1000$  ms; 5  $b_0$  images and FOV =  $40 \times 40$  mm; MTX =  $172 \times 172$  giving a resolution of  $233 \times 233 \mu\text{m}^2$ . On day 7 TE = 37.5; TR = 3000 ms; 17 slices at 1 mm were acquired with 2 averages giving an acquisition time of 14 min. On day 14 TE = 37.5; TR = 5000 ms; 33 slices at 0.5 mm were acquired with 6 averages giving an acquisition time of 1 hr 10 min.

## RESULTS

### BUBBLE FORMATION AND CLINICAL SIGNS

A total of 9 rats were decompressed, of which 3 died and 6 had bubble grades from 2 to 4. Three rats died because of considerable amounts of bubbles, two rats died immediately after the dive, and a third rat had neurological symptoms of DCS in the form of paralysis of the hind legs and died after the first MRI scan. The remaining six animals had no clinical symptoms.

### MAGNETIC RESONANCE IMAGING

Localized reduction of signal intensity was seen as stripes through the cortex as well as in the areas corresponding to the main cerebral arteries on the  $T_2^*$  images (Fig. 1). These findings were more pronounced in the rats exposed to decompression. Such signal reduction on  $T_2^*$ -weighted images are normally related to increased amounts of deoxygenated haemoglobin in the blood. However, air bubbles in the blood may also cause the same effect due to a local disturbance of the magnetic field.

Neither ADC-maps nor  $T_2$ -maps showed any signs of oedema immediately after decompression. There were also no signs of oedema, infarctions or structural changes at later time points assessed by the  $T_2$  images (Fig. 2). Diffusion-tensor images in some of the rats (in both groups) showed reduced fractional anisotropy in the external capsule, indicative of injury to the white matter tracts (Fig. 3). However, the relative sensitivity of this particular area to imaging artefacts makes this a most uncertain finding. The high-resolution 3D  $T_1$ -weighted images acquired on day 7 after decompression showed no sign of structural

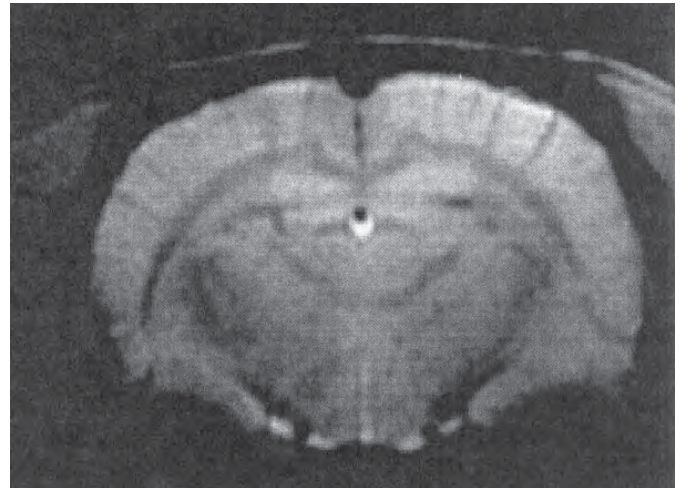

**FIGURE 1.**  $T_2^*$ -map of a decompressed rat. Localized reduction of signal intensity was seen as stripes through the cortex as well in the areas corresponding to the main cerebral arteries on the images.



**FIGURE 2.**  $T_2$ -map of brain of a decompressed rat. No signs of damage or oedema can be seen.

changes, infarctions, or manganese uptake that could suggest ongoing inflammatory processes.

The histological investigation of the brain has not yet been performed.

## DISCUSSION

This pilot experiment was done to establish a method for evaluating CNS effects of decompression using MRI techniques. The fact that we could not see any oedema or damage on the MRI may suggest that the decompression experienced was insufficient to cause any damage to the brain. On the other hand, injury to the brain caused by decompression may have been too subtle to be detected using the current MRI methods. Further evaluation of the experiment using immunohistochemical

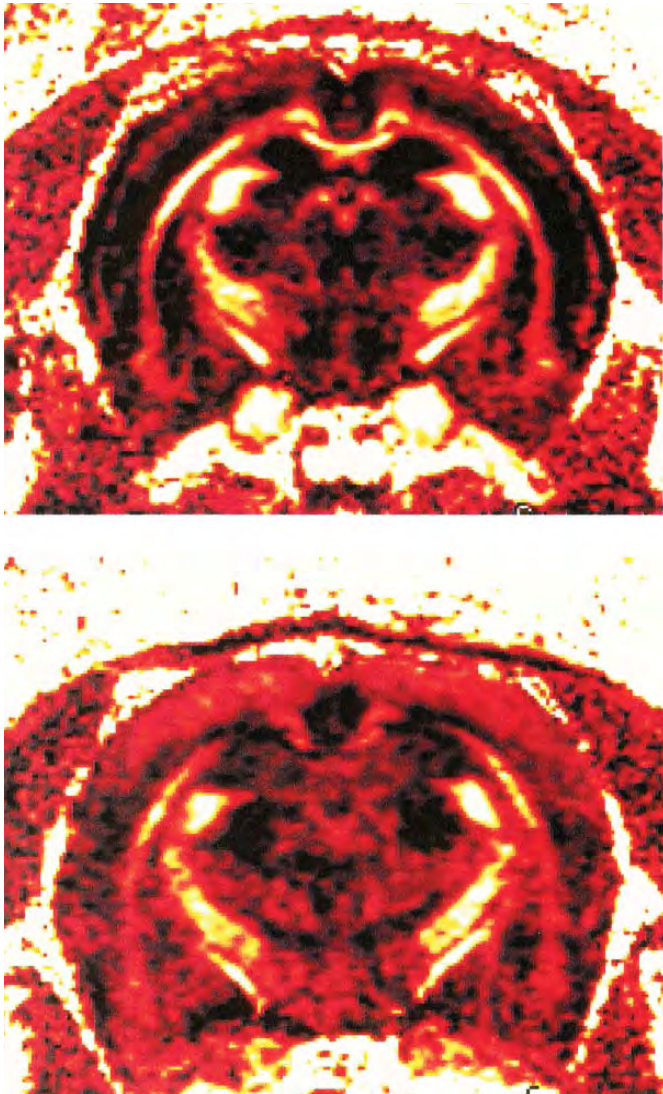

**FIGURE 3. Fractional Anisotropy (FA) maps of two rat brains. A. Top: Control animal shows intact white matter with high FA values (bright areas). B. Bottom: 1 week post-decompression shows a reduced fractional anisotropy in the external capsule and corpus callosum, indicative of injury to the white matter tracts, but may also represent imaging artefacts and needs further investigation.**

investigations might be able to provide us with more information on the effect of decompression on rat brain function and validate the MRI results.

In spite of a considerable amount of vascular gas bubbles detected in the pulmonary artery and clinical signs of neurological DCS in one rat, the preliminary results show no brain damage after decompression. However, there was a signal reduction on  $T_2^*$ -weighted images. This is normally related to increased amounts of deoxygenated haemoglobin in the blood, but air bubbles in the blood may also cause the same effect, due to a local disturbance of the magnetic field. It has previously been shown that if tissue oxygenation falls critically low,

this can lead to blood-brain barrier dysfunction, inflammation, demyelination, and eventually, axonal damage (James, 2007). It is tempting to speculate whether repeated diving with low levels of oxygen in brain tissue would give the latter damages.

The number of experimental animals is low. Still, these results raise questions whether the rats have a protective mechanism in the brain against bubbles or whether bubbles constitute any threat at all. It is possible that the major damage is in the spinal cord, as has been shown in some human studies. Human divers have reported pains and problems caused by decompression, like loss of concentration, blurred vision, and other problems that are possibly caused by injuries to the brain. It is possible that these changes in the brain are too subtle to be observed in MRI scans or that develop over time with repeated diving.

Evidence of brain damage caused by decompression is conflicting. Bubbles observed in the carotid artery may lead to injury (Brubakk et al., 1986), but a number of MRI studies show no visible damage to the brain after decompression in divers and animals (Hutzelmann et al., 2000; Rinck et al., 1991; Yoshiyama et al., 2007). Erdem et al. (2009) proposed that higher incidence of lesions in the cerebral white matter of divers is evidence of cumulative, subclinical injury to the neurological system that may affect the long-term health of military and recreational divers.

## CONCLUSION

The number of animals in this study is too low to draw any conclusion whether the MRI is a useful method to study brain injury after decompression in rats. No histology of the brains of these animals has yet been performed. To properly investigate the role of vascular gas bubbles in neurological decompression sickness it is necessary to perform further experiments with better control of the size and location of the possible damage.

The mechanisms behind decompression sickness are complex and the individual susceptibility for the disease is diverse. In order to study the effect of decompression on CNS we have to know that CNS is affected. By injecting air bubbles in appropriate amounts directly into the carotid artery, we can ensure that there are bubbles directed into the circulation of the brain. In order to visualize the acute effect of bubbles, one can perform the injection during the MRI scan. Histology should also be prepared to investigate more subtle changes.

## LITERATURE CITED

- Aoki, I., S. Naruse, and C. Tanaka. 2004. Manganese-enhanced magnetic resonance imaging (MEMRI) of brain activity and applications to early detection of brain ischemia. *NMR in Biomedicine* 17(8):569–580.
- Aoki, I., T. Ebisu, C. Tanaka, K. Katsuta, A. Fujikawa, M. Umeda, M. Fukunaga, T. Takegami, E.M. Shapiro, and S. Naruse. 2003. Detection of the anoxic depolarization of focal ischemia using manganese-enhanced MRI. *Magnetic Resonance in Medicine* 50(1):7–12.
- Barratt, D.M., P.G. Harch, and K. Van Meter. 2002. Decompression illness in



- divers: a review of the literature. *Neurologist* 8(3):186–202.
- Blogg, S.L., G.A. Loveman, F.M. Seddon, N. Woodger, A. Koch, M. Reuter, M. Gennser, and M.G. White. 2004. Magnetic resonance imaging and neuropathology findings in the goat nervous system following hyperbaric exposures. *European Neurology* 52(1):18–28.
- Brubakk, A.O., R. Peterson, A. Grip, B. Holand, J. Onarheim, K. Segadal, T.D. Kunkle, and S. Tonjum. 1986. Gas bubbles in the circulation of divers after ascending excursions from 300 to 250 msw. *Journal of Applied Physiology* 60(1):45–51.
- Dujic, Z., D. Duplancic, I. Marinovic-Terzic, D. Bakovic, V. Ivancev, Z. Valic, D. Eterovic, N.M. Petri, U. Wisloff, and A.O. Brubakk. 2004. Aerobic exercise before diving reduces venous gas bubble formation in humans. *Journal of Physiology* 555(3):637–642.
- Eftedal, O., and A.O. Brubakk. 1997. Agreement between trained and untrained observers in grading intravascular bubble signals in ultrasonic images. *Journal of Undersea and Hyperbaric Medicine* 24(4):293–299.
- Erdem, I., S. Yildiz, G. Uzun, G. Sonmez, M.G. Senol, M. Mutluoglu, H. Mutlu, and B. Oner. 2009. Cerebral white-matter lesions in asymptomatic military divers. *Aviation, Space, and Environmental Medicine* 80(1):2–4.
- Francis, T.J.R., and S.J. Mitchell. 2003. Pathophysiology of Decompression Sickness. In: Brubakk, A.O., and T.S. Neuman, eds. *Bennett and Elliott's Physiology and Medicine of Diving* (5th ed) London: Saunders. pp. 530–557.
- Haapanen, A., U.A. Ramadan, T. Autti, R. Joensuu, and J. Tyynela. 2007. *In vivo* MRI reveals the dynamics of pathological changes in the brains of cathepsin D-deficient mice and correlates changes in manganese-enhanced MRI with microglial activation. *Journal of Magnetic Resonance Imaging* 25(7):1024–1031.
- Hutzelmann, A., K. Tetzlaff, M. Reuter, S. Muller-Hulsbeck, and M. Heller. 2000. Does diving damage the brain? MR control study of divers' central nervous system. *Acta Radiologica* 41(1):18–21.
- Jallul, S., A. Osman, and W. El-Masry. 2007. Cerebro-spinal decompression sickness: report of two cases. *Spinal Cord* 45(1):116–120.
- James, P.B. 2007. Hyperbaric oxygenation in fluid microembolism. *Neurological Research* 29(2):156–161.
- Kohshi, K., and R.M. Wong. 2001. [Central nervous system involvement in decompression illness]. *No To Shinkei [Brain and Nerve]* 53(8):715–722.
- Masoy, S.E., O. Standal, P. Nasholm, T.F. Johansen, and B. Angelsen. 2008. SURF imaging: *in vivo* demonstration of an ultrasound contrast agent detection technique. *IEEE Transactions on Ultrasonics, Ferroelectrics, and Frequency Control* 55(5):1112–1121.
- Mollerlokken, A., V.J. Berge, A. Jorgensen, U. Wisloff, and A.O. Brubakk. 2006. Effect of a short-acting NO donor on bubble formation from a saturation dive in pigs. *Journal of Applied Physiology* 101(6):1541–1545.
- Moon, R.E., and D.F. Gorman. 2003. Treatment of the Decompression Disorders. In: Brubakk, A.O., and T.S. Neuman, eds. *Bennett and Elliott's Physiology and Medicine of Diving* (5th ed) London: Saunders. pp. 600–651.
- Mori, S., and J. Zhang. 2006. Principles of diffusion-tensor imaging and its applications to basic neuroscience research. *Neuron* 51(5):527–539.
- Mork, S.J., I. Morild, A.O. Brubakk, S. Eidsvik, and H. Nyland. 1994. A histopathologic and immunocytochemical study of the spinal cord in amateur and professional divers. *Journal of Undersea Hyperbaric Medicine* 21(4):391–402.
- Nohara, A., and T. Yusa. 1997. Reversibility in blood-brain barrier, microcirculation, and histology in rat brain after decompression. *Journal of Undersea Hyperbaric Medicine* 24(1):15–21.
- Rinck, P.A., R. Svihus, and P. de Francisco. 1991. MR imaging of the central nervous system in divers. *Journal of Magnetic Resonance Imaging* 1(3):293–299.
- Wideroe, M., O. Olsen, T.B. Pedersen, P.E. Goa, A. Kavelaars, C. Heijnen, J. Skranes, A.M. Brubakk, and C. Brekken. 2009. Manganese-enhanced magnetic resonance imaging of hypoxic-ischemic brain injury in the neonatal rat. *Neuroimage* 45(3):880–890.
- Wisloff, U., and A.O. Brubakk. 2001. Aerobic endurance training reduces bubble formation and increases survival in rats exposed to hyperbaric pressure. *Journal of Physiology* 537(2):607–611.
- Wisloff, U., R.S. Richardson, and A.O. Brubakk. 2004. Exercise and nitric oxide prevent bubble formation: a novel approach to the prevention of decompression sickness? *Journal of Physiology* 555(3):825–829.
- Woodger, N., A.C. Palmer, and W.F. Blakemore. 2001. A double-blind study of the neuropathology in goats exposed to hyperbaric conditions. Off-shore Technology Report 2001/090. Suffolk: Health and Safety Executive Books. 28 pp.
- Yang, J., and E.X. Wu. 2007. Manganese-enhanced MRI detected the gray matter lesions in the late phase of mild hypoxic-ischemic injury in neonatal rat. *Conference Proceedings IEEE Engineering in Medicine and Biology Society*. pp. 51–54.
- Yoshiyama, M., S. Asamoto, N. Kobayashi, H. Sugiyama, H. Doi, H. Sakagawa, and M. Ida. 2007. Spinal cord decompression sickness associated with scuba diving: correlation of immediate and delayed magnetic resonance imaging findings with severity of neurologic impairment - a report on 3 cases. *Surgical Neurology* 67(3):283–287.



# Exercise, Endothelium, and Diving Physiology

*Željko Dujic*

---

**ABSTRACT.** Generally, the idea that exercising before, during and after diving is not advised is based on the assumption that it would increase the incidence of decompression sickness. Our data show that exercise performed before or during diving results in a reduction of venous gas bubble formation after diving. Pre-dive administration of an acute nitric oxide donor had the same effect. Exercise performed after diving did not increase the number of gas bubbles and there was no evidence for an increased risk for right-to-left intrapulmonary shunting. In addition, we have shown that open sea single air dives may be associated with arterial endothelial dysfunction and right heart overload due to increased pulmonary artery pressure. Some of these asymptomatic cardiovascular changes may last for several days after the dive and may be attenuated by acute or chronic antioxidant administration (vitamin C and E). Long-term consequences of acute subclinical cardiovascular alterations induced by diving are presently unknown and will be a goal for future research efforts. Understanding the mechanisms of acute adverse effects of diving on human physiology may also contribute to the therapeutic options aimed at the improvement of cardiovascular health in patients and in the general population.

## INTRODUCTION

Ideas and views about the effects of diving on humans in relation to exercise, endothelial, and heart function were presented at the Haldane Symposium in Trondheim, Norway. Recent information was reviewed on the effect of exercise before, during, and after diving on gas bubble formation that occurs after surfacing, as well as the acute changes in cardiovascular function after single, open-water, compressed air dives. Our recent studies (Dujic et al., 2004) have shown that pre-dive exercise and exercise performed during a decompression stop (Dujic et al., 2005b) may significantly reduce bubble formation. These findings are important because venous gas bubbles (VGB) can be found in the vasculature and the right heart after the majority of recreational and professional dives and are statistically related with central nervous system decompression sickness (DCS), especially if a large amount of bubbles is found in the pulmonary artery (Nishi et al., 2003). VGB, when occurring without any acute clinical signs, have been termed “silent bubbles” (Behnke, 1951) and have in general been assumed not to have any negative effects. However, vascular bubbles will lead to a reduction of endothelial function in the pulmonary artery of the pig (Nossum et al., 1999) and the brachial artery in man (Brubakk et al., 2005), even without the passage of bubbles through the pulmonary circulation. Endothelial dysfunction represents one of the earliest events in the pathogenesis of cardiovascular disease and is observed in several clinical conditions. Keeping in mind that scuba diving is performed regularly by millions of recreational and professional divers worldwide and that the diving population is often older and may include unfit individuals or even individuals with some diseases such as hypertension, the potential acute or



long-term negative cardiovascular effects of diving on human health is disturbing and must be focused on by the medical and general communities.

## DETECTION OF VENOUS GAS BUBBLES BY ULTRASOUND

VGB in the pulmonary artery and the right heart can be monitored with the use of ultrasound, both by Doppler (Nishi et al., 2003) and/or echocardiographic imaging (Eftedal and Brubakk, 1997). Both methods have been proven valid for indicating the risk of DCS after dives (Sawatzky, 1991; Eftedal et al., 2007). Ultrasound images are graded according to a previously reported method (Eftedal and Brubakk, 1997) as follows: 0 – no bubbles, 1 – occasional bubbles, 2 – at least one bubble/4<sup>th</sup> heart cycle, 3 – at least one bubble/cycle, 4 – continuous bubbling, at least one bubble/cm<sup>2</sup> in all frames and 5 – “white-out”, individual bubbles cannot be seen (this grade had been previously observed only in animals). The grading system is non-linear when compared to the actual number of bubbles in the pulmonary artery and bubble grades can be converted into bubbles/cm<sup>2</sup> as described by Nishi et al. (2003).

Bakovic et al. (2008) were the first to report recently a case of a recreational diver who developed grade 5 (“white-out”) in the right heart with evidence of intrapulmonary (I-P) shunt resulting in grade 4 VGB in the left heart during resting condition, but still without any symptoms of DCS (Fig. 1). The diver had no evidence of patent foramen ovale as documented by contrast transesophageal echocardiography (Fig. 2). This case indicates that even extremely high bubble grade may not be related to an increased incidence of DCS. However, as stated above, the statistical relationship between detectable bubbles and the risk of DCS is well documented. Based on the well known and agreed

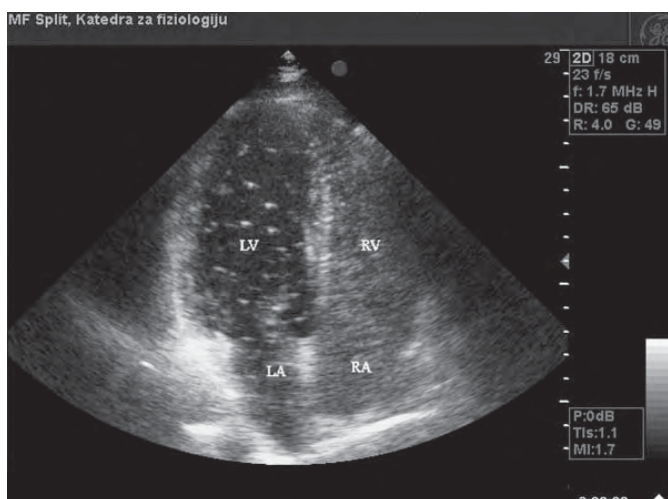

FIGURE 1. Echocardiographic apical four-chamber view of the heart representing right ventricle (RV) (grade 5) and left ventricle (LV) (grade 4) gas bubbles at 40 min after surfacing. RA right atrium; LA left atrium.

upon mechanism for decompression problems (gas bubble formation), we believe that the absence of VGB is a good indicator of decompression safety and that it is important to work on the procedures that reduce bubble formation after diving.

## EXERCISE AND DIVING

The effect of exercise before, during and after diving on bubble formation is still controversial. Exercise, which is an inherent part of professional diving, has long been considered to be an additional risk factor for DCS (Cook, 1951). Diving is associated with exercise of variable intensity, depending on ocean currents, temperature, and stress. Therefore, divers are exposed from a mild to moderate level of exercise intensity, with possible short periods of submaximal or even maximal effort. Intensive exercise immediately before diving may produce microscopic muscular injuries, which may promote bubble formation (Vann et al., 1989).

We recently found that a single bout of high-intensity exercise interval training performed 24 hours before a dive significantly reduced the number of bubbles in the right heart (Dujic et al., 2004) (Fig. 3). Blatteau et al. (2005) reported a similar finding recently for exercise performed 2h before a dive. These results are in concordance with previous studies performed in rats which suggested that there appears to be “good” and “bad” exercise (Wisloff and Brubakk, 2001). According to this model, the timing of the pre-dive exercise is critical: if it is too close (0.5h, 5h and 10h) or too far (48h) from the dive, the beneficial effects will disappear (Wisloff et al., 2004). Furthermore, the beneficial effect of properly timed pre-dive exercise partially depends on nitric oxide (NO) as shown by studies using some forms of NO inhibitors. Namely, despite NO-blockade, exercise

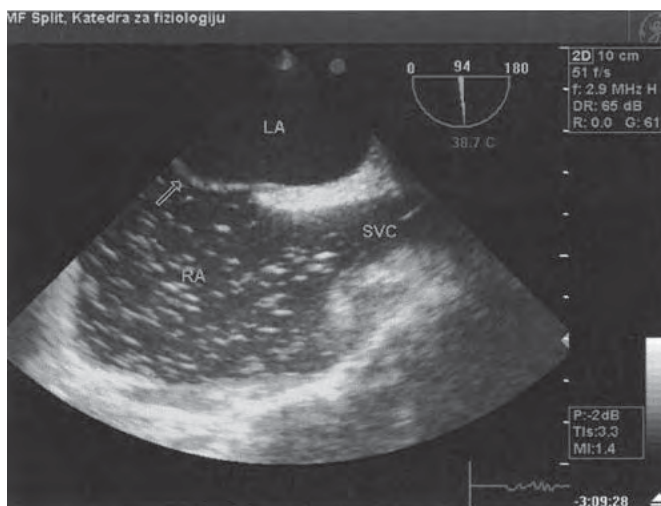
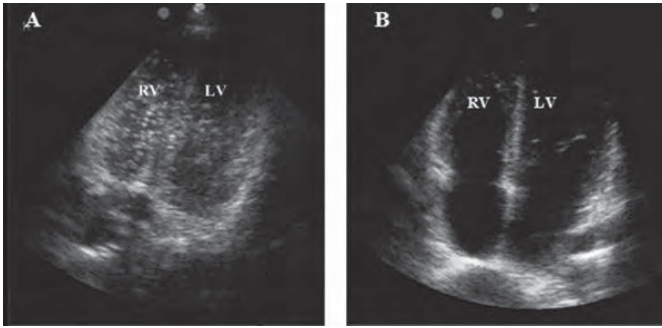

FIGURE 2. Transesophageal echocardiographic view of the heart using a contrast agent. Figure reveals intraatrial septum (arrow) without visible defects and presence of contrast agent solely in the right atrium (RA) during the Valsalva maneuver. LA left atrium; SVC superior vena cava.



**FIGURE 3.** The figure depicts change in venous gas bubbles within the right heart and pulmonary artery following a dive without (A) and with (B) a previous bout of strenuous exercise in one diver. In (A), there are numerous, clearly visible venous gas bubbles. After performing the exercise, bubbles are completely absent (B).

still provided some protection, although to a reduced degree, indicating NO-dependent and NO-independent components of that mechanism. Furthermore, both acute and chronic NO-donors protected against bubble formation and reduced the death rate in rats (Wisloff et al., 2003; Wisloff et al., 2004), without performing exercise. This was subsequently confirmed in man (Dujic et al., 2005b).

The uptake and elimination of inert gas depends on local blood flow. Exercise performed during the bottom phase of a dive will increase blood flow and consequently nitrogen uptake because of active hyperemia in skeletal muscles (Flook, 1997). With more nitrogen dissolved in the tissues the time for its elimination should be extended. Dick et al. (1984) have shown that more nitrogen is indeed eliminated after a dive with exercise during the bottom phase. However, when mild exercise was performed during a decompression stop, the number of VGB detected after diving was reduced, likely due to increased gas elimination via augmented alveolar ventilation caused by the physical activity (Jankowski et al., 1997; Dujic et al., 2005b). The positive effects of a rather short, 3-minute exercise period during a decompression stop suggests that the nitrogen pool for bubble formation is coming from the “faster” tissues.

Furthermore, in a subsequent study we have shown that post-dive, high intensity exercise did not increase the risk for DCS, but rather caused an 8-fold reduction in bubble formation. This was somewhat surprising since we hypothesized that it would promote venous bubble formation, based on the previous reports of increased nitrogen elimination with post-dive exercise after simulated dives to 20 msw (Muth et al., 1994). These inconsistencies may potentially be explained with the differences in type of diving (open water versus simulated) and the exercise intensity (high versus moderate). The most likely cause of reduced bubble formation observed during post-dive exercise is the increased blood flow induced by exercise which may cause a depletion of bubble nuclei at the surface of endothelial cells, without which bubbles cannot grow.

Eldridge et al. (2004) have shown that exercise-induced intrapulmonary a-v shunting occurs in healthy humans. Because

pulmonary circulation acts as a filter to prevent spill-over of venous bubbles to the arterial side, the next question was: is there a right-to-left shunting of gas bubbles through pulmonary circulation during exercise after the dive? We have repeated the study of Eldridge et al. (2004) with the same high-intensity cycle exercise after diving and found no evidence of right-to-left shunting of “endogenous” bubbles versus contrast bubbles. We speculated that a bolus application of agitated contrast may acutely overwhelm the filtering capacity of pulmonary microcirculation and open the I-P shunts. Thus, we suggest that the paradoxical results observed in our study are related to lower bubble load. Dujic et al. (2008) recently reviewed more detailed information on the relationship between exercise and diving.

In summary, the true cause of the beneficial effect of pre-, during and post-dive exercise remains elusive and very poorly understood. Other effects of exercise must be considered as well in future studies (e.g., endothelial function, NO, and heat shock proteins).

## CARDIOVASCULAR FUNCTION AFTER DIVING

This overview of the current knowledge of the effects of diving on the cardiac function and endothelium of the conduit arteries focuses on the findings from recent studies performed in the field and simulated (hyperbaric chamber) diving conditions. We believe that diving research should be performed, whenever possible, under open water conditions in order to include the additional stressors such as immersion, exercise, cold, weight of the breathing apparatus, hemoconcentration and psychological factors, which are usually present during routine diving activities.

The data on cardiovascular effects of simulated versus open water diving in humans is controversial. Diesel et al. (2002) showed a lack of increase in systolic pulmonary artery pressure (SPAP) after simulated altitude decompressions induced high grade venous gas bubbles. Valic et al. (2005) have confirmed this finding after a simulated chamber dive. The results of human studies seem to contradict the animal data that reported increased PAP (Vik et al., 1993). In addition, we have recently found that a single open water air dive is associated with acute, post-dive depressions in lung respiratory function and cardiac output (Dujic et al., 2005a). Marabotti et al. (1999) have also found that a recreational scuba dive impairs the cardiac performance within two hours after surfacing, suggesting a right ventricular overload and an impairment of both right and left ventricular diastolic function. In contrast to our findings obtained during a dry dive, we observed an increase in the PAP and pulmonary vascular resistance (PVR) after a single open water air dive to 30 m (Dujic et al., 2006) (Fig. 4).

The increased PAP and PVR were not expected to cause any clinical symptoms, bearing in mind the large functional reserve in the pulmonary circulation. The exact mechanism(s) of increased PVR after diving is still unknown. VGB lodged

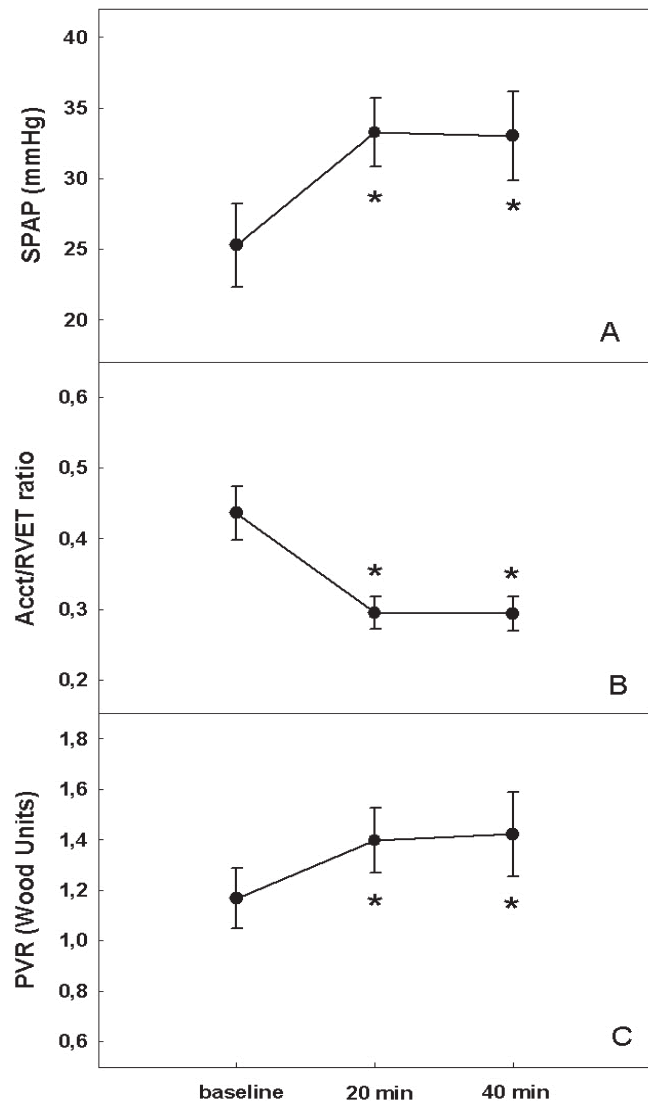

**FIGURE 4.** Changes in systolic pulmonary arterial pressure (SPAP). (A) Acct/RVET ratio; (B) Pulmonary vascular resistance (PVR); and, (C) at 20 and 40 min after dive. Values are mean  $\pm$  SD; \*,  $P < 0.05$  compared to baseline.

in the pulmonary circulation may cause mechanical, humoral, and biochemical effects. Humoral factors, like thromboxane  $A_2$ , histamine, endothelin-1, and serotonin have been implicated in pulmonary microembolization by bubbles (Malik, 1983). Nossum et al. (2002) have shown that venous bubbles may damage the pulmonary endothelium, which may also result in pulmonary vasoconstriction.

Nossum et al. (1999) also reported that vascular bubbles led to a reduction in endothelial function in pig pulmonary artery and that even a low bubble load was associated with a delayed endothelial dysfunction in rabbit 1-6 hours after exposure (Nossum et al., 2002). Since venous bubbles are trapped in the pulmonary circulation, they were assumed to have no further effects on the arterial side. It was also assumed that a

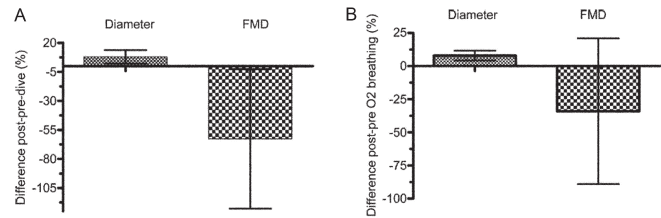

**FIGURE 5.** (A) Difference in brachial artery diameter and flow-mediated dilatation (FMD) before and after the dive. (B) Difference in brachial artery diameter and FMD before and after breathing 60% O<sub>2</sub>. The data are the mean and 95% confidence intervals.

right-to-left shunt (R-to-L), which occurs due to a persistent foramen ovale (PFO), was necessary for the bubbles to affect the systemic arteries. In that regard, we found a post-dive (both dry and field) increase in the brachial artery diameter and a reduction in the arterial endothelial function (assessed by flow-mediated dilatation). Although no large PFO was detected, the possibility of a significant number of gas bubbles in the arterial circulation was not very likely (Brubakk et al., 2005; Obad et al., 2007) (Fig. 5).

One explanation for this effect is a diving-induced activation of the endothelium which may, as shown by other investigators, lead to a production of endothelial microparticles and further endothelial damage and dysfunction, even at remote sites (Brodsky et al., 2004). Endothelial microparticles have a size of a few microns and could possibly pass the lung filter and enter the arterial system. Thus, it is possible that changes in the endothelial function can occur without the arteries being in direct contact with the gas bubbles. Next, we analyzed the effects of pre-dive administration of antioxidant agents since it was shown that hyperoxia per se (without diving) caused FMD reduction (Obad et al., 2007). Pre-dive ingestion of high doses of vitamins C and E (2 grams and 400 IU, respectively) in a randomized placebo-controlled study design partially reversed the endothelial dysfunction after a dive (Fig. 6), while changes in pulmonary artery and heart function were unaffected. It was also found that FMD, previously shown to be reduced up to 48 hours after a single open water air dive, was better preserved in this case and recovered faster.

## SUMMARY AND IDEAS FOR FUTURE STUDIES

The ideas presented above suggest the following:

1. Another means for reducing the number of venous gas bubbles after air diving may include exercising before, during decompression and after diving, and administering acute NO donors before the dive. Additional mechanistic studies on large numbers of divers should be performed in the future in order to complement current findings;
2. Asymptomatic cardiovascular and arterial endothelial

dysfunction detected after diving lasts for several days after a single open water dive. Long-term effects are presently unknown; and,

3. Acute and long-term use of antioxidants may contribute to prevention of some of these effects (endothelial function).

Based on the abovementioned findings, it seems that high-intensity, pre-dive exercise and moderate exercise performed during decompression stops would appear to be a wise prescription for reducing the number of venous gas bubbles after air dives. However, before these procedures can be widely adopted as a predictable safeguard against DCS we need further standardization related to the exercise's duration and intensity. Pharmacological intervention with an acute NO donor such as nitroglycerine seems to complement this procedure.

Despite a wealth of information about the physiological consequences of scuba diving gathered during the last several years, many more questions need to be answered in the future such as:

1. Is pre-dive exercise beneficial under field conditions for endothelial function, cardiovascular function, or prevention of bubble formation? What mechanisms are involved in this phenomenon (NO, heat shock proteins, vasoactive substances such as endothelin-1, angiotensin II, etc.)?

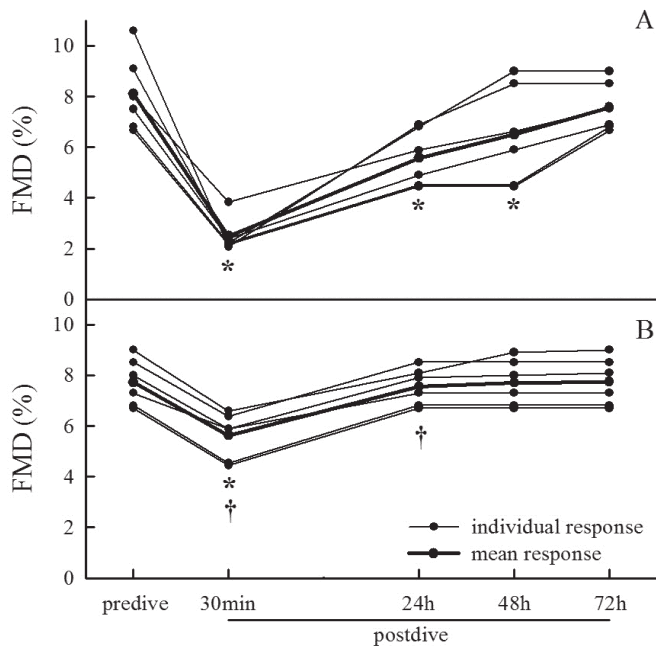

**FIGURE 6. Flow-mediated dilatation (FMD) at pre-dive and post-dive (30 min, 24 h, 48 h and 72 h) periods for control dive (A) and dive after application of antioxidants (B) in protocol 2. Values are represented as individual responses (thin lines) and mean response (thick line) for both dives; \*, significant difference ( $P < 0.05$ ) between pre-dive and post-dive values; †, significant difference ( $P < 0.05$ ) between dives with and without antioxidant treatment.**

2. What are the cumulative effects of multi-day air or trimix diving?
3. What are the long-term effects of diving on the cardiovascular system?
4. Does age and gender (especially female) make any difference?
5. What about genetics of DCS susceptibility and resistance (significance of genetic studies and analyses, detection of candidate genes' polymorphism - like eNOS)?

Understanding the involved mechanisms is a next critical step that may ultimately allow us to prevent DCS by various pharmacological means. Last, but not least, after completion of these planned studies we have to ask ourselves "what do the ideas and data presented above fail to explain?"

#### ACKNOWLEDGMENTS

The author's work on this topic was supported by numerous grants awarded by the Croatian Ministry of Science, Education and Sports (currently with 216-2169133-0130) and the Unity through Knowledge Fund project 33/08. The author would like to thank many collaborators over the years, and especially Dr. Alf O. Brubakk, who in 2001 visited Split and first suggested to test the physiological effects of pre-dive, high-intensity exercise on humans after diving.

#### LITERATURE CITED

- Bakovic, D., D. Glavas, I. Palada, T. Breskovic, D. Fabijanic, A. Obad, Z. Valic, A.O. Brubakk, and Z. Dujic. 2008. High-grade bubbles in left and right heart in an asymptomatic diver at rest after surfacing. *Aviation, Space, and Environmental Medicine* 79:626-628.
- Behnke, A.R. 1951. Decompression sickness following exposure to high pressures. In Fulton, J.F. (ed.). *Decompression Sickness*. Saunders: Philadelphia. pp. 53-89.
- Blatteau, J.E., E. Gempp, F.M. Galland, J.M. Pontier, J.M. Sainty, and C. Robinet. 2005. Aerobic exercise 2 hours before a dive to 30 msw decreases bubble formation after decompression. *Aviation, Space, and Environmental Medicine* 76:666-669.
- Brodsky, S.V., F. Zhang, A. Nasjletti, M.S. Goligorsky. 2004. Endothelium-derived microparticles impair endothelial function in vitro. *American Journal of Physiology: Heart and Circulatory Physiology* 286:H1910-H1915.
- Brubakk, A.O., D. Duplančić, Z. Valic, I. Palada, A. Obad, D. Baković, U. Wisloff, and Ž. Dujic. 2005. A single air dive reduces arterial endothelial function in man. *Journal of Physiology* 566:901-906.
- Cook, S.F. 1951. Role of exercise, temperature, drugs and water balance in decompression sickness. In Fulton, J.F. (ed.). *Decompression Sickness*. Saunders: Philadelphia. pp. 223-241.
- Dick, A.P., R.D. Vann, G.Y. Mebane, and M.D. Feezor. 1984. Decompression induced nitrogen elimination. *Undersea Biomedical Research* 11:369-380.
- Diesel, D.A., M.T. Ryles, A.A. Pilmanis, and U.I. Balldin. 2002. Non-invasive measurement of pulmonary artery pressure in humans with simulated altitude-induced venous gas emboli. *Aviation, Space, and Environmental Medicine* 73:128-133.
- Dujic, Ž., D. Duplančić, I. Marinović-Terzić, D. Baković, V. Ivančev, Z. Valic, D. Eterović, N.M. Petri, U. Wisloff, and A.O. Brubakk. 2004. Aerobic exercise before diving reduces venous gas bubble formation in humans. *Journal of Physiology* 555(3):637-642.



- Dujić, Ž., D. Bakovic, I. Marinovic-Terzic, and D. Eterovic. 2005a. Acute effects of a single open sea air dive and post-dive posture on cardiac output and pulmonary gas exchange in recreational divers. *British Journal of Sports Medicine* 39:e24.
- Dujić, Ž., I. Palada, A. Obad, D. Duplancic, D. Bakovic, and Z. Valic. 2005b. Exercise during a 3-min decompression stop reduces postdive venous gas bubbles. *Medicine and Science in Sports and Exercise* 37:1319–1323.
- Dujić, Ž., A. Obad, I. Palada, Z. Valic, and A.O. Brubakk. 2006. A single open sea air dive increases pulmonary artery pressure and reduces right ventricular function in professional divers. *European Journal of Applied Physiology* 97(4):478–485.
- Dujić, Ž., Z. Valic, and A.O. Brubakk. 2008. Beneficial role of exercise on scuba diving. *Exercise and Sport Sciences Reviews* 36:38–42.
- Eftedal, O.S. and A.O. Brubakk. 1997. Agreement between trained and untrained observers in grading intravascular bubble signals in ultrasonic images. *Journal of Undersea and Hyperbaric Medicine* 24:293–299.
- Eftedal, O.S., S. Lydersen, and A.O. Brubakk. 2007. The relationship between venous gas bubbles and adverse effects of decompression after air dives. *Journal of Undersea and Hyperbaric Medicine* 34:99–105.
- Eldridge, M.W., J.A. Dempsey, H.C. Haverkamp, A.T. Lovering, and J.S. Hokanson. 2004. Exercise-induced intrapulmonary arteriovenous shunting in healthy humans. *Journal of Applied Physiology* 97:797–805.
- Flook, V. 1997. The effect of exercise on decompression bubbles. In Mekjavic, I.B., and M.J. Tipton, eds. *Proceedings of the XXIII Annual Scientific Meeting of the European Underwater and Baromedical Society*, Bled, Slovenia. Pp. 55–61.
- Jankowski, L.W., R.Y. Nishi, D.J. Eaton, and A.P. Griffin. 1997. Exercise during decompression reduces the amount of venous gas emboli. *Journal of Undersea and Hyperbaric Medicine* 24:59–65.
- Malik, A.B. 1983. Pulmonary microembolism. *Physiological Reviews* 63:1114–1207.
- Marabotti, C., F. Chiesa, A. Scalzini, F. Antonelli, R. Lari, C. Franchini, and P.G. Data. 1999. Cardiac and humoral changes induced by recreational scuba diving. *Journal of Undersea and Hyperbaric Medicine* 26:151–158.
- Muth, C.M., C.M. Staschen, V. Warninghoff, U. van Laak, and P. Rademacher. 1994. Exercise effects on central venous nitrogen tensions after simulated non-decompression dives. *Journal of Undersea and Hyperbaric Medicine* 21:297–303.
- Nishi, R.Y., A.O. Brubakk, and O.S. Eftedal. 2003. Bubble detection. In Bennett and Elliott's *The Physiology and Medicine of Diving*, Brubakk, A.O. and T.S. Neuman, eds. Saunders: London. Pp. 501–529.
- Nossum, V., S. Koteng, and A.O. Brubakk. 1999. Endothelial damage by bubbles in the pulmonary artery of the pig. *Journal of Undersea and Hyperbaric Medicine* 26:1–8.
- Nossum, V., A. Hjelde, and A.O. Brubakk. 2002. Small amounts of venous gas embolism cause delayed impairment of endothelial function and increase polymorphonuclear neutrophil infiltration. *European Journal of Applied Physiology* 86:209–214.
- Obad, A., I. Palada, Z. Valic, V. Ivancev, D. Bakovic, U. Wisloff, A.O. Brubakk, and Z. Dujic. 2007. The effects of acute oral antioxidants on diving-induced alterations in human cardiovascular function. *Journal of Physiology* 578:859–870.
- Sawatzky, K.D. 1991. The relationship between intravascular Doppler-detected gas bubbles and decompression sickness after bounce diving in humans, York University, Toronto, ON.
- Valic, Z., D. Duplancic, D. Bakovic, V. Ivancev, D. Eterovic, U. Wisloff, A.O. Brubakk, and Z. Dujic. 2005. Diving-induced venous gas emboli do not increase pulmonary artery pressure. *International Journal of Sports Medicine* 26:626–631.
- Vann, R.D., W.A. Gerth, and N.E. Leatherman. 1989. Exercise and decompression sickness. In Vann, R.D. (ed.) *The Physiological Basis of Decompression*. Proceedings of the 38<sup>th</sup> UHMS Workshop. Bethesda. Pp. 119–145.
- Vik, A., B.M. Jenssen, O.S. Eftedal, and A.O. Brubakk. 1993. Relationship between venous bubbles and hemodynamic responses after decompression in pigs. *Journal of Undersea and Hyperbaric Medicine* 20:233–248.
- Wisloff, U., and A.O. Brubakk. 2001. Aerobic endurance training reduces bubble formation and increases survival in rats exposed to hyperbaric pressure. *Journal of Physiology* 537:607–611.
- Wisloff, U., R.S. Richardson, and A.O. Brubakk. 2003. NOS inhibition increases bubble formation and reduces survival in sedentary but not exercised rats. *Journal of Physiology* 546:577–582.
- . 2004. Exercise and nitric oxide prevent bubble formation: a novel approach to the prevention of decompression sickness? *Journal of Physiology* 555:825–829.



# Animal Experiments for Evaluating Decompression: Development of the Modern Submarine Escape Method

*Mikael Gennser*

---

**ABSTRACT.** Although animal experiments helped to lay the foundations of our understanding of decompression physiology and to develop the first methods to avoid decompression sickness, new diving methods have relied only sparingly on animal experiments. A short review is provided of the development of the modern submarine escape method: a rescue method from sunken submarines. The development of this method has depended to a very large extent on the use of animal experiments.

## INTRODUCTION

It is common knowledge that animal experimentation played an essential part in laying the foundations of our understanding of decompression physiology. In 1670 Robert Boyle made the initial observation of a bubble in the eye of a viper exposed to low ambient pressure (Boyle, 1670) and he put forward the hypothesis that decompression would cause bubbles to form in all parts of the body of the animal, thus causing the severe symptoms he described. Two hundred years later Paul Bert (Bert, 1878) in a series of experiments on several species of animals was able to link the cause of decompression sickness to the formation of nitrogen bubbles. Thirty years later, Boycott, Damant and Haldane (Boycott et al., 1908) used goats in their seminal experiments working out the method of staged decompression to prevent compressed-air illness, or as we now call it, decompression sickness. During WW II Newton Harvey and his group (Harvey, 1945) used physical, cellular, and animal models to investigate the conditions necessary for bubble formation in the body.

Nevertheless, it is hard to fault Alf Brubakk (1996) when he writes that “animal studies have had relatively little impact on both the development of [diving] procedures and methods for treatment of accidents.” Clearly, animal experimentation has played a much smaller role than human experimentation in the development of new diving techniques during the latter half of the 20th century. One of the reasons for this may be that the main drivers of the development of modern diving have been the military and commercial diving companies and the academic community has only played a secondary part.

The need for better tables or less narcotic or dense breathing gases has often occurred as a result of technological improvements, allowing the divers to dive deeper and/or stay at depth for longer periods. Problems have usually occurred while trying to extrapolate existing decompression tables or methods. By changing the methods incrementally it has been possible to use human divers to test new techniques because the complications have been considered to be of limited severity and any resulting decompression sickness treatable.

But in certain cases, where the danger posed to the divers either was much greater or was unknown, animal experiments have been extremely useful. Ralph Brauer when reviewing the work leading to the deep hydrox and hydroheliox dives felt that it was “difficult to escape the conclusion that here [was] an instance where animal experimentation furnished the basic data upon which others found it possible to initiate work directly aimed at testing the feasibility of exposing humans to this gas” (Brauer, 1987). The reason animal experiments were used initially to test hydrogen as a diving gas was, however, only partly due to the unknown decompression properties of the gas. The main reason the first exposures were made with animals was to make sure the gas was inert and excluded any risks of toxicity (Örnhagen, 1987).

### THE NEED FOR THE SUBMARINE ESCAPE METHOD

There is another diving method that is less well known that has relied almost exclusively on animal experiments for its development, and where the main risk apart from barotrauma is severe central nervous system decompression sickness (CNS DCS), i.e., the modern submarine escape method.

After WW II, as a response to the grievous losses experienced by the submarine fleet, the British Admiralty instigated research and development to improve the possibilities for submariners to escape from sunken submarines. There had been several successful escapes from submarines reported during the war. However, to be able to escape the pressure inside the submarine had to be equalized with the external pressure, and in single compartment submarines this took a long time. In the mean time, the survivors would be exposed to the increased pressure, and to increased partial pressures of nitrogen, carbon dioxide, and oxygen. It was considered that the chances of a successful escape from depths deeper than 100 ft (30 msw) were dismal. To improve the chances of a good outcome and increase the safe escape depth, special escape chambers were devised that would equalize much quicker to the surrounding pressure. The submariner would be breathing clean air via a dedicated air supply that inflated the buoyancy stole and the hood that he wore. Since the stole was connected to the hood, once the escape hatch had opened and the submariner would start to ascend through the water column, the expanding air in the stole would fill the hood and thus maintain a cushion of air in front of his face during the whole ascent.

### HISTORY OF TESTING PROCEDURES

Very early on it was decided that air would be used in the gas supply to reduce possible complications with oxygen toxicity and to also have the possibility of using other sources of compressed air in case the dedicated air supply was unavailable. The questions that now had to be answered were how fast a compression one could withstand and how fast and from what

depth could the ascent be without causing decompression illness.

Before any wet dives were tested experiments were carried out in dry pressure chambers. It was obvious that animals would have to be used in all but the most conservative exposures until a safe method had been devised. The animal that was chosen was the goat. Boycott et al. (1908) had chosen the goat mainly for its ease of handling. However, there were a number of other factors that had to be considered in the submarine escape trials. Preferably the animals should be awake and non-sedated during the exposures so that even mild symptoms could be noted: the animals should be able to equilibrate pressure during the rapid compressions and, most importantly, the animals should not tend to hold their breath during the ascent, but exhale as the pulmonary air expanded. It turned out that the goats could be trained to accept both the high noise volumes during compression and decompression and because of their strong Hering-Breuer reflex the animals would exhale in most cases during the ascents.

During a 25-year period between 1945 and 1970 the Royal Navy carried out animal experiments (and some human exposures) to develop a method that would allow submariners to escape from a disabled submarine from depths close to 200 msw. This work has been reviewed in two articles by one of the main investigators (Donald, 1979; 1991). The final escape “dive profile” turned out to be a pseudo-exponential compression rate with a doubling of pressure every 4th to 5th second to 180 msw depth (19 atm), a four second pause at depth, and then a linear ascent with 2.75 – 3 msw/s (Fig. 1). Thus, a “dive” to 180 msw and back to the surface would be completed in less than 90 seconds. In 1970, the method was tested successfully by submariners escaping from 180 msw depth off Malta (Upshot V).

There followed a pause in the research and development of submarine escapes until the mid-1980s. By that time one had come to the conclusion that in almost all conceivable submarine accidents there would be a pressure increase inside the submarine and it was therefore necessary to find out from what depth one could ascend safely given the internal pressure inside the submarine and the time spent at that increased pressure. The

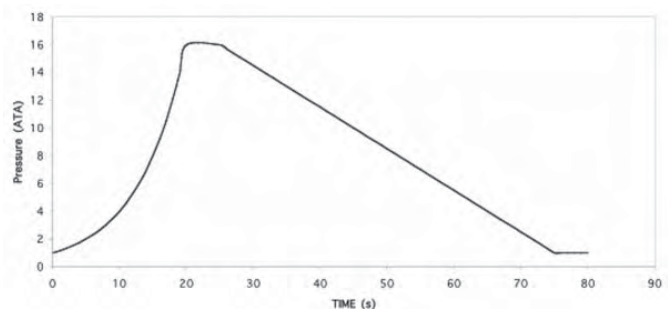

**FIGURE 1. Redrawn time-depth profile from submarine escape procedure carried out from submarine from a depth of 150 msw. (Copy of original data given to the author by Cdr. Bo Persson, Royal Swedish Navy.)**

“safe-to-escape” curve had to be determined. Also, for this work goats were used, although one series of man trials eventually was carried out. The safe-to-escape curve was in the end calculated from data from a total of 568 goat dives that resulted in 45 cases of DCS and 72 man dives with 2 cases of DCS (White et al., 2004).

The resulting safe-to-escape curve is shown in Figure 2 with human and goat data marked respectively. The remaining data has been extrapolated using an exponential/linear decompression model with Hill’s risk model added for saturation dives (Loveman, 2004). To sum up, goats were used to develop a relatively safe escape method prior to human testing.

## PHYSIOLOGICAL RISKS

The reason these profiles are dangerous is the ever present risk of pulmonary barotrauma with arterial gas embolism and the fact that these profiles will preferentially load the fast tissues (e.g., the central nervous system) with inert gas. Donald used classical Haldanean theories to calculate that after an escape from 300 msw a very fast tissue (half-time of 1.3 min) would yield a Haldane ratio of more than 11 upon surfacing and a fast tissue (half-time of 5 min) would yield a Haldane ratio of almost 6 (Donald, 1991). Consideration of results of experiments with broken ascent profiles (i.e., stops at shallow depths) indicated that the critical tissues were in the “5-minute” range (Donald, 1991). Flook (1997), in a theoretical consideration of the free ascent profile, showed that fast tissues such as the central nervous system, would be the preferential target for bubble formation.

Later research used this information showing that even short periods of oxygen breathing prior to deep escapes reduced the amount of circulating bubbles post ascent (Gennser and

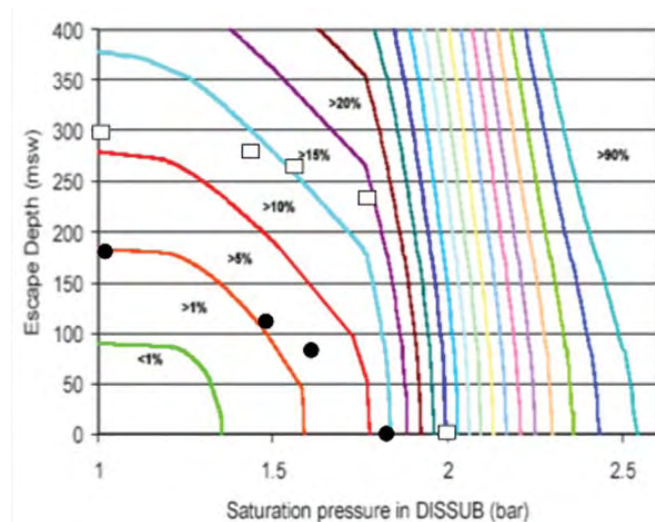

FIGURE 2. UK safe-to-escape curve. Redrawn from Loveman et al., 2004. Solid dots show limiting manned exposures; squares show the limits of animal exposures.

Blogg, 2008). However, the use of oxygen-enriched gas instead of air during the ascent did not reduce the amount of initial bubbling (Blogg et al., 2003). In all likelihood the very high partial pressures of oxygen made oxygen behave as an inert gas, even in a tissue with high metabolic rate like the central nervous system, and nitrogen/oxygen bubbles were formed. This had in fact been predicted by earlier investigators (Donald, 1991). Apart from the first paper on “oxygen bends” (Donald, 1955), these experiments are probably the first instances with clear evidence of oxygen bubbles.

## ANIMAL MODEL ADVANTAGES

The advantages of using an animal model include controlled conditions, avoiding the exposure of humans to unnecessary risk, achieving objective end points, and allowing for more extensive measurements. Another advantage of using animals in this particular setting, where the end-points were relatively severe decompression sickness, can be seen in Figure 3. The figure shows the timing of first DCS symptoms in goats after submarine escape (with or without preceding saturation at increased air pressure). Also shown in the graph is a line indicating the time when symptoms (CNS symptoms and joint pains) started to appear in escapers from the bottomed Peruvian submarine *Pacocha*. The internal pressure in the submarine had increased to 2.7 atm and the crew had waited far too long before deciding to escape towards the surface. The timing of the symptoms in the submariners fits rather well with the goat data.

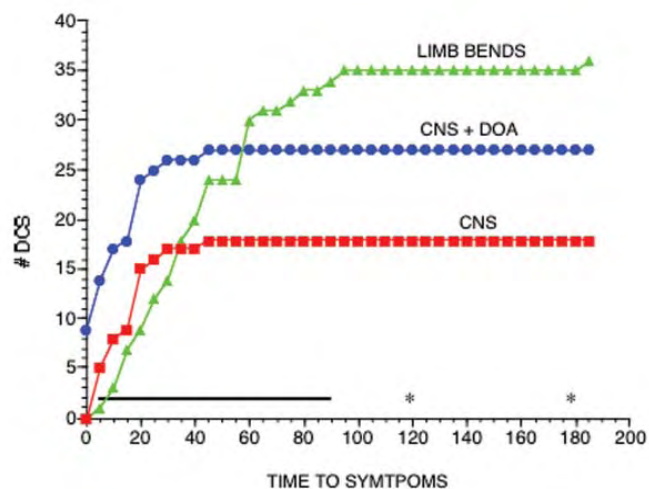

FIGURE 3. Time of occurrence of DCS symptoms in goats after surfacing from submarine escape profiles. Triangles: limb bends; circles: CNS symptoms; + dead on arrival at surface (probably arterial gas embolism), squares: CNS symptoms. Solid line indicates timing of DCS symptoms in survivors from the Peruvian submarine *Pacocha*. Stars show time of symptoms in two divers taking part in submarine escape experiments (CNS symptoms and marbling). Data from Blogg et al. 2003; Gennser and Blogg, 2008; Seddon, 1997; Benton, 2002; and Harvey and Carson, 1989.

Conversely, the symptoms that appeared in two subjects taking part in a trial with deep submarine escapes after shallow air saturation occurred much later. It is hard to avoid the suggestion that the DCS found after the experimental trial is of a less severe nature and the symptoms may well have subsided without any treatment. It must of course be noted that all symptoms occurring in a volunteer in an experimental study must be taken very seriously. However, in a mass casualty situation it is more than likely that these divers would not have merited any treatment in the first instance.

A definite advantage with the animal model used in these trials, was that the animals were awake and not exposed to anesthesia. In one trial where goats were lightly anesthetised to allow drawing arterial blood from carotid loops, rapid compressions to 50 msw caused the animals to become apneic. Interestingly, the resulting lung squeeze delayed the uptake of nitrogen in the arterial circulation by 30 secs to a minute, something that would have markedly reduced the risk of decompression sickness during an escape (Flook et al., 1998).

### LONG-TERM CNS EFFECTS?

The fact that goats were used in repeated dives, but otherwise kept in a stable, controlled environment for their whole life, made it of interest to investigate whether the diving activity appeared to have had any long-term effect on their central nervous system. Blogg et al. (2004) conducted experiments with 30 goats (13 of which had never shown symptoms of DCS and 17 had been treated successfully for DCS). Magnetic resonance imaging (MRI) of the brains showed “white spots” in 3 animals. There was no correlation of “white-spots” with either diving activity or DCS. Following up with a histopathological analysis of the brains, the “spots” were determined to be functional, not anatomical, lesions and there were no histopathological lesions in any of the brains, indicating no long-term effect of the diving activity in these animals. However, goats (like all *Artiodactyla*) have a carotid rete, which might provide protection against cerebral embolization. No correlation was found between spinal degeneration and DCS or diving, but spinal scarring in two animals treated for DCS was discovered. Although this study was too small to yield any clear-cut evidence one way or another, clearly it did show the possibility of using animal experimentation to attack one of the more important health questions concerning diving: whether diving as such gives rise to long-term effects on the central nervous system.

### CONCLUSION

This short review of the development of the submarine escape method has tried to show the importance of animal experiments in a situation where it would clearly have been unethical to use human subjects. In the future there may be other such instances where animal experiments will have to precede human

trials in order to not expose human volunteers to unnecessary risks. However, the most likely future use of animal experiments, and where animals have previously been used most frequently, is in the investigation of underlying pathophysiological mechanisms.

Modern molecular biological techniques, such as knock-out mice, will yield many new tools and avenues for investigating the interaction between bubbles and tissues. However, one should not forget the experiments that Nature itself has provided for us with natural divers such as diving mammals. Although both animal rights issues and the size of the animals make it almost impossible to carry out laboratory research on all but the smallest species, some remarkable field studies have been performed (Kooyman, 1981). With the use of microcomputers it has been possible to follow the natural diving behavior of these animals in the wild, and to even carry out invasive measurements such as mapping blood gases during actual deep dives (Zapol et al., 1989). In the future, improved miniaturization of ultrasound imaging devices may yield very interesting results, both in regard to blood-flow studies and possible post-dive bubble generation. Diving mammals may also yield biochemical clues on the pathophysiology of decompression sickness. It has for instance been shown that many diving mammals appear to lack certain factors in the coagulation cascade (Robinson et al., 1969). Experiments with knock-out mice or inbred mice that are poor in the same factors may yield information on the importance of an intact coagulation system in the pathological sequence of decompression sickness.

In short, although animal experiments will probably only be used sparingly in testing and developing actual diving methods, as an instrument to dissect and clear up the mechanisms behind decompression sickness animal experiments will in all likelihood still have a big part to play.

### LITERATURE CITED

- Benton, P. 2002. Submarine escape trials 1999–2001—provisions of medical support. *Journal of Royal Navy Medical Services* 88(3):108–115.
- Bert, P. 1878. *La Presion Barometrique*. Translated by Hitchcock, M. A. and F. A. Hitchcock (1943) Columbus: College Book Company.
- Blogg, S.L., M. Gennser, G.A.M. Loveman, F.M. Seddon, J.C. Thacker, and M.G. White. 2003. The effect of breathing hyperoxic gas during simulated submarine escape on venous gas emboli and decompression sickness. *Journal of Undersea and Hyperbaric Medicine* 3(3):163–174.
- Blogg, S.L., G.A.M. Loveman, F.M. Seddon, N. Woodger, A. Koch, M. Reuter, M. Gennser, and M.G. White. 2004. Magnetic resonance imaging and neuropathology findings in the goat nervous system following hyperbaric exposures. *Journal of European Neurology* 52:18–28.
- Boycott, A.E., G.C.C. Damant, and J.S. Haldane. 1908. Prevention of compressed-air illness. *Journal of Hygiene, Cambridge* 8:342–443.
- Boyle, R. 1670. New pneumatical observations about respiration. *Philosophical Transactions of the Royal Society* 5:2011–2031.
- Brauer, R.W., and R. Naquet. 1987. Contributions of animal experimentation to the establishment of appropriate conditions for ethical use of hydrogen as a component of deep diving atmospheres. In Brauer, R.W. (ed.) *Hydrogen as a diving gas*. Thirty-third Undersea and Hyperbaric Medical Society Workshop, UHMS publication no. 69. Pp 3–12.



- Brubakk, A.O. 1996. Which animal models are to be used to study decompression accidents? In *Proceedings of the Second European Consensus Conference on Treatment of Decompression Accidents in Recreational Diving*. Wattel, F., and D. Mathieu (eds.) Marseille, France. pp 85–101.
- Donald, K.W. 1955. Oxygen bends. *Journal of Applied Physiology* 7(6):639–644.
- . 1979. Submarine escape breathing air. A review and analysis of animal and human experiments by the Royal Navy. *Bulletin of European Physiopathology and Respiration* 15(5):739–745.
- . 1991. A review of submarine escape trials from 1945 to 1970 with a particular emphasis on decompression sickness. *Journal of Royal Navy Medical Services* 77:171–200.
- Flook, V. 1997. A theoretical study of the extent and duration of decompression bubbles following submarine escape procedures. In Mekjavic, I.B., and O. Eiken, eds. *Diving and Hyperbaric Medicine*, Proceedings of the 23rd European Underwater Baromedical Society Congress, Bled, Slovenia. Pp 62–67.
- Flook, V., and A.L. Ustad. 1998. Blood nitrogen concentrations in goats following rapid compression to 6 bar. SINTEF report no. STF78, F98112, SINTEF Unimed, UK.
- Gennser, M., and S.L. Blogg. 2008. Oxygen and carbogen breathing before simulated submarine escape. *Journal of Applied Physiology* 104:50–56.
- Harvey, C., and J. Carson. 1989. The B.A.P. Pacocha (SS-48) collision: The escape and medical recompression treatment of survivors. Naval Submarine Medical Research Laboratory, NSMRL Special Report SP89-1, pp. 50.
- Harvey, N.E. 1945. Decompression sickness and bubble formation in blood and tissues. *Bulletin of the New York Academy of Medicine* 21(10):505–536.
- Kooyman, G.L. 1981. *Weddell Seal: Consummate Diver*. Cambridge University Press. Pp. 176.
- Loveman, G.A.M. 2004. Iso-risk curves for escape from saturation in a distressed submarine. In Örnham, H. ed. *Humans in Submarines*. Royal Swedish Navy, Pp. 181–185.
- Örnham H. 1987. Swedish animal experiments using hydrogen-oxygen mixtures at pressures up to 6.0 MPa. In Brauer, R.W., ed. *Hydrogen as a diving gas*. Thirty-third Undersea and Hyperbaric Medical Society Workshop, UHMS publication no. 69. Pp 25–30.
- Robinson, A.J., M. Kropatkin, and P.M. Aggeler. 1969. Hageman factor (factor XII) deficiency in marine mammals. *Science* 166:1420–1422.
- Seddon, F.M. 1997. Safe to escape curve. Animal studies: August 1993 to February 1997. Defence Research Agency Report DERA/SSES/CR971023/1.0, London, UK.
- White, M.G., F.M. Seddon, K.M. Jurd, J.C. Thacker, M. Stansfield, and G.A.M. Loveman. 2004. UK safe-to-escape curve research. In Ed: Örnham, H., ed. *Humans in Submarines*. Royal Swedish Navy, Pp. 175–180.
- Zapol, W.M., R.D. Hill, J. Qvist, K. Falke, R.C. Schneider, G.C. Liggins, and P.W. Hochachka. 1989. Arterial gas tensions and hemoglobin concentration of the freely diving Weddell seal. *Undersea Biomedical Research* 16:363–373.





# Ultrasound for Evaluating Decompression

*Olav S. Eftedal*

---

**ABSTRACT.** Studies show that the occurrence of venous gas bubbles is a highly sensitive, although not specific, predictor of decompression stress, at least for sub-saturation dives. Consequently, the absence of detectable bubbles is a strong indicator of decompression safety. Traditionally, new decompression procedures have been evaluated by recording the incidence of decompression-related symptoms. The number of test dives required for a reliable assessment of a procedure based on this traditional evaluation is high, making validation of decompression procedures extremely resource demanding. We propose an alternative method for validation of decompression procedures based on detection of vascular gas bubbles. The method makes use of Bayesian statistics to estimate the risk of decompression sickness for the tested procedure based on previous knowledge about the correspondence between vascular gas bubbles and decompression sickness. The new method will greatly reduce the number of dives required to approve or reject a procedure and can facilitate introduction of new and safer decompression tables.

## INTRODUCTION

For 350 years we have known that decompression, the process of coming up from a dive, can induce formation of gas bubbles in the body (Boyle, 1670). We also have considerable empirical evidence that these gas bubbles can cause decompression sickness. Still, our knowledge of how bubbles are formed and how they cause decompression sickness is very limited. To study these processes we need some means of detecting the gas bubbles. Gas bubbles in liquid are strong reflectors of sound, and ultrasound techniques are well suited for detection of gas bubbles in the vascular system. The two ultrasound techniques most widely used for bubble detection are Doppler and imaging.

The Doppler technique gives audible sound signals (echoes) from the blood flow. Any bubbles present in the flowing blood will give sharp clicking sounds that can be discriminated from the smooth flow signal (Eftedal and Brubakk, 1997). Rather than counting single bubbles, the amount of bubbles is usually estimated according to some classification scheme. The most widely used grading schemes are the Spencer code (Spencer and Johansen, 1974) and the Kisman-Masurel (K-M) code (Kisman and Masurel, 1983). Both schemes go from grade 0 (no bubbles) to grade 4 (many bubbles), and the difference between the schemes lies in how the measurements are performed rather than the number of bubbles assigned to each grade. The K-M code includes measurements at rest and after movement, both in central and peripheral vessels, whereas the Spencer code is designed for measurements in the pulmonary artery at rest. Doppler systems are compact, inexpensive and well suited for field studies.

Ultrasound imaging can also be used to detect bubbles in the body, and the heart is the preferred location for detection. Bubbles can be seen as bright spots in the image,

and the number of bubbles is again usually estimated by scoring. We have previously suggested a grading scheme for ultrasound imaging with 6 levels from 0 to 5 (Eftedal and Brubakk, 1997). This scheme is in most cases directly comparable to the Doppler schemes (Brubakk and Eftedal, 2001). Imaging systems are generally more complex and expensive than Doppler systems, but portable instruments suitable for field studies are now available.

## CORRESPONDENCE BETWEEN VASCULAR GAS BUBBLES AND DCS

In the literature there are several published studies that address the issue of correspondence between detectable venous gas bubbles and the occurrence of decompression sickness, most of them on Doppler-detected bubbles. The studies use different procedures for bubble detection and the output parameters vary. Some use maximum observed bubble grade, some use time integrals. Some studies also combine data from various types of exposures. The different studies are therefore not easy to compare.

The most extensive study on bubble/DCS correspondence in sub-saturation diving was presented by Sawatzky (1991) in his master thesis where he systematically analyzed maximum Doppler scores and DCS incidence in 1,726 nitrox (nitrogen and oxygen) dives and 1,508 Heliox (helium and oxygen) dives. The data were obtained from chamber decompression trials at the Defence and Civil Institute of Environmental Medicine (DCIEM) in Toronto, Canada. The uniqueness of these data lie both in their quality and quantity: It is the most comprehensive collection of data published, the data are collected according to the recommended standards for Doppler monitoring (Eatock

and Nishi, 1986) and Doppler grading is performed and verified by competent personnel. DCS diagnoses were made according to specific criteria (Temple et al., 1999). The most important of Sawatzky's data are reproduced in Table 1.

Sawatzky (1991) concluded that the risk of developing DCS increases with increasing Doppler grades and the best indicator of that risk is the single highest Doppler grade regardless of location. He explained this with the greater ease with which bubbles can be detected in the subclavian veins where the signal to noise ratio is higher compared to precordial measurements. This is supported by the findings of Eckenhoff et al. (1990) who found an increased sensitivity with subclavian- as compared to precordial monitoring. In Sawatzky's data there is only one case of DCS not accompanied by detectable bubbles. The negative predictive value is 0.999 and the sensitivity of detectable bubbles as a test for DCS is 0.99. On the other hand there are 1,720 exposures where bubbles were detected without any symptoms of DCS, and the positive predictive value is only 0.04, so detectable bubbles only yields a 4% chance of having DCS. Even when using bubble grades III and IV as test criteria, the positive predictive value is as low as 0.07. Therefore, the data strongly suggest that for sub-saturation diving the absence of detectable bubbles is a good indicator of decompression safety, but the occurrence of bubbles, even high grades, is a poor predictor of decompression sickness.

There are few studies on bubbles and DCS for saturation diving, and most existing studies are performed on small populations. In a study of 125 exposures in 29 heliox saturation dives, Gardette (1979) found 23 cases of muscle or joint pain. Five of these cases were not accompanied by detectable gas bubbles, yielding an incidence of 10% for bubble grade 0. Doppler-bubble detection was performed precordially at rest and after

**TABLE 1. DCIEM data on Doppler detected bubbles and DCS incidence in bounce dives. "Overall maximum grade" is the highest obtained score regardless of position (precordial or subclavian veins) or rest/movement.**

Condition	KM Grade	Air dives			Heliox dives		
		Exposures	DCS	% DCS	Exposures	DCS	% DCS
Chest, rest							
	0	1264	7	0.6	945	6	0.6
	I	131	0	0.0	105	2	1.9
	II	137	8	5.8	184	1	0.5
	III	191	25	13.1	272	22	8.1
	IV	3	1	33.3	2	1	50.0
Chest, movement							
	0	1164	3	0.3	879	7	0.8
	I	109	2	1.8	70	0	0.0
	II	111	3	2.7	114	1	0.9
	III	305	26	8.5	313	11	3.5
	IV	37	5	13.5	132	13	9.8
Overall maximum grade							
	0	819	0	0.0	623	1	0.2
	I	287	3	1.0	214	1	0.5
	II	183	2	1.1	187	0	0.0
	III	365	27	7.4	347	15	4.3
	IV	72	9	12.5	137	15	10.9

movement and bubbles were graded according to the Spencer scale. The study showed an increasing risk of muscle and joint pain with increasing bubble grade, with a 34% incidence for grade III bubbles after movement. There were no cases of grade IV bubbles and no cases of serious decompression sickness.

Hypobaric exposures are in principle similar to decompression from saturation in that the subjects start the decompression from saturation. In contrast to saturation diving there are several large studies addressing the issue of bubbles and DCS for hypobaric exposures. One study by Conkin et al. (1998) reported on 1,322 exposures, mainly simulations of extravehicular activities (EVAs) in space. There were 480 exposures with detectable bubbles and 168 cases of DCS. The authors found that the absence of detectable bubbles was highly correlated with the absence of symptoms, with a negative predictive value of 0.98. For grades III and IV they found DCS incidences of 19% and 48%, respectively, and a corresponding positive predictive value of 0.39. The authors concluded that vascular gas bubbles is a necessary, but not sufficient, condition for DCS and that information about gas bubbles is useful to assess the risk of DCS in hypobaric decompressions.

In another review study of 2,044 hypobaric exposures with 819 cases of DCS from the Air Force Research Laboratory DCS Research Database, Pilmanis et al. (1999) found a considerably higher DCS risk with lower bubble grades (grade 0-19%, I-26%, II-50%, III-52%, IV-62%). The studies contained in the database are all designed to provoke DCS in a substantial portion of subjects and with an overall incidence of over 40% they have certainly succeeded. These figures question the usefulness of Doppler detected bubbles in excluding DCS. In a study of various clinical manifestations of DCS in the same database, Balldin et al. (2004) found that only 27 out of 49 cases (55%) of central nervous system (CNS) manifestations were accompanied by detectable bubbles. They concluded that echo imaging has limited application for use as a predictor of altitude-CNS DCS.

The bubble/DCS correlation seems to depend on the type of exposure. In general, the body can tolerate a substantial amount of gas bubbles without any signs or symptoms of decompression sickness, and the presence of gas bubbles therefore has little diagnostic value. However, at least for sub-saturation diving, the absence of gas bubbles is an excellent indicator of decompression safety.

## BUBBLE DETECTION FOR VALIDATION OF DECOMPRESSION PROCEDURES

In a clinical setting, the absence of detectable vascular gas bubbles could theoretically be used as a tool for excluding the DCS diagnosis. In practice, however, this would call for surveillance by highly trained personnel at 20 - 30 minute intervals for at least two hours directly after surfacing, which is clearly not an option. A more feasible application for bubble detection is in the assessment of the safety of decompression procedures.

Hamilton and Schreiner (1989) concluded in a UHMS workshop that new procedures should be validated primarily by extensive, dedicated laboratory testing before being put into the field for operational evaluation. Traditionally the criterion of success for such testing has been the observed incidence of DCS compared to a certain pre-defined maximum level. The main problem with evaluating decompression procedures this way is the large number of dives required to determine DCS risk with any degree of certainty: From the binomial distribution we find that more than 300 exposures with no incidents are needed to confirm a DCS incidence below 1% with a 95% confidence interval. For recreational diving the incidence should be considerably lower than this, so the expenses and time required for validation can actually prevent new procedures from being implemented. Also, this method for validation of procedures will inevitably lead to decompression injury among the test subjects. Furthermore, the DCS diagnosis is based on symptoms and is therefore subjective. Divers may choose not to report symptoms, or may report symptoms due to apprehension or from other causes not related to the decompression (Nishi et al., 2003). Occurrence of vascular bubbles is a more objective observation that cannot be hidden by the diver.

At Defence Research and Development Canada (DRDC, formerly DCIEM), bubble detection has been used for table validation for many years (Nishi and Eatock, 1989). An empirically selected limit of KM grade II or greater in 50% of the subjects has been used to discriminate between stressful and acceptable procedures. Simple criteria such as this will reduce the number of dives required for validation compared with observation of DCS alone, but they do not make full use of the information obtained by bubble detection.

With an established bubble/DCS correlation, bubble detection can be used to estimate the actual risk of having decompression sickness when testing a decompression procedure. We have designed a method based on Bayesian statistics where each bubble grade is assigned a DCS risk based on established data. In our method we used Sawatzky's nitrox data from Table 1. This set of risks is combined with observed bubble grades in a series of test dives for the new procedure. In this way we can estimate the DCS risk and, more importantly, calculate a 95% credible interval for the estimate. A credible interval is a posterior probability interval, used in Bayesian statistics for purposes similar to those of confidence intervals in frequentist statistics.

For illustration we have applied the method to bubble data from field tests of no-decompression limits for altitude diving. The experiments were carried out in the mountainous region of eastern Turkey in a small lake at 3,500 meters above sea level. Six different combinations of depth and bottom time were tested, with 10 dives for each dive profile. Bubble detection was performed with Doppler and bubbles were scored according to the K-M scheme. Maximum bubble grades for all dive profiles tested are shown in Table 2. There were no cases of DCS or adverse effects of decompression. Based on a "traditional" evaluation we find that the DCS risk is 0-31% (binomial distribution,

95% confidence interval) for each dive profile. This is obviously of little value for assessment of the procedures. If we apply the Bayesian method for estimating DCS risk based on detected bubbles we find estimates for DCS risk and 95% credible intervals as shown in Table 3.

## CONCLUSION

We conclude that the suggested method will greatly reduce the number of dives needed to validate or reject new decompression procedures.

The use of bubble detection has other benefits and there is evidence indicating that gas bubbles may cause subclinical damage in the absence of DCS e.g., to the endothelium of the lung (Brubakk et al., 2005). Whether such subclinical damage may accumulate to cause irreversible damage is not known, but should be a point of concern (Eckenhoff, 1985). Limiting the number of so-called “silent bubbles” (i.e., bubbles not causing clinical DCS) is therefore beneficial. Another important point in favor of monitoring VGE is that the risk of inflicting DCS to test divers is reduced, as a procedure can be rejected before a single case of DCS is encountered.

There is no standard criterion for acceptance or rejection of new decompression procedures with respect to DCS incidence. On-site recompression possibilities may justify use of procedures with higher DCS risk having longer bottom time or shorter decompression. For recreational diving the DCS risk should be as close to zero as possible. Our proposed validation method evaluates the DCS risk and allows comparison of the risk for simultaneously tested procedures. The method can greatly reduce the cost of testing of new decompression procedures both for commercial and recreational diving.

**TABLE 2. Results from field tests of no-decompression bottom times for altitude diving. Maximum bubble score regardless of location, graded according to the Kisman-Masurel code. There were no cases of grade IV bubbles.**

Depth [msw]	15	18	21	24	27	30
Bottom time [min]	38	29	24	21	17	14
Grade 0	6	7	7	4	5	3
Grade I	4	2	0	3	2	3
Grade II	0	0	1	1	1	3
Grade III	0	1	2	2	2	1
n	10	10	10	10	10	10

**TABLE 3. Estimated DCS risks and 95% CI for the no-decompression limits as calculated by the Bayesian method for validation of decompression procedures.**

Depth [msw]	15	18	21	24	27	30
Bottom time [min]	38	29	24	21	17	14
P(DCS) [%]	1.7	1.9	2.2	2.5	2.4	2.3
95% CI	0.7-3.1	0.8-3.5	1.0-3.9	1.3-4.1	1.2-4.0	1.2-3.8

## LITERATURE CITED

- Balldin, U.I., A.A. Pilmanis, and J.T. Webb. 2004. Central nervous system decompression sickness and venous gas emboli in hypobaric conditions. *Aviation, Space, and Environmental Medicine* 75(11):969–972.
- Boyle, R. 1670. New Pneumatical Experiments about Respiration. *Philosophical Transactions* 5:2011–2058.
- Brubakk, A.O., and O.S. Eftedal. 2001. Comparison of three different ultrasonic methods for quantification of intravascular gas bubbles. *Journal of Undersea and Hyperbaric Medicine* 28(3):131–136.
- Brubakk, A.O., D. Duplancic, Z. Valic, I. Palada, A. Obad, D. Bakovic, U. Wisloff, and Z. Dujic. 2005. A single air dive reduces arterial endothelial function in man. *Journal of Physiology* 566(3):901–906.
- Conkin, J., M.R. Powell, P.P. Foster, and J.M. Waligora. 1998. Information about venous gas emboli improves prediction of hypobaric decompression sickness. *Aviation, Space, and Environmental Medicine* 69(1):8–16.
- Eatock, B.C., and R.Y. Nishi. 1986. Procedures for Doppler ultrasonic monitoring of divers for intravascular bubbles. Downsview: Defence and Civil Institute of Environmental Medicine. Report No. 86-C-25.
- Eckenhoff, R.G. 1985. The role of monitoring venous gas emboli after decompression. *Undersea Biomedical Research* 12(4):485–486.
- Eckenhoff, R.G., C.S. Olstad, and G. Carrod. 1990. Human dose-response relationship for decompression and endogenous bubble formation. *Journal of Applied Physiology* 69(3):914–918.
- Eftedal, O., and A.O. Brubakk. 1997. Agreement between trained and untrained observers in grading intravascular bubble signals in ultrasonic images. *Journal of Undersea and Hyperbaric Medicine* 24(4):293–299.
- Gardette, B. 1979. Correlation between decompression sickness and circulating bubbles in 232 divers. *Undersea Biomedical Research* 6(1):99–107.
- Hamilton, R.W., and H.R. Schreiner. 1989. Editorial summary: validation of decompression tables. In Schreiner, H.R., and R.W. Hamilton, eds. *Validation of Decompression Tables*. The 37th Undersea and Hyperbaric Medical Society Workshop. Bethesda: Undersea and Hyperbaric Medical Society. Pp. 163–167.
- Kisman, K., and G. Masurel. 1983. Method for evaluating circulating bubbles detected by means of the Doppler ultrasonic method using the ‘K.M. code’. (English translation of 283 CERTSM 1983). Toulon: Centre d’Etudes et de Recherches Techniques Sous-Marines.
- Nishi, R.Y., A.O. Brubakk, and O.S. Eftedal. 2003. Bubble detection. In Brubakk, A.O., and T.S. Neuman, eds. *Bennett and Elliott’s Physiology and Medicine of Diving*. 5th ed. London: Saunders. Pp. 501–529.
- Nishi, R.Y., and B.C. Eatock. 1989. The role of bubble detection in table validation. In Schreiner, H.R., and R.W. Hamilton, eds. *Validation of Decompression Tables*. The 37th Undersea and Hyperbaric Medical Society Workshop. Bethesda: Undersea and Hyperbaric Medical Society. Pp.133–138.
- Pilmanis, A.A., N. Kannan, K.M. Krause, and J.T. Webb. 1999. Relating venous gas emboli (VGE) scores to altitude decompression sickness (DCS) symptoms. *Aviation, Space, and Environmental Medicine* 70(4):364.
- Sawatzky, K.D. 1991. The relationship between intravascular Doppler-detected gas bubbles and decompression sickness after bounce diving in humans. MSc Thesis. Toronto: York University.
- Spencer, M.P., and D.C. Johanson. 1974. Investigation of new principles for human decompression schedules using the Doppler ultrasonic blood detector. ONR Technical Report (Contract N00014-73-C-0094). Seattle: Institute for Environmental Medicine and Physiology.
- Temple, D.J., R. Ball, P.K. Weathersby, E.C. Parker, and S.S. Survanshi. 1999. The dive profiles and manifestations of decompression sickness cases after air and nitrogen-oxygen dives. Technical Report no. 99-03, 2nd vol. Bethesda: Naval Medical Research Center.

# Current Trends in Ultrasound Imaging Technology, SURF Imaging, and Decompression Induced Microbubbles

*Lasse Løvstakken, Andreas Møllerløkken, and Svein-Erik Måsøy*

---

**ABSTRACT.** Central to Haldane's theory, the risk of developing decompression sickness (DCS) increases with the number of gas bubbles. The introduction of ultrasound to detect vascular gas bubbles generated during and after decompressions has made it possible to compare different decompression situations and models without going to the binominal endpoint of DCS or no-DCS. Miniaturization of ultrasound imaging technology is progressing to small pocket-sized devices with close to high-end image quality. Technological achievements are due to vast developments that have taken place in engineering fields such as acoustics, electronics, material physics, and signal processing, but some challenges such as power consumption and heat generation remain unresolved. Recently, a new method, Second Order Ultrasound Field (SURF) for detecting contrast agents has been developed at NTNU, which utilizes the nonlinear nature of the contrast agents and filters out specific parts of the reflected signal in order to detect the agent of interest. Potential future uses in baromedicine include field monitoring, continuous monitoring, and development of implantable devices.

## INTRODUCTION

Miniaturization of ultrasound imaging technology is at a point where small pocket-sized devices can be made with close to high-end image quality. For measurements of decompression stress as vascular gas embolisms, the technology opens up for field monitoring and research. In addition to miniaturization, the ultrasound systems are getting more sophisticated, and of particular interest is the increased use of ultrasound contrast agents. The technological development opens up for new possibilities for monitoring and research in the diving and hyperbaric environments. Recently, a new method for detecting contrast agents has been developed at NTNU, which utilizes the nonlinear nature of the contrast agents (gas bubbles are easier to expand than to compress). The method called SURF, makes it possible to filter out specific parts of the reflected signal in order to detect the agent of interest. The SURF technology is as such well suited for decompression induced microbubbles, since it can be designed to detect specific size gas bubbles, and filter out all other disturbing signals.

## BACKGROUND

The purpose of all decompression procedures is to prevent injury to the diver, and it is generally agreed that these injuries are caused by the formation of gas bubbles in the body. Gas bubbles form in nearly all decompressions, and the risk of developing decompression sickness (DCS) increases with the number of gas bubbles (Nishi et al., 2003). Paul Bert demonstrated the relationship over 100 years ago (Vann, 2004) and his hypothesis was later central to Haldane's theory (Boycott et al., 1908). Today we know that bubble formation during decompression is not simply a consequence of inert gas supersaturation,

*Lasse Løvstakken and Svein Erik Måsøy, Ultrasound Research Group, Department of Circulation and Medical Imaging, Norwegian University of Science and Technology, Olav Kyrres gt 9, N-7489, Trondheim, Norway. Andreas Møllerløkken, Baromedical and Environmental Physiology Group, Department of Circulation and Medical Imaging, Norwegian University of Science and Technology, Olav Kyrres gt 9, N-7489, Trondheim, Norway.*



because numerous experiments indicate that bubbles originate as pre-existing gas nuclei (Blatteau et al., 2006).

A systematic study of the phenomena accompanying decompression is complex and difficult, as practical measurement methods to monitor the processes taking place in body tissues are lacking. However, the introduction of ultrasound to detect vascular gas bubbles generated during and after decompressions has made it possible to compare different decompression situations and models without going to the binominal endpoint DCS or no-DCS. Recently, a Bayesian approach to validate decompression procedures has also been developed, an approach which is based on detection of vascular gas bubbles (Eftedal et al., 2007).

Gas-filled microbubbles are not just interesting for researchers and clinicians working with hyperbaric problems. The introduction of contrast agents for ultrasonic imaging, especially for cardiology and abdominal applications are also a highly specialized application working with gas filled bubbles. Ultrasound contrast agents are generally of a size of 1-4  $\mu\text{m}$ , they are transpulmonary and provide strong reflections which can be detected. Modern contrast agents are usually filled with perfluorocarbon gas, stabilized in a lipid monolayer shell.

## CURRENT TRENDS IN THE MINIATURIZATION OF ULTRASOUND IMAGING TECHNOLOGY

Since the advent of medical ultrasound imaging in the late fifties, a continuous improvement in terms of image quality and real-time operation has taken place, and an increasing number of clinical applications and image modalities have appeared. Also important, is that ultrasound systems have decreased in size and are now available from portable high-end systems to hand-held low-end systems. The technological achievements are due to vast developments that have taken place in engineering fields such as acoustics, electronics, material physics, and signal processing. The motivation to develop ultrasound system hardware components of smaller size is driven by different factors, for example:

1. To develop small instruments with good image quality that can be operated anywhere in the field, driven by batteries.
2. In the development of real-time 3-D ultrasound imaging systems using 2-D phased-arrays, the amount of system channels is substantially increased, requiring too much space and dissipating too much heat unless electronic components can be made very small.
3. Intra-cardiac and intra-vascular imaging using tiny transducer arrays inside 1 mm catheters.

## WHY ARE TODAY'S HIGH-END ULTRASOUND SYSTEMS NOT ALREADY HAND-HELD?

Fundamental technical challenges are present for transducer design and electronics, and trade-offs are needed on the expense

of image quality. One of the main technological challenges in the miniaturization of ultrasound system components is making the high-voltage transmit electronics small. Further the miniaturization of receive electronics and signal processing boards is progressing steadily, but power consumption and heat generation is of major concern and needs to be reduced. One potential solution which is given attention especially in high-frequency imaging today, is to integrate future transducer technology and electronics directly on silicon wafers for miniaturized production.

## WHAT COULD THE NEXT-GENERATION DIAGNOSTIC ULTRASOUND IMAGING SYSTEM LOOK LIKE?

Envision a PDA-sized instrument with extreme portability (pocket-sized, lightweight, thin cable), with an image quality close to high-end systems, a lower cost compared to high-end systems, an extended battery life for more than one hour, easy to use with a simple user interface, semi-automatic image optimization, and limited to specific clinical application functionality. Indeed, instruments close to these specifications have already been launched on the market and in continuous smaller versions from 2000 till today. A true hand-held instrument was recently released on the market from Siemens (Siemens P10), and more are sure to follow from the major manufacturers and smaller niche companies.

## POTENTIAL FUTURE USES IN BAROMEDICINE

Some visions of the potential use of miniaturized ultrasound instruments in baromedicine can be entailed:

- Field monitoring: Hand-held systems with Doppler measurements and B-mode imaging can more easily be brought to the field for monitoring and research.
- Continuous monitoring: Extremely small battery operated devices in the size as a diver watch could be strapped around the arm or around the neck for continuous monitoring during diving and decompression. Indeed small systems already exist for instance in fetal heart beat monitoring and for detecting pulse / perfusion during resuscitation.
- Implantable devices: Simple transducer devices for Doppler imaging can be made small enough to fit on implantable devices, powered by an outside source. For instance, embedded in stents or as a clamp around peripheral vessel of interest.

For sure, many more applications can be envisioned. As some additional pointers, in addition to miniaturization, higher frequency imaging will make it possible to detect smaller bubbles, and more advanced signal and image processing may improve methods for bubble detection. We leave this subject open for discussion!



The ultrasound research group at the Department of Circulation and Medical Imaging at NTNU in Trondheim has developed a new method for detecting contrast agents, which gives better resolution and improves the sensitivity compared with traditional techniques. The method is called SURF (Second Order Ultrasound Field) Imaging, and instead of one pulse being transmitted as in traditional ultrasound transducers, the SURF method transmits two pulses simultaneously (Fig. 1). One pulse is used to manipulate the size of the microbubbles, and the other is used for detection of the change in size. By utilizing the nonlinear nature of the contrast agents (gas bubbles are easier to expand than to compress), one can filter out specific parts of the reflected signal in order to detect the agent of interest (Måsøy et al., 2008).

In relation to decompression induced microbubbles, it is accepted that the process of bubble formation starts by microscopic bubble nuclei. *De novo* formation of gas bubbles requires an unrealistic pressure gradient in relation to normal decompression activity. But, by definition, no one has actually seen these bubbles in non-diving subjects. They are believed to be in the order of 1  $\mu\text{m}$ , and there are no detection systems available today which can highlight such small bubbles. However, the SURF technology is well suited for decompression induced microbubbles, since it can be designed to detect specific size gas bubbles, and filter out all other disturbing signals. The result is that in a standard ultrasonic picture where you can not see any bubbles at all, the SURF can visualize the presence of bubbles if they are in the same size as ultrasound contrast agents. And in theory, one can build transducers based on the SURF technology which can detect microbubbles down to 2  $\mu\text{m}$ .

## LITERATURE CITED

Boycott, A.E., G.C.C. Damant, and J.S. Haldane. 1908. The prevention of compressed air illness. *Journal of Hygiene Cambridge* 8:342–443.

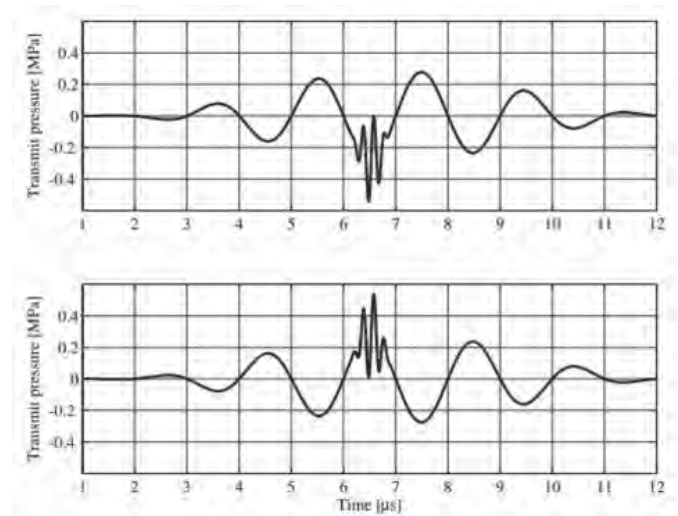

**FIGURE 1. SURF-pulse complexes for contrast agent detection and imaging. For additional information, please visit: <http://www.ntnu.no/surf/>.**

- Blatteau, J.E., J.B. Souraud, E. Gempp, and A. Boussuges. 2006. Gas nuclei, their origin, and their role in bubble formation. *Aviation, Space, and Environmental Medicine* 77:1068–1076.
- Eftedal, O.S., H. Tjelmeland, and A.O. Brubakk. 2007. Validation of decompression procedures based on detection of venous gas bubbles: A Bayesian approach. *Aviation, Space, and Environmental Medicine* 78:94–99.
- Måsøy, S.E., Ø. Standal, P. Näsholm, F. Johansen, B. Angelsen, and R. Hansen. 2008. SURF Imaging: *In vivo* demonstration of an ultrasound contrast agent detection technique. *IEEE Transactions on Ultrasonics, Ferroelectrics, and Frequency Control*. In press.
- Nishi, R.Y., A.O. Brubakk, and O.S. Eftedal. 2003. Bubble Detection. In Brubakk, A.O., and T.S. Neuman, eds. *Bennett and Elliott's Physiology and Medicine of Diving*, 5th ed: London: Saunders. Pp.501–530.
- Vann, R.D. 2004. Inert Gas Exchange and Bubbles. In Bove, A.A., ed. *Bove and Davies' Diving Medicine*, 4th ed. Philadelphia: Saunders. Pp. 53–77.



# The Future of Dive Computers

*Michael A. Lang and Sergio Angelini*

---

**ABSTRACT.** The age of electronic diving has arrived with the development of the modern electronic dive computer as the most significant advancement in self-contained diving since the invention of the Aqualung by Jacques Cousteau. Twenty-five years after modern day dive computer introduction several key questions remain surrounding the decompression models used, validation and human testing, acceptable risk, limitations, failures, and operational reliability. A brief history of analog dive computers and electronic digital computers and their function is discussed. Existing decompression models incorporated into dive computers are discussed with comments on the variety of approaches since Haldane. Educated predictions are offered on the functionality, features and configurations of future dive computer evolution based on benefits from advances in consumer electronics technology, and monitoring technology integrated into the dive computer algorithm that allows for a closer approximation of physiological parameters. Final remarks conclude with how advances in diving physiology research based mainly on Haldane's original work in 1908 will shape the dive computer landscape of the future.

## INTRODUCTION

Historically, the diving community has depended predominantly on the United States Navy Air Decompression tables, a direct descendant of Haldane's work, which has served divers well for over five decades. Dive computers, utilizing mathematical models of human tissue compartments and gas exchange, allow the constant computation of the diver's decompression status during the dive. They vary in the assumptions incorporated in their models and in their capabilities. As predicted by Lang and Hamilton (1989) these real-time tools now enjoy widespread use in the recreational, scientific and military diving sectors. Logically, dive computer evolution was a natural progression from decompression tables and as they experienced several generations of development. Computers replaced the diver's watch and depth gauge, provided greater accuracy and computerized, real-time, at-depth, continuous dive profile data, eliminating the need for the diver to remember tables and make decompression decisions while under water and while multi-level diving, allowed for longer bottom times than permitted by tables. Many divers are highly motivated in their activities and interested in maximizing underwater time and efficiency. They view decompression requirements as a hindrance and distraction from their dive objectives, yet are generally concerned about safety.

Evaluations of the available databases on pressure-related injuries to examine the effectiveness of dive computers showed that these devices had demonstrable advantages over dive tables. It remains clear that neither tables nor dive computers can eliminate all decompression problems, which have a probabilistic component to their occurrence. However, the current generation of dive computer technology represents an important tool for further improving diver safety. Divers Alert Network has managed to collect 172,000 dive profiles from 1999 to 2009 through its Project Dive Exploration (PDE), a

worldwide study of recreational diving to record more than one million dives to produce statistically accurate analyses of depth profiles, diver characteristics, and diver behavior. This collection of real-time depth/time profiles for statistical analysis and modeling will assist in characterizing the relationship between diving and health effects, developing flexible, low-risk decompression procedures for multilevel, multiday repetitive diving; and studying the effects of flying after diving.

Since the appearance of the first commercially mass-produced electronic dive computer, the 1983 ORCA Industries' EDGE model, the operational experience with dive computers is enormous, yet some key considerations remain:

1. **Decompression models:** What models are dive computers programmed with? Does it matter? Should the manufacturers specify the model in their brochures? What are the primary criteria for model effectiveness and "acceptability"?
2. **Validation and human testing:** What comprises an acceptable validation protocol? Should all computers be tested on human subjects with Doppler monitoring? If so, what type of dive profiles should be used, and what does this really prove? And the rejection criteria would be what exactly? Comparisons with existing decompression tables demonstrate the range of no-decompression limits (NDLs) for tables and computers. For square-wave dive profiles, NDLs of dive computers are generally more conservative. Multi-level profile comparisons are more tenuous because of mechanical constraints of the organization of dive table limits versus real-time interval updates of dive computers. Should the manufacturer publish validation data or divulge their modifications or adjustments of published algorithms? Should they be evaluated by an independent agency?
3. **Acceptable risk:** It is generally recognized that zero bends is unachievable and that for operational reasons sectors of the diving community accept different DCS rates. What levels of "bends" risk are acceptable?
4. **Limitations:** Should depth and time limitations be imposed on dive computers? If so, how is this determined? Specifically, what is the applicability of dive computers with regard to long shallow dives, short deep "bounce" dives, stage-decompression dives, repetitive multi-day, multi-level dives, reverse dive profiles, variable ascent rates, diving at altitude and desaturation levels for flying after diving.
5. **Dive computer failure:** What is a diver to do regarding decompression during or after a dive should the computer fail? Are there standardized contingency plans to continue diving after a computer failure, or a requirement for a back-up dive computer?
6. **Operational reliability:** The operational experience has been generally good. Are there specific dive computer component or battery failures? Should the manufacturer provide reliability data?

The incidence of decompression sickness would appear to be

an appropriate metric to evaluate the efficiency of dive computers. Assuming that the diver wore the computer, actually looked at it during the dive, and the computer can be interrogated by the hyperbaric chamber operator, useful dive profile information can be retrieved and used in treatment decision making protocols.

## HISTORY

The introduction of scuba in the mid-1940s changed diving operations that were carried out by hardhat divers using surface-supplied air for dives at single depths for as long as they needed to complete the mission while decompression status was monitored by surface tenders. Scuba divers without surface contact now had to be responsible for their own decompression status under water. Without an unlimited air supply from the surface the repetitive dive concept became an actuality with the exchange of full scuba cylinders. Three-dimensional freedom of movement during a dive led to multi-level dive profiles.

Various mechanical and electrical analog and microprocessor-based digital dive computers to determine a diver's decompression status in real time have been produced since the advent of scuba in the 1950s. Current computers only use depth and time as variables to compute decompression status. Future computers should incorporate individual and environmental variations and additional variables that play a role in decompression sickness susceptibility, and perhaps ultimately monitor actual inert gas levels in the diver.

The U.S. Navy Committee for Undersea Warfare and Underwater Swimmers met in 1951 at Scripps Institution of Oceanography to identify improvements required in scuba diving equipment and how to control the decompression of a non-tethered, free swimming scuba diver. Groves and Monk's (1953) report established the foundation for most of the early designs for decompression devices and presented a preliminary design for a diver-carried pneumatic analog computer which simulated nitrogen uptake and elimination in two theoretical tissue groups and summarized its benefits:

The gauge automatically takes into account the depth-time history of the entire dive. The resulting continuous 'optimum ascent' should be somewhat more efficient than the usual step-wise ascent, the latter being used only because of its greater simplicity of presentation in tabular form. There are two other situations for which the gauge is conceivably an improvement over the table. For repeated dives the gauge automatically takes into account the residual elevation of nitrogen pressure in the body from the preceding dives. (Divers are known to be more subject to bends on subsequent dives.) In the case of an emergency ascent, such as may be required by an exhaustion of breathing air, the gauge gives some indication of the desirable recompression procedure.

This report also included a basic design for the "Ultimate Gauge," an electrical analog computer that would show both decompression and air consumption status so that the diver would know if the remaining air supply would be sufficient to

perform the required decompression schedule.

Searle (1956) indicated in a Navy Experimental Diving Unit report the need for some type of decompression device because of the ever-widening fields of both civilian and military free-swimming diving using self contained breathing apparatus. Particularly when scuba diving was untended from the surface, there arose a very pressing need for a small portable apparatus to be used by the diver to indicate proper decompression and ascent. Huggins (1989) thoroughly reviewed the history of dive computer evolution through 1988.

## ANALOG COMPUTERS

### *1955: Foxboro Decomputer Mark I*

Designed by Hugh Bradner and Mead Bradner, manufactured by the Foxboro Company with 40- and 75-minute halftime compartments (both with 1.75:1 surfacing ratios), a pneumatic design, and 5 bellows (Fredrickson, 1956). Nitrogen absorption and elimination from the compartments was simulated by the flow of gas through porous resistors between bellows, which were exposed to the ambient pressure, and bellows sealed in a vacuum, kept under a constant pressure by a spring. Searle's (1956) evaluation reported the actual compartment half-times simulated by the Foxboro Decomputer Mark I as 27.7 and 52 minutes, causing deviations from U.S. Navy Table decompression ranges for some dives. No further development occurred because the U.S. Navy published new air no-decompression/decompression tables and repetitive dive tables in 1957. The Navy apparently rejected the idea of a decompression computer and accepted option "a" of the Groves and Munk report, i.e., depth gauge, watch, tables, and diver wits (Huggins, 1989).

### *1959: SOS Decompression Meter*

Designed by Carlo Alinari, manufactured by SOS Diving Equipment Limited as a one-compartment pneumatic computer with half-time variations with the pressure differential across the ceramic resistor. The ambient pressure increased on the flexible bag, forcing gas through the ceramic resistor (simulating nitrogen uptake and elimination in the body) into the constant volume chamber. The pressure increase was measured by the bourdon tube gauge, indicating the safe ascent depth to the diver. On ascent, the gas pressure in the constant volume chamber became greater than the external pressure and the gas flow reversed (Huggins, 1989). Howard and Schmitt (1975) evaluated ten SOS meters and determined their no-decompression limits to be more conservative than the U.S. Navy limits at depths shallower than 20 msw, but less conservative at deeper depths.

### *1963: TRACOR Electrical Analog Computer*

Developed by Texas Research Associates Inc. as the first electrical analog decompression computer, employing a 10-section

ladder network of series resistors and parallel capacitors to simulate nitrogen diffusion within the body. Ambient pressure measurement was supplied by a depth sensor that varied the voltage supplied to the network. Two 1/2D alkaline cells powered an oven that housed the electronics and kept them at a constant 90 °F. Four small mercury batteries were used as the computer network power source. The display was a micro-ammeter calibrated in fsw displaying how many feet the diver could safely ascend. Workman (1963) found that minimal decompression requirements were adequately predicted for schedules throughout the depth range tested (40–190 fsw) for ascent rates of 20 and 60 fpm. Longer and deeper exposures were not provided adequate depth and total decompression time at stops compared to the U.S. Navy air decompression tables. Continuous ascent decompression predicted by the TRACOR computer was inadequate both in depth and duration of total decompression time. Temperature dependency of the instrument was excessive, particularly for cold exposures, and resulted in widely varying decompression requirements for the same dive schedule. Workman (1963) further suggested that a mechanical analog computer could be used to avoid the instability and breakdowns that occurred in the electrical circuitry.

### *1962: DCIEM Analog Computer Series (Nishi, 1989)*

Developed by D.J. Kidd and R.A. Stubbs at the Defence and Civil Institute for Environmental Medicine (DCIEM) with four compartments to simulate the nitrogen absorption and elimination in the diver. Initial versions' compartments were arranged in parallel, the final design's arranged in series, resulting in the Kidd-Stubbs decompression model (Kidd and Stubbs, 1966). The MARK V S was the first thoroughly tested, successful decompression computer. The four serial compartments gave effective half-times of 5 to over 300 mins (Nishi, 1978). The display consisted of a depth gauge face with two needles: one to indicate the diver's present depth, and the other to indicate the depth to which the diver could safely ascend (Huggins, 1989). The unit was small enough to fit into a housing 9 cm in diameter and 18 cm long, which could be easily carried by a scuba diver. Another version of the device, called the MARK VI S, was designed utilizing the same algorithm for hyperbaric chamber use. The MARK V S was produced by Spar Aerospace in the late 1960s for sale to industrial and military agencies with operational depth limits to 60 msw. In 1970, Spar developed a smaller and lighter version operational to 90 msw. Due to the complexity of construction, high manufacturing costs, and extensive maintenance and calibration requirements, the MARK VS computer was not a commercially viable product for recreational divers.

### *1973: GE Decompression Meter*

Designed by Borom and Johnson (1973) utilizing semipermeable silicon membranes to simulate nitrogen diffusion. These



membranes operated better than porous resistors because the simulated half-time of a compartment did not vary with depth (as in the SOS meter). A four-chamber device was built to simulate the U.S. Navy Air Decompression Tables using compartment half-times of 24, 39, 90 and 144 mins. Initial evaluations by GE showed that the membrane-based decompression meter concept was sound. The size of the unit could be reduced and temperature dependence was “well within satisfactory limits.” However, no information on any subsequent development and testing was available (Huggins, 1989).

### 1975: Farallon Decomputer

Manufactured by Farallon Industries, the device was a pneumatic analog computer utilizing four semipermeable membranes (two for gas uptake, 2 for elimination) that simulated two theoretical tissue groups. Air from the collapsible gas chamber flowed through the “fast tissue” (large) and “slow tissue” (small) membranes when exposed to elevated pressures. The increased pressure within the mechanism caused the pistons to move along the display color-coded green, yellow, and red, indicating the diver’s decompression status. When the ambient pressure was reduced to a lower pressure than inside the tissue simulator, the air flowed out through the “repetitive dive membrane.” Both compartments had offgassing membranes that simulated a slow offgassing rate. Testing at Scripps Institution of Oceanography determined that the Farallon Decomputer failed to “approximate” the U.S. Navy Air Decompression limits and repetitive dives proved even less acceptable, was too permissive, and developed too much mechanical deterioration with use (Flynn, 1978).

### DIGITAL COMPUTERS

The dive computer consists of a watertight housing with a through-hull pressure transducer that transforms pressure sensed through an analog-digital converter to the microprocessor, powered by a battery. Read-only memory, random-access memory and a clock feed into the microprocessor, which outputs information to the diver via the computer’s display (Fig. 1). Huggins (1989) outlined the evolution of a series of digital dive computers once the microprocessor revolution was underway in the mid 1970s. DCIEM unveiled the XDC Digital Decompression Computer Series using the Kidd-Stubbs model. The XDC3 Cyberdiver was actually the first diver-carried microprocessor-based underwater decompression computer. Like the Cyberdiver, the DACOR Dive Computer suffered from very high power consumption and was a US Navy dive table reader. Thalmann (et al., 1980; 1983; 1984) and Presswood et al. (1986) worked on developing an E-L (exponential linear) decompression model and algorithm to program into an Underwater Decompression Computer to be used with the USN constant partial pressure of oxygen closed-circuit mixed gas system. This model assumed that nitrogen absorbed by tissues at an exponential rate

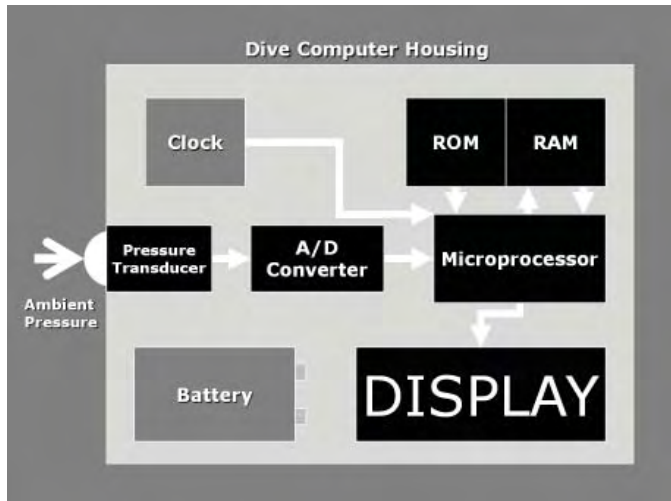

FIGURE 1. Dive computer schematic.

(as in Haldanean models), discharged at a slower linear rate. In 1996, Thalmann’s VVAL 18 model was tested in the USN’s Cochran Navy dive computer.

ORCA Industries, Inc. released the EDGE (Electronic Dive Guide) in 1983, the world’s first commercially successful, mass produced electronic dive computer that paved the way into this new approach to decompression status monitoring. The ORCA 12-compartment model (half times from 5 to 480 mins) was based on no-decompression limits (to 130fsw) determined, in part, by Doppler ultrasonic bubble detection (Spencer, 1976). The EDGE display was perhaps one of the most innovative to date, divided into graphical and digital information split into two sections by a curve (limit-line) representing the maximum pressure (M-values) allowed in the twelve compartments. One glance by the diver established whether all compartment bars were above the limit-line, indicating a no-decompression dive. The SkinnyDipper (also distributed as a private labeling, Sigmatech, by Sherwood Scuba) from ORCA Industries utilized the same decompression model as the EDGE, but its simpler display scheme consisted of three numerical segments and no graphics. The SME-ML, a nine-compartment Haldanean model with half-times ranging from 2.5 to 480 mins, is also based on Doppler research and was manufactured by SUUNTO of Finland. It stored ten hours of dive information that could be recalled at any time after the dive. The Datamaster II (also distributed as the DataScan II by U.S. Divers Co.) was manufactured by Oceanic using a pseudo-Haldanean decompression model of six compartments with half-times of 5 to 120 mins. This model allowed no off-gassing from the compartments until reaching the surface. The Datamaster II led the way in calculating air consumption, tank pressure and air time remaining.

In 1979, the Hans Hass Decobrain I was a Swiss table-based computer for high-altitude diving that could perform multi-level computations using the table’s repetitive group designators but only by using the 80-minute half-time compartment, which easily put it “out of range” as a decompression

device. In 1985, the Decobrain II by Divetronic was based on Bühlmann's 16-compartment Swiss model (ZHL-16) developed with compartment half-times ranging from 4 to 635 mins and designed for altitude diving up to 4500 meters above sea level. Time to fly information was first introduced. The DACOR Microbrain (also manufactured by Divetronics) used six compartments (4.5 to 395 minute half-times) that corresponded to the 16-compartment Swiss model. The Aladin (Uwatec), G.U.I.D.E. (Beuchat) and the Black Fox (Parkway) is the same unit manufactured by Uwatec with a 6-compartment version of the Swiss decompression model utilizing four sets of M-values based on the altitude ranges of the dive. The Uwatec computer could be interrogated and the log entries for the last five dives recalled by activating two wet switches. The Aladin Pro Plus in 1987 was likely the second commercially successful mass-produced dive computer.

Huggins (1989) aptly concludes

It is interesting to speculate about the present state of scuba diving if the Foxboro Decomputer Mark I had performed properly and had been adopted for U.S. Navy use in 1956. If so, the present U.S. Navy air decompression tables might not have been computed and the standard tool used to determine decompression status might have been a dive computer. Dive computer technology would be far more advanced, and more information and studies about the effects of multi-level diving would be available today.

## DECOMPRESSION MODELS

In 1908 John Scott Haldane published a paper (Boycott et al., 1908) that to date represents the most significant milestone in decompression physiology. A multitude of researchers (Hills, 1966; Workman, 1963, 1965; Bühlmann, 1990) and many others over the years have published numerous versions of decompression models which, by and large, are all intrinsically linked to this century-old publication.

As a diver descends in the water column and is exposed to increased ambient pressure, the partial pressure of the inhaled inert gas is higher than that of the dissolved inert gas in the various bodily tissues. This imbalance leads to inert gas traveling from the lungs via the blood stream throughout the body, where it is absorbed in the various tissues at a rate which is a function of the tissue itself (e.g., muscle tissue will "load" up with inert gas faster than fat tissue). The characteristic by which a tissue loads with inert gas is defined by the term "half time", an artificial parameter that defines the time required for a tissue to equilibrate to within 50% of the imposed external pressure.

Similarly, as the diver ascends at the end of the dive and is exposed to a diminishing ambient pressure, the partial pressure of inert gas in a tissue will become higher than the partial pressure of the inhaled inert gas (supersaturation), and hence the inert gas transfer process is inverted. Excess inert gas is returned from the tissues via the blood stream to the lungs, from where it is eliminated by exhalation. The key concept in every form

of Haldanean implementation is that decompression sickness is preceded by inert gas bubbles forming due to excessive supersaturation. Therefore, a successful decompression strategy involves controlling the supersaturation in each tissue within defined values. The various versions of Haldanean models differ primarily in the number of tissues considered, their half times and their tolerance to supersaturation (up to the tipping point of bubble formation) and mathematical tricks are applied to cover a variety of influencing factors (e.g., cold, workload, repetitive diving). The primary reason for the success of Haldanean models is that, in spite of their simplistic approach, a vast amount of data exists to which the models have been fitted. Similar to the flower-like trajectory of Mars around the Earth in a Ptolemaic view, enough empirical observation and data fitting can make any model yield excellent results within its tested range.

During the 1980s the prevailing opinion was that bubbles formed during almost all dives, even those not producing any sign or symptom of decompression sickness. This prompted a new wave in decompression modeling that implicitly included bubble formation and growth, and its consequences to the diver. As a main departure from the Haldanean model, inert gas was not only present in dissolved form, but also in free form as a bubble. David Yount proposed a free-phase decompression model, the Variable Permeability Model (Yount and Hoffman, 1986), Michael Gernhardt the Tissue Bubble Dynamics Model (Gernhardt, 1991), and Wayne Gerth and Richard Vann (Gerth and Vann, 1997) the Probabilistic Gas and Bubble Dynamics Model. The most widely implemented model in a simplified version in a variety of dive computers is the Reduced Gradient Bubble Model (Wienke, 1990). Gutvik and Brubakk (2009) are the proponents of Copernicus, and Lewis and Crow (2008) presented an introduction to their Gas Formation Model (GFM). Whereas Yount and Hoffman, and Wienke consider supersaturation as a mechanism to begin bubble formation, Gernhardt, Gerth and Vann, and Gutvik and Brubakk track bubbles from their initial form as microscopic nuclei and follow their evolution and growth as the dive progresses. These latter models are of considerable higher mathematical complexity and cannot be solved within the realm of a modern microprocessor.

The overarching goal of future dive computer models should be to more closely reflect the individual physiology of the diver, evolving as a true electronic instrument designed to solve a physiological problem. Moon et al. (1995) reinforced that the probabilistic models on which tables and computers are based should reflect the individual reality of the divers, to enable them to conduct their dives in accordance with their individual characteristics.

## ASCENT RATES, REPETITIVE DIVING, TIME TO FLY, AND MIXED GAS FUNCTIONS

Divers must adhere to the manufacturer's recommended ascent rate, whether variable or uniform, which is an integral

component of the algorithm's tissue tension calculations. Training in, and understanding of, proper ascent techniques is fundamental to safe diving practice, including mastering proper buoyancy control, weighting and a controlled ascent with a "hovering" safety stop in the 10–30 fsw zone for 3–5 min (Lang and Egstrom, 1990). It is in the ascent phase of the dive that computers reveal one of their strengths. Existing computers have maximum ascent rates that do not exceed 60 fsw/min from depth and many are limited to 30 fsw/min in shallower water. Future dive computer models may favor slower rates but we make the observation that operationally, the 30 fsw/min is achievable and effective, while slower rates most likely are not.

Multi-level, multiday repetitive computer diving within the tested envelope is the mainstream practice today, and it appears to be less stressful than square wave profile diving. Deep repetitive dives with short surface intervals should nevertheless be given special consideration. Because of limited analysis of the existing profile databases, no firm conclusions have been reached regarding repetitive diving limits to date (Lang and Vann, 1992). The maximum depth sequence of repetitive dive profiles is not restricted by dive computers. Lang and Lehner (2000) found that there was no physiological reason for prohibiting reverse dive profiles for no-decompression dives less than 40 msw (130 fsw) and depth differentials less than 12 msw (40 fsw) because this was never a rule in either U.S. Navy or commercial diving, but more of an operational constraint of the organization of depth/time profiles in a square-wave table format.

There exists no dependable distinction between "safe to fly" and "not safe to fly" in dive computers. There is a gradual reduction of risk for which the diver needs to choose an acceptable degree (e.g., wait at least 24 hours, the longer the wait, the further the reduction in probability of decompression sickness). Lang and Hamilton (1989) provide examples of dive computer computations for "time to fly" that include offgassing to 1–2 fsw (2–4 psi) over ambient pressure, waiting until 12 hrs have elapsed after the last dive, or not exceeding 0.58 bar as maximum ceiling setting (against a minimum aircraft cabin pressure of 0.75 bar).

Adjusting oxygen fractions in dive computer software from 0.21 to standard oxygen-enriched air (nitrox) of 0.32 or 0.36 is simple and an available function of most computers. Huggins (2006) evaluated several dive computers capable of calculating heliox and trimix dive profiles (the EMC-20H by Cochran Undersea Technology, the HS Explorer by HydroSpace Engineering, the NiTek He by Dive Rite, and the VR3 by Delta P Technology). The decompression software that purportedly emulated these four dive computers was used to calculate the response to specific 300 fsw/20 min total bottom time (TBT) dive scenarios, including decompression gas switches. Huggins opined that in surface-supplied mixed-gas operations diver-carried dive computers are best used as a backup and that the major control of decompression should be assigned to the surface-support personnel using a preplanned set of heliox or trimix tables that the dive computer emulates.

## THE FUTURE: FUNCTIONALITY, FEATURES AND CONFIGURATIONS

The dive computer of the future will benefit from advances in science and technology. These can be grouped into three distinct categories: benefits from advances in consumer electronics technology, monitoring technology integrated in the algorithm, and advances in decompression physiology research.

### BENEFITS FROM ADVANCES IN CONSUMER ELECTRONICS TECHNOLOGY

The combined worldwide sales of dive computers from all manufacturers does not exceed 500,000 units per year, while Apple alone sold over 30 million iPhones in the first 12 months. It becomes obvious then that dive computers do not drive new technologies, but rather benefit from a trickledown effect. In a world dominated by PDAs, Smartphones and iPods, not only is the technological development unbridled, but the cost of these new technologies keeps declining and becoming more affordable. Hence, in spite of the relatively small volumes of dive computer produced, we can expect to start seeing more and more advanced embedded technologies. Other outdoor activities, such as hiking, climbing and camping, are also promoters of new technologies that can find an application within a dive computer.

#### *High Resolution Color Display*

Barring a few exceptions dive computers today utilize a segment display. In these types of displays, information is presented by "turning on" certain segments within a large array. Due to the constraints of fitting a wide variety of information on a small display, segment displays typically present only numbers and symbols. Advantages of this technology are low energy consumption and very sharp representation. The main disadvantage, however, is the inability to show anything other than what is "preprogrammed" into the display. This means that any interaction between the diver and the computer takes place through a display of numbers and symbols. In an emergency situation, the diver sees blinking symbols and/or numbers and from this has to infer the nature of the emergency and take appropriate action. The possibility exists that, if the diver does not recognize or otherwise understand the meaning of the blinking symbol, this can lead to an increase in stress in the diver and could potentially precipitate a risky situation.

The switch to a high resolution color display is the most obvious consequence of the proliferation of PDAs and Smartphones. Color dot-matrix displays can play an important role in enhancing the safety of the dive in many ways:

- a. Before the dive: menu navigation via text in a language of choice means simplicity and clarity in setting up the computer for the dive;
- b. During the dive: one obvious advantage is the clear

representation of all relevant information, possibly with a choice of font size and in a pattern customized by the user. In addition, the combination of text and color can be tremendously helpful in alerting the diver of a potentially risky situation by describing the exact nature of the problem and recommending a course of action. For instance, a diver on nitrox exceeding the maximum operating depth of the breathing gas would see a clear text message such as MAX OPERATING DEPTH EXCEEDED (the nature of the problem) followed by a clear text message such as ASCEND TO 40 MSW (the recommended course of action).

- A dive computer with a standard segment display cannot do more than beep madly and show blinking symbols; and,
- c. After the dive: logbook viewing function with several pages of information, including a graphic representation of the dive.

#### *Rechargeable Battery*

Today's computers function well with replaceable batteries, allowing between 100 and 800 dives before the battery runs out. In most cases replacing the battery is a very simple process which, combined with a battery price of a few dollars/euros, makes this an attractive solution. Reliability, an important factor in a life support system, is also very high in this configuration. Color displays, however, require higher energy consumption and thus the switch to a rechargeable battery becomes necessary. With a typical lifetime of 500 charge/discharge cycles and assuming 5 to 10 dives on each full charge, this would allow 2500 to 5000 dives before the battery needs to be replaced. Charging of the battery can take place via a USB cable connected to a PC or directly to a power outlet, or, as in the case of the UEMIS Scuba Diver Assistant, via solar cells.

#### *GPS Receiver*

GPS receiver use has become wide spread in outdoor instruments and the automotive industry, where its role is of much higher importance and obvious benefit than in a dive computer. GPS works only through air, hence on the surface, and therefore an application in a dive computer might seem inappropriate. However, it would allow divers to locate dive sites simply by recording their GPS coordinates. Additionally, at the end of the dive, the emerging diver would be able to estimate the distance and direction from the point of entry (boat or shore), which could be useful in a situation of low visibility.

#### *Underwater Communication and Navigation*

Communicating underwater with the dive buddy or even all the way to the dive vessel would represent an enormous step forward in diver safety (but perhaps not necessarily in dive enjoyment, because many divers love diving for the peace and quiet provided by the silent world). Furthermore, with the proliferation of navigation systems in automotive technology,

it seems only logical to have similar gadgets guiding us through a dive. Data transmission underwater over a certain distance requires the use of ultrasound technology. Radio frequency, as utilized for instance for the transmission of tank information from a sensor on the first stage regulator to the dive computer, is strongly attenuated by water and thus would require too much power to be useful over a longer distance. Ultrasound, on the other hand, can travel very far underwater with relatively little power. Unfortunately, ultrasound is not necessarily a universal technology in consumer electronics, hence its integration in a dive computer may not be in the near future. Attempts have been made though, and for professional use there are voice communication systems which, though bulky, function rather well. GPS-like underwater navigation would require the reproduction of a satellite system for triangulation (set of buoys that translate the GPS signal from the surface to an ultrasound signal underwater) and, as such, would be costly and cumbersome. Simpler devices, which only show the direction and distance to the boat, have been introduced several years ago (Uwatec NEVERLOST, Desert Star Systems DIVETRACKER) but have not enjoyed extensive market penetration.

#### *EPIRB*

Emergency Position Indicating Radio Beacon (EPIRB) is a distress signal technology utilized in the maritime industry. EPIRBs are tracking transmitters that aid in the detection and location of boats, aircraft, and people in distress. Strictly speaking, they are radio beacons that interface with Cospas-Sarsat, the international satellite system for search and rescue (SAR). When activated, such beacons send out a distress signal that, when detected by non-geostationary satellites, can be located through triangulation. Often using the initial position provided via the satellite system, the distress signals from the beacons can be homed in on by SAR aircraft and ground search parties who can in turn come to the aid of the concerned boat, aircraft, or people. For instance, should a diver get carried away by a current during a drift dive, an EPIRB built into the dive computer would allow for a relatively quick location and rescue. The related technology is unfortunately rather costly and most divers may never need to be rescued at sea.

#### **BENEFITS FROM MONITORING TECHNOLOGY INTEGRATED INTO THE ALGORITHM**

The principal objective of a dive computer is to recommend an ascent schedule as a result of the diver's exposure to a specific depth/time profile. The depth defines the inert gas partial pressure in the inhaled breathing gas which, combined with the length of the exposure (time at depth), drives the inert gas uptake into the diver's tissues. Clearly, perfusion (blood circulation through the body) plays a significant role in that it transports the inert gas through the body from and to the lungs. Consequently, a change in perfusion during the dive, as may be



induced by exercise (increased perfusion) or exposure to cold (vasoconstriction in the arms or legs, hence a reduced perfusion), is expected to play a role in the on-gassing and off-gassing of inert gas. In particular, if the perfusion was increased during the deeper parts of the dive when much inert gas uptake is occurring, and/or the perfusion were reduced during the shallower parts towards the end of the dive, when inert gas elimination is occurring, the simplistic approach of considering only inert gas partial pressures may not be sufficient. In today's dive computers evidently enough conservatism is built in to cover these effects, as evidenced by the relatively low incidence rates of decompression sickness.

There are attempts to account for changes in perfusion. One approach is to lump any deviation from a "normal" exposure into additional conservatism in the model ("personal factors"). The clear disadvantage of this method is that the diver needs to define and predict before the dive whether strenuous exercise or chilling is expected to occur. The other approach, followed at the moment only by UWATEC and UEMIS, is to evaluate changes in perfusion based on actual measurements during the dive. An increase in workload is measured either by heart rate monitoring (UWATEC) or by a change in breathing pattern (UWATEC and UEMIS). Cold water effects, which theoretically could lead to a reduction in perfusion during the decompression phase of the dive, are based on the concept that the colder the water, the more vasoconstriction plays a role (Angelini, 2007). A thermally insulated diver, however, may be warmer in 4 °C water than a poorly protected diver in the Caribbean, and here a pre-dive set cold factor could be more practical.

Regardless, in spite of the theoretical validity of the effect of changes in perfusion during the dive, the actual implementation within a decompression model has not been experimentally validated or clinically proven. A thorough review of cold as decompression sickness stress factor was performed by Mueller (2007). One can argue that diving is a reasonably safe activity and that therefore these model complications are uncalled for. Another point of view is that this is an indication of excessive conservatism in today's models so that, with proper implementation of these phenomena, a diver could enjoy more freedom.

However, as advances in science and decompression physiology are made, we propose the continued development of the following technologies:

1. **Heart rate monitoring.** There is a proliferation of heart-rate monitoring devices in most outdoor and fitness activities. As people become more aware of the importance of exercise to their well being, they also discover heart rate monitoring as an excellent tool for fitness evaluation. Recording the heart rate during a dive can be useful, besides from an implementation of workload-related nitrogen calculations, to become aware of how the body responds to the environment, leading to either increased comfort and enjoyment (recorded heart rate is low and consistent) or the avoidance of certain types of stressful dives (high and/or erratic heart rate).
2. **Skin temperature measurements.** Vasoconstriction is the result of the brain's recognition that the core body temperature is diminishing. In order to maintain the function of critical body parts the brain reduces blood circulation to the limbs (arms and legs) with their large surface to volume ratio to reduce heat loss and protect the heart, lungs, and brain. Skin temperature measurements transmitted to the dive computer would allow for a quantification of the cooling. In addition to an implementation of vasoconstriction in the decompression model, this could be very important as an alarm trigger for approaching hypothermia. Hypothermia is an acute danger when pain and feeling of cold disappears once the body gives up on shivering as a mechanism of generate warmth.
3. **Oxygen saturation measurement.** This is of primary interest to free divers because the risk of oxygen depletion and consequent shallow-water blackout is high. Nevertheless, this and other blood monitoring technologies could find applications in scuba or rebreather diving.
4. **Inert gas bubble detection.** Inert gas uptake and consequent off-gassing is in and of itself not the cause of decompression sickness. Problems can occur when the combination of excessive amounts of inert gas dissolved in the body and a diminishing ambient pressure lead to the gas coming out of solution and forming free gas bubbles in the body. Some decompression models attempt to describe this free gas formation, with all the complexity that follows from the physics associated with such an event. It would be very useful if it were possible to detect bubble formation during the dive, integrated into a feedback loop into the decompression algorithm (regardless of the nature of the algorithm itself). There exist, however, two rather large obstacles to this. First, the bubble detection technology existing today is based on ultrasound or Doppler monitoring, both requiring rather cumbersome equipment that could hardly be placed on a diver during the dive. The second problem is that bubbles really do not grow to a discernible level until 20 to 40 minutes after the dive, so that in-water detection might only be useful in extreme dives in which something went seriously wrong. On the other hand, this line of thinking could lead to the development of a similar or new kind of technology aimed at detecting a physiologically viable parameter that gives an indication of decompression stress in the body. Any parameter that gives online feedback into a decompression model as to the state of the diver with respect to potential DCS would be a tremendous benefit.

#### BENEFITS FROM ADVANCES IN DECOMPRESSION PHYSIOLOGY RESEARCH

As described above, decompression models in existence today are, aside from a few mathematical manipulations, almost



entirely based on the ideas of John Scott Haldane presented in the historic 1908 paper (Doolette, 2009). Actual bubble models that carry out the pertinent bubble-dynamics calculations (and the related non-linear differential equations) are too complex to be managed by the limited processing power of a dive computer microprocessor. Even if this were to be solved, what remains is the need to validate such a radically different approach to decompression. There is an attempt by the Norwegian University for Science and Technology to build a complete bubble model under the project name Copernicus. As much as the earth-centered planetary model was intrinsically flawed yet allowed reasonable ocean navigation via immense empirical observations of the movements of the stars (made to fit this wrong model), a sun-centered planetary system yielded much better and accurate results allowing for significant broadening of the range of validity of the model itself. Haldanean theory, which does not consider inert gas in free form, and consequently its effects on the human body, has been refined over a century with the input of Workman (1963), Bühlmann (1990), Thalmann et al. (1980) and Thalmann (1983; 1984) to name a few, and provides us today with an extremely valuable and powerful tool in spite of its underlying wrong assumption. Copernicus, the decompression model, is the attempt to find the sun-centered model for decompression physiology, yet at the moment the wealth of data with which the existing models have been refined gives the Haldanean-based models a clear advantage. Science and its related research should nevertheless persist in the pursuit of the “truth”. A full bubble model availability within a few years would be very welcome. Such a model should incorporate those aspects of relevance in approximating the human body such as body fat, age, gender, and fitness level.

## CONCLUSION

Electronic dive computers have for all practical purposes replaced dive tables in recreational and scientific diving and are increasingly implemented in particular segments of the military diving community. For the commercial diving industry and its standard operating methods of surface-supplied/controlled diving or saturation diving, a dive computer’s advantages in monitoring decompression status appear to be minimal. It would not be unreasonable to state that regardless of the number of algorithm variations incorporated in modern dive computers, they all appear to fall within an acceptable window of effectiveness based on available databases of pressure-related injuries. It is also clear that neither tables nor dive computers can eliminate all decompression problems, but if utilized conservatively, computers have emerged as an important tool for the improvement of diver safety.

All things considered, the dive computer’s functions of ascent rate monitoring, real-time computation of nitrogen balances, air consumption monitoring and profile downloading capability form a solid, reliable basis for advancements that will emerge in the future. Benefits from advances in consumer

electronics technology will undoubtedly incorporate features such as high resolution color display, rechargeable battery, GPS receiver, underwater communication and navigation, and EPIRB. Further, benefits from monitoring technology integrated in the dive computer algorithm will surely include heart rate monitoring, skin temperature measurements, oxygen saturation monitoring, and perhaps even inert gas bubble detection. We can only imagine the progress that John Scott Haldane’s brilliant decompression insight would have made had the dive computer tools available to us now and in the future been available to him 100 years ago.

## LITERATURE CITED

- Angelini, S. 2007. Cold water decompression. In Lang, M.A. and M.D.J. Sayer (eds.) *Proceedings of the International Polar Diving Workshop*. Svalbard, March 15–21, 2007. Washington, DC: Smithsonian Institution. pp. 55–62.
- Borom, M.P., and L.A. Johnson. 1973. A Decompression Meter for Scuba Diving Utilizing Semipermeable Membranes. Report X73CRD129. General Electric Company Corporate Research and Development.
- Bühlmann, A.A. 1990. Tauchmedizin: Barotrauma, Gasembolie, Dekompression, Dekompressionskrankheit, Dekompressionscomputer (German Edition). Berlin: Springer Verlag. 148 pp.
- Doolette, D. 2009. Haldane still rules. In: Lang, M.A. and A.O. Brubakk, eds. *The Future of Diving: 100 Years of Haldane and Beyond*. Washington, DC: Smithsonian Institution Scholarly Press. Pp. XX–XX.
- Fredrickson, P. 1956. The Analysis and Testing Decomputer (Mark I), Report MR-138, Foxboro, Mass.: The Foxboro Company.
- Gernhardt, M.L. 1991. Development and evaluation of a decompression stress index based on tissue bubble dynamics. Ph.D. Dissertation, University of Pennsylvania. 328 pp.
- Gerth, W.A., and R.D. Vann. 1997. Probabilistic gas and bubble dynamics models of decompression sickness occurrence in air and N<sub>2</sub>-O<sub>2</sub> diving. *Journal of Undersea and Hyperbaric Medicine* 24:275–292.
- Groves, G., and W. Munk. 1953. A decompression gauge for divers. SIO Reference Report 53–64. San Diego: University of California, Scripps Institution of Oceanography.
- Gutvik, C.R., and A.O. Brubakk. 2009. A Dynamic Two-Phase Model for Vascular Bubble Formation During Decompression of Divers. *IEEE Transactions on Biomedical Engineering* 56(3): 884–889.
- Hills, B.A. 1966. A thermodynamic and kinetic approach to decompression sickness. Doctoral Thesis, the University of Adelaide, Australia. 370 pp.
- Howard, R., and K. Schmitt. 1975. The Decompression Meter - Another Look. *The Undersea Journal* 3:9–13.
- Huggins, K. 1989. The history of underwater decompression devices and computers. In Lang, M.A. and R.W. Hamilton. (eds.) *Proceedings of the AAUS Dive Computer Workshop*. USC Catalina Marine Science Center. Costa Mesa: American Academy of Underwater Sciences. Pp. 7–29.
- Huggins, K. 2006. Evaluation of dive computer options for potential use in 300 fsw heliox/trimix surface-supplied scientific diving. In Lang, M.A., and N.E. Smith (eds.) *Proceedings of the Advanced Scientific Diving Workshop*. Washington, DC: Smithsonian Institution. pp. 47–64.
- Kidd, D.J., and R.A. Stubbs. 1966. Analog Computer Solution of Decompression. Defense Research Medical Laboratories. Toronto: Defence and Civil Institute for Environmental Medicine.
- Lang, M.A., and R.W. Hamilton (eds.) 1989. *Proceedings of the AAUS Dive Computer Workshop*. USC Catalina Marine Science Center. Costa Mesa: American Academy of Underwater Sciences. 231 pp.
- Lang, M.A., and G.H. Egstrom (eds.) 1990. *Proceedings of the Biomechanics of Safe Ascents Workshop*, Woods Hole, Massachusetts. Costa Mesa: American Academy of Underwater Sciences. 220 pp.

- Lang, M.A., and R.D. Vann (eds.) 1992. *Proceedings of the Repetitive Diving Workshop*, Duke University Medical Center. Costa Mesa: American Academy of Underwater Sciences. 339 pp.
- Lang, M.A., and C.E. Lehner (eds.). 2000. *Proceedings of the Reverse Dive Profiles Workshop*. Washington, DC: Smithsonian Institution. 295 pp.
- Lewis, J.E., and S. Crow. 2008. Introducing the Gas Formation Model. *Undersea Journal* 3<sup>rd</sup> quarter. Rancho Santa Margarita: Professional Association of Diving Instructors. Pp. 57–59.
- Moon, R.E., R.D. Vann, and P.B. Bennett. 1995. The Physiology of Decompression Illness. *Scientific American*. August issue. Pp. 54–64.
- Mueller, P.H.J. 2007. Cold stress as DCS factor. In Lang, M.A. and M.D.J. Sayer (eds.) *Proceedings of the International Polar Diving Workshop*. Svalbard, March 15–21, 2007. Washington, DC: Smithsonian Institution. pp. 63–72
- Nishi, R.Y. 1978. Real Time Decompression Monitoring by Computers. In *Hyperbaric Diving Systems and Thermal Protection*, OED Vol. 6, Johnson, C.E., M.L. Nuckols and P.A. Clow (eds.). New York: The American Society of Mechanical Engineers. Pp. 25–38.
- Nishi, R.Y. 1989. Dive Computer Experience in Canada. In: Lang, M.A. and R.W. Hamilton (eds.) *USC Catalina Marine Science Center*. Costa Mesa: American Academy of Underwater Sciences. Pp. 69–79.
- Presswood, C., E. Thalmann, and M. Curley. 1986. Test and Evaluation of Two Prototype Model Underwater Decompression Monitors. NEDU Technical Report No. 10–86. Washington DC: Navy Experimental Diving Unit.
- Searle, W.F. 1956. Foxboro Decomputer Mark I. Navy Experimental Diving Unit Technical Report No. 7–57.
- Spencer, M.P. 1976. Decompression Limits for Compressed Air Determined by Ultrasonically Detected Blood Bubbles. *Journal of Applied Physiology* 40 (2): 229–235.
- Thalmann, E., I. Buckingham and W.H. Spaur. 1980. Testing of Decompression Algorithms for use in the U.S. Navy Underwater Decompression Computer, Report 11–80, Navy Experimental Diving Unit.
- Thalmann, E. 1983. Computer Algorithms used in Computing the MK 15/16 Constant 0.7 ATA Oxygen Partial Pressure Decompression Tables, Report 1–83, Navy Experimental Diving Unit.
- Thalmann, E. 1984. Phase II Testing of decompression algorithms for use in the U.S. Navy Underwater Decompression Computer, Report 1–84, Navy Experimental Diving Unit.
- Wienke, B.R. 1990. Reduced Gradient Bubble Model. *International Journal of Biomedical Computing* 26: 237–256.
- Workman, R.D. 1963. Evaluation of a Decompression Computer Developed for Divers. NEDU Technical Report No. 1–63. Washington DC: Navy Experimental Diving Unit.
- Workman, R.D. 1965. Calculation of Decompression Schedules for Nitrogen-Oxygen and Helium-Oxygen Dives. NEDU Technical Report No. 6–65. Washington DC: Navy Experimental Diving Unit
- Yount, D.E., and D.C. Hoffman. 1986. On the use of a bubble formation model to calculate diving tables. *Aviation, Space, and Environmental Medicine* 57(2):149–156.

# Discussion: Decompression Physiology and Methodology

*Chairman: Otto I. Molvaer*

---

**M. Gennser:** The idea of self-experimentation was passed on by J.S. Haldane to his son J.B.S. Haldane who during the war spent many hours in chambers experiencing oxygen convulsions with Kenneth Donald and others. That became the ethics of environmental physiology back then, performing experiments on oneself. Another interesting aspect of his decompression sickness work, notwithstanding today's competition between gas-loading models and bubble models, is in his second conclusion of his 1908 paper where he states that the gas wash-out will follow the same kinetics as the gas wash-in, unless there is bubble formation.

**A. Brubakk:** Right, during World War I, because of the gas attacks, he also played an enormous role by studying the physiological effects of different gases. He performed a number of self-experiments breathing cyanide in order to develop the best gas masks. Haldane was in just about every field of environmental science at the time.

---

**O. Ellingsen:** Can you elaborate on your statement that Haldane was never a professor and there were probably political reasons? Also, Boycott's name was first author on the 1908 paper.

**A. Brubakk:** Boycott was not a scientist, he was a Navy man. Haldane's uncle John Burdon-Sanderson, held the Waynflete Chair in Physiology at Oxford where he stayed all his life. It is a complicated story but it is clear that Haldane stepped back and did not apply for a professorship when he could have done so because they thought it would be politically better to have other people in that position. As far as we know, he never got a professorship. That was maybe good because he had other things to do.

---

**B. Gardiner:** I came close to Haldane in that I actually had tea with his daughter Naomi Mary Margaret Mitchison while sitting at his house in Scotland. Naomi, 97 at the time, talked to me about daddy, which was quite profound.

---

**A. Hope:** Does bubble formation have anything to do with high-altitude sickness?

**R. Moon:** At the rate at which mountaineers can climb, probably not. The rate of decompression is so slow that at least in situ bubble formation due to supersaturation is very unlikely. If you read some of the accounts of balloon flights, the participants often describe inability to move during their high-altitude exposure. One wonders whether they were perhaps suffering not only from hypoxia, but also from decompression sickness. One other hypothesis was raised a few years ago: in the presence of hypoxia there could conceivably be acidosis, particularly within the brain, that could cause bubbling due to  $\text{CO}_2$ . The rate at which the acidosis occurs, if it even exists, given the high buffering capacity of the blood, makes that scenario unlikely. Bubble formation is therefore probably not important, except in situations where you can increase altitude very rapidly as in balloon flights or military fighter aircraft.

**A. Brubakk:** One revealing fact that may point in the direction that bubbles may have an important role is nitric oxide. If you can give NO, you can more or less totally eliminate the amount of gas bubbles. We also know that in hypoxia, NO production is reduced.

---

**M. Gennser:** Has there been any follow-up to Groves' experiments where he exercised Tibetans and high-altitude living South American Indians and measured pulmonary artery pressure? The Indians do not seem to have adapted in the same way after living 1,000 years at altitude.

**R. Moon:** As I recall the numbers, the Tibetans have been living at altitude for 20,000 years, perhaps 5,000 generations that seems to have resulted in this adaptation. The slide I showed you from Beall is the most recent study I know of suggesting that the mechanism of the Tibetan adaptation may be related to NO, which they have more of in their blood. The results show they had higher blood flow and oxygen delivery to the forearm and other areas as well.

---

**R. Richardson:** Myoglobin spectroscopy is a good mechanism to measure intercellular  $\text{PO}_2$ .

**R. Moon:** I believe we are getting closer to where we want to go with that.

**Ž. Đujić:** On the high-altitude pulmonary oedema, there are some publications related to polymorphism where subjects are more susceptible to increasing pulmonary artery pressure because of less nitrates in the blood, so it might be that there is some genetic predisposition to being more sensitive or resistant to the same level of hypoxia.

**R. Moon:** That disease seems to be an individual susceptibility issue due to genetic predisposition.

---

**D. Doolette:** In C. Balestra's model diagram of decompression sickness the focus in the beginning was almost entirely on vascular bubbles, but there is the possibility that bubbles forming in the tissue are also involved.

---

**A. Hope:** On the supersaturation issue, can you say anything about this area under the tissue curves? You can have fast tissues that are saturated when you stop. What about the slow tissues in air diving decompression?

**D. Doolette:** That is probably the reason why when you look at the no-stop data they came up with much greater allowed supersaturation for fast tissues than for slow tissues. Fast tissues will have a greater supersaturation and a greater driving force for bubble formation, but that only lasts a short amount of time. In our probabilistic models, where we are fitting back to data, the fastest compartments do not contribute equal amounts, because we have scaling factors that allow a fast compartment to be more or less important than a slow compartment as far as how much it contributes to the risk. I do not remember what those values are, so I cannot tell you what the relative contribution is. We find that the medium and slow compartments contribute most to risk, while the fast compartments you only need to describe in submarine escape data.

**A. Brubakk:** You have decompression models that have supersaturation and they are theoretical concepts. Then you evaluate how these theoretical models fit with your model by doing experiments where the end result is clinical decompression sickness. This is a very vague end point. A very well known decompression researcher said the symptoms of decompression sickness are very different, with more symptoms than syphilis and diabetes combined. The problem is in the use of an end point that is poorly defined.

**D. Doolette:** There is indeed difficulty with symptom definition, particularly when looking back at historical data. One of the great utilities of this technique for us is that we have data back to the 1940s. It is a way for us to use this huge body of information that we have, about 8,000 dives with that as end point, and driven modeling in that direction. It is difficult when doing a study on how to classify the very vague symptoms that people get. We do it purely by whether the diver was diagnosed with DCS by a Diving Medical Officer. Divers tend to know when they get bent.

**A. Brubakk:** It is not a problem when you have serious symptoms and the diver keels over and cannot walk. The issue is the subtle symptoms because we do not know their pathophysiology

or importance. What does it mean to grade symptoms, because this will have an effect on the endpoint?

**D. Doolette:** Laurent at Duke University has been looking into marginal symptoms which are not quite decompression sickness, but the diver is not quite well. He has cast some doubt on whether we should be counting those at all in our models.

**G. Perdrizet:** You are really fine-tuning the supersaturation to the tolerance of the individual. Other examples of tolerance to extreme environments of the individual may vary.

**D. Doolette:** That is an interesting point. It is actually an unavoidable part of the way that we study that we have to ignore that issue to an extent. Our modeling assumes that every dive is independent and yet it is not because we use the same divers over and over again. In that man-trial where we had just under 400 dives there were 81 or 84 divers, I cannot remember exactly because there were two trials going on at the same time. Some divers dived between 1 and 12 times on that study. Only one person only dived once, but everyone else in that study dived both profiles at least once. There is a problem with the population we can draw from. From the historical data that we have, it would be very hard to reconstruct how many times divers dived. There are techniques for looking at that, you can use mixed effect modeling and look at the individual as a random variable as well.

**P. Lindholm:** Do you have that data now for those dives?

**D. Doolette:** Yes, we could reconstruct it. If we go back to our data starting in the 1940s, we could probably find that data by going back to the original logs, but we do not have some of the old material on hand at the moment.

**Ž. Đujić:** These military divers exercise regularly, which of course makes a difference with respect to bubble formation and their effects on the body. Do you have information of what they do regularly besides diving?

**D. Doolette:** That information is not very well characterized. We had done VO<sub>2</sub> measurements on a few divers so we know what sort of VO<sub>2</sub> max values a typical diver has. It is a huge range of divers we have from very young guys to senior people. They all have to pass a physical exam annually and they all do physical training at least three times per week, but I do not have actual values.

**Ž. Đujić:** Do you take the pre-dive exercise regimen into account?

**D. Doolette:** All we have them do is fill out a questionnaire about what they have done, so we have that information. Because we are interested in operational procedures we do not restrict the divers much to not make it too artificial. When we are doing a purely scientific experiment, we may put more restrictions on the divers than normal. Otherwise, they do what they normally do, but let us know what that is. The pre-dive exercise can be quite variable.

**J. Ross:** Mild decompression illness is much more common than serious life-threatening decompression illness. Are you perhaps skewing your table to one event, mild decompression illness and not necessarily to the other severe decompression illness?



**D. Doolette:** That is quite possible because we do not distinguish between mild and serious decompression sickness and try to come up with a model for that. We try to design our dives to avoid serious decompression sickness for ethical reasons. It could possibly be the case that we are skewing our procedures, I do not know for sure but do not think so. We have come across that problem when we recently tested new no-stop limits. Our estimates of decompression sickness were about 2% incidence. We got less than that, only 1%, but they were all serious cases. That is a limitation of that technique. Central nervous system decompression sickness is not part of our model.

**O. Eftedal:** Ed Thalmann once commented that all symptoms, no matter how minor or trivial, must be considered because they impinge on decompression stress, which means that the definition of decompression sickness in your technique is very different from an operational sense.

**D. Doolette:** Ed said that in respect to testing. In our modeling we do count minor symptoms as well and assign a value of 1/10 of a decompression sickness incident. All minor symptoms are noted and incorporated into the model, although there is some debate of late as to whether we should be doing that.

**S. Angelini:** In the diagram of activity versus release, there was zero activity that was showing an order of magnitude higher release than in some cases with activity.

**S. Kayar:** That is because pigs, like humans, have *Methanobrevibacter smithii* in their natural intestinal flora. They also have microorganisms, as do we, that produce hydrogen ( $H_2$ ). *M. smithii* turns  $H_2$  into methane ( $CH_4$ ).

**S. Angelini:** How can you quantify the effectiveness of the bacteria with all the background noise?

**S. Kayar:** You first start up the dive profile with control animals with a 60% hit rate. How do you decide on that initial profile that produces enough hits? You do not want 100% hits because you would be so far over the limit that you could remove tons of gas and it would still not help. You do not want a 10% hit rate in your control group because then you have nowhere to go down to. The dive profile choice is not a sensible approach, it is a guess with a convenient depth, a convenient dive time, and decompression rate to see how many animals bend. The dive profile can then be adjusted up or down. If you are at the 50% bends rate, you are on the steep part of the curve, so a bit deeper profile should produce more bends but the pigs were not bending. We were continuously measuring the animals' methane production rate. The animals' native methanogens were battling us by doing biochemical decompression before we put more in.

**A. Hope:** Is there any chance that it is possible to consume the hydrogen in other tissues than the intestine? Can you also comment on the ultimate solution to the decompression problem, liquid breathing?

**S. Kayar:** Hydrogen consumption is limited to the intestines because there are no other areas in the mammalian body where you can put live bacteria that will not trigger an inflammatory response. Even though they are not pathogenic, these bacteria

are not in our tissues. If it works in the gut, why would you want to put it anywhere else? Biochemists suggested extracting the isolated enzyme and putting it anywhere in the body. But it is a foreign, bacterial protein that will produce an inflammatory response. You can do liquid breathing now if you do not mind never being able to come out of having your lungs filled with perfluorocarbons, but you will not have to worry about bending.

**C. Gutvik:** How do you diagnose DCS in your animal models?

**S. Kayar:** When you are dealing with a 60-70% hit rate, it is usually clear. It is a severe hit, the animals obviously have difficulty walking. There are also dubious "pig-headed" cases where the pig is fine, but just does not want to walk on the treadmill. It is on the bottom of the chamber and is turned on and off at a comfortable walking pace at 5-minute intervals.

**R. Richardson:** Is there a comment on the differences between wet and dry dives in the chamber?

**S. Gaustad:** Immersion prior to the dive adapted rats for swimming because immersion effects last for a couple of days. From the dry dives we got lots of bubbles. There is also a diuretic effect from immersion resulting in increased urine secretion.

**R. Richardson:** True, there is a lot of evidence that water immersion causes diuresis.

**D. Doolette:** The dry versus wet dives you showed were two very different dives in profile (depth and time) and dry versus wet, so the effect might not be as large as you imagine. In one very large meta-analysis of dry versus wet diving, they really wanted to be able to detect a large difference in decompression sickness in humans between the two, but physiologically, the effect was not as large as imagined.

**R. Richardson:** It may turn out that the NO specific role may be involved in the wet-dry business.

**E. Thorsen:** You demonstrated the interaction between oxygen radicals and nitric oxide production. Diving is associated with hyperoxia. How do different depths, with increased partial pressures of oxygen, affect the protective effect of nitric oxide?

**R. Richardson:** I am not sure about the actual effects, but in terms of the physiology of oxidative stress there are some paradoxes of free radical generation. Certainly, hyperoxia elevates oxidative stress and you are likely to have greater free radical stress. On the paradoxical side of that, if you are in hypoxia, you tend to have greater oxidative stress. The answer is hyperoxia will give you a greater chance for oxidative stress and therefore a greater chance for NO bioavailability. The protective role of antioxidants would be offensive in that situation.

**M. Gennser:** This spring we carried out a trial looking at exercise 24 hours before diving, compared to 2 hours before diving. When you have three conditions and you expect to see the lowest bubble scores in one of two conditions, it occurs in the third one. We found less bubbles in the control situation where they had not conducted any exercise prior to the trial. Our methods



were different from the teams of Dujic and Blatteau. We noticed that our subjects, although they had some hyperbaric experience, were not divers, whereas the other groups tested divers. This is something we will test further. Is there anything in divers that would affect the NO metabolism?

**R. Richardson:** There are a number of things that can occur, but I would immediately ask what the exact exercise paradigm was?

**M. Gennser:** It was the exact same intensity and duration as Dujic's trial.

**R. Richardson:** A lipid load or high fat meal can increase the NO bioavailability. You can reduce FMD (flow-mediated dilation) by 50% by having a McDonald's meal. In your case it does not sound like you were measuring FMD per se. Clearly, we are measuring FMD to look at NO and if the bubbles are involved you have to be very cautious while investigating endothelial function and relating it to diving. People must be fasted for 12 hours, no caffeine, no smoking, to make sure we are measuring endothelial function without being skewed by something they did previously. We typically require 24 hours with no exercise for these FMD studies.

**C. Balestra:** I agree totally with your approach. We had more or less the same results looking at antioxidants and FMD and with the same precautions such as no smoking, but we gave them 30 g of Belgian chocolates and could not find a reduction of FMD after the dive. It is also an antioxidant system, a catechin. Microvascularization can be increased with exercise. Venous gas bubbles increase is dependent on delta PO<sub>2</sub> and not on the steady state. We are giving oxygen like exercise, which just increases blood flow into the tissues and in turn increases oxygen, so delta PO<sub>2</sub> will be positive.

**R. Richardson:** That is interesting, you are using hyperoxia to drive oxygen into the cell by increasing gradient, as opposed to dropping the gradient, inside the cell.

---

**D. Doolette:** How universal is your calibration data to test all sorts of different dives? Are we going to have to do 1,000 more calibration dives with DCS if the dives we are interested in looking at are sufficiently different from the calibration data?

**O. Eftedal:** These data are for air bounce dives. If you want to use these for other types of dives you have to gather new data, which will obviously create a lot of decompression sickness.

**J.E. Jacobsen:** This is very interesting. Are these dives you make reference to going down, staying on the bottom and then checking the decompression schedule coming up? Do you take into consideration whether there is any decompression stress during the bottom phase?

**O. Eftedal:** These were just square profiles. We used bottom times just to confirm that they stayed exactly on the profile that was prescribed. If they did not, we did not use the data.

**J.E. Jacobsen:** Did you measure bubble score at the start of decompression and follow it up?

**O. Eftedal:** No, they were actually not decompression dives. The dives were performed in a lake and we started monitoring

once the divers were out of the water. The bubble numbers you see are the maximum numbers. We know from experience that the maximum numbers are usually reached within 40 minutes.

**J.E. Jacobsen:** Can we transfer this information into saturation diving?

**O. Eftedal:** That is the problem with the lack of basic information for saturation diving. The bubble-decompression sickness relationship for saturation diving has not been well described.

**J. Pontier:** Have you done experiments with animal models that are applicable?

**O. Eftedal:** It is difficult to use data from animal experiments in this setting for new operational procedures. What we can do with animals is compare different procedures. With our pig model we have a more sophisticated method for detecting bubbles and can actually count single bubbles. This is a better way of doing it than crude grading of bubbles.

---

**A. Fahlman:** Are you using inbred rats or regular rats?

**A. Møllerløkken:** We are using regular Sprague Dawley rats.

**A. Fahlman:** With inbred rats you can use genetic variation and may be able to see environmental variation, because you can get a lot of variation in the investigative environment.

**A. Møllerløkken:** We have used two different strains that are very different when it comes to bubble production or reactions to decompression.

**A. Brubakk:** The next step is to try to use rats that are genetically modified, most specifically by exercise where you can see they get different responses to exercise models to look at genetic mechanisms that might play a role. We believe that particular adaptation will protect them from decompression sickness and bubble formation as far as our present data indicate.

---

**D. Doolette:** To what extent is individual variability, which you are talking about here with genetics, and day-to-day variability important? We have divers who do identical profiles day after day and then get bent maybe 1 out of 8 times.

**A. Brubakk:** It seems clear that there is variation and it could be that you need a decompression table with a lower limit. It is obvious that individual variation plays a significant role. We think that epigenetics is a very interesting term, which is a genetic response of your genes to the environment that has genetic effects. But, we do not know the answer.

**C. Balestra:** We did a study of 5 divers who accepted to do two dives per day for 5 days and being scanned for bubbles every day. There was high variability in divers where we found bubbles present. The divers who had no bubbles continued to have no bubbles. We do not have sufficient data for a clear answer either. Adaptation may be one indicator.

**A. Fahlman:** We looked at the dive response in rats and there is a huge variability difference between strains, but not between days. You have to be able to reduce the variability to get a handle on decompression sickness mechanisms.

**D. Doolette:** You found very little day-to-day variability of susceptibility to decompression sickness with inbred strains of rats?

**A. Fahlman:** No, not for decompression sickness, we were looking at the dive response, distinguishing between good and bad divers and how long they could hold their breath. You reduce the genetic variability of phenotypes and see little difference within strains or between days

**D. Doolette:** Right, it is interesting that everyone thinks they are immune to decompression sickness until they get bent.

---

**L. Skjerven:** One observation is of air divers working every day, one to two dives, same decompression and same conditions, yet on Friday they get the bends.

**A. Brubakk:** Many have data like that and yet other data show that repetitive diving reduces the risk, but we still do not know.

---

**O. Molvaer:** Can ultrasound somehow trigger decompression sickness?

**S. Måsøy:** A known fact is that ultrasound can cause cavitation. For imaging you have to be able to not cause cavitation. As far as causing decompression sickness, I would say no, not during imaging.

**O. Molvaer:** Can it be deleterious or damaging in pregnancies using ultrasonic diagnostics?

**S. Måsøy:** This is a highly controversial issue, but I would say no. I have seen studies done on mice, and although not comparable to humans, much higher frequencies of ultrasound were used which causes energy absorption in the tissues.

**A. Hope:** Could it be possible with this new technique to detect or measure stationary bubbles or is it only Doppler?

**S. Måsøy:** Yes, they can move very slowly. We saw on the B-mode images of pigs' stationary bubbles. For large bubbles I suggest going to contrast agents which add a few microns.

**D. Knaus:** Can you elaborate on what the actual signal is that you are analyzing and how it is processed?

**S. Måsøy:** The signal is not the frequency difference or the frequency mixing that you use, because you would have to use a very long pulse. We use very short pulses and are actually using the fundamental signal from high frequency itself. This signal would be different, it is compressed and expanded, resonance-based. The low resonance of the bubble you can compress and expand.

---

**J. Buckey:** You mentioned that the nitric oxide produced vasodilatation and reduced pre-existing micronuclei. What do you propose as mechanism for that?

**J. Blatteau:** I do not know exactly. It is possible that vasodilatation accelerates the attenuation of nitric oxide.

**C. Balestra:** Another possible mechanism is related to caveolae changing due to production of NO.

**E. Thorsen:** Is it possible that you are studying the effect of heat exposure and vibration and you have no control over either of those?

**J. Blatteau:** Of course.

**A. Anfindsen:** I assume you said the stroke volume might be reduced because of dehydration so the gas uptake was decreased.

Could it not be a similar problem that the offgassing during decompression would be reduced if the stroke volume was back to normal during decompression?

**J. Blatteau:** In fact in our study we did not measure stroke volume, it is just a hypothesis.

**G. Perdrizet:** Did you measure the core body temperature in your model?

**J. Blatteau:** We did not measure the core temperature.

**G. Perdrizet:** What cell type did you measure the HSP70 stress protein in, white blood cells?

**J. Blatteau:** I do not remember exactly.

**C. Balestra:** The plasma came from white blood cells through a "sandwich method".

---

**A. Brubakk:** Can I make a suggestion? I do not think it has anything to do with gas uptake and gas elimination at all. I am more and more convinced that supersaturation is a red herring when it comes to bubble formation. Data to support that is from the studies we have done, where we can eliminate gas bubbles totally at the same level of supersaturation. This does not fit with the prevailing model that supersaturation creates a significant problem. With our animal experiments the bubble formation was the same but the effect of the bubbles was reduced, so this is still not solved at all.

---

**O. Molvaer:** Did you examine the spinal cord in the paralyzed rats?

**M. Havnes:** No, we did not.

**E. Thorsen:** Would it be possible to monitor for gas bubbles on the arterial side?

**M. Havnes:** I do not know. We can actually see the bubbles but in the brain it is very difficult.

**A. Brubakk:** From the studies we have done with exercise and nitric oxide we seem to be able to totally eliminate gas bubble formation in these animals. The question now of course is that a safe procedure is when you cannot see any bubbles anymore. We were a little surprised that we did not see anything, but the investigation still goes on and we are learning a lot about technique. It may be that there are a lot more in our data than we know of. Our studies also show we can have endothelial dysfunction even if we cannot measure any gas bubbles using ultrasound. Endothelial effects on the venous side also have an effect on the arterial side even if bubbles are not transported over.

**J. Ross:** You are using manganese contrast but because you have not seen it does that mean that there is no endothelial damage?

**M. Havnes:** The uptake of the manganese in the brain is there. Manganese behaves like Calcium, it flows into the cells.

**J. Ross:** It is not encapsulated, it will not interact with another process and make it worse, because it is a transition metal?

**J. Pontier:** Do you recall the chronology of signs of decompression sickness?

**M. Havnes:** One of the rats was paralyzed in the hind leg for a day and then it cleared up. I have not done it systematically, but I watch them and try to get them to run around and see if they behave strangely.

**G. Perdrizet:** You have a very sophisticated model and I do not know much about decompression sickness in the brains of rats. Can you use light microscopy or post-mortem studies that give you a positive control here?

**M. Havnes:** I am not sure we would get feedback, because the rats were so damaged, but earlier studies were mostly on the spinal cord and I have not seen many studies on the brain.

**A. Brubakk:** We had hoped we had a model that could give us a positive result, that was the intention at least, but it turned out much less than expected. We did a study many years ago looking at spinal cords in diseased divers who had died from different reasons. A number of those divers (10 professional and 10 amateur divers) had experienced decompression sickness. With the most sophisticated techniques we had available ten years ago, we could not find anything in the spinal cord. We do not have enough data, in part because we do not know exactly what we are looking for.

---

**J.E. Jacobsen:** Somehow we need to find a better link to the operational world besides just basic research. In the operational world we are focusing very much on saturation diving where the concern is long-term effects and a study of operational exposure data. We should also take more into consideration the bottom phase of the dives. There could well be some decompression stress accumulating before the final decompression takes place. Many years ago there was a project looking for critical exposure factors and we actually did find some too. We need the link between the profile, or elements of the profile, and probability of DCS as an outcome of the total saturation period. Today we are easily capable of producing time/depth profiles and study them. Within a short time we will have even more information available when the automatic monitoring systems come on line aboard the vessels. But we have not yet developed a tool to describe the character of the exposure. This is important for the doctor who sits in front of the diver and has the health record on the left side and the exposure information on the right side. However, the exposure information is not summarized in any way and cannot currently present a clear picture to the medical doctor, who therefore cannot link the two in practice. The project also had an important strategy: first, it was to connect a lot of exposure data and search for critical exposure factors, then test this exposure data out on animals. That clear link has not been made yet. An example of an accumulative factor on the bottom phase from the analysis we have done was when the relative pressure change between the shallowest and deepest stores in saturation increased by 1%, the probability of producing DCS as an outcome of total exposure increased by 5%. That was a qualitative measure of DCS. There were other examples, but we need to look for more factors. All of the presentations at this symposium have been interesting and we should not forget that there is an industry out there that needs practical tools to monitor the long-term effects and that should be taken into consideration.

**A. Brubakk:** I agree that it is important to try to find practical

applications of the research here. It is also important to have an understanding of what we are actually looking for and what we are doing. One of the reasons we are doing the kind of research presented at this meeting is trying to understand some of the mechanisms that can help us explain and give you the tools that you need. We have had a number of presentations in many different fields that show there are various methods that are normally not considered part of decompression research but are quite useful. Emerging techniques such as the new ultrasound equipment clearly could, if we have the right methods and understanding of the theory, provide us with a lot of information to develop better procedures.

**J. Ross:** Understanding fundamental physiology of responsive people put under pressure and then decompressed is very important as you are considering the long-term health effects of an industry. In saturation diving you use pressure chambers to commute to work. What you actually do at work may be more important than any change in pressure. This industrial work force is working at pressure and is exposed to accidents, illness, industrial contamination and petrochemicals in particular, hand-arm vibration syndrome, cold-induced events, excess noise, etc. The responses to those exposures may also be fundamental physiological changes induced by the environment. To measure long-term health effects, you need to take all factors into account, not just pressure changes, but exposure in the holistic sense.

**J.E. Jacobsen:** Thank you Alf, we agree of course, it is just that when we do the basic research we still need to remember the link as to why we do it and follow up on the operational side as well as pointed out by Dr. John Ross.

---

**B. Gardiner:** I would like to share an anecdote on John Scott Haldane. Last week on the news in the U.K., a ten-year old boy wanted to cycle to school but the school management was so concerned about his health and safety and protection that they demanded his mother drive behind him in the car. The thought of John Scott Haldane turning his child into experimentation must have shocked people like that. I do know however that John Scott Haldane was a very kind man. I visited the Mines Rescue Center in the north of England and came across the canary cage that he used to investigate mine disasters. Many people thought it was the explosions that killed the miners, but Haldane found it was the toxic gases that asphyxiated most of those people. He took his canary cage with him down into the mines when he did experiments, and when the bird fell off its perch, he would put his mask on. The reason that the canary cage is important to see John Scott Haldane, is that it was made of a complete box with glass sides and a front door that hung down. When the canary fell off his perch, Haldane would close the o-ring sealed cage door. On top of the cage's carrying handle was a small bottle of oxygen, which he would open, the bird lived and everybody was happy.

---

**D. Doolette:** There have been several talks on using VGE as

a measure of decompression stress and how that could work. There are at least two ways why VGE might be a measure of decompression stress. Some people believe the gas emboli in cells may cause symptoms, others believe it may just be a reflection of what is going on extravascularly. There was also a talk that seemed to suggest that the use of nitric oxide and exercise affects micronuclei inside the vasculature, then using VGE as a measure of stress after that. Are we measuring the right thing anymore with extravascular VGE effects by not looking at DCS as an endpoint? We are looking at bubbles or changing how they behave. Can we still say without some validation that they are still a measure of decompression stress?

**A. Brubakk:** We might be measuring a totally wrong thing. The reason we at least are measuring the wrong thing is that it is the only thing we can measure. I would love to have a method for instance to know changes that happen in some tissues and get some data on that. The only things I really believe in, and fully agree with Haldane, is that we need data from something we can measure. Decompression sickness is a very slippery beast that we cannot really define. My group is going in a totally different direction. We use something we can measure and then use Occam's Razor principle and try to explain it with the simplest mechanism we can think of and see where that gets us. Maybe over time or with better methods we will have to acknowledge that we were totally wrong, but can at least have some fun trying to get it right.

**A. Møllerløkken:** It is important for the future to pinpoint the exact research questions. As far as I know most questions being asked at different laboratories do not give us straight yes or no answers, but they open up all different kinds of opportunities that lead to disagreements on the importance of bubbles, stress, or other markers. The ability to state more concise questions on the decompression syndrome is a major challenge for all of us.

**C. Balestra:** My answer to this is collaboration, which is the only thing we can do together to find the right answers.

**G. Perdrizet:** You cannot manage what you cannot measure. Lyme disease may be an analogy. In the literature there is

continuous argument and controversy over that disease because we have no way to measure it. The decompression theory will remain a theory until you find an objective way to measure it.

---

**R. Moon:** Alf Brubakk made the point that there was no relationship between bubbles and supersaturation, but surely did not mean that bubbles are caused by something other than supersaturation.

**A. Brubakk:** You need supersaturation, but that is not enough. My point was that you can have tremendous supersaturation without bubble formation.

**R. Moon:** Probably a caution, but you suggested quite correctly, I think, that venous gas embolism is a more objective measure of decompression stress than symptoms. However, I think you intended to calibrate your decompression stress by using symptoms. One of the presentations had some nice graphs looking at the correlation between venous gas embolism and decompression sickness. After all, is it not the sickness we are trying to prevent? We know that bubbles are almost ubiquitous among divers, particularly saturation divers, and yet very few divers actually get bent.

**A. Brubakk:** The point here, as was said earlier, is that what we are looking for is a bubble-free decompression. We want to use gas bubbles in a way that can produce a procedure that has as few bubbles as possible. That is our current thinking. It is clear that there is a statistical relationship between many vascular gas bubbles and the increased risk of decompression sickness. The argument I made was that using decompression sickness as endpoint is extremely difficult in developing models or ideas about what is really going on because there is no clear definition of the clinical symptoms. I agree with what Thalmann suggested that any symptom after decompression could be related to decompression sickness and use that as endpoint.

**R. Moon:** I would agree with that, but it is not unique in medicine. There are many other clinical syndromes for which there are no objective measures, in fact, perhaps even most.

**A. Brubakk:** True, and that is why we are in trouble.





# Breeding Diving Scientists: Cloning, Spawning, or Cultivation?

*Øyvind Ellingsen*

---

**G**ood morning ladies and gentlemen. I am probably one of the few audience members who does not dive and therefore does not know much about diving, which is probably the reason I am only going to talk for about five minutes.

As you know, we are building a new hospital. In that respect I am asked to share how we see the future for diving physiology and diving medicine in our faculty. We have plans for our labs and we believe that there is no future for science without scientists, so how are we going to plan for that? I do not think we have to spend much time describing our enthusiasm for translational research, a necessity for the future of any physiological science and probably also true for diving.

How are we going to breed young scientists? There are several methods for producing offspring and cloning is one of them. We have had reasonably successful stories for the last fifteen years and some of these success factors give room for reflection. Alf Brubakk and others here have had a very solid basis in medicine and physiology with grounding in clinical and occupational consulting. I was struck by Željko Đujić's presentation that showed that almost all researchers involved in science at the University of Split were MDs with PhDs. We need to have many MDs on board in order to be successful. They need to be involved in clinical and occupational consulting in order to experience the problem base for the experimental work that is going to be the translational part.

Several speakers have mentioned that the translational approach combining experimental and clinical work is important to figure out the cellular and molecular mechanisms but also for the evaluation of the outcome of physiological experiments. In my opinion it is also important to have close industry and national collaborations where the actual professional diving takes place. That is the cloning part that we believe has contributed to our success and we want to copy that model for the future.

No one knows how and what the new discoveries are going to be, but for certain you need fresh minds and much enthusiasm to accomplish that. We are fortunate to have many young students who we engage quite early in medical school to work on their student theses. It is important to involve people in research from the very start. It is much easier to engage 20-year olds in diving research and environmental physiology than in geriatric research. In that regard diving science is very fortunate.

Spawning involves spreading out the enthusiasm by seeding all over the place, but you also need to do some cultivation, the money-consuming and difficult part. Again, solid roots are required in clinical and occupational consulting. In the cultivation process of new researchers, competition and selection are important and career grants must be available for young, accomplished postdocs. The spawning of trying to reach everybody stops at some point. The funding then needs to be based on the people who

are contributing with large scientific output. Stable fertilization is required in order for this to happen, which means a good basis of industry and government funding. How are we going to do that, through direct funding by the industry to the various research groups? If you really want to do a good selection

of young researchers, a large chunk of the funding should be channeled through established funding agencies for the peer-review part and to ensure that the resources are spent on the best candidates.

# National Centre for Hyperbaric and Diving Medicine

*Marit Grønning*

---

## INTRODUCTION

The National Centre for Hyperbaric and Diving Medicine was established in January 2008 at the request of the central authorities of Norway in Stortingsmelding 12, 2005-2006 on health, environment and safety in the petroleum industry, Chapter 7 - Diving (Stortingsmelding, 2005-2006). This document acknowledges the consensus from the Godøysund II meeting (Hope and Risberg, 2005) that “there is evidence that changes in lung function, CNS (central nervous system), bone, and cochleo-vestibular system can be demonstrated in some occupational divers. The magnitude of these changes is highly variable and has the potential to influence divers’ quality of life. The knowledge about the precise mechanism is still limited and calls for further research on preventive measures, including health surveillance.”

## ESTABLISHMENT OF THE NATIONAL CENTRE

The Norwegian Labour Union highlighted the need for a National Centre for diving medicine, independent of industry, with a high level of clinical expertise emphasizing the principles of evidence-based medicine.

The Centre is located at the Department of Occupational Medicine, Haukeland University Hospital. This department is responsible for elective and acute hyperbaric therapy on a regional and national level and medical assessment of occupational disease in all Norwegian divers. Since 2000, about 200 out of a total of 375 former North Sea divers and about 40 inshore divers have been examined with collaboration from several hospital departments (e.g., divers with decompression sickness are inpatients at the Department of Neurology).

## NATIONAL CENTRE GOALS

In accordance with the official definition of Norwegian National Centres, our Centre will promote research, education, and public information in the field of hyperbaric and diving medicine (HOD, 2003). The Centre is expected to advise central authorities on developing a national plan for hyperbaric medicine and in all matters related to divers’ health, environment and safety. The Centre will also advise health professionals, develop national standards and a registry for decompression sickness and occupational diseases in divers. Health promotion is the main goal in this endeavor.

## RESEARCH

The Centre will focus on epidemiological and multidisciplinary clinical research and also conduct basic and translational research. We are involved in a multi-center study of hyperbaric treatment of radiation-induced cystitis. In another ongoing project we are studying possible CNS effects of hyperoxia in patients undergoing hyperbaric therapy. A prospective longitudinal study of occupational divers and long-term health effects in retired divers is being conducted. A follow-up study on divers referred for decompression sickness is being conducted. Studies of the effects of diving and hyperoxia on pulmonary mechanical and gas exchange functions are being continued with emphasis on nitric oxide as mediator.

To further multi-center studies and to accomplish other goals, we are establishing closer contact and cooperation with other national and international centers.

## LITERATURE CITED

- HOD I-19/2003 - Om høyspesialiserte tjenester – landsfunksjoner og nasjonale medisinske kompetansesentra  
Hope, A., and J. Risberg, eds. 2005. Long term Health effects of diving. The Godøysund 1993 consensus revisited. Bergen: BODONI. 302 pp.  
Stortingsmelding 12, 2005–2006. Health, environment and safety in the petroleum industry, pp 65–69.

# Baromedical and Environmental Physiology Group (BAREN)

*Alf O. Brubakk*

---

## INTRODUCTION

The start of the program known today as the NTNU Baromedical and Environmental Physiology Group (BAREN) was in 1970, when as a young medical doctor just finishing my internship I was offered a grant to do research in Trondheim. At that time there was no Medical Faculty in Trondheim, only in Bergen and Oslo, but the county wanted to support research as part of an effort to get recognition as the next medical faculty in Norway.

Trondheim had the only technical university in the country and my job was to see if there was a possibility to establish research in the area of medical technology. Together with a young engineer, Rune Aaslid, we developed a computer model (JENNY - named after the first patient) of the human cardiovascular system that we wanted to use for clinical work. This model consisted of over 50 non-linear equations, but no digital computer existed at the time able to handle that. So Rune built an analogue computer to do this. We had hoped that this model could be used clinically, but we were probably way ahead of our time!

Based on this work, we saw the need early on for better methods to evaluate vascular function. We therefore decided to develop an ultrasonic system for measuring blood-flow velocity in the aorta and large vessels in the thorax (PEDOF). This was the start of a considerable and long-standing development of ultrasonic equipment for cardiovascular measurements that is now part of the instruments being sold as GE Vingmed.

## EVOLUTION

When we first got interested in diving research we saw the potential of ultrasonic equipment for detecting gas-phase formation after decompression. Bubble detection using ultrasound had been around for a considerable time but, apart from a few enthusiasts, the establishment saw little value in this. "Bubbles are not decompression sickness" we were told by the experts. However, as we could demonstrate that gas bubbles could be detected in the carotid artery of nearly all divers following a deep experimental dive (Brubakk et al., 1986), we realized that these methods had considerable value.

Financed by Mobil Oil, a program was started in Trondheim in 1985 to look at various aspects of the underwater work environment, of which decompression was just one aspect. The program looked at decompression, bacteriology, ergonomics, and toxicology, trying to understand how this environment could influence man's health.

Later, BAREN was established as a group within the Department of Physiology and Biomedical Engineering, and then in the Department of Circulation and Medical Imaging at the Medical Faculty. As can be seen in the Appendix, the group has over the years



published a significant number of papers. BAREN's work has led to over 25 Masters theses and 5 PhD dissertations in the field of diving and decompression physiology. The main aim of the group is to train scientists in the field of underwater medicine and physiology. In more general terms, the program wants to provide students with an understanding of how the environment influences human physiology. The approach is multi-disciplinary and focused on understanding the basic mechanisms involved.

## DECOMPRESSION RESEARCH

During later years the group focused on decompression and in particular on how the endothelium is involved. This has led us into studies of endothelial dysfunction in general and how it can be influenced by environmental factors like (e.g., exercise). Through collaboration with scientists interested in exercise physiology we could show that gas-bubble formation can be significantly influenced by exercise. Originally, we predicted that exercise would increase gas elimination, thus reducing the risk of DCS. The results obtained experimentally were quite surprising, gas elimination was not increased, but a single bout of high-intensity exercise 24 hours before a dive that killed all our control animals, prevented all vascular gas bubble formation (Wisloff and Brubakk, 2001). This result, originally first shown in rats, has since then been demonstrated in man (Dujic et al., 2004). The mechanism is related to the production of NO, shown both in rats and pigs as well as in man (Wisloff et al., 2003; Brubakk and Wisloff, 2005).

This led us to focus on vascular gas-bubble formation as the most important factor for evaluating the risk of neurological DCS. By focusing on the endothelium, we realized that endothelial dysfunction was an important factor involved in decompression and that hyperoxia and vascular gas bubbles significantly influenced the outcome of a dive. We also concluded that stress was an important factor in diving and that hyperoxia and gas-bubble formation are examples of a stress response. Stress in the right dose and at the right time has a significant health-promoting effect, thus showing that diving elicits a general response to stress.

A number of decompression models exist. Our effort, called Copernicus, is a model based on physiological principles that try to take individual factors of the diver and his environment into account. In a way the circle is closed because BAREN is a result of research started over 30 years ago as JENNY at the start of my scientific career.

## VISION FOR THE FUTURE

Diving research is a very small field reflected by the fact that there are probably less than 50 full-time scientists engaged in its study around the world. University departments with a diving research focus are even rarer. It is our belief that this field can only survive and grow if collaboration with other fields of physiology and medicine can be established.

We are experiencing a world where sea levels are rising,

needs for new energy sources independent of fossil fuels are required, and fish farming will have increasing importance. A man-in-the-sea capability is needed as will a better understanding of how to live and work under the ocean.

I personally am about to retire in a couple of years. Considerable effort is under way to ensure that our work can continue. We hope that Trondheim will also be a Centre of Excellence in diving research in the future.

When planning for a month, sow rice, when planning for a year, plant trees, when planning for a decade, train and educate men --Old Chinese proverb

## LITERATURE CITED

- Brubakk, A.O., O. Eftedal, and U. Wisloff. 2005. Endothelium and diving. In Aird, W.C., ed. *The endothelium: A comprehensive reference*. Cambridge University Press.
- Brubakk, A.O., R. Peterson, A. Grip, and B. Holand. 1986. Gas bubbles in the circulation of divers after ascending excursions from 300 to 250 msw. *Journal of Applied Physiology* 60:45–51.
- Dujic, Ž., D. Duplančić, I. Marinović-Terzić, D. Baković, V. Ivančev, Z. Valic, D. Eterović, N.M. Petri, U. Wisloff, and A.O. Brubakk. 2004. Aerobic exercise before diving reduces venous gas bubble formation in humans. *Journal of Physiology* 555(3):637–642.
- Wisloff, U., and A.O. Brubakk. 2001. Aerobic endurance training reduces bubble formation and increases survival in rats exposed to hyperbaric pressure. *Journal of Physiology* 537(2):607–611.
- Wisloff, U., R.S. Richardson, and A.O. Brubakk. 2003. NOS inhibition increases bubble formation and reduces survival in sedentary but not exercised rats. *Journal of Physiology* 546:577–582.

## APPENDIX

### PUBLICATIONS 1999–2009

#### 2009

- Glavas, D., D. Bakovic, A. Obad, I. Palada, T. Breskovic, Z. Valic, A.O. Brubakk, and Ž. Dujic. 2009. Effects of tetrahydrobiopterin on venous bubble grade and acute diving-induced changes in cardiovascular function. *Clinical Physiology and Functional Imaging* 29(2):100–107.
- Gutvik, C.R., and A.O. Brubakk. 2009. A dynamic two-phase model for vascular bubble formation during decompression in divers. *IEEE Transactions in Biomedical Engineering* 56:884–889.

#### 2008

- Bakovic, D., D. Glavas, I. Palada, T. Breskovic, D. Fabijanic, A. Obad, Z. Valic, A.O. Brubakk, and Ž. Dujic. 2008. High-grade bubbles in left and right heart in an asymptomatic diver at rest after surfacing. *Aviation, Space, and Environmental Medicine* 79:626–628.
- Dujic, Ž., Z. Valic, and A.O. Brubakk. 2008. Beneficial role of exercise on scuba diving. *Exercise and Sport Sciences Reviews* 36:38–42.
- Glavas, D., A. Markotic, Z. Valic, N. Kovacic, I. Palada, R. Martinic, T. Breskovic, D. Bakovic, A.O. Brubakk, and Ž. Dujic. 2008. Expression of endothelial selectin ligands on human leukocytes following dives. *Experimental Biology and Medicine* 233(9):1181–1188. Epub 2008 Jun 5.
- Medby, C. A. Bye, U. Wisloff, and A.O. Brubakk. 2008. Heat shock increases survival in rats exposed to hyperbaric pressure. *Diving and Hyperbaric Medicine* 38(4):189–193.

**2007**

- Brubakk, A.O., O.S. Eftedal, and U. Wisloff. 2007. Endothelium and diving. In: Aird, W., ed. *Endothelial Biomedicine*. Cambridge University Press. pp. 497–505.
- Eftedal, O.S., H. Tjelmeland, and A.O. Brubakk. 2007. Validation of decompression procedures based on detection of venous gas bubbles: A Bayesian approach. *Aviation, Space, and Environmental Medicine* 78(2):94–99.
- Eftedal, O.S., S. Lydersen, and A.O. Brubakk. 2007. The relationship between venous gas bubbles and adverse effects of decompression after air dives. *Journal of Undersea and Hyperbaric Medicine* 34:99–105.
- Møllerløkken, A., C. Gutvik, V.J. Berge, A. Jørgensen, A. Løset, and A.O. Brubakk. 2007. Recompression during decompression and effects on bubble formation in the pigs. *Aviation, Space, and Environmental Medicine* 78(6):557–560.
- Obad, A., I. Palada, V. Ivancev, Z. Valic, D. Fabijanic, and A.O. Brubakk, and Z. Dujic. 2007. Sonographic detection of intrapulmonary shunting of venous gas bubbles during exercise after diving in a professional diver. *Journal of Clinical Ultrasound* 35(8):473–476.
- Obad, A., I. Palada, Z. Valic, V. Ivancev, D. Bakovic, U. Wisloff, A.O. Brubakk, and Ž. Dujic. 2007. The effects of acute oral antioxidants on diving-induced alterations in human cardiovascular function. *Journal of Physiology* 578:859–870.
- Obad, A., Z. Valic, I. Palada, A.O. Brubakk, D. Modun, and Ž. Dujic. 2007. Antioxidant pretreatment and reduced arterial endothelial dysfunction after diving. *Aviation, Space, and Environmental Medicine* 78(12):1114–1120.

**2006**

- Brubakk, A.O., and C. Gutvik. 2006. Optimal decompression from 90 msw. In: Lang, M.A. and N.E. Smith (eds). *Proceedings of the Advanced Scientific Diving Workshop*. Washington, DC: Smithsonian Institution. Pp. 39–46.
- Brubakk, A.O., O.S. Eftedal, and U. Wisloff. 2006. Endothelium and diving. In: Aird, W. (ed). *Handbook of the Endothelium*. Cambridge University Press.
- Dujic, Ž., A. Obad, I. Palada, Z. Valic, and A.O. Brubakk. 2006. A single open sea air dive increases pulmonary artery pressure and reduces right ventricular function in professional divers. *European Journal of Applied Physiology* 97(4):478–485.
- Dujic, Ž., Z. Valic, and A.O. Brubakk. 2006. Exogenous nitric oxide and bubble formation in divers. *Medicine and Science in Sports and Exercise* 38(8):1432–1435.
- Løset, A., A. Møllerløkken, V. Berge, U. Wisloff, and A.O. Brubakk. 2006. Post-dive bubble formation in rats: Effects of exercise 24 h ahead repeated 30 min before the dive. *Aviation, Space, and Environmental Medicine* 77(9):905–908.
- Møllerløkken, A., V.J. Berge, A. Jørgensen, U. Wisloff, and A.O. Brubakk. 2006. Effect of a short-acting NO donor on bubble formation from a saturation dive in pigs. *Journal of Applied Physiology* 101(6):1541–1545.
- Wisloff, U., P.M. Haram, and A.O. Brubakk. 2006. Exercise and the endothelium. In Aird, W. (ed). *Handbook of the Endothelium*. Cambridge University Press.

**2005**

- Berge, V.J., A. Jørgensen, A. Løset, U. Wisloff, and A.O. Brubakk. 2005. Exercise ending 30 min pre-dive has no effect on bubble formation in the rat. *Aviation, Space, and Environmental Medicine* 76(4):326–328.
- Brubakk, A.O. 2005. Decompression illness. What we do know, what we don't know. In: Marroni, A., D. Mathieu, and F. Wattel (eds). *The ECHM Collection*. Volume 1. pp 11–34.
- Brubakk, A.O. 2005. Which animal models are to be used to study decompression accidents? In: Marroni, A., D. Mathieu, and F. Wattel (eds). *The ECHM Collection*. Volume 1. pp 201–211.
- Brubakk, A.O., D. Duplancic, Z. Valic, I. Palada, A. Obad, D. Bakovic, U. Wisloff, and Ž. Dujic. 2005. A single air dive reduces arterial endothelial function in man. *Journal of Physiology* 566:901–906.
- Dujic, Ž., I. Palada, A. Obad, D. Duplancic, D. Bakovic, and Z. Valic. 2005. Exercise during a 3-min decompression stop reduces postdive venous gas

bubbles. *Medicine and Science in Sports and Exercise* 37:1319–1323.

- Hjelde, A., O.A. Gederaas, H.E. Krokan, and A.O. Brubakk. 2005. Lack of effect of hyperoxia on photodynamic therapy in three different cell lines. *Medical Science Monitor* 11:351–356.
- Møllerløkken, A., A.O. Brubakk, and U. Wisloff. 2005. The effect of hyperbaric oxygen on aerobic capacity in rat. *European Journal of Underwater and Hyperbaric Medicine* 6:5–9.
- Valic, Z., D. Duplancic, D. Bakovic, V. Ivancev, D. Eterovic, U. Wisloff, A.O. Brubakk, and Ž. Dujic. 2005. Diving-induced venous gas emboli do not increase pulmonary artery pressure. *International Journal of Sports Medicine* 26:626–631.
- Westin, A.A., J. Asvall, G. Idrovo, P. Denoble, and A.O. Brubakk. 2005. Diving behaviour and decompression sickness among Galapagos underwater harvesters. *Journal of Undersea and Hyperbaric Medicine* 32:175–184.

**2004**

- Brubakk, A.O. 2004. Hyperbaric oxygen therapy: Oxygen and bubbles. *Journal of Undersea and Hyperbaric Medicine* 31(1):73–79.
- Dujic, Ž., D. Duplancic, I. Marinovic-Terzic, D. Bakovic, V. Ivancev, Z. Valic, D. Eterovic, N.M. Petri, U. Wisloff, and A.O. Brubakk. 2004. Aerobic exercise before diving reduces venous gas bubble formation in humans. *Journal of Physiology* 555(3):637–642.
- Eftedal, O.S., S. Lydersen, G. Helde, L. White, A.O. Brubakk, and L.J. Stovner. 2004. A randomized, double blind study of the prophylactic effect of hyperbaric oxygen therapy on migraine. *Cephalalgia* 24(8):639–644.
- Wisloff, U., R.S. Richardson, and A.O. Brubakk. 2004. Exercise and nitric oxide prevent bubble formation: a novel approach to the prevention of decompression sickness? *Journal of Physiology* 555:825–829.

**2003**

- Brubakk, A.O., and T.S. Neuman, eds. 2003. *Bennett and Elliott's The Physiology and Medicine of Diving*. London: Saunders, 5<sup>th</sup> edition.
- Brubakk, A.O., B. Krossnes, A. Hjelde, S. Koteng, S.J. Mørk, and H. Ørnhagen. 2003. The effect of 100 kPa Oxygen and recompression to 200 kPa on air on organ injury following decompression in the pig. *European Journal of Underwater and Hyperbaric Medicine* 4:5–12.
- Brubakk, A.O., B. Wienke, and S. Koteng. 2003. Decompression profile and bubble formation after dives with surface decompression. Experimental support for a dual phase model of decompression. *Journal of Undersea and Hyperbaric Medicine* 30:181–193.
- Morland, T., L. Langø, and A.O. Brubakk. 2003. Inert gas exchange from nitrogen bubbles in diffusion limited tissue: Relevance for the use of helium in the treatment of decompression sickness. *European Journal of Underwater and Hyperbaric Medicine* 4:13–19.
- Nishi, R.Y., A.O. Brubakk, and O.S. Eftedal. 2003. Bubble detection. In *Bennett and Elliott's The Physiology and Medicine of Diving*. Brubakk, A.O. and T.S. Neuman, eds. Saunders: London. Pp. 501–529.
- Nossum, V., A. Hjelde, K. Bergh, A.L. Ustad, and A.O. Brubakk. 2003. Anti-C5a monoclonal antibodies and pulmonary polymorphonuclear leukocyte infiltration – endothelial dysfunction by gas bubbles. *European Journal of Applied Physiology* 89:243–248.
- Wisloff, U., R.S. Richardson, and A.O. Brubakk. 2003. NOS inhibition increases bubble formation and reduces survival in sedentary but not exercised rats. *Journal of Physiology* 546:577–582.

**2002**

- Hjelde, A., G. Bolstad, and A.O. Brubakk. 2002. The effect of air bubbles on rabbit blood-brain barrier. *Journal of Undersea and Hyperbaric Medicine* 29:31–38.
- Hjelde, A., M. Hjelstuen, O. Haraldseth, J.D. Martin, S.R. Thom, and A.O. Brubakk. 2002. Hyperbaric oxygen and neutrophil accumulation/tissue damage during permanent focal cerebral ischaemia in rats. *European Journal of Applied Physiology* 86:401–405.
- Hjelde, A., V. Nossum, M. Steinsvik, J.I. Bagstevold, and A.O. Brubakk. 2002. Evaluation of cerebral gas retention and oedema formation in

decompressed rats by using a simple gravimetric method. *Scandinavian Journal of Clinical Laboratory Investigations* 62:263–270.

Medby, C., H. Røe, and A.O. Brubakk. 2002. Microdialysis in cisterna magna during cerebral air embolism in swine. *Journal of Undersea and Hyperbaric Medicine* 29:226–234.

Nossum, V., A. Hjelde, and A.O. Brubakk. 2002. Small amounts of venous gas embolism cause delayed impairment of endothelial function and increase polymorphonuclear neutrophil infiltration. *European Journal of Applied Physiology* 86:209–214.

#### 2001

Brubakk, A.O., and O. Eftedal. 2001. Comparison of three different ultrasonic methods for quantification of intravascular gas bubbles. *Journal of Undersea and Hyperbaric Medicine* 28:131–136.

Juvik, E., E. Soligård, A.O. Brubakk, and A.M. Brubakk. 2001. Arterial air embolism after venous air infusion in newborn pigs. *Acta Paediatrica* 90:786–782.

Medby, C., A.O. Brubakk, and H.E. Myrvold. 2001. Iatrogen gasemboli. *Tidsskrift for Den norske legeforening* 121:2604–2606.

Wisloff, U., and A.O. Brubakk. 2001. Aerobic endurance training reduces bubble formation and increases survival in rats exposed to hyperbaric pressure. *Journal of Physiology* 537:607–611.

#### 2000

Brubakk, A.O. 2000. Man in extreme environments. *Aviation, Space, and Environmental Medicine* 71(suppl):A126–130.

Brubakk, A.O. 2000. Surface oxygen is an acceptable definite treatment for DCI. *Journal of the South Pacific Undersea Medicine Society* 30:1955–1961.

Brubakk, A.O. 2000. What is the optimal treatment “dose” for decompression illness. *Journal of the South Pacific Undersea Medicine Society* 30:92–95.

Brubakk, A.O. 2000. On-site recompression treatment is acceptable for DCI. *Journal of the South Pacific Undersea Medicine Society* 30:166–173.

Brubakk, A.O., and O.S. Eftedal. 2000. Evaluation of reverse dive profiles. In: Lang, M.A., and C.E. Lehner, eds. *Proceedings of the Reverse Dive Profiles Workshop*. Washington DC: Smithsonian Institution. pp. 111–121.

Hjelde, A., and A.O. Brubakk. 2000. Variability in serum surface tension in man. *Applied Cardiopulmonary Pathophysiology* 9:9–12.

Hjelde, A., S. Koteng, O.S. Eftedal, and A.O. Brubakk. 2000. Surface tension and bubble formation after decompression in the pig. *Applied Cardiopulmonary Pathophysiology* 9:47–52.

Nossum, V., A. Hjelde, K. Bergh, and A.O. Brubakk. 2000. Lack of effect of anti-C5a monoclonal antibody on endothelial injury by gas bubbles in the rabbit after decompression. *Journal of Undersea and Hyperbaric Medicine* 27:27–35.

#### 1999

Hjelde, A., A.O. Brubakk, K. Bergh, V. Videm, and A.L. Ustad. 1999. Effect of anti-C5a antibody on blood-lung and blood-brain barrier in rabbits after decompression. *Journal of Undersea and Hyperbaric Medicine* 26:249–256.

Nossum, V., S. Koteng, and A.O. Brubakk. 1999. Endothelial damage by bubbles in the pulmonary artery of the pig. *Journal of Undersea and Hyperbaric Medicine* 26:1–8.

# Physiopathology of Decompression (PHYPODE) Network

*Francois Guerrero, Jacek Kot, Peter Germonpré, Jean-Michel Pontier, Alessandro Marroni, Adel Taber, Frans Cronje, Bernard Gardette, D. Nicola, and Costantino Balestra*

---

The recent changes in diving habits and population characteristics increase the risk of decompression sickness among recreational divers. Moreover, it is also expected that diving companies will increase their activity because oil companies are eager to increase offshore excavations. Those dives should be done with increased level of decompression safety, since in the last years a lot of former commercial divers have been financed by large amends for long-term deleterious effects of inappropriate desaturation of inert gas during decompressions conducted according to currently used decompression tables. Because of the important and yet unexplained inter- and intra-individual variability of bubble formation and bubble sensitivity, there is a need for new approaches of decompression management and better diver education. Finally, no actual university course is given in the specific field of research applied to decompression after diving or working under pressure. Not even formal medical information is provided through European universities during the standard medical education curriculum. Therefore, a proposal for a FP7-people Marie Curie Initial Training Network has been submitted to the European Commission in September, 2008. This ITN proposal, entitled *Physiopathology of decompression: Risk factors for the formation of intravascular bubbles during decompression* (PHYPODE), aims to:

1. develop a coherent and integrated research training program on decompression phenomena with specific attention to the formation of intravascular bubbles with their pathophysiological and clinical consequences, including endothelial function and decompression sickness.
2. develop an exchange of knowledge that will be structured by the initial training network activities, giving young researchers opportunities to share research techniques and resources, and jointly participate in courses, seminars, workshops and congresses in order to benefit from the best international scientists' knowledge in this field, and get in touch with the scientific community from private and public institutions; and,
3. widen career prospects of young researchers by embracing the whole chain of research applied to decompression:
  - fundamental research for pathophysiological understanding of decompression;
  - applied research in the industry;
  - clinical research on decompression sickness; and,
  - ground experimentation with professional divers.

*Francois Guerrero, UFR Sport et Education Physique, Université de Bretagne Occidentale, Brest Cedex, F-29285, France. Jacek Kot, National Center for Hyperbaric Medicine, Medical University of Gdansk, Gdansk, Poland. Peter Germonpré, Centre d'Oxygénothérapie Hyperbare, Hôpital Militaire Reine Astrid, 1120, Brussels, Belgium. Jean-Michel Pontier, Département de Médecine Hyperbare, Hôpital d'Instruction des Armées Sainte-Anne, 83800, Toulon Armées, France. Alessandro Marroni, P.O. Box DAN Europe, 64026, Roseto, Italy. Adel Taber, Hyperbaric Medical Center, Sharm el Sheikh, Egypt. Frans Cronje, Hyperbaric Medicine and Research, University of Stellenbosch, Stellenbosch, South Africa. Bernard Gardette, COMEX S. A., 36 Boulevard des Océans - BP 143, F-13275, Marseille Cedex 9, France. D. Nicola, Human Breathing Technology s.r.l., Via Valmartinaga 3, 34135, Trieste, Italy. Costantino Balestra, P.O. Box DAN Europe, 64026, Roseto, Italy; and Environmental and Occupational Physiology Laboratory, I.S.E.K. Haute Ecole Henri Spaak, 1160, Brussels, Belgium.*

The PHYPODE network unites 9 teams, situated in France, Poland, Belgium, Italy, Egypt and South Africa. Among these, one partner is a non-profit association

with worldwide activities (DAN Europe), four are hyperbaric medical centres and national reference centres for treatment and evaluation of injuries related to exposure to hyperbaric environments (NCHM, HBOC, HMC, HMR). One industrial partner is a world leader for professional deep diving (COMEX S.A.), the other is specialized in the field of high-technology diving breathing apparatus (HBT). Finally, four network partners are higher education institutions with research activities in complementary fields of human physiology (UBO, NCHM, ISEK, HMR).

The PHYPODE network will conduct the five sub-programs below, which combine epidemiological study, fundamental experimental and integrated approaches of the decompression phenomena in both human and animal models, and the following prospective studies:

1. investigation of the environmental and behavioural determinants of decompression bubble formation;
2. determination of individual physiological and anthropometric determinants of decompression bubble formation;
3. research on secondary prevention of decompression sickness;
4. training of young researchers; and,
5. dissemination of knowledge.

Although scientific and training collaborations already exist between partners involved in the PHYPODE network, they will be reinforced through this project. Such constitution of a formal network will primarily benefit from the mutual recognition of reciprocal quality of training that will increase the collaboration and exchangeability of “know-how” and knowledge

at all levels. Host organizations will benefit from an integrated approach gaining knowledge and time towards developing new decompression schedules. Furthermore, mutual recognition of the training program by the network institutions will lead to the possibility of a European degree in this field.

Young researchers, the scientific community, and industries will interact through planned conferences and workshops, with relationships and job opportunities emerging from the PHYPODE project. The PHYPODE network will meet industrial needs for knowledge and provide experts in decompression. Beyond academic collaborations, the interdisciplinary programmes will simplify the connections with industry and facilitate the validation of research output, by the practical application of scientific results. Indeed, industries will look for scientific output in order to develop safer diving tools and update actual decompression software. This network will reinforce the partners’ collaborations with both industrial entities from within and outside the network via communications in the planned conferences.

The network will share knowledge with the international scientific community and industries of the diving sector through international conferences. Other training events such as network workshops will be open to external participation in specific cases. Visiting scientists will be invited to participate in PHYPODE workshops in order to ensure the highest scientific quality of the projects. They will be chosen at the international level to complete the network range of competencies or to extend the network knowledge to different sectors such as space flights. Visiting scientists will also be provided the opportunity to interact with external experts from Europe and beyond.



# International Cooperation in Diving Research

*Matthew Swiergosz*

---

## INTRODUCTION

The Office of Naval Research (ONR) has funded science and technology research in Undersea Medicine (UM) since the early 1950s. The UM Program is a part of ONR's Discovery and Invention (D&I) portfolio, which makes broad investments in basic (6.1) and applied (6.2) research that will increase fundamental knowledge, foster opportunities for breakthroughs, and provide options for advanced technology research (6.3) through the Future Naval Capabilities (FNC) Program. D&I programs such as UM nurture creativity and seek a balance between risk, opportunity, and potential naval impact. Figure 1 illustrates the UM program's interactions and contributions to the U.S. Navy and world-wide undersea community.

## UNDERSEA MEDICINE RESEARCH PROGRAM

In order to leverage contemporary biomedical and electrophysiological technologies, more recent UM Program efforts have shifted from defining safety/performance windows for undersea operations (*e.g.*, dive table development) to investigating the mechanisms underlying health and performance challenges associated with manned undersea operations. Current investments are focused on, but not limited to, the following focus areas and sub-topics:

- Decompression Illnesses (DCI)
  - Basic and applied research in mechanisms of DCI
  - Advanced applications in DCI mitigation
    - Non-recompression prevention and treatment strategies
- Oxygen (O<sub>2</sub>) Toxicity
  - Basic and applied research in mechanisms of O<sub>2</sub> toxicity
  - Advanced applications in O<sub>2</sub> toxicity mitigation
- Short- and Long-term Health and Performance Threats
  - Basic and applied research in diver/submariner health and performance risks
  - Advanced applications in health and performance risk management for the diver/submariner

During the 2007 fiscal year, the UM Program was designated as a National Naval Responsibility (NNR). This designation was a major achievement because it established UM as a research program that is critically important to naval operations. While the instruction that defines the nature of NNRs may be modified at the request and approval of the Chief of Naval Research (CNR), the historical purpose of a NNR is to sustain (a)

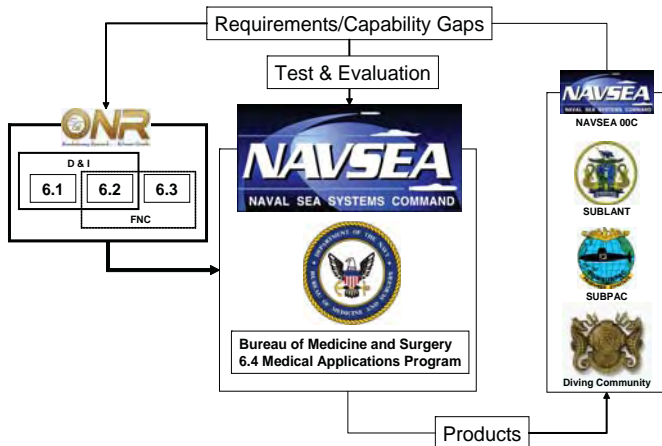

**FIGURE 1. Office of Naval Research (ONR) interactions and contributions to the undersea community. The Discovery and Invention portfolio outlined in bold within the ONR block represents the Undersea Medicine Program.**

a robust research capability to work on long-term science and technology (S&T) challenges of interest to the Department of the Navy, (b) a pipeline of new scientists and engineers in disciplines of unique Naval importance, and (c) S&T products necessary to ensure future superiority in integrated naval warfare.

## INTERNATIONAL COOPERATION AND PROGRAM OPPORTUNITIES

We assume that all diving and submarine communities share S&T challenges similar to those that were outlined in the previous section. Therefore, we should leverage the entire international community of scientists and engineers who have established expertise in diving and submarine research to satisfy UM Program goals and objectives. This does not equate to ONR being the sole source for funding world-wide research in this area, but rather establishes itself as a leader to promote international cooperation and optimization of current and future investments. In some cases this will involve direct funding of work efforts and in other cases it may take the form of aligning international research efforts in order to more efficiently and effectively address common research goals and objectives.

The UM Program seeks preproposals (white papers) and proposals for basic and applied research that address either DCI, O<sub>2</sub> toxicity, or other short- and long-term health/performance threats associated with manned undersea deployments. Work efforts normally run for two to three years on fiscal year cycles (1 October – 30 September). Program opportunities are outlined below.

- Preproposal
  - Format: [www.onr.navy.mil/sci\\_tech/34/prop\\_preproposal.asp](http://www.onr.navy.mil/sci_tech/34/prop_preproposal.asp)
  - Submission: email attachment to the UM Program Officer no later than 1 March for potential funding beginning 1 October

- Proposal
  - Format: [www.onr.navy.mil/sci\\_tech/34/prop\\_format\\_instructions.asp](http://www.onr.navy.mil/sci_tech/34/prop_format_instructions.asp)
  - Submission:
    - Universities, Organizations, Non-profits: [www.grants.gov](http://www.grants.gov) per ONR Broad Agency Announcements (BAA; [www.onr.navy.mil/02/baa/](http://www.onr.navy.mil/02/baa/)) no later than 1 June for potential funding beginning 1 October
    - Commercial: [www.grants.gov](http://www.grants.gov) (must establish as a commercial/profit entity) per ONR Broad Agency Announcements (BAA; [www.onr.navy.mil/02/baa/](http://www.onr.navy.mil/02/baa/)) no later than 1 June for potential funding beginning 1 October. Email attachment per ONR Broad Agency Announcements (BAA; [www.onr.navy.mil/02/baa/](http://www.onr.navy.mil/02/baa/)) no later than 1 June for potential funding beginning 1 October
  - Animal and Recombinant DNA Use: [www.onr.navy.mil/sci\\_tech/ahd\\_usage.asp](http://www.onr.navy.mil/sci_tech/ahd_usage.asp)
  - Human Subjects Research Sponsored by the Department of the Navy: [www.onr.navy.mil/sci\\_tech/34/documentation\\_requirements.asp](http://www.onr.navy.mil/sci_tech/34/documentation_requirements.asp)

ONR Global (ONRG) is the international presence for ONR, which actively seeks opportunities to promote science and technology collaboration of mutual benefit between the United States and researchers around the globe.

- Visiting Scientist Program (VSP; [www.onrglobal.navy.mil/vsp.asp](http://www.onrglobal.navy.mil/vsp.asp))
- Conference Support Program (CSP; [www.onrglobal.navy.mil/csp.asp](http://www.onrglobal.navy.mil/csp.asp))
- Naval International Cooperative Opportunities in Science and Technology Program (NICOP; [www.onrglobal.navy.mil/nicop.asp](http://www.onrglobal.navy.mil/nicop.asp))

## BUILDING AN AGENDA FOR THE FUTURE

An international meeting focused on the science of undersea medicine does not currently exist. The Undersea and Hyperbaric Medical Society (UHMS) hosts an annual meeting that is normally held in the United States. More recent UHMS annual meetings have been dominated by plenary and continuing education sessions that more directly support clinical practice and recreational diving. The European Underwater and Baromedical Society (EUBS) also hosts an annual meeting. Its content has also been dominated by issues related to clinical practice and recreational diving. Other professional organizations that hold annual meetings have a sparse representation of research focused on undersea medicine. While all of these meetings have merit, and we hope that our sponsored scientists and engineers contribute to the dissemination of professional information at these meetings, there is no indication that their agendas will consistently focus on the advancement of basic and applied

research in undersea medicine and its previously discussed S&T challenges. More importantly, none of these meetings encourage young scientists to pursue a career in undersea medicine research.

The Undersea Medicine Program Review is an annual review of S&T research efforts funded by the UM Program at ONR, Biomedical Deep Submergence Program at Naval Sea Systems Command (NAVSEA 00CM), and related advanced efforts within the 6.4 Medical Applications Program at the Bureau of Medicine and Surgery (BUMED). The agenda for this

meeting could be modified to include other sponsored work in undersea medicine. Together, we could build an international roadmap for undersea medicine research, and encourage our brightest and most promising young scientists to dedicate their professional endeavors to our community. Future S&T capability in undersea medicine is contingent on our current ability to foster and develop new scientists and engineers. This objective may be achieved by establishing global collaborations that support graduate student and post-doctoral awards.



# Discussion: Diving Researcher Recruitment

*Chairman: Richard E. Moon*

---

**R. Moon:** Does your funding by the government include only support for facilities, or does it include disbursement to other researchers in the form of grants?

**M. Grønning:** We do not issue grants; you have to apply for them elsewhere. Our government funding only covers the daily activities. But that is one of the big things we have to work towards.

---

**M. Lang:** You did not provide any numbers, what is your budget for international cooperation in diving research?

**M. Swiergosz:** I am not at liberty to divulge that information. The budget that I manage is modest. At the last program review we received high marks because my performers do good work in what is considered one of the better, relevant programs at the Office of Naval Research. We have been able to grow the budget and acquire some supplemental funding. This is the first year we have really engaged ONRG heavily and we have a commitment from them for support of the program. It is enough to support research and we will keep on going.

**M. Lang:** How many postdoctoral fellows, for example, did your program fund last fiscal year?

**M. Swiergosz:** Six, and in terms of graduate students, about thirty. There are also some predoctoral students who have received grant funding for good proposals.

**A. Brubakk:** Perhaps one of the main points you are making is that international cooperation is very important. We have to establish a mechanism to make a decision on which important questions we want to answer. Diving research is a small community with only a few laboratories around the world and a handful of people interested in this particular problem. I believe the time has come, one hundred years after Haldane, to decide on at least five very important questions. Then we would try to establish collaborations for the next two years to focus our efforts on those questions. The way to handle that is to establish an organization and state that if you want money, come in and join this effort. This effort has to be funded and organized with scientifically credentialed people with publication records in high-impact journals. After two years we then review what we have done and decide which problem to address next. We need

the type of cooperation we have never had but which is crucial to move this effort forward.

**M. Swiergosz:** I wholeheartedly concur. To revisit the question about funding, the donor does not have enough money to fund all diving medical research. Furthering Alf's thoughts, we need to build a roadmap, find out what resources we have and leverage them to the best of our ability. In order to argue for an increase in budget, notwithstanding the great science already being produced, there is a need for a cohesive strategy. This will allow us to identify and fill in the gaps in our knowledge.

---

**A. Brubakk:** I am convinced that we need to get rid of the people with gray hair and the way to do that is to attract new people with high scientific expectations with less gray hair to become interested. We need to get these people to enter the top programs in genomics or whatever field it is and decide that these environmental physiology questions are so exciting that this is what they want to pursue for a long period of time. How do we accomplish that? Funding availability is only part of the story. Money is a part of the story and will also follow perhaps the ability to generate excitement about this. This is also a public relations question: how do we sell ourselves in order to get it done? Olav Eftedal suggested that we try to establish something similar to the human genome project. We have to make a common effort and decide that this is important to do and convince the rest of the world of the same.

---

**R. Moon:** We need to hear from our consumers about their ideas but perhaps we could start by articulating the issues and challenges and then how to attract the funding.

**S. Lothe:** Our challenge in the saturation diving community is that the gray hairs have become long. We need to take a look at the long-term health effects of diving. Entrance and exit selection criteria for the new generation of saturation divers also need to be established to ensure they can continue in this industry for a long period of time. Should there be age-based exclusion criteria? The fastest growing segment of the diving industry is the recreational diver. This diver is no longer happy to dive to



20 or 30 m, they wish to dive to 100 m with rebreathers. This will be a regulatory challenge for all countries.

**Ž. Dujčić:** The key issue remains the money and how we might influence our national and international funding instruments to support this rather small niche of science, which is really diving/environmental physiology. In Europe we have to really lobby in Brussels to change the priorities. There are pre-proposal steps we could take based on these discussions to initiate larger, multi-center collaborative studies. In our country people with good research tracks are working as MDs because there is not much funding in diving physiology. We need to sell this idea through PR efforts and nice web pages on diving projects to influence the decision-makers who are distributing the money. Without this effort we cannot sustain long-term multi-center efforts as they are occurring in hypertension and diabetes for example. The exercise symposium had some excellent papers on cooperative projects that serve as examples on how to collaborate. Those multi-center trials of high intensity exercise have a project coordinator, partners, and agreements on methodologies. These types of large-scale projects must have involvement from the National Institutes of Health, the National Science Foundation and the European Science Foundation, in addition to other national science foundations.

**R. Moon:** The U.S. national funding agencies' take on this type of research support is that there are only a small number of divers with a small number of morbidities, unlike HIV or diabetes. The funding priorities are fairly low for diving, except when there is a national priority, for example protecting divers in the military or the commercial field where there is a national interest. Before we arrive at the funding strategy, we need to identify the diving problems worthy of being solved.

**Ž. Dujčić:** Long-term health effects and safety of the millions of recreational divers diving deeper and deeper is a research possibility.

**A. Fahlman:** Environmental physiology should be used as a tool to investigate clinical problems. Bubbles are a huge problem in cardiopulmonary bypass surgery. Inert gas exchange every time we go under anaesthesia also needs to be better understood.

**M. Lang:** The common thread in the presentations by S. Slordahl and O. Ellingsen centered on the issue of attracting new young researchers to the field for pure science. Solving specific operational diving issues may be viewed as an applied science and is perhaps best addressed through a contract with a specific outcome or solution. David Doolette said it best, "Haldane still rules." In 1991, we held a large, interdisciplinary repetitive diving workshop at Duke University Medical Center. The international DCS incident rates, as presented by the diving communities at that time, were 1:1,000 dives for commercial diving, 3.2:10,000 dives for recreational diving, and 1:100,000 dives for scientific diving. At those levels of DCS incident rates, deemed "acceptable" by those three diving communities

(recognizing that zero incidents is desirable but unachievable), it would appear that even 18 years ago, decompression sickness was not a significant problem. Going forward, focusing solely on decompression sickness may not be the path to follow. For the advancement of science, not solely the solution of operational diving problems, the probability of attracting bright young researchers would more likely follow a redirected research emphasis that focuses on big scientific questions.

**A. Brubakk:** I quite agree. We need to look at scientific problems in a way that has practical applications, hopefully for millions of people. As an example, some work we have done here was actually by chance, looking into diving, bubble formation and endothelial function, has changed the whole field of exercise physiology. Everyone believed until then that the effect of exercise came from doing it for months at a time until something changed. First, exercise is becoming more important as a drug and second, it is the single bout of exercise that is important. This result came from a diving experiment and is the type of research that will excite people outside of the diving community and attract funding.

**C. Balestra:** We have to go outside our research niche. Another idea is to understand how a healthy human coping with an extreme environment compares to an older human coping with a normal environment.

**I. Eftedal:** I found it very interesting from a medical genetic point of view to determine how the genome or proteome is challenged by a changing physiology. Health is to a very large extent defined by how much you can express your proteomes in response to a challenge you have. People will be attracted to study the effects of the environment on the genetics, genomics and proteomics.

**Ž. Dujčić:** Sleep apnea may be a healthy research model to examine as there are millions of suffering people. Hypertension, pulmonary arterial disease, lipid disorders are others. Non-specific effects of stress response during diving are another topic worthy of investigation and how we can have a wider impact outside of our community.

**R. Moon:** Another way of looking at it is that there are people working on some of these phenomena in other fields that could be attracted to work on some of our diving problems. For example, there are many investigators working on spinal cord injuries and biochemistry of heat-shock proteins who could apply their techniques to diving.

**S. Lothe:** We have extreme exposure divers in their 50s and 60s who have for the last 30 years spent 180 plus days in saturation at 100-200 m depth every year. These healthy individuals may be of interest as to what makes them tick. These divers are fit and interested and do not want to stop saturating. They have experienced the most extreme pressure changes of any population. What makes them fit? Why are they healthy?

**J. Jakobsen:** The key word is natural selection. Why are some selected to continue and why do others drop out?

**J. Ross:** This kind of question inevitably leads to psychological issues and people's perception of the risk of the job they are in and how they should be responded to. Why do people go to see their doctor? Is it because they perceive minor symptoms of everyday illness or are these people who do something very different with high profile health effects? Some people will be vulnerable to that concept and some people will not. These are not just diver issues. It goes back to the impact of technology on human populations. Repetitive strain injury is a phenomenon where people react adversely to a change in their work circumstances. This is a psychological issue with potential particularly in the oilfield diving industry.

**R. Moon:** Articulation of the problems and availability of money will lead to young and senior researchers' willingness to work on these questions. Twenty-five years ago HIV research did not exist and it is now a multi-billion dollar enterprise. Where did those researchers come from? They came because there was a problem, money to solve the problem, a complicated issue that was interesting to work on. There is no shortage of interesting issues to work on in diving.

**J. Jakobsen:** The question is strategy for recruiting. The diving contractor needs to feel supported by the research community, not through investigations of all kinds of reasons why he should stop diving. Support would come by finding methods of adapting to problems and solving his potential trouble so that he can continue diving. The latter approach is very important. Management of many diving companies is reluctant to allow diving researchers into their ranks because it is a potential show stopper.

**R. Moon:** That is an important point because the diving community's traditional approach has often been to find reasons why people should not dive, which is easy to accomplish without very much data.

**M. Swiergosz:** The quality of life issue for many U.S. Navy divers is their continued ability to dive. We should be trying to enable human beings to go into this potential adverse environment.

**S. Daniels:** The last time there was any significant investment in this field was when the U.S. Navy developed a strategy to dive beyond 500 m. That coincided with the explosion of exploration for oil and gas at depths beyond which diving technology could provide for. There is a common perception these days that those problems have been solved. There is no clear statement by any of our community about what the problem is. Until we can articulate that, we will not attract people into this field. There exists exactly the same issue in anaesthesia, which is a field with scientific terms that has been running for approximately the same amount of time as diving. Nowadays, certainly in the U.K., under appropriate national government funding organizations there has to be clinical representation. Assume an application for support of a program to look at mechanisms of

anaesthesia; the review response is "what problem"? We anaesthetize you, you wake up, and you survive, no problem. In order to secure funding we need to articulate what the new challenge is beyond what we can do today.

**J. Jakobsen:** That is exactly the point when we approach diving management, what problems, we do not have any problems. One way to tackle this might be to implement a more comprehensive monitoring of the exposure that takes place during diving. There exists no clear definition of what exposure is or the analytical tools to describe the exposure, which could be petrochemical contamination, thermal, oxygen or other parameters. The automatic monitoring system is mapping just about everything so we know an awful lot about operational dives, but what are going to do with all that operational data? We need to find a proper way of storing it, reduce it and analyze it by developing tools to determine if there is a long-term health effect.

**R. Moon:** That is very good point but how does one get around the issue that you just raised that the diving doctor community is trying to get people to stop doing what is currently seemingly OK?

**M. Gennser:** Integrative physiology has gone down a lot in the past decades, displaced by genomics, biochemistry, proteomics. Progress made in those fields now needs to be tested on themes exposed to human environments. One of our selling points is actually that our exposures to extreme environments being decompression or hypoxia or large accelerations can expose physiological, biochemical mechanisms, but this is not immediately evident. One colleague has been working on arm pain experienced by pilots of high performance aircraft. The research there has provided insight into causal mechanisms.

**J. Jakobsen:** In the 80s and 90s there was a situation where most of the divers were permanently employed and there was good feedback from the divers on their problems. Today the divers may not tell the medical doctor of their problems for fear of losing their job, so there needs to be a security system to share that information.

**A. Brubakk:** We cannot solve all diving problems at once and need to come back and decide which problems we think are the most important.

**D. Doolette:** Cross-fertilization of diving problems that Andreas Fahlman mentioned to solve other problems is a very good idea. I did that for ten years until the funding agency realized there was an easier way of doing that. And as Michael Lang said there are operational procedures to be developed as well such as diving to 100 m for science purposes. Decompression is a very obscure field and it is really operational issues that are going to drive it, if they are not there, we are not going to exist. We can solve the cross-fertilization problems in another way. Our responsibility is to recruit scientists into this field to keep it going. It will not support very many people but it needs to be a continuous program. The Navy keeps funding some university programs even though there are no current problems because they know there will be problems in the future. Collaboration

is the key and in the civilian world there needs to be a group of people who get together and make a home for those scientists. A permanent ongoing presence will attract people, a short-term funded program will not. Creation of a virtual international institute of diving with some key members and a common set of problems to be addressed will feed that longevity.

**R. Moon:** An important aspect of collaboration is meetings like this. Matt Swiergosz runs a meeting every year in the U.S. along similar lines which creates a major portion of the atmosphere of excitement that draws young people into the field.

---

**Ž. Dujčić:** We can sell environmental physiology as human integrative physiology, a field that is coming back. Looking only at molecules will not solve complex situations. At the University of Wisconsin in Milwaukee there was a departmental fusion of Anesthesiology with Physiology thirty years ago because a faculty member in Anesthesiology, John Kampine, was really a big name in Physiology as well. I completed my work in anesthesiology but actually got my PhD in physiology. By being connected with another field is how Anaesthesia survived and it is now considered one of the best basic experimental Anaesthesia departments in the U.S.

---

**P. Lindholm:** Many of the commercial operational dives are not a big problem. Today the recreational divers go beyond the limits and do not have a safety net. The technical divers push the limits and present with strange decompression issues. Breath hold divers are drowning in swimming pools, mostly due to lack of training. Recreational divers on beta-blockers for hypertension come to the diving doctor and ask if they can still go diving. Who is going to do that research? There have been some advances in asthma and diabetes in diving. In the recreational diving community there are problems from a medical point of view. It remains however a small group and small problem with respect to other societal medical problems.

**J. Gangenes:** North Sea diving operations are saturation diving almost constantly from 60 m down to 300 m. The discussions have been regarding surface-oriented decompression for normal air or nitrox dives. The saturation divers do not complain because of their employment. Part of their living is diving. The challenge we have is those divers who have been under pressure for thirty years now do not tell us their problems and we do not know what the maximum amount of years under pressure should be.

---

**J. Buckley:** The perception of this field in general does not come so much from diving as it does from our larger clinical cousin, hyperbaric oxygen therapy. There is much gray research in that area that is not being done and there are problems with how hyperbaric oxygen therapy is being applied. That may be where much of the doubt is coming from in getting more people into this area. More funding in the HBOT area would likely bring in additional new researchers who would then also be interested in diving.

**M. Lang:** Directors of scientific program use metrics to evaluate the effectiveness and success of the research funding provided. One such metric is quantity and quality of publications in high-impact journals such as Science, Nature, or Proceedings of the National Academy of Sciences. Positive results were shown here in this regard and perhaps those studies that were successfully published in such journals are areas that should be further pursued as they were successful in breaching the wall and acquiring continued funding.

**J. Ross:** We are talking about decompression sickness here and the problem as I see it is getting all the people to examine who actually have the problem. That way you can apply advanced techniques and investigations of the people who actually have the disease. Top that end there is major room for international collaboration for studies of DCS. In Scotland we have four chambers that treat between 100-150 cases per year and there are other chambers around the world with similar numbers. This is where you can also pick up cases of severe decompression sickness that will illustrate what the major issues are. Why do divers die from decompression illness? Once you get a hold of that kind of question and the real cases you can do the research. Decompression illness is less common as time goes by with the development of decompression technologies. We are developing an international database that will inform us of what is actually going on with people with decompression illness.

**S. Gaustad:** To help provide some funding perhaps a small annual fee to an organization that does diving research may be the way to go, similar to DAN member fees.

**C. Balestra:** For reference, DAN Europe tries to get 1 Euro from each member for diving research.

**A. Brubakk:** We tried to establish some years ago the notion of having every recreational diver pay 5 dollars, pounds, Euros, whatever denomination, in exchange for which they get 5 extra minutes of bottom time. This is not an impossible idea. Every diver would pay to be member of this group with a community feeling that they are supporting diving research and getting five extra minutes of bottom time. That's PR, the idea is to not get too specific.

**A. Antonsen:** It seems the oilfield diving companies have been challenged several times about providing the money for diving research. What about CMAS and PADI who are providing the recreational divers, where are they?

**A. Brubakk:** We challenge everybody.

---

**H. Janssen:** There is a negative focus of much of the research that has been going on historically. It is focused on the accidents and outcomes of what we are doing. This is over documented compared to the success stories. We annually conduct thousands of saturation hours worldwide without incidents. Divers get in alive and get out alive. We should also focus on how we as companies and the scientific community documents operational research. This is scientifically very low on the scale of what people publish. If you review the literature, operational research results are almost non-existent. That will lead to a documentation of

best practice, which is what we live off. It is also something we can easily sell internally in our industry and to those who fund us, the oil companies. That is how we review what we are doing without jeopardizing Statoil or the Norwegian government. My second comment is about terminology and the concept of bounce diving, which is very different in the commercial diving community, a historical concept which was used offshore and is not used anymore. The conceptualization of saturation diving and what is best practice is different around the world and even within large companies. Saturation diving has also changed from being bottom-focused work in very deep water to shallow-water saturation because the oil industry has changed. We now do shallow sats in the air range of 15-20 m with a narrow excursion window and problems or possibilities that we know very little about. The tables were developed many years ago and are now carved in stone and almost impossible to change because of regulations. My final point is that of the transition of the knowledge gained within these various fields in a feedback loop to where we can utilize it. We are now doing extensive development of personal diving equipment: rebreathers, drysuits, electrically heated undergarments, etc., which definitely have applications in military diving, where these developments are also taking place. We are reinventing the same wheel in many instances for different reasons. There is no obvious feedback and lack of knowledge among diving communities of what each is doing in this small community around the world.

**O. Eftedal:** The problem of petrochemical exposure under pressure is of interest and concern to occupational medicine.

**M. Lang:** Does anyone have the decompression sickness incident rate for saturation diving or are there no problems when divers come out of sat?

**O. Eftedal:** Very little, there have been only two cases in Norway in fifteen years.

**J. Ross:** I recently did an assessment of DCS rates among divers in the North Sea and the incident rate has not change in many years. There is not much literature on diving from a public health or preventive medicine perspective. I do population-based medical research and there are not many studies of large populations of divers. I reiterate the need for generating data to establish what the real problems are in populations of divers.

**G. Perdrizet:** I have installed a large multiplace chamber in the New England region of the United States. I have seen two requests for recompression treatment for decompression illness. However, in a normal week I will see multiple head injuries, crush injuries, and spinal cord injuries. In terms of the hyperbaric medicine issue, we should focus on that. Right now we are linked in a seven center trial where we are trying to get money. We have been turned down once by the Department of Defense but are resubmitting. It is very difficult with a high profile type diagnosis, but there needs to be a perception by the funding agencies that you have a problem. HIV shows up on time with affected people, but you do not have that here. I recently submitted a grant proposal to the NIH to use hyperbaric medicine in a major emerging infectious disease in the world right now

that is causing deaths in our hospital. It is interesting that a pall sits over hyperbaric medicine right now, which is in its infancy. This is a big opportunity but a big uphill struggle which we all suffer from.

**R. Moon:** We have a problem otherwise many of us would not be sitting here. The main discussion points are summarized below.

## 1. PHYSIOLOGY/BIOCHEMISTRY

- Immersion
- Inert gas exchange
- Pulmonary gas exchange
- Breath hold diving
- Narcosis
- HPNS
- Genomics/Proteomics
- Exercise – stress

## 2. CHALLENGES

- Publication of non-accident experience
- Change approach to extend, not exclude, diving careers
- Shallow saturation tables are antiquated
- DCS
  - pathophysiology
  - treatment
- Saturation diving
  - Decompression
  - Infections
  - Emergency care
  - Long-standing sat divers
  - Trace gases
- What is “best practice?”
- AGEING DIVERS
  - Exclusion criteria (age, co-morbid conditions)
- DIVER SELECTION
  - Sat divers
- OXYGEN EFFECTS
- TOXIC EFFECTS (petrochemical) enhanced by increased pressure?
  - Thermal issues
  - Long-term effects
  - Psychological issues
- Population studies in divers needed (vulnerability of people to work-related environments)

## 3. METHODOLOGY

- Mechanisms of HBO
- Cross-fertilization
- Cardiopulmonary bypass
- Anaesthesia?
- Military-commercial diving cross-fertilization

## 4. MONEY

- Multi-center collaboration: DCS cases





# How Do Marine Mammals Avoid DCS?

*Andreas Fahlman*

---

**ABSTRACT.** Ever since the pioneering work by Scholander in 1940, it has been generally accepted that alveoli collapse at shallow depths in breath-hold diving marine mammals, reducing the amount of  $N_2$  taken up. This has been described as the major adaptation to prevent decompression sickness (DCS) in mammals. However, more recent experimental and theoretical work suggests that gas exchange may continue to depths much deeper than previously believed. Foraging marine mammals perform bouts of repeated long and deep dives interspersed by short surface intervals. With continued gas exchange, this results in accumulation of blood and tissue  $N_2$  to levels that would cause a high incidence of DCS in terrestrial mammals. It has been suggested that a coupling between physiology and dive behaviour may be important in decreasing end-dive  $N_2$  levels. For example, mammals may adjust their diving lung volume during dives to different depths, allowing for behavioural control of the depth of alveolar collapse. A slower ascent rate close to the surface coupled with a pre-surface tachycardia may reduce the end-dive venous  $N_2$  tension ( $PN_{2v}$ ) by as much as 45%. The short and shallow dives that commonly occur between dive bouts may moderate  $N_2$  supersaturation and thereby DCS risk. Adipose tissue, with its higher  $N_2$  solubility, may lessen DCS risk during the first few dives in a bout by functioning as a sink to buffer extreme levels of  $N_2$ , but may eventually become a liability and force animals to end a dive bout. It is also possible that marine mammals evolved adaptations making them less susceptible to bubbles. Understanding these successful adaptations may provide novel ways of preventing or treating DCS human divers.

## PULMONARY SHUNT AND ALVEOLAR COLLAPSE

In 1940, Per Scholander published his seminal work on diving mammals. In one section of this opus, he discussed the implications of the anatomy of the respiratory system of marine mammals. He noted that marine mammals appeared to have a very compliant rib cage and stiffened upper airways. He suggested that the increasing pressure with depth would compress the chest and push all the air into the upper airways. This would prevent gas exchange at depth and thereby reduce  $N_2$  uptake during breath-hold dives. Using measured volumes of the upper and lower respiratory system in whales and seals (*Hyperoodon ampullatus*, *Cystophora cristata*, *Halichoerus grypus*, *Balaenoptera physalus*, *Phocaena communis*), alveolar collapse and termination of gas exchange was estimated to occur at depths ranging from 30 m to 210 m depending on the diving lung volume (Scholander, 1940).

Following the work of Scholander, a number of studies have attempted to answer the question of when and where the lungs may collapse in different species. Biological tissues have limited scope to resist pressure differences and negative trans-thoracic pressures exceeding 100 kPa will damage tissues (Brown, 2000). It was therefore concluded that the chest must compress and eventually collapse to prevent damage. Both direct and indirect evidence of chest collapse has been reported in the diving dolphin (Kooyman, 1973; Leith, 1989; Ridgway et al., 1969). However, compression of the rib cage does

not prove that the alveoli have collapsed and that gas exchange has stopped. Collapse depth has been estimated by assuming a rigid trachea and highly compliant lung (Denison and Kooyman, 1973; Stephenson, 2005). This assumption is questionable as the trachea in a Weddell and elephant seals showed significant compressions at depth of only 54 m. Direct measurement of inert gas exchange during diving has suggested that alveolar collapse, and a concomitant cessation of gas exchange, occurs at 30 m depth in the Weddell seal (Falke et al., 1985) and 70 m in the dolphin (Ridgway and Howard, 1979). These depths are relatively shallow and could possibly prevent significant levels of  $N_2$  uptake and minimize DCS risk during deep diving (Falke et al., 1985; Ridgway and Howard, 1979; Scholander, 1940). An experimental study, on the other hand, suggested that gas exchange may persist until a depth of 170 m in seals and sea lions diving with lung volumes ranging between 18 to 67 % of total lung capacity (TLC) (Kooyman and Sinnott, 1982). In addition, recent modelling attempts provide alternate explanations for the uptake and removal of  $N_2$  in the dolphin and Weddell seal (Bostrom et al., 2008; Fahlman et al., 2009; Fahlman et al., 2006), consistent with the idea postulated by Scholander (1940) and experimentally shown by Kooyman and Sinnott (1982), that alveolar compression results in an increasing pulmonary shunt.

## ESTIMATING LUNG COLLAPSE DEPTH USING $N_2$ UPTAKE AND REMOVAL

### THE DOLPHIN

Lung collapse in the dolphin was estimated at 70 m in a study by Ridgway and Howard (1979). They studied freely diving dolphins trained to dive repeatedly to 100 m with average dive duration of 1.5 min and surface interval of 1 min. The two dolphins dove repeatedly 23 times for an hour. At the end of the bout, each dolphin jumped onto a work platform and a catheter was inserted into the dorsal epaxial muscle tissue. The muscle  $N_2$  washout rate was converted to a tissue half-time ( $\tau_{tiss/2}$ ) which determines the time to equilibrium after a change in pressure. The time constant is physiologically relevant and related to the solubility of the gas, the blood flow and the volume of blood that passes by the tissue in a given time (Fahlman et al., 2009; Fahlman et al., 2006; Fahlman et al., 2007). The data from the dolphins suggested that muscle  $\tau_{tiss/2}$  were 6.6 min and 5.2 min for each of the two animals. The observed values of  $PN_2$  could be explained using a standard exponential gas exchange model that assumes symmetrical gas uptake and removal and assumes that gas exchange was terminated at 70 m. The authors suggested that this provided evidence for lung collapse (Ridgway and Howard, 1979). However, most, if not all, breath-hold diving mammals show a higher heart rate while breathing at the surface as compared to diving, i.e., the dive response (Butler and Jones, 1997). Since blood flow affects inert gas uptake and removal in breath-hold diving mammals (Fahlman et al., 2009; Fahlman et al., 2006; Fahlman et al., 2007), the assumption of symmetrical gas uptake and removal

have to be reconsidered. In fact, a recent study showed that a 50% reduction in blood flow during diving as compared with the surface value (Fahlman et al., 2006) provides estimated values that agreed with the observed data in the dolphin.

### THE WEDDELL SEAL

In a study on freely diving Weddell seals (Falke et al., 1985), arterial blood was sampled during the descent phase every 30 sec. The results showed that, independent of the maximum dive depth (80 m to 200 m), arterial  $PN_2$  continued to increase during descent to a depth of 30 m. This was followed by a continual decline in arterial  $PN_2$  as the animal continued the descent (Falke et al., 1985). It was concluded that this was evidence of alveolar collapse and termination of gas exchange at a depth of 30 m, and the gradual decline in arterial  $PN_2$  caused by tissue absorption of the available blood  $PN_2$ . However, this conclusion is incompatible with cardiopulmonary physiology and not evidence of complete alveolar collapse, but rather agrees with the suggestion of a pulmonary shunt that increases with depth (Bostrom et al., 2008; Scholander, 1940). If the data were evidence of alveolar collapse, arterial  $PN_2$  should immediately have declined close to ambient levels. The reason for this is the circulatory transit time, which has been shown to be between 2-3 min in Weddell seals during forced chamber dives (Kooyman et al., 1972). While the dive response differs in forced and freely diving animals, being more severe in the former, the forced dives resulted in a 87 % decrease in the heart rate during diving in the elephant seal (Kooyman, pers. comm.) and by 75% in the freely diving Weddell seal (Falke et al., 1985). If heart rate is directly related to cardiac output, the reduction in blood flow is similar in these deep diving species. In other words, as the animal descends, it takes 2-3 min for the first volume of blood to go from lung to tissues and back to the lung. Thus, a dive-related increase in mixed venous  $PN_2$  lags behind arterial  $PN_2$  by 2-3 min (Kooyman et al., 1972). The seals reached 30 m during the 80 m or 200 m dive after ~ 2 min of submergence (see Fig. 2 in Falke et al., 1985). Therefore, if the alveoli collapse within 2-3 minutes of submergence, arterial  $PN_2$  should drop instantaneously close to the value at the surface because any  $N_2$  taken up before alveolar collapse would not have made it around the circulatory system.

The antagonistic effect of compression on diffusion rate is an alternative explanation that explains the data in the Weddell seal (Bostrom et al., 2008; Fahlman et al., 2009; Scholander, 1940). Compression of the respiratory system will, on the one hand, result in an increasing partial pressure gradient and thereby an increase in the diffusion rate. On the other hand, compression will also result in a reduction in the diffusion rate caused by the reduced gas exchange surface area and increasing diffusion distance. Thus, compression will initially increase the diffusion rate and inert gas uptake but as depth increases a pulmonary shunt will develop that decreases the uptake rate (Bostrom et al., 2008; Fahlman et al., 2009; Scholander, 1940).

## MEASURING CHANGES IN GAS EXCHANGE AT PRESSURE

While the studies on dolphins and Weddell seals implicitly assumed that termination of gas exchange occurred instantaneously, others have shown experimental and theoretical evidence that compression results in a shunt that increases with pressure (Bostrom et al., 2008; Fahlman et al., 2009; Kooyman and Sinnott, 1982; Scholander, 1940). In one study, measuring pulmonary shunt in California sea lions and harbour seals at pressures equivalent to a depth of 70 m to 90 m, respectively, showed a reduction in gas exchange that correlated with depth and diving lung volume (Kooyman and Sinnott, 1982). At a depth of 90 m (10 ATA) the shunt exceeded 70% in the harbour seal and complete alveolar collapse and termination of gas exchange was estimated to occur between 160 m and 170 m (17 ATA to 18 ATA, Kooyman and Sinnott, 1982). The species used for this study were chosen as they show the most divergent airway structure of those measured in pinnipeds (Denison and Kooyman, 1973). Despite this, the compression shunt at pressures below 8 ATA (70 m) were not remarkably different from each other (see Fig. 2 and 3 in Kooyman and Sinnott, 1982).

A recent mathematical model, describing compression of the upper and lower respiratory tract (Bostrom et al., 2008), showed that graded alveolar collapse and its effect on gas exchange produced results that agreed with observed data in the dolphin (Ridgway and Howard, 1979), California sea lion (Kooyman and Sinnott, 1982), Weddell (Falke et al., 1985) and harbour seal (Kooyman and Sinnott, 1982). In addition, the model also predicted compression of the upper respiratory tract that agreed well with the measured data in the Weddell seal. Furthermore, it was predicted that complete collapse would not occur until a depth > 150 m, similar to the predictions made by Scholander (1940) and Kooyman and Sinnott (1982).

If gas exchange does not cease at shallow depths, is it possible that some species of mammals live with elevated  $N_2$  levels that could cause bubble formation with alterations in the dive behaviour? In fact, mathematical modelling estimates suggest that deep diving beaked whales may experience end-dive mixed venous  $P_{N_2}$  values that result in 50% DCS in similar sized terrestrial animals (Fig. 1, Hooker et al., 2009). If so, how do they avoid DCS when foraging for food and could climate change impose behavioural changes that increase risk?

## OTHER MECHANISMS TO AVOID DCS

Only one study has measured the effect of compression on gas exchange (Kooyman and Sinnott, 1982) and no study has directly measured cessation of gas exchange. Theoretical models and experimental data propose that the depth for complete alveolar collapse ranges between 30 m to 300 m depending on the structural properties of the respiratory system and the diving lung volume (Bostrom et al., 2008; Fahlman et al., 2009). While little information exists how the respiratory system in marine mammals compresses during breath-hold diving and how this

affects gas exchange, termination of gas exchange is routinely quoted in animal physiology textbooks as the primary adaptation that protects marine mammals from elevated  $N_2$  levels and DCS. Scholander did indeed suggest that cessation of gas exchange could protect against DCS but indicated that the actual diving lung volume would determine the depth at which this occurred and there is theoretical (Bostrom et al., 2008; Fahlman et al., 2009) and experimental evidence (Kooyman and Sinnott, 1982) that supports this idea. It is less well known that Scholander also reported two possible cases of DCS in a fin whale and hooded seal during a single dive. If mammals adapted for prolonged deep diving can experience DCS during a single dive, DCS may also be observed in breath-hold diving humans.

While marine mammals perform single deep and long dives without apparent DCS symptoms, more remarkable are the extensive foraging bouts carried out by many diving mammals and birds. Such dive behaviour should result in accumulation of  $N_2$  in tissues causing a higher risk of DCS. Scholander concluded that “by repeated dives, conditions as regards diving

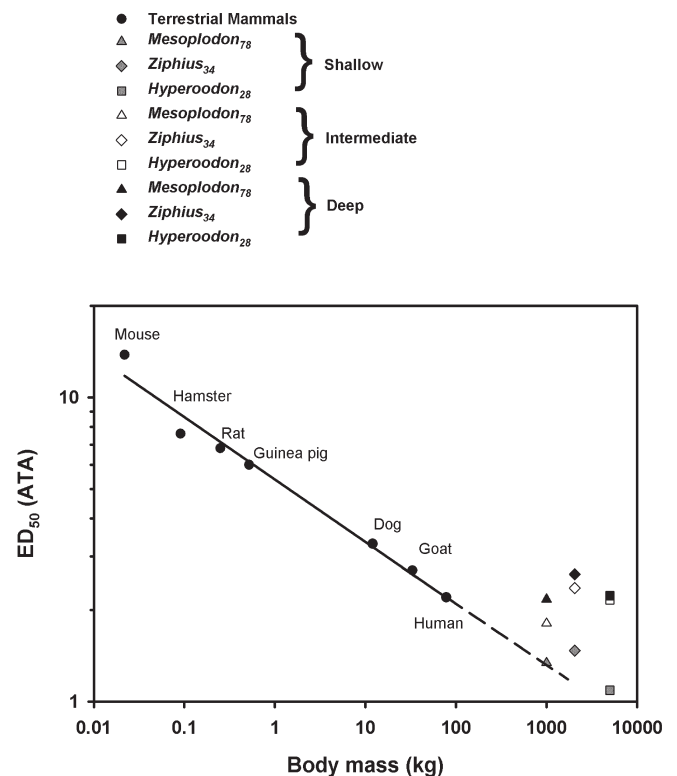

**FIGURE 1.** Estimated  $N_2$  saturation pressure (ATA) that would result in 50% decompression sickness (DCS) in a range of terrestrial animals after a rapid decompression (Flynn et al., 1971; Berghage et al., 1979). Black circles are tissue saturation  $P_{N_2}$  for terrestrial animals. The solid line indicates the best fit regression  $\log ED_{50} = 0.730 - 0.205 \cdot \log Mb$ . Open and grey symbols are average mixed venous inert gas tension ( $P_{vN_2}$ ) for Blainville's beaked whale (*Mesoplodon<sub>78</sub>*), Cuvier's beaked whale (*Ziphius<sub>34</sub>*) and northern bottlenose whale (*Hyperoodon<sub>28</sub>*) using Model A. The figure was previously published by Hooker et al., (2009).

disease would certainly tend to be worse on account of an accumulation of invaded nitrogen. There is every reason to believe that this risk exists unless there is sufficient ventilation between dives'' (Scholander, 1940). This agrees with a recent study by Zimmer and Tyack (2007) and Fahlman et al. (2009) in which it was concluded that repetitive diving to shallow depths may cause elevated tissue  $PN_2$  and bubble formation. Necropsy results in stranded beaked whales and dolphins (Cox et al., 2006; Jepson et al., 2003) were suggestive of DCS-like symptoms. These mass stranding events correlated with naval exercises using mid-frequency sonar. It was suggested that the sonar activity may have led to disturbances of the natural dive behaviour resulting in dive profiles causing bubble formation.

Only a few alternative explanations have been proposed to explain how marine mammals avoid elevated inert gas uptake during breath-hold diving. Kooyman (1973) summarized most of these in a review on the respiratory adaptations in marine mammals: 1) increased tissue and blood  $N_2$  solubility, 2) a special  $N_2$  absorbing tissue, 3) changes in cardiac output and varying blood-flow distribution are some possible physiological adaptations that may help prevent excessive inert gas uptake in addition to pulmonary shunt and alveolar collapse. It is also possible that a coupling between physiology and behaviour is important to moderate tissue and blood  $PN_2$  levels and this may have a significant impact on diving animals with increasing anthropogenic disturbances and global environmental change.

#### INCREASED BLOOD $N_2$ SOLUBILITY

There are no published studies that have measured the solubility of  $N_2$  in tissues of diving mammals or birds, but the solubility of blood is similar in the seal and human (Kooyman, 1973). The foam normally found in the upper respiratory tract of marine mammals has been suggested to be a potential  $N_2$  absorbing agent but there is no experimental support for this supposition (Kooyman, 1973). Animal research has shown that inert gas removal can be accelerated by intestinal microbes that metabolize a small portion of the inert gas burden (Fahlman and Kayar, 2003; Kayar et al., 1997). For example, a 5% reduction in the inert gas burden reduced DCS incidence by as much as 50% (Fahlman et al., 2001). Nitrogen-fixing microbes are found in the gut of animals and if present in diving mammals would provide one additional avenue for inert gas removal. Interestingly, a similar suggestion was described by Scholander where  $N_2$  from blood in vitro disappeared in the presence of  $O_2$  (Scholander, 1940). It was suggested that this observation was caused by  $N_2$  fixation of a microbe called organism-X but this was dismissed by others (Scholander, 1940).

#### SPECIAL $N_2$ ABSORBING TISSUES

Diving mammals perform extended dive bouts consisting of repeated dives interspersed by surface intervals that commonly are shorter than each dive. The  $PN_2$  level of each tissue

throughout a dive and a bout depends on the specific  $\tau_{tiss/2}$ . Because this variable is governed by local blood flow,  $\tau_{tiss/2}$  changes for most tissues. Most diving mammals have large amounts of subcutaneous fat that reduces heat loss and acts as an energy reservoir during extended periods without food. The 5-fold higher  $N_2$  solubility in fat as compared with lean tissue, combined with the reduction in cardiac output and re-distribution of blood flow that represents the dive response, results in a high  $\tau_{tiss/2}$  for adipose tissue (Fahlman et al., 2009; Fahlman et al., 2006). These properties have led researchers to suggest that adipose tissues could act as a  $N_2$  absorbent and reduce bubble formation during deep and short duration dives (Behnke et al., 1935; Fahlman et al., 2007; Kooyman, 1973). During the first few dives of a dive bout, tissues with a low  $\tau_{tiss/2}$  (CNS and muscle) experience high  $PN_2$  during the dive, but much of the accumulated  $N_2$  is removed during the ascent and only low levels remain as the animal surfaces (Fahlman et al., 2007). The high  $\tau_{tiss/2}$  of subcutaneous fat, on the other hand, leads to a slow but continuous increase in  $PN_2$  (Fahlman et al., 2007). During the ascent, the pre-surface tachycardia reported in both diving mammals and birds (Andrews et al., 1997; Elsner, 1965; Froget et al., 2001; Kooyman and Campbell, 1972) and increased perfusion to adipose tissue allows a portion of the  $N_2$  in the fast tissues to be taken up by the fat without any dramatic increase in  $PN_2$ . This could help reduce overall mixed-venous  $PN_2$  and thereby decrease the likelihood of bubble formation (Fahlman et al., 2009; Fahlman et al., 2007; Kooyman, 1973). Thus, fat  $PN_2$  is negligible at the beginning of the bout, but slowly increases during each dive even during most of the ascent. This continuous increase in  $PN_2$  could eventually result in elevated adipose  $PN_2$  that could force the animal to undertake a long surface interval (Fahlman et al., 2007). Consequently, adipose tissue could help buffer  $PN_2$  at the beginning of a dive bout but become a liability after a long bout (Fig. 2). This could have significant consequences if the food source available for the animal moved deeper due to global warming or became scarcer as a result of over fishing possibly leading to reduced foraging efficiency.

#### CHANGES IN CARDIAC OUTPUT AND BLOOD-FLOW DISTRIBUTION

The dive response has been suggested as a useful physiological mechanism to reduce inert gas uptake (Fahlman et al., 2007; Ponganis et al., 1999; Scholander, 1940). While this suggestion makes intuitive sense, a previous study only analyzed a 1-hour dive bout consisting of 23 dives (Fahlman et al., 2006). A more recent theoretical study, estimating tissue and blood  $PN_2$  levels in deep-diving king penguins during a foraging trip, showed that an increase in blood flow during diving led to an increased  $PN_2$  at the end of an extended dive bout in some tissues, but a decrease in  $PN_2$  in other tissues (Fahlman et al., 2007). For example, diving bradycardia caused a substantial reduction in brain and central circulation  $PN_2$ , but an increase in muscle and



fat  $\text{PN}_2$ . These surprising results suggest that the diving-related reduction in blood flow does not always reduce  $\text{N}_2$  levels during repeated diving. Interestingly, each tissue had a specific blood-flow rate that resulted in maximum end bout  $\text{PN}_2$  (Fig. 3). A  $\tau_{\text{tiss}/2}$  was computed for each tissue and it was shown that the  $\tau_{\text{tiss}/2}$  resulting in maximum end bout  $\text{PN}_2$  was the same for the different tissues and similar to the average dive duration of 1 to 1.5 min (Fahlman et al., 2007).

It will be interesting to investigate if the  $\tau_{\text{tiss}/2}$  that results in maximum end bout  $\text{PN}_2$  corresponds to average dive duration in different species and if so, this could be an inherent property of inert gas flux in deep diving animals. If that is the case, one would predict that diving animals would avoid tissue perfusion rates that result in tissue  $\tau_{\text{tiss}/2}$  close to the average dive duration. However, as the circulatory system is also responsible for removing  $\text{CO}_2$  and supplying  $\text{O}_2$ , blood flow changes to each tissue is a trade-off between the need to exchange metabolic gases and the need to reduce DCS risk.

Thus, the blood  $\text{PN}_2$  at the end of a dive or an extended bout is a complex function of the need to supply  $\text{O}_2$  to, and remove  $\text{CO}_2$  from, central organs while simultaneously reducing

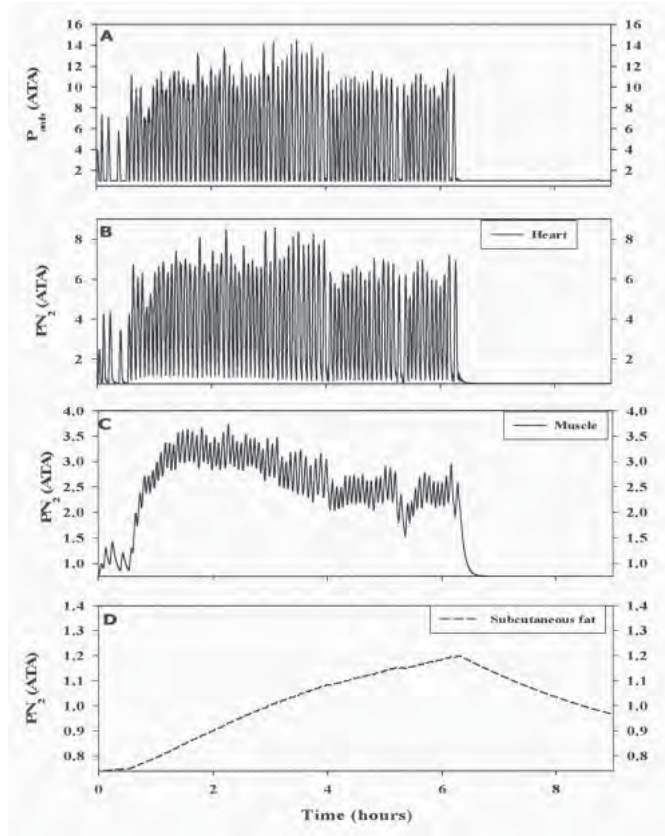

FIGURE 2. (A) Ambient pressure ( $P_{\text{amb}}$ ), and (B–D) estimated  $\text{N}_2$  tensions ( $\text{PN}_2$ ) for a tissue (B, heart) an intermediate (C, muscle) and a slow tissue (D) fat in a 12 kg king penguin. Data shows how the fast and intermediate tissues rapidly reach equilibrium while the slow tissue continuously increases during the entire diving bout. Figure is modified from (Fahlman et al., 2007).

uptake of  $\text{N}_2$ . The question is to what extent blood-flow changes are used as a means to reduce extreme  $\text{PN}_2$  without ischemic injury; this will be an interesting area of research.

#### COUPLING BEHAVIOUR AND PHYSIOLOGY TO REDUCE TISSUE AND BLOOD $\text{N}_2$ LEVELS

Diving mammals and birds may also use behavioural means coupled with physiology to reduce the inert gas burden. It has been shown that the pre-surface tachycardia (Andrews et al., 1997; Froget et al., 2001) and reduction in ascent rate close to the surface seen in some species (Banish and Gilmartin, 1992; Hooker and Baird, 1999; Sato et al., 2004; Tyack et al., 2006)

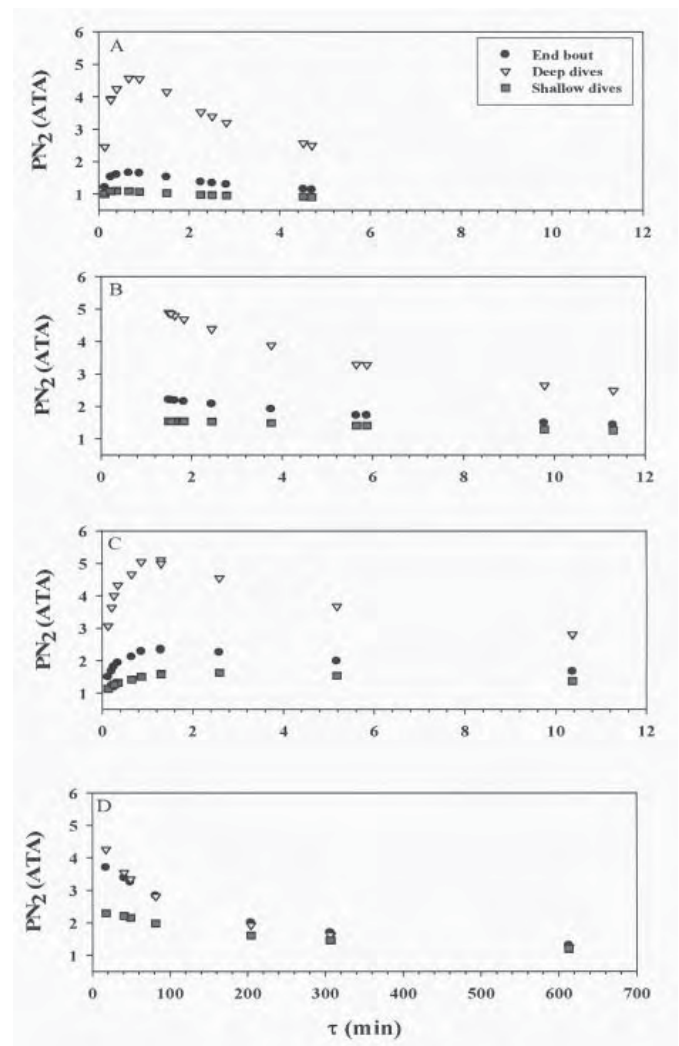

FIGURE 3. Model sensitivity analysis comparing (A) central circulation, (B) muscle, (C) brain and (D) fat  $\text{PN}_2$  levels against diving tissue time constant ( $\tau$ ). Results shown are predicted compartment values at the time the bird reaches the surface after the last dive in a dive bout (black circles), or after deep (>50 m, light gray triangles) or shallow ( $\leq 50$  m, dark gray squares) dives. Figure is modified from (Fahlman et al., 2007).



may reduce the inert gas burden by up to 45% before reaching the surface (Fahlman et al., 2006). However, another study was unable to show any changes in predicted end-dive  $PN_2$  when the ascent rate was varied from 1 m sec<sup>-1</sup> to 20 m sec<sup>-1</sup> in beaked whales (Zimmer and Tyack, 2007). A reduction in the ascent rate is only useful when the tissue  $PN_2 >$  ambient  $PN_2$  and at any other time a diving animal should attempt to return to the surface as fast as possible as this will reduce additional  $N_2$  uptake. In other words, the effect of ascent rate is case specific and depends on the actual blood and tissue  $PN_2$  level.

The short and shallow surface dives that are observed between deep dives or at the end of extended dive bouts could be a behavioural phenomenon that helps reduce supersaturation and bubble formation while gas exchange and inert gas removal continues (Fahlman et al., 2007). It must be pointed out that to be protective, these decompression dives have to be to a depth that allows removal of  $N_2$  and therefore not deeper than the current tissue and mixed venous  $PN_2$ . It is therefore interesting to note that in some diving animals these decompression dives are deepest at the end of a dive bout and subsequently become more shallow (Fig. 4, Fahlman et al., 2007).

## CONCLUSION AND FUTURE RESEARCH

If diving animals use either behavioural and/or physiological means to reduce the inert gas burden, how do they know that they are at risk? Can they sense low levels of bubbles and does this affect physiology and behaviour? To better understand how diving mammals avoid elevated  $N_2$  levels, research efforts must improve our understanding of gas exchange during breath-hold diving. This is not only an interesting physiological problem but an important question in clinical pulmonary medicine, because recruiting a collapsed human lung may represent a severe

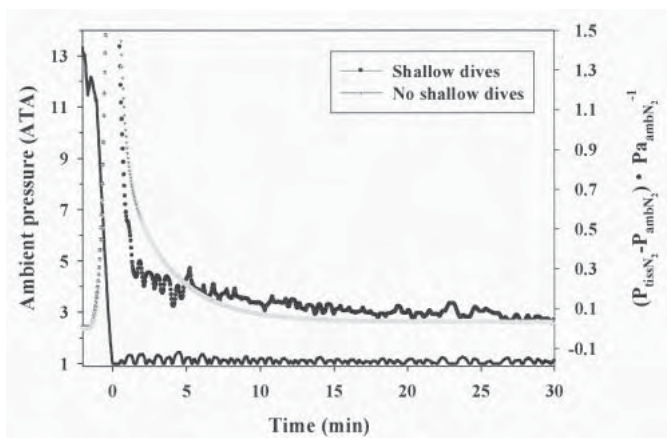

**FIGURE 4.** Ambient pressure ( $P_{amb}$ , ATA) and estimated mixed venous supersaturation ( $\{PN_{2venous} - PN_{2ambient}\} \cdot PN_{2ambient}^{-1}$ ) for a king penguin performing short and shallow dives (black dots) or resting at the surface (grey dots) during an interbout interval. Figure is modified from (Fahlman et al., 2007).

clinical problem. Thus, clinical medicine may greatly benefit if we can understand how marine mammals are able to repeatedly collapse and recruit their alveoli during each deep dive. In addition, if marine mammals live with elevated blood and tissue  $N_2$  levels, do they have any specialized adaptations that reduce DCS risk? Such information may result in novel methods to reduce DCS risk in humans.

## ACKNOWLEDGMENTS

Support for this work was made by a grant to AF from the Office of Naval Research (ONR Award No. N00014-07-1-1098).

## LITERATURE CITED

- Andrews, R.D., D.R. Jones, J.D. Williams, P.H. Thorson, G.W. Oliver, D.P. Costa, and B.J. Le Boeuf. 1997. Heart rates of northern elephant seals diving at sea and resting on the beach. *Journal of Experimental Biology* 200:2083–2095.
- Banish, L.D., and W.G. Gilmartin. 1992. Pathological findings in the Hawaiian monk seal. *Journal of Wildlife Disease* 28:428–434.
- Behnke, A.R., R.M. Thomson, and L.A. Shaw. 1935. The rate of elimination of dissolved nitrogen in man in relation to the fat and water content of the body. *American Journal of Physiology* 114:137–146.
- Berghage, T.E., T.D. David, and C.V. Dyson. 1979. Species differences in decompression. *Undersea Biomedical Research* 6:1–13.
- Bostrom, B.L., A. Fahlman, and D.R. Jones. 2008. Tracheal compression delays alveolar collapse during deep diving in marine mammals. *Respiratory Physiology and Neurobiology* 161: 298–305.
- Brown, R.W., and J.P. Butler. 2000. The absolute necessity of chest-wall collapse during diving in breath-hold diving mammals. *Aquatic Mammals* 26:26–32.
- Butler, P.J., and D.R. Jones. 1997. Physiology of diving birds and mammals. *Physiological Reviews* 77:837–899.
- Cox, T.M., T. Ragen, A. Read, E. Vos, R. Baird, K. Balcomb, J. Barlow, J., Caldwell, T. Cranford, L. Crum, L. Amico, A.D. D'Spain, G. Fernandez, A., Finneran, J. Gentry, R. Gerth, W. Gulland, F. Hildebrand, J. Houser, D. Hullar, T. Jepson, P.D. Ketten, D. MacLeod C.D. Miller, P. Moore, S. Mountain, D.C. Palka, D. Ponganis, P. Rommel, S. Rowles, S. Taylor, B. Tyack, P. Wartzok, D. Gisiner, R. Mead, J. Benner. 2006. Understanding the Impacts of Anthropogenic Sound on Beaked Whales. *Journal of Cetacean Research and Management* 7(3):177–187.
- Denison, D.M., and G.L. Kooyman. 1973. The structure and function of the small airways in pinniped and sea otter lungs. *Respiration Physiology* 17:1–10.
- Elsner, R. 1965. Heart rate response in forced versus trained experimental dives in pinnipeds. In *Essays in Marine Physiology*, pp. 24–29. Oslo: Universitetsforlaget.
- Fahlman, A., S.K. Hooker, A. Olszowka, B.L. Bostrom, and D.R. Jones. 2009. Estimating the effect of lung collapse and pulmonary shunt on gas exchange during breath-hold diving: the Scholander and Kooyman legacy. *Respiratory Physiology and Neurobiology* 165:28–39.
- Fahlman, A. and S.R. Kayar. 2003. Probabilistic modeling for estimating gas kinetics and decompression sickness risk in pigs during H2 biochemical decompression. *Bulletin of Mathematical Biology* 65:747–806.
- Fahlman, A., A. Olszowka, B. Bostrom, and D.R. Jones. 2006. Deep diving mammals: Dive behavior and circulatory adjustments contribute to bends avoidance. *Respiration Physiology and Neurobiology* 153:66–77.
- Fahlman, A., A. Schmidt, D.R. Jones, B.L. Bostrom, and Y. Handrich. 2007. To what extent does  $N_2$  limit dive performance in king penguins? *Journal of Experimental Biology* 210:3344–3355.

- Fahlman, A., P. Tikuisis, J.F. Himm, P.K. Weathersby, and S.R. Kayar. 2001. On the likelihood of decompression sickness during H<sub>2</sub> biochemical decompression in pigs. *Journal of Applied Physiology* 91:2720–2729.
- Falke, K.J., R.D. Hill, J. Qvist, R.C. Schneider, M. Guppy, G.C. Liggins, P.W. Hochachka, R.E. Elliot, and W.M. Zapol. 1985. Seal lung collapse during free diving: evidence from arterial nitrogen tensions. *Science* 229:556–557.
- Flynn, E.T.J., and C.J. Lambertsen. 1971. Calibration of inert gas exchange in the mouse. In Lambertsen, C.J. (ed.) *Underwater Physiology*. Academic Press, New York, pp. 179–191.
- Froget, G., P.J. Butler, Y. Handrich, and A.J. Woakes. 2001. Heart rate as an indicator of oxygen consumption: influence of body condition in the king penguin. *Journal of Experimental Biology* 204:2133–2144.
- Hooker, S.K., and R.W. Baird. 1999. Deep-diving behaviour of the northern bottlenose whale, *Hyperoodon ampullatus* (Cetacea: Ziphiidae). *Proceedings of the Royal Society of London B* 266:671–676.
- Hooker, S.K., R.W. Baird, and A. Fahlman. 2009. Could beaked whales get the bends?: Effect of diving behavior and physiology on modelled gas exchange for three species: *Ziphius cavirostris*, *Mesoplodon densirostris* and *Hyperoodon ampullatus*. *Respiratory Physiology and Neurobiology*. In press. <http://dx.doi.org/10.1016/j.resp.2009.04.023>
- Jepson, P.D., M. Arbelo, R. Deaville, I.A.P. Patterson, P. Castro, J.R. Baker, E. Degollada, H.M. Ross, P. Herraes, A.M. Pocknell, Rodriguez, F. Howie, F.E. Espinosa, A. Reid, R.J. Jaber, J.R. Martin, V. Cunningham, A.A. Fernandez, A. 2003. Gas-bubble lesions in stranded cetaceans. *Nature* 425: 575–576.
- Kayar, S.R., E.O. Aukhert, M.J. Axley, L.D. Homer, and A.L. Harabin. 1997. Lower decompression sickness risk in rats by intravenous injection of foreign protein. *Undersea Hyperbaric Medicine* 24:329–335.
- Kooyman, G.L. 1973. Respiratory adaptations in marine mammals. *American Zoologist* 13:457–468.
- Kooyman, G.L., and W.B. Campbell. 1972. Heart rates in freely diving Weddell seals, *Leptonychotes weddelli*. *Comparative Journal of Biochemistry and Physiology* 43A:31–36.
- Kooyman, G.L., J.P. Schroeder, D.M. Denison, D.D. Hammond, J.J. Wright, and W.P. Bergman. 1972. Blood nitrogen tensions of seals during simulated deep dives. *American Journal of Physiology* 223:1016–1020.
- Kooyman, G.L., and E.E. Sinnett. 1982. Pulmonary shunts in harbor seals and sea lions during simulated dives to depth. *Physiological Zoology* 55:105–111.
- Leith, D.E. 1989. Adaptations to deep breath-hold diving: respiratory and circulatory mechanics. *Undersea Biomedical Research* 16:345–354.
- Ponganis, P.J., G.L. Kooyman, R. VanDam, and Y. Le Maho. 1999. Physiological responses of king penguins during simulated diving to 136 m depth. *Journal of Experimental Biology* 202:2819–2822.
- Ridgway, S.H. and R. Howard. 1979. Dolphin lung collapse and intramuscular circulation during free diving: evidence from nitrogen washout. *Science* 206:1182–1183.
- Ridgway, S.H., B.L. Scronce, and J. Kanwisher. 1969. Respiration and deep diving in the bottlenose porpoise. *Science* 166:1651–1654.
- Sato, K., J.B. Charrassin, C.A. Bost, and Y. Naito. 2004. Why do macaroni penguins choose shallow body angles that result in longer descent and ascent durations? *Journal of Experimental Biology* 207:4057–4065.
- Scholander, P.F. 1940. Experimental investigations on the respiratory function in diving mammals and birds. *Hvalrådets Skrifter* 22:1–131.
- Stephenson, R. 2005. A theoretical analysis of diving performance in the Weddell seal (*Leptonychotes weddelli*). *Physiological and Biochemical Zoology* 78:782–800.
- Tyack, P.L., M. Johnson, N.A. Soto, A. Sturlese, and P.T. Madsen. 2006. Extreme diving of beaked whales. *Journal of Experimental Biology* 209:4238–4253.
- Zimmer, W.M.X., and P.L. Tyack. 2007. Repetitive shallow dives pose decompression risk in deep-diving beaked whales. *Marine Mammal Science* 23:888–925.



# Does Diving Destroy the Brain?

*Stephen Daniels*

---

**ABSTRACT.** Inadequate decompression can cause acute neurological symptoms including speech, hearing and visual deficits, motor dysfunction, and paralysis. Similarly, exposure to high pressure, greater than 250 msw equivalent (2.5 MPa), also leads to a variety of central nervous system dysfunctions including sensory and cognitive impairment, epileptiform electrical discharges, and motor dysfunctions (tremor and convulsions). The severity and onset pressure of symptoms is related to both the magnitude of the pressure and the speed of compression. The appearance of these acute manifestations of neurological damage has sustained the impetus for a search for long-term neurological damage related to diving activity. The neurological symptoms related to decompression can easily be understood as arising through hypoxic mechanisms following intravascular bubble formation occluding cerebral blood vessels. The severity and precise neurological manifestations would then be related to the extent and location of the bubble formation. Long-term changes have been postulated to occur either as a result of irreversible acute damage or an accumulation of damage related to multiple, asymptomatic hypoxic events, in a manner similar to that associated, clinically, with Transient Ischaemic Attacks. Mechanism(s) that might lead to long-term neurological deficit arising as a result of exposure to pressure are more difficult to establish, largely because pressure-induced changes would be difficult to distinguish from decompression-induced changes. There is a theoretical possibility that pressure-induced potentiation of NMDA-sensitive glutamate receptor activity, which has been observed experimentally, might lead to cell death through calcium-induced excitotoxic mechanisms. However, it has not been established that long-term neurological deficits are caused by diving, through any mechanism. More light may be shed on this question by modern molecular imaging technologies, high-field magnetic resonance imaging (MRI) coupled with functional-MRI or positron emission tomography. Nevertheless, there is no clear evidence, to date, that diving, in the absence of serious acute damage, leads to long-term neurological dysfunction.

## INTRODUCTION

Inadequate decompression can cause acute neurological decompression sickness that may involve speech, hearing and visual deficits, motor dysfunction, and paralysis (Francis and Mitchell, 2003a; 2003b). Similarly, exposure to pressures greater than 2 MPa (200 msw equivalent) leads to acute High Pressure Neurological Syndrome (HPNS) dysfunctions, which include sensory and cognitive impairment, epileptiform electrical discharges, and motor dysfunctions (tremor and convulsions) (Bennett and Rostain, 2003). Since decompression and exposure to pressure can both cause significant acute neurological dysfunction the question has long been posed as to whether long-term effects may arise (Dutka, 2003). It is clear from a number of studies that serious, acute neurological decompression sickness, especially that involving paraplegias of spinal origin, often respond poorly to treatment and leave significant long-term sequelae. Cerebral dysfunction, in contrast, more often responds to treatment and as an isolated incident does not appear to have the same propensity

for long-term effects. However, with both spinal and cerebral effects multiple instances of damage are frequently associated with residual and long-term damage (Dutka, 2003). An important question is whether long-term neurological deficits accrue in the absence of acute decompression sickness, neurological or other.

The question as to whether exposure to pressure is able to cause long-term neurological deficits is much more difficult to resolve. All exposures to raised ambient pressure will at some point involve decompression back to atmospheric pressure. Furthermore, since practical decompression will always involve some degree of bubble formation it will be extremely difficult to resolve whether any residual central nervous system dysfunction arose from the exposure to pressure or the subsequent decompression.

To attempt an answer to the questions as to whether decompression, in the absence of acute decompression sickness, or exposure to pressure *per se* may lead to long-term neurological dysfunction, first the mechanisms via which such damage may occur and second the epidemiological evidence for damage will be considered.

## MECHANISMS FOR LONG-TERM CNS DYSFUNCTION

### NEUROLOGICAL DECOMPRESSION SICKNESS

Decompression schedules that are acceptable in practice are invariably associated with some degree of bubble formation (Daniels, 1984; Daniels et al., 1989). In general, bubbles give rise to pathophysiological effects either indirectly, through activation of biochemical pathways, directly as a result of hypoxic mechanisms (because blood vessel blockage gives rise to areas of ischaemic tissue) or through direct mechanical stimulation, particularly of nerve pathways (Francis and Mitchell, 2003a). The biochemical pathways stimulated are largely pro-inflammatory (Francis and Mitchell, 2003a) and as such may exacerbate, prolong, and intensify pain sensations from direct mechanical stimulation of nerve fibres via release of mediators of nociceptive neurotransmission such as bradykinin, 5-hydroxytryptamine, prostaglandins and nerve growth factors. However, it is the activation of hypoxic mechanisms (Fig. 1) that have the potential to cause permanent loss of neurons, with an associated accumulation of neurological deficit.

It is an interesting feature of neurological decompression sickness that it is most commonly the spinal cord that is affected rather than the brain. This is in contrast to other embolic causes of central nervous system injury (e.g., cardiac surgical patients) where it is overwhelmingly the brain that is injured, not the spinal cord (Francis and Mitchell, 2003a). Furthermore, pathologically the damage seen in spinal decompression sickness comprises punctate white matter (myelinated nerve fibres) haemorrhages and necrosis whereas ischaemia is associated with grey matter (nerve cell bodies) damage. A number of hypotheses

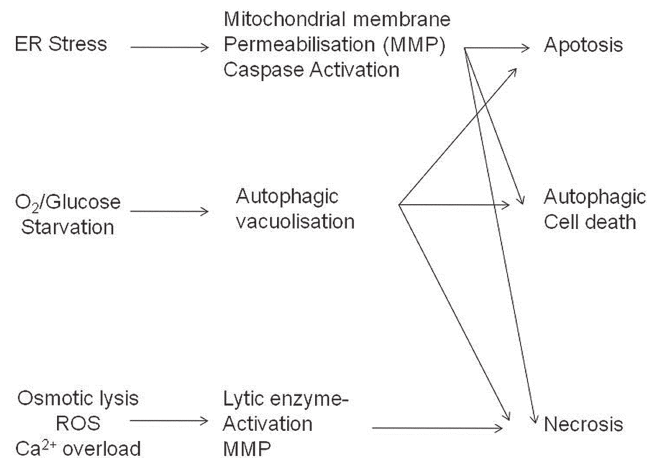

**FIGURE 1. Pathophysiology of bubbles.** The biochemical processes that may be activated by *in vivo* bubbles acting either directly or indirectly and that may lead to cell death. Any one stress induced through bubble-induced processes may lead to cell death from any of the three fundamental mechanisms: apoptosis, autophagic, or necrotic cell death. (Adapted from Galluzzi et al., 2007)

have been proposed to account for these findings. First there is the embolic-ischaemic hypothesis which appears to be an acceptable explanation for arterial gas embolism but bubble formation in arterial blood is extremely unlikely and, therefore, emboli would have to appear in the arterial circulation following passage through a patent foramen ovale or through pulmonary shunting. Although both mechanisms are known to occur, they are relatively rare and are normally thought most significant with severe decompression stress, usually associated with accidental or emergency decompressions (Francis and Mitchell, 2003a). Non-gaseous emboli, arising from vascular agglutination or coagulation initiated via biochemical cascades induced by bubbles, do occur but since recompression therapy is normally effective at relieving symptoms they would seem to be an unlikely direct cause of much damage. However, such emboli may well contribute to areas of ischaemia and to the initiation of hypoxic mechanisms outlined in Figure 1. Such mechanisms may underlie those cases of neurological decompression sickness that are unresponsive to recompression therapy. Finally, the autochthonous bubble hypothesis has been proposed that links central nervous system damage to extravascular bubble formation within the white matter, which is rich in lipid and with a low vascularisation and, therefore, would be an ideal tissue for bubble formation. Such bubbles might cause permanent neuronal loss through axonal destruction, which leads to cell death, or alternatively, stimulate biochemical processes that lead to necrosis.

Although the above mechanisms have usually been invoked to explain the acute symptoms of neurological decompression sickness, it is clear that by linking bubble formation to hypoxia, either directly or indirectly, these mechanisms may lead to permanent neuronal cell death that may be acutely asymptomatic.



However, since neurons are not readily regenerated, accumulation of such damage over time may lead to a long-term neurological deficit.

### EPIDEMIOLOGY

A variety of studies, in the main cross-sectional epidemiological studies, have been conducted in an attempt to identify a link between diving and long-term health consequences, particularly neurological deficits. Six such studies are summarised in Table 1 where the number of divers, their experience, the essential methodology, and main findings are summarised. The methodologies range from use of magnetic resonance imaging (MRI) in relatively small numbers of subjects, looking specifically for evidence of diving related white matter lesions, to health-related quality of life questionnaires issued to much larger groups with comparisons made either to population's norms or to matched controls.

The earliest study of Knauth et al. (1997) revealed white matter lesions in 11 out of a group of 87 recreational divers, each with a minimum of 160 dives experience. Seven of the affected divers showed no evidence of left-to-right cardiac shunt and only showed a few lesions. In contrast, 4 of the 11 divers had evidence of left-to-right cardiac shunt and exhibited multiple lesions. However, a further 21 divers, who also showed evidence of left-to-right cardiac shunt, had no detectable lesions. Although suggesting a case for neuronal damage in the absence of symptoms and evidence that left-to-right cardiac shunting may pre-dispose towards neurological damage, these results should be interpreted with caution. A cross-sectional study cannot identify cause and these changes may have arisen from non-diving related events. There are also no matched controls with a similar proportion of cardiac shunt for comparison.

Hutzelmann et al. (2000) examined 59 experienced, elderly but healthy divers and compared their MRI scans to those of

48 matched controls. They used both T1 and T2 weighted images and fluid-attenuated, inversion-recovery weighting, which is particularly suitable for revealing cerebral lesions. They found no difference in the distribution of lesions between the divers and the controls.

Slosman et al. (2004) examined 215 healthy recreational divers measuring global cerebral blood flow (CBF), using <sup>133</sup>Xe single photon emission computed tomography (SPECT), a battery of psychometric and neuropsychological tests, and evaluating diving activity by questionnaire. Their conclusions were that diving may have long-term effects on cognitive function when carried out in cold water, with more than 100 dives per year, and to depths below 40 m.

Taylor et al. (2006) studied the neuropsychological test performance of 102 divers with a complaint of "forgetfulness or loss of concentration," 100 non-forgetful divers, and 100 non-forgetful non-divers. Verbal memory, current intelligence, and sustained attention were worse for the divers with a complaint than for the non-forgetful divers or the non-forgetful non-divers. Tests of memory but not of executive function were different for the divers with complaints compared to the two control groups. In particular, mixed-gas bounce diving and surface-oxygen decompression diving, but not other techniques, were associated with memory deficit. However, their overall conclusion was that the relationships between diving experience and neuropsychological test performance were small and associated only with diving techniques used in the offshore oil and gas industry.

Irgens et al. (2007) investigated by questionnaire the impact of decompression sickness and diving exposure on health-related quality of life (HRQoL) in 375 Norwegian North Sea divers registered before 1990. They recorded demographic data, relevant health data and data on diving education, history of decompression sickness, and Medical Outcomes Study Short-Form General Health Survey (SF-36; Ware et al., 1994) in 230

**TABLE 1. Outcome from six cross-sectional epidemiological studies investigating possible long-term neurological sequelae from decompression. SCUBA: self-contained underwater breathing apparatus; MRI: magnetic resonance imaging; PFO: patent foramen ovale; DCS: decompression sickness; T1, T2 & FLAIR: alternative means of weighting an MRI image to reveal structural details; Fluid Attenuated Inversion Recovery is particularly useful for revealing brain and spinal cord lesions; CBF: cerebral blood flow; LTNE: long term neurological effects; NPT: neuropsychological test score; HRQoL: health-related quality of life score; LTNE: long-term health effect; PRO: professional diver; OSW: offshore worker.**

Divers/Control	Technique	Result	Reference
87 (SCUBA)	MRI & Doppler for PFO	White matter lesions in absence of DCS, more with PFO	Knauth et al., 1997
59 (experienced)/48 215 (SCUBA)	MRI: T1 & T2 & FLAIR Global-CBF and cognitive performance	No increase in white matter changes >40 m diving and cold water may predispose LTNE	Hutzelmann et al., 2000 Slosman et al., 2004
202/100	Case-controlled, neuropsychological tests	Weak correlation between NPT and diving; only in PRO divers	Taylor et al., 2006
375 (PRO)/Norwegian norms	HRQoL Questionnaire	Significant correlation between neurological DCS & reduced HRQoL	Irgens et al., 2007
2958 (PRO)/2708 (OSW)	Postal questionnaire	No evidence for LTNE	Ross et al., 2007

divers. They concluded that HRQoL was reduced in these divers (compared to Norwegian norms), having had decompression sickness contributed significantly to a reduction in all SF-36 scales, with neurological decompression sickness having the greatest impact, and cumulative diving exposure contributed to a reduced HRQoL.

In contrast to the study of Irgens et al. (2007), Ross et al. (2007) found no evidence to suggest any major impact of diving on long-term health of UK divers who started their career before 1991. They sent a questionnaire that addressed lifestyle, occupation and health status to 2,958 male professional divers, registered with the UK Health and Safety Executive before 1991, and to 2,708 non-diving men who had worked in the offshore oil industry in 1990–1992. It is possible that the study of Irgens et al. (2007) was influenced by the highly publicised campaign for the Norwegian government to award compensation for work-related illness to all Norwegian North Sea professional divers. There may be associations between HRQoL and diving activity but these studies cannot prove a causal relationship.

In summary, the evidence that diving causes long-term neurological damage is very weak. In order to pursue this, a longitudinal study would afford the best hope of establishing cause and effect. However, given the very low incidence of decompression sickness amongst professional divers in the North Sea these days (one or two cases per year), it is unlikely that such a study would be successful.

#### HIGH PRESSURE NEUROLOGICAL SYNDROME

The central nervous system excitability associated with exposure to elevated pressures (above 2.5 MPa) is not related to epilepsy, despite the many similarities in the outward expression of symptoms, nor is it an expression of a failure in the motor control originating in the basal ganglia, *cf* Parkinson's Disease. At a molecular level pressure selectively affects two ionotropic neurotransmitter receptors, one that mediates fast inhibitory neurotransmission and the other that mediates fast excitatory neurotransmission. The sensitivity of postsynaptic glycine receptors is progressively decreased by increasing pressure. This would lead to a reduction in inhibitory control, most pronounced in the spinal cord, but expressed throughout the central nervous system. As an illustration that effects on a single post-synaptic receptor can have profound consequences, there is a hereditary disease, hyperreflexia, in which there is a point mutation in the glycine receptor giving rise to a reduction in its sensitivity to the neurotransmitter glycine, which is expressed clinically as an increase in excitability (Eulenburg et al., 2006). In addition, the sensitivity of specific Glu<sup>NMDA</sup> receptors, which mediate excitatory neurotransmission, is increased, leading to an increase in excitability. Interestingly, the specific Glu<sup>NMDA</sup> receptor affected is that composed of R1 and R2C subunits, which are localised to the cerebellum, a region of the brain known to be important for motor control (Daniels and Grossman, 2003).

In addition to the effects of pressure on the glycine and Glu<sup>NMDA</sup> receptors, pressure also selectively affects an ion channel species, N-type Ca<sup>2+</sup> channels that regulate calcium entry into cells, 5HT<sub>2C</sub> receptors that mediate anxiety, and the adenylyl cyclase activated intracellular signalling pathway. The regulation of calcium entry into excitable cells is of crucial importance to exocytosis, the process of neurotransmitter release, but also if too much calcium enters the cell and cannot be sequestered into intracellular organelles then excitotoxic mechanisms (see below) may be initiated that will lead to cell death. The 5HT<sub>2C</sub> receptors are inhibited by pressure which would be expected to induce a state of anxiety that may explain some of the neurological responses divers report at pressure (Heisler et al., 2007). The intracellular signalling pathway mediated by adenylyl cyclase is responsible for regulating the activity of protein kinase A, which in turn regulates the activity of many neuroactive proteins by phosphorylation (Ahn and Choe, 2009). Pressure increases the activity of this intracellular signalling pathway (Daniels and Grossman, 2003).

At the cellular level pressure depresses synaptic transmission via pre-synaptic mechanisms, which exacerbates the effect of a reduction in post-synaptic sensitivity. To some extent the depression in synaptic transmission is partially compensated by frequency-dependent facilitation of transmission. In general, under normal circumstances a balance between excitation and inhibition exists. Pressure appears to manifest its excitable action via complex effects at both molecular and cellular levels that disturb that balance.

#### EXCITOTOXICITY

The mechanisms described above go some way towards explaining the ability of pressure to cause acute hyperexcitability in the central nervous system. However, they do not provide a mechanism by which long-term neurological deficit could accumulate. The key to potential long-term effects lie in the increase in activity of the Glu<sup>NMDA</sup> receptor and the voltage sensitive N-type calcium channel that is brought about by exposure to pressure. The Glu<sup>NMDA</sup> receptor is permeable to Ca<sup>2+</sup>, as well as Na<sup>+</sup> and K<sup>+</sup>, and thus activation of these two species will cause an increase in intracellular Ca<sup>2+</sup>. Normally, intracellular calcium concentrations are kept extremely low (< nM) because Ca<sup>2+</sup> is actively taken up into intracellular organelles, particularly the endoplasmic reticulum, and stored. Calcium is released from these stores by the activation of inositol triphosphate receptors following post-synaptic metabotropic glutamate receptor activation and helps initiate neurotransmitter release by exocytosis. However, if the intracellular concentration of Ca<sup>2+</sup> exceeds the capacity of the storage system because of the action of pressure, then a positive reinforcement is initiated because Ca<sup>2+</sup> activates Transient Receptor Potential channels that are themselves permeable to Ca<sup>2+</sup> (Fig. 2). The high calcium concentration then leads to activation of neuronal nitric oxide synthase, the production of nitric oxide and peroxynitrite radicals that cause cell

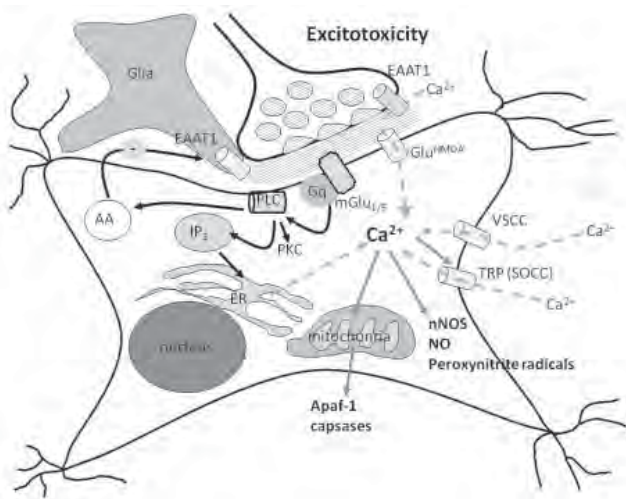

**FIGURE 2. Excitotoxicity.** Postulated mechanisms that may be induced by exposure to high pressure (> 2.5 MPa): Pressure induced stimulation of NMDA-sensitive ionotropic glutamate receptors ( $\text{Glu}^{\text{NMDA}}$ ) leads to excessive influx of  $\text{Ca}^{2+}$  into the post-synaptic cell. This is augmented by the pressure-induced stimulation of voltage-sensitive  $\text{Ca}^{2+}$  channels (VSCC), which, in turn, leads to the activation of  $\text{Ca}^{2+}$ -sensitive Transient Receptor Potential channels (TRP/SOCC Store Operated Calcium Channels), which produces a further increase in  $\text{Ca}^{2+}$  influx. In addition,  $\text{Ca}^{2+}$  is released from internal stores via activation of post-synaptic metabotropic glutamate receptors ( $\text{mGlu}_{1/5}$ ) that activate phospholipase C (PLC) leading to the production of inositol triphosphate ( $\text{IP}_3$ ), which acts on receptors on the endoplasmic reticulum (ER) to release  $\text{Ca}^{2+}$  from store. The excessive intracellular  $\text{Ca}^{2+}$  induces neuronal nitric oxide synthase (nNOS), leading to the production of nitric oxide (NO) and subsequently peroxynitrite radicals that cause necrotic cell death. Excessive intracellular  $\text{Ca}^{2+}$  also induces apoptotic peptidase activating factor 1 (Apaf-1) and caspases, which initiate apoptotic cell death. EAAT1: excitatory amino acid transporter 1; AA: arachadonic acid; PKC protein kinase C; Gq guanine nucleotide binding protein, class q.

death via necrotic mechanisms. In addition, calcium stimulates the release of caspases and apoptotic peptidase activating factor 1 which are responsible for initiating apoptotic cell death (Besancon et al., 2008).

Exposure to pressure is, therefore, capable of stimulating processes that may lead to cell death through both necrotic and apoptotic mechanisms. An accumulation of such damage over time and with repeated exposure to pressure might be sufficient to give rise to symptoms of neurological deficit. The question is whether there is any evidence for such effects.

#### EPIDEMIOLOGY

Aarli et al. (1985) investigated 23 professional divers before and after dives to 300 and 350 msw. Twelve divers were studied during pressure exposure with neurophysiological and neuropsychological tests. All twelve showed neurological impairment at pressure. Transient neurological changes appeared in 4 divers post exposure. More persistent changes were reported in

6 divers who had been exposed to 2 dives within 3 months. However, the difficulty in separating the effects of pressure from those of decompression remains.

#### THE FUTURE – MOLECULAR IMAGING?

As suggested above, the likelihood of longitudinal questionnaire and/or neuropsychological testing being able to resolve the question of long-term neurological deficit related to diving is low because the incidence of decompression sickness is so low. However, it is possible to envisage longitudinal studies that employ modern molecular imaging techniques (MRI, functional MRI (fMRI), Positron Emission Tomography (PET) and Single Photon Emission Computed Tomography (SPECT)) being used to probe changes in cerebral and spinal function during the course of a diving career. Indeed, it might be possible to separate the effects of decompression from those of pressure by comparing three groups: a group of divers who predominantly dive to depths greater than 250 m, a group of divers who do not dive to depths greater than 75 m, and a matched group of non-diving controls. It might be expected that pressure effects would appear mainly in the brain whereas those associated with decompression would appear in the spinal cord.

Magnetic resonance imaging has, until relatively recently, been used to examine anatomical features at very high resolution (< 1 mm) using a variety of image weighting techniques such as T1, T2 and fluid attenuation inversion recovery (FLAIR). More recently, fMRI techniques have been developed to probe function in addition to structure. In the context of potential hypoxic damage two techniques have shown great promise; blood-oxygen level dependent (BOLD) fMRI (Murata et al., 2006) and fluctuation-imaging using gradient-recalled echo-planar imaging (GRE-EPI) (Liu et al., 2007). The areas of lesion and the functional significance of the lesions can be revealed with great precision using either technique.

Positron Emission Tomography (PET) uses radiotracers that incorporate an atom that spontaneously decays by emitting a positron. When this positron annihilates on contact with an electron in the surrounding medium, two anti-parallel 511KeV gamma rays are emitted. It is the simultaneous detection of these anti-parallel gamma rays that forms the basis of PET imaging. Positron emitting isotopes include  $^{11}\text{C}$ ,  $^{15}\text{O}$  and  $^{18}\text{F}$ , which have half-lives of 20 min, 2 min and 110 min, respectively. These atoms are ones found commonly in biological molecules and therefore PET radiotracers can be made that closely resemble endogenous compounds or small molecular weight ligands that bind to endogenous compounds, such as neurotransmitter receptors or cellular transporter proteins. The function of the physiological processes probed by PET will, therefore, be minimally perturbed by these tracer molecules. As an example of the type of PET studies that can be applied to ischaemia, Nariai et al. (2003) looked at regional cerebral blood flow, using  $\text{H}_2\text{O}^{15}$ , before, during and after a period of ischaemia. They also looked post-ischaemia at the function of adenosine  $\text{A}_1$  receptors,



using the  $^{11}\text{C}$ -labelled  $A_1$  receptor antagonist [1-methyl- $^{11}\text{C}$ ] 8-dicyclopropyl-methyl-1-methyl-3-propylxanthine,  $\text{GABA}_A$  receptors, using the  $^{11}\text{C}$ -labelled benzodiazepine binding agent  $^{11}\text{C}$ -flumazenil, and cellular metabolic activity, using  $^{18}\text{F}$ -labelled  $^{18}\text{F}$ fluorodeoxyglucose. The advantage of PET over MRI is the sensitivity of detection of the tracers, with nM concentrations being sufficient for detection. The spatial resolution of PET imaging is much lower than that of MRI and so conventionally PET is combined with X-ray CT, and more recently MRI, which provides anatomical location for the detected PET activity.

Single photon emission computer tomography (SPECT) uses gamma-emitting isotopes such as  $^{99\text{m}}\text{Tc}$ ,  $^{111}\text{In}$  and  $^{123}\text{I}$  with half-lives of 6 hr, 2.805 day and 13.3 hr, respectively. Although the half-lives are considerable longer than those of PET isotopes  $^{99\text{m}}\text{Tc}$ , and  $^{111}\text{In}$  cannot be incorporated into conventional biological molecules, macromolecular complexes have been constructed using peptide nucleic acid sequences or antibodies to target the tracers at the physiological processes of interest (Heckl, 2007). SPECT with  $^{123}\text{I}$  incorporated into an amphetamine analogue has been used to study cardiovascular reactivity following ischaemic injury (Aso et al., 2009). Like PET, the spatial resolution of SPECT is relatively poor and increasingly it is being combined with X-ray CT or MRI to provide anatomical location. One potential advantage of SPECT over PET is that unlike PET where the gamma-ray energy is always 511 KeV, with SPECT the gamma-emitting isotopes can be distinguished on the basis of their energy. Thus, two (or more) isotopes could be imaged, simultaneously, to reveal multiple functional responses.

## CONCLUSION

At present there is no clear evidence that diving, in the absence of serious acute neurological decompression sickness, causes long-term neurological deficit. Cross-sectional population studies, whether questionnaire, neuropsychological or functional, cannot prove a causal relationship. Furthermore, since the operational incidence of decompression sickness in well-regulated diving activity is extremely low, it is unlikely that longitudinal studies based on questionnaire or neuropsychological tests can be successful either. To date it has not proved possible to separate the effects of pressure *per se* from those of decompression. However, it is possible that in the future, using appropriate molecular imaging techniques and well matched groups of deep (> 250 m) divers, shallow (< 75 m) divers and non-divers, functional longitudinal studies may be able to reveal whether repeated exposure to pressure and/or decompression causes neurological deficits beyond what would be expected from normal aging processes.

## LITERATURE CITED

Aarli, J.A., R. Vaernes, A.O. Brubakk, H. Nyland, H. Skeidsvoll, and S. Tønjum. 1985. Central nervous dysfunction associated with deep-sea diving. *Acta*

*Neurologica Scandinavica* 71(1):2–10.

- Ahn, S.M., and E.S. Choe. 2009. Activation of Group I Metabotropic Glutamate Receptors Increases Serine Phosphorylation of GluR1  $\alpha$ -Amino-3-Hydroxy-5-Methylisoxazole-4-Propionic Acid Receptors in the Rat Dorsal Striatum. *Journal of Pharmacology and Experimental Therapeutics* DOI:10.1124/jpet.108.149542.
- Aso, K., K. Ogasawara, M. Sasaki, M. Kobayashi, Y. Suga, K. Chida, Y. Ota- wara and A. Ogawa. 2009. Preoperative cerebrovascular reactivity to acetazolamide measured by brain perfusion SPECT predicts development of cerebral ischemic lesions caused by microemboli during carotid endarterectomy. *European Journal of Nuclear Medicine and Molecular Imaging* 36(2):294–301
- Bennett, P.B. and J.C. Rostain. 2003. High Pressure Nervous Syndrome. In *Bennett and Elliott's Physiology and Medicine of Diving*. Brubakk, A.O. and T.S. Neuman, eds. Pp. 323–358. Elsevier Science: Edinburgh, London, New York, Oxford, Philadelphia, St. Louis, Sydney, Toronto.
- Besancon, E., S. Guo1, J. Lok, M. Tymianski and E.H. Lo. 2008. Beyond NMDA and AMPA glutamate receptors: emerging mechanisms for ionic imbalance and cell death in stroke. *Trends in Pharmacological Sciences* 29(5):268–275.
- Daniels, S. 1984. Ultrasound monitoring of decompression procedures. *Philosophical Transactions of the Royal Society of London B* 304:153–175.
- Daniels, S., F. Bowser–Riley, and I.G. Vlachonikolis. 1989. The relationship between gas bubbles and decompression sickness. In *Gas supersaturation and bubble formation*. Brubakk, A.O., Hemmingsen, B.B. and G. Sundnes, eds. Pp. 387–416. Norway: Tapir.
- Daniels, S., and Y. Grossman. 2003. Biological effects of pressure. In *Bennett and Elliott's Physiology and Medicine of Diving*. Brubakk, A.O. and T.S. Neuman, eds. Pp. 265–299. Elsevier Science: Edinburgh, London, New York, Oxford, Philadelphia, St. Louis, Sydney, Toronto.
- Dutka, A.J. 2003. Long term effects on the central nervous system. In *Bennett and Elliott's Physiology and Medicine of Diving*. Brubakk, A.O. and T.S. Neuman, eds. Pp. 680–699. Elsevier Science: Edinburgh, London, New York, Oxford, Philadelphia, St. Louis, Sydney, Toronto.
- Eulenburg, V., K. Becker, J. Gomeza, B. Schmitt, C.M. Becker, and H. Betz. 2006. Mutations within the human *GLYT2* (*SLC6A5*) gene associated with hyperplexia. *Biochemical and Biophysical Research Communications* 348:400–405.
- Francis, T.J.R. and S.J. Mitchell. 2003a. Pathophysiology of decompression sickness. In: *Bennett and Elliott's Physiology and Medicine of Diving*. Brubakk, A.O. and T.S. Neuman, eds. Pp. 530–556. Elsevier Science: Edinburgh, London, New York, Oxford, Philadelphia, St. Louis, Sydney, Toronto.
- . 2003b. Manifestations of Decompression Disorders. In: *Bennett and Elliott's Physiology and Medicine of Diving*. Brubakk, A.O. and T.S. Neuman, eds. Pp. 578–599. Elsevier Science: Edinburgh, London, New York, Oxford, Philadelphia, St. Louis, Sydney, Toronto.
- Galluzzi, L., M.C. Maiuri, I. Vitale, H. Zischka, M. Castedo, L. Zitvogel, and G. Kroemer. 2007. *Cell Death and Differentiation* 14:1237–1266.
- Heckl, S. 2007. Future contrast agents for molecular imaging in stroke. *Current Medicinal Chemistry* 14:1713–1728.
- Heisler, L.K., L. Zhou, P. Bajwa, J. Hsu and L.H. Tecott. 2007. Serotonin 5-HT<sub>2C</sub> receptors regulate anxiety-like. *Behaviour Genes, Brain and Behavior*, 6:491–496.
- Hutzelmann, A., K. Tetzlaff, M. Reuter, S. Müller-Hülsbeck, and M. Heller. 2000. Does diving damage the brain? MR control study of divers' central nervous system. *Acta Radiologica* 41:18–21.
- Irgens, A., M. Grønning, K. Troland, E. Sundal, H. Nyland, and E. Thorsen. 2007. Reduced health-related quality of life in former North Sea divers is associated with decompression sickness. *Occupational Medicine* 57:349–354.
- Knauth, M., S. Ries, S. Pohimann, T. Kerby, M. Forsting, M. Daffertshofer, M. Hennerici, and K. Sartor. 1997. Cohort study of multiple brain lesions in sport divers: role of a patent foramen ovale. *British Medical Journal* 314:701–705.
- Liu, Y., H. D'Arceuil, J. He, M. Duggan, G. Gonzalez, J. Pryor and A. de

- Crespigny. 2007. MRI of Spontaneous Fluctuations after Acute Cerebral Ischemia in Nonhuman Primates. *Journal of Magnetic Resonance Imaging* 26:1112–1116.
- Murata, Y., K. Sakatani, T. Hoshino, N. Fujiwara, T. Kano, S. Nakamura, and Y. Katayama. Effects of Cerebral Ischemia on Evoked Cerebral Blood Oxygenation Responses and BOLD Contrast Functional MRI in Stroke Patients. *Stroke* 37:2514–2520.
- Nariai, T., Y. Shimada, K. Ishiwata, T. Nagaoka, J. Shimada, T. Kuroiwa, K.I. Ono, K. Ohno, K. Hirakawa, and M. Senda. 2003. PET Imaging of Adenosine A<sub>1</sub> Receptors with <sup>11</sup>C-MPDX as an Indicator of Severe Cerebral Ischemic Insult. *Journal of Nuclear Medicine* 44:1839–1844.
- Ross, J.A.S., J.I. Macdiarmid, L.M. Osman, S.J. Watt, D.J. Godden, and A. Lawson. 2007. Health status of professional divers and offshore oil industry workers. *Occupational Medicine* 57:254–261.
- Slosman, D.O., S. de Ribaupierre, C. Chicherio, C. Ludwig, M.L. Montandon, M. Allaoua, L. Genton, C. Pichard, A. Grousset, E. Mayer, J.M. Annoni, and A. de Ribaupierre. 2004. Negative neurofunctional effects of frequency, depth and environment in recreational scuba diving: the Geneva “memory dive” study. *British Journal of Sports Medicine* 38:108–114.
- Taylor, C.L., J.I. Macdiarmid, J.A.S. Ross, L.M. Osman, S.J. Watt, W. Adie, J.R. Crawford, and A. Lawson. 2006. Objective neuropsychological test performance of professional divers reporting a subjective complaint of “forgetfulness or loss of concentration. *Scandinavian Journal of Work, Environment, and Health* 32(4):310–317.
- Ware, J.J., K. Snow and M. Kosinski. 1994. SF-36 Health Survey: Manual and Interpretation Guide. The Health Institute, New England Medical Center: Boston, Mass.





# Effects of Diving on the Lung

*Einar Thorsen*

---

**ABSTRACT.** Hyperoxia and decompression stress with formation of free gas have well-known effects on the lung. Other factors associated with diving are pollutants of the breathing gas mixture, the diving habitat, or the water of chemical, bacteriological or even radioactive nature. Hyperoxia, decompression stress as evaluated by the formation of free gas, submersion, and breathing resistance have all been shown to have acute and sub-acute effects on the lung. In analyses of long-term term effects of diving over an entire career, the inclusion of different factors or estimates of cumulative hyperoxic and hyperbaric exposure and decompression stress in the models can result in significant effects being missed or, if there is any effect, it may be ascribed to a factor that is associated with the causal factor and not to the causal factor itself. Five independent cross-sectional studies have confirmed the finding of a reduction in small airways conductance and its relation to diving and exposure to hyperoxia. Several studies of the effects of single dives have shown changes in lung function immediately after a dive. At least for the effect of hyperoxia, a longitudinal follow-up for three years has demonstrated a persisting residual effect on lung function.

## DIVING EXPOSURE

The diving exposure is multifactorial with several exposure factors known to have effects on the lung, the central nervous system (CNS), and the musculo-skeletal system (MSS). Some effects are a physiological adaptation to the environment, but some effects are harmful and mediated by inflammatory responses causing diving-related disease and having a potential for long-term residual effects.

The basic physical components of the diving exposure are pressure, time, and gas mixture. The cumulative hyperoxic exposure is a function of the partial pressure of oxygen of the gas mixture and time. The decompression stress is a function of the partial pressure of the inert gases of the gas mixture, time, and the first derivative of pressure with respect to time. Hyperoxia and decompression stress with formation of free gas have well-known effects on the lung and on the CNS and MSS causing decompression sickness and dysbaric osteonecrosis. In some way any diving-related exposure factor will be related to these three basic physical components.

There are also other factors associated with diving such as pollutants of the breathing gas mixture, the diving habitat, or the water of chemical, bacteriological or even radioactive nature.

The components of the diving exposure can be easily monitored and controlled in experimental diving and the effects of each component can be studied when controlling for the others. In that way hyperoxia, decompression stress as evaluated by the formation of free gas, submersion, and breathing resistance have all been shown to have acute and sub-acute effects on the lung.

When it comes to long-term effects of diving, assessment of cumulative diving exposure over a diving career of many years is much more difficult. All necessary information

is expected to be in the divers' professional logbooks. However, the log-books are not easily retrievable and recreational diving is usually not registered. Even in the prospective longitudinal follow-up studies of apprentice divers' log-book data were retrievable in only about 25% of the divers (Skogstad et al., 2002).

In the study of UK divers (HSE, 2004) the quality of questionnaire data was compared with logbook data in the fraction of subjects having a complete log. There was good agreement concerning the number of years of professional diving and the number of days in saturation, but less agreement concerning the number of air and mixed-gas bounce dives. The recall bias can be considerable and the estimate of number of dives and diving-related events may be influenced by the purpose of the study, the selection criteria for inclusion in the study, cultural, and geographical factors. However, by having an estimate of the number of dives, this number includes a measure of the cumulative exposure to diving because the exposure factors in some way are related to time.

In analyses of long-term term effects of diving, the inclusion of different factors or estimates of cumulative hyperoxic and hyperbaric exposure and decompression stress in the models introduces a problem of co linearity between the exposure factors derived from the basic physical factors. The result can be that significant effects are missed or, if there is any effect, it may be ascribed to a factor that is associated with the causal factor and not to the causal factor itself. For epidemiological studies however, it may be sufficient to relate any effects to cumulative diving exposure and leave the causal relationships to studies of experimental dives.

## EFFECTS ON THE LUNG

At the international consensus conference on long-term effects of diving at Godøysund in 1993 three studies were presented showing a reduction in small airways conductance in divers that was related to cumulative diving exposure (Hope, 1994). The three studies had been conducted independently of each other in the United Kingdom, in the former Soviet Republic, and in Norway. A later German study (Tetzlaff et al., 1998) and more recently an Israeli study (Adir et al., 2005) have confirmed the finding of a reduction in small airways conductance and its relation to diving and exposure to hyperoxia. All these studies were cross-sectional in their design.

Prospective longitudinal follow-up studies were initiated in Norway after the Godøysund conference. A cohort of

apprentice divers was followed up for six years from the start of their professional diving career at the basic training course at the Norwegian Professional Diving School in Oslo (Skogstad et al., 2002). More than 80% of the subjects completed the 6-year follow-up examination and the results confirmed the findings of the cross-sectional studies. A group of apprentice policemen followed up for six years served as control.

Several studies of the effects of single dives, including deep and shallow saturation dives and shallow, air bounce dives, have shown that exposure to hyperoxia and decompression stress as evaluated by the incidence of venous gas microembolisms, contribute to changes in lung function immediately after a dive. At least for the effect of hyperoxia, a longitudinal follow-up for three years has demonstrated a persisting residual effect on lung function (Thorsen and Kambestad, 1995).

## CONCLUSION

The above-mentioned effects have been demonstrated in active divers. Whether the effects persist into retirement is still not resolved. In the Haukeland University Hospital Study the prevalence of spirometric airway obstruction in retired divers was significantly higher than in the general population, but in the study of UK divers there was no difference between the divers and a control group of offshore workers (HSE, 2004). A higher prevalence means that a larger fraction of the population has, or is at risk of, clinical chronic obstructive lung disease.

## LITERATURE CITED

- Adir, Y., A. Shupak, A. Laor, and D. Weiler-Ravell. 2005. Large lungs in divers: natural selection or a training effect? *Chest* 128:224–228.
- Health and Safety Executive. 2004. Coordinated investigation into the possible long-term health effects of diving. Research Report 230. Aberdeen: University of Aberdeen for the Health and Safety Executive.
- Hope, A., T. Lund, D.H. Elliott, M. Halsey, H. Wiig. 1994. Long-term health effects of diving. An international consensus conference. Godøysund 6-10 June, 1993. John Grieg forlag A/S, Bergen, pp. 387–391.
- Skogstad, M., E. Thorsen, T. Haldorsen, and H. Kjuus. 2002. Lung function over six years among professional divers. *Occupational and Environmental Medicine* 59:629–633.
- Tetzlaff, K., L. Friege, M. Reuter, J. Haber, T. Mutzbauer, and B. Neubauer. 1998. Expiratory flow limitation in compressed air divers and oxygen divers. *European Respiratory Journal* 12:895–899.
- Thorsen, E., and B.K. Kambestad. 1995. Persistent small-airways dysfunction after exposure to hyperoxia. *Journal of Applied Physiology* 78(4):1421–1424.

# The Limits of Breath-Hold Diving

*Peter Lindholm*

---

**ABSTRACT.** The limits of breath-hold diving are discussed regarding both duration and depth. For duration, the calculations presented explain a possible, theoretical breath-hold duration (according to known physiology) of 10 minutes 24 seconds for comparison with the current world record of 10 minutes 12 seconds. One technique that makes the current record possible is glossopharyngeal insufflation, by which the diver may fill the lungs with an extra 3–4 liters of air, increasing oxygen stores. In terms of depth, the record has stretched from 30 m in 1949, to the current record of 214 m diving with “no limits”. The depth limit is not yet known (the diver surfaced from 214 m in full health) but various factors limiting deep diving are discussed. The compression of gas, according to Boyle’s Law, may cause a range of barotraumas associated with the descent, including problems with equalization of middle ear, pulmonary oedema and haemoptysis. The increase in partial pressure of nitrogen may cause nitrogen narcosis with a risk of the diver becoming incapacitated at depth, as well as gas supersaturation in tissues leading to decompression sickness on, or after, the ascent. While divers have reached depths of 113 m by physically swimming down and up, the “no limits” divers use assisted descent and ascent. To reduce problems with compression, pulmonary gas stores can be increased by glossopharyngeal insufflation, and sinuses may be filled with (sea) water as a means of equalization. For the elite divers, the amount of oxygen they can store seems to be the limit for duration, while the problems of compression and nitrogen partial pressure are the most likely limiting factors for depth.

## INTRODUCTION

Breath-hold diving has been utilized as a means of harvesting food from the sea floor for many years, with descriptions dating back for thousands of years (Nukada, 1965). One form of food harvesting is by spear fishing and the first official world record in deep diving on one breath was set (with spear in hand) by diving to 30 m in 1949 (although descriptions exist of deeper dives predating this event).

For many decades a few divers competed with each other setting deeper and deeper depths, registering them as world records in deep breath-hold diving. This “style” of diving was later characterized as “no limits” i.e., the diver can use a weight to descend faster and a lift bag to ascend faster. Some examples of the most recognized deep divers are Enzo Maiorca (first to 50 m), Jacques Mayol (first to 100 m) and Umberto Pelizzari (first to 150 m). The current no-limits record is 214m (Fig. 1) that was recently set by Herbert Nitsch (who was also the first diver to reach 200 m). During the last decade, the sport has evolved to the point where athletes can compete in different forms of deep diving apart from the no-limits dives; current disciplines for competition include swimming down and up with or without fins, swimming as far as possible in a pool while holding one’s breath, and floating motionless in a pool, again for as long as possible on one breath. Two of the disciplines, “no limits” and “variable weight” are usually held as special events organized for individual record attempts rather than competitions. The Association Internationale pour le Développement de l’Apnée (AIDA) is the current governing body that

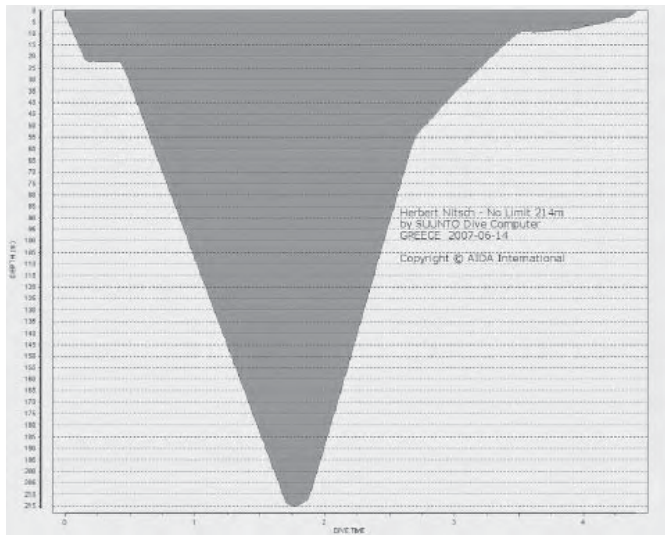

**FIGURE 1. Herbert Nitsch's 214 m record "no limits" dive (with permission from AIDA international).**

verifies records and organizes international competitions ([www.aida-international.org](http://www.aida-international.org)).

What are the limits of breath holding? The world records give an indication of the limits that may be achieved by select (perhaps genetically predisposed) individuals who devote themselves to extensive training in order to push their physiological boundaries. From the physiologist's point of view, two important limits can be distinguished: the first is the limit set by the onset of unconsciousness from the gradually developing hypoxia during breath holding (Lindholm, 2007; Lindholm and Lundgren, 2006). The other is the voluntary breakpoint of a breath hold in a subject. The breakpoint is highly variable due to motivation, tolerance and conditions (for example hyperventilation, exercise, rest) (Lindholm and Lundgren, 2009). There is a large discrepancy between the limit of consciousness and the voluntary breakpoint, which may vary from the edge of unconsciousness to a breath-hold duration of a few seconds where changes in gas stores can hardly be detected in arterial blood. This factor should be considered when evaluating the literature on breath-hold diving, as many studies have focused on voluntary breath holding without concurrent measurements of end-tidal or arterial gas partial pressures.

It is possible to hold one's breath until unconsciousness, even though most individuals would not do so voluntarily and most would only reach this limit under duress, for example, in a drowning scenario. The point of unconsciousness is considerably easier to accomplish with prior hyperventilation and exercise during the breath hold, as evidenced by deaths in swimming pools (Craig, 1961). When diving at great depth, the changes in pressure further aggravate the risk of unconsciousness during ascent where the partial pressure of oxygen falls rapidly (ascent blackout) (Lindholm, 2007; Lindholm and Lundgren, 2009). The current "limits" of breath-hold diving in the form of world records are listed in table 1.

## DIVE DURATION

How is a dive duration of ten minutes and twelve seconds possible? Can it be explained by current physiological knowledge? For elite competitors, the limit of their breath hold is loss of consciousness (LOC) or loss of motor control (LMC), i.e., severe hypoxia. We can calculate the oxygen stores at the start of the breath hold and divide them by the metabolism to come up with a reasonable suggestion for the maximum duration approachable by man (Lindholm, 2002; Lindholm and Lundgren, 2006).

If we assume that the limit for LMC is  $\text{PaO}_2 < 3\text{-}3.5 \text{ kPa}$  (20-21 mmHg) (Lindholm and Lundgren, 2006), that  $\text{SaO}_2 < 50\%$  (~40% depending on duration and  $\text{PCO}_2$ ), and that  $\text{SvO}_2$  would be 10-30% in different compartments, then what would the starting oxygen stores be?

Consider a male diver of 70 kg body weight, with a low basal metabolic rate equivalent to that during sleep of 240 ml  $\text{O}_2$ /min (Greger and Bleich, 1996). His residual volume is two liters, vital capacity eight liters, and he has the ability to insufflate another three liters by glossopharyngeal insufflation. Hyperventilating prior to the dive will reduce  $\text{PaCO}_2$  to < 3 kPa (20 mmHg), and increase  $\text{PaO}_2$  to 18-19 kPa (135 mmHg) ( $\text{PaO}_2$  98% to 99%), with a  $\text{PvO}_2$  increase ~ from 75% to circa 85-88%. This would give a total oxygen store that can be used for breath holding of:

- Desaturation of arterial blood  $100 - 40 = 60$
- Desaturation of venous blood  $88 - (10 \cdot 1/3 + 30 \cdot 2/3) = 88 - 70/3 = 88 - 23 = 65$
- Usable Blood stores:  $((0.25 \cdot 60) + (0.75 \cdot 65)) / 100 \cdot 70 \cdot 0.08 \cdot 1.36 = 884 \text{ ml O}_2$
- Usable Lung stores:  $13 \cdot 0.8259 \cdot (135 - 21) / 760 = 1610 \text{ ml O}_2$

Total usable oxygen stores: 2494 ml  $\text{O}_2$ . 2494 ml / 240 ml/min = 10 minutes and 24 seconds.

It is possible that the duration of breath holding can be improved further, partly by the selection of genetically gifted individuals with, for example, large lungs; the ability to insufflate large amounts of extra air and still hold their breath without increasing metabolism; large blood volume; and, a high hemoglobin concentration. Other means to extend breath-hold duration would be to consume less oxygen, i.e., reduce the metabolism during breath holding or extend the limit of consciousness by increasing tolerance to hypoxia.

## DISTANCE

When aiming to swim as far as possible on one breath, the limiting factors are oxygen stores, the efficiency of the swimming technique and also the individual's anaerobic capacity (i.e., the muscles' ability to produce energy without consuming oxygen during the breath hold). The distance will also depend on technology such as swim suits that reduce drag, and the



**TABLE 1. World records (December 2008).**

<b>DURATION</b>	
<b>Static Apnea (STA)</b>	
10 min 12 sec: Tom Sietas	8 min 0 sec: Natalia Molchanova
<b>DISTANCE</b>	
<b>Dynamic without Fins (DNF)</b>	
213m: Tom Sietas/ Dave Mullins	151 m: Kathryn McPhee
<b>Dynamic with Fins (DYN)</b>	
250m: Alexey Molchanov	214 m: Natalia Molchanova
<b>DEPTH</b>	
<b>Constant Weight without Fins (CNF)</b>	
86m: William Trubridge	60m: Natalia Molchanova
<b>Constant Weight (CWT)</b>	
113m: Guillaume Néry	95m: Natalia Molchanova
<b>Free Immersion (FIM)</b>	
108m: William Trubridge	85m: Natalia Molchanova
<b>DEPTH with assistance not competitive disciplines</b>	
<b>Variable Weight (VWT)</b>	
140m: Carlos Coste	122m: Tanya Streeter
<b>No Limit (NLT)</b>	
214m: Herbert Nitsch	160m: Tanya Streeter

material and shape of the fin(s) when used.

## DIVE DEPTH

### HOW DEEP CAN MAN GO AND WHAT ARE THE LIMITS?

During a deep dive, there is of course the limit of duration, i.e., the diver has to maintain consciousness until he/she can resume breathing at the surface. The duration of the breath hold will be affected by various degrees of exercise dependent on the technique of descending to depth. The technique can vary between swimming with legs (constant weight), legs and arms (constant weight no fins) and pulling oneself with the arms along a rope (free immersion). Even the assisted disciplines require exercise in comparison to a static breath-hold. In addition, the changing gas pressures may affect metabolism and the distribution of gas stores during a dive.

Divers reach greater depths each year. As noted above, the limit of deep diving by means of swimming will most likely be limited by duration and exercise capacity, but it may also be affected by the individual's ability to tolerate pressure at depth. Apart from the effects of changing pressure on gas stores, the effect of pressure on buoyancy (gas compression makes the diver heaviest at depth) makes the exercise effort expended when depth diving different from a distance swim in a pool. Currently

the limit for depth in the assisted category “no limit” is unknown, as the deepest dive made was successful and people may yet go deeper. While there are no reports of serious illnesses or mortality in any competitive events, the assisted categories have claimed both lives and caused decompression illness. The “no limits” fatalities reported have been due to technical malfunction and entanglement at depth leaving the diver at depth for too long. The extreme environment will put the diver at risk of barotrauma of descent, decompression illness, decompression sickness, nitrogen narcosis, and barotrauma of ascent.

### BAROTRAUMA OF DESCENT

When a breath-hold diver descends deeper and deeper, the gas in the body will be compressed according to Boyle's law. This means that the rigid spaces such as the sinuses and the middle ear will require additional gas for equalization. Normally this is achieved using air from the lungs. At some depths, the diver will have descended to a point where the residual gas volume in the lungs equals this diver's residual volume (Schaefer et al., 1968). What happens then if the descent is continued?

Primarily, one needs to account for the shift of blood into the thorax, which is due to immersion but further enhanced by compression. This effect will lower the residual volume of the lungs at depth in comparison to a measurement made on dry land (Craig, 1968; Schaefer et al., 1968). The rigid air spaces will require gas, and the technical air space created by a facemask can be countered by not using a mask, but lenses or fluid-filled goggles with special lenses enabling enough vision for guidance. Other divers counter this problem by filling the sinuses prior to diving (Germonpré et al., 2008) or during the actual dive by letting seawater passively flood sinuses and the middle ear (pers. comm. with Martin Stepanek and Kirk Krack).

Secondly, if the diver descends beyond the point of compression of the residual volume, what will then happen? When gas is compressed, atelectasis, i.e., collapse of parts of the lungs, may occur. Another possibility is that the high pressure difference over the pulmonary capillaries could cause fluid filtration into the interstitial space and then into the alveoli (Lindholm et al., 2008). This would result in pulmonary oedema, which may be aggravated by pulmonary hemorrhage, where erythrocytes leak into either the alveoli or the airways (Boussuges et al., 1999).

### BAROTRAUMA OF ASCENT

There are reports of divers surfacing from single deep dives with neurological symptoms, thereafter being treated with recompression in a hyperbaric chamber (McCrory et al. 2004; Thorsen et al., 2007). This is most likely due to decompression sickness (see below) but there is another speculation: compression of the lungs, in combination with a blood shift to the thorax could possibly cause air to be trapped; upon ascent the same air could rapidly expand resulting in pulmonary barotrauma and arterial gas embolism. Another factor that could aggravate

this condition is the ability of some divers to use glossopharyngeal insufflation to overfill their lungs with 3–4 liters of air prior to diving (Lindholm and Nyrén, 2005; Loring et al., 2007). The high pressure, together with a shift of perhaps a liter of blood into the thorax, could cause a relative overfilling of the lungs with air during the ascent unless the diver exhales during the last 5–10 meters to the surface.

### DECOMPRESSION SICKNESS

Calculations based on Haldanean decompression theory show that repetitive breath-hold diving may cause supersaturation of tissues and put the breath-hold diver at risk of decompression sickness (Thorsen et al., 2007). In the case of a single deep dive, this would also be the case if gas exchange remains unaffected by compression of the lung gas stores. It is possible that compression will limit nitrogen uptake from the lung at depth, but to what extent gas exchange is affected during such a dive is not known and outside the scope of this paper.

### NITROGEN NARCOSIS

The diving depths reached by breath-hold divers would incapacitate a scuba diver breathing air. The absence of reports of nitrogen narcosis may be due to the short duration at depth, as well as the repetitive nature of the dive training, i.e., the diver descends and returns according to a procedure repeated numerous times during training to gradually deeper and deeper depths imbuing an element of acclimatization to functioning during narcosis. There is one published account of nitrogen narcosis during a dive to 160 m (Streeter, 2006). The dynamics of gas exchange would give the diver the highest  $PN_2$  in the nervous system during the early parts of ascent. Nitrogen narcosis is also known to cause amnesia which may complicate the description of such events. As noted above, the extent that nitrogen uptake is affected by lung compression during deep breath-hold diving is not known, but it seems plausible that nitrogen narcosis as well as decompression sickness may be limited by collapse of gas exchange areas in the lungs at great depths.

The current world record dive to 214 m included a 30 second long “decompression stop” or slow ascent during the last 10 m, included in the 4 min 24 seconds of total dive duration. It is possible that the slow ascent reduces the risk of DCS (the ascent speed equals 3–4 m/s during the deeper parts of the ascent to be compared with the recommended 10 m/min during regular scuba diving). The slow ascent could also give time for blood and gas redistribution in the lungs, reducing the theoretical risk of barotrauma on ascent.

### CONCLUSION

It is possible for (some) humans to hold their breath for more than 10 minutes or to dive to more than 200 m. These durations and depths can be explained: the compression of gas in

the body requires that the diver has an elastic chest (muscles and ribcage) and a trachea and lungs that can collapse to a residual volume of less than 0.5 liters. Special lenses in fluid-filled goggles can be used instead of a mask to reduce the non-collapsible air spaces and glossopharyngeal insufflation may be used to increase pulmonary gas stores to over 12 liters. Water equalization of the sinuses and middle ear, while painful, is a useful adjunct. Pulmonary oedema and partial lung collapse (atelectases) will likely occur. Whether a decompression stop is needed or effective to reduce the risk of decompression sickness is not known. Currently, the limits of deep breath-hold diving seem to be pulmonary barotrauma of descent causing pulmonary oedema and the effects of nitrogen: nitrogen narcosis incapacitating the diver at depth or causing decompression sickness on ascent.

### LITERATURE CITED

- Boussuges, A., C. Pinet, P. Thomas, E. Bergmann, J.M. Sainty, and D. Vervloet. 1999. Haemoptysis after breath-hold diving. *European Respiratory Journal* 13:697–699.
- Craig, A.B., Jr. 1961. Causes of loss of consciousness during underwater swimming. *Journal of Applied Physiology* 16:583–586.
- . 1968. Depth limits of breath hold diving (an example of Fennology). *Respiratory Physiology* 5:14–22.
- Germonpré, P., C. Balestra, and P. Musimu. 2008. Passive flooding of paranasal sinuses and middle ears as a method of equalization in extreme breath-hold diving. *British Journal of Sports Medicine* doi:10.1136/bjsm.2007.043679.
- Greger, R., and M. Bleich. 1996. Normal Values for Physiological Parameters. In Greger, R., and U. Windhorst (eds.) *Comprehensive Human Physiology*. Berlin, Heidelberg, New York: Springer. p. 2427–2449.
- Lindholm, P. 2002. Severe hypoxemia during apnea in humans: influence of cardiovascular responses. Karolinska Institutet.
- . 2007. Loss of motor control and/or loss of consciousness during breath-hold competitions. *International Journal of Sports Medicine* 28:295–299.
- Lindholm, P., A. Ekborn, D. Öberg, and M. Gennser. 2008. Pulmonary edema and hemoptysis after breath-hold diving at residual volume. *Journal of Applied Physiology* 104:912–917.
- Lindholm, P., and C.E. Lundgren. 2006. Alveolar gas composition before and after maximal breath-holds in competitive divers. *Journal of Undersea and Hyperbaric Medicine* 33(6):463–467.
- . 2009. The physiology and pathophysiology of human breath-hold diving. *Journal of Applied Physiology* 106:284–292.
- Lindholm, P., and S. Nyrén. 2005. Studies on inspiratory and expiratory glossopharyngeal breathing in breath-hold divers employing magnetic resonance imaging and spirometry. *European Journal of Applied Physiology* 94(5/6):646–651.
- Loring, S.H., C.R. O'Donnell, J.P. Butler, P. Lindholm, F. Jacobson, and M. Ferrigno. 2007. Transpulmonary pressures and lung mechanics with glossopharyngeal insufflation and exsufflation beyond normal lung volumes in competitive breath-hold divers. *Journal of Applied Physiology* 102:841–846.
- McCrorry, P., E. Matser, R. Cantu, and M. Ferrigno. 2004. Sports neurology. *Lancet Neurology* 3:435–440.
- Nukada, M. 1965. Historical development of the ama's diving activities. In Rahn, H. (ed.) *Physiology of Breath-Hold Diving and the Ama of Japan*. Washington, DC: National Academy of Sciences, National Research Council. p. 25–40.
- Schaefer, K.E., R.D. Allison, J.H. Dougherty, Jr., C.R. Carey, R. Walker, F. Yost, and D. Parker. 1968. Pulmonary and circulatory adjustments determining the limits of depths in breathhold diving. *Science* 162:1020–1023.
- Streeter, T. 2006. Nitrogen narcosis during no limits freediving world record to 160 m (525 ft). In Lindholm, P., N. Pollock, and C.E.G. Lundgren

(eds.) *Breath-hold diving: Proceedings of the Undersea and Hyperbaric Medical Society/Divers Alert Network Workshop*, Divers Alert Network, Durham, North Carolina p. 17–25.

Thorsen, H.C., G. Zubieta-Calleja, and P.E. Paulev. 2007. Decompression sickness following seawater hunting using underwater scooters. *Research in Sports Medicine* 15:225–239.



# Parameters of Extreme Environment Diving

*Michael A. Lang*

---

**ABSTRACT.** The 2007-2009 International Polar Year (IPY) is a global research effort to better understand the polar regions and their climatic effect on the Earth. IPYs in 1882-1883, 1932-1933, and the International Geophysical Year of 1957-1958 were the precursors to this 4th IPY, the first to use extensive scientific diving techniques for polar underwater research. The science completed above and below the ice during IPY will provide a baseline for understanding future environmental change. Our research methodologies must also advance in the next 50 years, requiring some new approaches to diving physiology, equipment and procedures. Polar diving is one of the more extreme-environment diving modes where parameters such as thermal protection, cold stress as DCS risk, and regulator function require special consideration. Contaminated water diving is another extreme environment of microbiological and chemical nature that requires contaminant and risk assessment. Three illustrative cases review extreme environment diving parameters: the past (Smithsonian Tropical Research Institute Oil Spill Project), present (U.S. Antarctic Program benthic pollution studies), and future (Smithsonian Environmental Research Center Invasive Species Project). A final extreme environment is diving at depth. An advanced scientific diving workshop recently examined diving modes and operational parameters of open-circuit mixed gas scuba, closed-circuit rebreathers, underwater habitats, saturation systems, surface-supplied, and bell diving.

## INTRODUCTION

The commonality between poles and tropics is their shared remoteness, removed from the thoughts of society that sponsors our diving research. Additionally, the global economic downturn engenders an “extreme” research fund-raising environment.

This 4th International Polar Year (IPY) 2007-2009 is a global research effort to better understand the polar regions and their climatic effect on the Earth. The research completed during IPY will provide a baseline for understanding future environmental change. Previous IPYs were held in 1882-1883 and 1932-1933, and the International Geophysical Year in 1957-1958. A “Vision for International Polar Year 2007-2009” was published by the National Academy of Sciences’ Polar Research Board.

As the first major IPY scientific symposium, “Smithsonian at the Poles” was convened May 3-4, 2007 at the Smithsonian Institution. Highlights included the National Museum of Natural History’s U.S. Antarctic Meteorite Program, U.S. Antarctic Program Invertebrate Collection, and Arctic Cultural Studies; the Office of the Under Secretary for Science’s U.S. Antarctic Program Scientific Diving Program; the Smithsonian Environmental Research Center’s Antarctic Photobiology and Polar Invasions Biology Programs; the National Zoological Park’s Weddell Seal Energetics Project; and, the Smithsonian Astrophysical Observatory’s South Pole Antarctic Submillimeter Telescope/Remote Observatory Program. A second Smithsonian IPY symposium was convened at the National Air and Space Museum, November 30-December 1, 2007: “*Making*



*Science Global: Reconsidering the Social and Intellectual Implications of the International Polar and Geophysical Years.*" The AT50 symposium, celebrating the 50th anniversary of the signing of the Antarctic Treaty will convene November 30-December 3, 2009 at the Smithsonian National Museum of Natural History.

Polar environmental factors that make these ecosystems unique are biological, geological, physical and sociological in nature. Studies of Arctic-Antarctic marine faunal comparisons and adaptations are receiving much interest. Research on carbon dioxide levels, temperatures, greenhouse gases, and climate change centers on the polar regions because of their global importance. Human impacts and their ethical and economic considerations are integral to the conservation efforts of these pristine ecosystems. Ocean circulation and heat release, sea level rise and the extent of sea ice cover are topics that currently receive much attention due to their direct impacts on the climatic effects on where human populations reside.

Scuba diving conducted by scientists places the trained scientific eye under water and provides research value and flexibility that unmanned systems often do not. Scientific diving is a valuable research tool that has become an integral methodology in the pursuit of scientific questions in extreme environments in polar regions, in contaminated waters, and at depth.

## EXTREME ENVIRONMENTS: POLAR DIVING

The purpose of the project using scientific diving is the advancement of science. The tasks of a scientific diver are those of an observer and data gatherer. Scientific divers, based on the nature of their activities, must use scientific expertise in studying the underwater environment, and, therefore are scientists, or scientists-in-training.

The establishment of the first scientific diving safety program occurred at Scripps Institution of Oceanography in 1951 with a two-fold purpose: a) a research support function that assists the diving scientist with specialized underwater equipment, advice, and diver support, and b) a risk management function that protects the safety and health of the individual scientist, and the employing organization from excessive liability exposure. The following risk parameters are generally accepted for scientific diving in extreme environments (adapted from Lowrance, 1976). The ultimate responsibility for safety rests with the individual diver. Safety is the judgment of acceptability of risk. Risk is a compound measure of probability and severity of harm to human health. There are degrees of risk, therefore, degrees of safety. Estimating risk is a scientific event (an objective and probabilistic pursuit) and accepting risk is a political activity (a personal or social judgment). Nothing is absolutely free of risk.

The International Polar Diving Workshop (Lang and Sayer, 2007) was convened March 15-21, 2007 at the Arctic Marine Laboratory in Ny-Ålesund, Svalbard, resulting in recommendations on ice-diving equipment, cold water decompression, and

scientific ice diving operational procedures. The U.S. ice diving experience is derived mainly from the National Science Foundation's U.S. Antarctic Program Scientific Diving Program (Lang and Robbins, 2007) whose activities since 1989 have averaged annually 700 ice dives, 30 scientific divers, 41-minute dive times and depths shallower than 40 m.

## THERMAL PROTECTION

The shell drysuit is conceptually like a rain coat, it keeps the diver dry and the undergarments provide warmth. The level of insulation (unaffected by depth) can be adjusted for different diving requirements and individual needs. The primary means of passive thermal protection is by trapping and stabilizing a low conductivity gas. The active heating options that exist are not a replacement for a highly effective passive system for remote polar scientific diving operations because an infinite energy source is not available on site that can deliver between 250-1000 W to the diver. Free-flooding hot water suits require an infinite power source and, in general, water is not an optimal medium to work with in - 40°C polar environments. Electrically heated and liquid-heat transport garments also require energy sources that are difficult to provide in extreme diving environments. A good compromise may be the hybrid system, a high-efficiency passive system with supplemental heating of hands and feet. The drysuit is configured to accept power penetrations and attached gloves without wrist seals. Highly efficient passive insulation, e.g., Thinsulate, incorporates the wiring harness. Electrically heated glove and sock liners (50 W system with ground-fault interrupter, screening and temperature control) are powered by a compact Lithium battery.

Inadequate thermal protection in extreme environments leads to progressive safety concerns including the distraction effect of cold, loss of dexterity, loss of cognitive functions, non-freezing cold injuries, and ultimately life-threatening hypothermia. Moreover, respiratory heat loss is approximately 10% of the diver's metabolic rate, influenced by atmospheric composition, temperature, water vapor content, and ambient pressure. Further heat loss comes from warming the gas and the addition of water vapor. The inability to complete underwater and post-dive tasks impacts upon scientific productivity. Stinton (2006) considered matrix (undergarment) composition and selection for polar diving, including low conductivity under hydrostatic loads of 35 to 210 cmH<sub>2</sub>O (0.5 to 3.0 psi), effectiveness when wet (hydrophobic characteristics) or immersed (flooded), conformity to the diver's body, low conductivity to bulk ratio, materials, and construction costs. The diver's hands and feet are the factors limiting exposure time and efficiency in passive systems. Circulation to the hands can be improved by attaching ZipGloves™ by DUI, Inc. without a wrist seal to the drysuit. Medical examination gloves worn under insulation create a vapor barrier that keeps moisture out of the insulative matrix. Vapor barrier socks worn on the feet perform the same function. The use of a gas interlayer to warm the hands by occasionally

positioning them high inflates the gloves and reduces the hydrostatic pressure on the hands. Twice the amount of insulation covering the legs should be used for insulating the feet, without impairing their circulation, and avoiding the use of tight fins.

Air has been the traditional drysuit inflation gas. The use of Argon, with lower conductivity than air, as a suit inflation gas has become very common in the technical diving community. However, its value has been debated following tests done by Risberg and Hope (2001) whose results from skin and core temperature monitoring during dives did not show a significant difference between air and Argon. Weinberger (1989) reported a 19% improvement in suit insulation using CO<sub>2</sub>. Argon and CO<sub>2</sub> have conductivities that are comparatively close relative to air (Stinton, 2007). The difference in test results can possibly be explained by Risberg and Hope's utilization of a 6-mm foam neoprene drysuit with wooly bears with a large fraction of the total insulation coming from the foam neoprene. The addition of Argon into the drysuit would not change the intrinsic insulation of the foam and at 9 m of depth the foam still contributes a major portion of the total suit/system insulation. Weinberg used shell drysuits that had relatively little intrinsic insulation with the majority provided by the undergarments. Argon or possibly CO<sub>2</sub> are not a fix for a poor insulation package. They are a means to gain additional performance when there is no more room in the drysuit for additional thermal layers. The effect of CO<sub>2</sub> use in suits at deeper depths is not known.

Aerogel is perhaps the most promising matrix for future thermal insulation. It is silica-based and the world's lowest density solid (99.8% air, density 3 g/L, average particle size 2-5 nm). Current aerogel undergarment production challenges are its encapsulated construction to control silica dust and the 5-fold increased cost over traditional insulation materials.

### COLD STRESS AND DCS RISK

The effect of cold on DCS risk is not fully understood. However, the diver should be kept warm throughout the dive and during the immediate post-dive period external heat application and heavy lifting should be avoided (Mueller, 2007). Being only slightly cold may have the same effect on bubble grades as being severely hypothermic. Long-term health effects for divers with a high proportion of cold water dives should be considered in the future. The effect and timing of exercise has recently been studied with implications for cold water diving as a stress factor (Dujic et al., 2005, 2006; Gerriets et al., 2000; Jankowski et al., 2004; Mekjavic et al., 2003; Ruterbusch et al., 2004, 2005; Tetzlaff et al., 2001).

### REGULATORS

When scuba regulators are dived in very cold water, as under sea ice in polar regions, there is a chance that first or second stage regulators will malfunction due to the accumulation of ice in or around the regulator, yielding complete occlusion of air

flow, or massive free flow rapidly expending a diver's air supply (Clarke, 2007). Both conditions are referred to as regulator "freeze-up". Most operational freeze-up problems in scientific diving operations result in the second stage of regulators where divers' warm, moist exhalant breath induces ice crystal formation on the second stage air delivery valve. First stage regulator problems are minimal until there is enough ice build-up that mechanically interferes with the compression of an exposed spring. Most first stages used for ice diving are environmentally sealed (dry bleed or silicon sealed) or of a diaphragm versus piston type, negating the freeze-up problem. Once the freeze-up occurs, the air flow is shut off by closing one of the two redundant cylinder valves or sliding the isolation valve on the second stage shut, and the dive is aborted.

Factors influencing regulator freeze-up are design (determined by the manufacturer), quality control (individual regulator), depth (due to increased gas density), mass flow (depth and respiratory minute volume), time, and temperature. Configuration control is influenced by pressures of the market place, resulting in scuba regulator models typically experiencing a short half-life. Designing a regulator tolerant to freeze-up is a black art for most manufacturers without field testing sites. Even minor "cosmetic" model changes can affect freeze-up risk. The USAP scientific diving program initially used double-hose regulator until 1990. In 1991, single-hose Sherwood Maximus SRB3600 regulators were introduced to the program with the second stage modified with a heat retention plate and intermediate pressure lowered from 145 to 125 psi.

Full-face masks have been used successfully by the Norwegian Polar Institute (Hop and Pavlova, 2006) and the British Antarctic Survey. Sayer et al. (2006) describes operation and maintenance of full-face AGA masks with manual bail-out side valve connected to a rear-mount pony cylinder. Robbins (2006) cautions about the higher failure rate of full-face masks (AGA, Heliox 18, and Superlite 17 helmets) in the -1.86°C waters of McMurdo Sound, approximately 2°C colder than those of the Arctic, Antarctic Peninsula, and perennially ice-covered lakes of the Antarctic Dry Valleys.

## EXTREME ENVIRONMENTS: CONTAMINATED WATER DIVING

### SCIENTIFIC DIVING: RISK VERSUS SCIENCE BENEFIT

Minimization of risk to all team members is a priority consideration. Contaminated water is defined as water that contains any chemical, biological, or radioactive substance that poses a chronic or acute health risk to exposed personnel. The contaminants can be of the following nature: chemical (hydrocarbons, solvents, PCBs, heavy metals, tributyl-tin fluorides, pesticides, oxidants); biological (sewage, bacterial pathogens, viruses, protozoans, microorganism toxins); or, radiological.

Contamination assessment is generally performed by local

health offices, Environmental Protection Agency, or state agencies that can usually provide information on potential contaminants in local bodies of water or beaches. Bacterial contamination and other common contaminants are routinely tested for in any body of water in which people swim or drink from. Is the contaminant in the water column, in the sediment, or on the surface? Is the contaminant water soluble? Is the contaminant toxic on contact, on ingestion, on inhalation or by proximity? Are the potential effects acute, chronic or long term?

The identification of hazards should be based upon existing scientific evidence, which can show a cause and effect relationship between making dives in contaminated water and serious injury to the diver. The dose/response relationship would require that an objective decision be made as to the degree to which different contaminants cause an observed effect. This would normally involve a study of a population of scientific divers and its known response to various exposures. We need to know the likelihood of increased injury in the diving population that is produced by the hazard. The type of contaminants, length of exposure and equipment used are all part of the “dose” that must be evaluated. Risk is relative to a specific set of conditions. The analysis of potential public exposure will depend, in part, on the potential damage or benefits of the practice of contaminated water diving. It may also depend upon the effect of a variety of intervening variables such as physiological fitness, age, equipment, proper post-dive decontamination procedures and many others which may have an effect on susceptibility to contaminants. What is the specific nature of the calculated risk that divers must accept if they choose to dive in contaminated water? The description of the risk is then based upon the objective evaluation of the likelihood of the occurrence of undesirable side effects following a given “dose” of contaminated water diving exposure. Usually, risks of 1 in 1,000,000 are considered acceptable for virtually any risk. Risks at the level of 1 in 100,000 are minimal but the severity of the injury becomes an issue. Contaminated water diving risk assessment needs a review of the actual number of exposures or the accurate size of the population as well as the number and severity of the injuries to make a reasonable assignment of risk. Without the denominator the attempts at assigning risk are speculative.

## U.S. NAVY WATER QUALITY CATEGORIES

### *Category One*

Highest Contamination (Level A protection): Grossly contaminated with concentrated chemical or microbiological contamination. Examples include heavy fuel slicks and sewage operations. Divers should use full diving helmets with surface-supplied air and communications, vulcanized rubber suits with integrated helmet-mating collar and dry gloves with rings. The helmet should be equipped with the double exhaust-valve assembly design for use in contaminated water. The helmet must be used in the free-flow mode.

### *Category Two*

Moderate Contamination (Level B protection): Increased levels of both chemical and microbiological contamination are expected. Divers may use a positive pressure full-face mask and use it in the positive pressure mode. A block should be used for emergency gas switching to bail out gas in the advent of primary supply failure. A drysuit is required.

### *Category Three*

Baseline Contamination (Level C protection): No expectation of contamination above baseline that is normal for human habitation. This category represents what most dive teams and other research divers will face during the normal course of events. Divers should wear a positive pressure full-face mask to avoid water contact with mucous membranes and mouth (unless water analysis shows contact with the mouth is an acceptable risk) and thermal protection appropriate for the diving conditions.

### *Category Four*

No contamination (Level D protection): This includes situations where no contaminated sources are known or expected such as offshore oceanic locations or drinking water reservoirs, recreational swimming areas or areas where water quality is routinely checked and no contaminants are reported.

Potable water supplies or perennially ice-covered Antarctic lakes can have other challenges in a reverse mode. Special training and equipment is often needed to safeguard these bodies of water from diver- or equipment-introduced contaminants.

## CONTAMINATED WATER SCIENTIFIC DIVING PROCEDURES

Dive plan considerations for risk management purposes include consideration of the following: contaminant information; diver equipment suitability, monitoring, minimization of contact, method of decontamination, and emergency plan; tenders' handling and containment of contaminated items, method of decontamination, personal protection equipment, and emergency plan; decontamination and quarantine; and, drysuit permeability, tensile strength and penetration resistance, ease of donning and doffing, fit, thermal balance and heat stress (dehydration, body temperature, heart rate). Decontamination procedures are widely available from various sources, for example, the U.S. Navy, Diving Unlimited International, National Oceanic and Atmospheric Administration, Environmental Protection Agency, or Federal Emergency Management Administration.

Special circumstances include rainfall runoff (increased pollutants from farming; known point and nonpoint source polluters should be checked); sediments (many lakes and commercial harbors have sediments with significantly higher levels of contamination than the water column, e.g., polychlorinated biphenyls and heavy metals); and, hazardous materials (areas

with gross fuel contamination, e.g., leaking ships, storage tanks or aircraft recovery, or in areas with a high concentration of creosote-soaked wood or anti-fouling paint).

#### SELECT CONTAMINATED WATER DIVING EXAMPLES

##### *Case 1 - Past: Smithsonian Tropical Research Institute Oil Spill Project*

Marine environments are subject to man-made disasters. The escape of 100 000 barrels of oil into the mangroves and reefs of Bahia Las Minas (Caribbean) has had unexpectedly prolonged effects (Jackson et al, 1989). Oil seeps into the sediments around mangroves and returns to coat the coral reefs year after year as heavy rainfalls (exacerbated by the effects of deforestation) slowly wash it out. Injury, post-impact regeneration and growth of corals have been assessed by scientific divers at this oil spill site (Guzman et al, 1994). The skeletons of corals record the history of acute disasters as well as chronic stresses. X-ray analyses of corals done in response to the oil spill document a worrying decline in coral growth over the past century. Oil pollution, nutrient pollution and sedimentation due to excessive run-off from deforested areas are extreme coral stressors. Multiple stressors have a combinatorial effect on an otherwise resilient system, e.g., Galeta Point, Panama (Jackson, et al., 1989; Keller and Jackson, 1993; Guzman et al., 1994).

##### *Case 2 - Present: U.S. Antarctic Program (USAP) Benthic Pollution Studies*

Several benthic pollution studies were initiated in 1992 in the contaminated water of Winter Quarters Bay and around the McMurdo outfall (Conlan et al., 2004). Initial sampling was done by USAP commercial divers who were working at McMurdo Station. Scientific divers, anxious to see the study site and use the diving mode began diving with the commercial divers to complete the sampling requirements. All diving was done with program-supplied commercial diving equipment (Robbins, 2006). The two-day training program includes a minimum of two familiarization dives under direct supervision of the USAP Dive Supervisor. Hands-on briefings with the Scientific Diving Coordinator cover system set-up, introduction/familiarization with bandmask/helmet, out-of-air emergencies, tether management, line pull signals, free-flow procedures, equalization, defogging, decompression requirements, and tending the surface-supplied diver.

A three-person crew is the minimum personnel requirement for USAP surface-supplied diving. The positions include a supervisor/tender, a diver, and a suited standby diver. The standby diver can use either scuba or surface supply.

In addition to contaminated water operations, surface-supplied diving has found other niches in the USAP diving repertoire. Surface-supplied diving is now the exclusive mode used by USAP divers operating in the Dry Valley Lakes. Environmental

protocols mandate the use of solo divers to minimize disruption of lake haloclines. Safety concerns demand that solo divers using relatively unreliable band- or full-face masks be provided with a large supply of breathing gas. USAP experience with EXO-26 masks has been 11 free-flows in 106 dives (10.4% failure rate). AGA masks have had 2 free-flows in 26 dives (7.7% failure rate). These data come from dives in the Dry Valley Lakes where water temperatures range between 0°C and 2°C. It is assumed that failure rate would be even higher in -1.8°C water of McMurdo Sound. Specific failure rates for either the Heliox-18 or Superlite-17 helmets cannot be extracted from the USAP database, although it is felt to be similar to the full-face masks.

Surface-supplied diving is used when workloads demand higher respiration rates than can be supplied by scuba. Another current benthic pollution study requires coring in an area of frozen sediment. At other sites for this study, a large number of cores are required at 40 m. The ability to work fast, with inherently high respiration rates, results in a reduction of the number of dives required to complete this sampling.

Since 2001, 459 surface-supplied dives have been logged by 32 surface-supplied divers. The DUI TLS350 or RS1050 drysuits or Trelleborg Viking Pro or HD vulcanized rubber drysuits work better in extremely cold environments because they do not freeze in the air.

##### *Case 3 - Future: Smithsonian Environmental Research Center Invasive Species Project*

Established in 1997 pursuant to the National Invasive Species Act of 1996, the National Ballast Information Clearinghouse (NBIC) is a joint program of SERC and the U.S. Coast Guard that collects, analyzes, and interprets data on the ballast water management practices of commercial ships that operate in U.S. waters. The principal goals are to quantify the amounts and origins of ballast water discharged in U.S. coastal systems and to determine the degree to which such water has undergone open-ocean exchange or alternative treatments designed to reduce the likelihood of ballast-mediated invasions by exotic species.

The World Conservation Union (IUCN) established generally accepted distinct bioregions of the world. Organisms have been transferred among bioregion boundaries with economic damage and environmental impacts as a result. Hull fouling and ballast water act as invasive species vectors requiring sampling in select harbors and ports at locations such as Oakland-San Francisco Bay, Prince William Sound, Chesapeake Bay, and Tampa Bay by scientific divers, commercial divers and remotely operated vehicles (ROVs).

#### EXTREME ENVIRONMENTS: DEPTH

A majority of the marine ecosystem habitats of interest are located in waters of up to 130 m depth, which roughly corresponds to the continental shelf and the photic zone. The



Advanced Scientific Diving Workshop (Lang and Smith, 2006) examined the existing technologies (open-circuit mixed gas, closed- and semi-closed circuit rebreathers, habitats and fly-away saturation systems, bell diving, and surface-supplied mixed gas) with the goal of establishing a robust capability for government-agency sponsored (non-military) scientific divers to once again work at depths of up to 90 m through a phased approach. Safety concerns have gradually eroded this depth limit to what has become a 60 m operational compressed air window for scientific diving, as published by the Department of Labor Occupational Safety and Health Administration (OSHA) in 1982 and 1985 (29 CFR 1910). OSHA does not regulate the scientific diving community with regard to technology, which provides us with the operational flexibility to employ mixed gases in our research methodology to meet the Nation's marine science needs.

Reliable commercial diving technology exists to reach these depths, but is not routinely employed by the scientific community. Training a competent scientific diver in surface-supplied mixed gas diving, where the dive, gas mix, depths, bottom times, voice communication, and decompression are controlled from the surface would appear to be the simplest method of choice. The limitations of diving on a hose under these constraints do not seem to outweigh the advantages of immediate access to 90 m depth. The sparsely explored depths between 60 and 100 m are reflected in our incomplete knowledge of contributions of deep coral reefs to shallow-reef systems and the infrequent discovery of cryptic and deep-water species that are new to science.

Attempts at introducing rebreathers into mainstream scientific diving programs have met with inertia and significant safety concerns due to issues of reliability, availability, time investment in training, and proficiency requirements. The workshop focus was therefore not on rebreathers *per se*, as they have received much attention through numerous venues over the last 15 years and should continue to evolve on a parallel track. Rather, deliberations emphasized a scientific diving capability to conduct research between 60 and 90 m by evaluating a re-expansion of the scientific diving envelope through mixed gas and surface-supplied techniques.

#### ACKNOWLEDGMENTS

I wish to thank John Scott Haldane, Alf Brubakk of the Norwegian University of Science and Technology, the Smithsonian Office of the Under Secretary for Science, Bob Stinton and Dick Long of Diving Unlimited International, Inc., John Clarke of the U.S. Navy Experimental Diving Unit, Rob Robbins of Raytheon Polar Services, NEDU, the National Science Foundation Office of Polar Programs, and Martin Sayer of the NERC National Facility for Scientific Diving.

#### LITERATURE CITED

Clarke, J.R. 2007. Scuba regulators for use in cold water: the U.S. Navy perspective. In Lang, M.A. and M.D.J. Sayer (eds.) 2007. *Proceedings of the International Polar Diving Workshop*. Svalbard, March 15–21, 2007. Washington, DC: Smithsonian Institution, pp. 181–186.

- of the *International Polar Diving Workshop*. Svalbard, March 15–21, 2007. Washington, DC: Smithsonian Institution, pp. 35–44.
- Conlan, K.E., S.L. Kim, H.S. Lenihan, and J.S. Oliver. 2004. Benthic changes during 10 years of organic enrichment by McMurdo Station, Antarctica. *Marine Pollution Bulletin* 49:43–60.
- Dujic, Z., I. Palada, A. Obad, D. Duplancic, D. Bakovic, and Z. Valic. 2005. Exercise during a 3-min decompression stop reduces post-dive venous gas bubbles. *Medicine and Science in Sports and Exercise* 37(8):1319–1323.
- Dujic, Z., A. Obad, I. Palada, V. Ivancev and Z. Valic. 2006. Venous bubble count declines during strenuous exercise after an open sea dive to 30 m. *Aviation, Space, and Environmental Medicine* 77(6):592–596.
- Gerriets, T., K. Tetzlaff, T. Liceni, C. Schafer, B. Rosengarten, G. Kopske, C. Algermissen, N. Struck, and M. Kaps. 2000. Arteriovenous bubbles following cold water sport dives: relation to right-to-left shunting. *Neurology* 55(11):1741–1743.
- Guzman, H.M., K.A. Burns, and J.B.C. Jackson. 1994. Injury, regeneration and growth of Caribbean reef corals after a major oil spill in Panama. *Marine Ecology Progress Series* 105:231–241.
- Jackson, J.B.C., J.D. Cubit, B.C. Keller, V. Batista, K. Burns, H.M. Caffey, R.L. Caldwell, S.D. Garrity, C.D. Getter, C. Gonzalez, H.M. Guzman, K.W. Kaufmann, A.H. Knap, S.C. Levings, M.F. Marshal, R. Steger, R.C. Thompson, and E. Weil. 1989. Ecological effects of a major oil spill on Panamanian coastal marine communities. *Science* 243:37–44.
- Jankowski, L.W., P. Tikuisis, and R.Y. Nishi. 2004. Exercise effects during diving and decompression on postdive venous gas emboli. *Aviation Space and Environmental Medicine* 75(6):489–495.
- Hop, H. and O. Pavlova. 2006. Ice amphipods in drifting sea ice around Svalbard: quantitative collections by scuba divers. In Lang, M.A. and M.D.J. Sayer (eds.) 2007. *Proceedings of the International Polar Diving Workshop*. Svalbard, March 15–21, 2007. Washington, DC: Smithsonian Institution, pp. 181–186.
- Keller, B.D. and J.B.C. Jackson (eds.) 1993. Long-term assessment of the Oil Spill at Bahía Las Minas, Panama Synthesis Report. New Orleans: OCS Study MMS 93-0047. U.S. Department of the Interior, Minerals Management Service, Gulf of Mexico OCS Regional Office.
- Lang, M.A. and N.E. Smith (eds.) 2006. *Proceedings of the Advanced Scientific Diving Workshop*. Washington, DC: Smithsonian Institution.
- Lang, M.A. and M.D.J. Sayer (eds.) 2007. *Proceedings of the International Polar Diving Workshop*. Svalbard, March 15–21, 2007. Washington, DC: Smithsonian Institution.
- Lowrance, W.W. 1976. *Of Acceptable Risk: Science and the Determination of Safety*. Los Altos, California: W. Kaufmann.
- Lang, M.A. and R. Robbins. 2007. USAP Scientific Diving Program. In Lang, M.A. and M.D.J. Sayer (eds.) 2007. *Proceedings of the International Polar Diving Workshop*. Svalbard, March 15–21, 2007. Washington, DC: Smithsonian Institution. pp. 133–155.
- Mekjavic, I.B., M.J. Tipton, and O. Eiken. 2003. Thermal Considerations in Diving. In Brubakk, A.O. and T.S. Neuman, eds., *Bennett and Elliott's Physiology and Medicine of Diving*, 5<sup>th</sup> Edition. London: Elsevier Science Ltd.
- Mueller, P.H.J. 2007. Cold stress as DCS factor. In Lang, M.A. and M.D.J. Sayer (eds.) *Proceedings of the International Polar Diving Workshop*. Svalbard, March 15–21, 2007. Washington, DC: Smithsonian Institution. pp. 63–72.
- OSHA, U.S. Department of Labor. 1982. Commercial Diving Standards. 29 Code of Federal Regulations Ch. XVII Subpart T 1910.401 and Appendix B to Subpart T - Guidelines for Scientific Diving (1985), Washington, DC.
- Risberg, J. and A. Hope. 2001. Thermal insulation properties of argon used as a dry suit inflation gas. *Journal of Undersea and Hyperbaric Medicine* 28(3):137–143.
- Robbins, R. 2006. USAP surface-supplied diving. In Lang, M.A. and N.E. Smith (eds.) *Proceedings of the Advanced Scientific Diving Workshop*.



- Washington, DC: Smithsonian Institution. pp. 187–191.
- Ruterbusch, V.L., W.A. Gerth, and E.T. Long. 2004. Diver thermal status as a risk factor for decompression sickness (DCS). *Journal of Undersea and Hyperbaric Medicine* 31(3):95.
- Ruterbusch, V.L., W.A. Gerth, and E.T. Long. 2005. Benefits of warm decompression can be realized with hot water suits. *Journal of Undersea and Hyperbaric Medicine* 32(4):33.
- Sayer, M.D.J., K.P. Fraser, T.M. Shimmiel and J.P. Wilkinson. 2006. Under sea ice diving operations carried out by UK organizations in support of scientific research. In Lang, M.A. and M.D.J. Sayer (eds.) 2007. *Proceedings of the International Polar Diving Workshop*. Svalbard, March 15–21, 2007. Washington, DC: Smithsonian Institution. pp. 95–110.
- Stinton, R.T. 2007. A review of diver thermal protection strategies for polar diving: present and future. In Lang, M.A. and M.D.J. Sayer (eds). *Proceedings of the International Polar Diving Workshop*. Svalbard, March 15–21, 2007. Washington, DC: Smithsonian Institution. pp. 13–34.
- Tetzlaff, K., L. Friege, A. Koch, L. Heine, B. Neubauer, N. Struck, and T.S. Mutzbauer. 2001. Effects of ambient cold and depth on lung function in humans after a single scuba dive. *European Journal of Applied Physiology* 85(1–2):125–129.
- Weinberg, R.P. 1992. Alternate drysuit inflation gas for improved thermal insulation. In R. Nishi (ed.) *Proceedings of the DCIEM Diver Thermal Protection Workshop*. Toronto: DCIEM. pp. 41–43.



# Creativity and Improvisation As Phenomena and Acting Potential in Different Contexts

*Bjørn Alterhaug*

---

**ABSTRACT.** This paper focuses on creativity and improvisation; how these phenomena and acting strategies in real time seem to create optimal conditions for innovative activity. As such, they represent supplementary and alternative ways of acting, learning and organising in different contexts.

That's my way of preparation -  
to not be prepared. And that  
takes a lot of preparation!  
—Lee Konitz

## PRELUDE

At the Haldane Symposium, my colleague and jazz musician John Pål Inderberg and I were asked to play and give a talk on jazz improvisation. In 1908, J.S. Haldane and co-workers published their paper “The prevention of compressed-air-illness” that has formed the basis of modern decompression procedures. One century later it was time for a symposium in Trondheim, Norway, December 18-19, 2008. The title of our presentation was: “*Improvisation: Between Panic and Boredom*”. For us to talk to international researchers on diving seemed a little strange, what has jazz improvisation to do with diving?

However, reactions to our performance and presentation, which mainly consisted of jazz music sounding from a baritone sax and a double bass supplemented with comments, were very positive. At certain points it seemed that there might be links between these two seemingly rather separate areas, diving and improvisation. For example, blowing and breathing through a baritone sax has certain similarities with breathing through a diving apparatus. Kinra and Okasha (1999) published on the risk for health damage and illness due to exertion of blowing a jazz saxophone titled *Unsafe sax: cohort study of the impact of too much sax on the mortality of famous jazz musicians*. A depressing title for my fellow sax playing musician! Our hypothesis that improvisation has a constructive and fruitful acting potential on all kinds of human behavior was still encouraged by this thin thread between these areas.

Per request of the Symposium Convener, Alf O. Brubakk, to write about creativity and improvisation as part of the Haldane Symposium proceedings, I accepted to give a try to his request. Parts of this writing are based on my article: *Improvisation on a Triple Theme* (Alterhaug, 2004).

At the Symposium we started our presentation by playing a standard jazz tune, titled “Whisper Not” by Benny Golson. We then commented on how we, in the course of performance, created new melodies, rhythms and variants of harmonies on this tune's structure: the balance between structure and flexibility. Related to this explanation we

told the following story, which was told to us June 19, 2003 at a seminar in Trondheim arranged by Sintef Industrial Management, Safety and Reliability, where saxophonist John Pål Inderberg and I presented a paper.

A manager of the deep-sea diving section on a North Sea oil platform spoke about his experiences with training deep-sea divers in emergency situations. The managers tried to give the divers highly detailed and exact written instructions for how to react in dangerous situations. However, when the divers strictly followed the instructions in dangerous situations, they concentrated on the prescribed rules so much that they forgot to use their own imagination and creativity to solve this complex situation. The result was critically dangerous and they needed outside help to save their lives. The instructions were then reformulated to just a few fundamental points, which were easy to remember, and which gave a better balance between structure and flexibility. In other words, the divers were given the opportunity to improvise on internalised knowledge, trusting their inborn capacities. This meant that they could keep calm and did not panic; accordingly, they handled the most complex situation in an adequate way through improvising.

This short story brings to the fore the importance of creativity and improvisation as an important acting potential in real time situations. In the following text examples are presented and an argument made for a better understanding and significance of these Latin-derived words that are often interpreted in many ways, often far from their etymological meaning. Before approaching these words more in detail, I will briefly mention some personal experiences, which refer to a more or less confusing understanding of improvisation.

The word improvisation is generally used with a negative connotation: a kind of accidental acting without planning, which often leads to incomplete and bad solutions. In the musical contexts that jazz improvisation has, improvisation has often been characterised by the uninitiated as chaotic, without structure, meaningless. As a young jazz musician I was asked by an elder relative of mine during a concert: "Bjørn, couldn't your band please play a tune that you all know". The improvised melodies sounded that unfamiliar and strange to my relative, that he thought we just played occasional, strange melodies at the same time, which we were actually doing. But, these melody lines were interconnected through an underlying structure. A structure organised by a common-rhythm feel that gave the individual musician freedom, space and time to express himself in the collective, where the interactional conditions "on the spot" enhanced the creative and improvisational forces.

During many years as a jazz musician and academic I have met a lot of strange and confusing questions, especially on the meaning of the word "improvisation." Undoubtedly, there is need for some clarification. This paper aims to bring to light some aspects connected to the word and phenomenon improvisation in music and other contexts. I will also argue that insight and knowledge on creativity and improvisation might open up alternative ways of acting learning and organising.

## APPROACHING CREATIVITY AND IMPROVISATION

'Creativity' is derived from the Latin word *creare*, "to create", and as such it is closely related to improvisation. Even if these two words seem to represent the same meaning, and often are used by chance, there is a distinction that may be useful to figure out (Jørgensen, 2009). Creativity is a solution-oriented and innovative development process where there is an exchange between exploration, reflection and new exploration. The exploration part does not necessarily have to be of a practical kind, and might be a combination of practice and reconsiderations; a circular circuit of idea-acting consequence. Creativity is understood as a slow-floating improvisation, a process based on knowledge, proficiency and reflection over time. This creates the platform for the "in-the moment-innovation", what apparently happens in a "magical" way by creative persons.

Improvisation may be described as immediate action, where there is no time for reflections in the moment, yet action based on deep internalized knowledge, proficiency, and creativity. Improvisation is the creativity manifested in the moment's invention. In interactive acting situations, improvisation has to, in order to benefit a common goal, unfold in a proficient collective that shares the creative capacity; the members of the spirit of the community have to be on the same wavelength in order to interact-improvise together on the spot. Trust, security, tolerance, and humor are important keywords in this kind of interaction.

An example of positive effects due to creativity and improvisation is the U.S. Airways Captain and his crew who in January 2009 were forced to land an airplane on the Hudson River because of a bird strike that damaged the engines. This emergency situation was solved elegantly due to a high state of readiness, internalised skills, and practice. The pilot and the crew had been trained and prepared for different emergency situations, but likely not for this very special situation. However, all kinds of emergency actions and procedures had been rehearsed repeatedly in simulators and in other contexts. When this dangerous situation occurred, the crew was mentally and physically prepared; the procedures and necessary actions for this situation were performed automatically. Creativity and improvisation were coordinated on the spur of the moment, a superb combination for solving unexpected situations. There was obviously no time to look in the manual and find written procedures to solve this unexpected and dramatic situation, which was totally unforeseen. Is it possible to be prepared for the unexpected, the unforeseen, and if so, how? These will be the main questions to be considered. Improvisation - and jazz improvisation especially - will be used as a metaphor for a further exploration of this topic.

## MEANINGS AND ETYMOLOGY

The different usages of improvisation in daily speech often cause confusion when improvisation as a concept and

phenomenon is discussed. Among very different meanings, there seem to be two main meanings of the word: 1) Improvisation as emergency actions (e.g., the plans failed so I had to improvise"). This statement presupposes that human action is normally based on following rules and instructions; and, 2) Improvisation based on a high state of readiness, internalised skills and practice, a first-rate way of acting. This meaning is based on another important concept, tacitly knowing. During our adolescence, we develop a kind of readiness for "whatever may happen." This readiness is acquired mainly through direct involvement in various problem-solving situations, and this type of knowledge is mediated via bodily experiences and alert awareness. Readiness is crucial when acting in real-time turbulent and chaotic surroundings. In this paper improvisation is understood in accordance with the second meaning.

All human beings, whatever their background, have creative potential. It is therefore necessary to emphasize that creativity and improvisation are human features of a general character, which we may recognise as easily in a masterpiece as in everyday activities. Creativity has through history been of decisive importance for man's ability to survive, e.g., when inventing new tools and adopting new approaches and perspectives. Even though the word 'improvisation' was not used in a musical context until approximately 1850, improvisation has a long history. In antiquity, we find it as an important part of rhetoric training and in the field of music. In Western music history; we know that medieval music was mostly improvisational and that leading composers such as Bach, Mozart, Beethoven, and Chopin were great improvisers.

The Latin *improvisus* means "unforeseen" or "on the spur of the moment." The root of the word improvisation is the Latin word for "see." *Visus* is something which has been seen, while *pro* means before, in advance, etc. *Provisus* does not exist as a separate word in Latin, but it would have had the meaning "something which has been seen in advance." The prefix *im-* is negative, yielding the meaning "something which has not been seen in advance." From *improvisus*, which gradually got the meaning "unforeseen" or "unexpected", "surprising", Italian has formed a verb *improvisare*, to do something without preparation, solve an unexpected situation, and the noun improvisation is derived from this verb (Gunhild Vidén, pers. comm.).

## IMPROVISATION IN ANTIQUITY

Another Latin term was *extempore actio*, which originally meant "acting outside time" – outside the normal flow of time, which could be related to the term "experienced" time (Bergson, 1990). Other definitions of improvisation are discussed below. Ancient Greek and Roman performance culture was mainly oral, and we see parallels to many music cultures of today, e.g., folk music, jazz, and popular music. This ancient literacy was both a tool and basis for oral communication. In Athens, approximately 500 BC, there were annual organised recitals that lasted for

many days. The Greeks grew up with the epic poems such as the Iliad and the Odyssey. However, they did not read them, they listened to them. This is an illustration of the importance of the aural aspect and recitation/learning by heart as crucial elements of improvisation, irrespective of historical period.

Plato calls the art of poetry "the art which the ear can perceive", and uses the expression "hearing something from a book." The Roman Quintillian (35-100 AD) says the following about making a good speech: "to be free to improvise, you have to know the speech so well that you do not feel restricted by it" (Andersen, 1995).

Proficiency as an improviser in rhetoric contexts, according to the old sources, is due to two factors: natural predisposition and practice, i.e., talent and training. The former is regarded as the most important, but the ability to improvise is also a matter of practising and one can find a lot of explicit advice and instructions for the improviser concerning memory techniques and elements that influence the performance, including voice, face, body, ear and rhythm (Andersen, 1995). Even pressure to deliver and nervousness are treated in this connection. For instance, Crassus said: "... if not even the most proficient and relaxed speakers go to work with a certain anxiety and are moved by nervousness when they start to speak, well, then they are lost to all sense of shame." This focuses the very important role of emotion, state of mind, and mood in performance situations. From ancient times until today, we find improvisation in every known musical culture, even if there is a great variation in how it is handled in the different traditions.

## JAZZ AND "AFRICAN WAYS"

In the beginning of the 20th century, New Orleans became the center for the development of a new musical expression: jazz. Improvisation reappeared in this music in a way that proved to be of vital importance and influence for all kinds of music throughout the century. "Of all the musical forms to emerge during the twentieth century, jazz was by far the most significant" (Shipton, 2001). Jazz has a relatively short history. The first references to it come from the West Coast of America, where the *San Francisco Bulletin* of March 1913 used the term to describe a dance music full of vigor and "pep" (Shipton, 2001). A definition of this expression has since caused many discussions and even today there is no final conclusion, which should be looked upon as a healthy state and evidence for a vital cultural expression.

The *New Grove Dictionary of Jazz* definition is as follows: "A music created mainly by black Americans in the early 20th century through the amalgamation of elements drawn from European-American and tribal African music." This rather open definition recognises that... "on the whole, ethnicity provides a core, a centre of gravity for the narrative of jazz, and is one element that unites the several different kinds of narratives in use today" (DeVeaux, 1991).

With the emergence of jazz in the first part of the 20th century, improvisation gradually found its place on the musical



scene and in recent years seems to generate interest within different fields of research. Jazz has spread all over the world, and today we can describe jazz as global music. One of the main causes for this relatively fast dispersion is to be found in the African elements of jazz: African ways of behavior with respect to life and music are closely interwoven. The expression “African ways” should not be conceived as if the African is something unambiguous or homogenous. The African refers to heterogeneous practices, but fundamental to these ways of communicating is the inclusive, interactive, dialogic aspect; where the actor or musician is the message (Sidran, 1981). In the combination of singing, dancing and drumming there is a “celebration of life” which has many layers of tacit knowledge, experience, religion and joy. In every such performance and meeting it seems very important to bring forth personal, individual voices; inviting others to make their contribution and to be open to all directions and possibilities such dialogues and interactions may take. Behind these actions and activities, communities of practice full of joy and sorrow, there is a deep feeling of belonging to a collective of local identity where nature plays a decisive part.

This rather generalised description and essentialism need some remarks. In the postcolonial period, parts of Africa have been saddled with poverty and deep conflicts between tribes and regions, a gloomy fact that strongly contradicts my idealisation of African ways of acting. These human, political, social and global urgent and complex questions are part of this paper; however, these questions are not discussed here. The main focus of this paper is particular aspects of African ways of acting which I have experienced in different musical settings, e.g., in West African traditions and in the interplay with African-American jazz musicians, these aspects provide a valuable contribution to the discussion and discourses on interaction and communication in a global world.

## UBUNTU

In his book “No Future without Forgiveness”, the Reverend Desmond Tutu talks about a South-African term *ubuntu*, which means, “to be a human being.” All human relations that are imprinted of mutual respect, dignity, and community are terms or expressions for *ubuntu*. *Ubuntu-Botho* means “the art or virtue of being a human creature.” We are born to live in a subtle network of mutual dependence. “I am only a human being through another you.” We say “A person is a person through other persons.” It is not, “I think, therefore I am.” It says rather: “I am human because I belong. I participate, I share” (Tutu, 1999).

This view of the world or humanism represents a universal *ubuntu* that includes all people irrespective of race, sex, ethnicity, political, cultural and/or religious belonging. As the Reverend Tutu said: “We are all born different, like a rainbow. A rainbow is a rainbow just because the colours are different. The different colours come together, and then we get a rainbow.” The influence of “African ways” then seems to represent a potential for action that may be looked upon as “an alternative modernism”: celebration of the unpredictable, improvisational,

“unforeseen”, rooted in tradition and internalised knowledge and experience combined with training to act “on the spot.” The risk of a romanticisation of “African ways” is clearly present in such pompous pronouncements, but as an alternative to over 200 years of Western rationality, time has come to develop conceptual frameworks grounded on alternatives: interaction, emotions, social creativity and internalised, tacit knowledge, and Africa offers a rich source for such a framework.

## THE IMMOVABLE AND THE STATIC

The African-American art form jazz, jazz improvisation may be placed philosophically in a tradition that radically contradicts central parts of Western rationalist thinking: a static, mechanistic worldview rooted in the immovable world of Ideas of Plato. In this respect jazz may be linked to the thinking of the French philosopher Henri Bergson and the American pragmatists of the early 1900s. Flexibility and process are focused, life is considered as a stream of movements and changes, processes and tendencies that cross and intermingle, the complex. Consciousness and rationality are in this thinking constituted through creative action, often compared to an ecosystem.

The Norwegian ecophilosopher Sigmund Kvaløy Setreng has, with reference to Bergson’s process philosophy, developed a pedagogic model to elucidate the difference between European traditional system thinking and a philosophy grounded in process thinking. Setreng (2001) uses the concepts “complicated” and “complex”. The complicated may be compared with a machine based on reversibility, a closed system controlled from a center. The symphony orchestra’s hierarchical structure is used as a metaphor for this form of organising, the complicated. As a contrast, he uses the complex, which is open and irreversible self-organising grounded in interaction, comparable to an ecosystem. Here the jazz combo, a small group of two to six members, is used as an illustration of complexity. Of course one can also find hierarchical structures in strictly organised jazz big bands with 18-20 members and more. Setreng underlines that his models are simplified ideal types, used to illustrate a basic difference in organisational thinking, representative of two different cultures (Setreng, 2002). Setreng’s thinking seems to have parallels to Edgar Morin’s concept: self-eco-re-organisation, suggesting that the nature of the organisation changes as well and that it is an ongoing process of self-renewal that always happens in a context, in an environment, never in isolation or abstraction. No self without an eco. No text without context (Montuori, 2003).

## DIFFERENT PERSPECTIVES, OBJECTIVE TO SUBJECTIVE

Academic research on creativity during the 20th century has mainly concentrated on the individual, and it has often been based on a Western, modernistic understanding with emphasis on objectivity, rationality, order and theory. The traditional goals of Western universities have been on a theoretical

understanding of the world. “Practical” knowledge traditions, with their background in what people do in the world, have received little attention, as practice is regarded as less important than theoretical issues. Nearly all knowledge and searching for the truth is grounded in traditional systems thinking: logical-rational thinking expressed in a technical language.

The subjective, emotional, accidental and tacit knowledge have had almost no space within this hierarchic, hegemonic paradigm, which in a context of art often is grounded on a “genius-aesthetic” alien to most cultures outside the Western world. (See e.g., *Encyclopaedia of Psychology*, 2000, Vol. 2, p. 339... “The musical idea has to be written down and orchestrated...”). This way of conceiving the world is mainly rooted in the metaphysics of antiquity: inflexibility regarded as synonymous with absoluteness and perfection, a world view that has contributed to a static understanding of reality in which control and prediction, in human interrelationships too, have had the highest priority, expressed in quite simple, mechanistic models.

Within musicology one would expect that studies of ethnic music cultures should lead to new and extensive research on creativity, but research on this topic appears to be marginal. At the end of the last millennium, certain endeavours to do research within this field could be seen. However, it is remarkable that new, innovative research, based on impulses from, in this case jazz improvisation, occurs quite often within disciplines such as organisational theory, economy, business, social science and psychology, and now also diving, but only haphazardly within musicology.

## THE JAZZ METAPHOR

Berliner’s (1994) book, “Thinking in Jazz,” has been of vital importance for understanding the jazz culture and has inspired different writers to use jazz improvisation as a metaphor for knowledge, innovation, and creativity in organisational connections (Barrett, 2002; Hatch, 2002; Weick, 2002). However, when using the jazz metaphor, one has to be aware of the fact that jazz has changed through the years and that the metaphor has to be used carefully as the difference between for example Swing Jazz from the 1930s and Free Jazz from the 1960s is essential. However, in spite of differences, one element has been central through the whole jazz tradition, i.e., improvisation.

### WORDS, MYTHS, AND DEFINITIONS

Bailey (1980) stated:

The word *improvisation* is actually very little used by improvising musicians. Idiomatic improvisers, in describing what they do, use the name of the idiom. They “play flamenco” or “play jazz”; some refer to what they do as just “playing.” There is a noticeable reluctance to use the word and some improvisers express a positive dislike for it. I think this is due to its widely accepted connotations, which imply that improvisation is something without preparation

and without consideration, a completely ad hoc activity, frivolous and inconsequential, lacking in design and method. And they object to that implication because they know from their own experience that it is untrue. They know that there is no musical activity that requires greater skills and devotion, preparation, training and commitment. And so they resent the word, which in some places has become almost a term of abuse. They recognise that, as it is generally understood, it completely misrepresents the depth and complexity of their work. But I have chosen to retain that term throughout this book; firstly because I don’t know of any other which could effectively replace it, and secondly because I hope that we, the other contributors and myself, might be able to re-define it.

One of the most common myths concerning improvisation is the romantic one. The improvising jazz musician is the incarnation of God; improvisation is a supernatural phenomenon, a privileged gift of the chosen few. When we talk about improvisation on a high artistic level, it may be correct to speak of a special talent, which not all of us are in possession of. But there is one thing that both the specially gifted people and others that deal with jazz improvisation have in common: hard work, the long and demanding way to achieve an instrumental standard and personal strength that justifies the power of intuition.

There are various definitions of improvisation. Dictionaries give us such definitions as “a performance according to the inventive whim of the moment” or “to perform without preparation.” “Improvisation” is here confined to the first usage of the term mentioned at the beginning: improvisation seen almost as an inferior, second-hand solution. But the second mentioned usage, the one relevant for jazz, is something quite different. That activity requires thorough preparation, both mentally and with respect to skills that have to be internalized, which means that the performer is prepared to handle the unexpected, to handle an error as a new creative challenge, breaking with habitual patterns. All professional jazz musicians know that “playing jazz”, improvising, means to strive hard to obtain the ideal state, the “golden moments”, these ecstatic heights in musical interaction that are the main reason why we play. But as we all know, unfortunately these great moments really happen all too seldom. However, behind this motivation and intentionality to reach this “peak performance,” there has to be an existential urge.

Besides these elements, it is crucial that there is a good balance between challenges and skills. If this balance is not optimal, the musicians will either feel bored or anxious, the musicians’ potential for interaction weakened, and this will have a negative impact on the ensemble play. When this balance is optimal, the musicians will feel good and in this “aesthetics of presence”, they are in a state often referred to as “flow”. Musicians describe this state as ‘being played’, only observing that the fingers are playing their instrument. As such the performer’s condition will be a kind of constructive uncertainty and confusion, being in a transcendent state. This seems close to social psychologist Mihaly Csikszentmihalyi’s description of the “flow” concept:

Flow denotes the holistic sensation present when we act with total involvement.... It is the state in which action follows upon action according to an internal logic, which seems to need no conscious intervention on our part. We experience it as a unified flowing from one moment to the next, in which we feel in control of our actions, and in which there is little distinction between self and environment, between stimulus and response, or between past, present and future (Csikszentmihalyi, 1975).

When jazz musicians are asked to define improvisation, they often answer as Bailey mentioned, "I am just playing," or they try to find metaphoric terms, as did composer, arranger and trumpeter Thad Jones in an interview:

Here the aesthetics of presence hold unrestrictedly. You give yourself up, surrender without ulterior motives; egoism and spirit of competition yield for generosity, presence and interdependence. One develops a presence that is like telepathic intuition ... during such moments, improvisation is like the language that develops between two loving partners and that usually is called eroticism (Oversand, 1987).

It is tempting to link Jones' poetic description of improvisation to the old Sanskrit word *lila*, meaning "divine play", the play of creation, destruction and recreation, the folding and unfolding of the cosmos. *Lila*, free and deep, is both the delight and enjoyment of this moment, and the play of God. It also means love (Nachmanovitch, 1990).

As we see, to find adequate descriptions or definitions of this transient phenomenon in scientific linguistic terms is difficult, which underlines the complexity of interactions "in the course of performance." However, among the many different definitions, I find Paul Berliner's definitions on jazz improvisation particularly fruitful in this context:

Improvisation involves reworking pre-composed material and designs in relation to unanticipated ideas conceived, shaped, and transformed under the special conditions of performance, thereby adding unique features to every creation (Berliner, 1994).

This definition recognises that successful, creative improvisation is dependent on preparation and training as fundamental factors to spontaneous and intuitive action.

## IMPROVISATION IN OTHER CONTEXTS

Even if we in the last decade can find quite a lot of literature on improvisation outside the field of music, the necessity of improvisation seems rarely recognised in different organisational contexts: industry, management, education, etc., probably because these activities are mainly grounded on a reliance of linearity and traditional systems thinking. When regular planning breaks down, and solutions on the spot are needed, this way of acting (improvising) is often regarded as a sign of failure, called "emergency solutions" or "fire fighting," followed by a cry for new and more detailed plans which often results in

a lot of newly written, detailed, complicated instructions and bureaucratic procedures. The human potentiality for spontaneous creativity under such circumstances is seldom fully put into action because we, in most Western societies, are trained to follow rules and prescriptions for most of our actions, and therefore our natural creative capacity for finding the best solution in complex situations remains unused.

The ability to find local solutions "on the spot" is, as mentioned, officially rarely accepted in work life. On the contrary, there is a tendency to regard improvisational activities as "unfair" and as a rupture of the activities' canonised, official administration system. Indeed, in socialist countries Jazz was often suppressed because it pointed to individualism and freedom. To solve problems and local challenges that continually emerge during a working day, the employees that are closest to the problems then have to improvise "off the cuff" by making use of their tacit knowledge. Thus, improvisation is regarded as a temporary expedient, something risky and dangerous in human activity and accordingly a practice and activity that should be avoided. The status of improvisation is evaluated to be very low and this outlook on improvisation obviously has not inspired research activities related to this vital topic.

Among the primary goals of this paper is to acknowledge prepared improvisational activity as a crucial and inevitable activity in different contexts that demand training and practice, for example in a small group of musicians. The aspects of interaction we can observe in a jazz group seem to be fruitful for finding metaphors that can be used to illustrate ways of improvisation in other contexts.

## ORGANISATIONAL IMPROVISATION

The relatively new field of organisational improvisation is concerned with the pressures on organisations to react continually to today's ever-changing environment. We often find questions as "What can organisations learn from jazz?" Barrett (2002) offered seven features that could have implications for other contexts:

1. Provocative competence: Deliberate efforts to interrupt habit patterns.
2. Embracing errors as a source of learning.
3. Shared orientation toward minimal structures that allow maximum flexibility.
4. Distributing task: continual negotiation and dialogue toward dynamic synchronisation.
5. Reliance on retrospective sense making.
6. "Hanging out": Members in a community of practice.
7. Taking turns in soloing and supporting/ accompanying.

All of these characteristics are essential to the understanding of this musical expression. The third feature, "Shared orientation toward minimal structures that allows maximal flexibility", what Setreng (2002) calls "light bridges" best captures

the core of interaction and creativity in a jazz group. The relationship between structure and flexibility is an essential point concerning the best balance between order and chaos and in the space where creativity is given optimal conditions.

## STRUCTURE AND FLEXIBILITY

Flexibility is a term used in various contexts, but the concept is seldom defined. In the early 1970s, Gregory Bateson defined flexibility as “unused potential for change.” Flexibility consists of the possibilities one has not yet utilised, within defined frames. When the frames become narrower, the structure is filled with detailed prescriptions, and flexibility and creativity are reduced. When the structure in jazz and other human actions is too complicated or rigid, flexibility, improvisation and creativity do not have the chance to unfold.

The example from the offshore industry, cited in the beginning of this paper, might be an example on how important a balanced weight between structure and flexibility is to get the optimal conditions for creativity and improvisation to unfold. Even if the differences between diving and jazz are considerable, for example the consequences for making errors in diving are naturally far more serious than making errors in jazz improvisation, there are many parallels concerning preparation, training, and alertness to act on the spot, using all senses, body and soul. Jazz is in daily speech often described as “unstructured,” or “lack of structure.” As we shall see, jazz is based on structure, but not as distinctly as other forms of music. The structure in jazz is minimal and serves as a basis for the development of creative ideas, the patterns on which the musicians improvise. In this respect jazz differs from other musical expressions (e.g., pop, rock, art music) in how the structure is used as a frame for creative interaction.

## ORDER – CHAOS

Personally, I do not like the word ‘structure’ in musical surroundings very much. Structure is often described negatively, with connotations to limits and restrictions. Instead of structure, I find the words “agreement” or “mutual consent” to be more fruitful descriptions. “Mutual consent” gives an understanding about the frames the musicians have agreed upon and that this agreement is not a diktat from outside, but a mutual consent that serves as a point of departure for creative activity and display. In this sense, this agreement will be flexible; it may be enlarged and changed depending on the interaction in the collective dialogues. But if the mutual consents become too loose, the participants will not recognise the fundamental pattern, and they will lose contact with the agreement and with each other. The interplay breaks down and the result may be chaos. Chaotic performances may of course, for a short period, be interesting and even exciting, but the collective creative forces are badly off where chaos rules.

## STANDARDS

The agreements within jazz are very often rooted in what we call the “standards.” American film and musical tunes that through the years have become renowned are for example ‘I got rhythm’, ‘Summertime’, which are the basis, the mutual consent, for the creative interaction in a jazz group. Standards are often built on musical forms of 32, 16, 12 bars, which can be said to function as minimal structures. Many other references for improvisation are of course also used as mutual consents: melodic fragments, rhythmic ostinatos, melodic modes, bass figures, etc. These agreements (structures) are the tools whereupon improvisation unfolds. The structure is internalised and experienced implicitly: i.e., it is not necessary to accentuate “One” in every beat. “One” is in this context implicit and does not have to be articulated (Hatch, 2002) Further, structure is not sacred to the jazz musician, it serves its own alteration. The freedom imparted by not having to play structural features means that the musician can play around them, and this encourages creativity. I attended a concert with the Herbie Hancock Quartet in Trondheim, Norway, in July 2003. The first tune they played was the well-known standard melody “I love you”, nicely re-harmonised using alternative chords by Hancock. I knew the tune very well, but during the performance I had a lot of trouble recognising the 32-bar structure of the tune. I was lost by every repetition of the form, and I was quite frustrated by my inability to recognise the well-known structure. Talking to the musicians after the concert I got the answer. At a concert in France, the musical form, the agreement, was accidentally prolonged by one bar: ...“and you see, it was so much fun playing 33 bars, instead of the ordinary 32, that we still are playing this new structure!”

## DIALECTIC PARADOXES

This little alteration, one bar, was for the musician a fresh inspiration and gave new challenges for the creative interplay. As shown in this case, the head arrangement can be changed in the course of performance, a way of acting and communicating that demands a lot of experience, training and practice. This interaction implies confidence in tradition, alertness, listening and responding, taking risks, but to a great extent it also involves confidence and sense of security. An existential act is difficult to find adequate linguistic terms for and suggests a series of “dialectic paradoxes.” The musicians stress the importance of being able to do solos, but they must also be capable of accompanying and supporting other people. They know and respect the jazz tradition and its legacy carriers, but at the same time they want to challenge and push the tradition forward. These “dialectical paradoxes” between immersion in the tradition and taking risks, between standing out as an individual voice and being supporters of others’ voices, beg for new and creative ways of developing a deeper understanding of creativity and improvisation.

Improvising in jazz means to create a situation where change, transformation, and process are focused and where even



the structure, the referential foundation of improvisation, may be part of the alterations. Among the most important elements in this activity is changing the relation towards oneself, as this will be a fruitful point of departure for change in other relations. Compare this with the saying of the Norwegian drummer Jon Christensen in relation to his attitude and preparation before a concert performance: "At least, you have to try to surprise yourself" (Alterhaug, et al., 2002).

The communicational aspect to oneself and the dialogic aspect to the others are central to all improvisational activity, which should be a good basis for a "well-functioning democracy." In all kinds of dialogues there are always certain elements of uncertainty present because one does not know the "result" until the participation in the dialogue has come to an end. This fact is nicely expressed by Asplund: "I don't know what I have said until you have answered and you don't know what you have said until I have answered. You show me what I have said and I show you what you have said" (Molander, 1993).

## PROCESS AND COMPLEXITY IN GROUPS

Groups in different fields face the paradox of planning (trying to create its future) contrasted to their inability to foresee what the future entails. To cope with this paradox, the leader function is often strengthened in order to get a better and more effective organisation. This type of organising is based on a hierarchical and pyramidal thinking that seldom gives the expected results, because it neither brings out all the potential in each individual, nor the complementary forces in the group. Another, contrasting way of organising that converges with research in complexity theory is that which we can find in the jazz group. The complex responsive processes (CRP) perspective is a transformative process view, where human phenomena in organizations are a result of people interacting with each other and the environment. By the responding processes they create, they transform the reality of both themselves and their environment (Stacey, 2001). In small jazz groups, distributed tasks, rotation of soloing (leadership) and continual negotiation toward a dynamic synchronisation are elements that create a flow of ongoing invention and mutual support within the group. An example of this type of self-organising, flat structure, "moveable hierarchies," in a jazz group, is from a personal experience from my career as a jazz bass player.

Around 1970, the great tenor saxophonist Ben Webster was invited to give concerts in Trondheim, Norway, and I was asked to play bass in the quartet. I was not very experienced and almost scared to death playing with such a jazz giant. There was not much time for rehearsals; we hardly met before we were on stage to play a concert of two sets. During the first set, I tried hard to follow Webster's playing, very respectfully and intently, listening to every musical move he made, my sole concern being to do my very best for the "star." In the intermission I was very eager to hear what he thought about our support, and of

course, my playing. Without asking, and with a humble look, I sat down close to Ben waiting for something to be said. After a while he said: "Yeah Bjørn, you're doing fine. But, you shouldn't listen that much, then you lose yourself. You know, I need your initiative to play my best and then our best!" What a lesson from a master: To get the best music, you have to play in your own manner and of course be extremely alert to everything that happens during the performance, in that way the individual and collective forces in a team will have the best possibilities to unfold, and this of course gives the best music, through a collective, non-hierarchical approach. In jazz improvisation, the group has the ideas, not the individual musicians.

Communicating in an improvisational way gives joy, releases energy, and activates knowledge and reflection. The basis for this form of interaction and interplay is trust and freedom, two elements that secure the social dimension. In this perspective, knowledge is continually reproduced and transformed as interaction processes amongst people. Being involved in improvisation has a positive effect on the learning environment, social competence and development of a person's creative abilities, and this activity underlines that knowledge should not be stored in individual heads or in libraries, but activated and negotiated as complex, responsive processes in relations between people. Being involved in creativity and improvisation in one or another context should lead to a kind of Meta learning, a Meta doing that transfers across styles and forms (Nachmanovitch, 1990).

The directness and dialogic nature of improvisatory practice, which is something that happens "face to face" in real time situations, makes it particularly relevant and interesting in relation to communicational aspects in a globalised reality. Fisclin and Heble (2004) argue that music, specifically creative improvised music and free jazz, can reinvigorate our understanding of the social function of humanities research within the broader context of how that research plays a role in shaping notions of community and "new forms" of social organization.

## RESEARCH ON MUSICAL PERFORMANCE AND EXPERT PERFORMANCE

Recent research in a new discipline called the learning sciences shows musical improvisation as a very good pedagogical tool, and with general knowledge features related to expert performance. Sawyer (2008) argues that improvisation should be at the core of the music curriculum, and he also refers to cognitive science research from 1970s until now. This research shows the mental structures and processes underlying expert performance. Examples include doctors diagnosing a patient, lawyers analysing a case, architects designing a building and scientists interpreting the result of an experiment. Expert performance has four features of knowledge that have much in common with musical improvisation (Sawyer, 2008):

1. Deep conceptual understanding. Experts have not simply memorized a large repertory of facts. Of course they know



a lot of facts, but in the expert's mind, those facts are embedded in complex conceptual frameworks. Experts understand the mechanisms underlying phenomena and are able to explain surface features in terms of underlying mechanisms and conceptual structures.

2. Integrated knowledge. Each piece of knowledge is highly interconnected with all of the other pieces of knowledge. Expertise does not result from possessing distinct compartmentalized knowledge; everything known is related in an integrated framework.
3. Adaptive expertise. Experts have mastered a large range of standard procedures and solutions. When first encountering a new problem, they typically will quickly recall a variety of similar problems they've encountered in the past, and they will begin by considering one of the solutions that has worked in the past. But experts do not simply apply these memorized procedures in rote fashion; they are able to flexibly modify the routines they've mastered or to combine elements of distinct routines as is appropriate to the new problem.
4. Collaborative skills. Experts work together with other experts in teams and in complex organizational structures. Unlike the hierarchical corporation of old, where everyone's job description was quite specific, the boundaries between each team member are fluid, and many tasks require the simultaneous and joint contributions of multiple experts to be successfully accomplished.

Sawyer (2002) ends his paper this way: "...My hope is that music education will lead the way in moving to a new type of pedagogical practice, one that is grounded in the learning sciences, one that is based in improvisation."

## POSTLUDE

Fifteen years ago I introduced improvisation as a discipline for university music students, most of which had no previous training in improvising. The musical practice and improvisational interaction have of course been the most important activity in this improvisational discipline, but reflections through dialogues, as well as rather provoking and open questions about the students' everyday experience through the process have been of vital significance.

Throughout the years, the students' evaluation of the improvisational practice have been unambiguous when it comes to the following question: "Do you think the improvisation practice may have some effects on your way of acting in everyday life, like feeling more secure and being more self-confident when talking in front of an audience?" Almost all answers to this question have been positive, i.e., that the students through the improvisation practice have felt a better mastering of their own tensions, insecurity and fear, and that the fear of making mistakes had decreased radically. To me this means a reinforced belief in improvisation as a kind of Meta-learning; a pedagogical

strategy that has been strongly underestimated in all kinds of organised learning, from Kindergarten to Academia. Even if this cannot be regarded as valid research, the interaction with the students and their responses have, to me at least, been of great inspiration, an encouragement to continue this work and it has also served to reinforce the processes which had a creative beginning through musical interaction.

Improvisation becomes, in this context, an important factor in the development of the personality. The purpose is to give support to a creative process of consciousness: a process where individuals are made aware of their potentials and see these in relation to the relations and contexts they take part in. These studies should bring new angles to the understanding of the dialogic aspects of human communication and also with regard to introspection, alertness and social competence. Finally, these studies should lead to research and production of pedagogical material on different levels in the educational system to find new ways of learning and perceiving.

## CODA

One question often arises when dealing with improvisation: "To what extent can one learn improvisation?" To me, the answer is easy: As human beings, we already are part of a great improvisation and we are all more or less unconsciously improvising most of the day. We must simply become aware of this fact, "our unused potential for change," and then find the open spaces and the creative atmosphere to release our hidden, inborn improvisational capacities in different contexts, for the best for ourselves and the world we are part of.

## LITERATURE CITED

- Alterhaug, B. 2004. *Improvisation on a Triple Theme: Creativity, Jazz Improvisation and Communication*. In *Studia Musicologica Norwegica*. Oslo:Universitetsforlaget.
- Alterhaug, B., S.H. Jørgensen, and S. Setreng. 2002. *Improviseer necesse est*. In: *Forskning på tvers, Tverrfaglige forskningsprosjekter ved NTNU*, Tapir akademiske forlag.
- Andersen, Ø. 1995. *I retorikkens hage*, (In the Garden of Rhetoric). Oslo: Universitetsforlaget.
- Bailey, D. 1980. *Improvisation*. London: Moorland Publishing Co. Ltd.
- Barrett, F.J. 2002. Creativity and improvisation in jazz and organizations. In *Organisational Improvisation*. Kamoche, K., M. Pina E Cunha, and J. Vieira da Cunha, eds. London and New York: Routledge. pp. 135–162.
- Bateson, G. 1972. *Steps to an ecology of mind*, New York: Ballantine Books.
- Bergson, H. 1990. *Tiden og den frie vilje* (original title: *Essai sur les données immédiates de la conscience*) Oslo: Aschehoug.
- Berliner, P. 1994. *Thinking in Jazz*. Chicago: University of Chicago Press.
- Csikszentmihalyi, M. 1975. Play and intrinsic reward. *Journal of Humanistic Psychology* 15: 41–63.
- DeVeaux, S. 1991. Constructing the Jazz Tradition: Jazz Historiography. In: *Keeping Time, Readings in Jazz History*. R. Walser, ed. Oxford: Oxford University Press.
- Fisclin, D., and A. Heble. 2004. *The Other Side of Nowhere*. Middletown: Wesleyan University Press
- Hatch, M. 2002. Exploring the empty spaces of organizing. In *Organizational Improvisation*. Kamoche, K., M. Pina E Cunha, and J. Vieira da

- Cunha, eds. London and New York: Routledge. pp. 71–92.
- Jørgensen, S.H. 2009. unpublished manuscript. "Komplekse bevegelser og fotballfaglige utfordringer."
- Kinra, S., and M. Okasha. 1999. *Unsafe sax: cohort study of the impact of too much sax on the mortality of famous jazz musicians*. *British Medical Journal* 319(7225):1612–1613.
- Molander, B. 1993. *Kunnskap i handling*, (Knowledge in action) Daidalos.
- Morin, E. 1994. *La complexite humaine*, (Human complexity) Paris: Flammarion.
- Montouri, A. 1992. *Chaos, creativity and self-renewal*. World Futures. The Journal of General Evolution.
- . 2003. The complexity of improvisation and the improvisation of complexity: Social science, art and creativity. *Human Relations* 56(2):237–255. London: SAGE Publications.
- Nachmanovitch, S. 1990. *Free Play*, Published by J.P. Tarcher, Inc. Distributed by Putnam-Berkley.
- Nettl, B. 1998. *In the Course of Performance*, Chicago: University of Chicago Press.
- The New Grove Dictionary of American Music*. 1986. London: Macmillan.
- Oversand, K. 1987. *Improvisasjon og tilstedeværelsens estetikk*, (Improvisation and the aesthetics of presence) Musikkildenskapelig, O.K. Ledang, ed.
- Sawyer, K. 2008. Improvisation and Teaching. *Critical Studies in Improvisation* Vol. 3, No. 2.
- Setreng, S. 2001. *Mangfold og tid*, (Complexity and Time) Skrifter fra Musikkvitenskapelig institutt. Trondheim: NTNU
- . 2002. Improvisation and Musical Quality – a Qestion of Complexity. In *Challenges in Norwegian Jazz Research*. Trondheim: NTNU Institutt for Musikk.
- Sidran, B. 1981. *Black Talk*. New York: Da Capo Press.
- Shipton, A. 2001. *A New History of Jazz*. London and New York: Continuum.
- Stacey, R.D. 2001. *Complex Responsive Processes in Organizations: Learning and Knowledge Creation*. London: Routledge.
- Treitler, L. 1991. Medieval Improvisation. In: *The World of Music* 33 (3).
- Tutu, D. 1999. *No Future without Forgiveness*. An Image Book. New York: Doubleday, Random House.
- Weick, K. 1998. Creativity and the Aesthetics of Imperfection. Ford, C. Gioia, eds. *Creative Action in Organizations*. Thousands Lakes: Sage Press.
- . 2002. The aesthetic of imperfection in orchestras and organizations. In *Organisational Improvisation*. Kamoche, K., M. Pina E Cunha, and J. Vieira da Cunha, eds. London and New York: Routledge. pp. 49–70.

# Discussion: Environmental Physiology and Strategies for the Next 100 Years

*Chairman: Richard E. Moon*

---

**A. Brubakk:** The heart rate effect was very interesting. This fits well with our own modeling work that shows that exercise activity is important in order to judge decompression procedures. There are no decompression computers that take that into account. The second interesting point is what is down there that these animals stop diving. The whales use sound detection in order to locate their prey. It has been suggested by Sam Ridgway, because air is a bad conductor, that whales stop diving because the sound reflections become less distinct and they therefore terminate hunting dives. They have to wait until the gas bubbles have gone away which may be because of the sonic detection they have in their brain. Is the lung collapse related to a surfactant problem? Is the surfactant different in these animals? Some human physiology researchers talked about the possibility of getting whales or seals and developing an animal research facility to look at decompression.

**A. Fahlman:** We have no idea. The last research done on lung collapse was by Gerry Kooyman. It is extremely difficult to do this type of work with a seal in a hyperbaric chamber. We are now trying to devise ways to visualize animals under pressure. If we can do that we can get a sense of how the lungs collapse and proceed with comparative studies of terrestrial and marine mammals. The compliances of the respiratory system could be first looked at from physics, then histology, genetics and proteomics.

**A. Brubakk:** Can you acquire the surfactant?

**A. Fahlman:** Some studies have been done on that in dead, diseased animals.

---

**H. Janssen:** Do these animals change behavior and ability to do this with age? Also, do their neurological systems anatomically change with age?

**A. Fahlman:** That has not been studied. That would be an excellent long-term study.

**A. Brubakk:** They also do not appear to get HPNS.

---

**S. Gaustad:** How do these animals tolerate these high blood exposures with lactic acid not showing up during hypoxia?

**A. Fahlman:** They usually dive until the point that lactic acid starts increasing, called anaerobic diving, where they return to the surface before they run out of oxygen. There is no large build up of lactic acid and they have an immense vital capacity. If they have to dive longer and deeper, they build up CO<sub>2</sub> and then have to stop.

---

**M. Gennser:** You showed lung collapse in harbor seals and sea lions but these are not deep diving animals, are they? Lung collapse is a mechanism to protect against high oxygen and nitrogen pressure during deep diving.

**A. Fahlman:** The compliance of their respiratory system is the most divergent, the most different. You do not see that in experimental situations. No one has ever shown lung collapse in Weddell seals either. The best and most convincing study is by Kooyman and Sinnott (1982) where they actually measured the pulmonary shunt. All the other studies are estimated values like I have shown here. The nitrogen tensions are fitted with curves. In Ridgway's graph, there is no doubt that the respiratory system compressed and the lungs collapse eventually but I highly disagree with their 70 m estimated collapse depth, I believe it to be much deeper. One animal diving with 80% of lung capacity had a shunt of only 70% at 90 m.

**M. Gennser:** The fact that the animals reduce their speed close to the surface is interesting. There were some submarine escape experiments conducted where the speed was reduced from 30 m to the surface and that increased the final depth to about 50-60 m.

**A. Fahlman:** That is what they do between 15 and 30 m and that is also around the estimated nitrogen tensions they have when they come back to the surface. There is much guess work here but at least with these models we can define what we need to study next, i.e., blood flow distribution and gas exchange, which are also important for human divers.

---

**H. Janssen:** When other mammals can do this continuously without sustaining damage, the question is the mechanisms of exposures. There are things besides pressure we are exposed to as human beings, especially what we are breathing through. We

know very little about how we send the gas down to the diver through the umbilical and what this consists of and how this might impact on the exposure. We are exposed to fumes and other particles and occupational hazards like petrochemicals. We have divers who have spent most of their careers, 1000s of days in saturation, over tens of years. Is there damage we should see or might this be an adaptation?

**S. Daniels:** In essence, I completely agree with you. John Ross' earlier comment was absolutely right. The difficulty associated with trying to understand what might have caused any potential damage is that there are too many changes, too many potentially adverse circumstances that the diver will have been exposed to in their work environment. The only way we are going to understand this is to dissect it out in controlled situations where we can actually measure specific changes as a result of a particular manipulation of the animal. Trying to do cross-sectional studies is fraught with enormous difficulties. Regarding deep diving mammals, what I think I have identified in a particular sample I have received is simply a mechanism that might explain how they could be acutely sensitive, it says nothing about potential long-term effects. It is highly likely that those animals have developed adaptation mechanisms that compensate for their exposure, but we have no idea what those might be. The complexities of the regulations protecting marine mammals and acquiring samples are ferocious, which is why so little study has occurred, but it would be fascinating to do so.

**A. Brubakk:** Michael Gernhardt was previously a saturation diver, went on to get his PhD in decompression physiology and then became a NASA astronaut. Regrettably, he could not be here in person due to his testing schedule in the Arizona desert of the prototype moon buggy, but he did send us his presentation on video.

**R. Moon:** We do have in attendance an original astronaut, Dr. Jay Buckley.

**J. Buckley:** That was a great talk Mike just gave. It is beautiful, actually stunning, to see the Earth from space.

**R. Moon:** Referring to the tail of the distribution, the 5th percentile, you concluded that the prevalence of disease would be twice as high in divers. Is that a theoretical calculation or have you actually observed people in that category?

**E. Thorsen:** We have not. This study was of 135 retired divers. We calculated the prevalence and it was at least 5.1% divers compared to the age that has a prevalence of 1%. There has been some discussion about calculating prevalence, so it may be anything from 5%-1% and is dependent on the denominator you use.

**B. Gardiner:** Were all those subjects ex-North Sea professional sat divers? If so, I have always been a bit skeptical because saturation divers know how to fiddle that to keep getting their medical year after year. DO you do the straightforward spirometry they are used to offshore?

**E. Thorsen:** We do spirometry properly and stick to exhalation criteria concerning the solidity of the curves. We look at FEV1

in absolute numbers, not the FEV1 ratio which is dependent on the effort or the point at which you would like to stop the exhalation. The problem with spirometry is that it is often not done according to the standard and the maintenance of the equipment can be questioned at many levels.

**M. Swiergosz:** Can you comment on the clinical relevance and why it matters?

**E. Thorsen:** Five percent of retired divers with median age 50 have obstructive lung disease influencing their quality of life. The gold criterion is 1 or lower. This study says nothing about the severity of COPD, but they are clinically classified as having COPD.

**M. Swiergosz:** It is an interesting question to follow up. What kinds of functions are they losing? What is the definition of quality of life other than our scientific one?

**E. Thorsen:** Concerning lung function and reduction in FEV1, it is a reduction of their physical working capacity. The most important thing probably is that their COPD is classified as an occupational exposure that induces some rights in the social security system that you will not get if there is some other cause.

**R. Moon:** How do you manage your saturation crew?

**J. Gangenes:** These vessels support continuous saturation diving. We have 12 men on the seabed all the time and normally six in decompression on a rotational basis. Twelve divers are kept on the bottom 365 days, unless we are in refit. Two divers are working all the time, which means the second bell goes down before the first one comes up and you have an on-bottom handle on these guys with a lot of production.

**M. Gennser:** What sort of scrubber material are you using, is it still soda lime?

**M. Lothe:** We have a couple of unique features and are bought off the shelf. Fortunately, the US Navy put money into development of the micropore stirrers which is soda lime based, packed in plastic with three channel gas lines that has a very high efficiency for CO<sub>2</sub> scrubbing while at the same time keeping the work of breathing very low. The rebreather is fitted with two of those which gives it an extremely low time constant work rate and we can use it as a passive rebreather instead of a push-pull system.

**M. Gennser:** Has the capacity of the micropore been tested down to 400 m?

**M. Lothe:** No, it has not yet been tested to 400 m as far as I know. We are not going to use it the rest of the way if we find it deficient at 225.

**O. Molvaer:** The hyperbaric rescue vessels seem very big, how heavy are they?

**J. Gangenes:** Perhaps 1900.

**O. Eftedal:** Are the displays outside or inside? I ask because this might be used for bubble monitoring through Doppler ultrasound.

**J. Gangenes:** Inside, each diver has an individual unit and we have used these screens for many years now. They can be used for whatever you like.

**R. Moon:** Can you actually calculate what the PN<sub>2</sub> would be, is

there enough nitrogen in the lung and would it be sufficient to produce narcosis? Could it be that  $\text{PCO}_2$  is part of the narcotic process?

**P. Lindholm:** The  $\text{CO}_2$  could of course add to the narcosis. If you calculate the dive without lung collapse, yes, in those times you will reach high  $\text{PN}_2$  to get narcosis. It would not be possible however to really separate the  $\text{O}_2$  toxicity from the  $\text{CO}_2$  narcosis and the  $\text{N}_2$  narcosis in this mix.

**C. Balestra:** I wanted to add two things about Herbert Nitsch's way of making a record dive. What he is doing when he puts some air into the plastic Coca-Cola bottle, is he is sipping a bit of it to keep enough volume to be able to inflate his ears. No one can say if he is not rebreathing a bit. During rebreathing of even a few breaths, it is quite a long time of apnea you can do because you are not in apnea anymore. When he does his safety stop, I can accept that as a redistribution of blood coming from the blood shift, but not exactly for decompression. Claus Muth pointed out that what he does is come out of the water and says everything is OK and then goes back down with oxygen.

**P. Lindholm:** We do not know if he needs that for decompression. I also do not think he needs to rebreathe to keep his breath hold because it is just four and a half minutes. There are plenty of divers who actively swim down (the record being 130 m) with dive times also around four and a half minutes.

---

**C. Balestra:** There is one paper published in the British Medical Journal on saxophone playing and the increased risk of mortality. I have never seen in the medical literature a paper criticized as heavily as this one. The conclusion was that circular respiration is bad and that was why saxophone players died before the others. There were 35 or so reactions to this paper with everyone arguing against it.

---

**J. Jakobsen:** In Norway by law we are required to monitor our diving activity. As was shown in an earlier presentation, we are shortly to be drowned in dive data. We must also save occupational information about deep divers. Therefore, we must establish an international exposure register. This is not to demonstrate that there are dangerous aspects to diving, but it is to be prepared to answer possible long-term effects of diving in the future. The exposure needs to be defined and analytical tools developed.

---

**A. Brubakk:** Our earlier discussions were not really about strategy and objectives for the future. As our list demonstrates, there are many things we can do. We need to ask which of these problems are the most important and whether we have the tools and methodology to solve them. Personally, I would think that the problems of ageing, selection, oxygen toxicity and toxicity in general are four areas where there are crucial questions and there are methods that enable us to solve them. One important aspect about doing science is that there be a solvable problem and an available method. Establishing large databases without knowing what you are going to do with them is perhaps less important than devising a strategy we can use in order to prepare for the

next 100 years. We should really try to outline what problems are possible to solve in the short-term. My proposal is that we are going to try to repeat this event in three years, which should be a useful time span that, if this will lead to anything, will allow us to see a clear structure. The special focus and challenge will be to review what we have done during that three year period. We think that we can establish a real cooperation and solve a problem that we think is important and produce something that is of value, scientifically and practically. That is what we had planned as an outcome off this particular meeting.

**C. Balestra:** We were already planning to share a database with you to examine how to go forward with the recreational divers. Is there something to be shared with the military diving community?

**M. Swiergosz:** Notwithstanding having a "program", our leaders often thrust an emerging requirement on us in a short time frame for which we must improvise. It might be good to work in small groups first to devise a strategy on solving the important problems. Next month I am bringing together some of the people we fund and some outside people to think out of the box to refresh us to devise a programmatic strategy to attack the scientific inquiry of oxygen toxicity. This could be done with any of the listed problems.

**R. Moon:** We have highlighted four of the best questions. We heard from our commercial diving colleagues about the importance of ageing, diver selection, and trace gas toxicity. There is almost nothing written in the literature on those three. Oxygen toxicity is a long-standing, extremely important problem and will probably remain so.

**M. Lothe:** One of the interesting parts of this event is that we have many distinguished members of the diving community from different countries around the world. Too much time has been spent in the past on pushing your own agenda and believing that what is going on in your own community is the only thing that matters. This has created unhealthy competition in who can be the most acceptable. From my point of view as a responsible manager for many different people in their every day job, to go into these areas as a common effort to establish some worldwide acceptance of what is and what is not important in this community would be tremendously beneficial for everybody. From a commercial diving point of view, adhering to one set of standards versus over one hundred in the countries we operate in would give us the possibilities to change the costs of keeping up with all these national legislations and maybe use that in research.

**B. Gardiner:** In the future I would suggest a focus on physiology and biochemistry and perhaps genomics and psychology. What are the effects on people who spend long-duration time in isolation and perhaps join discussions with NASA on their ideas of people in space.

---

**A. Brubakk:** Barring further comments or suggestions, I will close the Haldane symposium here and again thank the speakers for their contributed lectures on which they spent a lot of time and the audience for coming here to participate.





# Appendix A: *The Prevention of Compressed-Air Illness* (1908)

---

To Come:

Intro Text and credit line

# THE PREVENTION OF COMPRESSED-AIR ILLNESS.

BY A. E. BOYCOTT, D.M.,

G. C. C. DAMANT,

*Lieut. and Inspector of Diving, R.N.,*

AND J. S. HALDANE, M.D., F.R.S.

*(From the Lister Institute of Preventive Medicine.)*

[With 7 Figures and 3 Plates.]

## CONTENTS.

	PAGE
Introduction . . . . .	348
Part I. Theoretical.	
A. The rate of saturation of the body with nitrogen during exposure to compressed air . . . . .	345
B. The rate of desaturation of the body with nitrogen during and after decompression . . . . .	350
C. The limits of safety in decompression . . . . .	355
D. Practical measures for avoiding compressed-air illness:	
(1) Diving . . . . .	358
(2) Work in caissons and tunnels . . . . .	372
Part II. Experimental.	
1. Apparatus . . . . .	377
2. Choice of experimental animals and results with large and small animals . . . . .	378
3. Respiratory exchange of goats . . . . .	380
4. Method of conducting the experiments . . . . .	382
5. Symptoms observed in goats . . . . .	385
6. Results of the goat experiments . . . . .	394
7. Individual variation among the experimental animals . . . . .	403
8. Pathology of caisson disease in goats . . . . .	410
Summary . . . . .	424
Appendix I. Human experiments in the pressure chamber . . . . .	426
" II. Human experiments in deep diving . . . . .	429
" III. Protocols of some goat experiments . . . . .	436
" IV. Tables for decompression of divers . . . . .	442



A. E. BOYCOTT, G. C. C. DAMANT AND J. S. HALDANE 343

## INTRODUCTION.

MEN who have been working in compressed air, as in diving, preparing foundations of bridges, etc. under water, or making tunnels or shafts through water-bearing strata, are liable on their return to atmospheric pressure to a variety of symptoms generally known as "diver's palsy" or "caisson disease," but which may more conveniently be designated "compressed-air illness." It was shown experimentally by Paul Bert<sup>1</sup> that these symptoms are due to the fact that gas (chiefly nitrogen) which goes into solution in the blood and tissues during exposure to compressed air is liberated in the form of bubbles on too rapid decompression, and produces local or general blockage of the circulation or other injury. Subsequent investigations, for an account of which we must refer more particularly to the treatise on the subject by Heller, Mager and v. Schrötter<sup>2</sup> and to recent papers by Hill and McLeod<sup>3</sup> and Hill and Greenwood<sup>4</sup>, have confirmed and extended Paul Bert's conclusions.

It was pointed out by Paul Bert that by means of very slow decompression the symptoms of caisson disease could be avoided, but his experiments were not sufficient to furnish data as to what rate of decompression would be safe. Nor has subsequent human experience in engineering undertakings solved this problem; and the risks attending work in compressed air at excess pressures of over 1½ to 2 atmospheres are notorious. Heller, Mager and v. Schrötter have endeavoured to formulate rules as to safe decompression; and they express the belief that perfectly uniform decompression at the rate of 20 minutes an atmosphere would always be safe. Following this rule, which is based on a calculation, Hill and Greenwood decompressed themselves, without any serious symptoms, after short exposures at excess pressures of as much as five and even six atmospheres.

Although the rules formulated by the above-mentioned observers constituted a distinct step in advance, it appeared to us that, for reasons which will be explained below, there were grave doubts as

<sup>1</sup> *La Pression Barometrique*, 1878.

<sup>2</sup> *Luftdruckerkrankungen*, 1900; also v. Schrötter, *Der Sauerstoff in der Prophylaxie und Therapie der Luftdruckerkrankungen*, 2nd edition, 1906. The former work contains a very full abstract of all previous investigations on the subject.

<sup>3</sup> *This Journal*, vol. III. (1903), p. 401 (and references there given): see also *Recent Advances in Physiology*, 1906, pp. 233—255.

<sup>4</sup> *Proceedings of the Royal Society*, vol. LXXVII. p. 442, 1906; vol. LXXIX. p. 21, 1907; also *British Medical Journal*, July 7th, 1906, Feb. 16th, 1907, June 22nd, 1907.



### 344 *The Prevention of Compressed-air Illness*

to the safety of their recommendations, and particularly as to whether uniform decompression is desirable. The need for framing definite rules as to safe decompression in the shortest possible time presented itself in a very definite form in connection with the work of the Admiralty Committee on Deep Diving<sup>1</sup>, of which one of us was a member. Our investigation, which was planned with the more particular object of furnishing information required for securing the safety of divers ascending from deep water, was rendered possible by the gift to the Lister Institute by Dr Ludwig Mound, F.R.S. of a large experimental steel pressure chamber and by substantial financial and other help from the Admiralty, Messrs John Aird and Son, the late Mr Basil Ellis, Messrs S. Pearson and Son, Ltd., and Messrs Price and Reeves.

The formation of gas bubbles in the living body during or shortly after decompression evidently depends on the fact that the partial pressure of the gas or gases dissolved in the blood and tissues is in excess of the external pressure. But it is a well-known fact that liquids, and especially albuminous liquids such as blood, will hold gas for long periods in a state of supersaturation, provided the supersaturation does not exceed a certain limit. In order to decompress safely it is evidently necessary to prevent this limit being exceeded before the end of decompression. Whether or not the decompression is free from risk will depend on the degree of supersaturation which can be borne with safety, the extent to which the blood and tissues have had time or opportunity to become saturated, and the extent to which they have had time to become desaturated again during decompression. In carrying out our investigations we have kept these three factors constantly in view, and it is necessary to discuss them in some detail before proceeding further.

<sup>1</sup> The Report of this Committee, which has recently appeared as a blue-book, contains a full account of the experimental investigations on Diving, carried out under its auspices at Portsmouth, off the West Coast of Scotland, and elsewhere, during the last two years: also a short summary of the experiments detailed in the present paper, and many data as to the occurrence of compressed-air illness in connection with diving and other work in compressed air. The conclusions and recommendations of the Committee are summarised at the beginning of the Report.



A. E. BOYCOTT, G. C. C. DAMANT AND J. S. HALDANE 345

PART I. THEORETICAL.

A. *The rate of saturation of the body with nitrogen during exposure to compressed air.*

When a man or animal is placed in compressed air, the blood passing through the lungs will undoubtedly take up in simple solution an amount of gas which will be increased above normal in proportion to the increase in partial pressure of each gas present in the alveolar air. The experiments of Haldane and Priestley<sup>1</sup>, which have since been extended by Hill and Greenwood<sup>2</sup>, show that the partial pressure of CO<sub>2</sub> in the alveolar air remains constant with a rise of atmospheric pressure: hence there can be no increase in the amount of CO<sub>2</sub> present in the blood during exposure to compressed air. As regards oxygen, the amount in simple solution in the arterial blood will certainly increase in proportion to the rise in alveolar oxygen pressure; but as soon as the blood reaches the tissues this extra dissolved oxygen, which (except with exposures to enormous pressures) is only a small part of the total available oxygen in the arterial blood, will be used up, so that in the tissues and venous blood there will be at most only a very slight increase in the partial pressure of oxygen. For practical purposes therefore we need only take into consideration the saturation of the body with nitrogen.

In view of what is known as to the ease and completeness with which the blood becomes aerated in its passage through the lungs, there seems no reason to doubt that in compressed air the blood reaching the lung capillaries must become instantly saturated with nitrogen at the partial pressure existing in the alveolar air (see p. 351). At the commencement of exposure to compressed air this blood, on being carried to the tissues, will by diffusion share with them its excess of nitrogen and then return to the lungs for a fresh charge. By the constant repetition of this process the tissues, and the venous blood leaving them, will gradually become more and more saturated with nitrogen at the partial pressure of the nitrogen in the alveolar air, which will be practically the same as in the inspired air. Since the rate of blood supply and the solubility of nitrogen per unit mass of tissue vary greatly in different parts of the body, the rate of saturation

<sup>1</sup> *Journal of Physiology*, vol. xxxii. (1905), p. 229.

<sup>2</sup> *Proc. Roy. Soc., B*, vol. lxxvii. p. 442.



346 *The Prevention of Compressed-air Illness*

will vary correspondingly. We may however form some rough general idea of the average rate of saturation by assuming as a basis of calculation that the blood is evenly distributed throughout the body, and that the tissues are similarly constituted in all parts.

According to the figures adopted by Bohr<sup>1</sup>, 100 c.c. of blood take up in simple solution at the body temperature 0.87 c.c. of nitrogen for each atmosphere of air pressure. This is only 8% less than would be taken up by water under the same conditions. Blood contains nearly the same percentage of solids as the semi-liquid tissues (apart from fat) in most parts of the body, and we may assume that these tissues will take up nearly the same proportion of nitrogen as blood. The earthy constituents of bone (about 3% of the body weight) probably take up no nitrogen. On the other hand the body fat, as was recently shown by Vernon<sup>2</sup>, who made a number of determinations at the body temperature with special reference to our investigations, takes up about six times as much nitrogen as an equal weight of blood. The body of a well-nourished man probably contains fully 15% of its weight as fat or fatty material. Hence it may be estimated that it will, when saturated at any given pressure, on an average take up, weight for weight, about 70% more nitrogen in simple solution than the blood under the same conditions, and that the whole body of a man weighing 70 kilos will take up about one litre of nitrogen for each atmosphere of excess pressure.

Now the weight of the blood in man is about 4.9% of the body weight<sup>3</sup>: hence the amount of nitrogen held in solution in the body, when it is completely saturated at any given pressure, will be about  $\frac{170}{4.9}$ , or 35 times as great as the amount present in the blood alone.

If therefore the blood distributed itself evenly and at the same rate throughout the body, the latter would have received, at the end of one complete round of the blood after sudden exposure to high pressure of air, one thirty-fifth of the excess of nitrogen corresponding to complete saturation. The second round of the circulation would add one thirty-fifth of the remaining deficit in saturation, *i.e.*  $\frac{1}{35} \times \frac{34}{35}$  of the total excess: the third round would add  $\frac{1}{35} \times (\frac{34}{35} \times \frac{34}{35})$  of the total excess, and so on. On following out this calculation, it will be found that half the total excess of nitrogen would have entered the body

<sup>1</sup> *Nagel's Handbuch der Physiologie*, vol. I., 1905, p. 63.

<sup>2</sup> *Proc. Roy. Soc.*, vol. LXXIX. B, 1907, p. 366.

<sup>3</sup> *Haldaue and Lorrain Smith, Journal of Physiology*, vol. XXV., 1900, p. 340.



A. E. BOYCOTT, G. C. C. DAMANT AND J. S. HALDANE 347

after 23 rounds of the circulation, three-fourths after 46 rounds, seven-eighths after 69 rounds, and so on. The progress of the saturation of the body with nitrogen is thus a logarithmic curve of the form shown in Figure 1<sup>1</sup>.

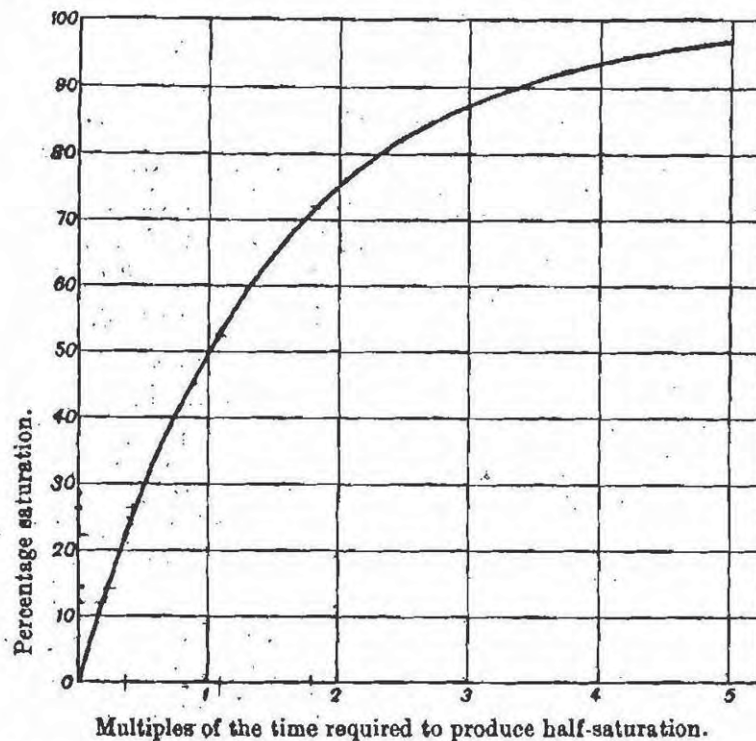

Fig. 1. Curve showing the progress of saturation of any part of the body with nitrogen after any given sudden rise of air pressure. The percentage saturation can be read off on the curve, provided the duration of exposure to the pressure, and the time required to produce half-saturation of the part in question, are both known. Thus a part which half-saturates in one hour would, as shown on the curve, be 30% saturated in half-an-hour, or 94% saturated in 4 hours.

Experiments on animals have shown that the venous blood entering the lungs contains about two-fifths less of oxygen than the arterial blood. If we assume that the same proportion holds good for a man at rest, and that very little oxygen is used up in the lungs themselves, the percentage of oxygen gained by the blood in the lungs must be about 8%, or about double the percentage diminution in the expired

<sup>1</sup> This calculation is in principle similar to that made by Zuntz (*Fortschritte der Medizin*, 1897, No. 16), and worked out more fully by Heller, Mager and v. Schrötter (*loc. cit.*). On account, however, of the discovery that fat has a very high coefficient of absorption for nitrogen, and that the blood volume in man is considerably less than was formerly supposed, our calculation gives a much slower rate of saturation per round of the circulation.



348 *The Prevention of Compressed-air Illness*

air as compared with the inspired air. The volume of blood passing through the lungs is therefore about double the volume of air breathed. Since this volume of air (measured dry and at standard pressure and temperature) averages about seven litres per minute<sup>1</sup> for a man of 70 kilos during rest, the volume of blood passing through the lungs may be estimated at about 3.5 litres per minute<sup>2</sup>. The total blood volume is however also about 3.5 litres, so that a volume of blood equal to the total blood volume probably passes through the lungs about once a minute during rest. We may therefore substitute minutes for rounds of the circulation in the above calculation of the rate of saturation of the body with nitrogen, so that, if the assumptions made for the purposes of the calculation held good for a man exposed to compressed air, his body would be half saturated with the excess of nitrogen in 23 minutes, three-fourths saturated in 46 minutes, etc.

In reality, however, this calculation affords at best only a very rough general idea of the actual rate of saturation, since it is known that the distribution of blood per unit of body weight through various parts of the body varies greatly, and that the rate of circulation through any given part varies according as the part is at rest or in a state of activity. The proportion of fat and fatty material is also very different in different parts of the body, so that the capacities of different tissues for taking up nitrogen must vary accordingly. We should expect therefore that some parts of the body will saturate much more rapidly than the calculation shows, and other parts much more slowly. Direct experimental evidence of far more rapid saturation in some parts of the body has recently been furnished by Hill and Greenwood<sup>3</sup>. Their method was to determine the free nitrogen in samples of urine secreted shortly after exposure to high pressure, and shortly after return to normal pressure. A sufficiently copious secretion of urine was produced by previously administering large drinks of water to the subject of the experiment; and they found that, within about ten minutes of exposure to high pressure, samples of urine secreted were saturated at this pressure. Conversely, on lowering the pressure to normal, the excess of nitrogen disappeared within a few minutes.

<sup>1</sup> Haldane and Priestley, *loc. cit.*, p. 245.

<sup>2</sup> As a result of numerous experiments on man with the lung catheter Loewy and v. Schrötter (*Untersuchungen über die Blutcirculation beim Menschen*, 1905, p. 90) infer that the average rate of blood flow during rest is slightly faster. At present, however, there is some doubt as to the interpretation of results obtained by the lung catheter method.

<sup>3</sup> *Proc. Roy. Soc. B*, vol. LXXIX., p. 21, 1907.



## A. E. BOYCOTT, G. C. C. DAMANT AND J. S. HALDANE 349

These results seem to show conclusively that the kidney substance became saturated with nitrogen at a rate about ten times as great as would correspond to the above calculation. From the data given it appears, however, that urine was being secreted with great rapidity during the experiments. For instance, 135 c.c. were secreted in five minutes in one observation where the quantities and times are recorded. This is about thirty times the average rate of secretion, so that the circulation of blood through the actively working kidneys must have been greatly increased.

Equally clear evidence of the existence of a far slower rate of saturation is afforded by the experience of men working in compressed air, particularly in caissons and tunnels at moderate pressures. It is well known to those practically familiar with such work that the risk of symptoms occurring on decompression depends on the duration of the exposure. There is very little risk on rapid decompression after short exposures of less than an hour to an excess pressure of two atmospheres or even somewhat higher pressure; but as the duration of exposure increases hour by hour, so do the risks on decompression increase. We are assured by Mr E. W. Moir (of the firm of Messrs S. Pearson and Son, Ltd., Westminster), who has had an exceptionally large experience of tunnelling work in compressed air at excess pressures up to about  $2\frac{1}{2}$  atmospheres, that the maximum of risk is not reached after even three hours, so that a limitation of working shifts to three hours markedly diminishes the frequency of compressed-air illness. Hence in some parts of the body saturation with nitrogen must still be incomplete after three hours. Another observation pointing in the same direction is that when the daily working period was  $8\frac{1}{2}$  hours under pressure with two intervals of about  $1\frac{1}{2}$  hours each for meals at ordinary atmospheric pressure, cases of caisson disease usually occurred after the last decompression in the evening and not when the men came out for meals<sup>1</sup>.

Our own observations on animals afford fresh evidence bearing in the same direction. We found that in goats the risks on decompression increase with the length of exposure to pressure up to from two to three hours (see below, p. 396).

In different warm-blooded animals the rate of respiratory exchange varies, roughly speaking, according to the ratio of body surface to weight. The smaller the animals, therefore, the greater is the respiratory exchange per unit of body weight, and the more rapid must be the

<sup>1</sup> G. W. M. Boycott, *Trans. Inst. of Civil Engineers*, vol. CLXV., 1906.



### 350 *The Prevention of Compressed-air Illness*

circulation. In consequence small animals, when placed in compressed air, must saturate their tissues more rapidly in proportion to their more active respiratory exchange; and, conversely, they will free themselves more rapidly, during or after decompression, from the excess of nitrogen. Hence results obtained with small animals as to the time required for complete saturation, or for safe decompression, are not directly applicable to man. We selected goats for our experiments as they were the largest animals which could be conveniently used; but their weights averaged only about one-fourth to one-third of the weight of an adult man. As the surfaces of different mammals are roughly as the cube roots squared of their weights, we should expect that in goats of this size the respiratory exchange per kilo of body weight would be about two-thirds greater than in man. Direct determinations showed that this was the case (see p. 381). Hence if it required three hours exposure to a high pressure to effect practically complete saturation<sup>1</sup> of the more slowly saturating tissues of a goat with nitrogen, about five hours would be required for a man. An inspection of Fig. 1 (p. 347) will show that if these tissues became 50% saturated in about 45 minutes in goats and 75 minutes in man, they would be 94% saturated in three hours for goats, and in five hours for man. A higher degree of saturation than this would scarcely be appreciable, and we have concluded that for practical purposes any slower rate of saturation than this, and correspondingly slower rate of desaturation, need not be allowed for, unless the percentage of fat in the body is abnormally high. We must admit, however, that there is some evidence, both from our own experiments and from practical experience in work in compressed air, that in the parts of the body which are the seat of "bends" a still slower rate of saturation may exist.

#### B. *The rate of desaturation of the body with nitrogen during and after decompression.*

If the pressure is rapidly diminished to normal after exposure to saturation in compressed air, and no gas bubbles are liberated in the body, it is evident that for each part of the body the curve of desaturation will be similar to that of saturation, provided the physiological conditions are constant. The venous blood will give off practically the

<sup>1</sup> The only method apparently available to determine the time of complete saturation in normal animals is to subject them to a series of experiments in which the pressure and decompression are kept constant and the time of exposure varied, and to observe when the effects cease to become any worse. The method is open to obvious limitations.



## A. E. BOYCOTT, G. C. C. DAMANT AND J. S. HALDANE 351

whole of its excess of dissolved nitrogen during its passage through the lungs<sup>1</sup>, and at each round of the circulation will bring back a fresh charge of nitrogen (at the partial pressure existing in the tissues) to be given off. The parts which become half desaturated by this process in a given time will be three-fourths desaturated in double the time, and so on. The slowest saturating tissues will thus, in accordance with our previous calculation, take one and a quarter hours to become half desaturated in man.

The normal combined gas pressure of nitrogen, oxygen and CO<sub>2</sub> in the tissues and venous blood may be estimated as about 90 % of an atmosphere, so that if the nitrogen pressure be more than an eighth above normal the total gas pressure will be above atmospheric pressure. Supposing therefore that before decompression the most slowly saturating parts of the body (*i.e.* those half saturating in one and a quarter hours) had been saturated to an excess pressure of two atmospheres of air, it would take about five hours at atmospheric pressure to reduce this excess pressure to a sixteenth (or an eighth of one atmosphere) and so bring down the total gas pressure in the parts in question to about atmospheric pressure. The slowness of desaturation must be as clearly borne in mind as the slowness of saturation, in connection with all the phenomena of compressed-air illness.

If gas bubbles are formed in consequence of too rapid decompression, they will naturally tend to increase in size by diffusion into them, in whatever part of the body they may be except the arteries, for some time after the end of decompression. They may thus easily cause blocking of small vessels, and even if they are carried to the right side of the heart or the pulmonary arteries, and lodge there, they will increase in bulk until the total gas pressure in the mixed venous blood falls to one atmosphere. The same remark applies to bubbles which

<sup>1</sup> In view of the enormous surface (probably more than 100 square metres) presented by the lung alveoli for diffusion it seems hardly possible to doubt that the blood during its passage through the lungs becomes saturated or desaturated to almost exactly the pressure of nitrogen in the alveolar air. According to the calculations of Loewy and Zuntz (*Die physiologischen Grundlagen der Sauerstoff-Therapie* in Michaelis' *Die Sauerstofftherapie*, Berlin, 1904), a difference in partial pressure of oxygen of less than 1 mm. of mercury would account for the diffusion of 250 c.c. of oxygen per minute through the alveolar walls. With a difference in partial pressure of nitrogen of two atmospheres, or 1520 mm. of mercury, between the blood and the alveolar air only about 70 c.c. of nitrogen would require to pass per minute in order to establish complete saturation, or desaturation, of the blood. The conditions are thus enormously more favourable for the taking up or giving off of this nitrogen than for the taking up of oxygen by diffusion during normal respiration.



### 352 *The Prevention of Compressed-air Illness*

lodge in the branches of the portal veins. If small bubbles are carried through the lung capillaries and pass, for instance, to a slowly desaturating part of the spinal cord, they will there increase in size and may produce serious blockage of the circulation or direct mechanical damage. Apart from this increase of size the air bubbles passing along the arteries are probably too small to cause any harm. Once formed they will under ordinary conditions take a long time to become re-absorbed, since even after the gas pressure in the blood and tissues has fallen to normal, the excess of nitrogen pressure in the bubbles over that in the blood and tissues will only be about a tenth of an atmosphere at most. In one case we found bubbles in the veins of an animal which died two days after suffering from severe decompression symptoms (see below p. 421).

In order to avoid the risk of bubbles being formed on decompression, it has hitherto been recommended that decompression should be slow and at as nearly a uniform rate throughout as possible. We must therefore carefully consider the process of desaturation of the body during slow and uniform decompression. For convenience in calculation we may imagine the process as occurring in a series of time-intervals, the first half of each of which is spent at the pressure existing at the beginning of the interval, and the second half at the pressure existing at the end. Let us suppose, for instance, that the body has been completely saturated with nitrogen at an excess pressure of five atmospheres of air, and that decompression occurs at a rate of one atmosphere in 20 minutes. The process may be divided into five periods of 20 minutes, during each of which the pressure falls one atmosphere. We can then easily calculate how far desaturation will have gone at the end of each period, and from these data construct a desaturation curve.

Let us first consider the mean desaturation rate of the whole body, assuming that, when the pressure is suddenly raised or diminished to a certain level, the tissues will on an average saturate or desaturate themselves by 50% in 23 minutes, which was shown above to be a probable average rate. A reference to the curve (Fig. 1) shows that ten minutes' exposure to the reduced pressure of four atmospheres in excess will reduce the saturation by 28% of the difference between five and four atmospheres, *i.e.* by 0.28 of an atmosphere. Hence at the end of 20 minutes the tissues will on an average be saturated to 4.72 atmospheres. Ten more minutes at four atmospheres will reduce the saturation to 4.5 atmospheres, and ten minutes at three atmospheres



A. E. BOYCOTT, G. C. C. DAMANT AND J. S. HALDANE 353

will further reduce it by 28% of  $4.5 - 3$ , *i.e.* by 0.42 atmosphere. Hence at the end of the second twenty minutes the saturation of the tissues will be 4.08 atmospheres. Continuing this calculation we get the desaturation curve shown in Fig. 2, from which it will be seen that when atmospheric pressure is reached the tissues are still saturated to an excess pressure corresponding to 1.4 atmospheres of air.

Fig. 2 also shows a similar curve for the parts which saturate and desaturate most slowly, and which, according to our previous calculations, take one and a quarter hours to become half saturated. At the end of decompression these slowly desaturating parts, as shown on the curve, are still saturated to 3.15 atmospheres. This of course represents a most formidable excess; and, as will be shown below (p. 401), uniform decompression at this rate is dangerous even to goats, and would certainly be extremely dangerous to men, who desaturate a good deal more slowly than goats.

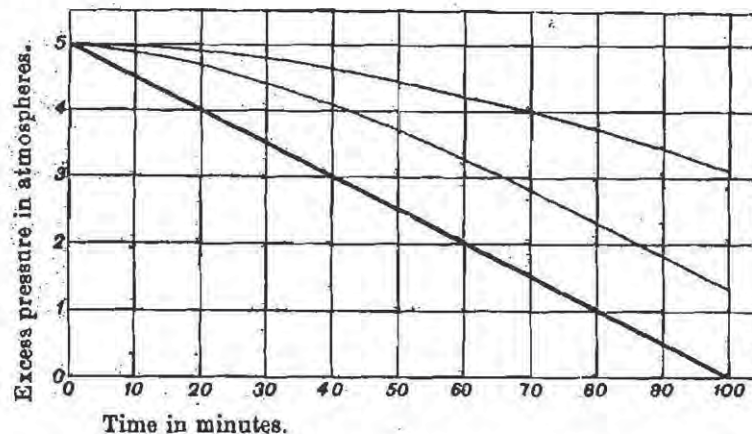

Fig. 2. Desaturation during uniform decompression after complete saturation at 5 atmospheres excess pressure. The thick line represents the air pressure; the upper and lower thin lines represent respectively the progress of desaturation in parts of the body which half saturate in 75 and 23 minutes.

Inspection of Fig. 2 shows that with uniform decompression the nitrogen pressure in the body lags behind that of the air, and that (in the case of the slowly desaturating parts) the amount of the lag increases during the whole time of a decompression lasting 100 minutes. No other result seems possible, and actual experiments point strongly in the same direction, as will be shown presently. We must emphatically dissent from the conclusion drawn by Heller, Mager and v. Schrötter that decompression at the uniform rate of 20 minutes an atmosphere prevents any dangerous retention of gas in the body. To



### 354 *The Prevention of Compressed-air Illness*

prevent a maximum lag of more than one atmosphere, it would be necessary to decompress at a rate of over one and a half hours an atmosphere if the decompression were uniform and from an excess pressure of five atmospheres<sup>1</sup>.

The examples given will be sufficient to illustrate the extreme slowness with which desaturation must occur with a uniform rate of decompression. This slowness has never hitherto been recognised, but must evidently be reckoned with in devising measures for the prevention of caisson disease.

It is clear that the rate of desaturation might be hastened by either (1) increasing the difference in nitrogen pressure between the venous blood and the air in the lungs, or (2) increasing the rate of blood circulation. In either case the blood would give off through the lungs an increased amount of the excess of nitrogen in a given time.

In order to increase the difference in nitrogen pressure between the venous blood and the alveolar air it has been proposed to give a diver oxygen to breathe during, or before decompression. As long, however, as the pressure was above about one atmosphere in excess, or 15 lbs., it would be impossible to do this safely, since, as will be explained more fully below, the effects might be rapidly fatal owing to oxygen poisoning. The possible applications of oxygen are thus somewhat limited, while the complications involved would be very considerable. The same end can, however, be attained in another way, as will be shown in the following section.

The rate of blood circulation can be increased considerably by muscular exertion. Quite moderate exertion is sufficient to increase the respiratory exchange to three or four times the normal; and the rate of blood flow through the lungs must be increased to something approaching to a corresponding extent. Unfortunately, the increased blood flow is chiefly through the muscles which are working, but probably many parts of the body participate to a greater or less extent in the extra blood supply. Muscular work must correspondingly increase the rate of saturation of the body with nitrogen. For this reason it seems desirable that where work has been done in compressed air, so that the muscles and associated tissues have probably become rapidly saturated with nitrogen, there should also be muscular exertion

<sup>1</sup> It is evidently a mistake to assume that a given rate of uniform decompression, such as 20 minutes per atmosphere, is either necessary for safety in all cases, or would be actually safe except from some limit of pressure. From a pressure below this limit the rate will be unnecessarily slow, and from above it dangerously fast.



## A. E. BOYCOTT, G. C. C. DAMANT AND J. S. HALDANE 355

during decompression. The rate of desaturation will thus be increased so as to compensate for the increased rate of saturation. In the case of short exposures to compressed air, as in diving work, this is specially important. Even, however, when there has been no special muscular work in the compressed air movements of joints and massage of the skin etc. will probably hasten desaturation. This has been clearly pointed out by Hill and Greenwood<sup>1</sup>.

Another method which can be employed for increasing the circulation in the case of divers is to restrict the air supply, so that the partial pressure of CO<sub>2</sub> in the air of the helmet may rise sufficiently to stimulate the respiration and circulation. Both methods are now used in the Royal Navy during the ascent of divers.

C. *The limits of safety in decompression.*

It is a fact well known to those practically acquainted with work in compressed air that even with very rapid decompression there is no risk of caisson disease unless the pressure has exceeded a certain amount. It seems perfectly clear that no symptoms occur with less than one atmosphere<sup>2</sup> of excess pressure, however long the exposure may be. Whether any distinct symptoms ever occur with less than about 1.25 atmospheres (18½ lbs. per square inch or 41 feet of sea water) seems very doubtful: at any rate they are very exceptional. At pressures a little above 1.25 atmospheres occasional slight cases begin to be observed, and their frequency and gravity rapidly increase with higher pressures unless the time of exposure is limited or slow decompression is resorted to. The lowest pressure at which we have been able to find any record of a death occurring from caisson disease is 23 lbs. or 1.6 atmospheres<sup>3</sup>. As will be seen below, we were able to obtain slight symptoms on rapid decompression in 1 out of 22 goats after long

<sup>1</sup> *Proc. Roy. Soc. B*, vol. LXXVII., p. 449, 1906.

<sup>2</sup> One atmosphere or 760 mm. of mercury = 14.7 lbs. per square inch, about 1 kilogram per square centimetre, 34 feet of fresh water, 33 feet of sea water. In this paper where pressures are defined in pounds or atmospheres without qualification, reference is intended to the excess over atmospheric pressure as shown on gauges, not to the absolute total pressure.

<sup>3</sup> Babington and Cuthbert, *Dublin Quarterly Journal of Medical Sciences*, vol. XXXVI., 1863, p. 312. In the list of fatal cases given by Heller, Mager and v. Schrötter (*Luft-druckerkrankungen*, p. 1072), are entered two deaths at a pressure of 1.4 atmospheres. A perusal of Paul Bert's original account (*La Pression Barometrique*, p. 401) shows that both the pressure and the cause of death are quite uncertain.



### 356 *The Prevention of Compressed-air Illness*

exposure (four hours) to 1.36 atmospheres or 20 lbs. With 25 lbs. (1.7 atmospheres) two cases of slight illness occurred out of 23 animals.

If the risks of rapid decompression depended simply on the extent to which the blood and tissues are supersaturated with nitrogen on decompression, we should expect to find that even a short exposure to such an excess pressure as two atmospheres would be risky with rapid decompression: for there can be no doubt that within, say, half an hour or forty minutes the tissues, and the blood returning from them, must be for all practical purposes fully saturated in many parts of the body, and particularly in parts of great physiological importance which are richly supplied with blood. Nevertheless it seems to be well established that a man may stay without serious risk for forty minutes at a pressure which would involve great danger on rapid decompression if he remained in it for several hours.

Parts of the body with a rapid circulation will become very completely saturated in a comparatively short time, but the highly supersaturated blood which first returns from them on rapid decompression can remain but a very short time supersaturated during each round of the circulation, and on reaching the large veins will mix with less highly saturated blood from other parts of the body. It would seem that the state of high supersaturation in any portion of blood lasts for too short a time to enable bubbles to form.

If this interpretation of the facts is correct, we should expect to find with small animals, which rapidly saturate and desaturate, that a higher pressure would be required to produce symptoms on rapid decompression after a long exposure than in the case of larger animals. The general experience of previous observers is in accord with this, and our own experiments (see below p. 402) showed that we could produce no obvious effects in mice, and very few in rabbits, rats, and guinea-pigs, by sudden decompression after exposures at pressures which were invariably or frequently fatal to goats.

Since supersaturation to the extent of about 1.25 atmospheres above normal atmospheric pressure can be borne with impunity, though a greater degree of supersaturation is risky, it seems clear that, in decompressing after prolonged exposure to high pressures, the rate of decompression should be sufficiently slow to prevent any greater excess of saturation than this in any part of the body at the end of decompression. On the other hand decompression should evidently be as rapid as is possible, consistently with safety. A pressure of 1 to 1.25 atmospheres above normal corresponds to from 2 to 2.25 times the



## A. E. BOYCOTT, G. C. C. DAMANT AND J. S. HALDANE 357

normal atmospheric pressure; but the *volume* (not the *mass*) of gas (measured at the existing pressure) which would be liberated if the whole excess of gas present in supersaturation were given off is the same whether the absolute pressure is reduced from two to one atmospheres, or from four to two, or from eight to four. Hence it seemed probable that, if it is safe to decompress suddenly from two atmospheres of absolute pressure to one, it would be equally safe to decompress from four atmospheres absolute to two, from six atmospheres absolute to three, etc. Our experiments, which are detailed below (p. 398), have shown that this is the case<sup>1</sup>. The process of desaturation can therefore be hastened very greatly by rapidly reducing the absolute pressure to half, and so arranging the rest of the decompression that the saturation in no part of the body shall ever be allowed to correspond to more than about double the air pressure. The main advantage of this plan is that the discharge of nitrogen from the tissues is from the outset of decompression increased to the greatest rate which is safe. The rate of discharge evidently depends on the difference in partial pressure of nitrogen between the venous blood and the alveolar air; and by keeping this difference at the maximum consistent with safety a great saving of time is effected. Detailed investigations have completely justified the adoption of this principle: they are described below, and comprise, besides a series of observations on animals, a number of experiments in which Lieut. Damant and Mr Catto were exposed to excess pressures up to 80 pounds, or 6·4 atmospheres of absolute pressure, in the experimental chamber and to 93½ pounds, or 7·4 atmospheres, in actual diving. The method greatly simplifies the problem of safe decompression, and gets rid of many practical difficulties, particularly in connection with deep diving. It may be conveniently referred to as the method of "stage decompression," and is so described in the sequel, though its essential peculiarity does not lie in the decompression being done in stages but in its being rapid till the absolute pressure is halved and slow afterwards.

<sup>1</sup> Whether the law holds good for pressures much exceeding six atmospheres is still doubtful, as no experimental data exist.



358 *The Prevention of Compressed-air Illness*D. *Practical measures for avoiding Compressed-air Illness.*

From the foregoing discussion the general nature of the measures needed to prevent compressed-air illness will be evident enough. The risks may best be avoided by properly calculated stage decompression, or by cutting down the period of exposure to a safe limit, or by both methods combined. In the case of work in compressed air in caissons, tunnels, etc., it is for economic reasons very undesirable to greatly reduce the period of exposure. In diving work, on the other hand, the periods of exposure are generally short in any case, and they can, without great inconvenience, be confined within limits which largely reduce the risks of compressed-air illness. Long periods of decompression are also very undesirable in diving, since changes of weather or tide or other causes may render a return to the surface necessary without any long delay in coming up, and since very prolonged stays under water are exhausting, and the diver's hands may become benumbed by cold.

As our investigations were in the first instance made with the object of securing safety from compressed-air illness in diving work, we may first consider the precautions desirable in connection with diving.

(1) *Diving work.*

The ordinary diving dress (Plate IV) consists of a copper helmet screwed to a corselet, the latter being in its turn connected water-tight to a stout water-proof dress covering every part of the body except the hands, which project through elastic cuffs. Air is supplied through a non-return valve on the helmet from a flexible pipe connected with an air-pump on a boat or ship. The air escapes through an adjustable spring valve at the side of the helmet. The arrangement is thus such that the pressure of the helmet air breathed by the diver is always at least equal to, and usually slightly greater than, the pressure of the water at the valve outlet. At a depth of 33 feet or 10 metres the diver is therefore breathing air at an excess pressure of one atmosphere, or at an absolute pressure of two atmospheres; and every additional 33 feet will add another atmosphere to the pressure. To enable the diver to sink, the dress and boots are suitably weighted. He is usually in connection with surface by a life-line containing a telephone wire, as well as by the air-pipe.



## A. E. BOYCOTT, G. C. C. DAMANT AND J. S. HALDANE 359

In descending or ascending a diver usually makes use of a rope attached to a heavy sinker at the bottom. He can thus easily regulate the rate of his ascent or descent, and take care that this rate is not so rapid as to cause any discomfort or pain in the ears owing to incomplete opening of the Eustachian tubes. A too rapid descent or ascent might cause mechanical injury followed by middle ear inflammation.

As explained above, there appears to be practically no risk of symptoms occurring from liberation of gas bubbles on rapid decompression if the pressure has not exceeded 1.25 atmospheres, corresponding to a depth of about seven fathoms or 42 feet of sea water. Up to this depth therefore no special precautions against caisson disease need be taken<sup>1</sup>. At greater depths precautions depending on the duration of exposure are evidently needed. The precautions which we have calculated to be desirable are embodied in the table given below (Appendix IV.); and the principles and experimental results on which this table is based must now be discussed.

It will be convenient to consider first the case of diving to a very great depth, and we shall take as an extreme example the case of exposure at a depth of  $35\frac{1}{2}$  fathoms (213 feet) of sea water, corresponding to an excess pressure of nearly 6.5 atmospheres, or an absolute pressure of 7.5 atmospheres.

Let us first suppose that the body of a diver is completely saturated with the nitrogen of air at this pressure, and that it is required to conduct his ascent to surface as rapidly as possible but without any risk of symptoms due to bubble formation, *i.e.* in such a way that, in accordance with the principles already laid down, the nitrogen pressure in no part of the body shall ever be more than double that of the air breathed at the same time.

The first step would obviously be to reduce the absolute pressure to about half, *i.e.* from 7.5 atmospheres absolute to 3.75 or from 6.5 atmospheres in excess to 2.75. This would be *ex hypothesi* the greatest initial drop in pressure which would be perfectly safe. The remainder of the decompression would evidently need to be conducted in such a way that the maximum partial pressure of nitrogen in any part of the body should diminish at double the rate of the fall in absolute pressure of the air. The ascent of a diver can be conveniently regulated from

<sup>1</sup> Heller, Mager and v. Schrötter recommend that at all depths decompression should be at a rate of at least 20 minutes per atmosphere. This would imply a delay of 25 minutes in coming up from 42 feet. Both common practical experience and our own experiments show that this excess of caution is quite unnecessary at small depths.



### 360 *The Prevention of Compressed-air Illness*

the surface by signalling to him to stop or come on at every ten feet as indicated on the pressure gauge attached to the pump. We may therefore divide the ascent into stages of ten feet, and the short periods occupied in the actual ascents may be neglected.

Since the depth was 213 feet, corresponding to 246 feet of water in absolute pressure, it would be safe to come up at once to a depth corresponding to 123 feet of absolute water pressure, *i.e.* to 90 feet of actual depth. Consequently the first stage would be a rapid ascent of 123 feet, and it would be necessary to wait here before the next ascent of 10 feet until the maximum partial pressure of nitrogen in the body had fallen to that of the nitrogen in air at  $2 \times (80 + 33) = 226$  feet of absolute water pressure. The difference between 246 and 226 is 20, and this is 16% of  $213 - 90 = 123$ , the difference between the original and the reduced pressure. The most slowly desaturating parts of the body will, according to our previous calculations, take 75 minutes to give off half of any excess of nitrogen which they may contain at any given air pressure; by inspection of the curve (Fig. 1) it will be seen that they will take about 19 minutes to lose 16% of the excess. Hence a delay of 19 minutes would be necessary at 90 feet before coming up to 80 feet. At 80 feet the partial pressure in the body would require to fall an amount corresponding to 20 feet, which is about  $17\frac{1}{2}\%$  of  $193 - 80 = 113$ , the new difference in relative pressure between the nitrogen in the body and in the air. This would necessitate a delay of 21 minutes before ascending to 70 feet. The further delays needed would be 23 minutes at 70 feet, 26 minutes at 60 feet, 30 minutes at 50 feet, 35 minutes at 40 feet, 42 minutes at 30 feet, 51 minutes at 20 feet, and 62 minutes at 10 feet. It would thus take 309 minutes, or more than five hours, to reach surface.

This calculation is represented graphically in Fig. 3. It will be noticed from the figure that the time required for safe decompression does not increase proportionally to the increase in depth. For instance, an increase in depth of 15 feet from 50 to 63 feet necessitates an increase of 45 minutes in the time required for safe decompression; but the same increase in depth from 198 to 213 feet only requires an increase of 15 minutes in the time of decompression.

A somewhat more rapid rate of stage decompression could probably be adopted without appreciable risk to life, but the occurrence under water of even one of the less serious decompression symptoms might be extremely unpleasant or indirectly dangerous, so that a factor which we believe to be thoroughly safe in this respect has been used in the



## A. E. BOYCOTT, G. C. C. DAMANT AND J. S. HALDANE 361

calculation. The possible occurrence of slight symptoms after surface had been reached would not, however, be a serious matter: for this reason half of the last stop at 10 feet from surface might be dispensed with, which would save half an hour. The most slowly desaturating tissues would, according to the calculation, still be only saturated to an excess pressure of 1.3 atmospheres—a safe enough limit perhaps, but leaving no great margin to spare.

Fig. 3 also shows the maximum excess of saturation with uniform decompression in the same time and in 10 hours. It will be seen that uniform decompression in about five hours would leave at the end of decompression an excess saturation within the body of 2.1 atmospheres; and even if uniform decompression were extended to ten hours the excess saturation would still exceed one atmosphere. It is also perfectly clear that uniform decompression is an unsuitable way of bringing a man out of compressed air. Where a sufficiently safe rate of uniform decompression is employed (as, for instance, with 10 hours in the case under consideration), it is only at the very end (when the nitrogen pressure inside the body becomes more than double that of the air) that there is any risk of symptoms occurring; and for the sake of safety at the end the whole process is made quite unnecessarily long. Increased safety at the end is only secured in combination with useless delay at the beginning<sup>1</sup>.

As will be seen in Part II, the results of our experiments, allowance being made for the difference between goats and men, fully confirm the foregoing mode of calculation. Not only has stage decompression in the calculated time proved safe where uniform decompression in the same total time was unsafe, but shorter periods of stage decompression than those calculated have been proved to involve risk of symptoms, increasing in gravity and frequency with the shortening of the time, though always less than the risk from uniform decompression in the same time.

If the whole body of a diver were allowed to become saturated at any great depth, it is evident that the time needed for safe decompression would be impracticably long. To reduce the time of de-

<sup>1</sup> The regulations of the Dutch Government make the following method of decompression obligatory for work in caissons, &c. The pressure is to be lowered at the rate of not more than  $\frac{1}{10}$ th of an atmosphere in 3 minutes till 3 atmospheres of excess pressure is reached: then at not more than  $\frac{1}{10}$ th of an atmosphere in 2 minutes till  $1\frac{1}{2}$  atmospheres excess pressure is reached; and finally at not more than  $\frac{1}{10}$ th of an atmosphere in  $1\frac{1}{2}$  minutes till normal pressure is reached. This method is still more unsuitable than uniform decompression, and would be very unsafe with high pressures.



### 362 *The Prevention of Compressed-air Illness*

compression to within limits practicable for divers, it is evidently necessary to greatly reduce the period of exposure to high pressure<sup>1</sup>. At great depths limitation of the exposure is also necessary in order to avoid toxic effects from the high pressure of oxygen (see p. 371). Calculation of the mode and period of decompression required after a limited exposure to pressure is a somewhat complicated matter, but the principles already laid down render it quite possible.

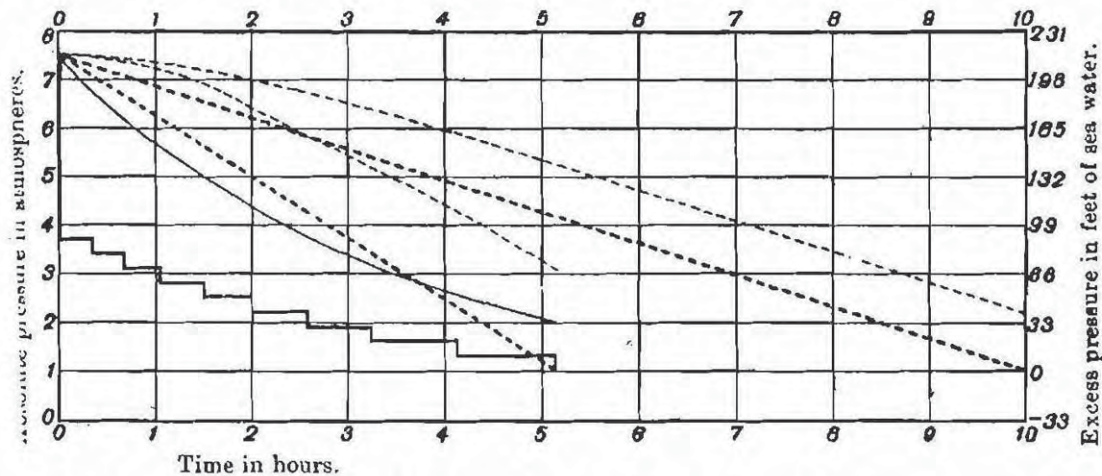

Fig. 3. Theoretical ascents of a diver after a prolonged stay at 213 feet of sea water. Stage decompression in 309 minutes compared with uniform decompressions in 309 minutes and in 10 hours. Continuous lines = stage decompression; interrupted lines = uniform decompression. Thick lines = air pressure; thin lines = saturation with atmospheric nitrogen in parts of the body which half saturate in 75 minutes.

When a diver goes down for a very short time, we have to take into consideration not only the time which he spends at the maximum pressure on the bottom but also the time occupied in the descent and the ascent. During the descent he is all the time saturating himself with nitrogen, and during most of the ascent he may be doing so also. Calculation will show that, if he descends and ascends at a uniform rate, the time spent in this process will be nearly equivalent, as regards the saturation of the body with nitrogen, to half the same time spent at the maximum depth. It is therefore clear that in deep diving the diver should descend as rapidly as is practicable, and should also ascend at once, on completion of his work, as far as he safely can. The rate of descent may be limited either by pain in the ears or by an air supply insufficient to keep the upper part of the dress full of air.

<sup>1</sup> This was fully realised by Catsaras who recommended a stay on the bottom of only 1 minute at 30 fathoms.



## A. E. BOYCOTT, G. C. C. DAMANT AND J. S. HALDANE 363

Both these causes are avoidable, and an experienced diver, with his Eustachian tubes well opened and a proper supply of air, can get to an excess pressure of six atmospheres (198 feet) in two minutes. This time was found sufficient in experimental dives up to 210 feet made by Lieut. Damant and Mr Catto (Appendix II). The recommendation commonly made that the rate of both ascent and descent should be slow is evidently quite unsound. A man who spent half an hour in descending to 30 fathoms, and an equal time in ascending at a uniform rate, would run a considerable risk of perishing on his return to the surface.

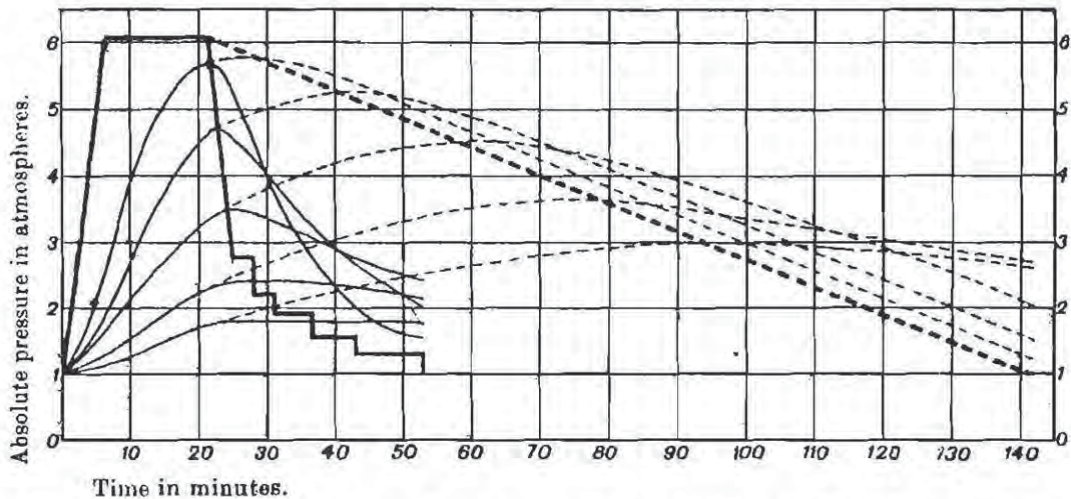

Fig. 4. Desaturation during stage decompression in 32 minutes and uniform decompression in 2 hours, after exposure for 15 minutes at 75 lbs. pressure with compression in 6 minutes. Thick lines=air pressure: continuous lines=stage decompression: dotted lines=uniform decompression. The curves from above downwards represent respectively the variations in saturation with nitrogen of parts of the body which half saturate in 5, 10, 20, 40, and 75 minutes.

In order to illustrate the method by which we have calculated safe modes of ascent in the minimum period of time we may take as an example the case of exposure for 15 minutes to a pressure of 75 pounds (6.1 atmospheres absolute or 28 fathoms = 168 feet). Many of our experiments on goats were made with this pressure and exposure. It took about six minutes to raise the pressure in the experimental chamber to 75 pounds, so that the total virtual exposure till decompression began was about 18 minutes. Fig. 4 shows graphically the variations of pressure during this period: also the calculated partial pressure of nitrogen in different parts of the body, as compared with the nitrogen pressure in the air. The first stage was from 6.1 to 2.8



364 *The Prevention of Compressed-air Illness*

atmospheres absolute (corresponding to an ascent in sea water from 168 to 60 feet) and occupied four minutes. The subsequent stoppages were:—

2	minutes	at	2.8	atmospheres	(60	feet	of	sea	water),
3	"		2.2	"	(40	"			),
5	"		1.9	"	(30	"			),
7	"		1.6	"	(20	"			),
10	"		1.3	"	(10	"			).

It will be seen from the figure that this rate of decompression was slightly faster than what was calculated above to be desirable. At the end of decompression the nitrogen pressure in those parts of the body which became half saturated in about 20 minutes under pressure would be equivalent to that of air at about 1.4 atmospheres, or 20.6 pounds per square inch. If the circulation in one of these parts were less vigorous during decompression than during exposure to the high pressure, it might well be that the nitrogen pressure in this part at the end of decompression would be higher than corresponded to the calculation. As a matter of fact minor symptoms ("bends") were observed five times in 34 decompressions of 18 goats, although no serious effects occurred. We concluded that the period of virtual exposure (18 minutes) was slightly longer than is desirable with stage decompression in 31 minutes: in the table below (p. 442) the limit has been set down at 15 minutes.

Fig. 5 shows the calculated nitrogen pressure in different parts of the body during uniform decompression in 31 minutes after the same exposure at 75 pounds. It will be noticed that at the end of decompression there is a dangerous excess of saturation in all parts of the body except those which half saturate in less than about seven or eight minutes, and that this supersaturation corresponds to an excess pressure of as much as 2.1 atmospheres of air. The goats used for the stage decompression experiments were on alternate occasions subjected to uniform decompression in the same time and with the same exposure. The result was that, in 36 decompressions, one died, two were paralysed, one had indefinite general symptoms of a severe character, and in 11 other cases "bends" occurred, besides two doubtful cases. This was entirely in accord with what the calculation would lead us to expect; and uniform decompression in 31 minutes is evidently dangerous under the conditions given.

It might be supposed that safety would be secured by extending to



A. E. BOYCOTT, G. C. C. DAMANT AND J. S. HALDANE 365

a moderate degree the length of uniform decompression. It must be remembered however that the more the duration of uniform decompression is extended, the longer is the period during which the body is exposed to high pressure. Fig. 4 shows the calculated effects of uniform decompression extended to two hours. Although the quickly saturating parts of the body are desaturating during the greater part of the decompression, the slowly saturating parts are, on the other hand, becoming more and more saturated, so that at the end of decompression the parts which half saturate in from 40 to 75 minutes are saturated to an excess pressure of about 1.7 atmospheres, although at the beginning of decompression they were only saturated to from 0.7 to 1.3 atmospheres and could consequently have given no trouble.

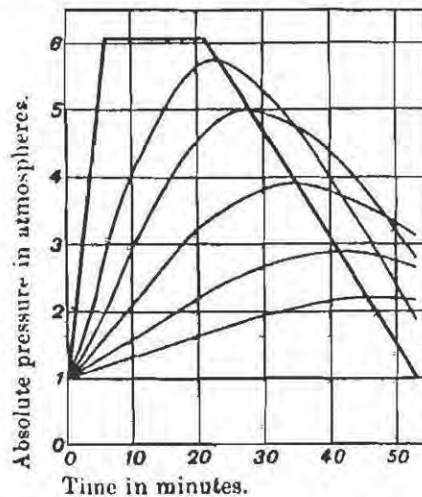

Fig. 5. Desaturation during uniform decompression in 32 minutes after exposure for 15 minutes at 75 lbs. pressure with compression in 6 minutes. Thick line = air pressure. The curves from above downwards represent respectively the variations in saturation with nitrogen of parts of the body which half saturate in 5, 10, 20, 40 and 75 minutes.

Very prolonged uniform decompressions are extremely tedious, and it seemed scarcely worth while to make any extensive series of such experiments. We found however that out of 12 goats uniformly decompressed in 90 minutes after 18 minutes virtual exposure at 75 pounds (6.1 atmospheres of absolute pressure) three developed symptoms of bends after decompression. The proportion of illnesses was thus greater than with stage decompression in a third of the time. With men the results would certainly be much worse, and we calculate that for a man, after the same exposure, several hours would be needed for uniform decompression in order to escape all risk of



### 366 *The Prevention of Compressed-air Illness*

symptoms occurring. The time would in fact require to be nearly as long as if the body had been completely saturated at the maximum pressure.

With very short exposures to high pressure, rapid decompression is probably safer than uniform decompression at a moderate rate. There is a considerable human experience on this point: divers working at great depths would seem to consider it fairly safe to go rapidly to the bottom at a depth of 160 or 180 feet and return equally rapidly, provided the time spent on the bottom does not exceed six or eight minutes and provided also that the dives are not repeated at short intervals. It is reported of the skilled Greek divers of the Mediterranean that, in case their gear becomes entangled on the bottom, they will cut their air-pipe and line and blow themselves up to the surface in less than a minute from a depth of 30 fathoms or the like rather than stop more than about ten minutes on the bottom. Our experiments on goats are in accordance with this practice. We found that no symptoms were produced by sudden decompression in less than a minute after virtual exposures at 75 pounds up to four minutes, and even in some trials up to six minutes (see below, p. 394).

With exposures exceeding a very few minutes, or such brief exposures frequently repeated, so that during the intervals the body has not time to become desaturated, we have little doubt that slow and uniform decompression—the slower the better—is at any rate preferable to sudden decompression. Uniform decompression must however be extremely slow to make it entirely free from risk of death or very serious symptoms, and the time required is so great that this method seems to us quite impracticable in connection with diving work. There appears to be very little human experience of slow uniform decompression. Divers usually come up in a few minutes at most, and even half an hour spent in the ascent would appear to be quite exceptional. Almost the only definite observations are those of Hill and Greenwood, who recently experimented on themselves at very high pressures. Fig. 6 shows the variations of pressure and the calculated saturations of different parts of the body during the experiment in which Greenwood went to a pressure of 91 pounds (7.1 atmospheres absolute). This experiment appears to have been a very risky one. After decompression he had bends in both arms, and Hill also had symptoms pointing towards blockage of vessels in the subcutaneous fat after similar experiences at 75 pounds pressure.

In Appendix IV two tables are given for the safe decompression of



## A. E. BOYCOTT, G. C. C. DAMANT AND J. S. HALDANE 367

divers after exposure for varying periods of time at different depths. These tables are the same as are now in use for divers in the Royal Navy, on the recommendation of the Committee on Deep Diving. In Table I the period of virtual exposure is so limited that the diver can return to surface by stages in half an hour or less. It will be noted that the maximum periods of exposure are from the time of leaving surface, so that there should be no chance of increased danger from undue delay in descending. The stoppages during the ascent are so calculated that, until surface is nearly reached, the excess of nitrogen pressure in any part of the body should never be more than double the nitrogen pressure of the air breathed, and not more

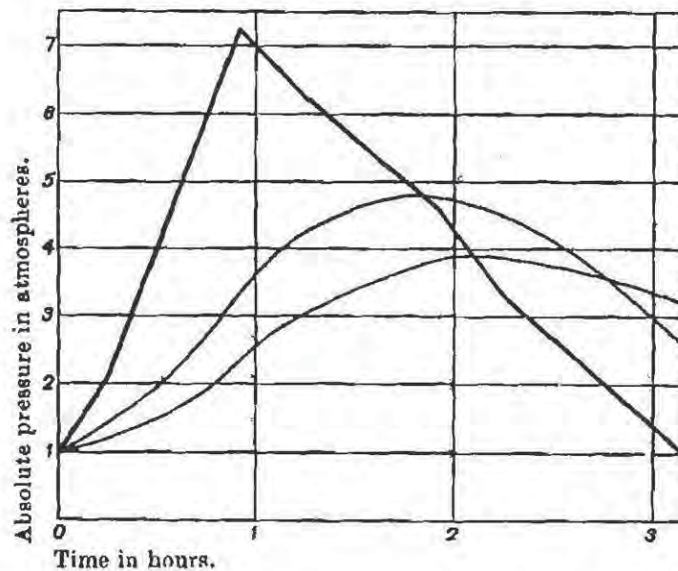

Fig. 6. Showing calculated variations in saturation with nitrogen during Dr Greenwood's experiment on himself. Thick line=air pressure: the two curves from above downwards represent respectively the variations in saturation with nitrogen of parts of the body which half-saturate in 40 and 75 minutes.

than two and a quarter times this pressure when surface is reached. The only case in which these limits are allowed to be slightly exceeded is with short exposures in comparatively shallow water. This slight excess is, however, only in parts of the body which saturate and desaturate very rapidly, and, as already explained, give rise to no danger. As an additional safeguard the diver is directed to keep his arms and legs constantly moving during each stoppage, so as to increase the rate of circulation and guard against the chance of the rate of desaturation during his ascent being proportionally less than the rate of saturation during his stay on the bottom while he was doing work.



### 368 *The Prevention of Compressed-air Illness*

The second table provides for the case of exceptionally long stays under water. A diver may be delayed by his air-pipe or life-line being fouled, or by other exceptional circumstances, against which it is necessary to provide. Where the fouling has been complicated by the action of tide the delay on the bottom has occasionally amounted to several hours, until the tide has slackened or turned. If the diver is at a great depth the calculated time required for safe decompression after so prolonged a stay is very long. On the other hand the dangers from cold and exhaustion have to be considered, and the difficulties caused by a strong tide during the diver's ascent. In view of these difficulties the time allowed for decompression after very prolonged exposures is somewhat curtailed, but not so much as to permit of risk of more serious symptoms than "bends," in so far as experiments on animals, and human experience, render it possible to calculate. In the case of men of exceptionally heavy build, and inclined to obesity, the time allowed after very prolonged exposures ought to be increased by about a third, although such men, particularly if over about 45 years of age, ought not to expose themselves to the risk of a prolonged stay in very deep water.

It might appear as if the rate of stage decompression recommended after prolonged exposures was slower than is actually required. A very unfortunate accident which occurred recently has shown only too clearly that this is not the case. In connection with the work of raising a torpedo boat which had sunk in 25 fathoms (150 feet or 46 metres) several divers were employed. They were working in 20 minute spells, and returning to surface by stages in 32 minutes, in accordance with the first table, which was the only one then in use. No symptoms of any kind were observed after the divers' return to surface under these conditions, nor have any symptoms ever been observed hitherto among divers working according to the table. One of the divers, however, became fouled in a very exceptional manner. His life-line was fixed in one direction over a spar or rope belonging to the sunk vessel, and his air-pipe was fixed in the other direction. He was thus prevented from going to free either his air-pipe or life-line. A second diver at once went down, but was unable to free him owing to the drag caused by the tide; and it was only after two and a half hours, when the tide had slackened, that he got free. He was then brought up by stages under the direction of Staff Surgeon Rees and Lieut. Damant. For the decompression two and a half hours were allowed, which we then believed would be a sufficient time in case of a diver being badly fouled



## A. E. BOYCOTT, G. C. C. DAMANT AND J. S. HALDANE 369

at 25 fathoms. The diver was, however, a man of heavy build with much fat in his body, and aged 49. Owing to his exhausted condition he did not come up on the ordinary rope, but had to be pulled up, hanging motionless on the life-line during the long stoppages. On reaching surface he was very exhausted and could hardly have been safely kept longer in the water. He had no paralysis or other definite symptoms of caisson disease. A bed was arranged for him on deck, and hot bottles &c. applied. After a time he complained of some pain in the legs, but this soon subsided; and as he seemed much better in the morning he was removed to hospital, since there was no suitable accommodation for him on the gun-boat where he was. The moving made him worse, and he gradually became restless and delirious in spite of administration of oxygen at intervals, showed signs of cardiac failure, and died somewhat suddenly about 24 hours after he had been brought up. At the post-mortem examination 12 hours later a moderate number of bubbles were found in the right side of the heart, the veins of the liver and intestines, while scattered bubbles were present in vessels elsewhere, including the coronary vessels, though none were seen in the vessels of the brain. The mesenteric fat, which was very abundant, was in places distended with small bubbles. There was about an inch of subcutaneous fat over the trunk, but no bubbles were seen in this layer. There seemed no reason to doubt that death was largely due to the bubbles, although the more usual symptoms of caisson disease were absent. There were no signs of pneumonia.

This is the only known case of prolonged exposure of a man to such a high excess pressure as four and a half atmospheres; and although his age, heavy build, and exhausted condition combined to make the circumstances very unfavourable, the fact of his death shows that the long decompression periods recommended in the second table after prolonged exposures are none too long, even for a man of ordinary build. Every precaution should be taken to guard against such long exposures at high pressures.

A diver has often to descend twice or oftener at short intervals. At the beginning of the second descent the more slowly desaturating parts of the body will not have had time to lose their excess of nitrogen, and consequently they will be more highly saturated at the end of the second descent than would otherwise have been the case. This will be clear from a study of Figs. 2 or 3. To meet the increased risk in decompression it is desirable, in calculating the proper stoppages, to add together the two periods of exposure, and adopt the corresponding rate



### 370 *The Prevention of Compressed-air Illness*

of decompression shown in the tables. For the first half of the stoppages this is not necessary, but for the second half, including the longer stoppages needed to meet the case of the more slowly desaturating parts, the rule should be carried out. The increasing danger after successive short dives by pearl divers, &c. without any precautions in decompression is notorious. This danger does not mount up to the same extent with stage decompression, but nevertheless exists. As the interval between successive dives increases the added danger on decompression diminishes. With an hour's interval the extra precautions might be halved, and with two or three hours' interval they might be omitted.

It may be remarked that the precautions recommended in the tables are greatly in excess of those which have hitherto been commonly employed in either diving work, or work in caissons, tunnels, &c. We have endeavoured to leave a clear margin beyond everything which either human experience or experiments on animals, or calculation, has shown to be risky. In connection with diving, the practice hitherto recommended in the British and other navies has been that the diver should both descend and ascend at a uniform slow rate. By abolishing the slow descent and ascent, and substituting stage decompression, it has been possible to combine greater safety with a clear saving of time under water for a given working period on the bottom. Where the air supply to the diver is managed in accordance with the recommendations of the Diving Committee there is also very greatly increased working efficiency in deep water. For a discussion of the air supply to divers, and many other practical points relating to diving, we must refer to the Committee's Report; and to the "Diving Manual," which has just been re-written and issued to the Royal Navy.

A possible complication to which we have not hitherto referred in connection with compressed-air illness arises from the fact that at very high pressures of air the partial pressure of oxygen begins to be so high as to be capable of producing serious effects. Paul Bert discovered that oxygen at a partial pressure exceeding about three atmospheres (corresponding to 14.3 atmospheres of air) causes animals to go into convulsions and die, even a short exposure being often fatal. More recently, Lorrain Smith, who experimented on mice, and whose results have been confirmed and extended by Hill and Macleod, showed that oxygen at high pressure acts on the lungs, producing pneumonia<sup>1</sup>. He

<sup>1</sup> Lorrain Smith, *Journ. of Physiology*, vol. xxiv., p. 19, 1899; Hill and Macleod, *Journ. of Hygiene*, vol. iii., p. 401, 1903.



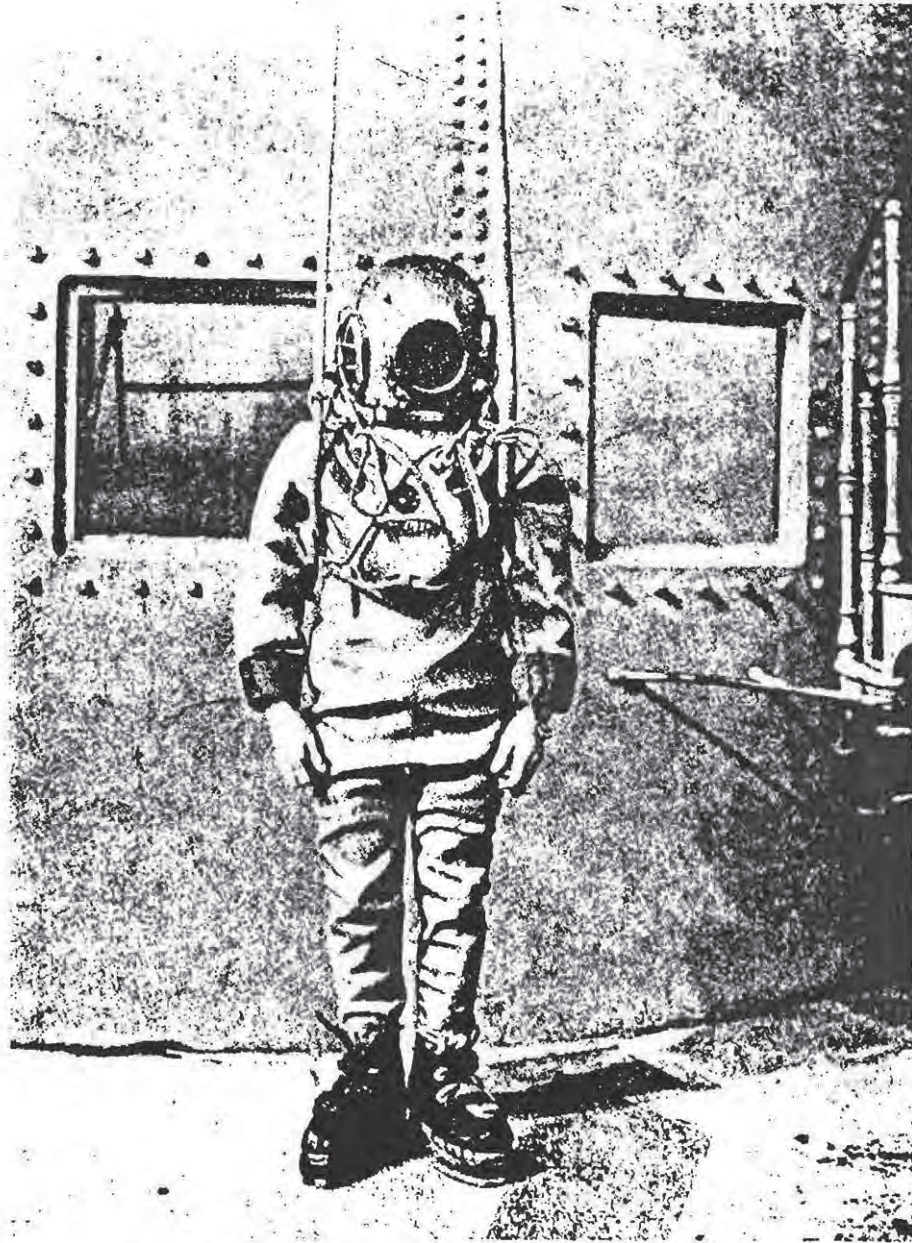

Diving dress, front view, with air-pipe and life-line, which are connected with the helmet behind.



## A. E. BOYCOTT, G. C. C. DAMANT AND J. S. HALDANE 371

found that fatal pneumonia may be produced after four days' exposure to an oxygen pressure of as little as 75 % of an atmosphere, corresponding to air at an absolute pressure of 3.6 atmospheres (88 feet of sea water). At a pressure of about 1.25 atmospheres of oxygen (6 atmospheres of air, or 165 feet of water) death from pneumonia was produced in about 48 hours. At about 1.8 atmospheres of oxygen (eight and a half atmospheres of air, or 250 feet of water), marked symptoms usually occurred in about 12 hours, and death in 20 hours, though in one case death followed in seven hours. At about 2.8 atmospheres of oxygen (13.3 atmospheres of air, or 406 feet of water) marked symptoms were observed in about three hours, and death in nine hours.

The steel chamber at the Lister Institute was not made to withstand such high pressures as would produce within a short time symptoms of oxygen poisoning if air alone was pumped into the chamber. We have, however, made a few observations in the chamber when the oxygen pressure of the air breathed was raised by other means. In one experiment seven goats were placed in the chamber, and the oxygen pressure raised by opening three large cylinders of oxygen, and at the same time pumping in air to 81 pounds pressure. The total oxygen pressure was thus raised to 2.3 atmospheres, corresponding to a depth of 55 fathoms, or 330 feet, or 100 metres. After three hours one animal had died of pneumonia in the chamber, and most of the others seemed more or less affected, though they rapidly recovered on decompression<sup>1</sup>. We also tried on ourselves the effects of breathing nearly pure oxygen from a bag while we were in the chamber at an absolute pressure of two atmospheres; but we could not detect any effects after a few minutes with an oxygen pressure of 1.7 atmospheres, corresponding to about 40 fathoms (240 feet or 73 metres). In a number of goats which were exposed to 75 pounds' pressure (168 feet or 51 metres of water) for three hours, no symptoms indicative of oxygen poisoning were observed.

To judge from these data there is no immediate risk to a diver from oxygen poisoning at depths up to 40, or perhaps 50 fathoms (73 to 90 metres) if ordinary air is breathed, provided the stay is not long. With stage decompression the diver could rapidly return to a perfectly safe oxygen pressure; but, as already remarked, we do not yet know with

<sup>1</sup> One animal showed bends after decompression which was effected in 133 minutes by stages. After exposure at +75 lbs. for 3 hours in air this decompression gave 2 bends in 14 goats. There is therefore no evidence that the exposure to high pressure oxygen increased the susceptibility to caisson disease.



## 372 *The Prevention of Compressed-air Illness*

certainly whether it is perfectly safe to rapidly reduce the pressure to half after exposure to such very high air pressures.

### (2) *Work in caissons, tunnels, and diving bells.*

In connection with various kinds of engineering work under water, or in soft water-bearing strata, compressed air is commonly used for keeping water out of the working place and preventing collapses. The men have thus to work continuously in compressed air.

In tunnels or 'tubes' through soft water-bearing strata, where a steel lining has to be erected to keep water out and resist pressure, the working face, or blind end of the tunnel under construction, is kept free of water by the air pressure with the help of a circular shield with a cutting edge which is advanced as each section of steel lining is erected into position. The soil is excavated by hand labour, and passed out on trucks through an air-lock.

In constructing foundations for the piers of bridges over rivers, caissons are employed. A caisson is a steel tube, which ultimately forms the lining of the pier, and is shaped accordingly. Near the lower end there is a steel diaphragm, forming a working chamber. An inner steel tube passes through this diaphragm, and serves for ingress and egress, and for passing up the material excavated. At the top of this inner tube there are air-locks for allowing the passage of men and material without escape of the compressed air contained in the working chamber. The latter is kept free from water by the air pressure, and the excess of air escapes beneath the cutting edge of the caisson. When a secure foundation for the pier has been reached this chamber is filled up with concrete. In constructing mine shafts through soft water-bearing strata the same principle may be employed. For work of a simpler kind on river or harbour bottoms diving bells are often used, the bell being simply lowered to the bottom at any required place, so that the men can work on the area covered by it and are kept dry by the air pressure.

The circumstances connected with work in compressed air in caissons, tunnels, &c., differ in certain respects from those associated with diving work.

In the first place the duration of exposure is far longer. A caisson or tunnel worker is usually in compressed air for six or eight hours daily, or even longer. The conditions of the work render any great limitation of the periods of exposure very difficult and expensive.



## A. E. BOYCOTT, G. C. C. DAMANT AND J. S. HALDANE 373

Usually, however, the workman comes out for meals at intervals of about three hours.

A second difference is that the very high pressures to which a diver may have to go are not needed in caisson or tunnel work. An excess pressure of about  $3\frac{1}{4}$  atmospheres, or 48 lbs., is, we believe, the extreme limit hitherto employed; and usually the excess pressure does not exceed about two atmospheres or 30 lbs. Decompression seems to be usually effected in 10 to 20 minutes, or even, with the lower pressures, in three to five minutes.

With properly arranged air-locks for men and material there should be no need for hurry in coming out; and undue hurry is specially undesirable if the workman leaves the works at once, since he would be liable to develop symptoms when he was so far away that he could not be readily recompressed. To obviate this risk as far as possible, it is customary to endeavour to keep men for half to one hour on the works after they come out; and with the usual rates of uniform decompression this precaution is very necessary. Evidently, however, it is greatly preferable to prevent all practical risks of serious symptoms.

In order to attain this end stage decompression as recommended for divers in the tables in Appendix IV may be employed. An accurate and easily read pressure gauge, visible from both inside and outside the air-lock, is of course essential; and a reliable man should be in charge of the tap. As a further control it would be desirable to have an automatic graphic record of the variations of pressure each time the lock for men is used. As any very sudden drop in pressure might cause mechanical injury, the outlet tap should be so arranged as to prevent decompression at a maximum initial rate of more than about one pound in five seconds<sup>1</sup>. With this arrangement and an ordinary tap, the rate of decompression would diminish considerably as the pressure fell, and the proper point for interrupting the decompression could be accurately reached.

The tables in Appendix IV have been calculated with special regard to the comparatively short periods of exposure to pressure in diving work;

<sup>1</sup> The delivery of the inlet tap should also be restricted, and the man in charge should have strict directions to take care that the rate of admission or discharge of air does not cause pain in the ears, &c. of any of the men in the lock. To avoid pain a very slow rate of air admission may sometimes be needed, but with practice a rise of pressure of one atmosphere per minute is often not too much, so that any definite rule, limiting the rate to much less than this, seems scarcely desirable.



### 374 *The Prevention of Compressed-air Illness*

and the stoppages recommended during the divers' ascent after exceptionally long periods of exposure are somewhat shorter than would be desirable apart from the risks entailed by the long stay under water. In the case of caisson and tunnel workers, on the other hand, it is only in exceptional cases that the exposure to pressure lasts less than three hours; and usually the exposure during the day lasts at least six hours.

With such long exposures and only moderate pressures the calculated theoretical rate of safe decompression after the first rapid stage is nearly uniform; and the rules for decompression may be greatly simplified by adopting uniform slow decompression or uniform stages<sup>1</sup>.

The following table shows the rate of uniform slow decompression calculated to be safe after the initial diminution of absolute pressure in the proportion of 2 : 1. Suppose, for instance, that men were working at a pressure of 24 pounds in 3-hour spells, with an hour's interval between for a meal. In coming out they would be rapidly decompressed to an absolute pressure of  $\frac{24 + 15}{2} = 19.5$  pounds or 4.5 pounds of excess pressure. After the first 3-hour spell of work the slow decompression would be at the rate of one pound in three minutes, or  $3 \times 4.5 = 13\frac{1}{2}$  minutes in all. After the second spell the rate would be one pound in five minutes, corresponding to  $22\frac{1}{2}$  minutes in all. If they stayed for the whole period in the compressed air the rate of slow decompression would be one pound in seven minutes corresponding to  $31\frac{1}{2}$  minutes in all. To take another example, if the work were at 40 pounds excess pressure the men could be rapidly decompressed to  $\frac{40 + 15}{2} = 27\frac{1}{2}$  pounds of absolute pressure, or  $12\frac{1}{2}$  pounds excess pressure. After a first 3-hour spell of work the period of slow decompression would therefore be  $12\frac{1}{2} \times 7 = 87$  minutes; after a second spell (with an interval of 30 or 45 minutes outside the lock)  $12\frac{1}{2} \times 8 = 100$  minutes; and after a continuous exposure of six or seven hours,  $12\frac{1}{2} \times 9 = 112$  minutes<sup>2</sup>.

<sup>1</sup> With the lock air-tight, and no ventilation, uniform decompression at any required rate could be easily secured by means of a reducing valve on an outlet, with a graduated tap beyond it, the arrangement being similar to the reducing valve and tap usually connected to a cylinder of compressed oxygen or gas used for limelight. If the delay in the lock is so long that ventilation is required, or if ventilation is needed in order to compensate for accidental leakage, it would be best to have an adjustable safety valve on the outlet, and adjust this by one pound at a time at the proper intervals.

<sup>2</sup> We have some doubt as to whether the increased slowness of decompression after very long exposures would be altogether sufficient to meet the increased tendency to slight symptoms ("bends"). These are, however, of minor importance if all serious symptoms



A. E. BOYCOTT, G. C. C. DAMANT AND J. S. HALDANE 375

TABLE I.

*Table showing rate of decompression in caisson and tunnel work.*

Working pressure in pounds per square inch	Number of minutes for each pound of decompression after the first rapid stage		
	After first three hours' exposure	After second or third three hours' exposure, following an interval for a meal	After six hours or more of continuous exposure
18—20 pounds	2	3	5
21—24 „	3	5	7
25—29 „	5	7	8
30—34 „	6	7	9
35—39 „	7	8	9
40—45 „	7	8	9

It will be evident from the last example that in order to avoid waste of time in the lock it would be preferable with pressures exceeding about 25 pounds to keep the men under pressure continuously during each shift. Thus with two 3-hour spells of work separated by a decompression, the time spent in the lock would be  $87 + 100 = 187$  minutes; whereas if the meal were taken in the compressed air, the two 3-hour spells would only imply 112 minutes in the lock.

With working pressures exceeding about 25 pounds the air-lock should be roomy and comfortably arranged, and large enough to take the whole of a shift of men. It should be provided with an electric heater, telephone, and if possible some sort of lavatory accommodation.

With pressures up to 45 pounds, or four atmospheres of absolute pressure, there appears to be no substantial objection to keeping men for six hours, or even more, continuously under pressure, provided that the mode of decompression is thoroughly safe. With pressures exceeding about 40 pounds, the practice has hitherto been to limit the exposure to about one hour, and employ rates of decompression which are dangerously rapid. This plan implies greatly increased risk and expense, since for the accomplishment of the work the number of decompressions is six times as great, and the men are idle most of the day. The actual increase in risk must be very great.

In tunnel work, or any other kind of work where plenty of space is available, there would be great advantage in providing a large air-lock, or section of tunnel, in which the pressure was constantly maintained at a little less than half the absolute pressure in the working section.

are prevented. We also think that with long shifts, exceeding a total of about 3 hours, still slower decompression would be needed for any men inclined to obesity. Such men should, therefore, be excluded in the medical examination which all men working in air at high pressures ought previously to undergo.



### 376 *The Prevention of Compressed-air Illness*

The men could then pass rapidly (in two or three minutes) from the working section into this intermediate lock or section, where they could take their meals, wash, and change their clothes. After a sufficient delay (dependent on the working pressure) they could then pass out rapidly. If, for instance, the working section was at a pressure of 30 pounds, the intermediate or "purgatory" lock could be kept at an absolute pressure of about  $\frac{30 + 15}{2.2} = 20.5$  lbs., or  $5\frac{1}{2}$  pounds of excess pressure<sup>1</sup>. At the end of the day's work there would be a delay of about 50 minutes in this large lock, during which the men could wash and change, or take a meal. With this plan all delays during actual decompression would be obviated, so that ingress and egress would be free at all times, and the men could use the locks employed for material. For persons going in for only short periods the delay in the "purgatory" lock could be curtailed in accordance with the tables in Appendix IV. The movement of the men while employed in washing, changing clothes, &c. would hasten the process of desaturation, and this would be a further advantage.

In any case where it was specially desirable to reduce the period of delay in the air-lock to a minimum, recourse could of course be had to breathing oxygen during the period of slow decompression. This would about double the rate of desaturation, and therefore halve the delay. The oxygen could be breathed from a bag, and the CO<sub>2</sub> absorbed by a purifier, so that very little oxygen would be needed. By so arranging the mouthpiece that part of the expired CO<sub>2</sub> was rebreathed, and the respiration and circulation thus stimulated, a still better result would be attained.

The results of some of our experiments seem to indicate that even the very slow rate of stage decompression which has been recommended above would be insufficient to completely obviate the risk of "bends" occurring after prolonged exposure. The rate of saturation and desaturation of some of the tissues which are the seat of "bends" is possibly slower than we have provisionally assumed. What we have aimed at is to completely obviate the risk of any serious symptom, while at the same time reducing the chances of "bends" to a minimum.

<sup>1</sup> A comparatively rapid fall in absolute pressure in the proportion of 2.2 to 1 is within practically safe limits, particularly if the previous period of continued exposure has not exceeded three or four hours.



A. E. BOYCOTT, G. C. C. DAMANT AND J. S. HALDANE 377

## PART II. EXPERIMENTAL.

I. *Apparatus.*

We owe the large pressure chamber (Plate V) in which both human and animal experiments were conducted to the generosity of Dr Ludwig Mond, F.R.S. It is a short segment of a boiler of  $\frac{3}{8}$  inch plate resting on its side; the ends are slightly dished steel plates  $\frac{1}{2}$  inch thick. Inside it measures  $7\frac{1}{2}$  feet long by 7 feet wide and high, and has a capacity of 9500 litres (336 cubic feet). It is thus large enough to hold 3 or 4 persons comfortable and can be used for animal experiments lasting several hours without the necessity of ventilating. There are two doors: one, an oval manhole (24 × 15 inches), is easily removed and is in common use; at the other end is a large rectangular plate (28 × 24 inches) which can be unbolted for the admission of bulky articles. There are a number of spring and simple valves; the largest is in the floor of the chamber and serves also as a drain; when fully opened it reduces the pressure from 100 lbs. to atmospheric pressure in rather less than a minute. Besides this there are four spring and three simple valves so arranged that the pressure can be completely controlled either from inside or outside. The front is also furnished with an air-lock, by means of which small articles can be passed in or out of the chamber during an experiment. Three windows are provided of stout glass; as a precaution for safety these are fitted with an arrangement whereby the breaking of the glass releases a solid metal rubber-faced plug which falls into the hole. Wiring for lights, a telephone, electric heaters and a motor to drive a fan, kymograph, &c., is introduced through fibre plugs.

The pressure is raised or reduced by a simple compressor driven by a gas engine. While this has proved quite satisfactory for negative pressure experiments, the rate at which the pressure can be raised by its means is only about 2 lbs. per minute. This was a serious obstacle to the examination of the effects of exposure to high pressures of short duration. Accordingly after the preliminary experiments, a multitubular compressed air reservoir was placed at our disposal by the Admiralty. This reservoir has a capacity of about 22 cubic feet, and by charging it to about 70 atmospheres with a two-stage liquid-air compressor and also another steel bottle to 180 atmospheres we were enabled to suddenly blow the contents into the chamber and so reach a pressure of 60 lbs. in



## 378 *The Prevention of Compressed-air Illness*

4 minutes, and 75 lbs. in  $5\frac{1}{2}$ — $6\frac{1}{2}$  minutes according to the temperature. The pressure is indicated by two Schaffer spring gauges (one of which is visible from within the chamber) for positive pressures, and one spring gauge outside and a mercurial barometer inside for negative pressures. The spring gauges show a lag of nearly 2 lbs. up to about half an atmosphere, but above one atmosphere they are concordant and, as far as could be ascertained, correct.

The chamber and accessory apparatus have now been frequently used during eighteen months for experiments at pressures varying from 100 lbs. above to 8 lbs. below atmospheric pressure, and have been found very satisfactory and convenient.

### 2. *Choice of experimental animals.*

A few experiments were made with rabbits, guinea-pigs, rats, and mice, but for regular use goats were selected chiefly because they were the largest animals which could be conveniently dealt with and which could be obtained in considerable numbers. The questions under consideration depend in a very fundamental way upon the rate of circulation in the animal under investigation. Among the ordinary mammals this must vary with the rate of the respiratory exchange per unit of body weight and is therefore proportional to the ratio between body surface and body weight. The susceptibility of any animal to caisson disease after sufficiently long exposure to compressed air must depend in the main upon the rate at which its respiration and circulation removes the excess of dissolved nitrogen on decompression.

Not only is this excess removed more rapidly in small animals, so that the time during which bubbles might be formed is correspondingly less, but, as already pointed out, there is every reason to believe that the time during which the venous blood remains in a supersaturated state during each round of the circulation largely determines the formation of bubbles. This time is so short in small animals that no bubbles at all are formed, in spite of the temporary existence of very great supersaturation in the blood and tissues. The susceptibility of any species of animal then varies enormously with the size. Thus a mouse, weighing 20 grammes and with a  $\text{CO}_2$  production of about 8 grammes per kilo per hour, is much less susceptible than a goat, weighing 20,000 grammes and producing about 0.8 gramme  $\text{CO}_2$ . We have indeed failed to produce any symptoms at all in mice on decompression in less than a minute after one hour's exposure at 75 lbs., an experience



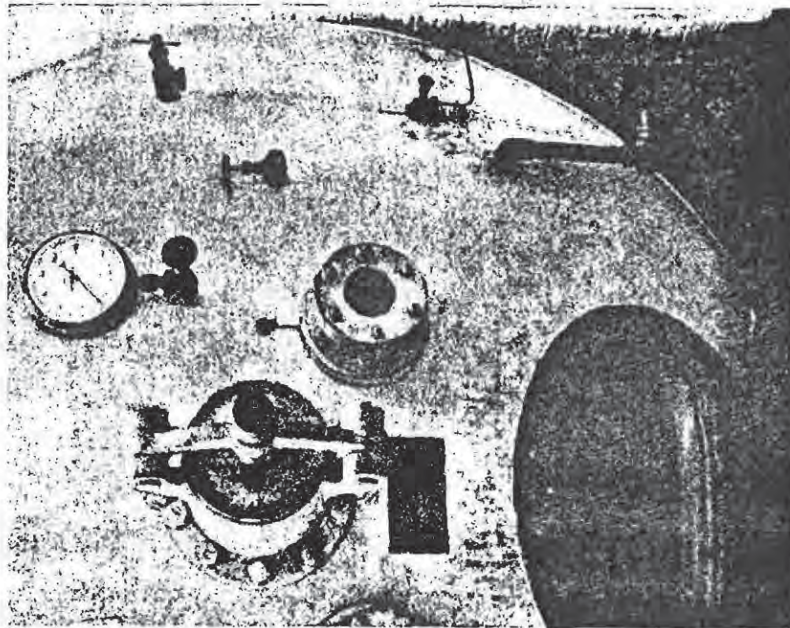

The steel chamber at the Lister Institute. Front end, showing the manhole for entering, the small air-lock for passing food, &c. into the chamber, an inspection window, a pressure gauge, and several valves, &c.

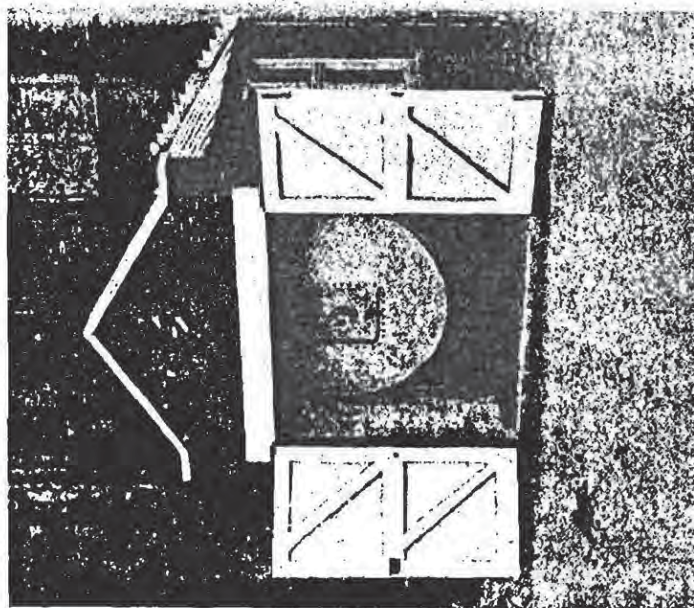

The steel chamber at the Lister Institute. View from outside, showing the back end of the chamber, with the large door and one inspection window.



## A. E. BOYCOTT, G. C. C. DAMANT AND J. S. HALDANE 379

invariably fatal to goats. In the same way dogs, with a respiratory exchange of some 1.3 gms. CO<sub>2</sub> per kilo per hour, are much less susceptible than men with an exchange of about 0.5 gms. Thus Heller, Mager and v. Schrötter observed no symptoms in dogs<sup>1</sup> on sudden decompression from any pressure less than about 60 lbs., while abundant illnesses are caused in man, and for the matter of that in goats also, by inappropriate release from 30 lbs. pressure. It therefore appears clear that it is necessary to use large animals for experiments which are designed to illustrate the incidence of caisson disease in man. Indeed the quantitative factor by which the results obtained on quite small animals might be translated into human experience is so large as to become qualitative in character.

Since pressures of some 100 lbs. or more are required to produce symptoms in a reasonable proportion of small animals, the use of animals such as goats is also very desirable in order to keep as far away as possible from the point at which the partial pressure of oxygen is high enough to cause toxic effects. We found that an exposure of three hours at 81 lbs. to an atmosphere containing 36 % oxygen (the oxygen pressure being thus equal to that of 150 lbs. excess air pressure) killed one goat out of seven with "pneumonia." Our experience shows that it is not necessary to exceed an air pressure of half this (75 lbs.) to produce symptoms which are sufficiently varied and severe to satisfy experimental requirements.

Experience also showed that goats were very suitable animals in that slight symptoms were presented to our notice in a definite objective form. The lesser symptoms of caisson disease cannot be neglected, and there are reasons for supposing that their occurrence is not exactly conditioned by those experimental circumstances which in a more severe form produce serious and fatal results. They cannot be properly detected in mice or guinea-pigs or even in rabbits. Goats, while they are not perhaps such delicate indicators as monkeys or dogs, and though they are somewhat stupid and definitely insensitive to pain, are capable of entering into emotional relationships with their surroundings, animate and inanimate, of a kind sufficiently nice to enable those who are familiar with them to detect slight abnormalities with a fair degree of certainty.

The animals, 85 in number, used in the present experiments were a mixed collection of ordinary English goats of no particular breed. They

<sup>1</sup> The weights are only given in a few instances; from these it may be surmised that the dogs were small (5 to 12 kilos).



### 380 *The Prevention of Compressed-air Illness*

were about equally distributed between the sexes, and varied in weight from 10 to 30 kilos, the average being rather less than 20 kilogrammes. All were apparently adult, judging from the fact that none showed any increase in weight while in our possession. One or two (XIII A, XXXII A) seemed to be quite aged, but the rest were fully active.

On the whole the herd remained healthy. Two died of apical pneumonia and two of diarrhoea, which was at one time epidemic in a severe form. The cause could not be determined, but the trouble became much less marked after the animals were placed on a more meagre diet and corn withheld. Three animals were under some suspicion of being infected with *M. melitensis*<sup>1</sup>; two of them seemed rather depressed (though not more so than appears to be natural in some goats), while the third showed no signs of ill-health. Various items of pathological interest were found in those which came to post-mortem: in the lungs various nematodes were found several times, *Linguatula* once, and a surgical needle once; a *Streptothrix* abscess in the stomach wall followed puncture with a needle to relieve distension; a bony tumour was found in an adrenal gland; in one old goat (XXXII A) the aorta was extensively atheromatous; flukes occurred in the liver once, while hydatids in the peritoneum were very common and intestinal worms abundant. None of these conditions (except possibly the arterial disease) can however be considered to have rendered the animals definitely abnormal as far as caisson disease was concerned, and none of them could be attributed to exposure to compressed air.

#### 3. *Respiratory exchange of goats.*

The difficulties of measuring directly the circulatory activity of normal animals are almost insuperable. This must be however in general proportionate to the rate of respiratory exchange, and a number of determinations of the CO<sub>2</sub> production of our goats were made in order to get a line of comparison with other animals (and especially man) in respect of the rate at which air would be taken up by and discharged from the body.

<sup>1</sup> Of 22 animals whose blood was examined, 16 gave no reaction with *M. melitensis* at a dilution of 1:20, 3 gave some reaction at 1:20, while 3 animals gave complete agglutination up to 1:200 (XVIII A, XXVI A, XXIII A). Cultures from the blood during life were negative, and when they eventually came to autopsy cultures of blood, spleen, liver, inguinal, axillary, mesenteric and mammary glands were negative as regards *M. melitensis*. The exact history of these animals could not be obtained, but there is practically no doubt that they had never been out of England.



A. E. BOYCOTT, G. C. C. DAMANT AND J. S. HALDANE 381

The observations were made by using the pressure-box as a respiration chamber. The animals were enclosed and hourly samples removed (after thorough mixing with an electric fan) and analysed in a delicate form of Haldane's gas analysis apparatus. The results were entirely satisfactory, the successive analyses showing a regular increase in the CO<sub>2</sub>. The goats led a regular life, and all the observations were made at approximately the same time of day so that they are fairly comparable with one another in respect of the influence of food. The animals remained fairly quiet, though they seldom lay down.

The results of 27 experiments are given in the next table. The analyses have been calculated in grammes of CO<sub>2</sub> per hour per kilo of

TABLE II.

Number of experiment	Temp. °C.	Bar. mm.	Duration hours	Pressure lbs. positive	Goats					CO <sub>2</sub> gms. per hour		Remarks
					Number	Males	Females	Total weight kilos.	Average wt. kilos.	Per kilo body wt.	Per 1000 sq. cms. surface	
I	19	764	3	0	4	—	4	99.0	24.7	1.006	2.625	
II	13	763	2½	0	4	2	2	62.8	15.7	1.123	2.070	
III	15.5	765	1½	0	9	4	5	159.7	17.7	0.908	1.823	
IV	15	752	1½	0	9	3	6	171.1	19.0	0.727	1.749	
V	17	762	3	0	6	6	—	111.8	18.6	1.104	2.554	R. Q. 1.03.
VI	11	769	6	0	6	—	6	138.8	23.1	0.670	1.771	R. Q. 0.90.
VII	13	765	5	0	6	6	—	121.3	20.2	0.975	2.389	R. Q. 1.06.
VIII	13	754	4	45	7	7	—	142.7	20.4	0.887	2.187	
IX	13	740	4	45	8	—	8	193.7	24.2	0.627	1.682	
X	15	754	7	0	7	7	—	142.1	20.3	0.664	1.630	R. Q. 0.91.
XI	16	780	6	0	6	6	—	126.3	21.0	0.615	1.533	Fasting 20 hrs. R. Q. 0.82.
XII	15	778	4	21	7	7	—	140.9	20.1	0.763	1.770	
XIII	15	774	7	0	8	—	8	193.7	24.2	0.548	1.469	R. Q. 0.82.
XIV	14	760	4	45	13	5	8	295.7	22.7	0.667	1.738	R. Q. 1.08.
XV	16	758	3½	25	6	6	—	127.9	21.3	0.959	2.367	
XVI	17	764	3¼	20	7	3	4	148.7	21.2	0.635	1.572	
XVII	15	762	4	0	6	6	—	127.9	21.3	0.669	1.652	
XVIII	17	762	1½	45	6	—	6	122.1	20.3	1.020	2.504	
XIX	14	761	4	45	6	6	—	127.9	21.3	0.697	1.722	
XX	13	760	3	0	5	—	5	100.1	20.0	0.921	2.258	
XXI	16	760	4	45	5	—	5	100.1	20.0	1.104	2.701	
XXII	15	762	4	45	6	6	—	127.9	21.3	0.967	2.390	
XXIII	16	768	4	45	5	—	5	100.1	20.0	0.852	2.083	
XXIV	12	776	5	0	4	2	2	95.3	23.8	0.717	1.853	
XXV	14	775	5	0	4	2	2	95.3	23.8	0.751	1.941	
XXVI	14	775	5	0	4	1	3	76.9	19.2	0.624	1.501	
XXVII	13	766	5	0	4	1	3	76.9	19.2	0.704	1.693	



382 *The Prevention of Compressed-air Illness*

body weight and also per 1000 square centimetres of surface according to the usual formula  $S \times 100 = \sqrt[3]{W^2} \times 11.2$ , where  $S$  = surface in square centimetres and  $W$  the body weight in kilogrammes.

The goats used belonged to Series II (Exps. 1—4), III and IV.

The results of these experiments are very variable; the averages are shown in the next table:

TABLE III.

	No. of experiments	CO <sub>2</sub> in grms. per hour	
		Per kilo body-weight	Per 1000 sq. cms. surface
At atmospheric pressure	16	0.795	1.907
At 45 lbs. positive	8	0.853	2.126
At 20, 21 and 25 lbs. positive	3	0.786	1.903
All pressure experiments	11	0.834	2.065
Males only	10	0.830	2.019
Females only	8	0.843	2.137
Mixed experiments	9	0.762	1.771
All experiments	27	0.811	1.971
		(410 c.c.)	(997 c.c.)

One may conclude that goats produce about 0.8 gm. CO<sub>2</sub> per kilo per hour under conditions of incomplete rest, and that no great departure from this figure is occasioned by the animals being under pressure up to 45 lbs. or by sex. It is shown elsewhere<sup>1</sup> that something more than 10% of the total CO<sub>2</sub> produced by goats comes from the fermentation of the contents of the alimentary canal, and figures detailed below (p. 409) indicate that one-fifth of the body weight is contributed by these contents. In comparing the CO<sub>2</sub> production of goats with that of man, we may regard these two corrections as roughly balancing one another and may neglect them.

It appears that man produces under conditions of bodily activity comparable to that of our experimental animals, about 0.45 to 0.5 gm. CO<sub>2</sub> per kilo per hour. Goats therefore show a respiratory activity approximately 1.7 times that of man. This figure corresponds fairly well with that calculated from the size. If the respiratory exchange per unit of surface is the same, a goat of 20 kilos will produce 1.5 times as much CO<sub>2</sub> per unit of weight as a man of 70 kilos.

4. *Method of conducting the experiments.*

No animals were subjected to experiment when obviously ill. As a rule five to eight animals were put in at one time. The pressure

<sup>1</sup> *Journal of Physiology*, vol. xxxvi. (1907), p. 283.



## A. E. BOYCOTT, G. C. C. DAMANT AND J. S. HALDANE 383

having been raised to the desired point, the chamber was entirely closed and no ventilation given until decompression began. The average  $\text{CO}_2$  production of goats is about 435 c.c. per kilo per hour at ordinary temperatures. The chamber usually contained 100 to 150 kilos of goat so that the  $\text{CO}_2$  rose about 0.45 to 0.55 % (measured at atmospheric pressure) per hour. In this way it never attained a harmful partial pressure in experiments lasting from a few minutes to four hours. In the few observations made with an exposure of eight hours, the  $\text{CO}_2$  was allowed to accumulate for four hours and afterwards the chamber was ventilated so that the  $\text{CO}_2$  did not exceed a partial pressure of 2 % of an atmosphere. No experiments have been made to directly examine the possible influence of  $\text{CO}_2$  upon the incidence of caisson disease. It appears to the authors that the effect must (1) in any case be very slight with partial pressures of less than 2 or 3 %, and the result, if any, of the increased respiratory and circulatory activity must be in the direction of diminishing the ill-effects of decompression after any but quite short exposures<sup>1</sup>.

After the preliminary experiments (Series I), the animals were never used more than once on the same day, and, with rare exceptions, not on succeeding days. In many cases indeed individual goats rested for a week or more between the experiments.

During decompression the animals could be watched fairly satisfactorily through the windows of the chamber, though fog of course completely blocked the view during the actual moments of rapid decompression. At the end they were allowed to escape from the chamber and run about free in the yard. They were kept under continuous observation for half an hour or longer, and were frequently seen throughout the day. We found that practically all the symptoms which were going to appear declared themselves within thirty minutes, though a few slight signs were probably missed. We also found that slight signs were much more obvious when the animals were not distracted or excited by food or other causes. During the breeding season it is advisable to keep the males and females separate, and, by removing any sources of interest, to allow the animals to fall into a state of meditative boredom. Under these circumstances, trivial symptoms are easily detected which are not made the subject of objective demonstration by animals engaged with their appetites.

<sup>1</sup> Greenwood (*British Medical Journal*, June 22nd, 1907, Supplement, p. 409) has recently found that high percentages of  $\text{CO}_2$  do not increase the liability to decompression symptoms.



384 *The Prevention of Compressed-air Illness*

No observations were made of the temperature within the chamber during an experiment. Very hot and very cold weather did not seem to influence the results. The air in the chamber was always warmed by compression and sometimes also artificially, while decompression was of course accompanied by sudden, often very severe, spells of cold. No account has been taken of variations in atmospheric pressure. The extreme readings of the barometer on record are 806 and 689 mm. at sea level, and in this country 790 and 695 mm.<sup>1</sup>, giving ranges of 117 mm. and 95 mm. or about 2½ and 1½ pounds. Even this variation, though it occurs at an important part of the absolute pressure scale, cannot be of great significance.

Times of exposure of one hour or less are, unless the contrary is directly specified, to be taken as indicating actual exposure to the given pressure, the time of compression (six minutes) being neglected. For longer exposures it was sometimes convenient to raise the pressure more slowly: in these cases therefore the times specified may indicate either the actual exposure *plus* four to six minutes compression or a virtual exposure calculated by adding the actual exposure to half the time of compression which is in minutes roughly one quarter of the pressure in pounds positive (see above, p. 362).

As will be gathered from the details given below, the general scheme of the experiments involved the examination of three variable factors—degree of pressure, duration of exposure and duration and mode of decompression. For the most part the degree of pressure was kept constant while the other two factors were varied. It soon appeared from the preliminary experiments that the individual variability of the animals was very large—larger indeed than the difference between many of the modes of decompression which it was desired to examine. It also appeared that the relative susceptibility of the different individual animals remained fairly constant so that after a time one could pick out goats which were known to be either susceptible above the average or definitely resistant to caisson disease. It was therefore clear that either an enormous number of animals had to be employed or the experiments had to be so framed as not to produce fatal results and so reduce the proportion of susceptible individuals in the herd. It appears probable that any 20 or 30 goats would give much the same results, but if many are lost it is necessary to discard the remainder and procure a fresh batch to be subjected to the comparative experience. Obvious reasons prevented this procedure. It was therefore necessary to be at

<sup>1</sup> *Nature*, vol. LXXV., 1907, p. 330.



## A. E. BOYCOTT, G. C. C. DAMANT AND J. S. HALDANE 385

some pains to secure that the deaths should be as few as possible so that the same individuals might pass through a number of different combinations of pressure, exposure and decompression. The animals were therefore first put through the experiments which we surmised would give least symptoms, and were subsequently exposed to circumstances of progressively increasing severity. Even so, each batch of animals became selected to a more or less considerable degree. Be it noted however that one may in this way obtain strong evidence of an *a fortiori* kind. For, if the selected resistant members of the herd show many symptoms in the severest experiments, so much the more would the whole original lot of average animals have been affected. This individual variability of the animals renders many of our experiments incomplete, and should be constantly borne in mind in considering the results obtained.

5. *The symptoms observed in goats.*

The symptoms observed in goats in sequence to decompression are protean in character. The majority may however be grouped under a few definite heads.

1. *Bends.* The commonest symptom which we have observed consists of the exhibition of signs indicating that the animal feels uneasy in one or more of its legs. The limb, most commonly a fore-leg, is held up prominently in the air and the animal is evidently loth to bear weight upon it (see Plate VI<sup>1</sup>). In mild cases such a limb is used normally in walking or running, but in other instances the animal limps more or less considerably when it is forced to use the affected member, and is often very anxious to lie down. No tenderness can be detected on pressure or manipulation of the leg and it is not altogether clear that the animal suffers definite pain. We have however noted that a goat may break its leg and immediately use it for progression without evincing any signs of pain. We may conclude from this that the response to stimuli which in many animals would be distinctly painful is largely suppressed in the goat to the level of the exhibition of a consciousness that the limb is somewhat abnormal and not well suited for active use. But it must be understood that this objective demonstration is a very conspicuous and definite symptom. There is little doubt that these symptoms observed in the legs of goats are the equivalent of the "bends" or "screws" which are the commonest

<sup>1</sup> We are indebted to Dr H. W. Armit for this photograph.





"Bends" of fore-leg in a goat.



386 *The Prevention of Compressed-air Illness*

symptoms in caisson workers; in human experience they are of course accompanied by definite pain, often of a severe character.

The following table shows the distribution of "bends" in the last 110 cases observed:

TABLE IV.

One hind leg ... ..	28
One fore leg ... ..	70
Both hind legs ... ..	1
Both fore legs ... ..	1
One fore and one hind leg ... ..	10
Total one leg ... ..	98
Total two legs ... ..	12
Total right ... ..	50
Total left ... ..	48

"Bends" may be seen immediately at, or indeed (but very rarely) shortly before the end of a long decompression. Most commonly however they come on after an interval of about 15 minutes; on the other hand they may be delayed still more. As might be expected, the period of delay varies with the duration of decompression: thus the average delay in a number of cases after rapid decompression (1 to 10 minutes) was 16 minutes, which was reduced by long decompression to six minutes. Their duration appears to be brief; all evidence of their presence has usually disappeared in one or two hours and it has been very exceptional for any trace of them to be present next day (16 to 20 hours).

"Bends" in parts of the body other than the limbs are very difficult to identify in animals; we have however occasionally noted symptoms which might well be bends in the trunk, though we are not prepared to definitely identify them as such.

2. *Temporary paralyses* may be of two kinds. In the first a general weakness is present accompanied with dyspnoea and there is dragging of the hind legs with foot-drop. These are clearly symptoms due to a general deficiency of oxygen from pulmonary embolism and are comparable to the paralyses seen in, *e.g.*, carbon monoxide poisoning in animals and men. In our records and the tables such cases are not classified as "paralysis" but as "dyspnoea." In the second group fall a series of cases which are obviously of nervous origin. The animal, while showing no signs of general illness, or in other instances having already had bends, exhibits foot-drop or a more extensive palsy in one or more hind- or fore-limbs. The paralysis does not usually come on till about 15 minutes after decompression, rapidly becomes more marked



## A. E. BOYCOTT, G. C. C. DAMANT AND J. S. HALDANE 387

for a few minutes after the first signs are noted, and then soon begins to mend, so that there is marked improvement in about half an hour, and by next day the animal is found quite well. This form of paralysis chiefly involves the hind legs (16 out of 19 cases).

3. *Pain.* In some cases the animals have shown signs of acute pain by urgent bleating and continual restlessness. Bleating in goats after decompression is usually a sign of distress such as is produced by cardiac and respiratory embarrassment and is often present in fatal cases. In other instances animals showing only severe bends bleat in a most distressing manner and are evidently in acute pain: at the same time they may gnaw at some part of their body (such as the testicles) as if localising the origin of the pain. In animals which have recovered, we have not had any instance where these signs persisted for more than 10 or 15 minutes.

4. *Permanent paralysis.* The onset is usually immediately after decompression, the condition is complete from the first and for at least several days there are no signs of improvement. In a few cases the first paralysis has passed off (to all appearances completely) in two or three hours and the animal has been found next morning to be again paralysed. This second paralysis is permanent. A similar history has often been noted in human cases. In 15 cases out of 16 the condition has been a paraplegia, and in one all four legs were affected more or less. In some there has been retention of urine, and one animal had to be killed on account of acute distension of the stomach which came on some 20 hours after the onset of the paraplegia. In the most severe cases the animals have been killed; others have however soon begun to mend and have lived for some months with a slight spastic paralysis of the hind legs.

5. A fair number of cases have occurred where the animal has been obviously ill, but in which it has been impossible to identify any definite local symptoms or any definite dyspnoea. The goat may lie down, refuse to move or to be tempted with corn (of which goats are inordinately fond), sometimes lying extended on the side, sometimes hurriedly rising, walking a few steps and then lying down again. On two occasions the most probable interpretation of the symptoms was that the animal was blind. The goat may run wildly about instead of becoming very apathetic and depressed. These and other such symptoms are on the whole somewhat persistent and the animal is often dull and poorly the next day. In one case (XXV A) the goat showed little but a marked apathy and distaste for food, but died 16 hours later.



388 *The Prevention of Compressed-air Illness*

6. *Dyspnoea* is usually the precursor of (7) *death* and only a minority of goats survived after showing clear *dyspnoea*. In these cases the condition has rapidly improved; more commonly however it progressively increases till the animal is moribund, when it is replaced by irregular, faint, gasping respiration. The mucous membranes become livid and pale and the animal lies for a short time unconscious before respiration stops. The heart continues to beat regularly throughout and the rate is not apparently much altered. Only on one occasion have we been able to hear gurgling in the heart on auscultation: it was then audible at some distance. Death ensues at varying periods after decompression; with very severe experiments (*e.g.* 100 lbs.: 1 hour: 1 minute)<sup>1</sup> it may follow in five or ten minutes; with more moderate conditions it is delayed for 20 or 30 minutes, or rarely for two or three hours: on three occasions it has followed still later, up to 40 hours. The delay in the onset of the first symptoms is often most striking; the animal may appear quite normal for as long as 10 or 15 minutes, *dyspnoea* then appears, the goat falls down helpless and in another 15 minutes is dead.

8. *Mechanical symptoms* are not important. We have not been able to satisfy ourselves that goats ever suffer materially during compression from the ear troubles which are so common in men. Abdominal distension is occasionally extreme, but the animal soon empties its distended stomach and seems to be little inconvenienced<sup>2</sup>.

Our index throughout has been the presence of symptoms, not the presence of bubbles. Anticipating here a later section (p. 410) we may say we are in entire agreement with the view which attributes most of the severe symptoms of caisson disease to local or general blocking of the circulation by bubbles of gas. One might suppose in consequence that the incidence of severe symptoms, especially of paralyses, would be of a haphazard kind, since they would be to a large extent dependent on the chance distribution of bubbles by the blood stream. Some support for this view is perhaps to be found in the records of caisson workers given by von Schrötter; as far as can be ascertained from the details given, the cases of paralysis and *dyspnoea* were distributed through the whole range of pressure experienced by the men in about the same proportion to the total number of illnesses of all kinds, which latter increased greatly as the pressure became higher. It should however be noted that the range of pressure was small (up to 2·4 atmospheres positive), and

<sup>1</sup> *i.e.* pressure 100 lbs. positive; exposure for 1 hour; decompression in 1 minute.

<sup>2</sup> Post-mortem experience shows that the stomach alone is distended, not the bowels.



A. E. BOYCOTT, G. C. C. DAMANT AND J. S. HALDANE 389

the general experience of caisson works as well as our own experiments with animals are distinctly at variance with these results. We have noted only two instances of what may be called "chance incidence" of paralysis: (a) goat XV (Series II) had a paraplegia after 15 minutes' exposure at 75 lbs. and decompression in 30 minutes uniformly, and afterwards lived for some time, passing through much more severe experiments without symptoms, and eventually being killed with some difficulty by 75 lbs: 2 hours: 1 min.: (b) goat XII A (Series III) after 45 lbs.: 1 hour: 10 min. uniform, had apparently very severe bends; it did not however recover in the usual way and became partially paraplegic, subsequently passing through many comparatively severe experiments without symptoms. The tables of our results seem to show quite clearly that as the conditions of experiment become more searching, not only does the frequency of symptoms increase but the proportion of severe to total symptoms becomes much greater.

It is necessary for comparative purposes to form some idea of the relative importance of these different symptoms, and to consider how far they may be classed as relatively dangerous or comparatively negligible. "Bends" are clearly a slight symptom; there is abundant evidence both in goats and men that their occurrence is no indication of urgent danger to life. At the other end of the scale we have death. Dyspnoea is not far removed in significance from death, and lasting paralyses are somewhat less serious than dyspnoea. Next in order come pain and those indeterminate conditions which we have grouped as "indefinite and various general": these may be followed by death and are much more indicative of danger than bends. Temporary paralyses are not so important and we are inclined to the view that they are not much more dangerous than bad bends. This classification is based for the most part on our experience as to the kind of experiment with which each group of symptoms is commonly associated, and the way in which the different groups are associated together in the same experiment. The individual variability of the animals introduces many difficulties, but it is certain that the more severe the conditions of pressure, exposure and decompression, the more likely it is that the animals will suffer from symptoms which we have classed as severe.

*Immunity to symptoms.* There is not the slightest ground, either theoretical or experimental, for supposing that animals or men, as the result of repeated exposure to compressed air, acquire any immunity to the formation of bubbles within their persons. It must be remembered in this connection that the susceptible individuals become eliminated,



390 *The Prevention of Compressed-air Illness.*

so that those who have been through many decompressions necessarily show more than average resistance. The matter is not so clear with regard to the exhibition of symptoms resulting from such bubbling. We have a certain amount of evidence, too vague to be detailed, that some goats show slight bends rather more easily in their first few experiences, and it is not difficult to imagine that they might grow to neglect altogether those bubbles which evidently cause them no very great inconvenience at any time. With severe symptoms it is of course different: no one can suppose that a goat acquires immunity to extensive pulmonary air emboli or to infarction of the spinal cord.

TABLE V.

Series I. June—July 1906. Pressure 75 lbs. positive (= 6 atmospheres absolute). Compression in 39—41 minutes. The details of the stage decompressions are shown in Table IX.

No. of goat	Sex	Decompression minutes ..... 40—50 uniform			40—50 stages		
		Actual exposure minutes.... 12	15	30	12	15	30
I	M	0					
Pa	M	0	bends	0		0	0
XIII	F	bends					
XVIII	F	bends	0	0			0
		+ indefinite <sup>1</sup>					
XXI	F	0 + 0 <sup>1</sup>	bends				
XXII	F	0	bends				
X	F		bends	bends			0
XVI			bends	bends		0	
XX	F		bends	bends	bends		
XXIV	M		0	bends		bends	0
XXVII	F		0			0	0
XXIX	F		0	bends, dyspnoea		0	
XXX			bends			bends	
XXXII			bends				
III	M			0			0
IV	M			0			bends
VI	M			0			0
XXVI	M			bends			bends + bends <sup>1</sup>
XXVIII	F			bad bends			
VIII	M				0		
XIV					bends		
XIX					bends		
II	M						bends
XXV	M						bad bends

<sup>1</sup> Each of these experiments was repeated upon the same animal: both results are shown. XVIII was generally uneasy, lay down, nothing definite.

A. E. BOYCOTT, G. C. C. DAMANT AND J. S. HALDANE 391

TABLE VI.

Series II. December 1906 to January 1907. Pressure 75 lbs. positive (6 atmospheres absolute); compression 6 minutes. The details of the decompressions are shown in Table IX.

Decompression No. of goat	Actual exposure in minutes	Weight in kilos	Sex	15		30		60		120 <sup>17</sup>		240 <sup>17</sup>	
				10 un- form	31 stages	31 un- form	31 stages	31 un- form	31 stages	70 stages	70 un- form	31 stages	31 un- form
I	1	18.3	M	0	0	0	0	0	0	0	0	0	0
2	0	16.2	M	0	0	sl. bends	temp. paral.	0	0	bends	para- plegia <sup>6</sup>	0	0
X	0	16.4	M	0	0	0	bends	0	0	bends	0	0	temp. paral. died <sup>11</sup>
XI	0	17.1	F	0	0	0	0	0	0	0	0	0	0
XII	0	19.8	M	0	0	0	0	0	0	0	0	0	0
XIII	0	17.8	M	0	0	0	0	0	0	0	0	0	0
XIV	0	18.6	F	0	0	0	0	0	0	0	0	0	0
XV <sup>12</sup>	0	16.8	M	0	0	sl. bends <sup>18</sup>	0	0	0	0	0	0	0
XVI	0	10.7	M	0	0	0	0	0	0	0	0	0	0
XVII	0	24.8	F	0	0	0	0	0	0	0	0	0	0
XVIII	0	26.3	F	0	0	0	0	0	0	0	0	0	0
XIX	0	15.0	F	0	0	0	0	0	0	0	0	0	0
XX	0	15.0	F	0	0	0	0	0	0	0	0	0	0
XXI <sup>15</sup>	0	29.7	F	0	0	0	0	0	0	0	0	0	0
XXII	0	19.0	F	0	0	0	0	0	0	0	0	0	0
XXIII	0	21.4	F	0	0	0	0	0	0	0	0	0	0
XXIV <sup>16</sup>	0	35 <sup>about</sup>	M	0	0	0	0	0	0	0	0	0	0
XXV <sup>13</sup>	0	21.5	M	0	0	0	0	0	0	0	0	0	0
XXVI	0	17.5	F	0	0	0	0	0	0	0	0	0	0
XXVII	0	12.0	F	0	0	0	0	0	0	0	0	0	0

<sup>1</sup> Animal also lay down and seemed generally ill: no dyspnoea. <sup>2</sup> Lay down, grunted, seemed quite ill: no definite bends or dyspnoea. <sup>3</sup> Lay down and refused to move: no definite local symptoms. <sup>4</sup> Could walk with feet dragging in 6 days; nearly well when killed 9 weeks later. <sup>5</sup> Well in 9 days. <sup>6</sup> Almost well in 48 hours. <sup>7</sup> Died in 15 minutes. <sup>8</sup> Died in 30 minutes. <sup>9</sup> Died in 76 minutes: bad bends, dyspnoea, no paralysis. <sup>10</sup> Pain, paralysis, dyspnoea; died 43 minutes. <sup>11</sup> Dyspnoea; died in 26 minutes. <sup>12</sup> 72 lbs., 4 hours, 40 seconds; convulsions, dyspnoea, died 20 minutes. <sup>13</sup> 75 lbs., 2 hours, 45 seconds; bends, convulsions, dyspnoea, died 17 minutes. <sup>14</sup> Injured shoulder: killed immediately after decompression: see p. 412. <sup>15</sup> 75 lbs., 1 hour, 13 minutes; died in 10 minutes without dyspnoea or any symptoms except collapse. <sup>16</sup> 80 lbs., 2 hours, 10 minutes uniform; bends, paralysis, dyspnoea; died in 12 minutes. <sup>17</sup> In some of these experiments slow compression in 89 minutes was used, in which case the actual exposure was reduced by half the time of compression. <sup>18</sup> A somewhat different decompression was used in this experiment, viz. 75 lbs. to 17 lbs. in 5 minutes, wait 5 minutes, then 5 minutes at 13 lbs., 10 minutes at 9 lbs., and 10 minutes at 4 lbs.



The Prevention of Compressed-air Illness

TABLE VII.

Series III. February to June 1907. Pressure 45 lbs. positive (4 atmospheres absolute). The details of the stage decompressions are shown in Table IX.

Exposure minutes	15		30		45		60		90		120		240		480	
	Decompression minutes	No. of goat	Sex	Weight kilos	30 stages	30 stages	10 unform	30 stages	30 stages	10 unform	30 stages	10 unform	30 stages	10 unform	30 stages	10 unform
2	2	2	M	24.3	0	0	0	0	0	0	0	0	0	0	0	0
4	0	0	M	19.6	0	0	0	0	0	0	0	0	0	0	0	0
X A	0	0	M	17.0	0	0	0	0	0	0	0	0	0	0	0	0
XI A	0	0	M	20.0	0	0	0	0	0	0	0	0	0	0	0	0
XII A	0	0	F	19.2	0	0	0	0	0	0	0	0	0	0	0	0
XIII A <sup>12</sup>	0	0	F	28.2	0	0	0	0	0	0	0	0	0	0	0	0
XIV A <sup>8</sup>	0	0	M	16.4	0	0	0	0	0	0	0	0	0	0	0	0
XV A	0	0	F	15.5	0	0	0	0	0	0	0	0	0	0	0	0
XVI A	0	0	M	21.1	0	0	0	0	0	0	0	0	0	0	0	0
XVII A <sup>9</sup>	0	0	F	16.8	0	0	0	0	0	0	0	0	0	0	0	0
XVIII A <sup>11</sup>	0	0	F	20.0	0	0	0	0	0	0	0	0	0	0	0	0
XIX A	0	0	M	22.4	0	0	0	0	0	0	0	0	0	0	0	0
XX A <sup>10</sup>	0	0	F	19.8	0	0	0	0	0	0	0	0	0	0	0	0
XXI A	0	0	F	16.0	0	0	0	0	0	0	0	0	0	0	0	0
XXIII A	0	0	F	26.3	0	0	0	0	0	0	0	0	0	0	0	0

<sup>1</sup> Six other animals had this experience also, of which 7, XXVII A, and XXIX A had bends, and XXIV A, XXX A and 9 showed no symptoms. <sup>2</sup> Never so completely paralysed that it could not walk, but no improvement occurred during 21 weeks. <sup>3</sup> Bleating, seemed lost and walked into objects as if blind: well in 2 hours. <sup>4</sup> Acute distension of stomach developed next day; goat killed. <sup>5</sup> Killed next day. <sup>6</sup> Hind legs and, to a less degree, fore legs also: could walk in 3 days; killed 15 days when much improved. <sup>7</sup> Killed 3 days. <sup>8</sup> Broke leg, killed. <sup>9</sup> Died of pneumonia: no reason to connect this with decompression. <sup>10</sup> Died, cause unknown. <sup>11</sup> 75 lbs., 3 hours, 58 seconds: died 12 minutes without showing dyspnoea or any symptoms except collapse. <sup>12</sup> Apparently elderly.



A. E. BOYCOTT, G. C. C. DAMANT AND J. S. HALDANE 393

TABLE VIII.

Series IV. January to June 1907.

Pressure lbs. positive.....	75									
	3	6	10	15	15	30	60	120	180	180
Exposure minutes .....	1	1	1	1	1	68 stages	86 stages	100 uniform	134 stages	134 uniform
Decompression minutes .....	1	1	1	1	1	68 stages	86 stages	100 uniform	134 stages	134 uniform
No. of goat	1	1	1	1	1	68 stages	86 stages	100 uniform	134 stages	134 uniform
Sex, weight										
1	0	0	0	0	0	0	0	0	0	0
2	0	0	0	0	0	0	0	0	0	0
3	0	0	0	0	0	0	0	0	0	0
4	0	0	0	0	0	0	0	0	0	0
5	0	0	0	0	0	0	0	0	0	0
6	0	0	0	0	0	0	0	0	0	0
7	0	0	0	0	0	0	0	0	0	0
8	0	0	0	0	0	0	0	0	0	0
9	0	0	0	0	0	0	0	0	0	0
10	0	0	0	0	0	0	0	0	0	0
11	0	0	0	0	0	0	0	0	0	0
12	0	0	0	0	0	0	0	0	0	0
13	0	0	0	0	0	0	0	0	0	0
14	0	0	0	0	0	0	0	0	0	0
15	0	0	0	0	0	0	0	0	0	0
16	0	0	0	0	0	0	0	0	0	0
17	0	0	0	0	0	0	0	0	0	0
18	0	0	0	0	0	0	0	0	0	0
19	0	0	0	0	0	0	0	0	0	0
20	0	0	0	0	0	0	0	0	0	0
21	0	0	0	0	0	0	0	0	0	0
22	0	0	0	0	0	0	0	0	0	0
23	0	0	0	0	0	0	0	0	0	0
24	0	0	0	0	0	0	0	0	0	0
25	0	0	0	0	0	0	0	0	0	0
26	0	0	0	0	0	0	0	0	0	0
27	0	0	0	0	0	0	0	0	0	0
28	0	0	0	0	0	0	0	0	0	0
29	0	0	0	0	0	0	0	0	0	0
30	0	0	0	0	0	0	0	0	0	0
31	0	0	0	0	0	0	0	0	0	0
32	0	0	0	0	0	0	0	0	0	0
33	0	0	0	0	0	0	0	0	0	0
34	0	0	0	0	0	0	0	0	0	0
35	0	0	0	0	0	0	0	0	0	0
36	0	0	0	0	0	0	0	0	0	0
37	0	0	0	0	0	0	0	0	0	0
38	0	0	0	0	0	0	0	0	0	0
39	0	0	0	0	0	0	0	0	0	0
40	0	0	0	0	0	0	0	0	0	0
41	0	0	0	0	0	0	0	0	0	0
42	0	0	0	0	0	0	0	0	0	0
43	0	0	0	0	0	0	0	0	0	0
44	0	0	0	0	0	0	0	0	0	0
45	0	0	0	0	0	0	0	0	0	0
46	0	0	0	0	0	0	0	0	0	0
47	0	0	0	0	0	0	0	0	0	0
48	0	0	0	0	0	0	0	0	0	0
49	0	0	0	0	0	0	0	0	0	0
50	0	0	0	0	0	0	0	0	0	0
51	0	0	0	0	0	0	0	0	0	0
52	0	0	0	0	0	0	0	0	0	0
53	0	0	0	0	0	0	0	0	0	0
54	0	0	0	0	0	0	0	0	0	0
55	0	0	0	0	0	0	0	0	0	0
56	0	0	0	0	0	0	0	0	0	0
57	0	0	0	0	0	0	0	0	0	0
58	0	0	0	0	0	0	0	0	0	0
59	0	0	0	0	0	0	0	0	0	0
60	0	0	0	0	0	0	0	0	0	0
61	0	0	0	0	0	0	0	0	0	0
62	0	0	0	0	0	0	0	0	0	0
63	0	0	0	0	0	0	0	0	0	0
64	0	0	0	0	0	0	0	0	0	0
65	0	0	0	0	0	0	0	0	0	0
66	0	0	0	0	0	0	0	0	0	0
67	0	0	0	0	0	0	0	0	0	0
68	0	0	0	0	0	0	0	0	0	0
69	0	0	0	0	0	0	0	0	0	0
70	0	0	0	0	0	0	0	0	0	0
71	0	0	0	0	0	0	0	0	0	0
72	0	0	0	0	0	0	0	0	0	0
73	0	0	0	0	0	0	0	0	0	0
74	0	0	0	0	0	0	0	0	0	0
75	0	0	0	0	0	0	0	0	0	0
76	0	0	0	0	0	0	0	0	0	0
77	0	0	0	0	0	0	0	0	0	0
78	0	0	0	0	0	0	0	0	0	0
79	0	0	0	0	0	0	0	0	0	0
80	0	0	0	0	0	0	0	0	0	0
81	0	0	0	0	0	0	0	0	0	0
82	0	0	0	0	0	0	0	0	0	0
83	0	0	0	0	0	0	0	0	0	0
84	0	0	0	0	0	0	0	0	0	0
85	0	0	0	0	0	0	0	0	0	0
86	0	0	0	0	0	0	0	0	0	0
87	0	0	0	0	0	0	0	0	0	0
88	0	0	0	0	0	0	0	0	0	0
89	0	0	0	0	0	0	0	0	0	0
90	0	0	0	0	0	0	0	0	0	0
91	0	0	0	0	0	0	0	0	0	0
92	0	0	0	0	0	0	0	0	0	0
93	0	0	0	0	0	0	0	0	0	0
94	0	0	0	0	0	0	0	0	0	0
95	0	0	0	0	0	0	0	0	0	0
96	0	0	0	0	0	0	0	0	0	0
97	0	0	0	0	0	0	0	0	0	0
98	0	0	0	0	0	0	0	0	0	0
99	0	0	0	0	0	0	0	0	0	0
100	0	0	0	0	0	0	0	0	0	0

1 None of the animals in these two experiments showed any symptoms while watched for 1 hour at 24 lbs. and for 1/2 hour at 17 lbs. The results in the Table are those observed after final decompression. 2 Some of these weights differ from those in Series III, Table VII: several of the animals became somewhat thinner in the later part of the experiments. 3 Bleated, some convulsions, fore and hind legs paralysed, a little dyspnoea; found dead next morning; no bubbles. 4 Cried out, lay down, refused to move, evidently very ill but no local symptoms or dyspnoea; died between 17 1/2 and 18 hours later; bubbles in heart. 5 Bleating, dyspnoea, died 27 minutes. 6 Paraplegia, dyspnoea, died 190 minutes after decompression and 130 minutes after returning to atmospheric pressure. 7 In these experiments the pressure fell to atmospheric pressure in 30-35 seconds, the thermal effect then produced a delay of about 2 minutes when the pressure began to fall further, reaching -6 lbs. in about 4 minutes more: decompression was therefore in rough stages. The animals were maintained at -6 lbs. for 1 hour. 8 No symptoms for 18 minutes, then cried out, was moderately convulsed and right fore leg appeared paralysed, no dyspnoea, seemed very ill for about 10 minutes but then recovered and showed no symptoms later. 9 Constant nystagmus also noted lasting about 1/2 hour. 10 Lay down, evidently ill, no definite symptoms. 11 No improvement, killed 4 days. 12 No improvement, killed 6 days. 13 On a second trial again showed severe bends. 14 Castrated, of male habit. 15 An aged animal.



394 *The Prevention of Compressed-air Illness*

6. *Results of goat experiments.*

The detailed results of the experiments on goats are set out in the accompanying tables. With the exception of those in Series I, these tables contain nearly all the experiments which were made. Read vertically the columns give the results of the different combinations of pressure, exposure and decompression: the records of individual goats can at the same time be read on the horizontal columns. The tables give however no indication of the chronological sequence of events. In Series I only a few experiments are given; the series actually comprised 164 experiments on 34 animals, but the procedures adopted were, through ignorance, so ill-devised that no very definite results were obtained, though we gained information which enabled us to devise more satisfactory experiments subsequently. We have therefore extracted from Series I only a few results which illustrate the difference between stage and uniform decompression. The four series roughly represent four batches of goats, except that the animals of Series IV are the remnant of Series III with the addition of a further small herd. When reference is made to individual goats of Series I, the series is noted; otherwise the goats of Series III and IV are distinguished by "A": this does not apply to hornless animals which are specified by Arabic instead of Roman numerals, no two goats having the same number.

TABLE IX. *Showing the decompressions of goats from 75 lbs. and 45 lbs. Times given in minutes, one minute being occupied in each drop after the first.*

Series ....	Decompressions from 75 lbs. +								Decompressions from 45 lbs. +			
	I	II	II	IV	IV	IV	IV	III	III	III	III	
Columns..	4, 5, 6	4, 5, 8, 9, 11, 12, 13, 16	4 , (part)	14	12	7	10	9	3, 4, 7, 9 12, 15	8	13	16
First drop in	4	4	5	2	3	3	3	4	1	2	2	2
Wait at 32								3				
„ 27	5	2		7	15	4	9	2				
„ 22½	4			5	19	4	14	4				
„ 18	4	2	5	5	19	9	14	16		4	9	14
„ 14	4	4	4	10	24	9	14	16	3	14	14	14
„ 9	4 or 9	4	9	15	24	14	14	19	9	14	14	14
„ 4½	10 or 14	10	9	20	24	19	14	19	14	14	14	14
Total time	41 or 50	31	36	70	134	68	92	86	30	52	57	62

In the next table (Table X) the results are condensed and grouped in a simpler way, and one or two more experiments are given from Series I.

A. E. BOYCOTT, G. C. C. DAMANT AND J. S. HALDANE 395

TABLE X.

Pressure lbs. positive	Compression minutes	Actual exposure minutes	Decompression minutes	No. of goats	No symptoms		Bends				Temporary paralysis	Various indolent	Paraplegia	Dyspnoea	Total severe symptoms	Death
					Number	Percent	Slight	Bends	Bad	Total						
75	6	1/2	60 un.	3	7	87									0	0
		1	1	6	6	100									0	0
		3	1	5	4	80									1	0
		3	10 un.	2	2	100									0	0
		6	1	6	6	100									0	0
		10	1	7	6	86									1	0
		15	1	6	2	33	1								1	1
		15	10 un.	7	2	29									1	1
		15	31 st.	34	29	85		2							0	0
		15	31 un.	36	19	53	2	3							3	1
		15	90 un.	12	9	75									3	3
		30	31 st.	23	12	52									3	0
		30	31 un.	6	1	17									1	0
		30	68 st.	14	14	100									0	0
		30	68 un.	14	7	50									0	0
		60	31 st.	22	15	68									1	3
		120	31 st.	9	0	0									1	1
		120	70 st.	14	9	64									1	1
		120	70 un.	13	4	31		1							2	0
		120	92 st.	19	15	79									1	0
		120	100 un.	19	10	53									2	5
		180	134 st.	14	12	86									0	0
		180	134 un.	10	5	50	1	1							0	0
		240	31 st.	8	2	25									1	1
		240	31 un.	4	0	0									1	1
51	6	180	4	10	2	20									2	3
45	6	15	2	15	14	93									0	0
		30	2	15	12	80									0	0
		45	30 st.	14	14	100									0	0
		60	1	13	10	77									0	0
		60	10 un.	13	7	54									1	0
		60	30 st.	13	9	69									0	0
		60	52 st.	13	10	77		1							0	0
		90	30 st.	8	5	62									1	0
		120	1	10	4	40									1	3
		120	10 un.	12	6	50									1	2
		120	30 st.	13	12	92									0	0
		120	57 st.	15	13	87									0	0
		240	10 un.	11	6	55									1	0
		240	30 st.	13	11	85									0	0
		240	62 st.	15	9	60									0	0
		480	10 un.	11	6	55									2	0
30	6	60	10 un.	19	15	79									0	0
25		240	2	23	21	91									0	0
20		240	2	22	21	95									0	0
75	39	1	7 un.	8	7	87									1	0
		10	10 un.	4	3	75									0	0
		12	45 st.	4	1	25									0	0
		12	45 un.	6	4	67									0	0
		15	45 st.	6	4	67									0	0
		15	45 un.	12	4	33									0	0
		30	45 st.	11	7	64									0	0
		30	45 un.	12	5	42									1	0
		30	10 un.	4	0	0									0	4
		30	10 un. <sup>1</sup>	4	4	100									0	0
		30	10 un. <sup>2</sup>	4	0	0									1	1
		60	75 un.	4	2	50									0	1

<sup>1</sup> Recompressed at once to 15 lbs. for 32 minutes.

<sup>2</sup> Recompressed to 15 lbs. for 37 minutes 18 minutes after decompression.

un. = uniform decompression : st. = decompression by stages.



396 *The Prevention of Compressed-air Illness*

The following tables give in the simplest form the experimental evidence on certain points which are of especial importance.

(I) *Experiments showing that a certain minimum pressure is required to give symptoms in goats, and that the results vary with the pressure.*

TABLE XI.

Pressure in lbs. positive	Exposure in minutes	Decompression in minutes	No. of goats	No symptoms	Bends	Severe symptoms	Death
20	240	2	22	21	1	0	0
25	240	2	23	21	2	0	0
30	60	10 uniform	19	15	4	0	0
45	60	10 „	11	7	3	1	0
60 <sup>1</sup>	45	15 „	4	1	3	0	0
75	15	31 „	36	19	13	3	1
75 <sup>2</sup>	50	10 „	4	0	0	0	4

<sup>1</sup> Experiment in Series I: compression 30 minutes, exposure 30 minutes.

<sup>2</sup> Series I: compression 40 minutes, exposure 30 minutes.

These experiments show that the effects become more severe as the pressure increases although the duration of exposure was at the same time diminished and the duration of decompression increased. It was necessary to arrange the experiments in this way to prevent an inconvenient mortality among the animals.

(II) *Experiments showing that the duration of exposure to high pressures is of great importance.*

TABLE XII.

Pressure 75 lbs. positive, reached in 6 minutes.

Exposure in minutes	Decompression in minutes	No. of goats	No symptoms	Bends	Severe symptoms	Death
1	1	6	6	0	0	0
3	1	5	4	0	1	0
6	1	6	6	0	0	0
10	1	7	6	0	1	0
15	10 uniform	7	2	3	1	1
15	31 stages	34	29	5	0	0
30	31 „	23	12	8	3	0
60	31 „	22	15	4	3	0
120	31 „	9	0	7	1	1
240	31 „	8	2	4	1	1

These experiments show that goats have taken up enough air in 15 minutes to give severe symptoms on decompression in 10 minutes, while, if the exposure is less than 10 minutes, nearly all the animals escape, even with sudden decompression. Note too that with short

## A. E. BOYCOTT, G. C. C. DAMANT AND J. S. HALDANE 397

exposures and rapid decompressions such symptoms as appear are more frequently severe, and that bends are proportionately less common than with longer exposures and slower decompressions. Beyond 15 minutes exposure the results are somewhat irregular, but on the whole there is a progressive increase of bad symptoms up to two hours exposure. The results after four hours exposure are about the same, but the animals used (see Table VI, Series II) were to a large extent selected by previous experiments, so that it would appear that goats are practically saturated in about three hours<sup>1</sup>.

TABLE XIII.

Pressure 45 lbs. positive.

Exposure in minutes	Decompression in minutes	No. of goats	No symptoms	Bends	Severe symptoms	Death
15	1	15	14	1	0	0
30	1	15	12	3	0	0
60	1	14	10	4	0	0
120	1	10	4	2	4	0
60	10 uniform	11	7	3	1	0
120	10 „	11	6	4	1	0
240	10 „	11	6	4	1	0
460	10 „	11	6	3	2	0

These figures show that with a duration of exposure up to about three quarters of an hour, no severe symptoms follow even sudden decompression. The series with sudden decompression shows that the results after two hours are much worse than after one hour. This is not clear from the series with 10 minutes decompression, which, however, show that the results do not become distinctly worse even after

<sup>1</sup> The following figures have been compiled from the records of Helier, Mager and von Schrötter as illustrating the saturation time for dogs of about 10 (?) kilos. The corresponding data for other animals do not seem to have been determined. Pressure 62–69 lbs., compression in 5–16 minutes, decompression  $\frac{1}{2}$  to 1 minute.

Exposure minutes	Number of experiments	No symptoms	Mild paralysis and bends	Lasting paralysis	Paralysis and asphyxia	Asphyxia
Less than 10	1	1	0	0	0	0
10–29	6	5	1	0	0	0
30–59	12	0	6	2	3	1 (lived)
60–120	19	2	2	2	3	10

Four of the group "paralysis and asphyxia" died, and the other two would probably have died if they had not been killed. All but one in the "asphyxia" group died, but in none of the rest was the decompression immediately fatal. These results seem to show pretty clearly that dogs require more than an hour to become saturated. It is strange that the authors conclude (*Luftdruckerkrankungen*, p. 806) that saturation is so far complete in about 38 minutes in man that no further intake of nitrogen is of any practical importance.



398 *The Prevention of Compressed-air Illness*

eight hours exposure. Note that of the nine severe symptoms, five were temporary and four permanent paralyses: only one case of dyspnoea was seen in the whole of the experiments at 45 lbs. (Series III) and the one case of severe illness of obscure nature was suggestive of temporary local cerebral anaemia. At 75 lbs., out of 26 severe cases, four had dyspnoea, four permanent and 12 temporary paralysis, and six indefinite: seven died.

(III) *Experiments to show that the duration of decompression is of great importance.*

TABLE XIV.

Pressure 75 lbs. positive, reached in 6 minutes.

Exposure	Decompression	No. of goats	No symptoms	Bends	Severe symptoms	Death
15	10 uniform	7	2	3	1	1
15	31 „	30	19	13	3	1
15	90 „	12	9	3	0	0
30	31 stages	23	12	8	3	0
30	68 „	14	14	0	0	0
120	31 „	9	0	7	1	1
120	92 „	19	15	3	1	0

(IV) *Experiments to show that the absolute range of pressure through which decompression occurs may be of less importance than the relative range of absolute pressure.*

TABLE XV.

Pressure in lbs. +	Exposure in minutes	Decompression to lbs.	Fall of pressure in lbs.	Relative reduction of absolute pressure	Duration of decompression in minutes	No. of goats	No symptoms	Bends	Severe symptoms	Death
75	180	+ 24	51	2.3 : 1	11 <sup>1</sup>	10	10	0 <sup>1</sup>	0	0
51	180	0	51	4.4 : 1	4	10	2	3	3	2
45	120	- 6	51	6.7 : 1	6	3	0	1	1	1
39	120	- 6	45	6.0 : 1	6	4	1	0	3	0
45	120	0	45	4.0 : 1	1	10	4	2	4	0

<sup>1</sup> There were three cases of bends at the ultimate end of a two hours' decompression.

A sudden drop of about 50 lbs. from 75 lbs. positive to 27 or 24 lbs. positive has been made about 200 times altogether in the course of these experiments without producing any symptoms, and about two-thirds of the animals showed no symptoms at the end of the stage decompression. The animals were however only left a short time at 27 lbs. before proceeding with the further decompression. In the



## A. E. BOYCOTT, G. C. C. DAMANT AND J. S. HALDANE 399

present series the animals were left for one hour at 24 lbs. and watched very carefully, and afterwards suddenly decompressed to 17 lbs. and again observed for half an hour. The same goats were subsequently dropped suddenly from + 51 lbs. to atmospheric pressure with very disastrous results, and a drop of 51 lbs. from + 45 lbs. to - 6 lbs. was even worse. The details of these experiments are given in Appendix III. Owing to the cooling effect of rapid decompression, the falls from + 45 and + 39 to - 6 lbs. were interrupted by a delay of about two minutes at atmospheric pressure so that they were in a rough way stage decompressions.

(V) *Experiments showing the importance of the mode and spacing of decompression.*

The next table shows in brief the results of seven groups of experiments undertaken with the purpose of directly testing the results of stage decompression in comparison with those of uniform decompression in the same total time. The only exceptions to the parallelism of the experimental conditions are (1) in group  $\zeta$  the time of uniform decompression was extended from 92 to 100 minutes in order that it might correspond to the supposed safe rate of 20 minutes an atmosphere<sup>1</sup>; and (2) in group  $\beta$  stage decompression, three animals were decompressed by stages in an abnormal way (see Table VI and note, Series II); since these stages were certainly not more favourable to the animals than those used for the rest of the group, we have included the results.

In considering these results it must be clearly understood that the stage decompressions used were not in most cases intended to be safe for the particular exposure to which they were attached. The only two groups which were intended to be safe ( $\delta$  and  $\eta$ ) gave fairly satisfactory results; with 30 minutes exposure (+ 6 minutes compression) at 75 lbs. and 68 minutes stage decompression, we obtained no illnesses in 14 goats, and with three hours exposure and two and a quarter hours stage decompression only two cases of bends in the same number of animals. For comparative purposes it was desirable that the stage decompressions should produce symptoms of some kind, and they were intentionally designed so to do in so far as our knowledge allowed<sup>2</sup>.

<sup>1</sup> The details of the experiments in this group are given in Appendix III.

<sup>2</sup> The stage decompressions from 45 lbs. pressure are likewise all shorter than what we calculate to be safe. The stoppages are also imperfectly spaced. The proper spacing and duration of stoppages could not be calculated till the results of the experiments were known, and we realised the extreme slowness of saturation and desaturation.



400 *The Prevention of Compressed-air Illness*

TABLE XVI. *Showing the comparison between the results of stage and uniform decompression. Pressure 75 lbs. positive.*

A. *All experiments.*

Group	Exposure minutes <sup>1</sup>	Decompression, minutes	Decompression, method	Number of animals	Number of decompressions	No symptoms	Per cent.	Bends					Temporary paralysis	Various general	Paraplegia	Dyspnoea	Total severe	Death
								Doubtful	Slight	Bends	Bad	Total						
α	12-30	45	stages	18	22	12	55			9	1	10					0	
β	15	31	"	18	34	29	85	2	2	2	1	5					0	
γ	30	31	"	15	23	12	52			7	1	8	3				3	
δ	30	68	"	14	14	14	100					0					0	
ε	120	70	"	14	14	9	64			4		4					1	1
ζ	120	92	"	19	19	15	79			3		3	1				1	1
η	180	134	"	14	14	12	86			2		2					0	
<b>Total</b>					140	103	74	0	2	27	3	32	4	0	0	1	5	0
α	12-30*	45	uniform	19	32	14	44			15	1	16		1		1	2	
β	15	31	"	18	36	19	53	2	3	8		13		1	2		3	1
γ	30	31	"	6	6	1	17			3	1	4	1				1	
δ	30	68	"	14	14	7	50			7		7					0	
ε	120	70	"	13	13	4	31		1	6		7	1		1		2	
ζ	120	100	"	19	19	10	53			1	2	3	2	1		2	5	1
η	180	134	"	10	10	5	50	1	1	3		5					0	
<b>Total</b>					130	60	46	3	5	43	4	55	4	3	3	3	13	2

B. *Experiments on identical animals.*

β	15	31	stages	18	34	29	85		2	2	1	5					0	
γ	30	31	"	6	6	4	67			2		2					0	
δ	30	68	"	14	14	14	100					0					0	
ε	120	70	"	13	13	9	69			4		4					0	
ζ	120	92	"	19	19	15	79			3		3	1				1	
η	180	134	"	10	10	8	80			2		2					0	
<b>Total</b>					96	79	82	0	2	13	1	16	1	0	0	0	1	0
β	15	31	uniform	18	36	19	53	2	3	8		13		1	2		3	1
γ	30	31	"	6	6	1	17			3	1	4	1				1	
δ	30	68	"	14	14	7	50			7		7					0	
ε	120	70	"	13	13	4	31		1	6		7	1		1		2	
ζ	120	100	"	19	19	10	53			1	2	3	2	1		2	5	1
η	180	134	"	10	10	5	50	1	1	3		5					0	
<b>Total</b>					94	46	49	3	5	28	3	39	4	2	3	2	11	2

<sup>1</sup> Group α compressed in 39 minutes; the rest in 6 minutes or, with long exposures, in 39 minutes and half the time of compression deducted from the actual time of exposure.

## A. E. BOYCOTT, G. C. C. DAMANT AND J. S. HALDANE 401

The results are given in two forms: (*A*) shows the fate of all the animals tested to obtain the direct comparison between stage and uniform decompression, while in (*B*) the figures are confined to the effects (in the same experiments) on animals which were exposed to both stage and uniform decompression in each group. This emendation removes the only very severe symptom and three out of four of the temporary paralysees caused by stage decompression. Goat XXI (Series II) was advancing in pregnancy and, after having nearly died as the result of quick stage decompression, was excluded from the experimental troupe; the effect of the corresponding uniform decompression on this animal can therefore be only surmised. The effects of 31 minutes stage decompression after 30 minutes exposure were so bad that, not wishing at this stage to risk losing any animals, the parallel experiment with uniform decompression was limited to the more resistant animals. In group  $\beta$  (*B*) two of the animals were only decompressed once by stages. One had died from uniform decompression, and the other had broken a leg and had to be killed.

The figures show that the ratio of animals showing no symptoms with stage decompression to those escaping after uniform decompression in the same total time is about eight to five. Be it noted too that the difference between the two methods is in the same sense, *i.e.* in favour of stage decompression, in each of the seven groups, including group  $\alpha$  (Series I) where the stages were less well arranged than afterwards. The difference between the two methods appears still more strikingly in the quality than in the quantity of the symptoms produced. For while but one animal had symptoms which can be called distinctly severe after stage decompression, as many as eleven were materially ill after the corresponding uniform decompressions, and one died.

This difference may perhaps obtain more definite expression if we assign numerical values to the different symptoms. Making bends = 1, temporary paralysis = 2, and so on up to death = 6, we obtain the following results, showing a ratio of nearly five to one (*B* grouping) in favour of stage decompression:—

Group	Stages	Uniform
$\beta$	5	30
$\gamma$	2	6
$\delta$	0	7
$\epsilon$	4	13
$\zeta$	5	26
$\eta$	2	5
Total	18	87



402 *The Prevention of Compressed-air Illness*

This method is of course very rough. "Death" is worth more than six times "bends," and bends should have different values according to the sort of experiment. Bends arising from short exposures and relatively rapid decompressions (*e.g.* group  $\beta$ ) indicate that the exposure has been long enough to allow material saturation and are very significant, while if bends show merely the extreme slowness with which the tissues in which they arise get rid of the excess gas (*e.g.* group  $\eta$ ), they are of much less moment.

If we exclude bends, and count only the more serious symptoms, or death, the comparison becomes still more striking, the ratio being then two for stage decompression, as compared with 50 for uniform decompression.

(VI) *Experiments illustrating the difference between different kinds of animals.*

(1) Five goats (XXIV A, XXVI A, XXVII A, 7 and 9), 10 small guinea-pigs (175 to 275 gms., average 230 gms.), 9 mice (average 20 gms.), 12 small rats (average 35 gms.), 9 medium rats (average<sup>1</sup> 85 gms.), 8 large rats (average<sup>1</sup> 200 gms.), and 4 rabbits (1285, 1450, 1850, 2850 gms.) were compressed to 72 lbs. in 7 minutes and left at that pressure for 3 more minutes and decompressed in 50 seconds. Goat 9 had a curious short seizure and rolled over on the ground 10 minutes after decompression; it seemed alright immediately afterwards and showed no after effects. One small rat became paraplegic at once, and two other small rats were found dead next morning; one of these had bubbles in the heart. The rest of the animals showed no symptoms. The incidence of illness on the young rather than on the old rats is curious in view of the demonstration of the general immunity of young animals by Hill and Greenwood<sup>2</sup>: it was perhaps correlated with the shortness of the exposure.

(2) Twelve small rats, 13 medium rats, 8 large rats, 59 mice, 7 rabbits, 10 guinea-pigs, and 1 old hen were raised to 72 lbs. in 10 minutes, left for 1 hour and then decompressed in 50 seconds. No goats were put in since it was well established that this experience would have killed all of them. The hen and the largest rabbit (weight 2800 gms.) died in 5 minutes, and 1 guinea-pig became paraplegic in 10 minutes and died in 20 minutes. All three were extensively

<sup>1</sup> The details were eaten by a goat. All the animals were about the same size.

<sup>2</sup> *British Medical Journal*, June 22nd, 1907, Supplement, p. 408.



A. E. BOYCOTT, G. C. C. DAMANT AND J. S. HALDANE 403

bubbled; it is interesting to note that there were no bubbles in the avascular eggs of the hen. None of the other animals showed any symptoms.

(3) Five rabbits, 10 guinea-pigs, 23 mice, 10 small, 9 medium and 6 large rats were compressed to 51 lbs. in 7 minutes, left there for 2 hours 56 minutes and decompressed in 45 seconds. In similar experiments, out of 10 goats 2 died and only 2 escaped without symptoms (see above, p. 398). The largest rabbit, a very fat animal weighing 2.9 kilos, died 9 minutes after decompression: the rest showed no symptoms.

(4) Six goats (3, XIA, XIIA, XXI A, XXIV A, XXVII A), 7 guinea-pigs and six rabbits were raised to 75 lbs. in 5½ minutes, left for 15 minutes and decompressed in 42 seconds. Goat XXVII A had dyspnoea and paraplegia and was found dead next morning: XXIV A had temporary paralysis of both hind legs without dyspnoea and was quite recovered in an hour: 3 and XXI A had bends, while XIA and XII A showed no symptoms. None of the small animals were affected.

(5) Seven goats (3, X A, XI A, XII A, XXI A, XXIV A, XXVII A), 7 guinea-pigs, 5 rabbits, 7 medium and 12 large rats and 37 mice were compressed to 75 lbs. in 6 minutes, left 10 minutes and decompressed in 48 seconds. Goat X A had paraplegia. The other goats and the small animals showed no symptoms.

(6) Guinea-pigs, mice and rats were compressed with ourselves to 30 lbs. in 15 minutes, and 1 guinea-pig, 1 mouse, 1 medium and 1 large rat were killed with chloroform after 33 minutes. After decompression in 26 minutes by stages, many bubbles were found in the heart and vessels of the guinea-pig, a few in the mouse's heart, a few in the great vessels of the large rat, but none in the medium sized rat.

#### 7. *Individual variation among the experimental animals in their susceptibility to decompression symptoms.*

The variation in the individual susceptibility of different goats is very marked. The same variation has been noted constantly among both divers and caisson workers, and is apparent in most of the published animal experiments. As an example, the following figures have been extracted from the tables of experiments at 75 lbs. All four animals were males and very similar to one another in all obvious respects: two were resistant and two susceptible.



404 *The Prevention of Compressed-air Illness*

TABLE XVII.

Exposure	Decompression	XIII (17.8 kg.)	X (16.4 kg.)	2 (16.2 kg.)	XV (16.8 kg.)
15 mins.	31 mins. uniform	0	0	slight bends	paraplegia
15 "	31 " "	0	0	paraplegia	0
15 "	31 mins. stages	0	0	0	slight bends
15 "	31 " "	0	0	bends	0
30 "	31 " "	0	bends	pain, temporary paralysis	bends
60 "	31 " "	bends	0	0	0
120 "	70 mins. uniform	0	bends	paraplegia	bends
120 "	70 mins. stages	0	0	bends	bends

In all, therefore, goats X and XIII showed mild symptoms three times in 16 decompressions, while in the same experiments goats 2 and XV showed symptoms 11 times, and on 4 occasions these were of a severe character.

It might be supposed that this variation was only in the exhibition of symptoms, depending on individual susceptibility to pain, &c., and did not represent a variation in the amount and distribution of bubbles within the body. But post-mortem experience shows that the amount of bubbling present in two animals killed in the same experiment may be very different; and in living animals it is clear that on the whole susceptibility to bends involves susceptibility also to the more severe symptoms, which cannot be much altered by the temperament of the animal.

The complete explanation of this individual variation in susceptibility probably requires a knowledge of the details of caisson disease far beyond that which we at present possess. Data exist, however, on which the influence of several factors may be discussed.

(A) *Influence of sex.* The following table shows the sum of the results of the experiments grouped according to the sex of the animals. The groups defined as "selected" include only those experiments in which the animals examined were approximately representative; in Series II for example the figures given are the totals of those experiments in which 10 or more animals were examined, while in Series III and IV are summed only those observations which included both sexes about equally (Series III, expts. 1, 2, 5—8, 10—17, Series IV, expts. 18—20).

It would appear from this that there is no clear difference between the sexes in liability to decompression symptoms in general. The experiments suggested however that under certain circumstances there might be a marked difference in the susceptibility to death. In



A. E. BOYCOTT, G. C. C. DAMANT AND J. S. HALDANE 405

Series I, of 5 deaths, 3 were in females, a distribution of fatalities corresponding to the numbers of the sexes (males 12, females 16) used, while in Series II are shown 1 death in 7 males and 4 deaths in 11 females. All these last four animals were to some degree advanced in pregnancy, and their mortality is very probably to be associated with this condition, which, in the goat, is accompanied by a marked increase in the subcutaneous and intra-abdominal fat. That the deaths in Series I did not fall more heavily upon the females is perhaps to be correlated with the fact that these experiments were made in the summer and none of the goats were found pregnant, while the autopsies of Series II showed that in the winter practically every female is pregnant.

TABLE XVIII.

	Males				Females			
	Number	Decom-pressions	Illnesses	Per cent.	Number	Decom-pressions	Illnesses	Per cent.
Series I:								
Total	12	78	25	32	16	71	35	49
Series II:								
Total	7	84	42	50	11	91	38	42
Selected	7	64	26	41	11	79	27	34
15 mins. exposures	7	28	9	32	11	42	13	31
1 and 2 hrs. exposures	7	25	11	44	8	24	10	42
Series III and IV:								
Selected	7	108	26	24	8	113	29	26
Total	26	270	93	34	35	275	102	37

*Influence of size.* In the same way the influence of size on susceptibility may be examined. In the next table the animals are grouped as above and below the average weight for each sex.

TABLE XIX.

	Above average weight			Below average weight		
	Decompressions	Illnesses	Per cent.	Decompressions	Illnesses	Per cent.
Series II:						
Selected	55	22	40	80	26	32.5
15 mins. exposure	27	9	33	39	9	23
1 and 2 hrs. exposure	20	9	45	26	12	46
Series III and IV:						
Selected	102	19	19	119	36	30
Total	157	41	26	199	62	31
Journ. of Hyg. VIII						26



406 *The Prevention of Compressed-air Illness*

The results are contradictory unless (which appears hardly possible) there is an essential difference between exposures to high (75 lbs.) and to low (45 lbs.) pressures. The sums of the whole show no material difference between large and small goats. Theoretically, with decompressions of moderate length such as were used in the experiments under consideration, small goats should be somewhat more susceptible than large goats with short exposures since they should saturate more quickly in proportion to their relatively greater gaseous exchange<sup>1</sup>. This is not borne out by the experiments, in which however the rate of decompression may not have been quick enough to bring out the difference. It is, on the other hand, obvious that the larger goats should be more susceptible after long exposures with any except very short or very long decompressions: this is confirmed by the experiments at 75 lbs. (Series II), but those at 45 lbs. (Series III) show a greater difference in the opposite sense.

In comparing the incidence according to sex with those arranged according to weight, it will be noted that in Series II the males are somewhat more susceptible though they are rather smaller, while the same experiments, arranged by weights, show that the heavier animals suffer more frequently. In Series III, in which the male group is again composed of smaller animals, the susceptibility of the sexes is equal, while the lighter animals are more susceptible if weight be taken as the criterion. The only conclusion to be drawn is that these figures do not indicate that either sex or weight was a determining factor in the incidence of decompression symptoms.

*Influence of the activity of gaseous exchange.* General considerations suggest rather strongly that the susceptibility would be found to vary with the activity of gaseous exchange, directly as regards short exposures and inversely as regards long exposures. In most of our experiments, especially those of Series III, the incidence of symptoms has been conditioned rather by the mode of decompression than by the duration of exposure. As a whole, then, the goats with the most active exchange should prove to be the least susceptible.

The respiration results already given have been analysed in reference to this point: the results are variable and inconclusive and need not be detailed. This is perhaps not very remarkable when we consider that the animals were not grouped for the respiration experiments according

<sup>1</sup> The respiratory activity per unit of body weight, being proportional to the ratio of surface to mass, would of course vary but little in the goats, and would only be about a fourth greater in a goat of 15 kilos than in one of 30 kilos.



A. E. BOYCOTT, G. C. C. DAMANT AND J. S. HALDANE 407

to their susceptibility but by the bands into which they had been marshalled for the pressure experiments. A factor of considerable importance, which is to a large extent beyond control, is the activity of the goats at the moment. Some goats are naturally vivacious while others are almost constantly lethargic. These individual idiosyncrasies are no doubt of some moment in relation to susceptibility, but the customary habits of a group of animals may be altogether upset by an incompatible companionship in the chamber during an experiment.

One group of measurements gave for example the results shown in the following table. The CO<sub>2</sub> production of each group was determined on four separate occasions under conditions similar to those obtaining in the pressure experiments.

TABLE XX.

Females.						Males.					
No. of goat	Weight kilos	Expts.	Illnesses	Pressure lbs.	CO <sub>2</sub> gms. per kilo per hour	No. of goat	Weight kilos	Expts.	Illnesses	Pressure lbs.	CO <sub>2</sub> gms. per kilo per hour
XII A	14.2	14	4	0 45 45 45	0.921 1.104 1.020 0.852	3	19.2	15	3	0 45 25 45	0.669 0.697 0.959 0.967
XV A	15.5	17	8			4	20.0	16	1		
XVIII A	31.4	17	2			X A	17.8	17	6		
XXI A	17.0	17	11			XI A	23.0	17	2		
XXIII A	22.0	13	0			XVI A	22.6	16	4		
						XIX A	25.3	17	7		
Average	20.0	78	25 (32%)	—	0.974		21.3	98	23 (23%)	—	0.823

The average size in each group is about the same, and the sex incidence for all goats of Series III is the same. The results therefore appear to show that the males are 32% less susceptible and produce 17% less CO<sub>2</sub>—a result which cannot be correlated with theory.

The only experiments made with the animals grouped according to their susceptibilities gave much more rational results. Great care was taken in this series to make the conditions as nearly identical as possible in all four observations; the animals were kept in the dark and remained quite quiet throughout. The results show a CO<sub>2</sub> production by the susceptible animals one-sixth less than that of the non-susceptible.

*Influence of blood volume.* The volume of the blood was determined in 8 goats, in 7 of which the susceptibility to caisson symptoms had been ascertained. The method used was the simple one of Welcker, in which, after taking a standard sample of arterial blood, the animal is bled to death and then thoroughly washed out with salt solution. The



408 *The Prevention of Compressed-air Illness*

TABLE XXI.

Animals							Respiration					
No. of goat	Sex	Weight	Total		Selected		No. of expt.	Temp.	Bar. m.m.	Duration in hours	CO <sub>2</sub> gms. per hour	
			Decomp. <sup>1</sup>	Ill	Decomp.	Ill					per kilo	per 1000 sq. cms.
1	M	18.6	15	0	10	0						
XIA	M	20.8	16	1	11	1	I	12°	776	5	0.717	1.853
XVIII A	F	30.7	14	0	10	0	III	14°	775	5	0.751	1.941
XXIII A	F	25.2	12	0	8	0						
Average		23.8	57	1 (2%)	39	(2½%)					0.734	1.897
<i>Susceptible goats.</i>												
XVA	F	15.0	15	6	10	4						
XXIA	F	15.4	15	8	10	6	II	14°	775	5	0.624	1.501
XIX A	M	21.3	15	7	10	5	IV	13°	766	5	0.704	1.693
XIII A	F	25.2	16	5	11	2						
Average		19.2	61	26 (43%)	41	17 (41%)					0.664	1.597

<sup>1</sup> These figures are given up to the date at which the respiration experiments were made. Some time elapsed before the final susceptibilities were ascertained: these were 8% for the non-susceptible group and 45% for the susceptible animals.

tissues were not afterwards extracted with water: the red colouring matter so obtained is so small in amount that it can have little influence on the final result, and Douglas<sup>1</sup> has shown that additional difficulties are thereby introduced. For purposes of calculation the specific gravity of the blood has been taken as 1050. The results and the decompression records of the goats are given in the two following tables. The figures should be read in relation to the "clean" weight, i.e. the crude weight less the weight of the contents of the alimentary canal, which in these animals is very considerable.

The results seem to indicate that there are two types of blood volume in goats: one about 7½% of the clean body weight and the other about 6½%, the first type being also associated with a higher percentage of haemoglobin. No relation between blood volume and susceptibility is apparent; thus goats 2 and XIII, both males, have identical blood volumes and differ about as widely in their susceptibility as any two goats which have come under our notice.

*Conclusions.* Of the four factors considered in detail, it appears therefore that age, sex and blood volume were without appreciable influence. Pregnancy and a low rate of respiratory exchange seem to favour the occurrence of symptoms.

<sup>1</sup> *Journal of Physiology*, vol. XXXIII. (1906), p. 499.

## A. E. BOYCOTT, G. C. C. DAMANT AND J. S. HALDANE 409

TABLE XXII.

No. of goat	Sex	Whole weight kilos	Weight of contents of stomach and intestines			Mass of blood per cent. of		Haemoglobin p.c. of human standard <sup>1</sup>
			Total kg.	Per cent. of whole weight	Volume of blood c.c.	Whole weight	Clean weight	
1	M	19.9	3.8	19.1	1006	5.31	6.56	74
XIII	M	18.9	4.3	22.7	883	4.91	6.36	—
2	M	18.0	3.7	20.5	874	5.10	6.42	64
X	M	17.0	3.0	17.6	833	5.14	6.25	72
XVI	M	11.3	2.3	20.3	592	5.50	6.91	64
A	F	31.2	5.2	16.7	1874	6.31	7.57	78
XVIII	F	27.1	4.6	17.0	1395	5.41	6.47	75
XVII	F	24.4	4.0	16.4	1520	6.54	7.83	84
Average		21.0	3.9	18.8	1122	5.53	6.80	73
Average of males		17.0	3.4	20.0	838	5.19	6.50	68.5
Average of females		27.6	4.6	16.7	1596	6.09	7.29	79

<sup>1</sup> The red blood corpuscles of goats are very small, about  $4\mu$  in diameter (Jolly, C. R. *Soc. de Biol.*, vol. LXIII (1907), p. 210).

TABLE XXIII.

Pressure 75 lbs.

Exposure minutes	Decomp. minutes	Goat 1	2	X	XIII	XVI	XVII	XVIII
15	30 un.	0	slight bends	0	0	bends	0	slight bends
15	30 un.	0	paraplegia	0	0	0	0	0
15	30 st.	0	0	0	0	0	0	0
15	30 st.	bad bends	bends	0	0	0	0	0
30	30 st.	bends	temp. paral.	bends	0	bends	bends	0
60	30 st.	bends	0	0	bends	0	dyspnoea	0
120	70 un.	bends	paraplegia	0	0	bends	temp. paral.	0
120	70 st.	0	bends	bends	0	0	0	0
15	1	—	—	—	—	bends	—	—
15	10 un.	—	—	bad bends	0	bends	—	—
30	30 un.	—	—	—	—	bends	—	bends
30	30 st.	0	—	0	0	temp. paral.	—	bends
60	30 st.	0	—	0	0	0	—	obscure
120	30 st.	bad bends	—	bad bends	bends	bends	—	bad bends
240	30 st.	—	bad bends	bends	0	temp. paral.	—	bends
240	30 un.	—	—	temp. paral.	—	—	—	—



410 *The Prevention of Compressed-air Illness*

But there are doubtless other particulars which, alone or in combination, are of fundamental importance. Such other factors we have not yet been able to examine in detail. Fatness for example can be gauged only in the dead, and, though we have the distinct impression that the goats which die easily (*i.e.* under circumstances of pressure, exposure and decompression which cause very few severe symptoms and deaths) are fatter than those which are killed with difficulty, we have had no means of extending our observations on this head to the great majority of our animals<sup>1</sup>. Fatness also involves a low rate of respiratory exchange per unit body weight. There are grounds in human experience for holding that age may have an important share in the production of symptoms and Hill and Greenwood have recently shown<sup>2</sup> clearly that young animals (rats, rabbits and cats) are far less susceptible than adults of the same species. All the goats used by us appeared to be adult; in the two cases (XIII A, XXXII A) in which old age had obviously set in, the susceptibility seemed to be somewhat above the average, but the ages of the animals as a whole were unknown. In any case such a factor as old age must be reduced to simpler components before it can be correlated with the theory of decompression.

8. *The pathology of caisson disease in goats.*

We have hitherto dealt exclusively with the symptoms exhibited by the experimental animals rather than with the actual or possible presence of bubbles within them. We have however made a number of observations on the post-mortem appearances of goats after decompression, which may be shortly dealt with here. Most of the animals had died from caisson disease but in other instances they were killed at varying periods after decompression.

The presence of bubbles *in vivo* must be inferred from their discovery post-mortem with considerable caution. The supersaturation of the body may be such that the separation of the gas as bubbles may take place after death. There are reasons for supposing that the living body presents nothing in the way of points or surfaces on which bubbles might arise in the blood and tissues as they do upon the glass and dust in soda-water, and a remote analogy may perhaps be drawn

<sup>1</sup> We have since examined this point by direct analysis of rats and guinea-pigs divided into susceptible and non-susceptible groups by decompression experiments. The results, which will be published in detail later, show that fatness is a very important factor in individual susceptibility to death.

<sup>2</sup> Meeting of Physiological Society, Nov. 1906.



A. E. BOYCOTT, G. C. C. DAMANT AND J. S. HALDANE 411

with the relations of the vessels to the separation of fibrin *intra vitam*. Death may well alter this condition in some degree, and in any case the time factor is of importance as well as the foreign manipulation which examination involves. During life no portion of the blood remains in a supersaturated state for more than the time required for it to return from the tissues to the lungs. We have already seen that the duration of this period is probably of very great importance as regards risk of bubble formation. On cessation of the circulation the blood remains in a supersaturated state for an indefinite period. In one instance at least we have actually observed such post-mortem separation of bubbles: a rabbit was killed immediately after 75 lbs., 2 hours, 31 minutes stages, opened up at once and no bubbles found<sup>1</sup>; an hour later a few bubbles were found in the inferior *vena cava*. In another case bubbles in the bladder were seen to increase considerably in number and volume during the progress of the examination.

The possibility of air being introduced from without into the veins must also be considered. Ewald and Kobert showed that air might be forced into the pulmonary capillaries by an increase of intra-pulmonary pressure such as may occur in severe dyspnoea. We have seen bubbles in large quantities in the meningeal veins, and in small numbers in the superficial veins of a fore-foot, under circumstances which left no reasonable doubt that they had been sucked into the vessels during the somewhat violent manipulations used in opening the skull and skinning the leg respectively.

There is not much doubt that some of our animals which showed no symptoms must have had bubbles present in the blood. Catsaras decompressed a dog in 1 minute after 2 hours exposure at 65 lbs.: it showed no symptoms and was killed 6 hours later, when fine bubbles were found in the blood. Heller, Mager and von Schrötter (pp. 790, 882) record two dogs which were killed 10 minutes after sudden decompression after 65 and 52 minutes at 15 and 18 lbs. respectively: in both cases bubbles were found in the heart<sup>2</sup>, though there is abundant evidence to show that dogs never show any symptoms after decompression from such low pressures. In our own animals attempts were made to see bubbles in the retinal vessels during life. Though an

<sup>1</sup> The vessels and bladder in the rabbit are so thin-walled that bubbles can be seen with certainty if they are present.

<sup>2</sup> On the other hand dogs (showing no symptoms) killed after sudden decompression after 16 minutes exposure at 2.8 atmospheres, 5+ at 3.5, 12 at 4.5 and 5 at 4.7, showed no bubbles in the blood: these were however found in three other dogs after 10+ minutes at 4.0 atmospheres, 16 and 72 at 4.5.



412 *The Prevention of Compressed-air Illness*

excellent view of the fundus may easily be obtained, no bubbles were ever seen even in animals with severe dyspnoea, so that the method cannot be taken as giving any indication of the absence of bubbles in the blood. Some of these animals died and plenty of free gas was found in the retinal vessels post-mortem. Four animals which showed no symptoms were killed within ten minutes after decompression with the following results:

TABLE XXIV.

Series and number of goat	Pressure lbs.	Exposure (actual) minutes	Decompression minutes	Bubbles in blood	Results of similar experiments in other goats			
					Number	Bends	Severe symptoms	Death
3: XXVI A	25	120	$\frac{1}{2}$	absent	23	2	0	0
1: II	45	26	6	absent	15	3	0	0
2: XIV	75	19	31 stages	present	29	5	0	0
1: 1	78	30	9	absent	4	0	0	1

These goats were killed before the expiration of the appropriate period for the development of bends. The experience of similar experiments indicates that they might have shown symptoms if they had not been killed. Yet three out of four had no bubbles in the blood. A few observations on rabbits on the other hand gave rather different indications. Seven rabbits in seven different experiments were exposed to 75 lbs. for periods of from 15 to 120 minutes and killed immediately after decompression in 31 minutes by stages. There is no question but that it would be the very rarest occurrence for a rabbit to have any symptoms under these circumstances, but in four of the animals we found bubbles in the heart or great veins. These may however have been formed post-mortem, and in one such case they were observed to appear some time after death.

The post-mortem appearances observed may now be shortly described. It should be remembered that most of the animals dealt with here died under circumstances of experiment less severe than those of other observers. The pressure was in almost all cases 75 lbs. and in a majority of instances the decompression was not instantaneous. These considerations probably afford the explanation of the somewhat less emphatic changes which we have noted. The naked eye appearances were in nearly every case supplemented by microscopical examination of many of the organs.

*Lungs.* The amount of blood in the lungs depends upon the condition of the heart: in severe cases, with the pulmonary artery choked with bubbles and the right heart distended, they are pale and bloodless; in other instances the quantity of blood appears about normal.



## A. E. BOYCOTT, G. C. C. DAMANT AND J. S. HALDANE 413

Haemorrhages may occur and small blood clots are not infrequently found in the trachea. A very marked, scattered, lobular emphysema is almost constant; the only explanation appears to be that some bronchioles are more or less impervious during decompression. Examination of fresh material showed that bubbles may burst out of the capillaries into the interstitial tissue of the lungs, and presumably therefore also into the alveoli. The same was found in rabbits which were killed by the injection of small quantities of air into the veins. Nothing resembling the exudative process seen in oxygen poisoning was ever found in animals exposed to simple air pressures.

In all fatal cases (with one exception) more or less abundant bubbles were found in the blood. In severe, rapidly fatal cases, the right heart is much distended with bubbles, the pulmonary vessels plugged with froth and the left heart nearly empty. The block in the pulmonary artery may indeed be so complete that the left auricle is collapsed and puckered up. In other animals, which have lived for 20, 30 or 60 minutes or longer, the two sides of the heart are equally full of blood and the right heart is not distended. The immediate cause of death, in all but three cases, which died many hours after decompression, was clearly pulmonary air embolism, and this is doubtless the cause of the urgent dyspnoea already noted. In two cases death ensued without any dyspnoea. Both these animals were intentionally killed by very severe experiments, viz. 75 lbs. for 1 hour (goat XXI) and 3 hours (XVIII A) with decompression in  $1\frac{3}{4}$  and 1 minutes. Both showed no symptoms for 5 minutes and collapsed and died quietly in 10 and 12 minutes respectively. Such animals must be regarded as being so overwhelmed by sudden asphyxiation that they exhibit only the symptoms of deficiency of oxygen and not those of the accumulation of carbon dioxide.

The fatal case in which no bubbles were found in the blood post-mortem was in goat XXVII A. After 75 lbs., 15 minutes, 42 seconds it showed pain, ate part of a note-book, and became paraplegic. It was found dead next morning<sup>1</sup>. In several other cases of delayed death, and in one (XVI A) in which the animal died in 3 hours<sup>2</sup>, the quantity of bubbles found seemed to be altogether inadequate to produce a fatal result. One may suppose that they had been previously more

<sup>1</sup> Heller, Mager and v. Schrötter (p. 852) record a case in a dog fatal in 6 hours after decompression in which no free gas was found in the vessels.

<sup>2</sup> This animal had however been recompressed and died under a state of recompression: see protocol e, Appendix III.



414 *The Prevention of Compressed-air Illness*

numerous and that oxygen starvation resulted in death at a time when the aeration of the blood had been restored. This form of delayed death from deficiency of oxygen is well-known in *e.g.* carbon monoxide poisoning. It might be for instance that temporary obstruction of the coronary arteries or portal capillaries caused fatal degenerative changes in the heart muscle or liver cells.

The distribution of the bubbles in the different parts of the vascular system shows several peculiarities. If only a few are present, all may be collected in the smaller branches of the pulmonary artery with none in the right heart. The left heart generally contains a few bubbles; the amount there and in the arteries roughly varies inversely with the rapidity of death unless decompression has been very quick. Smallness in the amount of bubbling affords the heart the best chance of being able to pass on the froth to the arteries, and cases which die slowly seem to show distinctly more arterial bubbles than those which expire almost at once. The veins contain variable quantities of bubbles, but always more than the arteries. They are especially abundant in the mammary, mesenteric, spermatic and portal veins, coronary vessels, and notably few in the veins on the surface of the stomach and in those of the brain and spinal cord. In several instances we have noticed great accumulations of froth in the liver while the spleen at the same time showed no bubbles in the blood flowing out on section. This massive portal embolism is probably the cause of the multiple small capillary haemorrhages which are frequently seen in the omentum and mesentery. Blocking of the portal circulation might also give rise to general symptoms of a very serious character.

It should be noted that the liver is particularly badly situated for getting rid of excess gas during and after decompression; nearly all the blood reaching it is already partly saturated by passing through the intestines, &c. The liver also contains much fat.

*Lymph.* The lymph in the thoracic duct has been noted to be full of froth on several occasions.

*Other liquid areas.* Bubbles have very seldom been found in the *aqueous humour*; the blood supply is considerable, so that their absence is probably to be attributed to the excess gas being carried off during decompression and the period which the supersaturation phenomenon adds, for practical purposes, to the actual time occupied in reducing the pressure to normal. The *vitreous humour*, on the other hand, has a poor blood supply and its consistence is such that any bubbles forming there would remain *in situ*. On only one occasion have bubbles been found



## A. E. BOYCOTT, G. C. C. DAMANT AND J. S. HALDANE 415

(goat XXVI, 75 lbs., 2 hours, 31 minutes stages), when they were seen in a layer close against the ciliary body. Their absence is explicable on the ground that the vitreous humour would take a very long time to saturate. The *bile* often contains bubbles: they were noted in one goat exposed at 75 lbs. for 15 minutes and killed immediately after decompression in 31 minutes stages, and in 8 animals exposed to the same pressure for 1—4 hours, but not in two animals exposed for 15 minutes which died 30 minutes after decompression in 10 minutes and 30 minutes uniformly respectively. The *urine* found in the bladder post-mortem is remarkably free from bubbles; on two occasions only has free gas been found. We have evidence here that the phenomenon must be due to supersaturation and the absence of "points," since we have very frequently observed goats pass urine after decompression which frothed freely on coming into contact with foreign surfaces. This is often seen in animals which show no symptoms. Thus in one experiment, seven goats were exposed at 45 lbs. for one hour and decompressed in 30 seconds. One had bends 19 minutes later. Within 24 minutes after decompression four animals passed urine; in two cases this frothed up freely as it ran over the pavement while in the other two (including the goat which had bends) no bubbles could be observed. It is somewhat striking to observe the transparent bladder of the rabbit containing urine quite free from bubbles while the vesical veins coursing over its surface are full of froth. The *cerebro-spinal fluid* rarely shows any bubbles: they have been seen only three times, in all cases after long exposures (1 to 3 hours) at 75 and 51 lbs. with sudden decompression. *Synovial fluid* is almost always full of bubbles; exposure for 15 minutes at 75 lbs. is sufficient to cause their presence, while decompression in 100 minutes uniformly is not enough to prevent their formation. In animals which have died within 3 hours of decompression, we have found them in every case. *Amniotic fluid* is dealt with below. Bubbles have been seen after very severe experiments in the *pericardial* and *peritoneal fluids* when present, and in the serous contents of a mammary cyst, but not in the milk. We have not seen any accumulations of gas in the serous cavities.

*Solid organs.* Fat commonly shows bubbles, often in extreme abundance. They are more numerous in the abdominal than in the subcutaneous fat; the latter is much more vascular. Other solid organs for the most part show no bubbles outside the blood vessels; a few are sometimes found in the liver and the spinal cord may contain large numbers. In the liver it is very difficult to determine whether any



416 *The Prevention of Compressed-air Illness*

bubble is inside a capillary or not, and we have failed to find clear evidence of bubbles outside blood-vessels, still less actually within tissue cells, in cardiac or skeletal muscle, spleen, kidney, suprarenal, salivary glands, thymus, thyroid and parathyroid, pancreas, lymphatic glands, haemolymph glands, nerves, posterior root ganglia, testis, ovary or mammary gland, though an extensive systematic histological examination has been made of more than 20 goats exposed at 75 or 45 lbs. for from 10 minutes to 4 hours and decompressed in from 30 seconds to 100 minutes.

This condition has no very obvious explanation. It is curious, for instance, to see the spermatic vein (and sometimes artery as well) full of froth and yet find no evidence of bubbles in the tissues which it drains: the same thing is also shown most strikingly in the mammary gland and vessels. There can be no doubt that these tissues must be fairly completely saturated in 4 hours and it is impossible that the excess should be removed from the tissues more quickly than from the blood. It follows that the blood must stand in an unfortunate relation towards bubbling in that it effervesces with a smaller difference of pressure, within and without, or with the same difference of pressure in a shorter time, than do the more solid organs. It seems unlikely that this difference depends on the motion of the blood. Rhythmical pulsating circulation through a smooth elastic system can hardly function as a shaking which would be efficient in bringing out free gas. Even if it did, it is not easy to see why the tissues are not affected by the pulsations in the same way, though perhaps not to the same degree, since isolated collections of fluid, as in the joints, may bubble very easily. One can only suppose that the dissolved particles of gas find in the tissues obstacles, visible and invisible, more obstructive to their aggregation into bubbles than those occurring in the blood.

Bubbles once formed in the blood will also increase in size more readily, since their movement will continuously keep them in contact with fresh portions of supersaturated liquid.

Among the solid organs, bubbles outside the vessels are found most frequently in the central nervous system. The fatty nature of this tissue is probably important in this respect. The brain is singularly free, both by direct examination and by the study of secondary degenerations. The cord may however contain numerous bubbles, and a study of their occurrence and distribution gives interesting results. In the first place they may occur in areas of softening after comparatively mild experiments (*e.g.* 45 lbs., 2 hours, 10 minutes): in this case



A. E. BOYCOTT, G. C. C. DAMANT AND J. S. HALDANE 417

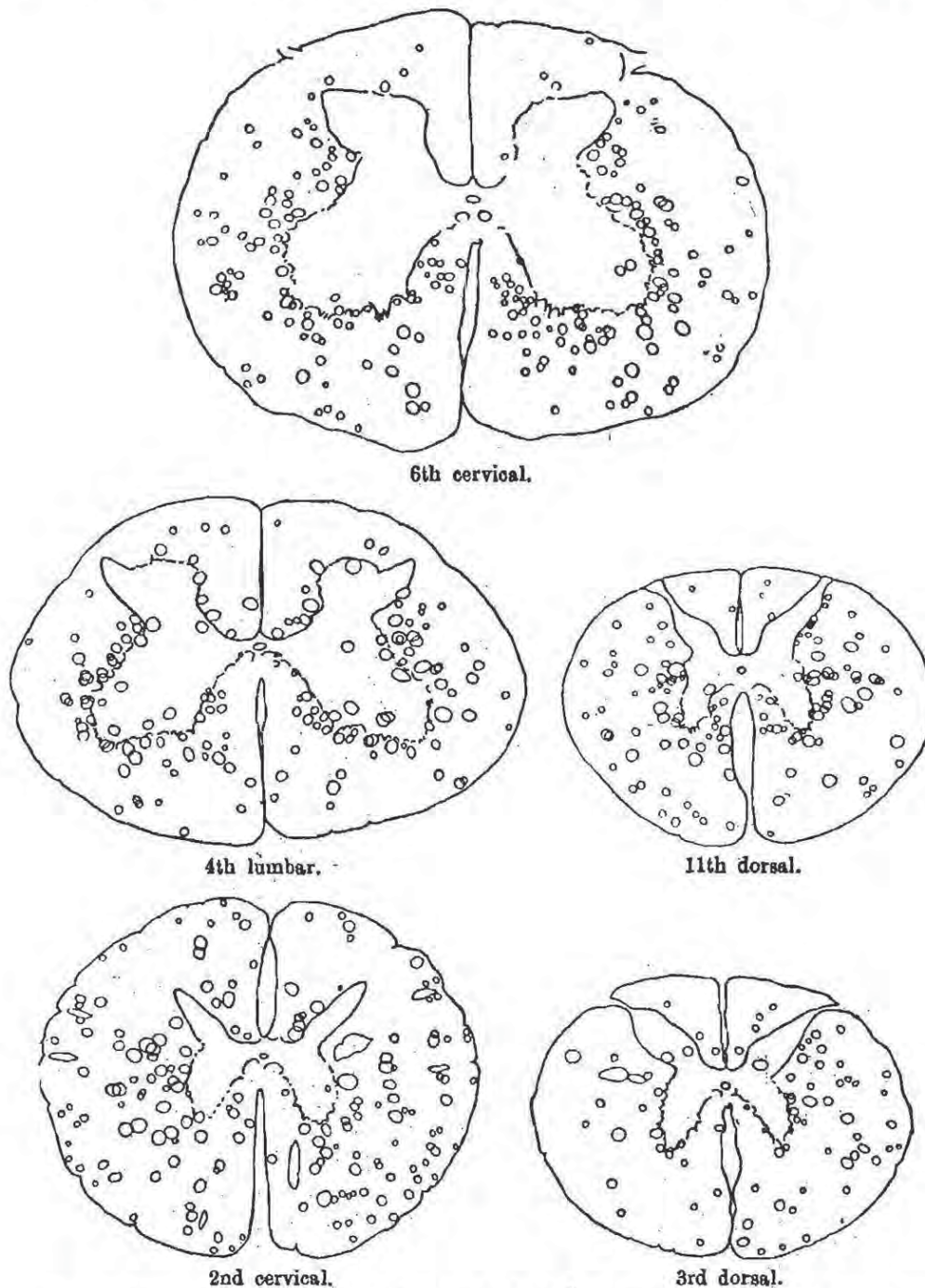

Fig. 7. Shows the distribution of extravascular bubbles in five regions of the spinal cord of goat 3 (series IV). The animal died of oxygen poisoning soon after the beginning of a decompression of 133 minutes duration by stages after 3 hours exposure at 81 lbs. in an atmosphere containing 36% oxygen. The bubbles are practically confined to the white matter and are there especially concentrated in the boundary zone where the circulation is least good. Each diagram is a composite drawing showing all the bubbles in 0.4 mm. length of cord.

418 *The Prevention of Compressed-air Illness*

they are confined to the area in which the circulation has been brought to a sudden standstill by a collection of gas. On the other hand they may be found in the cords of animals which have died immediately after a drastic decompression. This is however rather exceptional. Thus the cords of three animals decompressed in less than a minute after 1 hour at 100 lbs. and 1 and 2 hours at 75 lbs. contained numerous bubbles, while in two animals treated in the same way after exposure at 75 lbs. for 1 and 3 hours respectively, none were found.

The distribution of the bubbles when numerous is in harmony with the theoretical conclusions derived from the blood supply. They are for instance least numerous in those segments with an abundant blood supply (lumbar enlargement), and are almost confined to the white matter, those found in the grey substance being distributed along its periphery towards the boundary zone between the superficial and deep vessels. Thus one cord (goat XXI: 75 lbs., 1 hour, 1½ minutes) contained the following bubbles in 412 cubic millimetres in different parts:

Segment	Grey matter	Posterior columns	Ant.-lat. columns	White matter	Total
2nd cervical	14	141	215	197	175
5th dorsal	11	23	95	87	79
1st lumbar	0	32	161	140	140
4th lumbar	2	15	37	28	19
Average	7	53	127	113	103

Fig. 7 shows the distribution of bubbles in another case: note the paucity of bubbles in the grey matter and their concentration in the boundary zone.

The distribution of the areas of softening is also important. With one exception, these are most marked in, and usually confined to, the lower dorsal and upper lumbar segments where the blood supply of the cord may on many grounds be surmised to be at its minimum. They affect only the white matter. Now the only parts of the body in which we have found appearances resembling embolic infarction are the white matter of the spinal cord and the fat. The latter has on several occasions been found to contain large and small areas of necrosis. We have obtained no evidence of infarction of the spleen, kidney, heart-muscle, &c. The distribution of small bubbles by the arterial blood stream must be universal. They probably lodge in many places: while they are rapidly pushed forward in the grey matter and in most other tissues, if they lodge among the fatty surroundings of the capillaries of the white matter, or in actual fat, they quickly increase in size to such



## A. E. BOYCOTT, G. C. C. DAMANT AND J. S. HALDANE 419

an extent that their removal becomes impossible. It is also clear that in consequence of the slow circulation in the white matter, and especially in such inactive parts as the lower dorsal segments, bubbles have plenty of time to increase in size in the circulating blood. The condition of supersaturation will also last much longer in the white than in the grey matter. The cause then of these areas of softening in the cord is not ordinary embolism, but embolism which becomes effective to produce infarction by reason of the effect on the size of the embolus of the local conditions of the circulation rather than from any of those peculiarities in the resistance of the different tissues to lack of oxygen, or in the freedom of collateral circulation, which determine the topography of common infarcts.

*The presence of bubbles in the uterine contents.* We may group together here a number of casual observations which have been made on the distribution of bubbles in the foetus and amniotic fluid of pregnant goats dying of caisson disease. The pressure was in all cases 75 lbs.

TABLE XXV.

Number of goat	Exposure minutes	Decompression minutes	Time of death after decompression minutes	Bubbles present in the			Development of foetus
				maternal blood	foetus	amniotic fluid	
XXIII	15	31 stages	30	+	0	0	advanced
XXII	120	31 "	75	+	0	+	"
XX	240	31 "	40	+	live + dead 0	+	6 inch 4 inch
XXI	60	1 $\frac{1}{4}$	10	+	+	+	advanced
XI	240	31 uniform	25	+	0	0	1 inch
XIV	15	31 stages	killed at once	+	0	0	$\frac{1}{2}$ inch
XVIII A	180	1	12	+	+	+	advanced
XXVIII A	180	4 $\frac{1}{4}$	24	+	0	0	$\frac{1}{2}$ inch
XXXII A	180	4	27	+	0	0	4 inch (dead)

These observations seem to be fairly concordant. In 15 minutes the uterine contents have not taken up much excess of gas (XXIII), nor does a dead foetus absorb any (XX, XXXII A). In one hour both foetus and amniotic fluid have taken up abundant excess (XXI), which may, if death be long delayed after a rather slow decompression, be discharged from the foetus more quickly than from the amniotic fluid (XXII)<sup>1</sup>. With a very young foetus, the circulation is probably too

<sup>1</sup> Two pregnant guinea-pigs were exposed for 1 hour at +100 lbs. and decompressed in 34 minutes by stages: they showed no symptoms. On being killed 5 hours later, numerous bubbles were found in the amniotic fluid but nowhere else.



420 *The Prevention of Compressed-air Illness*

active and the bulk of fluid too small to favour bubbling (XI, XIV, XXVIII A).

The amniotic fluid, which contained in this case only a faint trace of proteid, may show the phenomenon of supersaturation to an exquisite degree. In goat XXI it was especially noted that a large bubble was present in the amniotic fluid on removing the uterus from the body. After free shaking to bring out any more gas, the uterus was opened and the contents poured into a glass vessel. Contact with this foreign surface immediately produced a great froth of fine bubbles.

The free gas runs together into one large bubble. Advantage was taken of this convenient circumstance in two instances to make analyses. The samples were collected over water and in XXII analysed at once; in XX they were kept for 20 hours over water before examination and in this case therefore the figures for CO<sub>2</sub> represent minimal and those for oxygen maximal values.

	XXII	XX Live foetus	XX Dead foetus
Total gas c.c.	16	27	10.5
CO <sub>2</sub> per cent.	16.23	6.55	2.73
O <sub>2</sub> " "	1.10	2.14	0.85
N <sub>2</sub> " "	81.90	94.14	96.21
Combustible gas (calculated as CH <sub>4</sub> and H <sub>2</sub> )	0.77	0.17	0.21

These results correspond with those of Bert (pp. 955, 961) of the free gas in the heart: they are not in accord with those of Heller, Mager and von Schrötter (p. 800) who found 15.31 and 7.18 per cent. of oxygen in the free gas collected from the hearts of dogs. It is somewhat significant that if this excess of oxygen is calculated as an air leak, the figures of Schrötter correspond exactly with those of Bert and our analysis XXII.

*Duration of bubbles.* It is difficult to say how long bubbles may remain in the vessels and tissues after their first formation in animals which survive<sup>1</sup>. The question is much complicated by the fact that we have reason to believe that bubbles may continue to form for a long, and quite unknown, time after decompression. This is probably especially marked in cases in which either local blocking of the blood supply has occurred, or the circulation has been slowed generally by a greater or less degree of cardiac and pulmonary obstruction. It would

<sup>1</sup> Zografidi (*Revue de Médecine*, 1907, p. 159) records the finding of numerous bubbles in the peripheral vessels, but not in the heart, of a diver who was paralysed and died 33 days after decompression!



## A. E. BOYCOTT, G. C. C. DAMANT AND J. S. HALDANE 421

appear likely that bubbles once lodged in the lungs would probably stop there for a considerable time, since their gaseous composition would quickly approximate to that of the alveolar air and there would be no considerable difference of tension to encourage their removal. Such results as we have which bear on the matter are collected in the next table. It will be seen that bubbles have been found in the blood of one animal which died two days after decompression (and that in an animal which had shown no dyspnoea) and in the joints up to 26 hours. In the substance of the spinal cord bubbles may persist far longer: in two cases we have found them 15 days after the last exposure to pressure and in one 27 days after the last occurrence of symptoms.

TABLE XXVI.

Goat	Pressure lbs.	Exposure minutes	Decompression minutes	Result hours	Bubbles present in	
					Blood	Joints
XXII (Series I)	75	35	40 stages	died 39	+	-
XXVA	75	120	100 uniform	„ 16½	+	0
XXVIIA	75	15	‡	„ 15*	0	0
XVA	45	120	½	killed 24	0	0
4	45	120	½	„ 26	0	+
XIIIA	45	120	10 uniform	„ 72	0	0
XA	75	10	‡	„ 96	0	0
XXIIIA	45 to -6	180	6	„ 144	0	0

\* Found dead next morning.

A histological point of some practical importance arises in connection with the size of the bubbles found in the blood. The bubbles soon run together into large bullae after death so that it is necessary to make the examinations immediately after death in order to observe approximately the true state of affairs. It will then be found that there are no bubbles so small as to be of strictly microscopic dimensions. Nor are any very small bubbles found in the spinal cord; in any one case all the bubbles are about the same diameter, commonly some 25 microns. The same is true of the bubbles given off on decompressing water, salt solutions, serum, blood, and even such thick solutions as gelatine or agar. At the same time however it is possible to produce bubbles which are truly microscopic and which last some hours in some sticky solutions such as gum and treacle. The energy required to aggregate particles of dissolved gas into a bubble is evidently considerable, and there is the same difficulty in the formation of free gas bubbles from solution in liquids as there is in the separation of liquid particles from solution in gases and of solid particles from solution in liquids.



422 *The Prevention of Compressed-air Illness*

Extremely minute bubbles are unstable in the same way as extremely minute droplets of water condensing from supersaturated air, or salt crystals forming in a supersaturated solution in water: in all cases the tendency is to reduce the free energy (surface tension) by reducing the ratio of surface to mass, and accordingly the smallest bubbles, droplets or crystals as the case may be, are rapidly, in the case of bubbles practically instantaneously, abolished to produce macroscopic masses. This is well seen on watching under the microscope a stream of bubbles coming off some "point" in soda water. It follows that if the concentration of dissolved molecules of gas is not higher than some unknown point, bubbles will not be formed. It is possible that the absence of bubbles from most of the solid tissues is to be explained by this non-existence of very small bubbles and the mechanical difficulties of the rapid aggregation of a sufficient number of molecules to produce large bubbles. It is also doubtless connected with the period of delay in bubble formation whereby an animal, for practical purposes, gains several minutes over the actual time of decompression.

It is reasonable to suppose that the temporary paralyses are due to temporary ischaemia from air bubbles in the vessels. The more lasting palsies are undoubtedly caused by obstruction sufficiently complete to produce softening and necrosis. As already mentioned, the change is confined to the white matter and in nearly all instances affects only the lower dorsal or upper lumbar region. In these segments the bulk of cord destroyed may be very extensive: thus in goat XXIII A fully three-quarters of the lateral columns were destroyed from the eighth dorsal to the second lumbar segment over a length of rather more than five inches, and in goat XV A the softening involved nearly the whole of the lateral columns and parts of the anterior and posterior columns for a length of four and a half inches. Such cases may recover to a remarkable degree, and eventually show objective signs of paralysis so slight as to be hardly perceptible except to those familiar with the individual animals.

The only other tissue in which we have found any signs of the results of circulatory obstructions is the intra-abdominal fat. Large masses of necrosed fat have been occasionally met with, especially in the fat lying below the kidneys. Only late stages have been seen: the necrosed areas are then surrounded by a well-marked ring of giant-cell reaction, and the surface layers are mostly converted into a calcium soap.

No evidence of infarction in other organs has been seen: the rarity



A. E. BOYCOTT, G. C. C. DAMANT AND J. S. HALDANE 423

of such changes seems to afford pretty good evidence that the duration of any obstruction in such organs as the spleen or kidney cannot be very long.

The pathological changes underlying the chief symptoms have been already sufficiently noticed except as regards bends. The exact cause of bends is not known. They have been attributed to bubbling in the central nervous system, chiefly on the ground that human experience shows that they are very frequently bilaterally symmetrical. This fact however cannot be taken as indicating any such origin in view of the complete symmetry of the limbs (where the symptoms occur) and the uniform symmetry of the causative agent throughout the body. In two animals which were killed soon after decompression when they showed bends only, we could find nothing abnormal in the cord, posterior root ganglia, or nerves, and there is abundant evidence from a number of goats that the cause of bends does not produce such lesions in the nervous system as are followed by secondary degeneration which can be revealed by the methods of Marchi or Weigert. The two following goats may be cited in detail as to this point: in neither was any degeneration found. Goat XXI (Series II) was used in seven experiments between November 26th and January 18th: it had bends on December 5th, 11th and 18th (the last being noted as "bad bends"), and dyspnoea, nearly fatal, on January 2nd: it was killed on January 18th. Goat XV A (Series III) was exposed 27 times between February 2nd and June 10th: it had bends on February 2nd, 20th, 22nd, March 3rd, 5th, May 13th, 15th, 27th and June 6th: it was killed on June 11th. Thorough examination of the pons, medulla and cord showed no secondary degeneration in either animal. There are therefore reasons for thinking that the cause of bends is peripheral rather than central. The constant presence of bubbles in the joints has been already mentioned, and they seem to afford a fairly probable explanation of most of the cases. Even in those cases in which the muscles are the seat of pain, it is quite possible that a sensation actually originating in or around the joints is referred to other parts. The joint pains in man are often relieved by flexion, and goats evidently try to obtain ease in the same way (see Plate VI). This fact adds strong confirmation to the conclusion that the origin of the pain is in or about the joints.

We have already seen that bends, while not the first symptom to appear as the duration of exposure to high pressure is increased, are the last symptom to disappear as the decompression is extended, that bends in short arise in parts of the body which saturate and desaturate



424 *The Prevention of Compressed-air Illness*

rather slowly. The synovial fluid satisfies this criterion; on the other hand the tendons and other dense tissues about the joints are not in disagreement with it.

Bends occur with a lower degree of supersaturation with air than any other symptom of compressed-air illness. In goats they are readily produced after exposures to 30 lbs. or less. The fact that only a moderate degree of supersaturation is needed to produce them seems to explain the fact that although they are not the first symptom to appear as the duration of exposure to very high pressure is increased, yet a moderate duration of exposure suffices to produce them, in spite of the fact that they occur in parts of the body with a slow rate of circulation, as shown by the fact that they are the last symptom to disappear as the duration of decompression is prolonged.

## SUMMARY.

1. The time in which an animal or man exposed to compressed air becomes saturated with nitrogen varies in different parts of the body from a few minutes to several hours. The progress of saturation follows in general the line of a logarithmic curve and is approximately complete in about five hours in man and in a goat in about three hours.

2. The curve of desaturation after decompression is the same as that of saturation, provided no bubbles have formed.

3. Those parts of the body which saturate and desaturate slowly are of great importance in reference to the production of symptoms after decompression.

4. No symptoms are produced by rapid decompression from an excess pressure of 15 pounds, or a little more, to atmospheric pressure, i.e. from two atmospheres absolute to one. In the same way it is safe to quickly reduce the absolute pressure to one-half in any part of the pressure scale up to at least about seven atmospheres: e.g. from six atmospheres (75 pounds in excess) to three (30 pounds), or from four atmospheres to two.

5. Decompression is not safe if the pressure of nitrogen inside the body becomes much more than twice that of the atmospheric nitrogen.

6. In decompressing men or animals from high pressures the first part should consist in rapidly halving the absolute pressure: subsequently the rate of decompression must become slower and slower, so that the nitrogen pressure in no part of the body ever becomes mor-



## A. E. BOYCOTT, G. C. C. DAMANT AND J. S. HALDANE 425

than about twice that of the air. A safe rate of decompression can be calculated with considerable accuracy.

7. Uniform decompression has to be extremely slow to attain the same results. It fails because it increases the duration of exposure to high pressure (a great disadvantage in diving work), and makes no use of the possibility of using a considerable difference in the partial pressure of nitrogen within and without the body to hasten the desaturation of the tissues. It is needlessly slow at the beginning and usually dangerously quick near the end.

8. Decompression of men fully saturated at very high pressures must in any case be of very long duration: and to avoid these long decompressions the time of exposure to such pressures must be strictly limited. Tables are given indicating the appropriate mode and duration of decompression after various periods of exposure at pressures up to 90 pounds in excess of atmospheric pressure.

9. Numerous experiments on goats and men are detailed in proof of these principles.

10. The susceptibility of different animals to compressed-air illness increases in general with their size owing to the corresponding diminution in their rates of circulation.

11. The average respiratory exchange of goats is about two-thirds more than that of man; they produce about 0.8 gram. of CO<sub>2</sub> per hour per kilogramme of body weight.

12. The mass of the blood in goats is six and a half or seven and a half per cent. of the "clean" body weight.

13. The individual variation among goats in their susceptibility to caisson disease is very large. There is no evidence that this depends directly on sex, size or blood-volume: there is some evidence that fatness and activity of respiratory exchange are important factors.

14. Death is nearly always due to pulmonary air-embolism, and paralysis to blockage of vessels in the spinal cord by air. The cause of "bends" remains undetermined; there are reasons for supposing that in at least many cases they are due to bubbles in the synovial fluid of the joints.

15. In our experiments bubbles were found post-mortem most freely in the blood, fat and synovial fluid; they were not uncommon in the substance of the spinal cord, but otherwise were very rarely found in the solid tissues.



426 *The Prevention of Compressed-air Illness*

APPENDIX I.

*Details of the experiments made on Lieutenant Damant and Mr A. Y. Catto, Gunner, R.N., in the pressure chamber at the Lister Institute.*

These experiments were undertaken in July, 1906, as a preliminary to actual diving experiments in very deep water.

In the first three or four the decompression was controlled from inside the chamber; in the rest from outside. The subjects remained closed in the chamber for half an hour after each experiment, the engine being also kept running so that recompression could be at once begun if any serious symptom developed. In addition to the actual period of exposure to each pressure, we have noted the virtual period of exposure calculated on the assumption that about half the time occupied in compression must be added (see above, p. 362).

In view of the results with goats, the occurrence of decompression symptoms seemed probable in the more severe experiments. No symptoms were, however, observed, except considerable itching of the skin of the fore-arms where it was uncovered. In the compressed air the well-known alteration in the voice, and corresponding abnormal sensations about the lips and mouth, were very marked at pressures exceeding 60 or 70 lbs.

I. July 25th. Actual exposure to 39 lbs. for one hour. Virtual exposure 69 minutes, decompression in 24 minutes:

Compressed to	...	...	...	...	39 lbs. in 17 minutes.	
Waited at	...	...	...	...	39 "	for 60 "
Decompressed to	...	...	...	...	9 "	in 7 "
Waited at	...	...	...	...	9 "	for 5 "
Decompressed to	...	...	...	...	4 "	in 1 "
Waited at	...	...	...	...	4 "	for 9 "
Decompressed to	...	...	...	...	0 "	in 2 "
						} 24.

II. July 26th. Actual exposure to 50 lbs., 27 minutes. Virtual exposure, 39 minutes. Started at 10.37 a.m. Decompression in 34 minutes:

Compressed to	...	...	...	...	50 lbs. in 24 minutes.	
Waited at	...	...	...	...	50 "	for 27 "
Decompressed to	...	...	...	...	17 "	in 4 "
Waited at	...	...	...	...	17 "	for 6 "
Decompressed to	...	...	...	...	13 "	in 1½ "
Waited at	...	...	...	...	13 "	for 3½ "
Decompressed to	...	...	...	...	9 "	in 2 "
Waited at	...	...	...	...	9 "	for 3 "
Decompressed to	...	...	...	...	4 "	in 2 "
Waited at	...	...	...	...	4 "	for 8 "
Decompressed to	...	...	...	...	0 "	in 4 "

## A. E. BOYCOTT, G. C. C. DAMANT AND J. S. HALDANE 427

III. Same day, 3.3 p.m. Exposure to 55 lbs. for 19 minutes.  
Virtual 33 minutes. Decompression in 31 minutes:

Compressed to	...	...	...	...	55 lbs. in 28 minutes.
Waited at	...	...	...	...	55 " for 19 "
Decompressed to	...	...	...	...	17 " in 4 "
Waited at	...	...	...	...	17 " for 5 "
" "	...	...	...	...	13 " " 5 "
" "	...	...	...	...	9 " " 5 "
" "	...	...	...	...	4 " " 10 "
Decompressed from	...	...	...	4 to 0	" in 2 "

The time taken for decompressing from 17 to 13 lbs., &c., was counted as time at 13 lbs.

IV. July 27th, 10.29 a.m. Exposure to 60 lbs. for 20 minutes.  
Virtual exposure 36 minutes. Decompression in  $37\frac{1}{2}$  minutes:

Compressed to	...	...	...	...	60 lbs. in $30\frac{1}{2}$ minutes.
Waited at	...	...	...	...	60 " for 20 "
Decompressed to	...	...	...	...	22 " in 5 "
Waited at	...	...	...	...	22 " for 5 "
Decompressed to	...	...	...	...	17 " in 1 "
Waited at	...	...	...	...	17 " for 4 "
Decompressed to	...	...	...	...	13 " in $1\frac{1}{2}$ "
Waited at	...	...	...	...	13 " for $3\frac{1}{2}$ "
Decompressed to	...	...	...	...	9 " in 1 "
Waited at	...	...	...	...	9 " for 4 "
Decompressed to	...	...	...	...	4 " in $1\frac{1}{2}$ "
Waited at	...	...	...	...	4 " for $8\frac{1}{2}$ "
Decompressed to	...	...	...	...	0 " in $2\frac{1}{2}$ "

V. Same day, 3.37 p.m. Exposure to 67 lbs. for 18 minutes.  
Virtual exposure 36 minutes. Decompression in 36 minutes:

Compressed to	...	...	...	...	67 lbs. in 36 minutes.
Waited at	...	...	...	...	67 " for 18 "
Decompressed to	...	...	...	...	22 " in 3 "
Waited at	...	...	...	...	22 " for 5 "
Decompressed to	...	...	...	...	17 " in 1 "
Waited at	...	...	...	...	17 " for 4 "
Decompressed to	...	...	...	...	13 " in 1 "
Waited at	...	...	...	...	13 " for 4 "
Decompressed to	...	...	...	...	9 " in 1 "
Waited at	...	...	...	...	9 " for 4 "
Decompressed to	...	...	...	...	4 " in $1\frac{1}{2}$ "
Waited at	...	...	...	...	4 " for $8\frac{1}{2}$ "
Decompressed to	...	...	...	...	0 " in 3 "



428 *The Prevention of Compressed-air Illness*

VI. July 30th, 10.57 a.m. Actual exposure at 74 lbs., 15 minutes.  
 Virtual exposure 35 minutes. Decompression in 42 minutes:

Compressed to	...	...	...	...	74 lbs. in 39 minutes.
Waited at	...	...	...	...	74 " for 15 "
Decompressed to	...	...	...	...	26 " in 4 "
Waited at	...	...	...	...	26 " for 5 "
Decompressed to	...	...	...	...	22 " in 1 "
Waited at	...	...	...	...	22 " for 4 "
Decompressed to	...	...	...	...	17 " in 1½ "
Waited at	...	...	...	...	17 " for 3½ "
Decompressed to	...	...	...	...	13 " in 1 "
Waited at	...	...	...	...	13 " for 4 "
Decompressed to	...	...	...	...	9 " in 1 "
Waited at	...	...	...	...	9 " for 4 "
Decompressed to	...	...	...	...	4 " in 1½ "
Waited at	...	...	...	...	4 " for 8½ "
Decompressed to	...	...	...	...	0 " in 3 "

VII. July 31st, 11.0 a.m. Actual exposure to 80 lbs. for 12 minutes.  
 Virtual exposure, 34 minutes. Decompression in 51 minutes:

Compressed to	...	...	...	...	80 lbs. in 44 minutes.
Waited at	...	...	...	...	80 " for 12 "
Decompressed to	...	...	...	...	31 " in 3 "
Waited at	...	...	...	...	31 " for 5 "
Decompressed to	...	...	...	...	22 " in 1 "
Waited at	...	...	...	...	22 " for 4 "
Decompressed to	...	...	...	...	18 " in 1 "
Waited at	...	...	...	...	18 " for 4 "
Decompressed to	...	...	...	...	15 " in 3 "
Waited at	...	...	...	...	15 " for 2 "
Decompressed to	...	...	...	...	13 " in 1 "
Waited at	...	...	...	...	13 " for 4 "
Decompressed to	...	...	...	...	9 " in 1 "
Waited at	...	...	...	...	9 " for 9 "
Decompressed to	...	...	...	...	4 " in 2 "
Waited at	...	...	...	...	4 " for 8 "
Decompressed to	...	...	...	...	0 " in 3 "



A. E. BOYCOTT, G. C. C. DAMANT AND J. S. HALDANE 429

APPENDIX II<sup>1</sup>.

A DIARY OF THE DEEP DIVING EXPERIMENTS CARRIED OUT OFF  
ROTHESAY, ISLE OF BUTE, FROM H.M.S. *SPANKER*, AUGUST, 1906.

Monday, 20th August.

H.M.S. *Spanker* arrived at Rothesay about 7 p.m., and was met by Drs Haldane and Rees and Mr Catto, Gunner, R.N. Arrangements were made to commence experiments the following day.

Tuesday, 21st August.

All the pumps to be used in the experiments were tested up to a pressure of 200 feet, and the leakage at this pressure measured. The pressure gauges, which had been specially graduated for these experiments, were tested and found to give correct readings. The method of testing employed was to attach the free end of the diving hose to a lead line, and lower it over the side into the sea to the required depth. The pumps were then hove round until there was a free supply of air, and then stopped whilst the reading of the gauge was taken.

The re-compression chamber was tested on the Whitehead torpedo charging column, and it was found that the pressure could be brought up to 40 lbs. on the gauge in 3 minutes. There was a leak of 1 lb. per minute, or, roughly 3 cubic feet. Afterwards Drs Haldane and Rees were compressed up to about 30 lbs. in order to further test the working of the chamber.

In the afternoon both divers made a trial dive in 15 fathoms:

	Lieutenant Damant	Mr Catto
Time of descent	2 minutes	1½ minutes.
„ on bottom	1 hour	1 hour.
„ of ascent	18½ minutes	17½ minutes.
No. 5-minute stops	1 at 30 feet	1 at 20 feet.
„ 10 „ „	1 „ 10 „	1 „ 10 „

Two double pumps were used for each diver in these and the subsequent dives. The divers were perfectly comfortable in moving about on the bottom. It may be mentioned that Lieutenant Damant had not dived previously beyond about 19 fathoms, and had no experience in diving except what he had gained in his course of instruction as a gunnery officer and in experimenting at Portsmouth for the Committee. Mr Catto had much previous experience in diving work, but had never dived beyond 23 fathoms.

<sup>1</sup> Reprinted from the *Report of the Admiralty Committee on Deep Diving, 1907.*

### 430 *The Prevention of Compressed-air Illness*

Wednesday, 22nd August,

H.M.S. *Spanker*, off Rothesay.

In the forenoon Mr Catto descended in 23 fathoms, and in the afternoon Lieutenant Damant did the same :

	Mr Catto	Lieutenant Damant
Time of descent	2 minutes	2½ minutes.
„ on the bottom	20 „	20 „
„ of ascent	35½ „	32½ „
No. 5-minute stops	4 at 50, 40, 30, 20 feet	2 at 50, 40 feet.
„ 10 „ „	1 „ 10 feet	2 „ 20, 10 „

Thursday, 23rd August,

H.M.S. *Spanker*, off Rothesay.

After testing the pumps each diver made a descent to 25 fathoms :

	Lieutenant Damant	Mr Catto
Time of descent	2 minutes	2 minutes.
„ on the bottom	18¾ „	19¼ „
„ of ascent	37¾ „	39¾ „
No. 5-minute stops	3 at 60, 45, 30 feet	3 at 50, 40, 30 feet.
„ 10 „ „	2 „ 20, 10 feet	2 „ 20, 10 feet.

Friday, 24th August,

H.M.S. *Spanker* was taken through the narrows of the Kyles of Bute and anchored off the entrance of Loch Riddon.

In the morning, after the usual tests had been applied to the pumps, Mr Catto descended in 27 fathoms, and in the afternoon Lieutenant Damant went down in a similar depth :

	Mr Catto	Lieutenant Damant
Time of descent	2 minutes ... ..	1 minute 20 seconds.
„ on the bottom	16½ „ ... ..	16¾ minutes.
„ of ascent	55½ „ ... ..	44¼ „
No. 5-minute stops	4 at 60, 50, 40, 30 feet ... ..	4 at 60, 50, 40, 30 feet.
„ 10 „ „	1 at 20 feet. (Diver was employed just under the ship's bottom in examining a propeller which had been slightly injured, for 19½ minutes before coming up.)	2 „ 20, 10 feet.

Saturday, 25th August,

H.M.S. *Spanker*, off Loch Riddon.

The *Spanker* shifted her position slightly, and, after the usual tests of the pumps, both divers descended in 29 fathoms of water :

	Mr Catto	Lieutenant Damant
Time of descent	3 minutes	1½ minutes.
„ on the bottom	14½ „	13½ „
„ of ascent	46 „	48½ „
No. 5-minute stops	4 at 70, 50, 40, 30 feet	4 at 66, 54, 40, 30 feet.
No. 10 „ „	2 at 20, 10 feet	2 at 20, 10 feet.



## A. E. BOYCOTT, G. C. C. DAMANT AND J. S. HALDANE 431

Monday 27th August,

H.M.S. *Spanker*, off Loch Riddon.

Thirty fathoms of water were obtained. Mr Catto was the diver in the morning. The pumps used were Nos. 3604 and 3593. Six men were told off for each pump, in reliefs of 5 minutes. Details of the descent:

Time	Remarks
11.22	Glass screwed up. Depth by lead line 30½ fathoms.
11.23¼	Diver under water.
11.23½	„ down 50 feet.
11.23¾	„ „ 70 „
11.24¼	„ „ 110 „
11.24½	„ „ 150 „
11.24¾	„ „ 180 „ on the bottom. 1 min. 30 secs. in descending. Revolutions averaged 32 per min., but fell to 24 for a short time, owing to the great exertions that were necessary to keep the pumps going at the higher speed. Diver quite comfortable while moving about on the bottom.
11.36¾	Diver called up.
11.38½	„ started up.
11.39¼	„ at 160 feet.
11.39¾	„ „ 140 „
11.40¼	„ „ 120 „
11.41	„ „ 100 „
11.41½	„ „ 70 „ 1st stop. Diver employed in gymnastic exercises. One pump stopped.
11.46½	Diver at 50 feet. 2nd stop.
11.51½	„ „ 40 „ 3rd stop.
11.56½	„ „ 30 „ 4th stop.
12.1¼	„ „ 20 „ 5th stop.
12.11¼	„ „ 10 „ 6th stop. There were no ill-effects. Water jackets gained 20 degrees F.
12.22½	Diver called up.
12.23¾	Glass off.

Afternoon. Lieutenant Damant.

2.14½	Screwed up glass.
2.15¾	Diver under water.
2.16	„ down 70 feet.
2.16½	„ „ 120 „
2.16¾	„ „ 160 „
2.17	„ „ 186 „ on the bottom. 1 minute 20 seconds in descending. Revolutions averaged 30 per minute.
2.29	Diver called up.
2.30	„ started up.
2.31	„ at 170 feet.
2.33	„ „ 120 „ Diver stopped 1½ minutes.
2.33¼	„ „ 70 „ 1st stop.
2.38½	„ „ 50 „ 2nd „



432 *The Prevention of Compressed-air Illness*

Time	Remarks
2.43½	Diver at 40 feet. 3rd stop.
2.48½	" " 30 " 4th "
2.53½	" " 20 " 5th "
3.3½	" " 10 " 6th "
3.13½	" called up.
3.15¼	Glass off. There were no ill-effects. Later in the afternoon, the pumps were tested at different temperatures of the water jacket, to see how the leakage was affected.

Tuesday, 28th August.

In the same locality, Lieutenant Damant made a second descent in 30 fathoms in order to obtain samples of the air in the helmet. The pumps used were Nos. 3588 and 3592 :

Time	Remarks
10.18½	Diver under water.
10.20¼	" on the bottom, 1 minute 40 seconds in going down.
10.34½	" started up.
11.21½	Glass off. Whilst on the bottom, diver took two samples whilst at rest. There was a distinct tide on the bottom, which affected the diver.

*Analysis of Samples.*

No. of sample	CO <sub>2</sub> per cent.	O <sub>2</sub> per cent.	CO <sub>2</sub> production in cubic feet per minute
1st	.32	20.86	.025
2nd	.50	20.43	.041 (? tide)

In the afternoon Mr Catto was in the dress. Pumps Nos. 3588 and 3592 were used :

Time	Remarks
2.17	Glass screwed up.
2.18¼	Diver down 60 feet.
2.19	" " 100 "
2.19½	" " 180 " on the bottom. The diver took down with him a wire hawser to shackle on to a sinker.
2.31¾	Diver called up, but could not come up as he was foul, until—
2.48½	" started up.
2.50½	" at 140 feet.
2.53	" " 100 " 1st stop.
2.56	" " 80 " 2nd "
3.1	" " 60 " 3rd "
3.7	" " 50 " 4th "
3.12	" " 40 " 5th "
3.22	" " 90 " 6th "
3.37	" " 20 " 7th "
3.52	" " 15 " 8th "
4.0	" " 10 " 9th "
4.18½	" on the surface.

434 *The Prevention of Compressed-air Illness*

Time	Remarks
11.8	Glass screwed up.
11.8½	Diver under water.
11.9	„ down 80 feet.
11.9¼	„ „ 120 „
11.9½	„ „ 150 „
11.9¾	„ „ 180 „
11.10¼	„ „ 200 „
11.10½	„ „ 216 „ on the bottom. Revolutions kept at 30 per minute, and the diver had a good supply of air.
11.13½	Diver took samples seated on the shot at the bottom of the rope.
11.15½	„ called up.
11.16¼	„ started up.
11.17	„ at 190 feet.
11.18	„ „ 110 „ Diver stopped to blow off sampling tube.
11.20½	„ „ 90 „ 1st stop.
11.23¼	„ „ 70 „ 2nd „
11.28¼	„ „ 52 „ 3rd „
11.33¼	„ „ 42 „ 4th „
11.39½	„ „ 32 „ 5th „
11.44½	„ „ 22 „ 6th „
11.54½	„ „ 11 „ 7th „
12.4½	„ called up.

There was no light on the bottom, which was of soft mud. The depth by the shot rope was 210 feet. Pressure was 93½ lbs. The gauge showed a pressure of 216 feet of fresh water with the pumps stopped, and 220 feet whilst they were heaving. The actual depth, as carefully measured on the shot rope against the ship's standard measure, was just over 35 fathoms, 210 feet.

In the afternoon Mr Catto made the same descent, and reached 35 fathoms. He found that the air supply was more than ample. He walked out to the end of his distance line, and then took a sample of the air in his helmet:

Time	Remarks
2.12	Screwed up glass. Same pumps as last.
2.12¾	Diver under water.
2.14¾	„ on the bottom. Revolutions reduced to 24, as the diver found the supply too much. He proceeded to the end of his distance line before taking his sample.
2.20½	Diver started up.
2.27¾	„ at 90 feet. 1st stop.
2.30½	„ „ 70 „ 2nd „
2.35¾	„ „ 50 „ 3rd „
2.40¾	„ „ 40 „ 4th „
2.45¾	„ „ 30 „ 5th „
2.50¾	„ „ 20 „ 6th „
3.0¾	„ „ 10 „ 7th „
3.10¾	„ called up.



434 *The Prevention of Compressed-air Illness*

Time	Remarks
11.8	Glass screwed up.
11.8½	Diver under water.
11.9	„ down 80 feet.
11.9¼	„ „ 120 „
11.9½	„ „ 150 „
11.9¾	„ „ 180 „
11.10¼	„ „ 200 „
11.10¾	„ „ 216 „ on the bottom. Revolutions kept at 30 per minute, and the diver had a good supply of air.
11.13½	Diver took samples seated on the shot at the bottom of the rope.
11.15½	„ called up.
11.16½	„ started up.
11.17	„ at 190 feet.
11.18	„ „ 110 „ Diver stopped to blow off sampling tube.
11.20½	„ „ 90 „ 1st stop.
11.23½	„ „ 70 „ 2nd „
11.28½	„ „ 52 „ 3rd „
11.33½	„ „ 42 „ 4th „
11.39½	„ „ 32 „ 5th „
11.44½	„ „ 22 „ 6th „
11.54½	„ „ 11 „ 7th „
12.4½	„ called up.

There was no light on the bottom, which was of soft mud. The depth by the shot rope was 210 feet. Pressure was 93½ lbs. The gauge showed a pressure of 216 feet of fresh water with the pumps stopped, and 220 feet whilst they were heaving. The actual depth, as carefully measured on the shot rope against the ship's standard measure, was just over 35 fathoms, 210 feet.

In the afternoon Mr Catto made the same descent, and reached 35 fathoms. He found that the air supply was more than ample. He walked out to the end of his distance line, and then took a sample of the air in his helmet:

Time	Remarks
2.12	Screwed up glass. Same pumps as last.
2.12¾	Diver under water.
2.14¾	„ on the bottom. Revolutions reduced to 24, as the diver found the supply too much. He proceeded to the end of his distance line before taking his sample.
2.20½	Diver started up.
2.27¾	„ at 90 feet. 1st stop.
2.30½	„ „ 70 „ 2nd „
2.35¾	„ „ 50 „ 3rd „
2.40¾	„ „ 40 „ 4th „
2.45¾	„ „ 30 „ 5th „
2.50¾	„ „ 20 „ 6th „
3.0¾	„ „ 10 „ 7th „
3.10¾	„ called up.



A. E. BOYCOTT, G. C. C. DAMANT AND J. S. HALDANE 435

*Analysis of Samples.*

			Lieut. Damant	Mr Catto
CO <sub>2</sub> per cent.	...	...	.14	.53
O <sub>2</sub> " "	...	...	20.89	20.34
Deficiency of O <sub>2</sub> per cent	...	...	.15	.70

Monday, 3rd September.

Experiments on rest and measured work were carried out, by means of an arrangement of rope and pulleys by which the diver on the bottom raised and lowered a 56 lb. weight suspended in view of those on deck. The heavy rope and blocks used caused great friction and resistance.

Time	Remarks	
2.26	Diver, Mr Catto, descended.	
2.27½	" on bottom, 142 feet.	
2.31	" took sample sitting on the shot.	(No. 1.)
	Two pumps at 30 revolutions per minute.	
	Raised the weight 4 times 5 feet, at the rate of one lift per minute.	
2.36	" took sample.	(No. 2.)
	Raised weight 7 times 5 feet in 5½ minutes.	
2.42	" took sample.	(No. 3.)
2.45	" started up.	
3.23	" on surface, no ill-effects.	
-----		
3.3½	" Lieutenant Damant, started down.	
3.4½	" down 100 feet.	
3.5	" on bottom, 139 feet.	
4.0	" took sample sitting on the shot.	(No. 4.)
	Two pumps at 26 revolutions.	
	Raised weight 5 times in 1½ minutes.	
4.3	" took sample.	(No. 5.)
	Raised weight 3 feet 18 times in 6¼ minutes.	
4.10	" took sample. Pump 24 revolutions.	(No. 6.)
4.13½	" started up.	
4.52½	" at the surface. No ill-effects.	

*Analysis of Samples.*

CO <sub>2</sub>	...	...	.30 per cent.	} Mr Catto. Sample No. 1.
O <sub>2</sub>	...	...	20.72 "	
CO <sub>2</sub>	...	...	.70 "	} " " No. 2.
O <sub>2</sub>	...	...	20.29 "	
CO <sub>2</sub>	...	...	.71 "	} " " No. 3.
O <sub>2</sub>	...	...	20.23 "	
CO <sub>2</sub>	...	...	.18 "	} Lieutenant Damant. Sample No. 4.
O <sub>2</sub>	...	...	20.73 "	
CO <sub>2</sub>	...	...	.73 "	} " " No. 5.
O <sub>2</sub>	...	...	20.12 "	
CO <sub>2</sub>	...	...	.81 "	} " " No. 6.
O <sub>2</sub>	...	...	20.36 "	

436 *The Prevention of Compressed-air Illness*

Tuesday, 4th September.

The *Spanker* was anchored in six fathoms of water, and experiments were made on the bottom by Dr Haldane, Lieutenant Damant, and Mr Catto on the risks of blowing up. After being compressed in the air chamber to teach them to open their Eustachian tubes, Lieutenant and Commander E. V. F. R. Dugmore, Lieutenant G. N. Henson, Jack Haldane (age 13) all made descents in six fathoms of water. This was the first time that these had ever dived in a diving dress, which illustrates the usefulness of the re-compression chamber in the practical teaching of divers.

Wednesday, 5th September.

Exhaustive tests were made as to the leakage of the pumps and composition of the air, with the water jackets at various temperatures. The results are embodied in the Report. These experiments concluded the work undertaken for the Committee.

APPENDIX III.

We give here some illustrative protocols of certain important animal experiments.

1. *Comparison of stage (93 minutes) and uniform (100 minutes) decompression after 2 hours exposure at 75 lbs.*

(a) 15.3.07. Goats 3, 4, X A, XI A, XVI A, XIX A, XXV A.

Started up	...	...	...	10.23	
Reached 75 lbs.	...	...	...	11.3	
Started from 75 lbs.	...	...	...	12.43	} Stage decompression. Total = 93 mins.
"    31½ "	...	...	...	12.49	
"    27 "	...	...	...	12.59	
"    22 "	...	...	...	1.14	
"    18 "	...	...	...	1.29	
"    13½ "	...	...	...	1.44	
"    9 "	...	...	...	1.59	
"    4½ "	...	...	...	2.14	
Reached 0 lbs.	...	...	...	2.16	

XIX A had bends left hind-leg at 2.20. X A passed urine not frothy at 2.27. Rest nil.



A. E. BOYCOTT, G. C. C. DAMANT AND J. S. HALDANE 437

(b) 18.3.07. Goats XII A, XIII A, XV A, XVIII A, XX A, XXI A, XXIII A.

Started up	...	...	...	10.53	
Reached 75 lbs.	...	...	...	11.35	
Started from 75 lbs.	...	...	...	1.14	} Stage decompression. Total = 93 mins.
"    31½ "	...	...	...	1.20	
"    27 "	...	...	...	1.30	
"    22 "	...	...	...	1.45	
"    18 "	...	...	...	2.0	
"    13½ "	...	...	...	2.15	
"    9 "	...	...	...	2.30	
"    4½ "	...	...	...	2.45	
Reached 0 lbs.	...	...	...	2.47	

XX A urine no froth at 2.54. XIII A at 2.55 seemed uneasy in hind-legs and lay down but nothing definite; at 3.0 right hind-leg slight limp and foot-drop; foot-drop very marked at 3.10 and could hardly walk; alright at 4.0. Rest nil.

(c) 14.3.07. Goats XXIV A, XXVI A, XXVII A, XXVIII A, XXIX A.

Started up	...	...	...	10.35	
Reached 75 lbs.	...	...	...	11.14	
Started from 75 lbs.	...	...	...	12.55	} Stage decompression. Total = 93 mins.
"    31½ "	...	...	...	1.1	
"    27 "	...	...	...	1.11	
"    22½ "	...	...	...	1.26	
"    18 "	...	...	...	1.41	
"    13½ "	...	...	...	1.56	
"    9 "	...	...	...	2.11	
"    4½ "	...	...	...	2.26	
Reached 0 lbs.	...	...	...	2.28	

XXIV A showed bends left fore-leg during decompression from 4½ to 0; XXVII A passed urine no froth at 2.32; XXVIII A bends left hind-leg at 2.40. Rest nil.

(d) 12.3.07. Goats XXIV A, XXVI A, XXVII A, XXVIII A, XXIX A.

Started up	...	...	...	12.53	
Reached 75 lbs.	...	...	...	1.1	
Started from 75 lbs.	...	...	...	3.0	} Uniform decompression. Total = 100 mins.
Reached 60 lbs.	...	...	...	3.20	
"    45 "	...	...	...	3.40	
"    30 "	...	...	...	4.0	
"    15 "	...	...	...	4.20	
"    0 "	...	...	...	4.40	



438 *The Prevention of Compressed-air Illness*

XXIX A bleated at about 1 lb., gnawed side, lay down; both fore-legs completely paralysed and hind-legs unsteady; kept head bent round on left side; bleated continually; no dyspnoea till 4.55, when it was moderate; seemed like to die. At 5.10 no dyspnoea, stopped bleating, could just stand. Could walk at 5.35. XXVII A passed very frothy urine at 4.41; both hind-legs bad bends at 4.50, right fore-leg at 5.10. XXIV A left hind-leg partial foot-drop and bends at 4.50; left fore-leg bends at 5.0. XXVIII A bad bends right fore-leg, won't stand up; at 5.0 could not stand, had constant nystagmus, bleated; at 5.10 left hind-leg bad bends, nystagmus stopped, no bleating; walked very badly at 5.30. XXVI A no symptoms.

(e) 19.3.07. Goats 3, 4, X A, XI A, XVI A, XIX A, XXV A.

Started up	...	...	...	10.30	} Uniform decompression, Total = 100 mins.
Reached 75 lbs.	...	...	...	11.14	
Started from 75 lbs.	...	...	...	12.52	
Reached 60 lbs.	...	...	...	1.12	
"  45  "	...	...	...	1.32	
"  30  "	...	...	...	1.52	
"  15  "	...	...	...	2.12	
"  0  "	...	...	...	2.32	

XVI A came out with bad bends left hind and right fore-legs; could hardly walk and kept head twisted round to left; much better at 2.50. XIX A urine at 2.34 full of froth; bends right fore-leg. X A began bleating at 2.38 but showed nothing till 2.44 when he had complete foot-drop right fore-leg and bends left hind-leg; at 2.50 right fore-leg paralysed, could not stand up, left fore-leg also weak; urine at 2.50 a little froth. XXV A cried out a bit, belly very tight, refuses to move, evidently far from well: died between 8 and 8.30 a.m. next day: a good many bubbles in right heart. Rest nil.

(f) 20.3.07. Goats XII A, XIII A, XV A, XVIII A, XX A, XXI A, XXIII A.

Started up	...	...	...	11.5	} Uniform decompression. Total = 100 mins.
Reached 75 lbs.	...	...	...	11.47	
Started from 75 lbs.	...	...	...	1.26	
Reached 60 lbs.	...	...	...	1.46	
"  45  "	...	...	...	2.6	
"  30  "	...	...	...	2.26	
"  15  "	...	...	...	2.46	
"  0  "	...	...	...	3.6	

A goat unknown aborted two fetuses 2 in. long; they were quite warm when found, so probably during decompression. XXIII A very

## A. E. BOYCOTT, G. C. C. DAMANT AND J. S. HALDANE 439

frothy urine at 3.8. XIII A dyspnoea, both hind-legs dragging; at 3.25 lying down, moaning bleat, tongue and lips getting cyanosed, dyspnoea not violent. Made sure it was going to die, but at 3.55 it got up and showed only bends right fore-leg and weakness in both hind-legs. At 5.0 seemed all right. Rest nil.

(2) *The effects of a sudden drop of 51 lbs. in different parts of the scale of absolute pressure.*

(a) 26.3.07. Goats XXIV A, XXVI A, XXVII A, XXVIII A, XXIX A.

Started up	...	...	...	10.0
Reached 75 lbs.	...	...	...	10.46
Left 75 lbs.	..	...	...	1.23
Reached 24 lbs.	...	...	...	1.24½
Left 24 lbs.	...	...	...	2.25
„ 14 „	...	...	...	2.55
„ 8 „	...	...	...	3.18½
Reached 0 lbs.	...	...	...	3.21½ Total = 118½ mins.

No symptoms during decompression. XXVIII A passed frothy urine at 3.23; at 3.31 had bad bends, evidently very uneasy generally; better at 4.0. XXIX A urine no froth at 3.31. Rest nil. (The immediate object of the experiment having been attained, an unwise quickening of the end of decompression gave XXVIII A bad bends.)

(b) 23.5.07. Goats 7, 9, XXX A, XXXII A, XXVII.

Start up	...	...	...	9.55
Reach 75 lbs.	...	...	...	10.35
Left 75 lbs.	...	...	...	1.15
Reach 24 lbs.	...	...	...	1.15.40"
Left 24 lbs.	...	...	...	2.15
„ 14 „	...	...	...	2.45
„ 8 „	...	...	...	3.5
„ 4 „	...	...	...	3.25 Total = 131 mins.

No symptoms during decompression. 7 limped right hind-leg on coming out; urine 3.30 no froth. 9 right hind-leg bends at 3.35. XXXII A urine 3.35 no froth. Rest nil.

(c) 27.3.07. Goats XXIV A, XXVI A, XXVII A, XXVIII A, XXIX A.

Started up	...	...	...	11.0
Reached 51 lbs.	...	...	...	11.80
Left 51 lbs.	...	...	...	2.16
Reached 0 lbs.	...	...	...	2.20½



440 *The Prevention of Compressed-air Illness*

XXVIII A very unsteady on hind-legs at 2.25, passed urine full of froth; legs gave way; at 2.30 lying down grunting, constant nystagmus, mucous membranes not pale; at 2.38 respiratory movements almost stopped; died 2.44 p.m. Ordinary moderate bubbling. XXVII A bends left fore-leg at 2.27, bad; a little left next day. XXIV A left hind-leg bends at 2.29; had pretty marked dyspnoea at 2.40. XXIX A urine 2.40 no froth, seemed uneasy, kept lying down but could make out nothing definite. XXVI A no symptoms.

(d) 24.5.07. Goats 7, 9, XXVII A, XXX A, XXXII A, XXVII.

Started up	...	...	...	...	9.51
Reached 51 lbs.	...	...	...	...	10.15
Started down	...	...	...	...	1.3
Reached 0 lbs.	...	...	...	...	1.7

XXX A, urine 1.10 much froth, no symptoms. XXVII A, bad bends left fore-leg, jumpy hind-legs. 7, bends right fore-leg. 9, bends right fore-leg; slight dyspnoea, bends bad, both hind-legs wobbly; dyspnoea gone by 1.40 and legs alright. XXXII A bleating, won't stand up, dyspnoea; died 1.34 p.m. Bad general bubbling. XXVII bends right fore-leg.

(e) 5.6.07. Goats XII A, XVI A, XXIII A.

Started up	...	...	...	...	9.52
Reached 45 lbs.	...	...	...	...	10.14
Left 45 lbs.	...	...	...	...	12.3
Reached 0 lbs.	...	...	...	...	12.3.33"
„ -6 lbs.	...	...	...	...	12.10

XVI A uneasy at -5 lbs., paraplegic at 12.10, struggling and bleating, dyspnoea. XII A bends right fore-leg 12.19, bleating at 12.28. XXIII A tried to get up at 12.25 but failed once; then got up, right hind-leg paralysed; both gone just afterwards, could just crawl across tank; dyspnoea at 12.28. Raised pressure to atmospheric and opened tank at 1.10. XII A got up and seemed alright. XXIII A and XVI A lay log-like, conscious, breathing slightly and slowly. At 1.40 XXIII A could rest on fore-legs, hind-legs completely paralysed, ate hay; seemed pretty well except for paraplegia at 4.0. (Condition did not improve and it was killed six days later.) XVI A died at 3.20 p.m. A few small bubbles in right auricle and right femoral vein.



A. E. BOYCOTT, G. C. C. DAMANT AND J. S. HALDANE 441

(b) 12. 6. 07. Goats 7, XXIV A, XXIX A, XXX A.

Started up	...	...	...	...	9.55
Reached 39 lbs.	...	...	...	...	10.13
Left 39 lbs.	...	...	...	...	12.4.20"
Reached 0 lbs.	...	...	...	...	12.4.50"
Left 0 lbs.	...	...	...	...	12.6.10"
Reached - 6 lbs.	...	...	...	...	12.11.5"

XXX A bends right fore-leg at 12.13, dyspnoea at 12.30. XXIX A bends right fore-leg at 12.14, lay down, dyspnoea at 12.24. 7 lay down, dyspnoea at 12.14. XXIV A no symptoms. Raised pressure to normal and opened up at 1.15. 7 showed bends left fore-leg and had slight dyspnoea. XXX A seemed alright. XXIV A and XXIX A were very quiet but no definite symptoms. All alright at 3.30.

442 *The Prevention of Compressed-air Illness*

APPENDIX IV.

TABLE I.

*Stoppages during the ascent of a diver after ordinary limits of time from surface.*

Depth		Pressure	Time from surface to beginning of ascent	Approximate time to first stop	Stoppages in minutes at different depths*						Total time for ascent in mins.
Feet	Fathoms	Pounds per square inch			60 ft.	50 ft.	40 ft.	30 ft.	20 ft.	10 ft.	
0-36	0-6	0-16	No limit ...	—	—	—	—	—	—	0-1	
36-42	6-7	16-19½	Over 3 hours	1	—	—	—	—	5	6	
42-48	7-8	18½-21	Up to 1 hour	—	—	—	—	—	—	1½	
			1-3 hours ...	1½	—	—	—	—	5	6½	
48-54	8-9	21-24	Over 3 hours	1½	—	—	—	—	10	11½	
			Up to ½ hour	—	—	—	—	—	—	2	
			½-1½ hours ...	2	—	—	—	—	5	7	
			1½-3 hours ...	2	—	—	—	—	10	12	
54-60	9-10	24-26½	Over 3 hours	2	—	—	—	—	20	22	
			Up to 20 mins.	—	—	—	—	—	—	2	
			20-45 mins. ...	2	—	—	—	—	5	7	
			¾-1½ hours ...	2	—	—	—	—	10	12	
			1½-3 hours ...	2	—	—	—	5	15	22	
60-66	10-11	26½-29½	Over 3 hours	2	—	—	—	10	20	32	
			Up to ¼ hour	2	—	—	—	—	—	2	
			¼-½ hour ...	2	—	—	—	—	5	7	
			½-1 hour	2	—	—	—	3	10	15	
			1-2 hours ...	2	—	—	—	5	15	22	
			2-3 hours ...	2	—	—	—	10	20	32	
66-72	11-12	29½-32	Up to ¼ hour	2	—	—	—	—	2	4	
			¼-½ hour ...	2	—	—	—	3	5	10	
			½-1 hour ...	2	—	—	—	5	12	19	
			1-2 hours ...	2	—	—	—	10	20	32	
72-78	12-13	32-34½	Up to 20 mins.	2	—	—	—	—	5	7	
			20-45 mins. ...	2	—	—	—	5	10	17	
			¾-1½ hours ...	2	—	—	—	10	20	32	
			Up to 20 mins.	2	—	—	—	—	5	7	
78-84	13-14	34½-37	20-45 mins. ...	2	—	—	—	5	15	22	
			¾-1½ hours ...	2	—	—	—	10	20	32	
			Up to 10 mins.	2	—	—	—	—	3	5	
84-90	14-15	37-40	10-20 mins. ...	2	—	—	—	3	5	10	
			20-40 mins. ...	2	—	—	—	5	15	22	
			40-60 mins. ...	2	—	—	3	10	15	30	
			Up to 10 mins.	3	—	—	—	—	8	6	
90-96	15-16	40-42½	10-20 mins. ...	2	—	—	—	3	5	10	
			20-35 mins. ...	2	—	—	—	5	15	22	
			35-55 mins. ...	2	—	—	3	10	15	30	
			Up to 15 mins.	3	—	—	—	3	5	11	
96-108	16-18	42½-48	15-30 mins. ...	3	—	—	3	7	10	23	
			30-40 mins. ...	3	—	—	5	10	15	33	
			Up to 15 mins.	3	—	—	2	3	7	15	
108-120	18-20	48-53½	15-25 mins. ...	3	—	—	5	5	10	23	
			25-35 mins. ...	3	—	—	5	10	15	33	
			Up to 15 mins.	3	—	—	2	5	7	17	
120-132	20-22	53½-59	15-30 mins. ...	3	—	—	5	10	15	33	
			Up to 12 mins.	3	—	—	3	5	5	16	
132-144	22-24	59-64½	12-25 mins. ...	3	—	—	2	5	10	32	
			Up to 10 mins.	3	—	—	3	5	5	16	
144-156	24-26	64½-70	10-20 mins. ...	3	—	—	2	5	10	32	
			Up to 10 mins.	3	—	—	2	3	5	5	
156-168	26-28	70-75	10-16 mins. ...	3	—	2	3	5	7	10	
			Up to 9 mins.	3	—	—	2	3	5	5	
168-180	28-30	75-80½	9-14 mins. ...	3	—	2	3	5	7		
180-192	30-32	80½-86	Up to 13 mins.	3	—	2	3	5	7		
192-204	32-34	86-91½	Up to 12 mins.	3	2	2	3	5	7		

\* During each stoppage the diver should continue to move his arms and legs.



## A. E. BOYCOTT, G. C. C. DAMANT AND J. S. HALDANE 443

TABLE II.

*Stoppages during the ascent of a diver after delay beyond the ordinary limits of time from surface.*

Depth		Pressure Pounds per square inch	Time from surface to beginning of ascent	Approximate time to first stop	Stoppages in minutes at different depths								Total time for ascent in mins.
Feet	Fathoms				80 ft.	70 ft.	60 ft.	50 ft.	40 ft.	30 ft.	20 ft.	10 ft.	
60-66	10-11	26½-29½	Over 3 hours	2	—	—	—	—	—	—	10	30	42
66-72	11-12	29½-32	2-3 hours ...	2	—	—	—	—	—	—	10	30	42
			Over 3 hours	2	—	—	—	—	—	—	20	30	52
72-78	12-13	32-34½	1½-2½ hours	2	—	—	—	—	—	—	20	25	47
			Over 2½ hours	2	—	—	—	—	—	—	30	30	62
78-84	13-14	34½-37	1½-2 hours ...	2	—	—	—	—	—	—	15	30	47
			2-3 hours ...	2	—	—	—	—	—	5	30	30	67
			Over 3 hours	2	—	—	—	—	—	10	30	35	77
84-90	14-15	37-40	1-1½ hours ...	2	—	—	—	—	—	5	15	25	47
			1½-2½ hours ...	2	—	—	—	—	—	5	30	35	72
			Over 2½ hours	2	—	—	—	—	—	20	35	35	92
90-96	15-16	40-42½	1-1½ hours ...	2	—	—	—	—	—	5	15	30	52
			1½-2½ hours ...	2	—	—	—	—	—	10	30	35	77
			Over 2½ hours	2	—	—	—	—	—	30	35	35	102
96-108	16-18	42½-48	40-60 minutes	2	—	—	—	—	—	10	15	20	47
			1-2 hours ...	2	—	—	—	—	5	15	25	35	82
			Over 2 hours	2	—	—	—	—	15	30	35	40	122
108-120	18-20	48-53½	35-60 minutes	2	—	—	—	—	5	10	15	25	57
			1-2 hours ...	2	—	—	—	—	10	20	30	35	97
			Over 2 hours	2	—	—	—	—	30	35	35	40	142
120-132	20-22	53½-59	½-¾ hours ...	3	—	—	—	—	5	10	15	20	53
			¾-1½ hours ...	3	—	—	—	—	5	10	20	30	98
			Over 1½ hours	3	—	—	—	15	30	35	40	40	163
132-144	22-24	59-64½	25-45 minutes	3	—	—	—	3	5	10	15	25	61
			¾-1½ hours ...	3	—	—	—	10	10	20	30	35	108
			Over 1½ hours	3	—	—	—	30	30	35	40	40	178
144-156	24-26	64½-70	20-35 minutes	3	—	—	—	3	5	10	15	20	56
			35-60 minutes	3	—	—	—	7	10	15	30	30	95
			Over 1 hour	3	—	—	20	25	30	35	40	40	193
156-168	26-28	70-75	16-30 minutes	3	—	—	—	3	5	10	15	20	56
			½-1 hour ...	3	—	—	3	10	10	15	30	30	101
			Over 1 hour	3	—	5	25	25	30	35	40	40	203
168-182	28-30	75-80½	14-20 minutes	3	—	—	—	3	3	7	10	15	41
			20-30 minutes	3	—	—	2	2	3	10	15	25	60
			½-1 hour ...	3	—	3	3	7	10	20	30	35	111
			Over 1 hour	3	—	15	25	30	30	35	40	40	218
182-194	30-32	80½-86	13-20 minutes	3	—	—	—	3	3	7	15	15	46
			20-30 minutes	3	—	—	3	3	5	10	15	25	64
			½-1 hour ...	3	—	3	5	10	12	20	30	35	118
			Over 1 hour	3	5	20	25	30	30	35	40	40	228
194-206	32-34	86-91½	12-20 minutes	3	—	—	3	3	5	7	10	20	51
			20-30 minutes	3	—	3	3	3	5	10	20	20	67
			½-1 hour ...	3	3	3	5	10	15	20	30	35	124
			Over 1 hour	3	15	20	25	30	30	35	40	40	238



# Appendix B: Symposium Speakers

---



***Bjørn Alterhaug***  
NTNU



***Costantino Balestra***  
Haute Ecole Paul Henri Spaak



***Jean-Eric Blatteau***  
Toulon Armées, France



***Alf O. Brubakk***  
NTNU

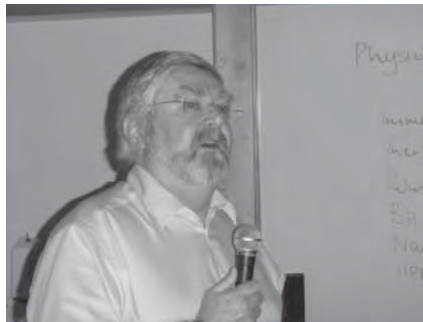

***Stephen Daniels***  
Cardiff University



***David J. Doolette***  
Navy Experimental Diving Unit



***Željko Đujić***  
University of Split, Croatia



***Olav S. Eftedal***  
StatoilHydro ASA



***Øyvind Ellingsen***  
NTNU



**Andreas Fablman**  
Naval Medical Research Center



**Joar Gangenes**  
Acergy



**Mikael Gennser**  
Swedish Defence Research Agency



**Michael L. Gernhardt**  
NASA



**Marit Grønning**  
Haukeland University Hospital



**Christian Gutvik**  
NTNU



**Marianne B. Havnes**  
NTNU

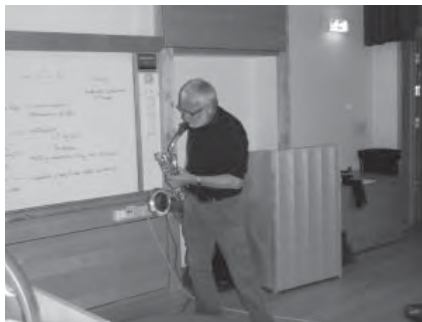

**John Pål Inderberg**  
NTNU



**Susan R. Kayar**  
Booz Allen Hamilton



**Michael A. Lang**  
Smithsonian Institution



**Peter Lindholm**  
Karolinska Institutet



**Svein-Erik Måsøy**  
NTNU

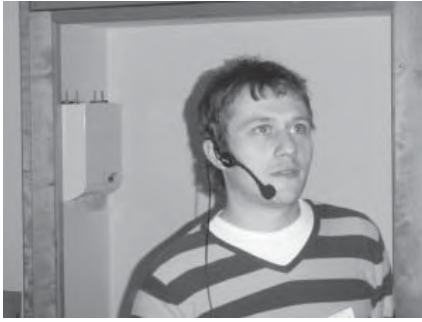

***Andreas Møllerløkken***  
NTNU



***Richard E. Moon***  
Duke University Medical Center



***George A. Perdrizet***  
Morristown Memorial Hospital



***Russell S. Richardson***  
University of Utah



***Stig A. Slørdahl***  
NTNU



***Matthew Swiergosz***  
Office of Naval Research



***Einar Thorsen***  
University of Bergen





# Appendix C: Symposium Participants

---

## SPEAKERS

<b>Name</b>	<b>Affiliation</b>	<b>Email</b>
Bjørn Alterhaug	NTNU	
Costantino Balestra	Haute Ecole Paul Henri Spaak	balestra@daneurope.org
Jean-Eric Blatteau	French Navy	je.blatteau@infonie.fr
Alf O. Brubakk	NTNU	alf.o.brubakk@ntnu.no
Stephen Daniels	Cardiff University	danielss@cardiff.ac.uk
David J. Doolette	Navy Experimental Diving Unit (NEDU)	david.doolette.as@navy.mil
Željko Dujic	University of Split, Croatia	zeljko.dujic@mefst.hr
Olav S. Eftedal	StatoilHydro ASA	OEFT@statoilhydro.com
Øyvind Ellingsen	NTNU	oyvind.ellingsen@ntnu.no
Andreas Fahlman	Naval Medical Research Center	fahlman@zoology.ubc.ca
Joar Gangenes	Acergy	—
Mikael Gennser	Swedish Defence Research Agency	mikaelge@foi.se
Michael L. Gernhardt	NASA	michael.l.gernhardt@nasa.gov
Marit Grønning	Haukeland University Hospital	marit.gronning@helse-bergen.no
Christian Gutvik	NTNU	christian.gutvik@ntnu.no
Marianne B. Havnes	NTNU	marianne.b.havnes@ntnu.no
John Pål Inderberg	NTNU	—
Susan R. Kayar	Booz Allen Hamilton	susan.kayar.ctr@navy.mil
Michael A. Lang	Smithsonian Institution	langm@si.edu
Peter Lindholm	Karolinska Institutet	peter.lindholm@ki.se
Svein-Erik Måsøy	NTNU	svein-erik.masoy@ntnu.no
Andreas Møllerløkken	NTNU	andreas.mollerlokken@ntnu.no
Richard E. Moon	Duke University Medical Center	moon0002@mc.duke.edu
George A. Perdrizet	Morristown Memorial Hospital	george.perdrizet@atlanticehealth.org
Russel S. Richardson	University of Utah	rrichardson@ucsd.edu
Stig A. Slørdahl	NTNU	stig.slordahl@ntnu.no
Matthew Swiergosz	Office of Naval Research	matthew.swiergosz@navy.mil
Einar Thorsen	University of Bergen	einar.thorsen@helse-bergen.no

## PARTICIPANTS

<b>Name</b>	<b>Affiliation</b>	<b>Email</b>
Arnfinn Arnfinsen	Subsea 7	—
John Arne Ask	—	john.ask@ptil.no
Jay Buckley	Dartmouth College	jay.buckley@dartmouth.edu
Rune Djurhus	NUI	rdj@nui.no
Ingrid Eftedal	St. Olav's Hospital, Trondheim	ieftedal@gmail.com
Harald Engan	NTNU	—
Lise Fishmen	NUI	—
Bob Gardiner	MarathonOil	bgardiner@marathonoil.com
Svein Erik Gaustad	NTNU	svein.e.gaustad@ntnu.no
Martin Andre Heer	Acergy	martin@heer.com
Astrid Hjelde	NTNU	astrid.hjelde@ntnu.no
Arvid Hope	NUI	aho@nui.no
Thomas Huerligmann	UWATEC	thomas.huerligmann@uwatec.ch
Jan Erik Jakobsen	Deep-X	jjacobsen@deep-x.com
Dawn Kernagis	Duke University Medical Center	dawn.kernagis@duke.edu
Darin Knaus	Create Inc	clf@create.com
Ingrid Kruger	NTNU	ingridk@stud.ntnu.no
Jason LeGore	UWATEC	jason.legore@uwatec.ch
Berit Linge	Subsea 7	—
Jasna Ljubkovic	Medical School of Split, Croatia	—
Marko Ljubkovic	Medical School of Split, Croatia	—
Angelica Lodin	Mittuniversitetet, Sweden	—
Sjur Lothe	Technip	mlothe@technip.com
Christian Medby	St. Olav's Hospital, Trondheim	christian.medby@stolav.no
Otto Molvær	—	marinmed@frisurf.no
Arvid Päsche	—	—
Scott Philip	Create Inc	—
Jean Michel Pontier	French Navy	jm.pontier@free.fr
Kim Vidar Rasdal	NTNU	kim-vidar.rasdal@ntnu.no
Matt Richardson	Mittuniversitetet, Sweden	matt.richardson@miun.se
John Ross	University of Aberdeen	j.a.ross@abdn.ac.uk
Bjarne Sandvik	PTIL	bjarne.sandvik@ptil.no
Martin D.J. Sayer	NERC Scientific Diving Facility	martin.sayer@sams.ac.uk
Kåre Segadal	NUI	KSEG@statoilhydro.com
Kaj Magnar Sjølie	Havsport Dykkersenter AS	kaj@havspot.no
Leif Tore Skjerven	—	—
Martin Skrove	NTNU	skrove@stud.ntnu.no
Einar Svendsen	—	—
Ulrik Wisløff	NTNU	ulrik.wisloff@ntnu.no