

20

Phenotypes and Endophenotypes

Foundations for Genetic Studies of
Nicotine Use and Dependence

Edited by

Gary E. Swan, Ph.D.

Timothy B. Baker, Ph.D.

Laurie Chassin, Ph.D.

David V. Conti, Ph.D.

Caryn Lerman, Ph.D.

Kenneth A. Perkins, Ph.D.

NCI Tobacco Control Monographs

To cite this monograph in other works, please use the following format:

National Cancer Institute. *Phenotypes and Endophenotypes: Foundations for Genetic Studies of Nicotine Use and Dependence*. Tobacco Control Monograph No. 20. Bethesda, MD: U.S. Department of Health and Human Services, National Institutes of Health, National Cancer Institute. NIH Publication No. 09-6366, August 2009.

This monograph and its supplemental materials may be found electronically at <http://cancercontrol.cancer.gov/tcrb/monographs/20/index.html>.

All NCI Tobacco Control Monographs are available from the Web page: <http://cancercontrol.cancer.gov/tcrb/monographs/index.html>

Recently Published Monographs

Risks Associated with Smoking Cigarettes with Low Machine-Measured Yields of Tar and Nicotine. Smoking and Tobacco Control Monograph No. 13. NIH Pub. No. 02-5047, October 2001.

Changing Adolescent Smoking Prevalence. Smoking and Tobacco Control Monograph No. 14. NIH Pub. No. 02-5086, November 2001.

Those Who Continue to Smoke: Is Achieving Abstinence Harder and Do We Need to Change Our Interventions? Smoking and Tobacco Control Monograph No. 15. NIH Pub. No. 03-5370, September 2003.

ASSIST: Shaping the Future of Tobacco Prevention and Control. Tobacco Control Monograph No. 16. NIH Pub. No. 05-5645, May 2005.

Evaluating ASSIST: A Blueprint for Understanding State-level Tobacco Control. Tobacco Control Monograph No. 17. NIH Pub. No. 06-6058, October 2006.

Greater than the Sum: Systems Thinking in Tobacco Control. Tobacco Control Monograph No. 18. NIH Pub. No. 06-6085, May 2007.

The Role of the Media in Promoting and Reducing Tobacco Use. Tobacco Control Monograph No. 19. NIH Pub. No 07-6242, August 2008.

Contents

Figures and Tables.....	vii
Foreword.....	xi
Message from the Series Editor.....	xiii
Acknowledgments.....	xv
Acronyms and Abbreviations.....	xxiii
Part 1—Overview.....	1
Chapter 1—Overview and Conclusions.....	3
Introduction.....	4
About the Monograph.....	5
Major Accomplishments.....	7
Major Conclusions.....	7
Chapter Summaries and Conclusions.....	8
References.....	18
Chapter 2—Status of Genetic Studies of Nicotine Dependence.....	19
Introduction.....	20
Historical Perspective of Genetic Research on Nicotine Dependence.....	22
Nicotine Dependence: A Construct in Need of Refinement.....	25
Nicotine-Dependence Phenotypes: A Framework.....	27
Genetic Epidemiological Concepts and Their Implications for Studying Nicotine Dependence.....	31
Summary of Selected Biometric and Measured Genetic Studies of Nicotine Dependence.....	37
Issues in Communication of Genetic Findings.....	45
Summary.....	51
References.....	52
Part 2—Theoretical Considerations.....	71
Chapter 3—The Nicotine-Dependence Phenotype: Translating Theoretical Perspectives and Extant Data into Recommendations for Genetic Mapping.....	73
Introduction.....	74
Construct Validation.....	75
Distal Measures of Dependence.....	78
New Directions for Phenotypic Research: Beyond Distal Measures.....	105
Summary.....	118
Conclusions.....	119
References.....	120

Chapter 4—Mouse Models and the Genetics of Nicotine Dependence	133
Introduction	134
Nicotinic Receptor Functional Diversity	135
Routes of Nicotine Administration: Interaction of the Drug with Physiological Systems	145
The Mouse Model of Nicotine Dependence	149
Nicotine and Behavioral Changes	151
Nicotine and Reward	157
Tolerance	162
Additional Directions for Research on the Nicotine-Dependence Phenotype in Mice	168
Summary	171
Conclusions	172
References	173

**Part 3—Developmental Trajectories of Tobacco Use
and Their Relation to Tobacco Dependence 187**

**Chapter 5—Developmental Trajectories of Cigarette Smoking
from Adolescence to Adulthood 189**

Introduction	190
A Developmental Psychopathology Perspective: Studying Multiple Trajectories over Time	191
Empirically Identified Trajectories of Adolescent Smoking	202
Statistical Models for Evaluating Alternative Developmental Phenotypes of Smoking Behavior	214
An Empirical Example: Trajectories in the Indiana University Smoking Survey	223
Future Research Directions	233
Summary	234
Conclusions	235
References	236

Chapter 6—Genetic Modeling of Tobacco Use Behavior and Trajectories 245

Introduction	246
Methodological and Conceptual Issues	247
Statistical Framework	248
Review of Genetic Studies of Smoking	259
Item Response Theory Approach: Application to Virginia Twin Registry Data	269
Limitations	279
Summary	280
Conclusions	280
References	282

**Chapter 7—Trajectories of Tobacco Use from Adolescence to Adulthood:
Are the Most Informative Phenotypes Tobacco Specific? 289**

Introduction	290
Importance of Studying Substance-Use Comorbidity	290

Common Versus Specific Liability to Substance-Use Disorders	292
Review of Trajectory Literature.....	295
Associations between Substance-Use Trajectories and Other Substance Involvement.....	296
Modeling Conjoint Trajectories of Substance Use.....	298
Empirical Example of Modeling Co-Occurring Courses of Substance Use	307
Method.....	307
Results	310
Summary	323
Conclusions	324
References.....	326

Part 4—Endophenotypes337

**Chapter 8—Endophenotypes for Nicotine-Dependence Risk at or before
Initial Nicotine Exposure 339**

Introduction	340
Endophenotypes.....	340
Smoking Initiation and Progression Risk: Examination of Key Candidate Psychological Domains.....	346
Initial Nicotine Exposure Response: Conceptual Framework and Candidate Endophenotypes.....	363
Discussion of Future Directions.....	381
Summary	384
Conclusions	385
References.....	386

Chapter 9—Nicotine-Dependence Endophenotypes in Chronic Smokers..... 403

Introduction	404
Rationale for Investigating Endophenotypes of Chronic Nicotine Exposure	406
Motivational Mechanisms	410
Acute Smoking or Abstinence Effects on Cognitive, Affective, and Physiological Function	424
Discussion and Recommendations for Future Research.....	452
Summary	457
Conclusions	458
References.....	459

Part 5—Epidemiological and Methodological Considerations485

**Chapter 10—Epidemiological Analysis of Variation in Phenotypic Definitions:
A Proof of Concept Using an Example of a Cessation Phenotype 487**

Introduction	488
The Proposed Approach.....	492
Method.....	494
Summary.....	503

Conclusions	504
References.....	506
Chapter 11—Incorporating Social Context into Genetic Studies of Nicotine Dependence.....	509
Introduction	510
Why Incorporate the Social Context?.....	511
Behavioral Genetic Studies of Smoking That Incorporate Social Context.....	514
Proximal Measures of the Social Context	518
Future Directions.....	527
Summary.....	531
Conclusions	532
References.....	533
Chapter 12—Using Ontologies in Hierarchical Modeling of Genes and Exposure in Biological Pathways.....	539
Introduction	540
Methodological Issues.....	541
Background on Statistical Approaches.....	543
Methods	550
Example: Nicotine Metabolism	562
Discussion.....	570
Summary.....	573
Conclusions	574
Appendix 12A. Estimation for the Hierarchical Model.....	575
Appendix 12B. Model Selection Algorithm	577
References.....	579
Part 6—Future Directions	585
Chapter 13—Future Directions.....	587
Introduction	588
Genetics and Nicotine Dependence: Implications for Basic and Clinical Research.....	588
Future Directions.....	591
References.....	597
Index	599

Figures and Tables

Figures

Figure 2.1	Cigarette Consumption in the United States in the Twentieth Century	20
Figure 2.2	Trajectories as Phenotypic Pathways	23
Figure 2.3	Multipoint Linkage Plot—Chromosome 6	41
Figure 2.4	Multipoint Linkage Plot—Chromosome 7	41
Figure 2.5	Multipoint Linkage Plot—Chromosome 8	42
Figure 3.1	Nomological Net: Evaluation Context for a Model of Dependence and Its Relation to Genetic Variants	76
Figure 3.2	Watershed Model of Gene-to-Phenotype Influence	78
Figure 3.3	Etiologic Path and Locus of Phenotypic Assay.....	83
Figure 3.4	Logistic Regression Curves Predicting Scores on the WISDM Subscales from Cigarettes Smoked per Month: Examples of an Early-Emergent Motive (Social/Environmental Goals) and a Late-Emergent Motive (Tolerance).....	91
Figure 3.5	Latent Class Results from the Combined Data Set	92
Figure 3.6	Associating Genes with Phenotypic Stages	109
Figure 4.1	Nicotinic Receptor Subunit Structure.....	137
Figure 4.2	Three-Dimensional Structure of the Nicotinic Acetylcholine Receptor	138
Figure 4.3	Influence of Subunit Composition on Nicotinic Receptors	139
Figure 4.4	Nicotinic Receptors of Closely Related Subunit Composition Differing in Function through Variation in Subunit Stoichiometry	140
Figure 4.5	Genetic Influences on Nicotine Tolerance and Self-Administration	146
Figure 5.1	Five-Class Solution for Waves 1–6.....	226
Figure 5.2	Six-Class Solution for Waves 1–8.....	228
Figure 6.1	Basic Path Diagram for the Analysis of Data Collected from Pairs of Monozygotic and Dizygotic Twins	250
Figure 6.2	Three-Factor Latent Phenotype Model	252
Figure 6.3	Causal Contingent Common Pathway Model	253
Figure 6.4	Estimates of the Contributions of Additive Genetic and Shared Environmental Factors to Smoking Initiation by Sample, Age, and Gender in Published Studies of Adolescent Twins	261
Figure 6.5	Estimates of the Contributions of Additive Genetic Factors in Common with Initiation, Total Additive Genetic, and Shared Environmental Factors to Smoking Persistence by Sample, Gender, Age, and Measure of Persistence	265

Figure 6.6	Estimates of Factor Loadings and Thresholds of Nicotine-Dependence Items in Female Twins from the Virginia Twin Registry	272
Figure 6.7	Estimates of Factor Loadings and Thresholds of Nicotine-Dependence Items Plotted by Gender and Measurement Instrument (FTQ or FTND Scale).....	273
Figure 6.8	Estimates of Nicotine-Dependence Item Characteristic Curves for 20-Year-Old Females	275
Figure 6.9	Estimates of Factor Loadings, Thresholds, Genetic Variance Components Due to the Factor, and Residual Item-Specific Genetic Variance Components in Virginia Twin Registry Males	277
Figure 7.1	Prevalence of Smoking and Drinking across the Four Study Waves	309
Figure 7.2	Underlying General Growth Mixture Model for Characterizing Trajectories of Smoking and Trajectories of Drinking and for Characterizing Conjoint Trajectories of Smoking and Drinking	311
Figure 7.3	Trajectories of Smoking and Drinking	314
Figure 7.4	Trajectories of Conjoint Drinking and Smoking	316
Figure 8.1	Hierarchical Structural Model and Hypothesized Physiological Concomitants.....	345
Figure 8.2	Example of How Potential Endophenotypes Can Link Genes to Nicotine-Dependence Risk at or before Initial Nicotine Exposure.....	347
Figure 9.1	Example of How Potential Endophenotypes Can Link Genes to Nicotine-Dependence Risk	409
Figure 10.1	Phenotype Choice Points along the Smoking Trajectory.....	490
Figure 10.2	Example of Phenotypic Comparison for Drug Response Using the Proposed Approach.....	491
Figure 10.3	Example of Phenotypic Comparison for Progression to Daily Smoking (Behavior of Interest) Using the Proposed Approach	491
Figure 10.4	Example of Phenotypic Comparison for Sustained Smoking Cessation (Behavior of Interest) Using the Proposed Approach	492
Figure 11.1	Located Cigarette Vendors in Rhode Island.....	521
Figure 11.2	Located Cigarette Vendors in Massachusetts	522
Figure 11.3	Percentage of Diary Responses Endorsing Cigarette Use Stratified by Social Contexts.....	530
Figure 11.4	Pattern of Endorsed Smoking Epochs over a Six-Day Period for a Concordant Sibling Pair.....	531
Figure 12.1	Evolutionary and Structural Analyses for the <i>CYP2A6</i> *2 Variant	555
Figure 12.2	Examples of Networks	556
Figure 12.3	Shrinkage of Test Statistics.....	567
Figure 13.1	Some Examples of Hypothetical Gene to Phenotype Pathways	590

Tables

Table 2.1	Results from the Genome-wide Association Study of Nicotine Dependence.....	44
Table 2.2	Results from the Candidate Gene Study of Nicotine Dependence.....	44
Table 2.3	Pleiotropic Associations of Genetic Variants Implicated in Smoking	48
Table 3.1	Subscales of the Wisconsin Inventory of Smoking Dependence Motives	85
Table 3.2	Dimensions on Which Groups Might Be Constructed to Contrast Putative High- and Low-Dependence Predispositions.....	96
Table 3.3	Causal Paths from Genetic Variant to Distal Phenotypes.....	102
Table 3.4	Levels of Analysis in Characterizing the Phenotype	109
Table 5.1	Studies of Smoking Trajectories	203
Table 5.2	Trajectory Group Sizes and Relationship with Gender and Educational Attainment.....	227
Table 5.3	Stability of Classification across the Waves 1–6 and Waves 1–8 Models	229
Table 5.4	Relationship of Trajectory Group Membership to Family History of Smoking.....	231
Table 5.5	Relationship of Trajectory Group Membership to Smoking Dependence Indices in Wave 8	231
Table 6.1	Number of Alleles Shared Identical by Descent for a Pair of Full Siblings.....	258
Table 6.2	Results from Fitting Measurement Noninvariance and Gender Heterogeneity Models to Nicotine Initiation and Dependence Data Collected from Twins	274
Table 7.1	Overview of the Literature on Conjoint Trajectories of Substance Use	300
Table 7.2	Correlations across Smoking and Drinking at Each of the Four Waves for the Full Sample	312
Table 7.3	Fit Indices and Likelihood Ratio Tests for Relative Improvement in Fit for Smoking, Drinking, and Dual Smoking and Drinking	313
Table 7.4	Cross-Tabulations of Frequency and Cell Proportions of Group Membership for Smoking and Drinking for the Full Sample	315
Table 7.5	Cross-Tabulations of Frequency (Cell Proportion) of Group Membership for Twin 1 Versus Twin 2 (across Zygosity) for Smoking and for Drinking.....	318
Table 7.6	Cross-Tabulations of Frequency (Cell Proportion) of Group Membership for Twin 1 Smoking by Twin 2 Drinking and Twin 2 Smoking by Twin 1 Drinking.....	319
Table 8.1	Extant Data on Potential Endophenotypes and Their Measurement.....	355
Table 9.1	Putative Endophenotypes for Nicotine Dependence: Motivational Mechanisms and Nicotine or Abstinence Effects	453

Table 9.2	Putative Endophenotypes for Nicotine Dependence: Acute Smoking or Abstinence Effects	453
Table 10.1	A Comparison of the Data Sets and Variables Used in the Analyses Presented in This Chapter	494
Table 10.2	Results from the Analysis of the ATBC Study Data.....	496
Table 10.3	Results from the Analysis of TUS-CPS Data.....	499
Table 10.4	Results from the Analysis of NHANES III Data	502
Table 11.1	Sibling Partners Diary Prompts.....	528
Table 12.1	Results for Nicotine Clearance	566
Table 12.2	Results for 3HC/COT Ratios	569

Foreword

The twentieth volume of the Tobacco Control Monograph series of the National Cancer Institute reviews the scientific foundation for genetic studies of nicotine use and dependence. The authors and editors perform an admirable job synthesizing the expanding literature in the field and developing a scientific blueprint for the integration of genetic approaches into transdisciplinary studies of nicotine dependence. This seminal work should be examined in the context of global public health action on tobacco prevention and control as well as advances in genomics and related technologies.

It is important to ask how genetic studies of nicotine use and dependence can contribute to the overall public health effort in tobacco control and prevention. For, despite public health efforts, an estimated 45 million people in the United States still smoke. Globally, one billion individuals smoke tobacco on a regular basis, and millions of individuals die yearly from illnesses related to tobacco. A “one size fits all” public health approach has not been fully successful. All available tools will be needed to meet the demand for effective and sustainable tobacco control, including pharmacogenetic-informed treatments and social policy interventions for smoking cessation.

Clearly, tobacco use in a population is the product of the interaction of agent, genetic, and environmental factors. Government policies are important modifiable environmental influences that can alter how tobacco products are designed and marketed and how consumers respond. Understanding individual variation in responses to tobacco can help our approach to different programs, policies, and treatments for nicotine dependence. Synergy occurs when tobacco control and prevention interventions directed at agent, host, and environmental factors are implemented together. However, no studies have adequately addressed simultaneously genetic variation, quantitative measures of behavioral, social and cultural variation, and the interaction among these sources of variation. This gap reflects the disciplinary silos that were not uncommon in the 20th century scientific enterprise.

A few short years after the completion of the Human Genome Project in 2003, we continue to witness growing scientific discoveries on the genetic contribution to common diseases of public health significance, such as cancer, coronary heart disease, and diabetes. The emergence of genome-wide association studies over the past two years has contributed to the acceleration of genetic discoveries. In addition, the number of genetic and genomic tests used in clinical practice continues to grow, including pharmacogenomic applications in clinical practice. A new era of personalized health and healthcare seems to be on the horizon. For diseases related to tobacco use, we are seeing increasing numbers of important genetic discoveries. The need for a wider range of valid phenotypes of nicotine dependence has driven the development of this monograph. The scientific analysis and synthesis presented in this monograph will undoubtedly further the field of behavioral genetics.

Muin J. Khoury, M.D., Ph.D.
Director
National Office of Public Health Genomics
Centers for Disease Control and Prevention
July 2009

Message from the Series Editor

This volume is the twentieth of the Tobacco Control Monograph series of the National Cancer Institute (NCI). The series began in 1991 with a visionary blueprint for public health action on tobacco prevention and control. In the years since, it has disseminated important cross-cutting research in areas such as the impact of tobacco control policies, the risks associated with smoking cigars and low-tar cigarettes, systems approaches to tobacco control, and the role of media in promoting and reducing tobacco use.

The subject matter of this monograph began with an informal review and critique of the behavioral genetics literature related to smoking. This review showed that genotyping is restricted to only a few phenotypes (usually current and former smokers) and that standard definitions of smoking behavior are not commonly used. For example, in the United States, an “ever smoker” has been defined generally in the epidemiology and surveillance literature as someone who has smoked at least 100 cigarettes in his/her entire life. Similarly, there is consensus about the need to separate current smokers into “every day” and “some days” smokers. This distinction is rarely made in smoking genetics research. The lack of use of standard definitions of these and other aspects of tobacco use behavior (for example, smoking cessation) not only hinders comparisons among genetics studies, but also the ability to put results from these studies into context of knowledge gained from other disciplines. The need for standard definitions and measures of tobacco use behavior is critical to furthering our understanding of the genetic and environmental determinants of tobacco use.

Much of the tobacco literature examines genetic susceptibility to smoking initiation and cessation only among very broad groups without an understanding of the complexities or variations within these categories in patterns of smoking behavior. Combining very different subgroups of smokers into a few common phenotypes (for example, the current smoking phenotype often includes both light and intermittent smokers with heavy daily smokers) and then using such heterogeneous groups in research studies may be hindering progress in our understanding the role of genetics in complex behaviors such as smoking.

Another limitation of genetics research is that it is often based on small, nonrepresentative samples of the population, which limits the generalizability and interpretability of the findings. The frequency of genetic variants determined from nonprobability-based samples may not reflect the true underlying frequency in the general population. Therefore, epidemiologic and etiologic conclusions based on these results may be misleading. Only through the analysis of population-based samples will we be able to examine the relative contribution of genetics and environment, as well as gene-gene interactions and gene-environment interactions, to explaining variations in tobacco use behavior, dependence, and disease risk. Population-level genetic analyses will also help us determine if previously identified genetic variants are truly associated with smoking and whether conflicting findings in the literature are due to population stratification (selection bias).

Finally, while the effect of single genetic variants is likely to be small for complex behaviors such as smoking, previous research has not studied the joint effects of different genetic variants on tobacco use behavior, dependence, and disease risk. Large, national samples are needed to allow us to examine the potential impact of these multiple genetic variants.

This monograph was originally intended to demonstrate the need for standard definitions of tobacco use behavior and to explore the utility of using epidemiologic data from national surveys, as well as data from a multitude of other sources (such as smoking topography) and disciplines (such as psychology and pharmacology) to identify unique smoking phenotypes for genetic analysis. In addition, the original proposal called for exploring the conceptual and measurement issues related to describing the entire continuum of smoking behavior, from the first few adolescent puffs to “hardcore” dependence. Several steps were outlined to achieve these objectives: (1) synthesize the existing literature; (2) conduct original data analyses and develop innovative methods to address the research gaps; (3) examine the application and usefulness of the potential phenotypes for genetic, epidemiologic, and behavioral research; and (4) make recommendations for future conceptualization (theory/model building), methods development (new measurement, innovative analytic approaches), and new data collection and empirical research.

Researchers within and outside NIH also reached the conclusion around this same time that there were a number of questions, including those related to behavioral genetics, which could be most effectively addressed only if a clear definition for nicotine dependence was developed. These researchers, many of whom have subsequently edited or authored this monograph, were particularly interested in finding ways to define various groups of smokers along meaningful dimensions (such as dependence) that could help to advance the field of behavioral genetics of smoking. One of the most significant obstacles identified in behavioral genetics research of smoking was the lack of valid and useful phenotypes.

Although the content of this monograph has changed somewhat to focus more on nicotine dependence phenotypes, it has remained true to the original vision. The publishing of this monograph comes at a critical time. The field of behavioral genetics is evolving rapidly. Efforts are underway to develop core sets of standardized measures to use in genetic studies. The need to identify a broad range of homogeneous phenotypes of nicotine dependence has never been clearer. While the literature on the relationship between genetic variation and treatment outcomes was not addressed, new and important discoveries presented in this monograph concerning the assessment, development, and maintenance of nicotine dependence may help clinicians target interventions more effectively—to specific components of nicotine dependence and to windows of opportunity for more precise timing of intervention delivery. Moreover, more refined phenotypes may provide more sensitive indicators of the impact of treatment for nicotine dependence and, ultimately, lead to a stronger evidence base for pharmacogenetically-informed treatments.

Moreover, a better understanding of the role of genetic susceptibility may help the public health community enhance already effective public policies for tobacco prevention and control. Much progress in reducing tobacco use has already been made and much is already known to work; however, even in this context, knowledge gained from genetic studies may play an important role in designing new and innovative environmental and policy interventions. We hope the science presented in this monograph guides the field for many years to come.

Stephen E. Marcus, Ph.D.
Monograph Series Editor
July 2009

Acknowledgments

This monograph was developed by the National Cancer Institute under the general direction of **Stephen E. Marcus**, Monograph Series Editor, and Senior Scientific Editor **Gary E. Swan**, along with Scientific Editors **Timothy B. Baker**, **Laurie Chassin**, **David V. Conti**, **Caryn Lerman**, and **Kenneth A. Perkins**.

Monograph Series Editor

Stephen E. Marcus, Ph.D.

Epidemiologist
Tobacco Control Research Branch,
Behavioral Research Program
Division of Cancer Control and Population
Sciences
National Cancer Institute
National Institutes of Health
Bethesda, MD

Senior Scientific Editor

Gary E. Swan, Ph.D.

Director
Center for Health Sciences
SRI International
Menlo Park, CA

Scientific Editors

Timothy B. Baker, Ph.D.

Professor
Center for Tobacco Research & Intervention
Department of Medicine
School of Medicine and Public Health
University of Wisconsin
Madison, WI

Laurie Chassin, Ph.D.

Regents Professor of Psychology
Department of Psychology
Arizona State University
Tempe, AZ

David V. Conti, Ph.D.

Assistant Professor
Zilkha Neurogenetic Institute
Keck School of Medicine
Department of Preventive Medicine
Division of Biostatistics
University of Southern California
Los Angeles, CA

Caryn Lerman, Ph.D.

Mary W. Calkins Professor
Department of Psychiatry and Annenberg
Public Policy Center
Deputy Director, Abramson Cancer Center
University of Pennsylvania
Philadelphia, PA

Kenneth A. Perkins, Ph.D.

Professor of Psychiatry
University of Pittsburgh
Pittsburgh, PA

Authors

Janet Audrain-McGovern, Ph.D.

Associate Professor
Department of Psychiatry
University of Pennsylvania
Philadelphia, PA

Erik Augustson, Ph.D., M.P.H.

Tobacco Control Research Branch
Behavioral Research Program
National Cancer Institute
Rockville, MD

Timothy B. Baker, Ph.D.

Professor
Center for Tobacco Research & Intervention
Department of Medicine
School of Medicine and Public Health
University of Wisconsin
Madison, WI

Andrew W. Bergen, Ph.D.

Director, Molecular Genetics Program
Center for Health Sciences
SRI International
Menlo Park, CA

Neal L. Benowitz, Ph.D.

Professor of Medicine, Psychiatry and
Biopharmaceutical Sciences
Chief, Clinical Pharmacology
University of California, San Francisco
San Francisco, CA

Laura Jean Bierut, M.D.

Professor of Psychiatry
Washington University School of Medicine
St. Louis, MO

Avshalom Caspi, Ph.D.

Professor
Departments of Psychology & Neuroscience
and Psychiatry & Behavioral Sciences, and
Institute for Genome Sciences & Policy
Duke University
Durham, NC
and
Social, Genetic, and Developmental
Psychiatry Research Centre
Institute of Psychiatry
King's College London
England

Laurie Chassin, Ph.D.

Regents Professor of Psychology
Department of Psychology
Arizona State University
Tempe, AZ

David V. Conti, Ph.D.

Assistant Professor
Zilkha Neurogenetic Institute
Keck School of Medicine
Department of Preventive Medicine
Division of Biostatistics
University of Southern California
Los Angeles, CA

Patrick J. Curran, Ph.D.

Professor
Department of Psychology
The University of North Carolina at
Chapel Hill
Chapel Hill, NC

Stephen E. Gilman, Sc.D.

Assistant Professor
Department of Society, Human
Development, and Health
Department of Epidemiology
Harvard School of Public Health
Boston, MA

Thomas J. Gould, Ph.D.

Associate Professor of Psychology
Center for Substance Abuse Research
Director of the Brain, Behavior, and
Cognition Area of Psychology
Temple University
Philadelphia, PA

Kristina M. Jackson, Ph.D.

Associate Professor (Research)
Department of Community Health
Center for Alcohol and Addiction Studies
Brown University
Providence, RI

Jaakko Kaprio, M.D., Ph.D.

Department of Public Health
Faculty of Medicine
University of Helsinki
and
Department of Mental Health and
Alcohol Research
National Public Health Institute
Helsinki, Finland

Caryn Lerman, Ph.D.

Professor
Department of Psychiatry
University of Pennsylvania
Tobacco Use Research Centers
Philadelphia, PA

Christina N. Lessov-Schlaggar, Ph.D.

Genetic Epidemiologist
SRI International
Menlo Park, CA

Juan Pablo Lewinger, Ph.D.

Assistant Professor
Department of Preventive Medicine
University of Southern California
Los Angeles, CA

Hermine H. Maes, Ph.D.

Associate Professor
Department of Human and Molecular
Genetics and Massey Cancer Center
Virginia Institute for Psychiatric and
Behavioral Genetics
Virginia Commonwealth University
Richmond, VA

Terrie E. Moffitt, Ph.D.

Professor
Departments of Psychology & Neuroscience
and Psychiatry & Behavioral Sciences, and
Institute for Genome Sciences & Policy
Duke University
Durham, NC
and
Social, Genetic, and Developmental
Psychiatry Research Centre
Institute of Psychiatry
King's College London
England

Michael C. Neale, Ph.D.

Professor
Departments of Psychiatry and
Human Genetics
Virginia Institute for Psychiatric and
Behavioral Genetics
Virginia Commonwealth University
Richmond, VA

Joel T. Nigg, Ph.D.

Professor
Department of Psychiatry
Oregon Health & Sciences University
Portland, OR

Kenneth A. Perkins, Ph.D.

Professor of Psychiatry
University of Pittsburgh
Pittsburgh, PA

Clark C. Presson, Ph.D.

Professor
Department of Psychology
Arizona State University
Tempe, AZ

Richard Rende, Ph.D.

Associate Professor of Psychiatry and
Human Behavior
The Warren Alpert Medical School of
Brown University
Research Psychologist
Transdisciplinary Research Group
Butler Hospital
Providence, RI

Scott W. Rogers, Ph.D.

Professor
Neurobiology & Anatomy
University of Utah
Salt Lake City, UT

Richard J. Rose, Ph.D.

Professor Emeritus
Department of Psychological and Brain
Sciences
Indiana University
Bloomington, IN

Kenneth J. Sher, Ph.D.

Curators' Professor of Psychological
Sciences
University of Missouri-Columbia
Columbia, MO

Steven J. Sherman, Ph.D.

Professor
Department of Psychological and
Brain Sciences
Indiana University
Bloomington, IN

Alexandra E. Shields, Ph.D.

Director
Harvard/MGH Center on Genomics,
Vulnerable Populations & Health
Disparities
Boston, MA

Cheryl Slomkowski, Ph.D.

Assistant Professor
Psychiatry and Human Behavior
Brown University Medical School
Providence, RI

Gary E. Swan, Ph.D.

Director
Center for Health Sciences
SRI International
Menlo Park, CA

Paul D. Thomas, Ph.D.

Evolutionary Systems Biology Group
Artificial Intelligence Center
SRI International
Menlo Park, CA

Rachel F. Tyndale, M.Sc., Ph.D.

Canada Research Chair in Pharmacogenetics
Section Head Pharmacogenetics
Centre for Addiction and Mental Health
Professor
Department of Pharmacology
University of Toronto
Toronto, Ontario, Canada

Michael Vanyukov, Ph.D.

Associate Professor
Departments of Pharmaceutical Sciences,
Human Genetics, and Psychiatry
University of Pittsburgh
Pittsburgh, PA

Kay Wanke, Ph.D., M.P.H.

Office of Behavioral and Social Sciences
Research
Office of the Director
National Institutes of Health
Bethesda, MD

R. J. Wirth, Ph.D.

Statistician
FPG Child Development Institute
The University of North Carolina at
Chapel Hill
Chapel Hill, NC

Reviewers

Rebecca Ashare

Doctoral Candidate
Department of Psychology
University at Buffalo, SUNY
Buffalo, NY

David Balfour, Ph.D.

Professor of Behavioural Pharmacology
Psychiatry Section, Centre for
Neuroscience
College of Medicine, Dentistry, and Nursing
University of Dundee
Dundee, United Kingdom

Neal L. Benowitz, Ph.D.

Professor of Medicine, Psychiatry and
Biopharmaceutical Sciences
Chief, Clinical Pharmacology
University of California, San Francisco
San Francisco, CA

Lisa Bero, Ph.D.

Professor
Department of Clinical Pharmacy
School of Pharmacy and Institute for Health
Policy Studies
School of Medicine
University of California, San Francisco
San Francisco, CA

Daniel M. Bolt, Ph.D.

Professor
School of Education
Department of Educational Psychology
University of Wisconsin
Madison, WI

Dorret Boomsma, Ph.D.

Professor, Department of Biological
Psychology
Vrije Universiteit Amsterdam
Amsterdam, Netherlands

Naomi Breslau, Ph.D.

Professor
Department of Epidemiology
Michigan State University
East Lansing, MI

Nilanjan Chatterjee, Ph.D.

Senior Investigator
Division of Cancer Epidemiology and
Genetics
National Cancer Institute
Rockville, MD

Ralph J. Coates, Ph.D.

Associate Director for Science
National Center for Public Health Genomics
Centers for Disease Control and Prevention
Atlanta, GA

Kevin P. Conway, Ph.D.

Deputy Director
Division of Epidemiology, Services and
Prevention Research
National Institute on Drug Abuse
Bethesda, MD

K. Michael Cummings, Ph.D, M.P.H.

Department of Health Behavior
Division of Cancer Prevention and
Population Sciences
Roswell Park Cancer Institute
Buffalo, NY

Lisa C. Dierker, Ph.D.

Professor of Psychology
Department of Psychology
Wesleyan University
Middletown, CT

Joseph DiFranza, M.D.

Professor
Department of Family Medicine and
Community Health
University of Massachusetts Medical School
Worcester, MA

Conor Dolan, Ph.D.

Department of Psychology
University of Amsterdam
Amsterdam, Netherlands

David J. Drobes, Ph.D.

Professor, Oncologic Sciences & Psychology
University of South Florida
Senior Member, Tobacco Research and
Intervention Program
Moffitt Cancer Center
Tampa, FL

Phyllis Ellickson, Ph.D.

Senior Behavioral Scientist
RAND
Santa Monica, CA

Stanton Glantz, Ph.D.

Professor of Medicine
American Legacy Foundation Distinguished
Professor in Tobacco Control
Department of Medicine
Division of Cardiology
University of California, San Francisco
San Francisco, CA

George J. Hammons, Ph.D.

Professor and Chair
Department of Chemistry
Philander Smith College
Little Rock, AR

Larry W. Hawk, Ph.D.

Associate Professor
Department of Psychology
The University of Buffalo, SUNY
Buffalo, NY

Kenneth S. Kendler, M.D.

Director
Virginia Institute for Psychiatric and
Behavioral Genetics
Rachel Brown Banks Distinguished
Professor of Psychiatry
Medical College of Virginia
Virginia Commonwealth University
Richmond, VA

Barbara A. Koenig, Ph.D.

Professor of Medicine
Departments of Medicine and Psychiatry
Mayo Clinic College of Medicine
Rochester, MN

Pamela Madden, Ph.D.

Associate Professor in Psychiatry
Washington University in St. Louis
Department of Psychiatry
Washington University School of Medicine
St. Louis, MO

Athina Markou, Ph.D.

Professor
Department of Psychiatry
School of Medicine
University of California, San Diego
La Jolla, CA

Michael J. Marks, Ph.D.

University of Colorado
Institute for Behavioral Genetics
Boulder, CO

Colleen M. McBride

Chief & Senior Investigator
National Human Genome Research Institute
National Institutes of Health
Bethesda, MD

Paras Mehta, Ph.D.

Associate Professor
University of Houston
Department of Psychology
Houston, TX

Robin J. Mermelstein, Ph.D.

Director, Institute for Health Research
and Policy
Professor, Psychology Department
Clinical Professor, Community Health
Sciences
University of Illinois at Chicago
Chicago, IL

Marcus Munafò, Ph.D.

Reader in Biological Psychology
Department of Experimental Psychology
University of Bristol
Bristol, United Kingdom

Joel T. Nigg, Ph.D.

Professor
Department of Psychiatry
Oregon Health & Sciences University
Portland, OR

Mark Parascandola, Ph.D., M.P.H.

Epidemiologist
Tobacco Control Research Branch
National Cancer Institute
National Institutes of Health
Rockville, MD

Ovide Pomerleau, Ph.D.

Professor
University of Michigan
Ann Arbor, MI

Soo Hyun Rhee, Ph.D.

Assistant Professor
Department of Psychology and Neuroscience
University of Colorado
Boulder, CO

Jed E. Rose, Ph.D.

Professor, Department of Psychiatry and
Behavioral Sciences
Director, Center for Nicotine and Smoking
Cessation Research
Duke University Medical Center
Durham, NC

Nancy L. Saccone, Ph.D.

Assistant Professor of Genetics
Department of Genetics
Division of Human Genetics
Washington University in St. Louis
St. Louis, MO

John Schulenberg, Ph.D.

Professor of Psychology
Research Professor, Institute for Social
Research and Center for Human Growth
and Development
University of Michigan
Ann Arbor, MI

Alexandra E. Shields, Ph.D.

Director
Harvard/MGH Center on Genomics,
Vulnerable Populations & Health
Disparities
Boston, MA

Saul Shiffman, Ph.D.

Professor of Psychology, Psychiatry, and
Pharmacology
University of Pittsburgh
Pittsburgh, PA

Wendy Slutske, Ph.D.

Professor
University of Missouri-Columbia
Department of Psychological Sciences
Columbia, MO

Mariana C. Stern

Assistant Professor
Preventive Medicine (Division of
Epidemiology)
Keck School of Medicine
University of Southern California/Norris
Comprehensive Cancer Center
Los Angeles, CA

Duncan C. Thomas, Ph.D.

Professor, Co-Director Biostatistics Division
Preventive Medicine
Division of Biostatistics
Keck School of Medicine
University of Southern California
Los Angeles, CA

Rachel F. Tyndale, M.Sc., Ph.D.

Canada Research Chair in Pharmacogenetics
Section Head Pharmacogenetics
Centre for Addiction and Mental Health
Professor
Department of Pharmacology
University of Toronto
Toronto, Ontario, Canada

Cornelia Ulrich, Ph.D.

Member
Cancer Prevention Program
Fred Hutchinson Cancer Research Center
Seattle, WA

Jennifer B. Unger, Ph.D.

Professor of Community and Global Health
Claremont Graduate University
Claremont, CA

Michael Vanyukov, Ph.D.

Associate Professor
Departments of Pharmaceutical Sciences,
Human Genetics, and Psychiatry
University of Pittsburgh
Pittsburgh, PA

Robert West, Ph.D.

Professor of Health Psychology and Director
of Tobacco Studies
Department of Epidemiology and
Public Health
Health Behaviour Research Centre
University College London
London, England

Helene R. White, Ph.D.

Professor
Center of Alcohol Studies
Rutgers, The State University of New Jersey
Piscataway, NJ

Michael Windle, Ph.D.

Chair, Rollins Professor
Department of Behavioral Sciences and
Health Education
Rollins School of Public Health
Atlanta, GA

John Witte, Ph.D., M.S.

Professor and Associate Director
Epidemiology/Biostatistics & Institute for
Human Genetics
University of California, San Francisco
San Francisco, CA

*The editors would like to acknowledge the
publication support services provided for
this monograph:*

American Institutes for Research

Margot Raphael, Project Director and
Managing Editor
Allan R. Clyde, Editor
Bethany Meissner, Project Assistant
Matthew Mowczko, Publication Production

Cygnus Corporation

Jennifer Bishop, Publications Manager
Patricia Spellman, Copyeditor
Mary Bedford, Proofreader

Preparation of this monograph was supported
by the American Institutes for Research
under Contract No. N02-PC-25041 to the
National Cancer Institute.

Acronyms and Abbreviations

5CSRTT	five-choice serial reaction time task
5-HT2A	serotonin 2A (receptor)
6-OHDA	6-hydroxydopamine
A2A	adenosine 2A
Abeta 25-35	amyloid beta-peptide 25-35
AD	Alzheimer's disease
ADA	Americans with Disabilities Act
ADHD	attention deficit hyperactivity disorder
AIC	Akaike Information Criterion
ANOVA	analysis of variance
ATBC	Alpha-Tocopherol, Beta-Carotene (Cancer Prevention Study)
ATR	Australian Twin Registry
AUD	alcohol-use disorder
BDNF	brain-derived neurotrophic factor
BIC	Bayesian Information Criterion
CB1	cannabinoid
CHRNA7	$\alpha 7$ nicotinic receptor
CIDI	Composite International Diagnostic Interview
cM	centimorgan
CNS	central nervous system
CO	carbon monoxide
COGA	Collaborative Studies on Genetics of Alcoholism
COMT	catechol- <i>O</i> -methyl-transferase (gene)
COT	children of twins
CPD	cigarettes per day/cigarettes smoked per day
CPP	conditioned place preference
CPS	Current Population Survey
CPT	continuous performance task
CPT-IP	continuous performance task identical pair
CS	conditioned stimulus
CYP	cytochrome P-450
CYP2A6	cytochrome P-450 2A6 (gene)
CREB	cyclic AMP-response element binding
dB	decibel
DH β E	dihydro-beta-erythroidine
DHEA	dehydroepiandrosterone
DIS	Diagnostic Interview Schedule (NIMH)
DRD2	dopamine receptor D2 (gene)
DSM	<i>Diagnostic and Statistical Manual of Mental Disorders</i>
DSM-III-R	<i>DSM (third edition, revised)</i>
DSM-IV	<i>DSM (fourth edition)</i>
EEA	equal environments assumption
EEG	electroencephalogram

EM	Expectation maximization
EMA	ecological momentary assessment
ERP	event-related potential
FF	female-female twin pairs
FHS	Framingham Heart Study
fMRI	functional magnetic resonance imaging
FMM	factor fixture model
FTND	Fagerström Test for Nicotine Dependence
FTQ	Fagerström Tolerance Questionnaire
GABA	γ -aminobutyric acid
GAW	Genetic Analysis Workshops
GIS	geographic information system
GGMM	general growth mixture modeling/models
GMM	growth mixture modeling/models
HSI	Heaviness of Smoking Index
HPA	hypothalamic-pituitary-adrenocortical
Hz	hertz
IBD	identical by descent
ICC	item characteristic curve
ICD	<i>International Statistical Classification of Diseases and Related Health Problems</i>
ICD-10	<i>ICD, tenth revision</i>
ICR mice	<i>(some kind of outbred mice)</i>
ICSS	intracranial self-stimulation
IP	intraperitoneal
IRT	item response theory
IV	intravenous
kg	kilogram
L	liter
LCGA	latent class growth analysis
LGC	latent growth curve
LOD	log (or logarithm) of odds
LRT	likelihood ratio test
MAO	monoamine oxidase
MAOA	monoamine oxidase A
mg	milligram
mL	milliliter
MLA	methyllycaconitine citrate
MMMF	male-male and male-female twin pairs
MSTF	Mid-South Tobacco Family
MTFS	Minnesota Twin Family Study
μg	microgram
nAChR	nicotinic acetylcholine receptor
NETSAD	Netherlands Twin Study of Anxious Depression
NDSS	Nicotine Dependence Syndrome Scale

NEAD	Nonshared Environment in Adolescent Development (Project)
ng	nanogram
NHANES-III	Third National Health and Nutrition Examination Survey
NMDA	<i>N</i> -methyl- <i>D</i> -aspartic acid
NRT	nicotine replacement therapy
PDA	personal digital assistant
PET	positron emission tomography
PNS	peripheral nervous system
PPI	prepulse inhibition
PR	progressive ratio
PTC	phenylthiocarbamide
QSU	Questionnaire on Smoking Urges
RNA	ribonucleic acid
RSA	respiratory sinus arrhythmia
RTU	regular tobacco use
RVIP	Rapid Visual Information Processing
S allele	short allele
SAS	Statistical Analysis Software
SC	subcutaneous
SEM	structural equation model
SES	socioeconomic status
SNP	single nucleotide polymorphism
<i>TH</i>	tyrosine hydroxylase (gene)
TI	tobacco initiation
TTFC	time to first cigarette
TTURC	Transdisciplinary Tobacco Use Research Center
TUS-CPS	Tobacco Use Special Cessation Supplement to the Current Population Survey (U.S. Census Bureau)
VLMR	Vuong-Lo-Mendell-Rubin (test)
VNTR	variable number tandem repeat
VTA	ventral tegmental area
WCST	Wisconsin Card Sorting Test
WISDM	Wisconsin Inventory of Smoking Dependence Motives

Part

1

Overview

Tobacco use is the world's leading cause of preventable death. This major public health threat exists within the context of a complex interplay between genetic and environmental causes of nicotine dependence, and understanding this balance may hold the key to further reductions in the disease burden and mortality due to chronic tobacco use. This monograph explores the role of genetics in the etiology of nicotine dependence. It provides a conceptual framework for understanding nicotine dependence and for examining the usefulness of a range of potential phenotypes and endophenotypes for linking genes to behavior.

This introductory part starts by summarizing the epidemiology of tobacco use, the history of genetic studies in tobacco, and the measurement of nicotine dependence. It then provides a literature review of selected biometric and genetic studies of nicotine dependence and ends with a discussion of some of the most important issues in the communication of genetic findings.

1

Overview and Conclusions

This chapter introduces a monograph that examines the relationship between genetics and nicotine dependence. It summarizes evidence and research accumulated since the 1950s on the effect of both unmeasured and measured genetic factors, as well as that of behavioral and environmental phenotypes on nicotine dependence.

This chapter frames issues addressed in the monograph, and describes its organization around topic areas including relating genetic and gene-environment factors to tobacco use, linking genetic traits with measures of nicotine dependence, examining the progression of tobacco use from adolescence to adulthood and its potential relationship to other substance abuse, identifying genetic liability markers for nicotine dependence in chronic smokers, and exploring the future of genetic studies for nicotine dependence. In addition to noting several “firsts” accomplished with the completion of this monograph, the closing sections of this chapter present volume and chapter conclusions generated by the work presented here.

Experts in psychology, psychiatry, behavioral pharmacology, neurobiology, epidemiology, child development, statistical genetics, and bioinformatics were assembled to provide data analyses within these pages. It is hoped that this monograph will help define various groups of smokers to advance the field of behavioral genetics of nicotine dependence.

Introduction

Substantial evidence, accumulated since the 1950s, from the study of twins, siblings, and nuclear families shows that *unmeasured* genetic factors (influences estimated from analyses of correlations among family members for specific phenotypes) influence the likelihood of both initiating and maintaining nicotine dependence. Beginning with research published in 1994, studies show that *measured* genetic factors (influences estimated from analyses of associations between genomic regions or specific gene variants and specific phenotypes) and nicotine dependence are also related. More than 100 published papers have reported associations between tobacco use behaviors and variants of candidate genes or genomic regions in relevant neurobiological and metabolic pathways. The combined evidence reveals that genetic involvement in nicotine dependence is present in adolescents and adults, both males and females, and in several cultures.

Concurrent with the work started in the early 1990s, new genomic technologies were introduced that make previous research quickly obsolete. With the rapid decrease in costs to genotype individuals for very large numbers of variants across the whole genome, the whole-genome association study has now become possible. Similarly, it is now possible to genotype candidate genes for many variants (known as single nucleotide polymorphisms [SNPs]). SNPs account for a large number of functional variants in humans, which has made them particularly useful in whole-genome research. Along with genomic technology, advanced methods from the experimental, bioinformatic, statistical, and epidemiological fronts now make it possible to envision the next generation of studies. These advances will support the further integration of neurobiological mechanisms into public health efforts.

The marked decline in cigarette consumption in the United States since the 1960s corresponds to increased public awareness of the dangers of tobacco use, changing social norms about tobacco, and increasing governmental actions to regulate the use, sale, and advertising of tobacco products. The most comprehensive environmental changes have been in attitudes and rules about smoking in enclosed public places. As late as the 1980s, smoking was present in most public places, with smoking allowed virtually everywhere (except in areas of increased probability of fires or damage to equipment). Over time, the environment that had supported smoking indoors has transformed. Limiting where people can smoke has contributed to the social marginalization of smoking as an accepted behavior. In addition, tobacco use screening and brief intervention by clinicians has become a top-ranked clinical preventive service on the basis of health impact, effectiveness, and cost-efficiency, further reducing cigarette consumption.

Despite enormous progress in the public health arena, 45 million individuals remain regular users of tobacco, with an estimated annual cost to the U.S. economy of \$167 billion due to premature death and disability.¹ Worldwide, approximately 1 billion people are regular users of tobacco, and 3–6 million people die every year from illnesses caused by tobacco.² One reason for this is that broad public health and community efforts, though found to be effective by such groups as the U.S. Task Force on Community Preventive Services, are not widely implemented and have varied substantially across the United States. Also, tobacco settlement dollars are spent by many states on non-health-related and non-tobacco-related activities instead of tobacco control and prevention.³

Another reason for continued smoking is that the potential of powerful genomic

tools to answer important questions about nicotine dependence has yet to be maximized, and increased attention should be paid to the nature of the behavioral and/or environmental phenotypes included in future genomic studies. The majority of the published work has relied upon relatively broad, nonspecific measures of nicotine dependence that may, in fact, represent the end result of a series of initiating, promoting, and maintaining factors, many of which interact along the developmental pathway to result in full-blown adolescent and adult nicotine dependence. The preparation of this volume was undertaken to provide future genomic investigations of nicotine dependence with a review of more refined phenotypes that derive from theory-driven and/or experimental work. To accomplish this, a team of experts in the areas of psychology, psychiatry, behavioral pharmacology, neurobiology, epidemiology, child development, statistical genetics, epidemiology, and bioinformatics was assembled to review the available evidence for novel phenotypes that could, in turn, meet the requirements of an “endophenotype.”

Endophenotypes are presumed to be more directly related to the underlying characteristics of nicotine dependence than are broad inclusive measures. To be viewed as an endophenotype, a candidate phenotype may be neuropsychological, neurophysiological, neurobehavioral, biochemical, endocrinological, or neuroanatomical in nature and must be heritable, state-independent, cosegregate with nicotine dependence in families, and present at a higher rate among unaffected relatives of those with nicotine dependence than in the general population.^{4,5} One of the assumptions of the endophenotype concept is that these constituents will have simpler genetic underpinnings than does nicotine dependence itself. The use of endophenotypes in genetic research of

nicotine dependence has been underutilized. Another underutilized approach to the study of nicotine dependence involves the study of gene-environment interactions in which it is assumed that “environmental pathogens” cause the expression of a disorder such as nicotine dependence only in the presence of certain gene variants.⁶

One of the objectives of the present volume is to more fully explore the existing approaches and supporting evidence (at both the phenotypic and environmental levels) available to the next generation of genetic studies. These approaches include factors and processes that are tobacco specific, as well as those that are related to broader correlated conditions, including other forms of substance dependence.

About the Monograph

The overarching goal for the volume was for each of the contributing editors and authors to review the existing literature, and to go beyond it, by identifying new concepts, measurements, and strategies to more fully enrich the universe of discourse and investigation in the area of genetics and nicotine dependence. The authors were asked to summarize the best available evidence and make recommendations accordingly. In some cases, when the available evidence is thin or nonexistent, the authors were asked to conduct original analyses or apply innovative methods to existing data to move the field forward. In addition, the authors were asked to provide informed opinions as to where the next generation of research should head.

The monograph will be most useful to individuals who are or will be designing next-generation studies to determine causal relationships between genes and nicotine dependence. To limit the scope of the volume, the emerging literature on the relationship between genetic variation

and response to pharmacotherapy for smoking cessation is not included. While the volume will identify many important issues and questions concerning nicotine dependence and its measurement, it does not seek to resolve the issue of what nicotine dependence is nor does it seek to identify the “best” measures of nicotine dependence. Throughout the volume, the reader will clearly see where the evidence is solid in support of a phenotype’s potential role as an endophenotype and where the evidence is weak or simply not yet available.

The chapters of the monograph are organized into six parts.

Part 1—Overview, provides background context for research in genetic and gene-environment factors in tobacco use. It focuses on phenotypes and endophenotypes that may link genes and behavior and be a basis for future genetic studies. In addition, conceptual, theoretical, and methodological considerations in the further study of nicotine dependence are examined.

Part 2—Theoretical Considerations, examines the theoretical basis for constructs that may link heritable genetic traits with observable measures of nicotine dependence. These include phenotypes representing a causal path between specific genetic actions and measures of nicotine dependence, as well as endophenotypes measuring indirect influences, such as those found before nicotine exposure. This part examines theoretical issues in establishing nicotine-dependence phenotypes as well as studies of human and animal behavior.

Part 3—Developmental Trajectories of Tobacco Use and Their Relation to Tobacco Dependence, examines issues in the study of trajectories of tobacco use and their future potential as a basis for genetic studies of nicotine dependence. Chapters include a literature review of developmental trajectories of cigarette smoking between

adolescence and adulthood, genetic modeling issues in the study of smoking trajectories and behavior, and the relationship of these with other trajectories such as alcohol use or substance abuse.

Part 4—Endophenotypes. Endophenotypes serve as intermediary measures that have the potential to provide a link between genes, smoking behaviors, and nicotine dependence. Endophenotypes may help serve as a basis for future studies to identify genetic liability markers for nicotine dependence. This part discusses the evidence base for several candidate endophenotypes for nicotine dependence at or before initial exposure to nicotine as well as for endophenotypes for nicotine dependence in chronic smokers.

Part 5—Epidemiological and Methodological Considerations, examines epidemiological and methodological issues related to the future of genetic studies of nicotine dependence. These issues include the use of epidemiologically-based phenotypes for tobacco use; a potential etiological architecture for genetic and environmental influences on smoking phenotypes; and the hierarchical modeling of gene-gene joint action.

Part 6—Future Directions, comments on how continued research in the area of genetics may influence future understanding of the pathways responsible for nicotine dependence, the role genetic variation plays in its initial acquisition and maintenance. It also provides summaries and recommendations from each of the parts of the monograph and concludes with several cross-cutting suggestions for future work in this area.

A Note to the Reader

It is not the intention of the authors of the volume to suggest that the continued substantial prevalence of nicotine dependence in the population is solely

determined by genetic factors. Much of the early work in twins indicates that environmental influences are equally important (and may be more so at different phases of the development of nicotine dependence). An enormous literature, evolving separately from that on genetics and nicotine dependence, clearly documents the effect of specific environmental influences on the likelihood of exposure to tobacco, its regular use, its chronic use, and the difficulty some people have in stopping its use. Protobacco stimuli are ubiquitous in the environment and include advertising by the tobacco industry and the portrayal of smoking in the movies. Equally important, the tobacco industry controls the design of cigarettes and, so, the bioavailability of nicotine. The form in which the nicotine is delivered is an important variable that almost certainly interacts with the biological factors discussed in the report.

No published study has adequately addressed simultaneously genetic variation, quantitative measures of social and cultural variation, and the interaction between the two sources of variation. This gap reflects the fact that scientists from the two traditions have not typically worked with each other rather than a dismissal of each other's work. Tobacco use as reflected in population trends is the product of the interaction of agent, host, and environmental factors. Government policies are important modifiable environmental influences that can alter how tobacco products are designed and marketed (agent factors) and how consumers respond. Individual variation in host responses to tobacco is important to understand, since this has implications for understanding how different people will respond to different programs and policies (i.e., treatments for nicotine dependence, tax increases, mass media campaigns, etc.). Synergy occurs when tobacco control and prevention interventions directed at agent, host, and environmental factors are implemented together.

Major Accomplishments

In completing the volume, several “firsts” were accomplished:

- The first comprehensive review of the state-of-the-art in the measurement of nicotine dependence and related phenotypes within the context of genetic studies
- The first demonstration that heterogeneity in tobacco use trajectory from early adolescence to early midlife is related to both family history of smoking and to nicotine dependence in adulthood
- The first demonstration that conjoint trajectories of tobacco and alcohol use in adolescents are heritable
- The first review of biobehavioral phenotypes that could be utilized by future genomic studies of pre- and postnicotine exposure
- The first demonstration that microcontextual effects on nicotine dependence can be assessed and are informative within the context of a genetically informed study
- The first use of Bayesian analysis as informed by a nicotine metabolic ontology to determine the relative importance of several genes to variation in nicotine metabolism

Major Conclusions

Several broad conclusions emerge from the volume. These include

1. At every level of analysis (theoretical, animal, child, and adult), good candidate endophenotypes are available for inclusion in future genomic studies of nicotine dependence.

2. Results from the animal and human domains implicate the importance of nicotinic acetylcholine receptors in nicotine self-administration, reward, and dependence.
3. Developmentally, there is evidence from latent class growth analysis and growth mixture modeling in unrelated and related adolescents that familial and/or genetic factors play a role in trajectories of tobacco use that vary in age of onset, level, and chronicity of use, as well as in the extent to which tobacco and alcohol use co-occur.
4. In children and adults, there are neuropsychological, electrophysiological, and behavioral laboratory measures characterized in other research contexts that may shed light on mechanisms that promote risk for initiation and maintenance of nicotine dependence.
5. Along with more refined definitions of nicotine dependence at the epidemiological level and an increased number of options at the phenotypic level, several technological developments will be important to the next generation of studies of nicotine dependence, such as whole-genome genotyping, epigenetics, proteomics, and metabolomics. Complementing these technologies are methodological advances including Bayesian statistics, behavioral ontologies, identification of developmental trajectories, and real-time measurement of environmental antecedents to nicotine dependence.

Chapter Summaries and Conclusions

Part 1—Overview

Chapter 1. Overview and Conclusions

Chapter 1 provides an introduction and framework for the monograph, describes

how it is organized, and includes major volume conclusions, chapter summaries and conclusions, and a look to the future.

Chapter 2. Genetic Studies of Nicotine Dependence: Current Status

Chapter 2 begins with a brief summary of the epidemiology of tobacco use, focusing on environmental factors that have been shown to promote and reduce smoking behavior. Also presented is an integrative model of tobacco use and nicotine dependence, illustrating the concept of trajectories of phenotypic pathways. The chapter then provides a history of research in the genetic basis of nicotine dependence. A full discussion of the limitations in the conceptual understanding of the construct of nicotine dependence along with a detailed framework for moving the field forward is then presented. Next follows a summary of findings from selected (biometric and measured) genetic studies of nicotine dependence. The chapter ends with a brief discussion of some of the major issues in communicating genetic findings.

Part 2—Theoretical Considerations

Chapter 3. The Nicotine-Dependence Phenotype: Translating Theoretical Perspectives and Extant Data into Recommendations for Genetic Mapping

Chapter 3 examines theoretical issues in establishing nicotine-dependence phenotypes, including distal measures of nicotine dependence focusing on mature nicotine dependence, newer multidimensional measures of nicotine dependence that examine motivational factors leading to dependence, and endophenotypes and transitional phenotypes that may form a causal path

between specific genetic actions and measures of nicotine dependence.

Conclusions

1. Most widely used tests of nicotine dependence, such as the Fagerström Test for Nicotine Dependence and the *Diagnostic and Statistical Manual of Mental Disorders*, aggregate data across different dimensions of dependence, thereby compromising the reliability and validity of these measures. Evidence suggests, however, that selected items from these measures and from newly developed dependence scales can be relatively coherent, show fairly high heritability, and be consistently related to core dependence features such as relapse likelihood.
2. Although key variance associated with the dependence construct will be captured by measures of smoking rate, latency to smoke in the morning, and the likelihood or latency of relapse, other complementary measures should also be considered such as strength of withdrawal symptoms and perceived control over smoking. Analytic strategies should adjust for environmental factors such as home or work smoking restrictions, which, in theory, may reciprocally affect dependence itself.
3. Nicotine dependence involves both environmental and constitutional influences, and the effects of genetic variants associated with nicotine dependence require certain environmental conditions to influence the phenotype (at minimum, drug access and use). Determining which environmental features moderate genetic expression and how to incorporate such gene-environment interactions into genetic mapping remains an area for further study.
4. New developments in the assessment of the nicotine-dependence phenotype include the development of new multidimensional measures of nicotine dependence, including the Nicotine Dependence Syndrome Scale and the Wisconsin Inventory of Smoking Dependence Motives. These measures of mature dependence phenotypes provide the opportunity to measure relatively discrete dimensions of dependence and may permit more specific gene mapping.
5. In addition to greater specificity, it is vital to capture important developmental processes that may be masked by the mature nicotine-dependence phenotype. To obtain measures sensitive to particular biological mechanisms that may have close links to genetic variants, researchers may need to develop biological, behavioral, and cognitive neuroscience assays that complement self-report measures. These may include measures of endophenotypes, or intermediate phenotypes, that assess vulnerabilities to dependence that preexist nicotine use as well as transitional phenotypic measures that assess processes that change in response to drug exposure and that lead to mature dependence.
6. All stages of the genetic mapping of nicotine dependence should be guided by specific theory linking candidate genetic variants sequentially with critical biological and behavioral processes and, ultimately, with phenotypes of clinical significance.

Chapter 4. Mouse Models and the Genetics of Nicotine Dependence

Chapter 4 examines key issues in using mouse models for nicotine dependence, including how nicotinic acetylcholine receptors contribute to tissue-specific response within the context of strain-specific genetic background, the interaction of nicotine with physiological systems and

how experimental results with mice may relate to the physiology of human smoking, and the way mouse models recapitulate many basic features of nicotine dependence in humans.

Conclusions

1. Substantial differences exist between mouse strains in their response to the acute or chronic administration of nicotine. These differences implicate specific neuronal nicotinic acetylcholine receptors within a broader genetic context, which suggests a central role for these genetic variants in nicotine dependence in humans.
2. The three most common routes of administration (intravenous, subcutaneous, and oral) for nicotine in rodents vary in the degree to which they model key features of human nicotine dependence, such as the behavioral features of self-administration and the acute and chronic physiological effects of nicotine. Each administration route offers advantages and disadvantages. Intravenous self-administration permits self-administration but may entail receptor-level response artifacts due to high dosages. Subcutaneous administration allows experimenter control of dosage and withdrawal over long time periods at a cost of precluding self-administration. Oral administration via drinking water permits chronic nicotine exposure and produces evidence of dependence, but is subject to specific possible side effects, making this issue an important variable in research design.
3. While mice generally are less sensitive to nicotine than are rats, mouse models now have a strong research base for nicotine effects. Mice are amenable to genetic and pharmacological experimental manipulation. They exhibit heterogeneity in strain-specific responses to nicotine, and methods of homologous recombination permit

manipulation of specific genes. Data now link specific mouse strains to genetically influenced differences in the effects of nicotine exposure that can facilitate further study of nicotinic acetylcholine receptor biology in mice.

4. Mouse models link nicotine self-administration to high-affinity nicotinic acetylcholine receptors, genetic differences, developmental factors, and other potential mechanisms of dependence. These models have, in addition, linked nicotine reward in the form of conditioned place preference with genetic strain differences and specific receptor subtypes and have linked acute and chronic nicotine tolerance with other genetic and receptor differences. The models have also linked the $\alpha 7$ and $\alpha 4\beta 2$ receptors with nicotine enhancement of working memory, learning, and attention and have shown strain-specific aging effects on nicotinic acetylcholine receptor expression.
5. Although substantial differences exist in the biology of nicotinic acetylcholine receptor expression and function between mice, other rodents, and humans, nascent research in mouse models for nicotine dependence shows considerable promise in furthering understanding of the biology and genetics of nicotine dependence.

Part 3—Developmental Trajectories of Tobacco Use and Their Relation to Tobacco Dependence

Chapter 5. Developmental Trajectories of Cigarette Smoking from Adolescence to Adulthood

Chapter 5 examines literature concerning developmental trajectories of cigarette smoking between adolescence and

adulthood and presents an empirical example of these trajectories. This chapter also provides a framework for part 3 that explores aspects of cigarette smoking trajectories and their potential to inform further genetic research.

Conclusions

1. Previous studies (and the empirical example presented in the chapter) have identified multiple developmental trajectories of tobacco use from adolescence to adulthood. These trajectory groups, which vary in age of onset, rate of acceleration, and persistence of smoking over time also vary in their antecedents and correlated risk factors. These trajectories may be informative as developmental phenotypes for genetic studies of tobacco use.
2. Statistical approaches such as latent class growth analysis and growth mixture modeling can be useful in evaluating developmental trajectories of smoking behavior. However, challenges in using these approaches include the handling of within-class random effects, the impact of a nonnormal aggregate distribution on the classes extracted, the need for proper model specification and parameterization, the span of evaluated data, and the impact of abstainers on the model.
3. Analysis of a 25-year cohort-sequential study of smoking behavior identified six distinct trajectories of smokers across eight waves of data collection. These trajectory groups were experimenters; developmentally limited smokers; early-onset, persistent smokers; high-school-onset, persistent smokers; late-onset, persistent smokers; and successful quitters, with a priori groups of stable abstainers, stable quitters, and relapsing/remitters. Trajectory group membership was related to educational attainment, family history of smoking, and indicators of nicotine dependence.

Chapter 6. Genetic Modeling of Tobacco Use Behavior and Trajectories

Chapter 6 examines genetic modeling issues in the study of smoking trajectories and behavior, including methodological and conceptual issues, statistical modeling considerations, a review of prior genetic studies of smoking behavior, and a study applying an item response theory approach to an analysis of smoking trajectories.

Conclusions

1. Data from twin studies suggest that shared environmental factors are the predominant source of familial resemblance in liability to smoking initiation in young adolescents, while additive genetic factors appear more important in older adolescents.
2. Results from extended twin designs show that significant assortative mating exists for smoking initiation and that the parent-child correlations can be almost entirely accounted for by genetic factors. This implies a limited environmental influence of parental smoking initiation on smoking initiation in their children.
3. In contrast to the significant role of shared environmental factors in smoking initiation, the liability to smoking persistence and nicotine dependence appears to be primarily accounted for by additive genetic factors. Furthermore, the liabilities to initiation and progression appear to be substantially correlated. Molecular genetic studies may be expected to find some genetic variants that contribute specifically to initiation—some that are specific to dependence and some that contribute to both.
4. Future development and applications of genetic latent growth curve models and genetic latent class models promise to improve the understanding of the role

of genes and environment in smoking trajectories and transitions from nonsmoker to smoking dependence.

5. The search for susceptibility loci for smoking-related traits, either through linkage or association studies, has not identified any convincing replicated findings. However, several genomic regions and several candidate genes have been found to be associated with smoking behavior in more than one study.
6. Improving the assessment of nicotine initiation and dependence by allowing for differences in measurement by age and gender and taking conditionality into account might provide more accurate estimates of the contributions of genes and environment to different stages of smoking.
7. Meta-analyses or mega-analyses of studies of smoking phenotypes—both genetic epidemiological and molecular genetic—should prove useful in summarizing the available data and results. Possibly, certain data sets may produce results that are outliers, and controlling for their effects would permit finer resolution between hypotheses and more accurate parameter estimates.

Chapter 7. Trajectories of Tobacco Use from Adolescence to Adulthood: Are the Most Informative Phenotypes Tobacco Specific?

Chapter 7 examines the evidence base for linkages between substance-use trajectories, as well as the results of an original empirical study examining smoking and alcohol use over time across a cohort group of male twins. The areas discussed include common versus specific liability to substance-use disorders, covariate relationships between smoking and other substance-abuse trajectories, and conjoint trajectories of smoking and other substances.

Conclusions

1. Studies examining the developmental course of multiple substances have shown relatively high concordance between identified trajectories despite diverse course shapes and different course prevalences.
2. Membership in a given developmental trajectory, which can be captured by a single categorical latent variable, represents age of onset and severity as well as change (slope) in use of a substance; moreover, membership in a trajectory characterized by concurrent use of two (or more) substances simultaneously provides information for multiple substances.
3. Developmental course might serve as a valuable phenotype for biometric models, and determining the degree to which a phenotype of developmental course is substance specific is valuable for the genetic study of addictive behavior.
4. Evidence using twin data indicates that courses of substance use are genetically influenced, with monozygotic twins showing greater concordance for smoking and for drinking than do dizygotic twins. The genetic contribution to the risk of taking different pathways in development represents an area for further study.
5. Conjoint trajectories of drinking and smoking reveal even greater concordance than do single-substance trajectories, suggesting greater heritability for courses extracted from several substances. This underscores the value of considering substance use across multiple domains when constructing phenotypes for research and perhaps even for clinical use. However, extending the concept of the components of developmental substance-use phenotypes raises new questions such as, Which substances? What aspects of substance use or its consequences? Which periods

of development? Thus, the findings show the value of extending the concept of substance-use phenotypes but not necessarily optimal phenotypes that “carve nature at its joints.”

6. If resources are limited for genetic analyses, focusing on those with the most “extreme” phenotypes marked by both high initial level and chronic continued use may represent an efficient strategy for identifying genes associated with more problematic forms of substance use.

Part 4—Endophenotypes

Chapter 8. Endophenotypes for Nicotine-Dependence Risk at or before Initial Nicotine Exposure

Chapter 8 examines the evidence base for several candidate endophenotypes for nicotine-dependence risk at or before smoking and nicotine exposure. Issues covered include approach-related smoking risk variables, avoidance-related smoking risk variables, control-related smoking risk based on psychological variables, and measures of initial response to nicotine exposure.

Conclusions

1. Several higher-order psychological constructs can consolidate many smoking initiation and progression risk variables. These constructs, as well as sensitivity to initial nicotine exposure, can be related to observable neural, physiological, and behavioral measures that may, in turn, serve as potential candidate endophenotypes for genetic research on nicotine dependence.
2. Several laboratory measures exist that could be associated with the risk for smoking initiation and progression and subsequent nicotine dependence, but these associations have yet to be

investigated. Findings are mixed for the reliability and heritability of these measures, and minimal evidence exists for their validity, representing an area for further study.

3. Measurement of sensitivity to initial nicotine exposure is subject to numerous methodological limitations, including ethical difficulties with empirical measurement in naive (e.g., previously unexposed to nicotine) subjects, a lack of consideration of smoking dose and context from retrospective self-reports, recall bias, and self-selection to early smoking experience. At the same time, preliminary findings indicate that measures of reward and mood effects surrounding initial exposure to smoking show promise as a potential basis for endophenotypes of a genetic predisposition to nicotine dependence.
4. The available evidence points to the plausibility of endophenotypes that link factors at or before initial nicotine exposure with the potential for nicotine dependence. These endophenotypes reflect approach, avoidance, and control-related traits as well as initial sensitivity and exposure measures in response to nicotine intake. Further research is needed to help identify endophenotypes that connect risk variables for nicotine dependence to genetic influences.

Chapter 9. Nicotine-Dependence Endophenotypes in Chronic Smokers

Chapter 9 explores the evidence base for purported endophenotypes for nicotine dependence in chronic smokers. Motivational measures, sensory measures, measures of cognitive function, measures of abstinence-induced and cue-induced craving, and affective regulation and impulse control are discussed from a standpoint of biological plausibility, objective measurement criteria and

reliability, genetic influences, and association with nicotine dependence.

Conclusions

1. Nicotine dependence in chronic smokers is characterized by persistent smoking behavior despite knowledge of its harm (e.g., an inability to sustain a quit attempt). Reinforcement measures such as nicotine choice have been related to nicotine dependence, although further research is needed on the relationship between dependence and ad libitum drug self-administration, behavioral economics, and progressive ratio measures. Genetic studies in reinforcement measures in mice indicate a potential for studying the heritability and genetic influence for these behaviors in humans.
2. Limited evidence exists regarding the relation between self-reported measures of reward and nicotine dependence in humans, while animal studies show a potential link between the reward-related measure of conditioned place preference and nicotine dependence.
3. Evidence of heritability and genetic influence has been established for measures of sensory processing, such as resting electroencephalogram activity, event-related potentials, and the prepulse inhibition of startle response, as well as cognitive measures such as attention and working memory. Further research is indicated to investigate the relationship of such measures to nicotine dependence in humans.
4. Self-report measures of abstinence-induced craving have been related to the success of cessation efforts (i.e., dependence), while neither self-report nor psychophysiological measures of cue-induced craving have been reliably shown to relate to nicotine dependence. The relationship of these measures with genetic factors remains an area for further investigation.
5. Self-reported levels of negative affect following smoking cessation have been strongly related to smoking persistence. Persistence has also been associated with abstinence-induced changes in physiological measures such as cortisol and the dehydroepiandrosterone to cortisol ratio. Other measures of affect have not been shown conclusively to relate to measures of nicotine dependence.
6. Impulsivity and cognitive control measures such as delay discounting, the go/no-go task, and the Stroop interference task have not been shown conclusively to relate to nicotine dependence, while the go/no-go task has shown some evidence of heritability and relation to genetic factors.
7. Overall, the available evidence supports the possibility of endophenotypes for nicotine dependence in chronic smokers on the basis of motivational factors and, to a lesser extent, sensory, cognitive, affective, and behavioral measures. Further research is indicated to help establish a consistent pattern of heritability, genetic influence, and association with nicotine dependence for measures in each of these areas.

Part 5—Epidemiological and Methodological Considerations

Chapter 10. Epidemiological Analysis of Variation in Phenotypic Definitions: A Proof of Concept Using an Example of a Cessation Phenotype

Chapter 10 explores the use of an epidemiological approach for modeling smoking phenotypes that are based on transitions along the smoking trajectory and prior exposure. It presents three studies that examine improved phenotypes based

on observable transition points in smoking cessation with appropriate prior exposure in relation to numerous variables for smoking behavior and comorbid conditions.

Conclusions

1. More tightly defined phenotypes of smoking behavior that are based on transitions along the smoking trajectory and adequate prior exposure have the potential to reduce the classification bias and lack of specificity inherent in broader existing phenotypes such as current smoking status. These improved phenotypes, in turn, may lead to closer correlations between smoking behavior and genetic variables in future studies.
2. Studies involving both longitudinal and cross-sectional population data show measurable differences among improved phenotypes, including sustained quitters, relapsers, and never quitters, in key markers such as smoking history, other indices of nicotine dependence, and comorbid conditions such as psychological symptoms and alcohol use.
3. Refined nicotine-dependence phenotypes based on longitudinal characterizations of smoking patterns show promise for further testing in genetic studies in support of potential phenotype-gene causal associations for nicotine dependence. Research indicates the potential need for further refinement of such phenotypes.

Chapter 11. Incorporating Social Context into Genetic Studies of Nicotine Dependence

Chapter 11 examines the available research and future trends related to social context factors that could inform subsequent genetic studies of smoking. The chapter considers macrocontextual factors such as culture and socioregional factors, microcontextual factors such as smoking

in specific interpersonal relationships, and integrated proximal indicators of both macro- and microcontext such as ecological momentary assessment.

Conclusions

1. Social context influences on developmental pathways to nicotine dependence reflect gene-environment interplay that comprises the elements of a traditional epidemiological framework including a host (e.g., smokers and genetic endowment), environmental factors (social network), and an agent (e.g., tobacco).
2. Macrocontextual factors such as culture, socioregional variables, and socioeconomic status can modify or even nullify genetic influences on nicotine dependence. For example, a twin study revealed a prevalence rate for smoking of less than 1% in Chinese women, reflecting an inhibitory cultural influence. Family or neighborhood socioeconomic status and density of tobacco sales outlets are examples of specific contextual factors that appear to influence smoking risk among adolescents.
3. Microcontextual approaches have revealed factors such as exposure to parental, sibling, and peer smoking that may moderate genetic influence on behavioral smoking measures. The genetically informative Nonshared Environment in Adolescent Development Project, which comprised twins as well as other siblings, indicated that sibling interaction patterns may moderate the shared environmental effects that influence adolescent smoking.
4. Studies of smoking behavior using ecological momentary assessment, designed to measure both macro- and microcontextual factors, show that smoking behavior varies with both location and companions. Such

assessments serve as a possible future model for incorporating integrated social context issues such as actual clinical and public health efforts to reduce tobacco use within etiological architectures.

5. Future work incorporating social context within gene-environment studies of smoking behavior and nicotine dependence will benefit from a greater focus on environmental factors, including more-fine-grained and comprehensive assessments of potential environmental influences.

Chapter 12. Using Ontologies in Hierarchical Modeling of Genes and Exposure in Biological Pathways

Chapter 12 examines the potential for the use of hierarchical modeling techniques within the framework of an ontology that quantifies relationships across genotypes and phenotypes for nicotine dependence. The chapter provides an overview of statistical approaches for genetic association studies in tobacco use, presents the results of a study of nicotine metabolism that shows significant genetic associations with nicotine clearance levels, discusses design and analysis considerations in the use of hierarchical modeling in conjunction with stochastic variable selection, and explores the use of ontologies for codifying prior knowledge to support efficient computational analysis of hierarchical models.

Conclusions

1. The available knowledge of nicotine dependence arises largely from studies that model the independent association of candidate genes with outcome measures. Such studies often fail to reflect the complexity of interacting factors and discrete events that can influence smoking behavior and, therefore, may not provide a clear picture of biological mechanisms affecting nicotine dependence.
2. A promising approach to the study of nicotine dependence involves the use of prior biological knowledge about the relations between genotypic and phenotypic variables in a hierarchical modeling framework. This allows prior knowledge to aid in estimating specific genotypic effects and to guide a stochastic search over all possible statistical models.
3. The use of ontologies is a promising new direction for the elucidation of the genetic basis of nicotine dependence. An ontology is a construct or model that represents entities in both genotypic and phenotypic domains as well as their interrelations. The use of an ontology permits the modeling of hierarchical relationships by using directed acyclic graphs spanning genotypes and endophenotypes and phenotypes, while taking advantage of prior knowledge to quantify these relationships, making them amenable to computational analysis.
4. A study of nicotine metabolism that used data from the Northern California Twin Registry to examine the total clearance of nicotine and the *trans* 3'-hydroxycotinine to cotinine ratio, with the Nicotine Pharmacokinetics Ontology as a framework, showed a significant association between specific polymorphisms for *CYP2A6* and measured nicotine clearance levels as well as statistically significant results for single nucleotide polymorphism 4 within *UGT1A4*.
5. Hierarchical modeling combined with the use of an ontology defining relationships between constructs of interest represents a promising area for further research in studying a possible genetic basis for nicotine dependence as well as for understanding

the interaction between genetics and social and environmental influences on tobacco use and dependence.

Part 6—Future Directions

Chapter 13. Future Directions

Chapter 13 starts with a discussion of how examining the genetics of tobacco dependence may affect basic and clinical research. It then outlines future research needs for topics covered in parts 2–5. The chapter ends by presenting higher level recommendations for future research in nicotine dependence that cut across the content of this volume. These volume level future directions were identified by the editors while preparing this monograph and after taking into account continuing developments in the field.

Crosscutting Issues

- A comprehensive approach to examining and reporting genotype-phenotype associations should be adopted; single-gene, single-variant association studies should be discouraged unless accompanied by reports of replication and validation.
- Researchers working in the field of genetics and nicotine dependence should be mindful of the potential for misinterpretation of results by lay audiences. Efforts to communicate results to the media should include the limitations of the work along with the extent to which the results are reliable and generalizable. Doing so will minimize the chances of stigmatizing subgroups in the population.
- An ontology-based approach to nicotine dependence, with specification of expected relations within and between phenotypic domains, will provide an interpretive context and more focused hypotheses for future research; this will lead to an ongoing refinement of the ontology as new information becomes available.
- A greater use of strategies that combine differing levels of analysis is needed. The incorporation of measured genetics into genetic latent growth curve and/or latent class models in extended twin designs, for example, will provide information on the extent to which variation in one or more genes plays a role in the overall estimate of genetic variation in any particular phenotype. In addition, a nicotine reward phenotype may be characterized via behavioral measures of self-administration, self-report assays, and imaging measures of activity in brain regions associated with reward processing. This, in turn, could spur the hunt for more genetic variants and gene-gene or gene-environment interactions to account for more of the overall genetic variation estimated in the biometric models. Inclusion of quantified life events, cultural factors, and extant clinical and public health efforts in tobacco control and prevention in genetic studies is also warranted.
- Genome-wide association analysis of phenotypes considered to be risk factors for the adoption or maintenance of nicotine dependence would lead to further understanding of the pathways by which children progress to adult nicotine dependence.
- Given the enormous social, health, and economic impacts of nicotine dependence, the coordinated effort of multiple research teams to address the many opportunities for further research identified in this volume is warranted.
- There is a need to examine the association between gene variants and phenotypes of relevance in both the presence and absence of environmental risk factors. Emerging evidence from longitudinal studies of adolescents suggests that genetic associations with indices of

nicotine dependence may be stronger and more robust when acting in the absence of environmental pressure to not use tobacco. Another way in which gene-environment interactions may influence nicotine dependence is during and/or following attempts to quit the use of nicotine-containing products. For example, variation in genes responsible for drug metabolism could interact with the dosing or duration of pharmacotherapy for nicotine dependence to reduce drug efficacy. A third possibility for further exploration of gene-environment interactions involves the period following smoking cessation. The relationship between genetic variation and the likelihood of relapse back to nicotine dependence could well be dependent on the presence of conditioned cues to smoke or environmental stress.

- Epigenetic methodologies promise to further understanding of the impact of the environment on the differential expression of gene variants. One possible approach, described in chapter 2, involves the comparison, at the genomic and/or expression level, of lymphoblastoid cell lines from identical twins discordant for nicotine dependence or other characteristics such as nicotine metabolism. Informative measures of environmental exposures will enhance the power of this approach to account for monozygotic twin discordance.
- Much of the tobacco literature examines genetic susceptibility to smoking initiation and cessation only among very broad groups, without an understanding of the complexities or variations within these categories in patterns of smoking behavior. Combining very different subgroups of smokers into a few common phenotypes and then using such heterogeneous groups in research studies may be hindering progress in understanding the role of genetics in complex behaviors such as smoking.

Moreover, standard definitions of smoking behavior from epidemiological surveys are not commonly used, making it difficult to compare results among genetics studies and to put these results into the context of knowledge gained from other disciplines. Therefore, researchers should be encouraged to use existing standardized definitions and measures of tobacco use behavior and to examine the role of genetics and environment in a greater number and broader range of more homogeneous groups of tobacco users.

- Epidemiologists and surveillance researchers should be encouraged to contribute more to the conceptualization, identification, definition, and operationalization of potential phenotypes of tobacco use behavior and then to demonstrate the utility, reliability, and validity of these potential phenotypes by using data from representative national surveys.

References

1. Centers for Disease Control and Prevention. 2007. Cigarette smoking among adults—United States, 2006. *Morbidity and Mortality Weekly Report* 56 (44): 1157–61.
2. World Health Organization. 2008. *WHO report on the global tobacco epidemic 2008: The MPOWER package*. Geneva: World Health Organization.
3. Farrelly, M. C., T. F. Pechacek, K. Y. Thomas, and D. Nelson. 2008. The impact of tobacco control programs on adult smoking. *American Journal of Public Health* 98 (2): 304–9.
4. Gottesman, I. I., and J. Shields. 1972. *Schizophrenia and genetics: A twin study vantage point*. New York: Academic Press.
5. Gottesman, I. I., and J. Shields. 1973. Genetic theorizing and schizophrenia. *British Journal of Psychiatry* 122 (566): 15–30.
6. Caspi, A., and T. E. Moffitt. 2006. Gene-environment interactions in psychiatry: Joining forces with neuroscience. *Nature Reviews Neuroscience* 7 (7): 583–90.

2

Status of Genetic Studies of Nicotine Dependence

Gary E. Swan, Christina N. Lessov-Schlaggar, Laura Jean Bierut, Alexandra E. Shields, Andrew W. Bergen, and Michael Vanyukov

This chapter frames important issues in identifying potential phenotypes of nicotine dependence and sets the stage for examining the role of genetics in nicotine-dependence research. Key areas discussed include

- *Issues in the definition and measurement of nicotine dependence*
- *A framework for phenotypes for nicotine dependence that potentially links genetics and behavioral traits while showing measurable validity, reliability, and heritability*
- *The implications of epidemiological concepts in identifying potentially complex genetic risk factors for nicotine dependence*
- *Measuring environmental influences and including them in models of estimates of genetic risk and the role epigenetic investigations will play in future investigations*
- *A review of selected biometric and genetic studies of nicotine dependence*
- *The communication and interpretation of findings from genetic studies of nicotine dependence, including the need for replication, the potential for stigmatization, and value of direct-to-consumer marketing of genetic tests based on these findings*

This volume examines conceptual, theoretical, and methodological considerations in the development of nicotine-dependence phenotypes and endophenotypes. Each of these areas shows the potential for future study to help better understand factors in global tobacco use.

The analyses described herein were supported by National Institute of Health grants CA89392, DA005605, DA018019, DA018701, DA019157, DA11070, DA21237, and HG003475-02, and University of California Tobacco-Related Disease Research Program 7PT-2000. Dr. L.J. Bierut is listed as an inventor on a patent (US 20070258898) held by Perlegen Sciences, Inc., covering the use of certain SNPs in determining the diagnosis, prognosis, and treatment of addiction. Dr. Bierut has acted as a consultant for Pfizer, Inc. in 2008.

Introduction

Environmental influences on tobacco use in the United States have intensified dramatically over time and account for the sharp reduction in the overall prevalence of smoking (figure 2.1). An enormous body of literature, evolving separately from that on genetics and nicotine dependence, clearly documents the effect of specific environmental influences on the likelihood of exposure to tobacco, its regular use, its chronic use, and the difficulty some people have in stopping use. Protobacco stimuli are ubiquitous in the environment and include advertising by the tobacco industry and the portrayal of smoking in movies. Equally important, the tobacco industry controls the design of cigarettes and, so, the bioavailability of nicotine. The form in which the nicotine is delivered is an important variable that almost certainly interacts with the biological factors discussed in this report. Similarly,

antitobacco stimuli have become almost as widespread in some parts of the world. Antismoking media, smoke-free workplaces and public places, smoke-free homes, concern over secondhand smoke, and the pricing of tobacco products are a few of the sources of environmental variation.

The marked decline in cigarette consumption in the United States since the 1960s (most of which has taken place since 1981 [640 billion cigarettes consumed compared to an estimate of 371 billion cigarettes in 2006]) corresponds to increased public awareness of the dangers of tobacco use, changing social norms about tobacco, and increased governmental actions to regulate the use, sale, and advertising of tobacco products. The most comprehensive environmental changes have been in attitudes and rules about smoking in enclosed public places. As late as 20 years ago, smoking was ubiquitous in most places, with smoking allowed virtually everywhere (unless it posed a danger of fires or damage

Figure 2.1 Cigarette Consumption in the United States in the Twentieth Century

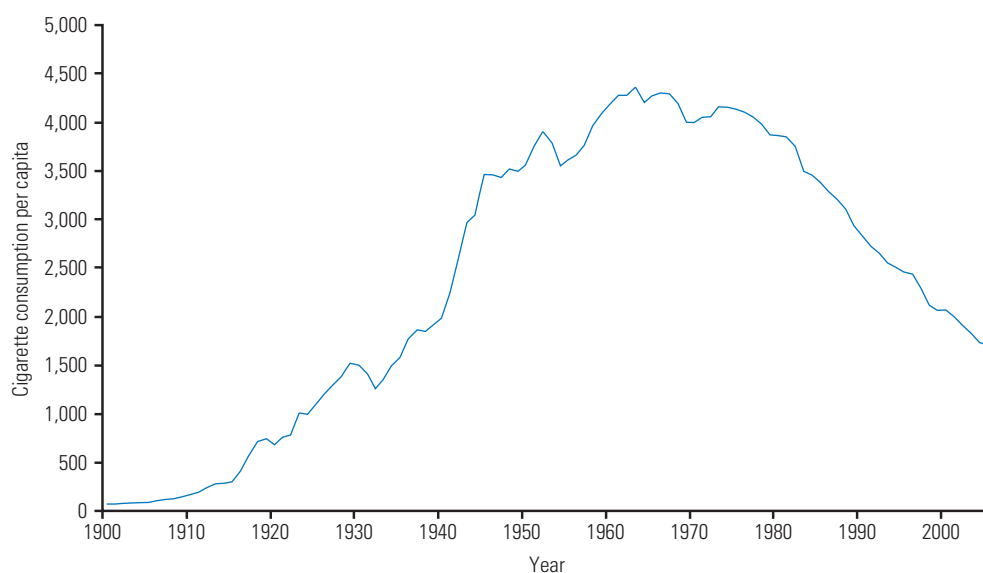

Note. From National Center for Health Statistics, Centers for Disease Control and Prevention, 2002. Cigarette consumption: U.S. Department of Agriculture, 1900–2000.

to equipment). Over time, the environment that had supported smoking indoors has transformed. Limiting where people can smoke has contributed to the social marginalization of smoking as an accepted behavior. In addition, another major reason for this decline is the associated rise in price per pack from about \$1.50 in 1980 to more than \$4.20 in 2007.¹

However, despite price increases and intensive public health control, an estimated 45 million people in the United States still smoke (17 million attempt to quit annually),² testifying to the fact that the consistent application of already effective methods of prevention and intervention is necessary to further reduce the prevalence of tobacco use in this country.³ The annual cost to the U.S. economy is estimated to be \$167 billion due to premature death and disability.²

It is estimated that approximately 1 billion people worldwide are regular users of tobacco (96.3% of smokers are outside of the United States) and that 3–6 million people die every year from tobacco-related illnesses.⁴ This number is expected to climb to 9 million by the year 2030.⁵ The prevalence of smoking outside the United States varies widely but is as high as 60% among men in some countries. The prevalence of smoking among non-American women is generally lower but appears to be rising in some countries as “westernization” continues.⁶ These data suggest that the effects of culture are another important aspect of environmental influences. For example, in many cultures, very few women smoke. The fact that more women start to smoke when moving from these cultures to the United States (or other places where smoking by women is accepted), or when exposed to cigarette marketing targeted to women, demonstrates dramatically the power of the environment to influence nicotine dependence. On a population-wide basis, the great diversity in tobacco use behaviors observed both between

countries and within countries over time demonstrates that biology alone cannot fully explain variations in tobacco use behaviors. These statistics indicate that the demand for both prevention and intervention efforts at tobacco control will continue to increase and will become urgent as the costs to existing and emerging economies are realized. All available tools will be needed to meet the demand for effective and sustainable tobacco control, including pharmacogenetic-informed treatments and social policy interventions⁷ for smoking cessation.

The highly addictive nature of nicotine and the more than \$13 billion spent annually by the tobacco industry⁸ to market its products to the American people contribute much to influence new and continuing smokers. However, the majority of adults and children choose not to use tobacco products. The answer to the question of intense scientific interest, “Why do some people smoke and others do not?” remains as elusive today as it was in 1993 when it was articulated by Pomerleau and colleagues.⁹

Although work in the human domain as well as in animal models has contributed to knowledge of the processes and pathways underlying nicotine dependence specifically, and addiction more generally, it is fair to say that knowledge derived from genetic studies of nicotine dependence has yet to inform prevention or cessation efforts. This has led some to conclude that research on nicotine dependence should be given a lower priority in the search for genes for complex disorders.^{10,11} However, given the large public health burden of tobacco use, the continued influx of new tobacco users, and the demands of sustained smoking cessation, it is imperative that the search for answers continues unabated.^{12,13} Environmental modification for the prevention and management of common conditions has been beneficial, but generic interventions should be supplemented by specifically targeted treatment based on a more precise

knowledge of biological mechanisms if further progress is to be made.¹⁴

Papers such as those by Merikangas and Risch¹⁰ and Carlsten and Burke¹¹ do not address the fact that complex traits such as nicotine dependence are multiply determined and treated. Previously, an integrative model of tobacco use and nicotine dependence was described¹⁵ (figure 2.2) that recognizes the role played by individual differences in vulnerability factors,¹⁶ in tobacco use trajectories,^{17–20} in environmental exposure,²¹ and in nicotine metabolism and nicotine dependence, including motivations to smoke and the reinforcement derived from tobacco.^{22,23} Certain factors such as anxiety, depression, use of other substances, and family history of tobacco use, along with individual differences in nicotine sensitivity or metabolism, might themselves have genetic components.¹⁶ It has been suggested that the effects of these variables on subsequent likelihood of smoking are mediated by personal factors such as lower performance on certain tests of cognition, socioeconomic status, and the occurrence of events within the social environment such as having peers who smoke and family discord.^{16,24}

Nicotine, the psychoactive alkaloid found in tobacco products, is thought to play a major role in nicotine dependence. Most smokers tend to ingest similar amounts of nicotine from day to day, consistent with the idea that they titrate their dose of nicotine to achieve desired effects.²⁵ Nicotine is extensively metabolized in the body, primarily by the liver cytochrome P-450 enzyme CYP2A6.^{26,27} Some studies have shown that the rate of nicotine metabolism may be related to nicotine-dependence risk.^{28,29} Because CYP2A6 activity affects the rate at which nicotine is eliminated, genetic alterations in the CYP2A6 enzyme may affect smoking behavior and nicotine dependence, and this deserves additional attention. Other genetic factors that may contribute

to nicotine dependence include variation in pathways responsible for nicotine reward and pleasure.^{30–32} An important feature of the model for tobacco use over the life span is that genetic and environmental factors exerting influence at different points in the development of tobacco use (e.g., initiation, maintenance, cessation, and relapse) are likely to be different.³³

Another feature in figure 2.2 that requires further investigation by genetic studies of nicotine dependence concerns the plethora of environmental conditions that are recognized to play a role in the acquisition, maintenance, cessation, and relapse of smoking.³⁴ Simply put, with one exception in 2007,³⁵ genetic investigations of smoking did not incorporate environmental measures into their study designs. It has been shown that genetic risk for smoking is lower at higher levels of parental monitoring,³⁵ suggesting that parental monitoring may help counteract genetic susceptibility to smoking behavior.

Historical Perspective of Genetic Research on Nicotine Dependence

A focused research agenda on the genetic basis of nicotine dependence is a relatively new development, but there have been earlier studies and claims about a potential genetic or constitutional basis for smoking behavior. Beginning in the 1950s, surveys showed that smokers and nonsmokers differ on a number of characteristics, including personality, occupation, diet, and physical characteristics.^{36,37} In addition, legendary British statistician Ronald Aylmer Fisher argued that a common cause, likely genetic or constitutional, might be responsible for a tendency to smoke and increased susceptibility to cancer. In two letters to *Nature*, Fisher described two small studies of twins suggesting that monozygotic twins,

Figure 2.2 Trajectories as Phenotypic Pathways

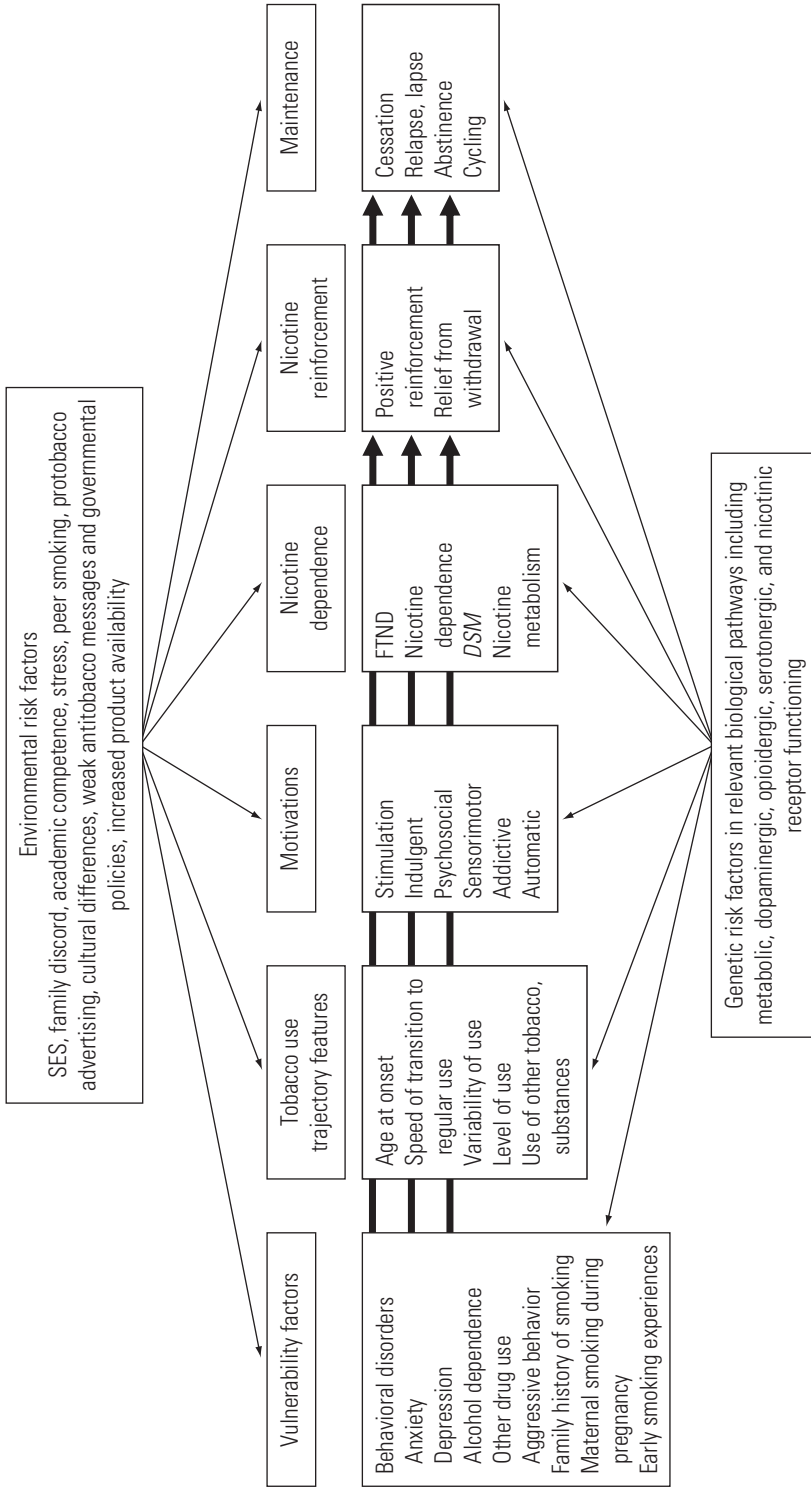

Note. SES = socioeconomic status; FTND = Fagerström Test for Nicotine Dependence; DSM = Diagnostic and Statistical Manual of Mental Disorders. Adapted from Swan, G. E., K. S. Hudmon, L. M. Jack, K. Hemberger, D. Carmelli, T. V. Khroyan, H. Z. Ring, et al. 2003. Environmental and genetic determinants of tobacco use: Methodology for a multidisciplinary, longitudinal family-based investigation. *Cancer Epidemiology, Biomarkers & Prevention* 12 (10): 994–1005.

even when separated at birth, tend to have similar smoking habits.³⁸ While the evidence was limited, Fisher argued that his primary purpose was to draw attention to the inadequacies of the epidemiological studies on smoking and health.³⁹ The landmark 1964 Surgeon General's report on smoking and health reviewed the evidence linking smoking behavior with various characteristics and concluded that there was "overwhelming" evidence that smoking was psychologically and socially determined but that there was not yet any consistent evidence for constitutional or hereditary factors.^{40(p377)} Nevertheless, Fisher's proposal, which came to be known as the "constitutional hypothesis," was one of the central arguments used by the tobacco industry to question the emerging evidence on cigarettes.⁴¹

Although it was widely recognized that many smokers exhibited characteristics of dependence, this phenomenon was initially viewed as primarily psychological and social, rather than pharmacological.⁴² The 1964 Surgeon General's report specifically concluded that tobacco dependence should be described as "habituation" rather than "addiction" to differentiate it from the effects of narcotics and other "more potent" addicting drugs.^{40(p350)} During the early 1970s, a few pioneering scientists, notably Murray Jarvik and M.A.H. Russell, began studying smoking behavior and the role of nicotine to understand the dependence process.^{43,44} Yet, it was not until the late 1970s, that a substantial contingent of behavioral scientists who had been studying other forms of drug addiction began to develop a research agenda around smoking;⁴⁵ and the 1979 Surgeon General's report was the first to devote substantial attention to smoking behavior and dependence.⁴⁶

Research in humans involving the relationship between measured genetic factors and smoking was first reported in 1993.^{47,48} Since the initial reports, many

published papers have reported associations between smoking behaviors and variants in a number of candidate genes. In all cases, the effect sizes reported were modest in nature, and until 2007, the studies were small and relied upon broad categories of smoking behaviors. The studies also reported single gene associations, some of which included variants with no known functional consequence. At least four separate meta-analyses of the literature concluded, that after interstudy heterogeneity has been taken into account, the association between genes and smoking behavior is modest indeed.⁴⁹⁻⁵²

Approximately 25 linkage studies in families have reported cosegregation of smoking behaviors with specific genomic regions. Few to none of these reported linkages have been strong enough to be called significant by current standards, and interestingly, many of the genomic regions that have been identified do not contain candidate genes of interest. Before 1978, most of the studies relied upon study samples that were constructed for reasons other than the study of smoking, used broad or imprecise classification of smoking behaviors, and relied on relatively loosely spaced marker sets with intermarker distances of five centimorgans (cM) or more. The first attempt to map susceptibility loci for nicotine dependence per se used the Fagerström Tolerance Questionnaire (FTQ)⁵³ (nicotine dependence defined as a score of seven or more) in a convenience sample of 130 families from Christchurch, New Zealand;⁵⁴ the FTQ was the precursor of the Fagerström Test for Nicotine Dependence (FTND). While initial results by Straub and colleagues showed limited evidence for linkage with specific regions (the strongest being a sharp peak at or near D2S1326), a subsequent reanalysis of the same data with different methods detected the same peak with an estimated Z-score of about 2.5.⁵⁵

Despite the cumulative results from work beginning in the early 1990s, there is still

no example in which these findings have made a difference to the early detection, prevention, or treatment of nicotine dependence. Collectively, the work in humans and animals has provided new insight into the underlying neurobiology by underlining the extreme complexity of nicotine dependence. In this regard, conclusions from the body of evidence from the first generation of measured genetic studies of nicotine dependence parallels similar conclusions from first-generation studies of other complex traits in general and those from psychiatric genetics more specifically.

Noting the problems of nonreplication in psychiatric genetics research, Caspi and Moffitt in 2006⁵⁶ identified three general approaches that have been taken in the literature. The first approach assumes direct linear relations between gene and behaviors, and this would be an accurate characterization of the bulk of the work on nicotine genetics summarized above. The second approach involves the use of intermediate phenotypes, also known as endophenotypes, that are related to an illness, are heritable, and could be neuropsychological, neurophysiological, biochemical, endocrinological, or neuroanatomical in nature. One of the assumptions of this approach is that these constituents will have simpler genetic underpinnings than does the disorder itself. The third approach involves the study of gene-environment interactions in which it is assumed that “environmental pathogens” cause a disorder such as nicotine dependence only in the presence of certain gene variants. The second and third approaches have yet to be fully exploited in the context of nicotine dependence. One of the objectives of the present monograph is to more fully explore the existing options to inform the next generation of genetic studies for all three of the research traditions for complex genetic traits.

The introduction of powerful, new genomic technologies will make previous research quickly obsolete. With the decrease in costs and the use of platforms to genotype individuals for very large numbers of variants across the whole genome, the genome-wide association study (GWAS) has now become possible. Similarly, it is now possible to genotype candidate genes not just for one variant but for many variants (known as single nucleotide polymorphisms [SNPs]), many of which are functional in nature by virtue of either their location or experimental validation. The first published example of this approach to the study of nicotine dependence and genes is summarized later in the section, “Genome-wide Association and Candidate Gene Studies of FTND.”

Unfortunately, the definition and measurement of nicotine dependence has not kept pace with the increased precision in the genomic arena. There is vigorous debate over what constitutes the critical constituents of nicotine dependence, and a definition that most or all investigators can agree upon remains elusive. One of the assumptions of this present volume is that until progress is made in understanding and resolving the conceptual and measurement issues in nicotine dependence, the yield from the advances in genomic science to better understand nicotine dependence will not be fully realized.

Nicotine Dependence: A Construct in Need of Refinement

One of the most troubling aspects of the state of nicotine-dependence measurement is the oft-cited finding from Moolchan and colleagues⁵⁷ in which poor agreement between the two gold-standard measures of nicotine dependence, the FTND and the *Diagnostic and Statistical Manual of*

Mental Disorders (DSM), was documented. This paper found that the kappa estimate of concordance was only .2, not much better than that expected by chance alone. This initial finding was confirmed in adolescents.⁵⁸ Both papers agree that the two measures, although claiming to be assessing nicotine dependence, are, in fact, assessing two different groups of smokers. The *DSM*-based approach appears to place a heavier emphasis on psychiatric symptoms, while the FTND appears to place a heavier emphasis on physical symptoms.

A consensus has emerged in which nicotine dependence is viewed as multidimensional and, therefore, should be assessed and quantified accordingly.^{9,23,57,59,60} Although it was pointed out earlier^{59,61} that dependence has several dimensions, including physical, behavioral, and psychological components, the assessment of nicotine dependence has relied largely upon the FTQ⁵³ and the FTND⁶² or *DSM* Fourth Edition (*DSM-IV*) criteria, an approach deriving from the need to include nicotine dependence in psychiatric nomenclature and classification and that attempts to adhere to classic definitions of drug dependence.^{63,64} Although both paper-and-pencil and psychiatric diagnostic approaches have provided reliable definitions for use in many different types of studies, neither of the existing assessments relies upon test development approaches well grounded in psychometric theory.

Multidimensional scales for assessing nicotine dependence have been published. However, their incorporation into genetic studies (biometric or measured) is only just beginning and the question of *which* components of nicotine dependence have the most or least genetic influence has only been addressed since 2004. A study by Lessov and colleagues,⁶⁵ described later in the section “Heritability of Components of Nicotine Dependence in Adults,” was the first to document the relative proportion of

genetic and environmental influences on diagnostic nicotine-dependence criteria, thereby opening the way for future studies to investigate dependence at a more precise level. Swan and colleagues⁶⁶ (also summarized later in the section “Linkage Analysis of FTND and Other Indices of Nicotine Dependence”) was the first linkage study to recognize the complexity of the nicotine-dependence phenotype by including multiple phenotypic markers in the analyses.

The literature on the test-retest reliability of self-reported tobacco use reveals that over short and longer intervals, reliability is substantial for summary measures of nicotine dependence. The FTQ and derivatives (mFTQ, FTND) have acceptable levels of test-retest reliability that range from .72 to .92 over intervals up to 1.8 years in length.⁶⁷⁻⁷⁴ Alternative measures of nicotine dependence have comparable 2- to 10-week test-retest reliabilities.^{22,72,75-84} Only one study has reported test-retest reliability over an interval consistent with that in typical population surveys (up to 12 years)⁸⁵ and found acceptable reliability for total FTQ (.62) and FTND (.72) scores.

A number of authors suggest that milestones in the development of smoking behavior and/or individual items from several of the nicotine-dependence measures may be good candidates for inclusion in a genetic study of nicotine dependence. For example, there is significant additive genetic variance for age first smoked^{86,87} and individual items from the FTND as well as diagnostic nicotine-dependence criteria.^{65,88,89} However, at the level of individual items, it is evident that more needs to be known about test-retest reliability over intervals consistent with those in population-based surveys. Reliability estimates are more variable (0–.90) for individual items from the FTQ,⁶⁷⁻⁶⁹ the FTND,^{68,85} and the Hooked on Nicotine Checklist.^{80,82} Perhaps not surprisingly, reliability of recall for specific

smoking behaviors such as smoking status and cigarettes smoked per day (CPD) are highly reliable for intervals of 3 years^{81,90,91} and up to 15 years.⁸⁵

Initial reactions to the first experience with smoking have also been suggested as an interesting and potentially informative phenotype for further genetic investigations.⁹² Initial sensitivity, perhaps related to genetic variation in metabolic, neural, and/or airway pathways, in combination with the social environment may well influence which adolescents who experiment with tobacco go on to become regular smokers. Initial reactions and tobacco use milestones could be easily assessed in prospective, longitudinal studies of adolescents during and after experimentation. More commonly, however, there is a need in large, population-based studies to assess these characteristics retrospectively in adults with tobacco use history. Initial findings suggest that reported age at first cigarette may be easier to recall than one's subjective reaction to the first cigarette ever tried.^{93,94} The extent to which the circumstances surrounding tobacco use (e.g., stress levels, other smokers, and depression) can be recalled reliably is of major interest, given the previously noted need to test for the presence of gene-environment interactions. Chapter 3 addresses many of the most important issues surrounding the measurement of nicotine dependence.

Nicotine-Dependence Phenotypes: A Framework

In most previous behavioral genetic and genetic epidemiological studies, “smoking” has been assessed as a static phenotype—that is, as if the behavior is a trait that remains constant over time. However, a variety of studies from the developmental,

epidemiological, psychiatric, and smoking literature suggests that smoking, in general, and the consumption of nicotine on a regular basis, specifically, is tremendously more complex than the simple trait perspective.⁹⁵ Not only do reasons and motivations for smoking vary across individuals, it is likely that motivations (biological, social, and psychological, individually and in combination with each other) vary within an individual across time and situations.^{34,96,97}

The field of psychiatric genetics is an area fraught with numerous examples of nonreplication.⁹⁸ However, some investigators believe that endophenotypes,^{99,100} relying on actual measurements of behavior, physiological responses, or biological characteristics, such as brain structure from imaging studies, will provide more replicable associations with genetic variants than have more general diagnostic measures.^{101–104}

Endophenotypes are viewed as quantifiable components in the genes-to-behavior pathway and can be neurophysiological, biochemical, endocrinological, neuroanatomical, cognitive, or neuropsychological in nature. To be viewed as a viable candidate for use in a genetic study of nicotine dependence, an endophenotype must be (1) associated with nicotine dependence in the population, (2) heritable, (3) state independent, (4) cosegregated with nicotine dependence in families, and (5) present at a higher rate among unaffected relatives of those with nicotine dependence than in the general population. Waldman¹⁰⁵ further suggests that candidate endophenotypes should have good psychometric properties, such as test-retest reliability, and be normally distributed. On the basis of work in schizophrenia as an example, endophenotypes that meet all or most of the criteria listed above include prepulse inhibition (a measure of sensory motor gating deficits), eye-tracking

dysfunction, and working memory.^{104,106} Other branches of psychiatry have adopted the endophenotypic approach to investigate bipolar disorder, depression, Alzheimer's disease, attention deficit hyperactivity disorder (ADHD), autism, alcoholism, and personality disorders. Work in the field of ADHD, in particular, has benefited from this approach.¹⁰⁷ Some concerns have been raised, however, that the endophenotype approach may lead researchers to conduct smaller, underpowered studies because it is assumed that the more proximal measures will result in a stronger genetic signal. In the field of nicotine dependence, this remains an empirical question.¹⁰⁸

In the field of tobacco use, numerous possibilities exist in which the relationships of phenotypes to genetic factors may actually be larger should the full range of phenotypes be explored. A framework was developed to organize phenotype selection for genetic investigations of tobacco use largely on the extent to which they could provide progressively more-fine-grained markers of nicotine dependence.¹⁵

At the least specific level, categories of smoking status and measures of amount smoked (class I) are included. The bulk of the work on genetics and smoking has relied upon these relatively nonspecific measures. Chapter 10 presents examples of how the definition of even broad phenotypes can be improved to be more specific within the context of epidemiological research. At the next level (class II), specific measures of nicotine dependence and their constituents are included because, while these may be related to quantity smoked, they appear to measure additional dimensions of nicotine dependence not assessed by simple measures of quantity consumed. Along with nicotine dependence, also included are withdrawal symptoms, motivations to smoke, as well as smoking topography, and more-fine-grained measures of *how* and *why* people consume tobacco.

Underlying the class III designation is the assumption that *how* individuals *attain* regular tobacco use (e.g., a trajectory) may be just as important as the fact that they are or have been regular users of tobacco. At this level of specificity, time-based aspects of an individual's history with tobacco become important, including the rate, level, and variability at which adolescents progress to regular tobacco use. The authors of chapters 5, 6, and 7 take a deeper look at approaches to identify tobacco use trajectory subgroups, the feasibility of their use as phenotypes in genetic studies, and the extent to which conjoint trajectories (tobacco and alcohol use) appear to have heritable components. At the highest level of specificity—class IV in this scheme—putative biological or physiological markers of nicotine dependence are included, such as pharmacokinetics and pharmacodynamics of nicotine, changes in neuropsychological function in response to nicotine, and changes at the receptor level (function, density). Chapter 4 addresses the issue of neurobiological phenotypes in animal models that can be viewed as analogs to class IV phenotypes in the human condition.

Available evidence indicates that the phenotypic options also vary as to whether they can be measured reliably, have validity as constituents of nicotine dependence, and are heritable—all three characteristics being defining criteria of endophenotypes. The most consistent evidence available is for the more general class I phenotypes. The crude measures of smoking status and quantity smoked can be measured with reliability over limited time intervals and are consistently correlated with components of measures of nicotine dependence. Their heritability has been well documented in twin and family studies.

Heritability estimates vary depending on how a phenotype is defined and the types of tobacco users (never, occasional, regular) included in the phenotypic definition.

Twin studies have addressed the genetic and environmental contributions to variation in several class I tobacco use phenotypes: initiation of tobacco use, measures of cigarette-smoking patterns (such as regular or current smoking), and measures of quantity of use (such as number of CPD). Across studies, measures of quantity of cigarettes smoked have been shown to be significantly heritable with estimates of heritability ranging from 45% to 86% for number of CPD^{65,87,109–113} and 46% to 49% for heavy smoking.^{114,115}

Lifetime regular smoking (a class I phenotype) often has been defined as having smoked 100 or more cigarettes in a lifetime and having exhibited a regular pattern of cigarette smoking. Regular smoking has been repeatedly shown to be moderately to highly heritable with an average estimate of approximately 50%.^{102,116–119} Smoking persistence (also a class I phenotype), defined as being a current smoker versus a past smoker, also has been consistently shown to be heritable, with genetic influences estimated at 27% to 82%.^{33,117,120–123}

Smoking initiation (class I) has generally been defined as a “yes” response to a question assessing whether a respondent has ever smoked or has ever tried smoking, but some studies have used an operationalization of smoking initiation (having smoked 100+ cigarettes) that could more accurately be described as ever smoking.^{98,117,120,121,123} The smoking initiation phenotype thus includes a heterogeneous group of smokers, ranging from people who may have tried smoking cigarettes only once, to heavy, dependent cigarette smokers. Not surprisingly, estimates of genetic and shared environmental effects on smoking initiation vary greatly across studies. Some studies have shown greater importance of shared environmental effects (44% to 54%) compared with genetic effects (11% to 39%) on smoking initiation;^{33,113,123–125} other

studies have shown substantial heritability (43% to 85%) and a relatively smaller role of shared environment (0% to 68%) for smoking initiation.^{33,98,117,120,121,126–128} Conceivably, studies that report greater genetic effects for smoking initiation may contain a greater proportion of regular and heavier smokers—two smoking dimensions with a strong genetic signal, relative to occasional or lighter smokers—for whom genetic differences from nonsmokers may be less important than environmental. Also, evidence shows differences in the relative contribution of genetic and shared environmental effects for smoking initiation across gender, age and age cohort, and culture.^{33,120,121,123,126}

At the next level of measurement, most measures of nicotine dependence, such as the FTND and the *DSM*-based classification, have shown acceptable levels of test-retest reliability, and some have been reported to have high to moderate heritability. The validity of many of the measures, however, is uncertain because the two primary measures of nicotine dependence are not correlated with each other, and the extent to which nicotine dependence is associated with motivations, withdrawal, and/or smoking topography is generally unknown as well.

For class II nicotine-dependence phenotypes, defined by the *DSM* Third Edition Revised,¹²⁹ *DSM-IV*,⁶³ or Fagerström criteria, heritability estimates ranged from 31% to 60%,^{65,88,89,128} and for dependence as defined by the Heaviness of Smoking Index (HSI),¹³⁰ which comprises two of the seven FTND items, heritability was also high (59% to 71%).^{65,89} In an analysis examining the genetic relationship between lifetime regular smoking and nicotine-dependence operationalization by using items from the FTQ⁵³ and the *DSM-IV*,⁶³ Kendler and colleagues⁹⁸ found substantial genetic effects for regular smoking (85%), substantial overlap in liability for regular

smoking and nicotine dependence (60%), and moderate residual genetic effects for nicotine dependence (22%), suggesting overall considerable heritable influences on both regular smoking and nicotine dependence. Individual diagnostic criteria also have been shown to be significantly heritable (26% to 73%), with little to no evidence for a significant contribution from shared environmental effects.^{65,89,131} Individual nicotine withdrawal symptoms have been shown to be moderately heritable, ranging from 9% to 53%,⁸⁹ with no evidence for a significant contribution from shared environmental effects.

Class III phenotypes—or smoking trajectories—appear to be reliable across a number of studies, although the extent to which they can be assessed reliably with a retrospective methodology is not clear. Their validity as constituents (precursors) of adult nicotine dependence is unknown as is the extent to which membership in a trajectory subgroup is influenced by genetic factors. Before the appearance of the present volume, no studies had been published on the contribution of genetics to variation in longitudinal tobacco use phenotypes (class III), such as developmental smoking trajectories. One study of adolescent twins that involved three data collection periods across seven years generated cross-sectional smoking groups (never smokers, triers, experimenters, current smokers). The study examined the cross-sectional heritability of a smoking index variable that combined frequency and recency of cigarette smoking across groups and thus captured the smoking experience across groups at each time of assessment, but not the smoking experience of each group across assessments.¹⁹ The study found that, at each wave of data collection, the smoking index variable was significantly influenced by genetic factors (21.8% at wave 1, 22.8% at wave 2, and 35.5% at wave 3) and by shared environmental factors (52% at wave 1,

51.7% at wave 2, and 36.7% at wave 3).¹⁹ Of note is the importance of shared environmental factors which, while not measured in this study, include influences such as protobacco advertising and product availability. The first investigation of twin concordance for tobacco- and alcohol-use trajectories is presented in chapter 7.

Several studies have examined the relative contribution of genetic and environmental influences on the transitions from smoking experimentation to higher levels of smoking and nicotine dependence. Using correlated liabilities models, these studies have shown an overlap in the genetic and environmental influences on liability to smoking initiation with liability to smoking persistence,^{33,117,120} smoking quantity,¹¹³ regular use,¹²⁷ and nicotine dependence.^{98,127} At least two studies demonstrated that, in older age groups (aged 30 years and older), genetic and environmental factors that determine liability to smoking initiation are independent from those that determine liability to smoking persistence.^{33,120} Except for one study,¹²⁷ these studies showed a relatively larger influence of shared environmental factors on smoking initiation and a smaller to no significant influence of shared environment on smoking persistence, quantity smoked, or nicotine dependence, consistent with much other work, as discussed earlier. While not measured in the present study, shared environmental influences could include the well-documented effects of smoke-free homes.

Finally, while the measurement properties of some of the class IV phenotypes such as nicotine pharmacokinetics and dynamics are well described, and significant heritability has been demonstrated in both biometric and measured genetic contexts (see the section below, “Heritability of Nicotine Metabolism,” for an example), these characteristics for many of the other potential candidate endophenotypes

are unknown. Moreover, the validity of these measures as constituents of nicotine dependence appears thus far to be problematic or without documentation.

The majority of adolescent and adult twin studies agree that the relative contribution of genetic influences on smoking initiation is smaller than that on downstream smoking phenotypes such as progression to regular smoking, smoking persistence, nicotine dependence, and smoking cessation. Conversely, the relative contribution of environmental factors is larger in smoking initiation than in downstream smoking phenotypes. These results suggest that environmental factors play an important role in experimentation with cigarettes, which largely occurs in adolescence, and that, beyond a certain level of experimentation, genetic liability becomes a stronger determinant of cigarette smoking. From the perspective of intervention and genetic studies of smoking, it appears that a genetically informative endophenotype for nicotine dependence may vary across age, as well as across levels of use.

With regard to existing molecular genetic literature involving smoking-related phenotypes, most reported studies examined class I phenotypes measured retrospectively.^{48,132–152} Since 2003, the number of papers that use retrospective measures of nicotine dependence—that is, class II indices—has been increasing.^{142,153–167} Retrospective case-control designs are subject to limitations of recall bias. Many of these studies have not received independent confirmation as of the writing of this chapter. A notable exception to the use of retrospective self-report measures of nicotine dependence is the paper by Ray and colleagues,¹⁶⁸ in which an experimental measure of the relative reinforcing value of nicotine (a class IV phenotype) was found to be associated with variation in the gene *OPRM1*.

Genetic Epidemiological Concepts and Their Implications for Studying Nicotine Dependence

Characteristics of Complex Genetic Traits

Nicotine dependence, a multidimensional construct, is a complex genetic trait. In this context, the term *complexity* is used as defined by the field of genetic epidemiology.^{169–172} A complex trait has several defining features: (1) it has reduced penetrance (i.e., not everyone with a susceptibility gene[s] will develop nicotine dependence); (2) genetic heterogeneity is involved (i.e., a different set of susceptibility genes may contribute to the likelihood of becoming a smoker in different people); (3) pleiotropy is involved (i.e., the same genetic risk factors may lead to different addictions, such as alcoholism, in addition to nicotine dependence in different people); (4) epistasis is involved, which refers to the situation in which a genetic risk factor modifies the expression of another genetic risk factor to produce nicotine dependence; and (5) environmental factors can interact with genetic risk to alter the likelihood of becoming dependent on nicotine.

The available literature involving measured genetics and nicotine dependence provides ample evidence that it is, indeed, a complex genetic trait. Incomplete penetrance is demonstrated by the fact that heritability of nicotine dependence is roughly 50% and that the odds of being a smoker even in the presence of a genetic risk factor is, on average, higher than in the absence of the risk allele.

Genetic heterogeneity is clearly evident when considering the number of genes that have been reported to be in association with nicotine dependence. These include *CHRNA4*,^{155,156} *CHRNA7*,¹⁴² *CHRNA9*,¹⁴² *CHRNB1*,¹⁶⁴ *CHRNB2*,¹⁴² *CHRNB3*,¹⁴² *OPRM1*,^{168,173} *DRD2* (evidence, however, suggests that the association with *DRD2* may be confounded by close proximity to *ANKKI*, a kinase gene),^{146,174} *DRD4*,¹³⁴ *COMT*,¹⁵⁹ *SLC6A3*,¹³⁵ *5-HTTLPR*,¹³³ *5HT2A*,¹⁴⁷ *CYP2A6*,^{29,150,163,175} *CYP2E1*,¹⁶¹ *GABA_{B2}*,¹⁵⁸ *MAOA*,^{148,152,162} *TH01*,^{149,153,154} *TPH*,¹⁶⁶ *SLC18A2*,¹⁵¹ *PTEN*,¹⁵⁷ *NTRK2*,¹⁵⁹ *EPAC*,¹⁶⁰ *DDC*,^{165,167} *CHRM1*,¹⁶⁴ *CCK*,¹⁷⁶ and *BDNF*.¹⁷⁷ A close review of these papers indicates substantial variation in the nature of the phenotype measured, ranging from CPD, maximum CPD, nicotine dependence, heavy smoking, smoking status, smoking initiation, withdrawal, regular smoking, and the relative reinforcing value of nicotine. Going forward, what is the best way to incorporate genetic heterogeneity into studies of nicotine dependence? What, if anything, should be concluded about the fact that the published linkage studies have identified regions for the most part that do not contain the candidate genes of interest? One answer to the problem of genetic heterogeneity is the use of an appropriate statistical framework capable of incorporating information about numerous genetic variants while simultaneously taking into account previous findings and expert knowledge to make sense of the plethora of associations reported. The use of Bayesian hierarchical modeling as informed by an ontological framework is described in chapter 12.

Pleiotropy is apparent because genes such as *DRD2* have been reported as associated with other addictive behaviors and/or affective disorders. That any one single gene may, in fact, be associated with a number of phenotypes is an issue that requires much more attention in the literature. In addition to being associated with smoking-related phenotypes such as ever

smoking,¹⁷⁸ smoking cessation in response to acupuncture,¹⁷⁹ smoking cessation in response to bupropion,¹⁸⁰ and smoking cue-induced cigarette craving,¹⁸¹ variation in *DRD2* has been reported as being associated with schizophrenia,^{182–184} alcoholism,^{185,186} quantity of alcohol consumed by adolescents and young adults,¹⁸⁷ obsessive compulsive disorder,¹⁸⁸ ADHD,^{189,190} cue-elicited craving for heroin,¹⁹¹ comorbid depression, anxiety, and social dysfunction associated with posttraumatic stress disorder,¹⁹² working memory in schizophrenics,¹⁹³ Tourette's syndrome,¹⁹⁴ anorexia nervosa,¹⁹⁵ neuroticism/anxiety in men,¹⁹⁶ and opium addiction.¹⁹⁷

The range of phenotypic correlates suggests, at the least, that variation in *DRD2* is not specific to nicotine dependence. The extent to which these indices of psychopathology are viewed as covariates or confounders of the association between nicotine dependence and variation in *DRD2* is highly variable across the published papers on this relationship. Another issue lacking clarity in the literature is the extent to which this plethora of psychiatric phenotypes is associated with and/or has any phenotypic subcomponent in common with nicotine dependence. Similar questions of phenotypic covariation can be raised about the literature involving variation in *OPRM1*, *5HTT*, *MAOA*, and *CHRNA4*. Evidence is addressed in chapter 8 that some of these phenotypes may serve as early indicators of risk for nicotine dependence before chronic exposure to nicotine.

Epistasis, the interaction between genes, was first reported by Lerman and colleagues¹³⁹ for *DRD2* and *SLC6A3* and then again by Lerman and colleagues¹⁹⁸ and by Swan and others.¹⁹⁹ These studies underscore the importance of considering the simultaneous effect of several genes on behavior in that the observed effect of any one gene may strictly depend on variation in another gene. For example, investigation of the effect of

genes that are part of a common neural pathway that underlies behavior may be an effective approach (chapter 12 discusses the need for pathway analyses in greater depth).

No published examples of gene-environment interactions in nicotine dependence were found in the literature. Emerging work in the psychiatric genetic literature provides an example that such interactions may exist. The work of Caspi and colleagues²⁰⁰ reveals that variation in the *5HTT* gene may moderate the impact of life stress on depression. The subsequent work of Kendler and others²⁰¹ supports Caspi's original findings and extends them by demonstrating that the threat level of the life stress may be the most critical aspect in interaction with *5HTT* to ultimately produce depression.

The conventional twin model has been extended to account more fully for the effects of gene-environment interactions and/or correlations. Purcell²⁰² provides the tools to extend the traditional twin model to include a component for the effects of a moderator variable which, in the present case, could be a measure of the environment. Purcell indicates that, while having both genes and environment as measured variables would provide the most power to detect a gene-by-environment (G×E) interaction, as in Caspi and colleagues,²⁰⁰ most modern twin studies should be able to rely on a latent, unmeasured G and a measured E. The most powerful approach to the measurement of E will be a continuous measure. The application of these models²⁰²⁻²⁰⁴ has been demonstrated by Button and colleagues,²⁰⁵ who showed that the heritability of antisocial scores in young twins declines as family dysfunction scores increase, and by McCaffrey and others,²⁰⁶ who examined the relationship between education level and nicotine dependence in twins. The evidence that macrocontextual (e.g., cultural and socioregional) factors can modify genetic effects is reviewed in chapter 11 of this volume. New approaches

to the assessment of microcontextual (e.g., parental and peer smoking) factors are also described.

Implications for Selection of Nicotine-Dependence Phenotypes and Endophenotypes

Are Multiple Nicotine-Dependence Phenotypes Associated with Each Other?

As discussed in chapters 3 and 4, the issue of construct validity is of major importance to the pursuit of knowledge in this area. The extent to which various nicotine-dependence phenotypes are or are not associated with each other or with a universally accepted gold standard of nicotine dependence has not been well studied in the literature. For example, while a measure of consumption such as CPD may be highly correlated with the total FTND score ($r > 0.60$), a measure of nicotine metabolism, considered to be a basis for dependence, is correlated only modestly with CPD ($r = 0.12$, $p < 0.05$;²⁰⁷ $r = -0.15$, p is not statistically significant;²⁰⁸ $r = 0.33$, $p < 0.01$;²⁰⁹ and not at all with the FTND).^{207,209-211} Similarly, while adolescent trajectories of tobacco use can be clearly demarcated on the basis of number of cigarettes smoked, the extent to which adolescent nicotine metabolism is associated with trajectory group membership is unknown. The first evidence that trajectory group membership in adolescence may be associated with adult nicotine dependence is presented in chapter 5.

Are Multiple Nicotine-Dependence Phenotypes Associated with a Single Endophenotype?

The relationships that exist between each "marker" of dependence within each phenotypic domain need to be determined, along with the relationships that exist

across phenotypic domains, to reach a comprehensive understanding of the nature of nicotine dependence. For example, a long-standing hypothesis states that the rate of nicotine metabolism should be related to smoking behaviors, with faster elimination of nicotine being associated with increased rates of smoking and nicotine dependence.²⁵ While there are few published tests of this hypothesis, the papers that have been published lend only limited supporting evidence, with the rate of nicotine metabolism accounting for less than 16% of the variation in CPD^{209,210} and no significant amount of variance in the FTND²⁰⁹⁻²¹¹ or in the Horn-Russell Scale.²¹⁰ Kandel and colleagues²¹¹ found no significant association between the rate of metabolism and CPD in a sample of younger, lighter smoking, and less dependent smokers. A review of the discussion of results from these papers offers the following possible reasons for the apparent disconnect between rate of metabolism and nicotine dependence: (1) the questionnaire measures of adult nicotine dependence used may not be the most sensitive measures of rate of metabolism,^{209,210} (2) the rate of metabolism may only be related to nicotine dependence during the transition from experimentation to “addicted” smoking,²⁰⁹ or (3) the rate of metabolism is not an important determinant of smoking behavior in younger smokers because of a low level of smoking.²¹¹

From the standpoint of the present volume, the lack of evidence that the rate of nicotine metabolism is an important driver of nicotine dependence should create some urgency as to its construct validity. On one hand, the rate of metabolism is associated (although weakly) with CPD. CPD, at the same time, is substantially correlated with most or all existing measures of nicotine dependence. While the resolution of the apparent logical inconsistencies in the literature is beyond the scope of this chapter, some suggestions are offered for future research. For example, is “time to

first cigarette after waking up”—one of the key components of the FTND—associated with nicotine metabolism? One would hypothesize that individuals with faster clearance of nicotine or more extensive conversion of nicotine to cotinine would be associated with a shorter time to the first cigarette. Again, using nicotine metabolism as an endophenotype, is variation in nicotine clearance associated with subjective reactions to the first cigarette of the day? Chapter 3 makes a strong case for developing a comprehensive theory of nicotine dependence as a way to understand apparent logical inconsistencies in research findings.

Are Multiple Nicotine-Dependence Endophenotypes Associated with a Single Phenotype?

Another set of addressable questions emerge when the relationship among endophenotypes is considered. For example, is variation in nicotine metabolism related to performance increases on the measure of executive function or to related nicotine reward? If metabolism and executive function are related, are they associated to the same degree with specific and global measures of nicotine dependence? Chapters 8 and 9 suggest that relatively little is known about the relationship between candidate endophenotypes and measures of nicotine dependence.

Why Are Environmental Phenotypes Important?

Given the success of policy interventions in reducing smoking rates, some have argued that resources invested in genetics research on smoking would be better spent on those intervention strategies. The reasoning is that nicotine dependence “appear[s] to be highly amenable to environmental modification,” and “[r]esources would be far better placed in designing effective interventions and studying the causes of the gap between

knowledge and modification of health-related behaviors.”^{210(p601)} This argument, however, rests on a false dichotomy between the roles played by genes and environment in the etiology of nicotine dependence.

As argued in rebuttal to the above viewpoint,^{12,212,213} contemporary genetic research of complex diseases takes into account both genes and environment and seeks practical results within the full scope of etiologic mechanisms. The environment (e.g., aggressive tobacco promotions, cigarettes designed to maximize their addictive potential), rather than genes, is the most likely target of intervention. Moreover, the results of some molecular genetic studies of behavioral disorders^{214,215} have shown that genetic information may be critical to the discovery of environmental effects and vice versa.

Despite the fact that the genetic mechanisms of many genetic disorders are already known, this has not necessarily translated into efficient interventions exactly for the reason that these mechanisms are difficult to change. Genetic studies of complex disorders, in contrast, have barely departed from their nascent stage, but the significant contribution of environmental factors, even in the natural variation in the risk, promises a greater payback. It has long been understood that, regardless of heritability, the individual genotype determines the range of possible phenotypes under possible environments, the norm of reaction.²¹⁶

Numerous environmental risk factors for acquiring nicotine dependence have been identified in the literature.²¹⁷ However, it is not yet clear whether any of these have the possibility of interacting with genetic risk factors to heighten the likelihood that an individual will become dependent. A number of these have the potential to be an “environmental pathogen”—that is, a characteristic of the environment in the presence of which a genetic risk factor can

exert its effect on nicotine dependence.²¹⁸

One of the challenges in this area is the need for optimal measurements of the environment so that proximal and distal risks can be enumerated, along with the documentation of age-specific and cumulative risk. Moffitt and colleagues²¹⁸ identify a strong need for improved retrospective measurement of environmental pathogens (see chapters 3 and 11 for further discussion of environmental pathogens and their measurement).

Evidence suggests that a portion of the smoking population smokes every day, has not previously attempted to quit, and has no desire or intention to quit. Prevalence estimates for this “hard-core” smoking range from 5% to 16% of the smoking population.^{219–221} Further characterization of hard-core smokers indicates several characteristics shown to have a genetic component (e.g., shorter time to first cigarette of the day, heavier smoking, concurrent use of other tobacco products, use of other abused substances, and comorbid depression). Given that hard-core smokers tend to be of lower socioeconomic status and are more likely to be unemployed and living alone, Warner and Burns²²² have speculated that these types of smokers may be living in a more stressful environment. Interestingly, stress reactivity has been shown to have both genetic^{223,224} and environmental²²⁵ components in its variation. This raises some interesting questions about the hard-core smoker that should be addressed in future research: (1) Is the prevalence of certain candidate gene variants higher or lower in hard-core smokers? (2) Does the relationship between specific candidate gene variants and hard-core smoking vary as a function of exposure to certain environmental risk factors? (3) Is the constellation of genetic and environmental risk factors different in hard-core smokers? (4) Are there subgroups within the hard-core smoker population that vary in genetic and environmental risk

factors? Genetic epidemiology investigations of this group of smokers may provide a wealth of information to inform future tobacco control efforts in hard-to-reach segments of the smoking population.

Could Environmental Variation Cause Variation in Expression of Genes of Relevance to Nicotine Dependence?

The evidence is compelling that environmental factors can result in the expression of genes in pathways of relevance to addiction in general. For example, exposure to stress modulates the expression of cocaine- and amphetamine-regulated transcript (*CART*) in the hypothalamus and amygdala in the rat brain in a region- and sex-specific manner. *CART* may, therefore, be a mediator peptide in the interaction between stress and drug abuse.²²⁶ In a series of studies, early maternal care was shown to have a profound impact on gene expression with long-lasting effects on the stress response.^{227,228} Chronic stress influences gene transcription in the hippocampus.²²⁹ Differential exposure to enriched or impoverished environments alters *N*-methyl-D-aspartate receptor subunit expression in the nucleus accumbens core and shell.²³⁰ Also, exposure to drugs of abuse (e.g., opiates) results in a discernible pattern of gene expression in the opioidergic and other pathways.^{231–233}

Epigenetics refers to heritable variation in biochemical modifications of both the nucleic acid and the protein components of chromatin—that is, the methylation of cytosine found in cytosine-guanine dinucleotides and posttranslational modification (methylation, acetylation and phosphorylation) of histone proteins, generally associated with decreased or increased levels of gene expression at the corresponding genetic locus.²³⁴ Multiple approaches to the analysis of epigenetic variation and its associations with genetic

and environmental variation and their association with disease are possible. One elegant design, however, uses monozygotic twins. These twins share 100% of their genome at the moment of twinning and accumulate differences thereafter with respect to DNA methylation, histone modification, and copy-number variation.^{235,236} Age, diet, gender, and environment have been associated with global epigenetic modification of the genome and both global and locus-specific DNA methylation appear to be heritable.^{236–239} While both genetic²⁴⁰ and epigenetic²³⁴ variation are associated with individual differences in gene expression, the discordant monozygotic twin design may be the most promising design to investigate epigenetic regulation of gene expression that might underlie differences in a phenotype of interest.²⁴¹

The study of discordant monozygotic twin gene expression or epigenetic differences is still in the early stages with respect to the numbers of studies, numbers of individuals, and design characteristics. A review of the literature reveals nine investigations of gene expression differences between discordant monozygotic twins that evaluate a panel of genes for gene expression differences to identify candidate genes potentially associated with the discordant phenotype,^{242–249} with the number of twin pairs evaluated in these studies ranging from 1 to 11. Five of these studies have used lymphoblastoid cell lines as the tissue source,^{242,243,245,249,250} two studies include analysis of dizygotic twin pairs or siblings in their gene expression analyses,^{243,248} and five studies used the Affymetrix gene expression array platform.^{244–246,249,250} Four studies confirmed specific results using individual candidate gene expression analysis in the discovery sample of RNA from the discordant monozygotic twins,^{245,248–250} and one study validated specific gene expression results in a second RNA sample derived from sporadic cases and controls.²⁴⁹

The use of monozygotic twins discordant for smoking history or nicotine pharmacokinetics for epigenetic studies to identify candidate genes influencing these traits represents a complementary approach to candidate gene and genome-wide association studies (GWAS). Candidate genes identified using these approaches can then be evaluated directly for specific epigenetic differences in genomic DNA from the discovery sample of discordant monozygotic twins and in genomic DNA from other individuals for association to the traits of interest. The availability of public epigenetic data and additional research into the prevalence and correlates of epigenetic modifications²⁵¹ will enable the data from such twin design epigenetic analyses to be placed within the population of genetic, environmental, and genomic and epigenomic contexts.

Summary of Selected Biometric and Measured Genetic Studies of Nicotine Dependence

The following studies are summarized below as examples of biometric and measured genetic studies of nicotine dependence. The reader will see a progression from completely biometric analyses of components of nicotine dependence (class II phenotypes),⁶⁵ biometric and measured genetic analyses combined (class IV phenotypes),²⁵² to measured genetics with a range of class I and II phenotypes,⁶⁶ and, finally, many measured genetic variants in relation to one class II phenotype.^{13,253} The studies are included as representative of the state of the science involving genetics and nicotine dependence. The reader will see, however, that none of the examples address issues raised in the present volume concerning theoretical and

measurement issues of nicotine dependence and, therefore, set a baseline from which future studies should progress.

Heritability of Components of Nicotine Dependence in Adults

A study in 2004 identified genetically informative nicotine-dependence criteria in a large community sample of adult (aged 24–36 years) Australian male and female twins.⁶⁵ The phenotypes under investigation were the seven *DSM-IV* nicotine-dependence criteria⁶³ and two FTND items (CPD and time to first cigarette in the morning) that together make up the HSI.¹³⁰ In the first step of the analysis, the phenotypic factor structure of the nine nicotine-dependence criteria in ever smokers resulted in two highly correlated factors for both women and men, with items related to smoking quantity loading on the first factor (*DSM-IV* nicotine tolerance and both HSI items), and *DSM-IV* items related to withdrawal and difficulty in quitting smoking loading on the second factor (withdrawal, smoking more than intended, difficulty in quitting smoking cigarettes, giving up important activities to smoke, and smoking despite physical or psychological problems caused by or exacerbated by smoking). Chain smoking, corresponding to the *DSM-IV* criterion of a great deal of time spent using the substance loads equally strongly on both factors and, in exploratory analysis, loaded highly on a third factor for both women and men, suggesting that this item does not correlate with endorsement of the remaining items. Internal consistency was high for both factors in women and men (Cronbach's alpha ranged from 0.78 to 0.79).

Factor analysis suggested similarity in the pattern of endorsement of nicotine-dependence criteria in women and men. Further, the weak factor loading of time to first cigarette in the morning on the factor for which withdrawal had a strong loading suggested that latency to first morning cigarette does not index nicotine withdrawal.

Finally, the *DSM-IV* criterion of giving up important social and occupational activities to smoke had the weakest correlation with the total factor score. Factor internal consistency improved without this item in both women and men. This result, together with this item being the least commonly endorsed, suggests that giving up activities to smoke may not be an important indicator of nicotine dependence in adults.

Genetic factor analysis of the same nine nicotine-dependence criteria resulted in two genetic factors and one shared environmental factor for both women and men. High item loadings were observed for all items on the first genetic factor with weaker loadings on the second genetic factor, suggesting that similar genetic factors contribute to interitem correlation. Factor loadings on the second genetic factor were opposite in sign in the women compared to the men, implying the influence of different genetic factors. Factor loadings on the shared environmental factor were low in women and moderate in men, and were opposite in sign between women and men, suggesting gender differences in the shared environmental factors that contribute to interitem correlation.

A study by Lessov and colleagues⁶⁵ also examined the relative contribution of genetic and environmental influences on variance to individual nicotine-dependence criteria and a nicotine-dependence diagnosis as defined by the *DSM-IV* and the HSI. The results showed substantial heritability for *DSM-IV* nicotine tolerance (73%), withdrawal (53%), smoking more than intended (62%), and both HSI items—time to first cigarette in the morning (68%) and number of CPD (70%). Relatively moderate heritability was observed for *DSM-IV* items: ever chain smoked (45%), smoking despite physical or psychological problems (39%), and giving up important activities to smoke (26%). There was no evidence for a significant contribution by shared environmental effects for any of these items and no gender differences.

One exception was the *DSM-IV* criterion of difficulty in quitting smoking, which was strongly heritable in women (68%), with no significant contribution for shared environment, and relatively more weakly heritable in men (54%), with significant contribution of shared environmental effects (26%). Nicotine dependence defined by *DSM-IV* criteria (i.e., endorsing three or more of seven items in the same 12-month period lifetime) was moderately heritable (56%); higher heritability was observed for HSI-defined dependence (71%). For both dependence definitions, there was no evidence for significant shared environmental effects or gender differences.

Taken together, the results from the Lessov and colleagues study⁶⁵ suggest that the *DSM-IV* criteria of giving up important activities to smoke and chain smoking (i.e., spending a lot of time using nicotine) may not be useful indicators of nicotine dependence for the purpose of genetic research. However, the *DSM-IV* criteria of tolerance, withdrawal, and difficulty in quitting smoking, and the two HSI items—time to first cigarette in the morning and CPD—may be the most salient genetic indicators of nicotine dependence in adults. The results also suggest that factor analytic approaches may identify highly genetically informative dependence phenotypes. Future work will examine the phenotypic and genetic factor structure of nicotine dependence in adolescents, which could be expected to be different from that of adults, considering differences in the importance of social and cultural pressures in relation to cigarette smoking.

Heritability of Nicotine Metabolism

The twin design has been used previously to investigate the genetic and environmental variance of the metabolism of a variety of substances including ethanol, lithium, and halothane (an anesthetic), but its

application to the study of nicotine metabolism did not begin until 2004. Although the body of evidence from the early twin studies shows substantial genetic involvement in drug metabolism, the extant literature has (1) examined relatively few pharmacokinetic indices of drug metabolism, (2) relied on very small samples of twins, (3) not used state-of-the-art techniques for quantification of the relative contribution of genetic and environmental influences, and (4) been unable to examine the impact of measured P450 genotype on estimates of broad heritability.

In a series of papers, the adaptability of the twin design to a variety of purposes was demonstrated.^{252,254–259} When combined with methodologies from molecular genetics, the design becomes highly informative with regard to the impact of measured genotype on estimates of heritability when the family nature of the data is used, as well as the impact of genotype on the metabolic phenotypes when the data are treated as coming from unrelated individuals.

Although certain genes for enzymes, such as *CYP2A6*, are clearly implicated in relevant pathways for nicotine metabolism,^{26,27,260} development of a complete understanding of all relevant candidate genes (e.g., *CYP2B6*²⁶¹ and *CYP2D6*^{262,263}) and their interactions in the pathways is still under way. For the purposes of the present example, the focus is only on that portion of the metabolic pathway that involves principally the action of *CYP2A6* in the conversion of nicotine to cotinine.²⁵² One hundred and thirty-nine twin pairs—110 monozygotic and 29 dizygotic—underwent a 30-minute infusion of stable-isotope-labeled nicotine and its major metabolite, cotinine, followed by an 8-hour in-hospital stay. Blood and urine samples were taken at regular intervals for analysis of nicotine, cotinine, and metabolites by gas chromatography–mass spectrometry or liquid chromatography–mass spectrometry and subsequent

characterization of pharmacokinetic and metabolism phenotypes. DNA was genotyped for zygosity and for variation in the gene for the primary enzyme involved in nicotine metabolism, *CYP2A6* (alleles tested: *1, *1/2, *2, *4, *7, *9, and *12).

Standard pharmacokinetic parameters were estimated from blood concentration data by using model-independent methods as described elsewhere.^{264,265} Univariate genetic analyses were used to quantify the relative contribution of genetic and environmental influences. All analyses were adjusted for age, current smoking, and oral contraceptive use in women.

Approximately 60% of the variability in clearance of nicotine, and clearance of nicotine via the cotinine pathway, was attributable to additive genetic effects. The estimate of additive genetic variation in the clearance of cotinine was smaller (33.3%). All three clearance parameters were significantly faster in the *CYP2A6* wild-type homozygous participants compared with those with at least one reduced metabolizing gene variant.

It was hypothesized that the estimate of additive genetic influence on measures of clearance would be reduced after adjusting for the effects of the *CYP2A6* genotype. The effect of measured *CYP2A6* genotype was tested by (1) including genotypic status (wild-type homozygotes or the presence of at least one reduced metabolizing variant) as a covariate in the genetic models and estimating the relative contribution of genetic and environmental effects to the residual phenotypic variance and (2) fitting models to metabolism data after excluding all individuals with at least one *CYP2A6* variant.

The inclusion of the *CYP2A6* genotype as a covariate in the biometric models did not significantly alter the estimate for additive genetic effects on the three measures of clearance. As hypothesized, point estimates

for the additive genetic effects decreased, but only to a small degree (e.g., decreases of 7.7%, 9.0%, and 7.4% for clearance of nicotine, clearance of cotinine, and clearance of nicotine, via the cotinine pathway, respectively). Similarly, exclusion of individuals with reduced metabolizing allele variants of *CYP2A6* resulted in best-fitting models with decreased but still significant heritability for the residual phenotypic variation in the clearance measures (e.g., decreases from point estimates for the sample as a whole of 8.8%, 26.4%, and 14.8% for clearance of nicotine, clearance of cotinine, and clearance of nicotine, via the cotinine pathway, respectively). These results suggest that, to the degree that twin variation in these nicotine clearance parameters is attributable to variation in *CYP2A6* allele status, the effect is small and that genetic influences in addition to variation in *CYP2A6* contribute to the heritability of nicotine and cotinine clearance (see chapter 12 for an analysis of nicotine metabolism involving multiple genes). The small association between the *CYP2A6* genotype and clearance measures, both at the phenotypic and genotypic levels, may partly explain why the relationship between the *CYP2A6* genotype and smoking behavior is inconsistent.^{51,52}

In addition, this study by Swan and colleagues²⁵² tested relatively few *CYP2A6* variants (i.e., those known or very likely to have an impact on the structure of the gene and resulting protein). New variants are appearing at a very rapid rate, and many are not yet characterized or numbered.²⁶⁶ The majority of these variants are in the 5' and 3' noncoding regions, which some studies have found to alter levels of transcription.

Linkage Analysis of FTND and Other Indices of Nicotine Dependence

The family study by Swan and others⁶⁶ sought to identify loci that segregate

with nicotine dependence as determined by the FTND. Additional measures were included to capture the complexity of the nicotine-dependence phenotype.⁶⁶ These included: (1) elements from the *DSM-IV* dependence criteria,⁶³ (2) smoking frequency and quantity, and (3) quitting history. Individuals who never tried even a puff of a cigarette were excluded from all definitions. Individuals who tried smoking, and those who smoked 100 or more cigarettes in their lifetime but were never daily smokers, are included in the zero category of *DSM-IV* measures. All other measures included lifetime daily smokers only.

For the FTND summary score, a maximum logarithm of odds (LOD) score of 2.7 was seen at 178 cM on chromosome 6 (figure 2.3). The marker closest to the peak was D6S446. The support interval (defined as the region in which LOD scores are within the value of one less than the maximum LOD score) included 156–191 cM (D6S1581–D6S281). In subsequent analyses, additional tobacco use phenotypes were examined for evidence of linkage. To minimize the reporting of results due to chance, individual LOD scores of 2.7 or greater only were reported. The support interval for withdrawal severity overlapped the FTND support interval on chromosome 6 (figure 2.3) with a peak LOD score of 2.7. Also shown in figure 2.3 is a quitting-history phenotype, short-term quit, that had a peak LOD score of 1.9 in the same region. The largest LOD score for any nicotine-dependence phenotype (LOD score = 3.0) was observed for *DSM-IV*-like nicotine-dependence severity near D7S636 (164 cM; support interval 159–167 cM; figure 2.4). For the dichotomous *DSM-IV*-like nicotine-dependence measure, a maximum LOD score of 2.7 was observed on chromosome 8 at 31 cM and 35 cM (near marker D8S258; figure 2.5).

Previous work has identified linkage peaks at or near the support interval reported

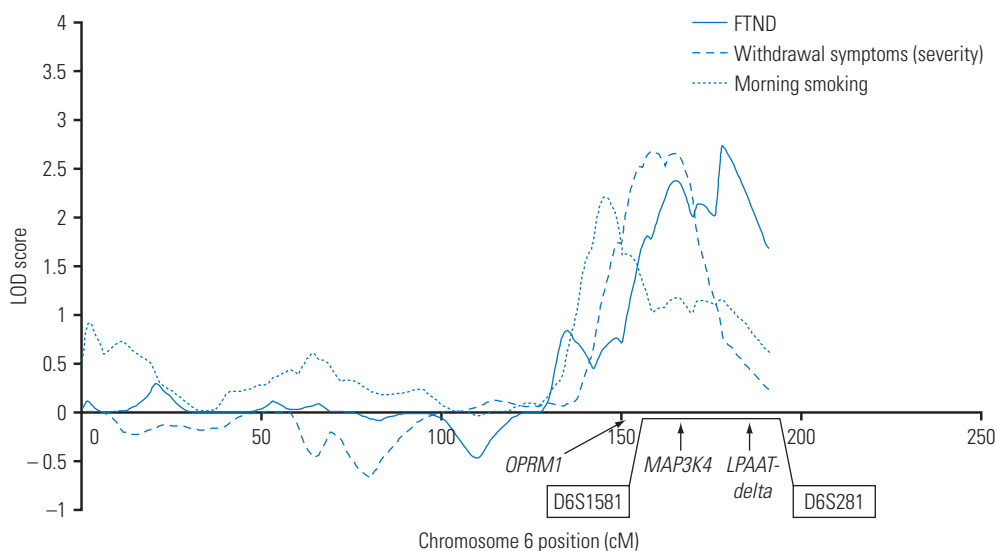
Figure 2.3 Multipoint Linkage Plot—Chromosome 6

Note. FTND = Fagerström Test for Nicotine Dependence; LOD = Logarithm of odds; cM = centimorgans; Bergen and colleagues²⁶⁷ (1999; ever smoke) and Sullivan and colleagues⁵⁵ (2004; Fagerström Tolerance Questionnaire) have peaks at beginning of support interval. From Swan, G. E., H. Hops, K. C. Wilhelmsen, C. N. Lessov-Schlaggar, L. S. Cheng, K. S. Hudmon, C. I. Amos, et al. 2006. A genome-wide screen for nicotine dependence susceptibility loci. *American Journal of Medical Genetics Part B, Neuropsychiatric Genetics* 141 (4): 354–60.

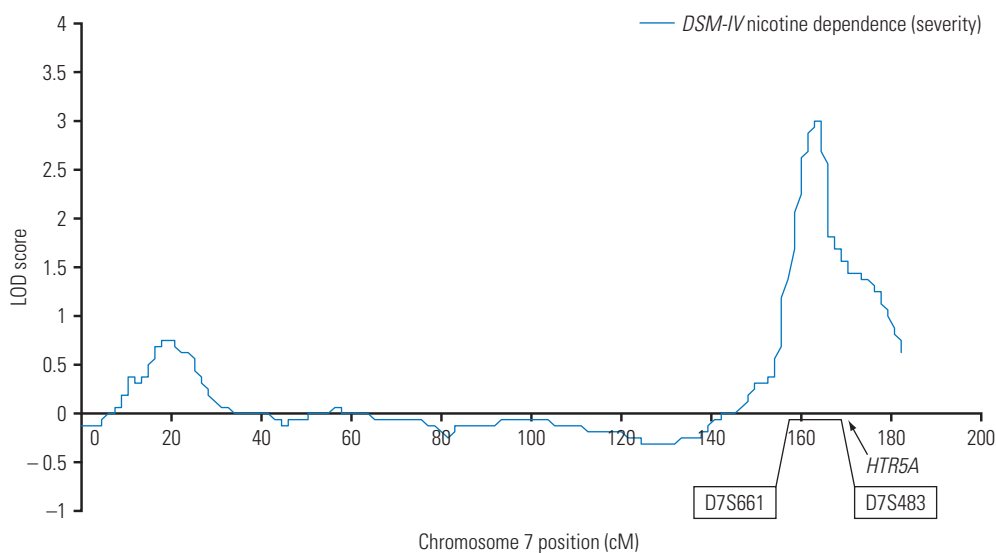
Figure 2.4 Multipoint Linkage Plot—Chromosome 7

Note. DSM-IV = *Diagnostic and Statistical Manual of Mental Disorders*, Fourth Edition; LOD = logarithm of odds; cM = centimorgans. Sullivan and colleagues⁵⁵ (2004; Fagerström Tolerance Questionnaire) have a peak near the start of the support interval. From Swan, G. E., H. Hops, K. C. Wilhelmsen, C. N. Lessov-Schlaggar, L. S. Cheng, K. S. Hudmon, C. I. Amos, et al. 2006. A genome-wide screen for nicotine dependence susceptibility loci. *American Journal of Medical Genetics Part B, Neuropsychiatric Genetics* 141 (4): 354–60.

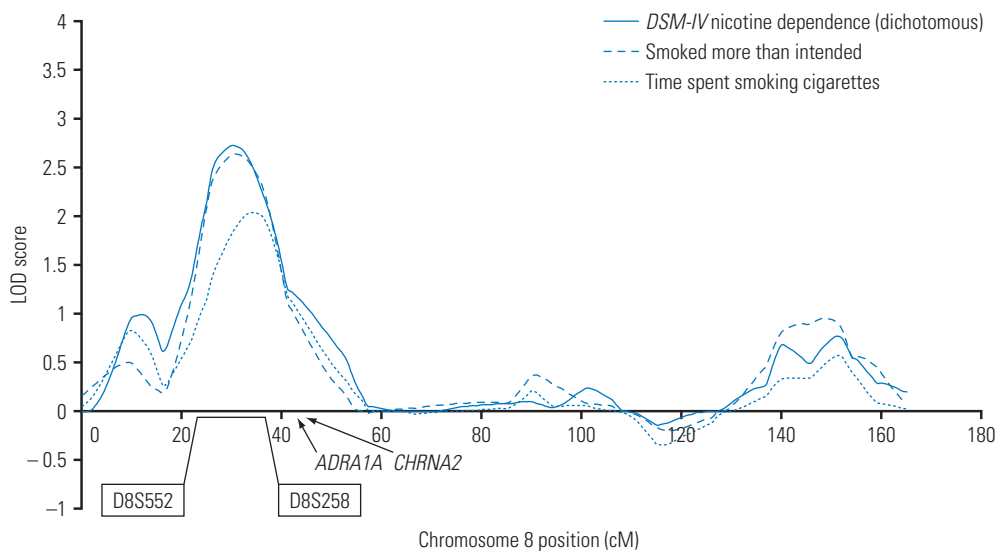
Figure 2.5 Multipoint Linkage Plot—Chromosome 8

Note. DSM-IV = *Diagnostic and Statistical Manual of Mental Disorders*, Fourth Edition; LOD = logarithm of odds; cM = centimorgans. Bergen et al.²⁶⁷ (1999; ever smoke) reported three significant peaks within support interval. From Swan, G. E., H. Hops, K. C. Wilhelmson, C. N. Llesov-Schlaggar, L. S. Cheng, K. S. Hudmon, C. I. Amos, et al. 2006. A genome-wide screen for nicotine dependence susceptibility loci. *American Journal of Medical Genetics Part B, Neuropsychiatric Genetics* 141 (4): 354–60.

here for FTND.^{55,267} Moreover, the support interval is very close to the *OPRM1* gene and contains *MAP3K4* and *LPAAT-delta*, both candidate genes for nicotine dependence.⁵⁵ It is encouraging that several loci reported here have been detected in other linkage studies as well. The support interval on chromosome 7 observed here for DSM-IV-like nicotine-dependence severity is near the linkage peak, D7S1804, reported previously for the FTQ,⁵⁵ and is near the candidate gene *HTR5A*. The support interval seen in the present study on chromosome 8 for DSM-IV-like nicotine dependence is near previously reported linkage peaks for the ever-smoking phenotype²⁶⁷ and is close to the candidate genes *CHRNA2* and *ADRA1A*. Whether the heterogeneity across chromosomes for indices of nicotine dependence derives from genetic or measurement sources cannot be determined from the present study and needs to be addressed in future research.

Genome-wide Association and Candidate Gene Studies of FTND

Smoking initiation occurs with the experimentation and use of cigarettes, often in adolescence. After smoking 100 or more cigarettes, a person passes the threshold to become a “smoker,” the term used in most health and population-based surveys. Various behaviors are seen among smokers, ranging from low-level cigarette use by “chippers” to heavy smoking by nicotine-dependent individuals who have difficulty quitting. Different factors contribute to the transition from one smoking level to the next, including genetic and environmental factors. Some of the risk and protective factors that play a role in smoking transitions include underlying biological predispositions (pharmacogenetic response to nicotine and nicotine metabolism), comorbid

disorders (alcohol dependence, major depressive disorder, and anxiety disorders), and environmental exposures (cigarette taxation, peer smoking, cigarette advertising, antitobacco programs, and parental smoking).

A GWAS, which involves scanning genetic variants across the genomes of many individuals, is among the newest and most powerful methods to uncover unique genes and pathways that contribute to a disorder. These large-scale genetic studies are now possible because of the rapid technological advancements in genetic research. To focus on the examination of genetic factors in the transition from smoking to the development of nicotine dependence, low-level smokers (defined as a lifetime FTND of zero) were compared to nicotine-dependent smokers (defined as having an FTND score of four or more) in a GWAS.¹³

Several novel genes were identified as potential contributors to the development of nicotine dependence in this GWAS, such as neurexin 1 (*NRXN1*), *TRPC7*, and others. The neurexin genes are expressed in neurons and are hypothesized to influence the balance of excitatory glutamatergic and inhibitory GABAergic synapses.²⁶⁸ Because substance dependence is modeled as a relative imbalance of excitatory and inhibitory neurotransmission, the neurexin genes are plausible new candidates that contribute to the neurobiology of dependence. An additional piece of evidence on the importance of the neurexin gene family comes from a pooled GWAS by Uhl and colleagues for polysubstance addiction, which identified *NRXN3*.²⁶⁹ A second gene of interest is *TRPC7*, which encodes a subunit of a multimeric calcium channel. In an animal model using *C. elegans*, genes in this family functionally regulated nicotine-induced neuronal activity.²⁷⁰ This animal model provides insight into the role this gene may play when nicotine is

ingested. Although these results require validation in independent samples, they represent some of the new leads that a GWAS can uncover.

In parallel with the GWAS, a second aim of this genetic project was to examine a comprehensive set of candidate genes to detect variants associated with nicotine dependence. Over 350 genes were genetically queried by using approximately 4,000 SNPs for genotyping. The genes for study included the nicotinic receptors as well as genes known to be involved in the neurobiological pathways that contribute to the development of dependence, such as dopamine and γ -aminobutyric acid (GABA) receptors. Genes were nominated by a skilled committee of investigators from the National Institute on Drug Abuse Genetics Consortium²⁷¹ with expertise in the study of nicotine and other substance dependence.

Genetic variants in the nicotinic receptors dominated the association results for nicotine dependence. Genetic association with the *CHRNA3-CHRNA6* nicotinic receptor locus on chromosome 8 was the most significant finding in the candidate gene study, and this cluster was also identified in the GWAS.^{13,253} Compelling findings were also seen in the group of SNPs in the *CHRNA5-CHRNA3-CHRNA4* cluster of nicotinic receptor genes on chromosome 15. Evidence shows at least two independent signals in this gene cluster. The first is a genetic variant that codes for a nonsynonymous coding SNP in the $\alpha 5$ nicotinic receptor subunit gene (**RS16969968*). There is evidence of at least one other independent signal in this gene cluster marked by **RS578776*. These results highlight the importance of the pharmacogenetic response to nicotine as a contributor to the development of nicotine dependence. Tables 2.1 and 2.2 summarize the results from each of the studies. The chromosome 15 findings from

2. Status of Genetic Studies of Nicotine Dependence

this study subsequently received support from analysis of independent data sets.^{272,273} Three studies have further implicated the same gene cluster in predisposition to lung cancer.^{274–276} Whether this effect is independent of an effect on smoking is controversial.²⁷⁷

In summary, these large-scale studies are a step in the process to identify genetic contributions to nicotine dependence.

They can, it is hoped, provide insights to understand the genetic contribution to nicotine dependence so that new approaches can be developed to reduce tobacco use, especially cigarette smoking. Although a substantial majority of smokers report that they want to quit (70%), and an estimated 41% try to quit in a given year, most smokers are not successful (although many are successful over time), and nicotine dependence is a strong predictor of failed

Table 2.1 Results from the Genome-wide Association Study of Nicotine Dependence

SNP	Gene	Chr	Pos(bp)	Risk Allele	Primary <i>p</i> -value	Male odds ratio (95% CI)	Female odds ratio (95% CI)
*RS4142041	CTNNA3	10	68,310,957	*G(0.41/0.34)	5.64E-06	1.7 (1.4–2.2)*	1.1 (1.0–1.4) ^a
*RS999 ^b	GPSM3, AGPAT1	6	32,261,864	*C(0.96/0.94)	1.42E-05	1.9 (1.1–3.5)	2.5 (1.6–4.0)
*RS12623467	NRXN1	2	51,136,740	*C(0.96/0.92)	1.48E-05	2.4 (1.5–3.9)	1.6 (1.1–2.3)
*RS12380218	VPS13A	9	77,165,214	*G(0.24/0.19)	2.09E-05	1.2 (0.9–1.6)	1.6 (1.3–1.9)
*RS2673931	TRPC7	5	135,717,335	*T(0.66/0.61)	3.89E-05	1.7 (1.3–2.1) ^a	1.0 (0.9–1.2) ^a
*RS2791480	CLCA1	1	86,680,605	*G(0.78/0.72)	4.38E-05	1.5 (1.2–2.0)	1.3 (1.1–1.6)
*RS10490162	NRXN1	2	51,159,308	*T(0.91/0.86)	5.66E-05	1.9 (1.3–2.8)	1.4 (1.1–1.8)
*RS13277254	CHRN3	8	42,669,139	*A(0.81/0.76)	6.54E-05	1.2 (0.9–1.6)	1.6 (1.3–1.9)
*RS10793832	FBXL17	5	107,348,129	*C(0.32/0.26)	8.13E-05	1.1 (0.9–1.4)	1.5 (1.2–1.8)
*RS2302673	FTO	16	52,625,622	*T(0.87/0.84)	8.85E-05	1.0 (0.8–1.4) ^a	1.8 (1.3–2.2) ^a

Note. SNP = single nucleotide polymorphism; Chr = chromosome; Pos(bp) = chromosomal position, base pairs; CI = confidence interval. Results for all SNPs are posted at <http://zork.wustl.edu/nida>. Adapted from Bierut, L. J., P. A. Madden, N. Breslau, E. O. Johnson, D. Hatsukami, O. F. Pomerleau, G. E. Swan, et al. 2007. Novel genes identified in a high-density genome wide association study for nicotine dependence. *Human Molecular Genetics* 16 (1): 24–35.

^aSignificantly different odds ratio for men and women.

^bThe allele frequency for *RS999 is quite different in these data than reported in the SNP database; this may represent a failure to accurately genotype this SNP in this study.

Table 2.2 Results from the Candidate Gene Study of Nicotine Dependence

SNP	Gene	Chr	Pos(bp)	Risk Allele	Primary <i>p</i> -value	Male odds ratio (95% CI)	Female odds ratio (95% CI)
*RS6474413	CHRN3	8	42,670,221	*T(0.81/0.76)	9.36E-05	1.2 (0.9–1.5)	1.5 (1.3–1.9)
*RS578776	CHRNA3	15	76,675,455	*G(0.78/0.72)	3.08E-04	1.5 (1.2–1.9)	1.3 (1.1–1.6)
*RS6517442	KCNJ6	21	38,211,816	*C(0.34/0.28)	5.62E-04	1.4 (1.1–1.7)	1.3 (1.1–1.5)
*RS16969968	CHRNA5	15	76,669,980	*A(0.38/0.32)	6.42E-04	1.3 (1.1–1.7)	1.3 (1.1–1.5)
*RS3762611	GABRA4	4	46,838,216	*G(0.93/0.91)	9.22E-04	2.1 (1.4–3.2)	1.3 (0.9–1.8)

Note. SNP = single nucleotide polymorphism; Chr = chromosome; Pos(bp) = chromosomal position, base pairs; CI = confidence interval. Results for all SNPs are posted at <http://zork.wustl.edu/nida>. Adapted from Saccone, S. F., A. L. Hinrichs, N. L. Saccone, G. A. Chase, K. Konvicka, P. A. Madden, N. Breslau, et al. 2007. Cholinergic nicotinic receptor genes implicated in a nicotine dependence association study targeting 348 candidate genes with 3713 SNPs. *Human Molecular Genetics* 16 (1): 36–49.

smoking cessation. This systematic survey of the genome nominates novel genes that increase an individual's risk of transitioning from smoking to nicotine dependence, and the candidate-gene study has provided persuasive evidence of the role of the nicotinic receptors in the transition from smoking to nicotine dependence. The continued genetic and biological characterization of these genes will help in understanding the underlying causality of nicotine dependence and may provide novel drug development targets for smoking cessation.

Issues in Communication of Genetic Findings

A full discussion of the ethical, legal, and social implications of this research is beyond the scope of this monograph. For a full discussion of these issues, see Caron and colleagues²⁷⁸ and Shields and colleagues.²⁷⁹ However, there are several important issues in the interpretation and communication of genetic findings that will be addressed here because: (1) unreplicated findings of gene–nicotine dependence associations could lead to erroneous conclusions based on false-positive results; (2) discrimination or stigma could accrue to individuals or groups identified as being at greater risk for nicotine dependence, especially if the prevalence of genetic risk factors varies as a function of ethnicity or of psychiatric comorbidity; and (3) available genetic tests for nicotine-dependence liability or treatment responsiveness are of questionable value at the individual level. While this portion of the chapter is not intended to be a comprehensive review of all the relevant issues, its purpose is to draw attention to the importance of understanding the broader implications of new research

findings and the need for further research and discussion in this area.

The Need to Replicate Gene–Nicotine Dependence Associations

As indicated earlier in this chapter, the bulk of the findings reporting associations between genetic variation and nicotine-dependence phenotypes has been derived from studies of single genes in relatively small samples. The effect sizes tend to be small, and the results have been notoriously difficult to replicate because of cross-study differences in sample ascertainment, population stratification, lack of consistency in SNP genotyping and phenotype definition, and failure to understand the role of linkage disequilibrium. This conclusion applies not only specifically to studies of nicotine dependence but more generally to studies of complex traits.

The advent of GWAS has the potential to alter the course of scientific progress in the field of nicotine dependence, as well as that of many other complex traits.²⁸⁰ Because it is now possible to study many SNPs (up to 1 million, using the Illumina platform) in multiple genes in relevant pathways, technological advances, if applied carefully, promise to encourage comprehensive investigation of genetic variation in relation to nicotine dependence and to do so in a much more rapid fashion. Concurrent with the application of this new technology are methodological developments centered on the best use of the GWAS approach. Best practices for SNP selection, phenotypic definition, incorporation of prior biological knowledge, multistage genotyping, proper handling of the multiple-comparison problem within the GWAS context, and the critical importance of replication are being proposed and incorporated into requirements for grant funding and publishing in top-tier

journals. Independent confirmation of the association between variation in the $\alpha 3$ and $\alpha 5$ gene cluster on chromosome 15, first reported by Saccone and colleagues,²⁵³ has now been reported by Bierut and colleagues²⁷³ and Berrettini and colleagues.²⁷²

As of April 2009, the GWAS approach has been successfully applied to two complex traits: age-related macular degeneration and type II diabetes,^{281,282} with many more applications of varying maturity being reported in the literature (including atherosclerosis and cancer, both reviewed in Kronenberg,²⁸³ brain aging and cognition;²⁸⁴ longevity,²⁸⁵ sleep and circadian phenotypes;²⁸⁶ and general cognitive ability²⁸⁷). It is clear that the GWAS approach will enjoy much popularity in the foreseeable future for the study of complex traits.

However, just as in the previous generation of single-gene, single-variant studies of nicotine dependence, investigators will need to apply with determination and vigilance the fundamental principles of good science and of interpreting results to the lay press and the public. Whereas previous headlines announced, “Gene for smoking identified,” the press, now with GWAS results in hand, might broadcast, “Multiple genes for smoking identified.” Unless the investigators involved are careful to point out the limitations of their findings and the associated effect sizes (which are destined to be modest with odds ratios of 1.5 or less), it is entirely likely that even more confusion will reign in the public mind as to the meaning of these results.

Discrimination or Stigma May Accrue to Individuals or Groups Identified as Being at Greater Risk for Nicotine Dependence

Several concerns have been raised regarding the potential for information about genetic risk for nicotine dependence or response

to smoking cessation treatment based on genotype to be used against individuals or groups in harmful ways.²⁸⁸ These concerns pose a barrier to physicians’ willingness to offer a new genetic test to tailor smoking treatment to their patients^{279,289,290} and to smokers’ willingness to undergo genetic testing to be matched to optimal treatment. Some of the primary critiques offered with respect to labeling individuals (especially youth) and groups are addressed below.

Might knowledge of one’s genetic status with respect to nicotine dependence be useful in deterring potential smokers from initiating smoking? Some might argue that informing adolescents that their genetic profile places them at greater risk of nicotine dependence may give them an incentive not to initiate smoking. However, evidence from other cases indicates that being identified as “at risk” is apt to have little effect on behavior. In the case of phenylketonuria (PKU), for example, dietary management is critical to maintaining phenylalanine levels to avoid developmental problems. In a U.K. study of PKU management, compliance with dietary restrictions to maintain phenylalanine levels among informed children decreased from 70% among children aged 10 to approximately 20% among children aged 15,²⁹¹ illustrating the limited ability of personalized feedback about risk to influence adolescents to change their behavior to maintain healthy habits. Thus, it is unclear what, if any, benefit such information might have for smoking prevention in practice.

Several additional risks associated with “labeling” adolescents as being susceptible to nicotine dependence have been identified.²⁹² Such labeling may result in a sense of fatalism among adolescents, leading to a perceived lack of ability to control their future, a higher willingness to smoke, and a resistance to considering public health messages about the risks of smoking.^{293–295} Youths identified as

at higher risk for nicotine dependence who already smoke may interpret this information as meaning that it is futile for them to try quitting. On the other hand, adolescents without a given genetic variant associated with increased risk of nicotine dependence may erroneously believe they can smoke and not become addicted. Thus, the provision of genetic information to adolescents could have significant positive or negative impact and psychological effects. More research is needed to understand adolescents' comprehension of the meaning of genetic risk for nicotine dependence and how this comprehension is likely to affect smoking behavior. The results of this research could then inform proactive public health messages that emphasize the health consequences from tobacco smoke that accrue regardless of genetic background and/or specify tailored methods to reduce chances for nicotine dependence.

Another area of intense debate concerns the framing of genetic information about risk of addiction or response to treatment in racial terms. Despite heated debates and numerous appeals for more careful use of racial categories in genetics research,²⁹⁶⁻³⁰⁰ many genetic studies continue to use self-identified racial variables in statistical analyses, resulting in research findings framed in "racial" terms. While it is essential to consider and control for population structure in genetic studies, using self-defined racial or ethnic categories as proxies for human genetic heterogeneity is less scientifically precise (more robust measures are available for assessing geographical ancestry) and fraught with potential for social harm.²⁹⁹ When research results are framed in racial terms, great harm can accrue to subpopulations identified as more likely to carry certain risk alleles, such as those that confer increased risk of addiction.

A well-documented example of the kind of stigma that can accrue to a particular

population is found in the early screening efforts for sickle cell hemoglobin among African Americans, which immediately resulted in considerable racial discrimination in both health insurance and employment contexts. This occurred despite the reality that a similarly high prevalence of the sickle cell trait was found in other subpopulations.^{294,301} At the same time, non-African-Americans, who were not socially viewed as being associated with sickle cell, often went undiagnosed until screening was implemented for all newborn infants.

Similarly, research results reporting that genotypes linked to nicotine dependence, cocaine, and other substances occur at a higher rate in African Americans than in European Americans holds the potential for exacerbating existing racial discrimination. Such research results are not received in a vacuum but are read in the context of social history and can lead to racism and marginalization of an entire portion of society, given the contentious history of racial stereotypes in the United States.³⁰¹ Studies have shown, for instance, that physicians already prescribe pain medication in smaller doses to African American patients than to European American patients with similar symptoms, reflecting a possible assumption that African Americans are more likely to become addicted to opiates.^{302,303} Because of the well-documented racial disparities in access to and quality of health care,³⁰⁴⁻³⁰⁹ investigators must seriously consider the unintended consequences of incorporating genetic information into risk assessment related to nicotine dependence.

The Association between Gene Variants, Nicotine Dependence, and Psychiatric Conditions May Also Result in Increased Risk for Stigmatization

As has been argued by Shields and colleagues, social sensitivity related to

2. Status of Genetic Studies of Nicotine Dependence

the pleiotropic associations of genetic variants implicated in nicotine dependence or response to treatment are intensified when they intersect with data on racial differences in the frequency of such risk alleles.²⁹⁹ One feature of the genetics of complex traits, such as smoking, that raises a host of social and ethical concerns is the pleiotropic associations of key genetic variants with many other traits. An early example of a pleiotropic genetic test is the test for apolipoprotein E, which simultaneously provides information on risk for cardiac disease and risk of developing late-onset Alzheimer's disease.^{310–312} Genes hypothesized to play a key role in increased risk of nicotine dependence also have been associated with increased risk of addiction to cocaine, alcohol,^{313,314} sexual activity,³¹⁵ compulsive gambling,³¹³ novelty seeking,^{316,317} and to other neuropsychiatric conditions. (Table 2.3 by Shields and colleagues,²⁹⁹ Billett and colleagues,³¹⁸ Comings and colleagues,^{319,320} Muglia and colleagues,³²¹ Nielsen and colleagues,³²²

and Rowe and colleagues.³²³) Many of these conditions and behaviors are very socially sensitive.^{324–329} Persons identified as having these genotypes may be stigmatized or discriminated against. One might assume that persons finding out they had a genetic profile of increased risk for nicotine dependence if they experimented with cigarettes might be deterred from initiating smoking. However, this profile could not be obtained without simultaneously generating information with other, more onerous implications. Similarly, it might be useful to tailor smoking cessation treatment to genotype to match patients to the treatment likely to work best for them (see below for a discussion of the evidence for the use of such tests), but such genetic testing would simultaneously generate additional information about a person's genetic risk for other addictions and psychiatric conditions. For these reasons, Shields and colleagues have argued that, in weighing the pros and cons associated with decisions regarding genetic testing to tailor smoking prevention

Table 2.3 Pleiotropic Associations of Genetic Variants Implicated in Smoking

Genetic Variants	Complex Traits			
	Tobacco Use	Addictive Behaviors	Psychiatric Conditions	Behavior Patterns
Dopamine Pathway				
<i>DRD1</i> (dopamine D1 receptor)	Smoking	Cocaine, Alcohol	Tourette's Syndrome	Gambling
<i>DRD2</i> (dopamine D2 receptor)	Smoking	Alcohol, Cocaine	ADHD, ^a PTSD ^b	Sexual Activity
<i>DRD4</i> (dopamine D4 receptor)	Smoking	Alcohol	ADHD, ^a OCD ^c	Novelty seeking
<i>SLC6A3</i> (dopamine transporter, DAT)	Smoking	Alcohol	Anxiety, Tourette's Syndrome	
<i>DBH</i> (dopamine beta-hydroxylase)	Smoking		Paranoia	
Serotonin Pathway				
<i>5HTTLPR</i> (serotonin transporter)	Smoking	Alcohol	Depression, Anxiety	
<i>TPH</i> (tryptophan hydroxylase)	Smoking	Alcohol	Suicide, Depression	Aggression

Note. Copyright © 2005 by the American Psychological Association. Adapted with permission. The official citation that should be used in referencing this material is, Shields, A. E., M. Fortun, E. M. Hammonds, P. A. King, C. Lerman, R. Rapp, and P. F. Sullivan. 2005. The use of race variables in genetic studies of complex traits and the goal of reducing health disparities: A transdisciplinary perspective. *American Psychologist* 60 (1): 77–103. The use of APA information does not imply endorsement by APA.

^aADHD = attention deficit hyperactivity disorder

^bPTSD = post traumatic stress disorder

^cOCD = obsessive compulsive disorder

and treatment strategies, decisions should be made based on the most potentially harmful uses of information generated by such testing.²⁸⁸

In what ways might these pleiotropic associations exacerbate concerns about identifying individuals at increased risk for nicotine dependence or raise new concerns? There have been cases of insurers increasing premiums or denying coverage to beneficiaries on the basis of genetic susceptibility tests for breast and ovarian cancer and for Alzheimer's disease.³³⁰ Smokers have long been charged higher health insurance premiums and identified as a socially stigmatized group.³³¹ In addition, the well-established adverse impact of smoking on employers' health care costs and worker productivity has led to instances in which employers have discriminated against smokers in hiring practice.³³² It is therefore not impossible to imagine that some employers might consider genetic testing as a screening tool in considering prospective employees. Such discrimination would likely be exacerbated when this genetic status is linked to an increased risk of alcohol or drug addiction, since this is a source of high health care costs.³³³ Such discrimination might be more likely to take place within self-insured firms, in particular, since they more directly manage and bear the costs of their employees' health care.³³⁴

The issue of harm to individuals from disclosure of genetic information is not new, and this issue has been addressed in many contexts.³³⁵⁻³³⁸ While some progress was made in protecting individuals against discrimination with the 1990 Americans with Disabilities Act (ADA)³³⁹ and Executive Order 13145, which prohibits discrimination against federal employees on the basis of genetic information,³⁴⁰ no comprehensive federal law bans genetic discrimination for the general population. State laws remain the primary source for protection

of genetic information. As of 2007, only 41 states banned genetic discrimination by health insurance companies, and only 32 states had passed laws that ban the misuse of genetic information by employers.³⁴¹ Greater federal protections are provided by the passage of the Genetic Information Nondiscrimination Act (GINA) of 2008.³⁴² On April 24, 2008, the Senate amended and passed GINA as H.R. 493. The House reconciled and agreed to the Senate bill on May 1, 2008.

Although GINA became law under President George W. Bush and addresses many concerns about discrimination and privacy, gaps remain in protection, including important omissions in consumer protections against employers discriminating against potential employees on the basis of genetic status.^{343,344} As Rothstein points out, GINA makes it unlawful for an employer to request, require, or purchase genetic information about an employee or applicant, yet section 102(d)(3) of the ADA still allows employers to require a signed authorization to release all of an individual's health record (including genetic information) after a conditional offer of employment.³⁴⁴ Moving forward, it will be essential to identify and close persisting gaps in protections to reassure patients who may benefit from genetic testing that information from such tests will not be used to discriminate against them in health insurance or employment. Failure to address these gaps will seriously undermine any future efforts to use genetic information to guide smoking prevention or treatment strategies.

The research involving genetics and nicotine dependence (and associated concerns) is occurring within the context of a much broader series of developments at the federal level, as described in the document, "Personalized Health Care: Opportunities, Pathways, Resources."³⁴⁵ The report identifies several future outcomes of personalized health care:

(1) prediction of individual susceptibility to disease, (2) provision of more useful and person-specific tools for preventing disease, (3) detection of the onset of disease at the earliest possible moment, (4) preemption of the progression of disease, and (5) targeting of medicines and dosages more precisely and safely to individual patients (p. 1). In addition, the report identifies the need to (1) make the individual patient's health information available on demand, (2) provide necessary support to clinicians when needed to use information concerning genetic and molecular factors, (3) bring large data sets together from real-world medical practices through secure networks to accelerate identification of best and safest practices, and (4) use data from data networks to understand differences in patients' responses to drugs and other therapies (p. 2).

The Value of Genetic Tests to Assess for Nicotine-Dependence Liability or Treatment Responsiveness Is Questionable

Despite the best efforts and intentions of the scientists involved in the work discussed in this monograph, vigilance and proactive planning are needed to minimize the risk of misunderstanding, misinterpreting, misusing, or otherwise abusing the results demonstrating associations between genetic factors and nicotine dependence.²⁷⁸ Documented examples exist of at least some instances of unintended consequences of this work. For example, a commercial company has been created to promote the sales of a genetic test (in this case, *DRD2*) that purports to predict the likelihood for success (smoking cessation) in response to certain pharmacological agents. Not only is there an inadequate knowledge base to support the widespread clinical use of this test, but also the cost-effectiveness of such a test has been called into question.^{346,347}

More generally, the rapidly developing field of direct-to-consumer marketing of genetic tests with little or no supporting evidence of their value at the individual level has generated a great deal of concern in the literature³⁴⁸ and calls for a regulatory framework to protect consumers from misleading claims made by commercial interests promoting these tests.³⁴⁹ Scientists in the field of genetics and nicotine dependence will need to stay informed regarding developments in this area of personalized medicine so that their work can be placed in the broader context of this emerging field.

The majority of scientists involved in the work described in this monograph are most interested in the implications of their work for understanding basic processes underlying nicotine dependence and, more generally, addiction. They are far less, if at all, interested in turning this work into for-profit, commercially available tests or products. Nevertheless, the ethical scientific community must be vigilant to quickly identify and challenge claims made about a test's predictive value for assigning smoking cessation treatments at the individual level. Similar concerns arise for claims that genetic variation can be used to predict whether a young child will become addicted to tobacco despite the fact that scientific work in this area has only just begun to explore this question.

Simply put, the work described in this monograph and in the field of genetics and nicotine dependence is in an early stage, and the body of available evidence is not sufficient to support any kind of predictive testing at the individual level. This may not be the case in other fields, such as the genetics of cancer, in which many decades have been spent by thousands of scientists to identify the genetic basis of cancer. By comparison, the field of genetics and nicotine dependence represents a tiny fraction of the total effort in the

field of cancer genetics, even though tobacco use remains an undisputed major risk factor for cancer. Evidence of a potential overlap between gene variants in the $\alpha 3$ – $\alpha 5$ nicotinic receptor cluster on chromosome 15, which are associated with nicotine dependence^{13,253,272} and with lung cancer,^{274–276} however, may cause the two fields to converge.

Summary

This chapter provides a framework for understanding nicotine-dependence phenotypes and an overview of major concepts, along with a summary of selected findings from the tobacco genetic literature. This chapter also raises important issues as to how genetic research is communicated and understood by the media and the public.

References

- Centers for Disease Control and Prevention. 2007. Fact sheet: Economic facts about U.S. tobacco use and tobacco production (updated April 2009). http://www.cdc.gov/tobacco/data_statistics/fact_sheets/economics/economic_facts.htm.
- Centers for Disease Control and Prevention. 2007. Cigarette smoking among adults—United States, 2006. *Morbidity and Mortality Weekly Report* 56 (44): 1157–61.
- Farrelly, M. C., T. F. Pechacek, K. Y. Thomas, and D. Nelson. 2008. The impact of tobacco control programs on adult smoking. *American Journal of Public Health* 98 (2): 304–9.
- World Health Organization. 2008. *WHO report on the global tobacco epidemic 2008: The MPOWER package*. Geneva: World Health Organization.
- Mathers, C. D., and D. Loncar. 2006. Projections of global mortality and burden of disease from 2002 to 2030. *PLoS Medicine* 3 (11): e442.
- MacKay, J., and M. Eriksen. 2002. *The Tobacco Atlas*. Geneva: World Health Organization.
- Ong, M. K., and S. A. Glantz. 2005. Free nicotine replacement therapy programs vs implementing smoke-free workplaces: A cost-effectiveness comparison. *American Journal of Public Health* 95 (6): 969–75.
- Federal Trade Commission. 2007. Federal Trade Commission cigarette report for 2004 and 2005. <http://www.ftc.gov/reports/tobacco/2007cigarette2004-2005.pdf> (accessed April 28, 2009).
- Pomerleau, O. F., A. C. Collins, S. Shiffman, and C. S. Pomerleau. 1993. Why some people smoke and others do not: New perspectives. *Journal of Consulting and Clinical Psychology* 61 (5): 723–31.
- Merikangas, K. R., and N. Risch. 2003. Genomic priorities and public health. *Science* 302 (5645): 599–601.
- Carlsten, C., and W. Burke. 2006. Potential for genetics to promote public health: Genetics research on smoking suggests caution about expectations. *JAMA: The Journal of the American Medical Association* 296 (20): 2480–82.
- Berrettini, W., L. Bierut, T. J. Crowley, J. F. Cubells, J. Frascella, J. Gelernter, J. K. Hewitt, et al. 2004. Setting priorities for genomic research. *Science* 304 (5676): 1445–47.
- Bierut, L. J., P. A. Madden, N. Breslau, E. O. Johnson, D. Hatsukami, O. F. Pomerleau, G. E. Swan, et al. 2007. Novel genes identified in a high-density genome wide association study for nicotine dependence. *Human Molecular Genetics* 16 (1): 24–35.
- Pomerleau, O. F., M. Burmeister, P. Madden, J. C. Long, G. E. Swan, and S. L. Kardia. 2007. Genetic research on complex behaviors: An examination of attempts to identify genes for smoking. *Nicotine & Tobacco Research* 9 (8): 883–901.
- Swan, G. E., K. S. Hudmon, L. M. Jack, K. Hemberger, D. Carmelli, T. V. Khroyan, H. Z. Ring, et al. 2003. Environmental and genetic determinants of tobacco use: Methodology for a multidisciplinary, longitudinal family-based investigation. *Cancer Epidemiology, Biomarkers & Prevention* 12 (10): 994–1005.
- Gilbert, D. G., and B. O. Gilbert. 1995. Personality, psychopathology, and nicotine response as mediators of the genetics of smoking. *Behavior Genetics* 25 (2): 133–47.
- Chassin, L., C. C. Presson, S. C. Pitts, and S. J. Sherman. 2000. The natural history of cigarette smoking from adolescence to adulthood in a midwestern community sample: Multiple trajectories and their psychosocial correlates. *Health Psychology* 19 (3): 223–31.
- Colder, C. R., P. D. Mehta, K. Balanda, R. T. Campbell, K. Mayhew, W. R. Stanton, M. Pentz, and B. R. Flay. 2001. Identifying trajectories of adolescent smoking: An application of latent growth mixture modeling. *Health Psychology* 20 (2): 127–35.
- White, H. R., R. J. Pandina, and P. H. Chen. 2002. Developmental trajectories of cigarette use from early adolescence into young adulthood. *Drug and Alcohol Dependence* 65 (2): 167–78.
- Lessov-Schlaggar, C. N., H. Hops, J. Brigham, K. S. Hudmon, J. A. Andrews, E. Tildesley, D. McBride, L. M. Jack, H. S. Javitz, and G. E. Swan. 2008. Adolescent smoking trajectories and nicotine dependence. *Nicotine & Tobacco Research* 10 (2): 341–51.
- Shadel, W. G., S. Shiffman, R. Niaura, M. Nichter, and D. B. Abrams. 2000. Current

- models of nicotine dependence: What is known and what is needed to advance understanding of tobacco etiology among youth. *Drug and Alcohol Dependence* 59 Suppl. 1: S9–S22.
22. Shiffman, S., A. Waters, and M. Hickcox. 2004. The Nicotine Dependence Syndrome Scale: A multidimensional measure of nicotine dependence. *Nicotine & Tobacco Research* 6 (2): 327–48.
 23. Hudmon, K. S., J. L. Marks, C. S. Pomerleau, D. M. Bolt, J. Brigham, and G. E. Swan. 2003. A multidimensional model for characterizing tobacco dependence. *Nicotine & Tobacco Research* 5 (5): 655–64.
 24. Andrews, J. A., E. Tildesley, H. Hops, and F. Li. 2002. The influence of peers on young adult substance use. *Health Psychology* 21 (4): 349–57.
 25. Benowitz, N. L. 1999. Nicotine addiction. *Primary Care* 26 (3): 611–31.
 26. Messina, E. S., R. F. Tyndale, and E. M. Sellers. 1997. A major role for CYP2A6 in nicotine C-oxidation by human liver microsomes. *Journal of Pharmacology and Experimental Therapeutics* 282 (3): 1608–14.
 27. Nakajima, M., T. Yamamoto, K. Nunoya, T. Yokoi, K. Nagashima, K. Inoue, Y. Funae, N. Shimada, T. Kamataki, and Y. Kuroiwa. 1996. Role of human cytochrome P4502A6 in C-oxidation of nicotine. *Drug Metabolism and Disposition* 24 (11): 1212–17.
 28. Audrain-McGovern, J., N. Al Koudsi, D. Rodriguez, E. P. Wileyto, P. G. Shields, and R. F. Tyndale. 2007. The role of CYP2A6 in the emergence of nicotine dependence in adolescents. *Pediatrics* 119 (1): e264–e274.
 29. O’Loughlin, J., G. Paradis, W. Kim, J. DiFranza, G. Meshfedjian, E. McMillan-Davey, S. Wong, J. Hanley, and R. F. Tyndale. 2004. Genetically decreased CYP2A6 and the risk of tobacco dependence: A prospective study of novice smokers. *Tobacco Control* 13 (4): 422–28.
 30. Corrigall, W. A. 1999. Nicotine self-administration in animals as a dependence model. *Nicotine & Tobacco Research* 1 (1): 11–20.
 31. Koob, G. F., and M. Le Moal. 1997. Drug abuse: Hedonic homeostatic dysregulation. *Science* 278 (5335): 52–58.
 32. Robinson, T. E., and K. C. Berridge. 1993. The neural basis of drug craving: An incentive-sensitization theory of addiction. *Brain Research: Brain Research Reviews* 18 (3): 247–91.
 33. Heath, A. C., and N. G. Martin. 1993. Genetic models for the natural history of smoking: Evidence for a genetic influence on smoking persistence. *Addictive Behaviors* 18 (1): 19–34.
 34. U.S. Department of Health and Human Services. 1994. *Preventing tobacco use among young people. A report of the Surgeon General*. Atlanta: U.S. Department of Health and Human Services, Public Health Service, Centers for Disease Control and Prevention, National Center for Chronic Disease Prevention and Health Promotion, Office on Smoking and Health. http://www.cdc.gov/tobacco/data_statistics/sgr/sgr_1994/index.htm.
 35. Dick, D. M., J. L. Pagan, R. Viken, S. Purcell, J. Kaprio, L. Pulkkinen, and R. J. Rose. 2007. Changing environmental influences on substance use across development. *Twin Research and Human Genetics* 10 (2): 315–26.
 36. Heath, C. W. 1958. Differences between smokers and nonsmokers. *Archives of Internal Medicine* 101 (2): 377–88.
 37. Lilienfeld, A. M. 1959. Emotional and other selected characteristics of cigarette smokers and non-smokers as related to epidemiological studies of lung cancer and other diseases. *Journal of the National Cancer Institute* 22 (2): 259–82.
 38. Fisher, R. A. 1958. Lung cancer and cigarettes. *Nature* 182 (4628): 108.
 39. Parascandola, M. 2004. Skepticism, statistical methods, and the cigarette: A historical analysis of a methodological debate. *Perspectives in Biology and Medicine* 47 (2): 244–61.
 40. U.S. Department of Health, Education, and Welfare. 1964. *Smoking and health: Report of the Advisory Committee to the Surgeon General of the Public Health Service* (PHS publication no. 1103). Washington, DC: U.S. Department of Health, Education, and Welfare, Public Health Service, Center for Disease Control. <http://profiles.nlm.nih.gov/NN/B/B/M/Q>.
 41. Glantz, S. A., J. Slade, L. A. Bero, P. Hanauer, and D. E. Barnes. 1996. *Cigarette papers*. Berkeley: Univ. of California Press.
 42. Goodman, L. S., and A. Gilman, eds. 1965. *The pharmacological basis of therapeutics*. 3rd ed. New York: Macmillan.

2. Status of Genetic Studies of Nicotine Dependence

43. Goldfarb, T. L., and M. E. Jarvik. 1972. Accommodation to restricted tobacco smoke intake in cigarette smokers. *International Journal of the Addictions* 7 (3): 559–65.
44. Russell, M. A., C. Wilson, U. A. Patel, P. V. Cole, and C. Feyerabend. 1973. Comparison of effect on tobacco consumption and carbon monoxide absorption of changing to high and low nicotine cigarettes. *British Medical Journal* 4 (5891): 512–16.
45. Jarvik, M. E., J. W. Cullen, E. R. Gritz, T. M. Vogt, and L. J. West, eds. 1978. *Research on smoking behavior* (NIDA Research Monograph No. 17, DHEW publication no. [ADM] 78-581). Rockville, MD: U.S. Department of Health, Education, and Welfare, Public Health Service, Alcohol, Drug Abuse, and Mental Health Administration, National Institute on Drug Abuse.
46. U.S. Department of Health, Education, and Welfare. 1979. *The health consequences of smoking: A report of the Surgeon General, 1977–1978* (DHEW publication no. [CDC] 79-50065). Washington, DC: U.S. Department of Health, Education, and Welfare, Public Health Service, Office of the Assistant Secretary for Health, Office on Smoking and Health. <http://profiles.nlm.nih.gov/NN/B/B/R/N>.
47. George, S. R., R. Cheng, T. Nguyen, Y. Israel, and B. F. O'Dowd. 1993. Polymorphisms of the D4 dopamine receptor alleles in chronic alcoholism. *Biochemical and Biophysical Research Communications* 196 (1): 107–14.
48. Noble, E. P., S. T. St Jeor, T. Ritchie, K. Syndulko, S. C. St Jeor, R. J. Fitch, R. L. Brunner, and R. S. Sparkes. 1994. D2 dopamine receptor gene and cigarette smoking: A reward gene? *Medical Hypotheses* 42 (4): 257–60.
49. Stapleton, J. A., G. Sutherland, and C. O'Gara. 2007. Association between dopamine transporter genotypes and smoking cessation: A meta-analysis. *Addiction Biology* 12 (2): 221–26.
50. Li, M. D., J. Z. Ma, and J. Beuten. 2004. Progress in searching for susceptibility loci and genes for smoking-related behaviour. *Clinical Genetics* 66 (5): 382–92.
51. Munafó, M. R., T. G. Clark, E. C. Johnstone, M. F. G. Murphy, and R. T. Walton. 2004. The genetic basis for smoking behavior: A systematic review and meta-analysis. *Nicotine & Tobacco Research* 6 (4): 583–98.
52. Carter, B., T. Long, and P. Cinciripini. 2004. A meta-analytic review of the CYP2A6 genotype and smoking behavior. *Nicotine & Tobacco Research* 6 (2): 221–27.
53. Fagerström, K. O. 1978. Measuring degree of physical dependence to tobacco smoking with reference to individualization of treatment. *Addictive Behaviors* 3 (3–4): 235–41.
54. Straub, R. E., P. F. Sullivan, Y. Ma, M. V. Myakishev, C. Harris-Kerr, B. Wormley, B. Kadambi, et al. 1999. Susceptibility genes for nicotine dependence: A genome scan and followup in an independent sample suggest that regions on chromosomes 2, 4, 10, 16, 17 and 18 merit further study. *Molecular Psychiatry* 4 (2): 129–44.
55. Sullivan, P. F., B. M. Neale, E. van den Oord, M. F. Miles, M. C. Neale, C. M. Bulik, P. R. Joyce, R. E. Straub, and K. S. Kendler. 2004. Candidate genes for nicotine dependence via linkage, epistasis, and bioinformatics. *American Journal of Medical Genetics Part B, Neuropsychiatric Genetics* 126 (1): 23–36.
56. Caspi, A., and T. E. Moffitt. 2006. Gene-environment interactions in psychiatry: Joining forces with neuroscience. *Nature Reviews Neuroscience* 7 (7): 583–90.
57. Moolchan, E. T., A. Radzins, D. H. Epstein, G. Uhl, D. A. Gorelick, J. L. Cadet, and J. E. Henningfield. 2002. The Fagerström Test for Nicotine Dependence and the Diagnostic Interview Schedule: Do they diagnose the same smokers? *Addictive Behaviors* 27 (1): 101–13.
58. Kandel, D., C. Schaffran, P. Griesler, J. Samuolis, M. Davies, and R. Galanti. 2005. On the measurement of nicotine dependence in adolescence: Comparisons of the mFTQ and a DSM-IV-based scale. *Journal of Pediatric Psychology* 30 (4): 319–32.
59. Lombardo, T. W., J. R. Hughes, and J. D. Fross. 1988. Failure to support the validity of the Fagerström Tolerance Questionnaire as a measure of physiological tolerance to nicotine. *Addictive Behaviors* 13 (1): 87–90.
60. Colby, S. M., S. T. Tiffany, S. Shiffman, and R. S. Niaura. 2000a. Measuring nicotine dependence among youth: A review of available approaches and instruments. *Drug and Alcohol Dependence* 59 Suppl. 1: S23–S39.
61. Hughes, J. R. 1985. Identification of the dependent smoker: Validity and clinical

- utility. *Behavioral Medicine Abstracts* 5: 202–204.
62. Heatherton, T. F., L. T. Kozlowski, R. C. Frecker, and K. O. Fagerström. 1991. The Fagerström Test for Nicotine Dependence: A revision of the Fagerström Tolerance Questionnaire. *British Journal of Addiction* 86 (9): 1119–27.
 63. American Psychiatric Association. 1994. *Diagnostic and statistical manual of mental disorders: DSM-IV*. 4th ed. Washington, DC: American Psychiatric Association.
 64. Robins, L. D., T. E. Helzer, L. Cottler, and E. Goldring. 1989. *NIMH diagnostic interview schedule, version III revised (DIS-III-R)*. St. Louis: Washington Univ.
 65. Lessov, C. N., N. G. Martin, D. J. Statham, A. A. Todorov, W. S. Slutske, K. K. Bucholz, A. C. Heath, and P. A. Madden. 2004. Defining nicotine dependence for genetic research: Evidence from Australian twins. *Psychological Medicine* 34 (5): 865–79.
 66. Swan, G. E., H. Hops, K. C. Wilhelmsen, C. N. Lessov-Schlaggar, L. S. Cheng, K. S. Hudmon, C. I. Amos, et al. 2006. A genome-wide screen for nicotine dependence susceptibility loci. *American Journal of Medical Genetics Part B, Neuropsychiatric Genetics* 141 (4): 354–60.
 67. Tate, J. C., and J. M. Schmitz. 1993. A proposed revision of the Fagerström Tolerance Questionnaire. *Addictive Behaviors* 18 (2): 135–43.
 68. Pomerleau, C. S., S. M. Carton, M. L. Lutzke, K. A. Flessland, and O. F. Pomerleau. 1994. Reliability of the Fagerström Tolerance Questionnaire and the Fagerström Test for Nicotine Dependence. *Addictive Behaviors* 19 (1): 33–39.
 69. Prokhorov, A. V., U. E. Pallonen, J. L. Fava, L. Ding, and R. Niaura. 1996. Measuring nicotine dependence among high-risk adolescent smokers. *Addictive Behaviors* 21 (1): 117–27.
 70. Etter, J. F., T. V. Duc, and T. V. Perneger. 1999. Validity of the Fagerström Test for Nicotine Dependence and of the Heaviness of Smoking Index among relatively light smokers. *Addiction* 94 (2): 269–81.
 71. Haddock, C. K., H. Lando, R. C. Klesges, G. W. Talcott, and E. A. Renaud. 1999. A study of the psychometric and predictive properties of the Fagerström Test for Nicotine Dependence in a population of young smokers. *Nicotine & Tobacco Research* 1 (1): 59–66.
 72. Etter, J. F., J. Le Houezec, and T. V. Perneger. 2003. A self-administered questionnaire to measure dependence on cigarettes: The cigarette dependence scale. *Neuropsychopharmacology* 28 (2): 359–70.
 73. Buckley, T. C., S. L. Mozley, D. R. Holohan, K. Walsh, J. C. Beckham, and J. D. Kassel. 2005. A psychometric evaluation of the Fagerström Test for Nicotine Dependence in PTSD smokers. *Addictive Behaviors* 30 (5): 1029–33.
 74. Vink, J. M., G. Willemsen, and D. I. Boomsma. 2005. Heritability of smoking initiation and nicotine dependence. *Behavior Genetics* 35 (4): 397–406.
 75. Rojas, N. L., J. D. Killen, K. F. Haydel, and T. N. Robinson. 1998. Nicotine dependence among adolescent smokers. *Archives of Pediatrics & Adolescent Medicine* 152 (2): 151–56.
 76. Kawakami, N., N. Takatsuka, S. Inaba, and H. Shimizu. 1999. Development of a screening questionnaire for tobacco/nicotine dependence according to ICD-10, DSM-III-R, and DSM-IV. *Addictive Behaviors* 24 (2): 155–66.
 77. DiFranza, J. R., J. A. Savageau, N. A. Rigotti, K. Fletcher, J. K. Ockene, A. D. McNeill, M. Coleman, and C. Wood. 2002. Development of symptoms of tobacco dependence in youths: 30 month follow up data from the DANDY study. *Tobacco Control* 11 (3): 228–35.
 78. DiFranza, J. R., J. A. Savageau, K. Fletcher, J. K. Ockene, N. A. Rigotti, A. D. McNeill, M. Coleman, and C. Wood. 2002. Measuring the loss of autonomy over nicotine use in adolescents: The DANDY (Development and Assessment of Nicotine Dependence in Youths) study. *Archives of Pediatrics & Adolescent Medicine* 156 (4): 397–403.
 79. O’Loughlin, J., J. DiFranza, J. Tarasuk, G. Meshefedjian, E. McMillan-Davey, G. Paradis, R. F. Tyndale, P. Clarke, and J. Hanley. 2002. Assessment of nicotine dependence symptoms in adolescents: A comparison of five indicators. *Tobacco Control* 11 (4): 354–60.
 80. O’Loughlin, J., J. Tarasuk, J. DiFranza, and G. Paradis. 2002. Reliability of selected measures of nicotine dependence among adolescents. *Annals of Epidemiology* 12 (5): 353–62.
 81. Grant, B. F., D. A. Dawson, F. S. Stinson, P. S. Chou, W. Kay, and R. Pickering. 2003. The Alcohol Use Disorder and

- Associated Disabilities Interview Schedule-IV (AUDADIS-IV): Reliability of alcohol consumption, tobacco use, family history of depression and psychiatric diagnostic modules in a general population sample. *Drug and Alcohol Dependence* 71 (1): 7–16.
82. Wheeler, K. C., K. E. Fletcher, R. J. Wellman, and J. R. DiFranza. 2004. Screening adolescents for nicotine dependence: The Hooked on Nicotine Checklist. *Adolescent Health* 35 (3): 225–30.
 83. Etter, J. F. 2005. A self-administered questionnaire to measure cigarette withdrawal symptoms: The Cigarette Withdrawal Scale. *Nicotine & Tobacco Research* 7 (1): 47–57.
 84. Lewis-Esquerre, J. M., S. M. Colby, T. O. Tevyaw, C. A. Eaton, C. W. Kahler, and P. M. Monti. 2005. Validation of the timeline follow-back in the assessment of adolescent smoking. *Drug and Alcohol Dependence* 79 (1): 33–43.
 85. Hudmon, K. S., C. S. Pomerleau, J. Brigham, H. Javitz, and G. E. Swan. 2005. Validity of retrospective assessments of nicotine dependence: A preliminary report. *Addictive Behaviors* 30 (3): 613–37.
 86. Stallings, M. C., J. K. Hewitt, T. Beresford, A. C. Heath, and L. J. Eaves. 1999. A twin study of drinking and smoking onset and latencies from first use to regular use. *Behavior Genetics* 29 (6): 409–21.
 87. Boms, U., K. Silventoinen, P. A. Madden, A. C. Heath, and J. Kaprio. 2006. Genetic architecture of smoking behavior: A study of Finnish adult twins. *Twin Research and Human Genetics* 9 (1): 64–72.
 88. True, W. R., H. Xian, J. F. Scherrer, P. A. Madden, K. K. Bucholz, A. C. Heath, S. A. Eisen, M. J. Lyons, J. Goldberg, and M. Tsuang. 1999. Common genetic vulnerability for nicotine and alcohol dependence in men. *Archives of General Psychiatry* 56 (7): 655–61.
 89. Pergadia, M. L., A. C. Heath, N. G. Martin, and P. A. Madden. 2006. Genetic analyses of DSM-IV nicotine withdrawal in adult twins. *Psychological Medicine* 36 (7): 963–72.
 90. Kesmodel, U., and S. F. Olsen. 1999. Smoking habits among pregnant Danish women: Reliability of information recorded after delivery. *Journal of Epidemiology and Community Health* 53 (4): 239–42.
 91. Eppel, A., J. O'Loughlin, G. Paradis, and R. Platt. 2006. Reliability of self-reports of cigarette use in novice smokers. *Addictive Behaviors* 31 (9): 1700–704.
 92. Pomerleau, O. F. 1995. Individual differences in sensitivity to nicotine: Implications for genetic research on nicotine dependence. *Behavior Genetics* 25 (2): 161–77.
 93. Eissenberg, T., and R. L. Balster. 2000. Initial tobacco use episodes in children and adolescents: Current knowledge, future directions. *Drug and Alcohol Dependence* 59 Suppl. 1: S41–S60.
 94. Brigham, J., C. N. Lessov-Schlaggar, H. S. Javitz, M. McElroy, R. Krasnow, and G. E. Swan. 2008. Reliability of adult retrospective recall of lifetime tobacco use. *Nicotine & Tobacco Research* 10 (2): 287–99.
 95. Swan, G. E. 1999. Implications of genetic epidemiology for the prevention of tobacco use. *Nicotine & Tobacco Research* 1 Suppl. 1: S49–S56.
 96. Hiatt, R. A., and B. K. Rimer. 1999. A new strategy for cancer control research. *Cancer Epidemiology, Biomarkers & Prevention* 8 (11): 957–64.
 97. Petraitis, J., B. R. Flay, and T. Q. Miller. 1995. Reviewing theories of adolescent substance use: Organizing pieces in the puzzle. *Psychological Bulletin* 117 (1): 67–86.
 98. Kendler, K. S., M. C. Neale, P. Sullivan, L. A. Corey, C. O. Gardner, and C. A. Prescott. 1999. A population-based twin study in women of smoking initiation and nicotine dependence. *Psychological Medicine* 29 (2): 299–308.
 99. Gottesman, I. I., and J. Shields. 1972. *Schizophrenia and genetics: A twin study vantage point*. New York: Academic Press.
 100. Gottesman, I. I., and J. Shields. 1973. Genetic theorizing and schizophrenia. *British Journal of Psychiatry* 122 (566): 15–30.
 101. Gelernter, J. 1997. Genetic association studies in psychiatry: Recent history. In *Handbook of psychiatric genetics*, ed. K. Blum and E. P. Noble, 25–36. Boca Raton, FL: CRC Press.
 102. Kendler, K. S. 1999. Preparing for gene discovery: A further agenda for psychiatry. *Archives of General Psychiatry* 56 (6): 554–55.
 103. Gottesman, I. I., and T. D. Gould. 2003. The endophenotype concept in psychiatry: Etymology and strategic intentions.

- American Journal of Psychiatry* 160 (4): 636–45.
104. Gould, T. D., and I. I. Gottesman. 2006. Psychiatric endophenotypes and the development of valid animal models. *Genes, Brain, and Behavior* 5 (2): 113–19.
 105. Waldman, I. D. 2005. Statistical approaches to complex phenotypes: Evaluating neuropsychological endophenotypes for attention-deficit/hyperactivity disorder. *Biological Psychiatry* 57 (11): 1347–56.
 106. Berrettini, W. H. 2005. Genetic bases for endophenotypes in psychiatric disorders. *Dialogues in Clinical Neuroscience* 7 (2): 95–101.
 107. Crosbie, J., D. Perusse, C. L. Barr, and R. J. Schachar. 2008. Validating psychiatric endophenotypes: Inhibitory control and attention deficit hyperactivity disorder. *Neuroscience and Biobehavioral Reviews* 32 (1): 40–55.
 108. Flint, J., and M. R. Munafó. 2007. The endophenotype concept in psychiatric genetics. *Psychological Medicine* 37 (2): 163–80.
 109. Kaprio, J., M. Koskenvuo, and S. Sarna. 1981. Cigarette smoking, use of alcohol, and leisure-time physical activity among same-sexed adult male twins. *Progress in Clinical and Biological Research* 69 Pt. C: 37–46.
 110. Swan, G. E., D. Carmelli, R. H. Rosenman, R. R. Fabsitz, and J. C. Christian. 1990. Smoking and alcohol consumption in adult male twins: Genetic heritability and shared environmental influences. *Journal of Substance Abuse* 2 (1): 39–50.
 111. Swan, G. E., D. Carmelli, and L. R. Cardon. 1996. The consumption of tobacco, alcohol, and coffee in Caucasian male twins: A multivariate genetic analysis. *Journal of Substance Abuse* 8 (1): 19–31.
 112. Hettaema, J. M., L. A. Corey, and K. S. Kendler. 1999. A multivariate genetic analysis of the use of tobacco, alcohol, and caffeine in a population based sample of male and female twins. *Drug and Alcohol Dependence* 57 (1): 69–78.
 113. Koopmans, J. R., W. S. Slutske, A. C. Heath, M. C. Neale, and D. I. Boomsma. 1999. The genetics of smoking initiation and quantity smoked in Dutch adolescent and young adult twins. *Behavior Genetics* 29 (6): 383–93.
 114. Swan, G. E., D. Carmelli, and L. R. Cardon. 1997. Heavy consumption of cigarettes, alcohol and coffee in male twins. *Journal of Studies on Alcohol* 58 (2): 182–90.
 115. Pergadia, M. L., A. C. Heath, A. Agrawal, K. K. Bucholz, N. G. Martin, and P. A. Madden. 2006. The implications of simultaneous smoking initiation for inferences about the genetics of smoking behavior from twin data. *Behavior Genetics* 36 (4): 567–76.
 116. Kaprio, J., M. Koskenvuo, and H. Langinvainio. 1984. Finnish twins reared apart. IV: Smoking and drinking habits. A preliminary analysis of the effect of heredity and environment. *Acta Geneticae Medicae et Gemellologiae (Roma)* 33 (3): 425–33.
 117. True, W. R., A. C. Heath, J. F. Scherrer, B. Waterman, J. Goldberg, N. Lin, S. A. Eisen, M. J. Lyons, and M. T. Tsuang. 1997. Genetic and environmental contributions to smoking. *Addiction* 92 (10): 1277–87.
 118. Kendler, K. S., L. M. Thornton, and N. L. Pedersen. 2000. Tobacco consumption in Swedish twins reared apart and reared together. *Archives of General Psychiatry* 57 (9): 886–92.
 119. Agrawal, A., P. A. Madden, A. C. Heath, M. T. Lynskey, K. K. Bucholz, and N. G. Martin. 2005. Correlates of regular cigarette smoking in a population-based sample of Australian twins. *Addiction* 100 (11): 1709–19.
 120. Madden, P. A., A. C. Heath, N. L. Pedersen, J. Kaprio, M. J. Koskenvuo, and N. G. Martin. 1999. The genetics of smoking persistence in men and women: A multicultural study. *Behavior Genetics* 29 (6): 423–31.
 121. Madden, P. A., N. L. Pedersen, J. Kaprio, M. J. Koskenvuo, and N. G. Martin. 2004. The epidemiology and genetics of smoking initiation and persistence: Crosscultural comparisons of twin study results. *Twin Research* 7 (1): 82–97.
 122. Maes, H. H., C. E. Woodard, L. Murrelle, J. M. Meyer, J. L. Silberg, J. K. Hewitt, M. Rutter, et al. 1999. Tobacco, alcohol and drug use in eight- to sixteen-year-old twins: The Virginia Twin Study of Adolescent Behavioral Development. *Journal of Studies on Alcohol* 60 (3): 293–305.
 123. Hamilton, A. S., C. N. Lessov-Schlaggar, M. G. Cockburn, J. B. Unger, W. Cozen, and T. M. Mack. 2006. Gender differences in determinants of smoking initiation and persistence in California twins. *Cancer Epidemiology, Biomarkers, & Prevention* 15 (6): 1189–97.

124. Boomsma, D. I., J. R. Koopmans, L. J. Van Doornen, and J. F. Orlebeke. 1994. Genetic and social influences on starting to smoke: A study of Dutch adolescent twins and their parents. *Addiction* 89 (2): 219–26.
125. Han, C., M. K. McGue, and W. G. Iacono. 1999. Lifetime tobacco, alcohol and other substance use in adolescent Minnesota twins: Univariate and multivariate behavioral genetic analyses. *Addiction* 94 (7): 981–93.
126. Heath, A. C., R. Cates, N. G. Martin, J. Meyer, J. K. Hewitt, M. C. Neale, and L. J. Eaves. 1993. Genetic contribution to risk of smoking initiation: Comparisons across birth cohorts and across cultures. *Journal of Substance Abuse* 5 (3): 221–46.
127. Maes, H. H., P. F. Sullivan, C. M. Bulik, M. C. Neale, C. A. Prescott, L. J. Eaves, and K. S. Kendler. 2004. A twin study of genetic and environmental influences on tobacco initiation, regular tobacco use and nicotine dependence. *Psychological Medicine* 34 (7): 1251–61.
128. McGue, M., I. Elkins, and W. G. Iacono. 2000. Genetic and environmental influences on adolescent substance use and abuse. *American Journal of Medical Genetics* 96 (5): 671–77.
129. American Psychiatric Association. 1987. *Diagnostic and statistical manual of mental disorders: DSM-III-R*. 3rd rev. ed. Washington, DC: American Psychiatric Association.
130. Heatherton, T. F., L. T. Kozlowski, R. C. Frecker, W. Rickert, and J. Robinson. 1989. Measuring the heaviness of smoking: Using self-reported time to the first cigarette of the day and number of cigarettes smoked per day. *British Journal of Addiction* 84 (7): 791–99.
131. Xian, H., J. F. Scherrer, P. A. Madden, M. J. Lyons, M. Tsuang, W. R. True, and S. A. Eisen. 2005. Latent class typology of nicotine withdrawal: Genetic contributions and association with failed smoking cessation and psychiatric disorders. *Psychological Medicine* 35 (3): 409–19.
132. Pianezza, M. L., E. M. Sellers, and R. F. Tyndale. 1998. Nicotine metabolism defect reduces smoking. *Nature* 393 (6687): 750.
133. Gerra, G., L. Garofano, A. Zaimovic, G. Moi, B. Branchi, M. Bussandri, F. Brambilla, and C. Donnini. 2005. Association of the serotonin transporter promoter polymorphism with smoking behavior among adolescents. *American Journal of Medical Genetics Part B, Neuropsychiatric Genetics* 135 (1): 73–78.
134. Laucht, M., K. Becker, M. El-Faddagh, E. Hohm, and M. H. Schmidt. 2005. Association of the DRD4 exon III polymorphism with smoking in fifteen-year-olds: A mediating role for novelty seeking? *Journal of the American Academy of Child & Adolescent Psychiatry* 44 (5): 477–84.
135. Ling, D., T. Niu, Y. Feng, H. Xing, and X. Xu. 2004. Association between polymorphism of the dopamine transporter gene and early smoking onset: An interaction risk on nicotine dependence. *Journal of Human Genetics* 49 (1): 35–39.
136. Bierut, L. J., J. P. Rice, H. J. Edenberg, A. Goate, T. Foroud, C. R. Cloninger, H. Begleiter, et al. 2000. Family-based study of the association of the dopamine D2 receptor gene (DRD2) with habitual smoking. *American Journal of Medical Genetics* 90 (4): 299–302.
137. Comings, D. E., L. Ferry, S. Bradshaw-Robinson, R. Burchette, C. Chiu, and D. Muhleman. 1996. The dopamine D2 receptor (DRD2) gene: A genetic risk factor in smoking. *Pharmacogenetics* 6 (1): 73–79.
138. Lerman, C., N. Caporaso, D. Main, J. Audrain, N. R. Boyd, E. D. Bowman, and P. G. Shields. 1998. Depression and self-medication with nicotine: The modifying influence of the dopamine D4 receptor gene. *Health Psychology* 17 (1): 56–62.
139. Lerman, C., N. E. Caporaso, J. Audrain, D. Main, E. D. Bowman, B. Lockshin, N. R. Boyd, and P. G. Shields. 1999. Evidence suggesting the role of specific genetic factors in cigarette smoking. *Health Psychology* 18 (1): 14–20.
140. Sabol, S. Z., M. L. Nelson, C. Fisher, L. Gunzerath, C. L. Brody, S. Hu, L. A. Sirota, et al. 1999. A genetic association for cigarette smoking behavior. *Health Psychology* 18 (1): 7–13.
141. Shields, P. G., C. Lerman, J. Audrain, E. D. Bowman, D. Main, N. R. Boyd, and N. E. Caporaso. 1998. Dopamine D4 receptors and the risk of cigarette smoking in African-Americans and Caucasians. *Cancer Epidemiology, Biomarkers & Prevention* 7 (6): 453–58.
142. Greenbaum, L., K. Kanyas, O. Karni, Y. Merbl, T. Olender, A. Horowitz, A. Yakir, D. Lancet, E. Ben-Asher, and B. Lerer. 2006.

- Why do young women smoke? I: Direct and interactive effects of environment, psychological characteristics and nicotinic cholinergic receptor genes. *Molecular Psychiatry* 11 (3): 312–22.
143. Boustead, C., H. Taber, J. R. Idle, and S. Cholerton. 1997. CYP2D6 genotype and smoking behaviour in cigarette smokers. *Pharmacogenetics* 7 (5): 411–14.
144. Arias, A., R. Feinn, and H. R. Kranzler. 2006. Association of an Asn40Asp (A118G) polymorphism in the mu-opioid receptor gene with substance dependence: A meta-analysis. *Drug and Alcohol Dependence* 83 (3): 262–68.
145. Cholerton, S., C. Boustead, H. Taber, A. Arpanahi, and J. R. Idle. 1996. CYP2D6 genotypes in cigarette smokers and non-tobacco users. *Pharmacogenetics* 6 (3): 261–63.
146. Connor, J. P., R. M. Young, B. R. Lawford, J. B. Saunders, T. L. Ritchie, and E. P. Noble. 2007. Heavy nicotine and alcohol use in alcohol dependence is associated with D2 dopamine receptor (DRD2) polymorphism. *Addictive Behaviors* 32 (2): 310–19.
147. do Prado-Lima, P. A., J. M. Chatkin, M. Taufer, G. Oliveira, E. Silveira, C. A. Neto, F. Haggstram, L. C. Bodanese, and I. B. da Cruz. 2004. Polymorphism of 5HT2A serotonin receptor gene is implicated in smoking addiction. *American Journal of Medical Genetics Part B, Neuropsychiatric Genetics* 128 (1): 90–93.
148. Jin, Y., D. Chen, Y. Hu, S. Guo, H. Sun, A. Lu, X. Zhang, and L. Li. 2006. Association between monoamine oxidase gene polymorphisms and smoking behaviour in Chinese males. *International Journal of Neuropsychopharmacology* 9 (5): 557–64.
149. Rodriguez, S., S. Huang, X. H. Chen, T. R. Gaunt, H. E. Syddall, J. A. Gilg, G. J. Miller, et al. 2006. A study of TH01 and IGF2-INS-TH haplotypes in relation to smoking initiation in three independent surveys. *Pharmacogenetics and Genomics* 16 (1): 15–23.
150. Schoedel, K. A., E. B. Hoffmann, Y. Rao, E. M. Sellers, and R. F. Tyndale. 2004. Ethnic variation in CYP2A6 and association of genetically slow nicotine metabolism and smoking in adult Caucasians. *Pharmacogenetics* 14 (9): 615–26.
151. Schwab, S. G., P. E. Franke, B. Hoefgen, V. Guttenthaler, D. Lichtermann, M. Trixler, M. Knapp, W. Maier, and D. B. Wildenauer. 2005. Association of DNA polymorphisms in the synaptic vesicular amine transporter gene (SLC18A2) with alcohol and nicotine dependence. *Neuropsychopharmacology* 30 (12): 2263–68.
152. Wiesbeck, G. A., N. Wodarz, H. G. Weijers, K. M. Dursteler-MacFarland, F. M. Wurst, M. Walter, and J. Boening. 2006. A functional polymorphism in the promoter region of the monoamine oxidase A gene is associated with the cigarette smoking quantity in alcohol-dependent heavy smokers. *Neuropsychobiology* 53 (4): 181–85.
153. Anney, R. J., C. A. Olsson, M. Lotfi-Miri, G. C. Patton, and R. Williamson. 2004. Nicotine dependence in a prospective population-based study of adolescents: The protective role of a functional tyrosine hydroxylase polymorphism. *Pharmacogenetics* 14 (2): 73–81.
154. Olsson, C., R. Anney, S. Forrest, G. Patton, C. Coffey, T. Cameron, A. Hassett, and R. Williamson. 2004. Association between dependent smoking and a polymorphism in the tyrosine hydroxylase gene in a prospective population-based study of adolescent health. *Behavior Genetics* 34 (1): 85–91.
155. Feng, Y., T. Niu, H. Xing, X. Xu, C. Chen, S. Peng, L. Wang, N. Laird, and X. Xu. 2004. A common haplotype of the nicotine acetylcholine receptor alpha 4 subunit gene is associated with vulnerability to nicotine addiction in men. *American Journal of Human Genetics* 75 (1): 112–21.
156. Li, M. D., J. Beuten, J. Z. Ma, T. J. Payne, X. Y. Lou, V. Garcia, A. S. Duenes, K. M. Crews, and R. C. Elston. 2005. Ethnic- and gender-specific association of the nicotinic acetylcholine receptor alpha4 subunit gene (CHRNA4) with nicotine dependence. *Human Molecular Genetics* 14 (9): 1211–19.
157. Zhang, L., K. S. Kendler, and X. Chen. 2006. Association of the phosphatase and tensin homolog gene (PTEN) with smoking initiation and nicotine dependence. *American Journal of Medical Genetics Part B, Neuropsychiatric Genetics* 141 (1): 10–14.
158. Beuten, J., J. Z. Ma, T. J. Payne, R. T. Dupont, K. M. Crews, G. Somes, N. J. Williams, R. C. Elston, and M. D. Li. 2005. Single- and multilocus allelic variants within the GABA(B) receptor subunit 2 (GABAB2) gene are significantly associated with nicotine dependence. *American Journal of Human Genetics* 76 (5): 859–64.

2. Status of Genetic Studies of Nicotine Dependence

159. Beuten, J., T. J. Payne, J. Z. Ma, and M. D. Li. 2006. Significant association of catechol-O-methyltransferase (COMT) haplotypes with nicotine dependence in male and female smokers of two ethnic populations. *Neuropsychopharmacology* 31 (3): 675–84.
160. Chen, X., B. Wu, and K. S. Kendler. 2004. Association study of the Epac gene and tobacco smoking and nicotine dependence. *American Journal of Medical Genetics Part B, Neuropsychiatric Genetics* 129 (1): 116–19.
161. Howard, L. A., J. S. Ahluwalia, S. K. Lin, E. M. Sellers, and R. F. Tyndale. 2003. CYP2E1*1D regulatory polymorphism: Association with alcohol and nicotine dependence. *Pharmacogenetics* 13 (6): 321–28.
162. Ito, H., N. Hamajima, K. Matsuo, K. Okuma, S. Sato, R. Ueda, and K. Tajima. 2003. Monoamine oxidase polymorphisms and smoking behaviour in Japanese. *Pharmacogenetics* 13 (2): 73–79.
163. Kubota, T., C. Nakajima-Taniguchi, T. Fukuda, M. Funamoto, M. Maeda, E. Tange, R. Ueki, et al. 2006. CYP2A6 polymorphisms are associated with nicotine dependence and influence withdrawal symptoms in smoking cessation. *Pharmacogenomics Journal* 6 (2): 115–19.
164. Lou, X. Y., J. Z. Ma, T. J. Payne, J. Beuten, K. M. Crew, and M. D. Li. 2006. Gene-based analysis suggests association of the nicotinic acetylcholine receptor beta1 subunit (CHRNB1) and M1 muscarinic acetylcholine receptor (CHRM1) with vulnerability for nicotine dependence. *Human Genetics* 120 (3): 381–9.
165. Ma, J. Z., J. Beuten, T. J. Payne, R. T. Dupont, R. C. Elston, and M. D. Li. 2005. Haplotype analysis indicates an association between the DOPA decarboxylase (DDC) gene and nicotine dependence. *Human Molecular Genetics* 14 (12): 1691–98.
166. Reuter, M., and J. Hennig. 2005. Pleiotropic effect of the TPH A779C polymorphism on nicotine dependence and personality. *American Journal of Medical Genetics Part B, Neuropsychiatric Genetics* 134 (1): 20–24.
167. Yu, Y., C. Panhuysen, H. R. Kranzler, V. Hesselbrock, B. Rounsaville, R. Weiss, K. Brady, L. A. Farrer, and J. Gelernter. 2006. Intronic variants in the dopa decarboxylase (DDC) gene are associated with smoking behavior in European-Americans and African-Americans. *Human Molecular Genetics* 15 (14): 2192–99.
168. Ray, R., C. Jepson, F. Patterson, A. Strasser, M. Rukstalis, K. Perkins, K. G. Lynch, S. O'Malley, W. H. Berrettini, and C. Lerman. 2006. Association of OPRM1 A118G variant with the relative reinforcing value of nicotine. *Psychopharmacology (Berl)* 188 (3): 355–63.
169. Lander, E. S., and N. J. Schork. 1994. Genetic dissection of complex traits. *Science* 265 (5181): 2037–48.
170. Ottman, R. 1990. An epidemiologic approach to gene-environment interaction. *Genetic Epidemiology* 7 (3): 177–85.
171. Ottman, R. 1995. Gene-environment interaction and public health. *American Journal of Human Genetics* 56 (4): 821–23.
172. Ottman, R. 1996. Gene-environment interaction: Definitions and study designs. *Preventive Medicine* 25 (6): 764–70.
173. Zhang, L., K. S. Kendler, and X. Chen. 2006. The mu-opioid receptor gene and smoking initiation and nicotine dependence. *Behavioral and Brain Functions* 2: 28.
174. Neville, M. J., E. C. Johnstone, and R. T. Walton. 2004. Identification and characterization of ANKK1: A novel kinase gene closely linked to DRD2 on chromosome band 11q23.1. *Human Mutation* 23 (6): 540–45.
175. Huang, S., D. G. Cook, L. J. Hinks, X. H. Chen, S. Ye, J. A. Gilg, M. J. Jarvis, P. H. Whincup, and I. N. Day. 2005. CYP2A6, MAOA, DBH, DRD4, and 5HT2A genotypes, smoking behaviour and cotinine levels in 1518 UK adolescents. *Pharmacogenetics and Genomics* 15 (12): 839–50.
176. Takimoto, T., H. Terayama, C. Waga, T. Okayama, K. Ikeda, I. Fukunishi, and K. Iwahashi. 2005. Cholecystokinin (CCK) and the CCKA receptor gene polymorphism, and smoking behavior. *Psychiatry Research* 133 (2–3): 123–28.
177. Beuten, J., J. Z. Ma, T. J. Payne, R. T. Dupont, P. Quezada, K. M. Crews, and M. D. Li. 2005. Significant association of BDNF haplotypes in European-American male smokers but not in European-American female or African-American smokers. *American Journal of Medical Genetics Part B, Neuropsychiatric Genetics* 139: 73–80.
178. Costa-Mallen, P., L. G. Costa, and H. Checkoway. 2005. Genotype combinations for monoamine oxidase-B intron 13

- polymorphism and dopamine D2 receptor TaqIB polymorphism are associated with ever-smoking status among men. *Neuroscience Letters* 385 (2): 158–62.
179. Park, H. J., S. T. Kim, D. H. Yoon, S. H. Jin, S. J. Lee, H. J. Lee, and S. Lim. 2005. The association between the DRD2 TaqI A polymorphism and smoking cessation in response to acupuncture in Koreans. *Journal of Alternative and Complementary Medicine* 11 (3): 401–405.
180. Swan, G. E., A. M. Valdes, H. Z. Ring, T. V. Khroyan, L. M. Jack, C. C. Ton, S. J. Curry, and T. McAfee. 2005. Dopamine receptor DRD2 genotype and smoking cessation outcome following treatment with bupropion SR. *Pharmacogenomics Journal* 5 (1): 21–29.
181. Erbllich, J., C. Lerman, D. W. Self, G. A. Diaz, and D. H. Bovbjerg. 2005. Effects of dopamine D2 receptor (DRD2) and transporter (SLC6A3) polymorphisms on smoking cue-induced cigarette craving among African-American smokers. *Molecular Psychiatry* 10 (4): 407–14.
182. Glatt, S. J., and E. G. Jonsson. 2006. The Cys allele of the DRD2 Ser311Cys polymorphism has a dominant effect on risk for schizophrenia: Evidence from fixed- and random-effects meta-analyses. *American Journal of Medical Genetics Part B, Neuropsychiatric Genetics* 141 (2): 149–54.
183. Hanninen, K., H. Katila, O. Kampman, S. Anttila, A. Illi, R. Rontu, K. M. Mattila, et al. 2006. Association between the C957T polymorphism of the dopamine D2 receptor gene and schizophrenia. *Neuroscience Letters* 407 (3): 195–98.
184. Kukreti, R., S. Tripathi, P. Bhatnagar, S. Gupta, C. Chauhan, S. Kubendran, Y. C. Janardhan Reddy, S. Jain, and S. K. Brahmachari. 2006. Association of DRD2 gene variant with schizophrenia. *Neuroscience Letters* 392 (1–2): 68–71.
185. Berggren, U., C. Fahlke, E. Aronsson, A. Karanti, M. Eriksson, K. Blennow, D. Thelle, H. Zetterberg, and J. Balldin. 2006. The taqI DRD2 A1 allele is associated with alcohol-dependence although its effect size is small. *Alcohol and Alcoholism* 41 (5): 479–85.
186. Wang, T. J., S. Y. Huang, W. W. Lin, H. Y. Lo, P. L. Wu, Y. S. Wang, Y. S. Wu, H. C. Ko, J. C. Shih, and R. B. Lu. 2007. Possible interaction between MAOA and DRD2 genes associated with antisocial alcoholism among Han Chinese men in Taiwan. *Progress in Neuro-Psychopharmacology & Biological Psychiatry* 31 (1): 108–14.
187. Hopfer, C. J., D. Timberlake, B. Haberstick, J. M. Lessem, M. A. Ehringer, A. Smolen, and J. K. Hewitt. 2005. Genetic influences on quantity of alcohol consumed by adolescents and young adults. *Drug and Alcohol Dependence* 78 (2): 187–93.
188. Denys, D., F. Van Nieuwerburgh, D. Deforce, and H. Westenberg. 2006. Association between the dopamine D2 receptor TaqI A2 allele and low activity COMT allele with obsessive-compulsive disorder in males. *European Neuropsychopharmacology* 16 (6): 446–50.
189. Li, D., P. C. Sham, M. J. Owen, and L. He. 2006. Meta-analysis shows significant association between dopamine system genes and attention deficit hyperactivity disorder (ADHD). *Human Molecular Genetics* 15 (14): 2276–84.
190. Sery, O., I. Drtilkova, P. Theiner, R. Pitelova, R. Staif, V. Znojil, J. Lochman, and W. Didden. 2006. Polymorphism of DRD2 gene and ADHD. *Neuro Endocrinology Letters* 27 (1-2): 236–40.
191. Li, Y., C. Shao, D. Zhang, M. Zhao, L. Lin, P. Yan, Y. Xie, K. Jiang, and L. Jin. 2006. The effect of dopamine D2, D5 receptor and transporter (SLC6A3) polymorphisms on the cue-elicited heroin craving in Chinese. *American Journal of Medical Genetics Part B, Neuropsychiatric Genetics* 141 (3): 269–73.
192. Lawford, B. R., R. Young, E. P. Noble, B. Kann, and T. Ritchie. 2006. The D2 dopamine receptor (DRD2) gene is associated with co-morbid depression, anxiety and social dysfunction in untreated veterans with post-traumatic stress disorder. *European Psychiatry* 21 (3): 180–85.
193. Rybakowski, J. K., A. Borkowska, P. M. Czerski, P. Kapelski, M. Dmitrzak-Weglaz, and J. Hauser. 2005. An association study of dopamine receptors polymorphisms and the Wisconsin Card Sorting Test in schizophrenia. *Journal of Neural Transmission* 112 (11): 1575–82.
194. Lee, C. C., I. C. Chou, C. H. Tsai, T. R. Wang, T. C. Li, and F. J. Tsai. 2005. Dopamine receptor D2 gene polymorphisms are associated in Taiwanese children with Tourette syndrome. *Pediatric Neurology* 33 (4): 272–76.

195. Bergen, A. W., M. Yeager, R. A. Welch, K. Haque, J. K. Ganjei, M. B. van den Bree, C. Mazzanti, et al. 2005. Association of multiple DRD2 polymorphisms with anorexia nervosa. *Neuropsychopharmacology* 30 (9): 1703–10.
196. Wacker, J., M. Reuter, J. Hennig, and G. Stemmler. 2005. Sexually dimorphic link between dopamine D2 receptor gene and neuroticism-anxiety. *Neuroreport* 16 (6): 611–14.
197. Shahmoradgoli Najafabadi, M., M. Ohadi, M. T. Joghataie, F. Valaie, Y. Riazalhosseini, H. Mostafavi, F. Mohammadbeigi, and H. Najmabadi. 2005. Association between the DRD2 A1 allele and opium addiction in the Iranian population. *American Journal of Medical Genetics Part B, Neuropsychiatric Genetics* 134 (1): 39–41.
198. Lerman, C., P. G. Shields, E. P. Wileyto, J. Audrain, L. H. Hawk Jr., A. Pinto, S. Kucharski, S. Krishnan, R. Niaura, and L. H. Epstein. 2003. Effects of dopamine transporter and receptor polymorphisms on smoking cessation in a bupropion clinical trial. *Health Psychology* 22 (5): 541–48.
199. Swan, G. E., L. M. Jack, A. M. Valdez, H. Z. Ring, C. C. Ton, S. J. Curry, and T. McAfee. 2007. Joint effect of dopaminergic genes on likelihood of smoking following treatment with bupropion SR. *Health Psychology* 26 (3): 361–68.
200. Caspi, A., K. Sugden, T. E. Moffitt, A. Taylor, I. W. Craig, H. Harrington, J. McClay, et al. 2003. Influence of life stress on depression: Moderation by a polymorphism in the 5-HTT gene. *Science* 301 (5631): 386–89.
201. Kendler, K. S., J. W. Kuhn, J. Vittum, C. A. Prescott, and B. Riley. 2005. The interaction of stressful life events and a serotonin transporter polymorphism in the prediction of episodes of major depression: A replication. *Archives of General Psychiatry* 62 (5): 529–35.
202. Purcell, S. 2002. Variance components models for gene-environment interaction in twin analysis. *Twin Research* 5 (6): 554–71.
203. Purcell, S., and K. C. Koenen. 2005. Environmental mediation and the twin design. *Behavior Genetics* 35 (4): 491–98.
204. Purcell, S., and P. Sham. 2002. Variance components models for gene-environment interaction in quantitative trait locus linkage analysis. *Twin Research and Human Genetics* 5 (6): 572–76.
205. Button, T. M., J. Scourfield, N. Martin, S. Purcell, and P. McGuffin. 2005. Family dysfunction interacts with genes in the causation of antisocial symptoms. *Behavior Genetics* 35 (2): 115–20.
206. McCaffery, J. M., G. P. Papandonatos, M. J. Lyons, K. Koenen, B. Hitsman, and R. Niaura. 2005. Education level moderates the heritability of nicotine dependence in Vietnam-era twins. Paper presented at the 11th annual meeting of the Society for Research on Nicotine and Tobacco, Prague.
207. Lerman, C., R. Tyndale, F. Patterson, E. P. Wileyto, P. G. Shields, A. Pinto, and N. Benowitz. 2006. Nicotine metabolite ratio predicts efficacy of transdermal nicotine for smoking cessation. *Clinical Pharmacology and Therapeutics* 79 (6): 600–608.
208. Malaiyandi, V., C. Lerman, N. L. Benowitz, C. Jepson, F. Patterson, and R. F. Tyndale. 2006. Impact of CYP2A6 genotype on pretreatment smoking behaviour and nicotine levels from and usage of nicotine replacement therapy. *Molecular Psychiatry* 11 (4): 400–409.
209. Benowitz, N. L., O. F. Pomerleau, C. S. Pomerleau, and P. Jacob 3rd. 2003. Nicotine metabolite ratio as a predictor of cigarette consumption. *Nicotine & Tobacco Research* 5 (5): 621–24.
210. Johnstone, E., N. Benowitz, A. Cargill, R. Jacob, L. Hinks, I. Day, M. Murphy, and R. Walton. 2006. Determinants of the rate of nicotine metabolism and effects on smoking behavior. *Clinical Pharmacology and Therapeutics* 80 (4): 319–30.
211. Kandel, D. B., M. C. Hu, C. Schaffran, J. R. Udry, and N. L. Benowitz. 2007. Urine nicotine metabolites and smoking behavior in a multiracial/multiethnic national sample of young adults. *American Journal of Epidemiology* 165 (8): 901–10.
212. Bierut, L. J., J. F. Cubells, W. G. Iacono, M. D. Li, P. A. Madden, E. C. Nelson, J. D. Pollock, J. L. Rutter, G. E. Swan, and M. Vanyukov. 2007. Genetic research and smoking behavior. *JAMA: The Journal of the American Medical Association* 297 (8): 809; author reply 810.
213. Khoury, M. J., R. Davis, M. Gwinn, M. L. Lindegren, and P. Yoon. 2005. Do we need genomic research for the prevention of common diseases with environmental causes? *American Journal of Epidemiology* 161 (9): 799–805.

214. Vanyukov, M. M., B. S. Maher, B. Devlin, G. P. Kirillova, L. Kirisci, L. M. Yu, and R. E. Ferrell. 2007. The MAOA promoter polymorphism, disruptive behavior disorders, and early onset substance use disorder: Gene-environment interaction. *Psychiatric Genetics* 17 (6): 323–32.
215. Caspi, A., J. McClay, T. E. Moffitt, J. Mill, J. Martin, I. W. Craig, A. Taylor, and R. Poulton. 2002. Role of genotype in the cycle of violence in maltreated children. *Science* 297 (5582): 851–54.
216. Dobzhansky, T. G. 1951. *Genetics and the origin of species*. 3rd ed. rev. New York: Columbia University Press.
217. U.S. Department of Health and Human Services. 1988. *The health consequences of smoking: Nicotine addiction. A report of the Surgeon General* (DHHS publication no. [CDC] 88-8406). Atlanta: U.S. Department of Health and Human Services, Public Health Service, Centers for Disease Control, National Center for Chronic Disease Prevention and Health Promotion, Office on Smoking and Health. <http://profiles.nlm.nih.gov/NN/B/B/Z/D>.
218. Moffitt, T. E., A. Caspi, and M. Rutter. 2005. Strategy for investigating interactions between measured genes and measured environments. *Archives of General Psychiatry* 62 (5): 473–81.
219. Emery, S., E. A. Gilpin, C. Ake, A. J. Farkas, and J. P. Pierce. 2000. Characterizing and identifying “hard-core” smokers: Implications for further reducing smoking prevalence. *American Journal of Public Health* 90 (3): 387–94.
220. Augustson, E. M., and S. E. Marcus. 2004. Use of the Current Population Survey to characterize sub-populations of continued smokers: A national perspective on the “hardcore” smoker phenomenon. *Nicotine & Tobacco Research* 6 (4): 621–29.
221. Jarvis, M. J., J. Wardle, J. Waller, and L. Owen. 2003. Prevalence of hardcore smoking in England, and associated attitudes and beliefs: Cross sectional study. *British Medical Journal* 326 (11): 1061–66.
222. Warner, K. E., and D. M. Burns. 2003. Hardening and the hard-core smoker: Concepts, evidence, and implications. *Nicotine & Tobacco Research* 5 (1): 37–48.
223. Falzone, T. L., D. M. Gelman, J. I. Young, D. K. Grandy, M. J. Low, and M. Rubinstein. 2002. Absence of dopamine D4 receptors results in enhanced reactivity to unconditioned, but not conditioned, fear. *European Journal of Neuroscience* 15 (1): 158–64.
224. Ouagazzal, A. M., J. L. Moreau, M. Pauly-Evers, and F. Jenck. 2003. Impact of environmental housing conditions on the emotional responses of mice deficient for nociceptin/orphanin FQ peptide precursor gene. *Behavioural Brain Research* 144 (1–2): 111–17.
225. Ijzerman, R. G., C. D. Stehouwer, E. J. de Geus, M. M. van Weissenbruch, H. A. Delemarre-van de Waal, and D. I. Boomsma. 2003. Low birth weight is associated with increased sympathetic activity: Dependence on genetic factors. *Circulation* 108 (5): 566–71.
226. Koylu, E. O., B. Balkan, M. J. Kuhar, and S. Pogun. 2006. Cocaine and amphetamine regulated transcript (CART) and the stress response. *Peptides* 27 (8): 1956–69.
227. Meaney, M. J., and M. Szyf. 2005. Maternal care as a model for experience-dependent chromatin plasticity? *Trends in Neurosciences* 28 (9): 456–63.
228. Zhang, T. Y., P. Chretien, M. J. Meaney, and A. Gratton. 2005. Influence of naturally occurring variations in maternal care on prepulse inhibition of acoustic startle and the medial prefrontal cortical dopamine response to stress in adult rats. *Journal of Neuroscience* 25 (6): 1493–1502.
229. Alfonso, J., A. C. Frasch, and G. Flugge. 2005. Chronic stress, depression and antidepressants: Effects on gene transcription in the hippocampus. *Reviews in the Neurosciences* 16 (1): 43–56.
230. Wood, D. A., J. E. Buse, C. L. Wellman, and G. V. Rebec. 2005. Differential environmental exposure alters NMDA but not AMPA receptor subunit expression in nucleus accumbens core and shell. *Brain Research* 1042 (2): 176–83.
231. Ammon-Treiber, S., and V. Holtt. 2005. Morphine-induced changes of gene expression in the brain. *Addiction Biology* 10 (1): 81–89.
232. Rhodes, J. S., and J. C. Crabbe. 2005. Gene expression induced by drugs of abuse. *Current Opinion in Pharmacology* 5 (1): 26–33.
233. Mayer, P., and V. Holtt. 2006. Pharmacogenetics of opioid receptors and addiction. *Pharmacogenetics and Genomics* 16 (1): 1–7.

234. Feinberg, A. P. 2008. Epigenetics at the epicenter of modern medicine. *JAMA: The Journal of the American Medical Association* 299 (11): 1345–50.
235. Bruder, C. E., A. Piotrowski, A. A. Gijbbers, R. Andersson, S. Erickson, T. D. de Stahl, U. Menzel, et al. 2008. Phenotypically concordant and discordant monozygotic twins display different DNA copy-number-variation profiles. *American Journal of Human Genetics* 82 (3): 763–71.
236. Fraga, M. F., E. Ballestar, M. F. Paz, S. Ropero, F. Setien, M. L. Ballestar, D. Heine-Suner, et al. 2005. Epigenetic differences arise during the lifetime of monozygotic twins. *Proceedings of the National Academy of Sciences of the United States of America* 102 (30): 10604–9.
237. Heijmans, B. T., D. Kremer, E. W. Tobin, D. I. Boomsma, and P. E. Slagboom. 2007. Heritable rather than age-related environmental and stochastic factors dominate variation in DNA methylation of the human IGF2/H19 locus. *Human Molecular Genetics* 16 (5): 547–54.
238. Bjornsson, H. T., M. I. Sigurdsson, M. D. Fallin, R. A. Irizarry, T. Aspelund, H. Cui, W. Yu, et al. 2008. Intra-individual change over time in DNA methylation with familial clustering. *JAMA: The Journal of the American Medical Association* 299 (24): 2877–83.
239. Kaminsky, Z. A., T. Tang, S. C. Wang, C. Ptak, G. H. Oh, A. H. Wong, L. A. Feldcamp, et al. 2009. DNA methylation profiles in monozygotic and dizygotic twins. *Nature Genetics* 41 (2): 240–45.
240. Bergen, A. W., A. Baccarelli, T. K. McDaniel, K. Kuhn, R. Pfeiffer, J. Kakol, P. Bender, et al. 2007. Cis sequence effects on gene expression. *BMC Genomics* 8: 296.
241. Petronis, A. 2006. Epigenetics and twins: Three variations on the theme. *Trends in Genetics* 22 (7): 347–50.
242. Haas, C. S., C. J. Creighton, X. Pi, I. Maine, A. E. Koch, G. K. Haines, S. Ling, A. M. Chinnaiyan, and J. Holoshitz. 2006. Identification of genes modulated in rheumatoid arthritis using complementary DNA microarray analysis of lymphoblastoid B cell lines from disease-discordant monozygotic twins. *Arthritis and Rheumatism* 54 (7): 2047–60.
243. Hu, V. W., B. C. Frank, S. Heine, N. H. Lee, and J. Quackenbush. 2006. Gene expression profiling of lymphoblastoid cell lines from monozygotic twins discordant in severity of autism reveals differential regulation of neurologically relevant genes. *BMC Genomics* 7: 118.
244. Mak, Y. T., G. Hampson, J. N. Beresford, and T. D. Spector. 2004. Variations in genome-wide gene expression in identical twins—a study of primary osteoblast-like culture from female twins discordant for osteoporosis. *BMC Genomics* 5: 14.
245. Matigian, N., L. Windus, H. Smith, C. Filippich, C. Pantelis, J. McGrath, B. Mowry, and N. Hayward. 2007. Expression profiling in monozygotic twins discordant for bipolar disorder reveals dysregulation of the WNT signalling pathway. *Molecular Psychiatry* 12 (9): 815–25.
246. Munshi, N. C., T. Hideshima, D. Carrasco, M. Shamma, D. Auclair, F. Davies, N. Mitsiades, et al. 2004. Identification of genes modulated in multiple myeloma using genetically identical twin samples. *Blood* 103 (5): 1799–1806.
247. Sarkijarvi, S., H. Kuusisto, R. Paalavuo, M. Levula, N. Airla, T. Lehtimaki, J. Kaprio, M. Koskenvuo, and I. Elovaara. 2006. Gene expression profiles in Finnish twins with multiple sclerosis. *BMC Medical Genetics* 7: 11.
248. Zhou, X., F. K. Tan, M. Xiong, F. C. Arnett, and C. A. Feghali-Bostwick. 2005. Monozygotic twins clinically discordant for scleroderma show concordance for fibroblast gene expression profiles. *Arthritis and Rheumatism* 52 (10): 3305–14.
249. Helbig, I., N. A. Matigian, L. Vadlamudi, K. M. Lawrence, M. A. Bayly, S. M. Bain, D. Diyagama, et al. 2008. Gene expression analysis in absence epilepsy using a monozygotic twin design. *Epilepsia* 49 (9): 1546–54.
250. Kakiuchi, C., K. Iwamoto, M. Ishiwata, M. Bundo, T. Kasahara, I. Kusumi, T. Tsujita, et al. 2003. Impaired feedback regulation of XBP1 as a genetic risk factor for bipolar disorder. *Nature Genetics* 35 (2): 171–75.
251. National Institutes of Health. 2005. NIH Roadmap for medical research. <http://nihroadmap.nih.gov/epigenomics>.
252. Swan, G. E., N. L. Benowitz, C. N. Lessov, P. Jacob 3rd, R. F. Tyndale, and K. Wilhelmsen. 2005. Nicotine metabolism: The impact of CYP2A6 on estimates of additive genetic influence. *Pharmacogenetics and Genomics* 15 (2): 115–25.

253. Saccone, S. F., A. L. Hinrichs, N. L. Saccone, G. A. Chase, K. Konvicka, P. A. Madden, N. Breslau, et al. 2007. Cholinergic nicotinic receptor genes implicated in a nicotine dependence association study targeting 348 candidate genes with 3713 SNPs. *Human Molecular Genetics* 16 (1): 36–49.
254. Benowitz, N. L., G. E. Swan, P. Jacob 3rd, C. N. Lessov-Schlaggar, and R. F. Tyndale. 2006. CYP2A6 genotype and the metabolism and disposition kinetics of nicotine. *Clinical Pharmacology and Therapeutics* 80 (5): 457–67.
255. Benowitz, N. L., C. N. Lessov-Schlaggar, G. E. Swan, and P. Jacob 3rd. 2006. Female sex and oral contraceptive use accelerate nicotine metabolism. *Clinical Pharmacology and Therapeutics* 79 (5): 480–88.
256. Swan, G. E., N. L. Benowitz, P. Jacob 3rd, C. N. Lessov, R. F. Tyndale, K. Wilhelmsen, R. E. Krasnow, M. R. McElroy, S. E. Moore, and M. Wambach. 2004. Pharmacogenetics of nicotine metabolism in twins: Methods and procedures. *Twin Research* 7 (5): 435–48.
257. Al Koudsi, N., J. C. Mwenifumbo, E. M. Sellers, N. L. Benowitz, G. E. Swan, and R. F. Tyndale. 2006. Characterization of the novel CYP2A6*21 allele using in vivo nicotine kinetics. *European Journal of Clinical Pharmacology* 62 (6): 481–84.
258. Mwenifumbo, J. C., C. N. Lessov-Schlaggar, Q. Zhou, R. E. Krasnow, G. E. Swan, N. L. Benowitz, and R. F. Tyndale. 2008. Identification of novel CYP2A6*1B variants: The CYP2A6*1B allele is associated with faster in vivo nicotine metabolism. *Clinical Pharmacology and Therapeutics* 83 (1): 115–21.
259. Swan, G. E., C. N. Lessov-Schlaggar, R. E. Krasnow, K. C. Wilhelmsen, P. Jacob 3rd, and N. L. Benowitz. 2007. Genetic and environmental sources of variation in heart rate response to infused nicotine in twins. *Cancer Epidemiology, Biomarkers & Prevention* 16 (6): 1057–64.
260. Benowitz, N. L., E. J. Perez-Stable, B. Herrera, and P. Jacob 3rd. 2002. Slower metabolism and reduced intake of nicotine from cigarette smoking in Chinese-Americans. *Journal of the National Cancer Institute* 94 (2): 108–15.
261. Yamazaki, H., K. Inoue, M. Hashimoto, and T. Shimada. 1999. Roles of CYP2A6 and CYP2B6 in nicotine C-oxidation by human liver microsomes. *Archives of Toxicology* 73 (2): 65–70.
262. Caporaso, N. E., C. Lerman, J. Audrain, N. R. Boyd, D. Main, H. J. Issaq, B. Utermahlan, R. T. Falk, and P. Shields. 2001. Nicotine metabolism and CYP2D6 phenotype in smokers. *Cancer Epidemiology, Biomarkers & Prevention* 10 (3): 261–63.
263. Cholerton, S., A. Arpanahi, N. McCracken, C. Boustead, H. Taber, E. Johnstone, J. Leathart, A. K. Daly, and J. R. Idle. 1994. Poor metabolisers of nicotine and CYP2D6 polymorphism. *Lancet* 343 (8888): 62–63.
264. Perez-Stable, E. J., B. Herrera, P. Jacob 3rd, and N. L. Benowitz. 1998. Nicotine metabolism and intake in black and white smokers. *JAMA: The Journal of the American Medical Association* 280 (2): 152–56.
265. Benowitz, N. L., and P. Jacob 3rd. 1994. Metabolism of nicotine to cotinine studied by a dual stable isotope method. *Clinical Pharmacology and Therapeutics* 56 (5): 483–93.
266. Human Cytochrome P450 (CYP) Allele Nomenclature Committee. 2007. CYP2A6 allele nomenclature. <http://www.cypalleles.ki.se/cyp2a6.htm> (accessed January 9, 2008).
267. Bergen, A. W., J. F. Korczak, K. A. Weissbecker, and A. M. Goldstein. 1999. A genome-wide search for loci contributing to smoking and alcoholism. *Genetic Epidemiology* 17 Suppl. 1: S55–S60.
268. Craig, A. M., and Y. Kang. 2007. Neurexin-neuroigin signaling in synapse development. *Current Opinion in Neurobiology* 17 (1): 43–52.
269. Liu, Q. R., T. Drgon, D. Walther, C. Johnson, O. Poleskaya, J. Hess, and G. R. Uhl. 2005. Pooled association genome scanning: Validation and use to identify addiction vulnerability loci in two samples. *Proceedings of the National Academy of Sciences of the United States of America* 102 (33): 11864–69.
270. Feng, Z., W. Li, A. Ward, B. J. Piggott, E. R. Larkspur, P. W. Sternberg, and X. Z. Xu. 2006. A C. elegans model of nicotine-dependent behavior: Regulation by TRP-family channels. *Cell* 127 (3): 621–33.
271. Washington University in St. Louis. 2007. Welcome to the National Institute on Drug Abuse Center for Genetic Studies. <http://zork.wustl.edu/nida>.
272. Berrettini, W., X. Yuan, F. Tozzi, K. Song, C. Francks, H. Chilcoat, D. Waterworth, P. Muglia, and V. Mooser. 2008. Alpha-5/alpha-3 nicotinic receptor subunit alleles

2. Status of Genetic Studies of Nicotine Dependence

- increase risk for heavy smoking. *Molecular Psychiatry* 13 (4): 368–73.
273. Bierut, L. J., J. A. Stitzel, J. C. Wang, A. L. Hinrichs, S. Bertelsen, L. Fox, R. A. Grucza, et al. Forthcoming. An amino acid change in the alpha 5 nicotinic receptor increases risk for nicotine dependence. *American Journal of Psychiatry*.
274. Thorgeirsson, T. E., F. Geller, P. Sulem, T. Rafnar, A. Wiste, K. P. Magnusson, A. Manolescu, et al. 2008. A variant associated with nicotine dependence, lung cancer and peripheral arterial disease. *Nature* 452 (7187): 638–42.
275. Hung, R. J., J. D. McKay, V. Gaborieau, P. Boffetta, M. Hashibe, D. Zaridze, A. Mukeria, et al. 2008. A susceptibility locus for lung cancer maps to nicotinic acetylcholine receptor subunit genes on 15q25. *Nature* 452 (7187): 633–37.
276. Amos, C. I., X. Wu, P. Broderick, I. P. Gorlov, J. Gu, T. Eisen, Q. Dong, et al. 2008. Genome-wide association scan of tag SNPs identifies a susceptibility locus for lung cancer at 15q25.1. *Nature Genetics* 40 (5): 616–22.
277. Chanock, S. J., and D. J. Hunter. 2008. Genomics: When the smoke clears.... *Nature* 452 (7187): 537–38.
278. Caron, L., K. Karkazis, T. A. Raffin, G. Swan, and B. A. Koenig. 2005. Nicotine addiction through a neurogenomic prism: Ethics, public health, and smoking. *Nicotine & Tobacco Research* 7 (2): 181–97.
279. Shields, A. E., D. Blumenthal, K. B. Weiss, C. B. Comstock, D. Currivan, and C. Lerman. 2005. Barriers to translating emerging genetic research on smoking into clinical practice. Perspectives of primary care physicians. *Journal of General Internal Medicine* 20 (2): 131–38.
280. Gibbs, J. R., and A. Singleton. 2006. Application of genome-wide single nucleotide polymorphism typing: Simple association and beyond. *PLoS Genetics* 2 (10): e150.
281. Amos, C. I. 2007. Successful design and conduct of genome-wide association studies. *Human Molecular Genetics* 16 (Spec. No. 2): R220–R225.
282. Owen, K. R., and M. I. McCarthy. 2007. Genetics of type 2 diabetes. *Current Opinion in Genetics & Development* 17 (3): 239–44.
283. Kronenberg, F. 2008. Genome-wide association studies in aging-related processes such as diabetes mellitus, atherosclerosis and cancer. *Experimental Gerontology* 43 (1): 39–43.
284. Seshadri, S., A. L. DeStefano, R. Au, J. M. Massaro, A. S. Beiser, M. Kelly-Hayes, C. S. Kase, et al. 2007. Genetic correlates of brain aging on MRI and cognitive test measures: A genome-wide association and linkage analysis in the Framingham Study. *BMC Medical Genetics* 8 Suppl. 1: S15.
285. Lunetta, K. L., R. B. D'Agostino Sr., D. Karasik, E. J. Benjamin, C. Y. Guo, R. Govindaraju, D. P. Kiel, et al. 2007. Genetic correlates of longevity and selected age-related phenotypes: A genome-wide association study in the Framingham Study. *BMC Medical Genetics* 8 Suppl. 1: S13.
286. Gottlieb, D. J., G. T. O'Connor, and J. B. Wilk. 2007. Genome-wide association of sleep and circadian phenotypes. *BMC Medical Genetics* 8 Suppl. 1: S9.
287. Butcher, L. M., O. S. Davis, I. W. Craig, and R. Plomin. 2008. Genome-wide quantitative trait locus association scan of general cognitive ability using pooled DNA and 500K single nucleotide polymorphism microarrays. *Genes, Brain, and Behavior* 7 (4): 435–46.
288. Shields, A., C. Lerman, and P. Sullivan. 2004. Translating emerging research on the genetics of smoking into clinical practice: Ethical and social considerations. *Nicotine & Tobacco Research* 6 (4): 675–88.
289. Shields, A. E., D. E. Levy, D. Blumenthal, D. Currivan, M. McGinn-Shapiro, K. B. Weiss, R. Yucel, and C. Lerman. 2008. Primary care physicians' willingness to offer a new genetic test to tailor smoking treatment, according to test characteristics. *Nicotine & Tobacco Research* 6: 1037–45.
290. Levy, D. E., E. J. Youatt, and A. E. Shields. 2007. Primary care physicians' concerns about offering a genetic test to tailor smoking cessation treatment. *Genetics in Medicine* 9 (12): 842–49.
291. Walter, J. H., F. J. White, S. K. Hall, A. MacDonald, G. Rylance, A. Boneh, D. E. Francis, G. J. Shortland, M. Schmidt, and A. Vail. 2002. How practical are recommendations for dietary control in phenylketonuria? *Lancet* 360 (9326): 55–57.
292. Wilfond, B. S., G. Geller, C. Lerman, J. Audrain-McGovern, and A. E. Shields. 2002. Ethical issues in conducting behavioral genetics research: The case of smoking prevention trials among

- adolescents. *Journal of Health Care Law Policy* 6 (1): 73–88.
293. Cohn, L. D., S. Macfarlane, C. Yanez, and W. K. Imai. 1995. Risk-perception: Differences between adolescents and adults. *Health Psychology* 14 (3): 217–22.
294. Murray, J. S. 2000. Conducting psychosocial research with children and adolescents: A developmental perspective. *Applied Nursing Research* 13 (3): 151–56.
295. Skinner, E. A., M. Chapman, and P. B. Baltes. 1988. Children's beliefs about control, means-ends, and agency: Developmental differences during middle childhood. *International Journal of Behavioral Development* 11 (3): 369–88.
296. Burchard, E. G., E. Ziv, N. Coyle, S. L. Gomez, H. Tang, A. J. Karter, J. L. Mountain, E. J. Perez-Stable, D. Sheppard, and N. Risch. 2003. The importance of race and ethnic background in biomedical research and clinical practice. *New England Journal of Medicine* 348 (12): 1170–75.
297. Phimister, E. G. 2003. Medicine and the racial divide. *New England Journal of Medicine* 348 (12): 1081–82.
298. Risch, N., E. Burchard, E. Ziv, and H. Tang. 2002. Categorization of humans in biomedical research: Genes, race and disease. *Genome Biology* 3 (7): 2007.
299. Shields, A. E., M. Fortun, E. M. Hammonds, P. A. King, C. Lerman, R. Rapp, and P. F. Sullivan. 2005. The use of race variables in genetic studies of complex traits and the goal of reducing health disparities: A transdisciplinary perspective. *American Psychologist* 60 (1): 77–103.
300. Cooper, M. L., P. K. Wood, H. K. Orcutt, and A. Albino. 2003. Personality and the predisposition to engage in risky or problem behaviors during adolescence. *Journal of Personality and Social Psychology* 84 (2): 390–410.
301. King, P. 1992. The past as prologue: Race, class and gene discrimination. In *Gene mapping: Using law and ethics as guides*, ed. G. J. Annas and S. Elias, 94–111. New York: Oxford Univ. Press.
302. Cleeland, C. S., R. Gonin, L. Baez, P. Loehrer, and K. J. Pandya. 1997. Pain and treatment of pain in minority patients with cancer. The Eastern Cooperative Oncology Group Minority Outpatient Pain Study. *Annals of Internal Medicine* 127 (9): 813–16.
303. Todd, K. H., C. Deaton, A. P. D'Adamo, and L. Goe. 2000. Ethnicity and analgesic practice. *Annals of Emergency Medicine* 35 (1): 11–16.
304. AMA Council on Ethical and Judicial Affairs. 1990. Black-white disparities in health care. *JAMA: The Journal of the American Medical Association* 263 (17): 2344–46.
305. Ayanian, J. Z., I. S. Udvarhelyi, C. A. Gatsonis, C. L. Pashos, and A. M. Epstein. 1993. Racial differences in the use of revascularization procedures after coronary angiography. *JAMA: The Journal of the American Medical Association* 269 (20): 2642–46.
306. Gornick, M. E., P. W. Eggers, T. W. Reilly, R. M. Mentnech, L. K. Fitterman, L. E. Kucken, and B. C. Vladeck. 1996. Effects of race and income on mortality and use of services among Medicare beneficiaries. *New England Journal of Medicine* 335 (11): 791–99.
307. Kahn, K. L., M. L. Pearson, E. R. Harrison, K. A. Desmond, W. H. Rogers, L. V. Rubenstein, R. H. Brook, and E. B. Keeler. 1994. Health care for black and poor hospitalized Medicare patients. *JAMA: The Journal of the American Medical Association* 271 (15): 1169–74.
308. Peterson, E. D., S. M. Wright, J. Daley, and G. E. Thibault. 1994. Racial variation in cardiac procedure use and survival following acute myocardial infarction in the Department of Veterans Affairs. *JAMA: The Journal of the American Medical Association* 271 (15): 1175–80.
309. Smith, D. B. 1999. *Health care divided: Race and healing a nation*. Ann Arbor, MI: Univ. of Michigan Press.
310. Post, S. G., P. J. Whitehouse, R. H. Binstock, T. D. Bird, S. K. Eckert, L. A. Farrer, L. M. Fleck, et al. 1997. The clinical introduction of genetic testing for Alzheimer disease. An ethical perspective. *JAMA: The Journal of the American Medical Association* 277 (10): 832–36.
311. Wachbroit, R. 1998. The question not asked: The challenge of pleiotropic genetic tests. *Kennedy Institute of Ethics Journal* 8 (2): 131–44.
312. Juengst, E. T. 1998. The ethical implications of Alzheimer disease risk testing for other clinical uses of APOE genotyping. In *Genetic testing for Alzheimer disease: Ethical and clinical issues*, ed. S. G. Post and P. J. Whitehouse, 177–88. Baltimore (MD): Johns Hopkins Univ. Press.
313. Comings, D. E., R. Gade, S. Wu, C. Chiu, G. Dietz, D. Muhleman, G. Saucier, et al.

2. Status of Genetic Studies of Nicotine Dependence

1997. Studies of the potential role of the dopamine D1 receptor gene in addictive behaviors. *Molecular Psychiatry* 2 (1): 44–56.
314. Comings, D. E., D. Muhleman, C. Ahn, R. Gysin, and S. D. Flanagan. 1994. The dopamine D2 receptor gene: A genetic risk factor in substance abuse. *Drug and Alcohol Dependence* 34 (3): 175–80.
315. Miller, W. B., D. J. Pasta, J. MacMurray, C. Chiu, H. Wu, and D. E. Comings. 1999. Dopamine receptor genes are associated with age at first sexual intercourse. *Journal of Biosocial Science* 31 (1): 43–54.
316. Bau, C. H., S. Almeida, F. T. Costa, C. E. Garcia, E. P. Elias, A. C. Ponso, A. Spode, and M. H. Hutz. 2001. DRD4 and DAT1 as modifying genes in alcoholism: Interaction with novelty seeking on level of alcohol consumption. *Molecular Psychiatry* 6 (1): 7–9.
317. Noble, E. P., T. Z. Ozkaragoz, T. L. Ritchie, X. Zhang, T. R. Belin, and R. S. Sparkes. 1998. D2 and D4 dopamine receptor polymorphisms and personality. *American Journal of Medical Genetics* 81 (3): 257–67.
318. Billett, E. A., M. A. Richter, F. Sam, R. P. Swinson, X. Y. Dai, N. King, F. Badri, T. Sasaki, J. A. Buchanan, and J. L. Kennedy. 1998. Investigation of dopamine system genes in obsessive-compulsive disorder. *Psychiatric Genetics* 8 (3): 163–69.
319. Comings, D. E., B. G. Comings, D. Muhleman, G. Dietz, B. Shahbahrani, D. Tast, E. Knell, et al. 1991. The dopamine D2 receptor locus as a modifying gene in neuropsychiatric disorders. *JAMA: The Journal of the American Medical Association* 266 (13): 1793–1800.
320. Comings, D. E., D. Muhleman, and R. Gysin. 1996. Dopamine D2 receptor (DRD2) gene and susceptibility to posttraumatic stress disorder: A study and replication. *Biological Psychiatry* 40 (5): 368–72.
321. Muglia, P., U. Jain, F. Macciardi, and J. L. Kennedy. 2000. Adult attention deficit hyperactivity disorder and the dopamine D4 receptor gene. *American Journal of Medical Genetics* 96 (3): 273–77.
322. Nielsen, D. A., M. Virkkunen, J. Lappalainen, M. Eggert, G. L. Brown, J. C. Long, D. Goldman, and M. Linnoila. 1998. A tryptophan hydroxylase gene marker for suicidality and alcoholism. *Archives of General Psychiatry* 55 (7): 593–602.
323. Rowe, D. C., C. Stever, J. M. Gard, H. H. Cleveland, M. L. Sanders, A. Abramowitz, S. T. Kozol, J. H. Mohr, S. L. Sherman, and I. D. Waldman. 1998. The relation of the dopamine transporter gene (DAT1) to symptoms of internalizing disorders in children. *Behavior Genetics* 28 (3): 215–25.
324. Davies, M. R. 2000. The stigma of anxiety disorders. *International Journal of Clinical Practice* 54 (1): 44–47.
325. Link, B. G., J. C. Phelan, M. Bresnahan, A. Stueve, and B. A. Pescosolido. 1999. Public conceptions of mental illness: Labels, causes, dangerousness, and social distance. *American Journal of Public Health* 89 (9): 1328–33.
326. Ritson, E. B. 1999. Alcohol, drugs and stigma. *International Journal of Clinical Practice* 53 (7): 549–51.
327. Link, B. G., E. L. Struening, M. Rahav, J. C. Phelan, and L. Nuttbrock. 1997. On stigma and its consequences: Evidence from a longitudinal study of men with dual diagnoses of mental illness and substance abuse. *Journal of Health and Social Behavior* 38 (2): 177–90.
328. Phelan, J. C., E. J. Bromet, and B. G. Link. 1998. Psychiatric illness and family stigma. *Schizophrenia Bulletin* 24 (1): 115–26.
329. U.S. Department of Health and Human Services. 1999. *Mental health: A report of the Surgeon General—Executive summary*. Rockville, MD: U.S. Department of Health and Human Services, Substance Abuse and Mental Health Services Administration, Center for Mental Health Services, National Institutes of Health, National Institute of Mental Health. <http://www.surgeongeneral.gov/library/mentalhealth/summary.html>.
330. Kite, M. 2001. Insurance firm admits using genetic screening. *The Times*, February 8.
331. Goldstein, J. 1991. The stigmatization of smokers: An empirical investigation. *Journal of Drug Education* 21 (2): 167–82.
332. Penner, M., and S. Penner. 1990. Excess insured health care costs from tobacco-using employees in a large group plan. *Journal of Occupational Medicine* 32 (6): 521–23.
333. Gabel, J. R., H. Whitmore, J. D. Pickreign, K. R. Levit, R. M. Coffey, and R. Vandivort-Warren. 2007. Substance abuse benefits: Still limited after all these years. *Health Affairs (Millwood)* 26 (4): w474–w482.
334. Garnick, D. W., A. M. Hendricks, C. Comstock, and C. Horgan. 1997. Do

- individuals with substance abuse diagnoses incur higher charges than individuals with other chronic conditions? *Journal of Substance Abuse Treatment* 14 (5): 457–65.
335. Benkendorf, J. L., J. E. Reutenauer, C. A. Hughes, N. Eads, J. Willison, M. Powers, and C. Lerman. 1997. Patients' attitudes about autonomy and confidentiality in genetic testing for breast-ovarian cancer susceptibility. *American Journal of Medical Genetics* 73 (3): 296–303.
336. Botkin, J. 2001. Protecting the privacy of family members in survey and pedigree research. *JAMA: The Journal of the American Medical Association* 285 (2): 207–11.
337. McAbee, G. N., J. Sherman, and B. Davidoff-Feldman. 1998. Physician's duty to warn third parties about the risk of genetic diseases. *Pediatrics* 102 (1 Pt. 1): 140–42.
338. U.S. Congress, Office of Technology Assessment. 1992. *Cystic fibrosis and DNA tests: Implications of carrier screening, OTA-BA-532*. Washington, DC: U.S. Government Printing Office. http://govinfo.library.unt.edu/ota/Ota_1/DATA/1992/9208.PDF.
339. *Americans with Disabilities Act of 1990*, 42 U.S.C. § 12101 et seq. (1990).
340. *Federal Register*. 2000. Presidential Documents: Executive Order 13145—To Prohibit Discrimination in Federal Employment Based on Genetic Information. *Federal Register* 65 (28): 6877–80.
341. National Human Genome Research Institute. 2008. Genetic Information Nondiscrimination Act: 2008. <http://www.genome.gov/Pages/PolicyEthics/GeneticDiscrimination/GINAInfoDoc.pdf>.
342. *Genetic Information Nondiscrimination Act of 2008*, Pub. L. 110-233, 122 Stat. 881 (2008). http://frwebgate.access.gpo.gov/cgi-bin/getdoc.cgi?dbname=110_cong_bills&docid=f:h493enr.txt.pdf.
343. Hustead, J. L., and J. Goldman. 2002. Genetics and privacy. *American Journal of Law and Medicine* 28 (2–3): 285–307.
344. Rothstein, M. 2007. Genetic Information Nondiscrimination Act is a first step; won't solve the problem. *The Metropolitan Corporate Counsel*, October: 42. <http://www.metrocorpcounsel.com/pdf/2007/October/42.pdf>.
345. U.S. Department of Health and Human Services. 2007. *Personalized health care: Opportunities, pathways, resources*. U.S. Department of Health and Human Services. <http://www.hhs.gov/myhealthcare/news/phc-report.pdf>.
346. Heitjan, D. F., D. A. Asch, R. Ray, M. Rukstalis, F. Patterson, and C. Lerman. 2008. Cost-effectiveness of pharmacogenetic testing to tailor smoking-cessation treatment. *Pharmacogenomics Journal* 8 (6): 391–99.
347. Welton, N. J., E. C. Johnstone, S. P. David, and M. R. Munafó. 2008. A cost-effectiveness analysis of genetic testing of the DRD2 Taq1A polymorphism to aid treatment choice for smoking cessation. *Nicotine & Tobacco Research* 10 (1): 231–40.
348. Janssens, A. C., M. Gwinn, L. A. Bradley, B. A. Oostra, C. M. van Duijn, and M. J. Khoury. 2008. A critical appraisal of the scientific basis of commercial genomic profiles used to assess health risks and personalize health interventions. *American Journal of Human Genetics* 82 (3): 593–99.
349. Katsanis, S. H., G. Javitt, and K. Hudson. 2008. Public health. A case study of personalized medicine. *Science* 320 (5872): 53–54.

Theoretical Considerations

The use of appropriate measures of nicotine dependence remains a key area for future research on the effects of genes and gene-environment interaction on tobacco use. This part examines the theoretical basis for constructs that may link heritable genetic traits with observable measures of nicotine dependence, including phenotypes representing a causal path between specific genetic actions and measures of nicotine dependence, as well as endophenotypes measuring indirect influences such as those found prior to nicotine exposure.

The first chapter of this part examines theoretical issues in establishing nicotine-dependence phenotypes in humans, including new and existing measures of nicotine dependence, as well as traits that may link specific genetic actions and measures of nicotine dependence. A subsequent chapter explores key issues in using mouse models of nicotine dependence. These issues include the use of nicotinic acetylcholine receptors to examine tissue-specific responses to nicotine within specific genetic strains, relating routes of administration in mice to the physiology of human smoking, and correlating mouse models of nicotine-response behavior with nicotine dependence in humans.

3

The Nicotine-Dependence Phenotype: Translating Theoretical Perspectives and Extant Data into Recommendations for Genetic Mapping

Timothy B. Baker, David V. Conti, Terrie E. Moffit, and Avshalom Caspi

The search for a possible genetic basis for nicotine dependence requires constructs that serve as a link between genes and behavior. Common existing measures of nicotine dependence are highly heritable and have high predictive validity for smoking outcomes yet lack specificity relative to the underlying biological mechanisms that could inform future genetic research. This chapter examines theoretical issues in establishing nicotine-dependence phenotypes, including

- *Distal measures of nicotine dependence, such as the Fagerström tests, the Diagnostic and Statistical Manual of Mental Disorders, and others, focusing on mature nicotine dependence*
- *Newer multidimensional measures of nicotine dependence, such as the Nicotine Dependence Syndrome Scale and the Wisconsin Inventory of Smoking Dependence Motives, examining motivational factors leading to dependence*
- *Endophenotypes and transitional phenotypes, measuring quantities before and after nicotine exposure, respectively, that may potentially form a causal path between specific genetic actions and measures of nicotine dependence, including cognitive, affective, and craving factors*

Further study is needed to establish the validity of such endophenotypes and transitional phenotypes for upstream measures of nicotine dependence and their relationship with genetic and gene-environment influences, which, in turn, may support further research on the impact of such influences on smoking outcomes and behavior.

The analyses described herein were supported by the National Institute of Health grant CA/DA19706.

Introduction

This chapter examines a theoretical basis for the assessment of phenotypes for nicotine dependence, focusing on strategies that investigators might use to assess nicotine dependence with the goal of uncovering its genetic bases. First, an epistemological system (i.e., construct validation) is discussed for studying such complex constructs as dependence. This system provides a vocabulary, a set of principles, and an inferential basis for evaluating evidence for the assessment of nicotine dependence. In addition, a conceptual model is presented that shows how dependence assessments may be characterized by their specificity and their proximity to genetic variants and the biological mechanisms that the variants directly express. This model reveals that genetic variants may be related to a developmental progression of phenotypes: those preceding nicotine exposure (intermediate or endophenotypes), those that arise out of initial nicotine exposure but precede frank dependence (transitional phenotypes), and those regarded as mature clinical phenotypes.

Next, the chapter reviews evidence on existing measures of dependence, including both traditional diagnostic measures and newer multidimensional measures. This evidence is used to draw inferences about the nature and structure of dependence, especially as it manifests in long-term, heavy smokers. Then, existing data are used to address general questions about strategies for genetic mapping. These questions include whether different types of assessments need to be used for different smoker subpopulations, which particular measures need to be used to assess the core and breadth of the phenotype, and how to model environmental influences in such mapping. Then, the chapter addresses future directions for phenotypic assessment, especially the need to develop assessments that reflect the

different stages in progression to dependence (intermediate and transitional phenotypes). Finally, issues regarding the integration of phenotypic measures with research design and analytic strategies are addressed.

Appropriate and accurate assessment of the nicotine-dependence phenotype construct is needed to understand better the molecular genetic basis of tobacco use and nicotine-dependence. The nicotine-dependence *phenotype* comprises the measurable manifestations of heritable information that result in nicotine use that produces persistent socially, clinically, or medically significant distress or dysfunction. Although the use of any sort of nicotine delivery system might satisfy this criterion, this review will concentrate on research and theory relevant to the smoking of tobacco cigarettes.

Most measures of nicotine dependence (e.g., diagnostic items) assess general features of dependence that are causally distal to underlying genetic influences. Common distal measures such as the Fagerström tests and the criteria of the American Psychiatric Association's *Diagnostic and Statistical Manual of Mental Disorders*, fourth edition (*DSM-IV*)¹ tend to assess mature states of nicotine dependence. Such measures could mask upstream causal factors that may, in fact, be closer to a genetic basis for nicotine dependence. Nevertheless, these distal measures assess constructs or dimensions that are highly heritable. Examining newer multidimensional criteria for nicotine dependence, as well as other approaches that take more of a causal and developmental perspective, can serve as an important key to developing phenotypes, endophenotypes, and intermediate phenotypes that, in turn, may correlate more closely with gene action.

The need to assess the phenotype accurately is patent. Genetic variants, by themselves, are relatively uninformative. They attain greater information value to the extent

that they are associated with biological, behavioral, cognitive, or clinical outcomes of interest. Thus, the phenotype confers clinical, societal, and/or theoretical meaning on such genetic variants as alleles. For this reason, phenotypic assessment is central to uncovering the genetic substrata relevant to the maintenance of chronic tobacco use and dependence. However, the attempt to measure this phenotype well is a daunting task that demands that investigators have a clear idea of what they want to measure and why.

One basic question that investigators must address is whether they are interested in “nicotine dependence” as opposed to “tobacco dependence.” This decision could have implications for the selection of genetic variants and phenotypic measures. For example, if one is interested in tobacco dependence, one might assess orosensory perceptual processes that could influence a person’s gustatory reaction to tobacco. In addition, an investigator must decide whether to focus on researching “chronic tobacco use” or “dependence.” The two terms refer to constructs that are related to one another, but are nevertheless distinct, and have important implications for dependence assessment. The focus in this chapter is largely on the assessment of nicotine dependence per se.

Construct Validation

The term *dependence* denotes hypothetical variables or constructs. A *construct* has been defined as “some postulated attribute of people, assumed to be reflected in test performance.”^{2(p283)} *Test performance* is broadly defined and may comprise any characteristic or behavior of the person that can be measured and that is thought to reflect the construct. Thus, the hypothesized features of nicotine dependence should be designed to explain a set of observations that are thought to constitute important

outcomes or manifestations of dependence. These outcomes might include the difficulty that smokers have in quitting, the escalation of smoking over time, craving and withdrawal, and so on. The process of attempting to both uncover the nature of a construct and accurately measure it is known as *construct validation*. This chapter uses the construct validation approach as an interpretive structure or metatheory to guide a discussion of the available research and theory regarding nicotine dependence.

The construct validation approach typically starts with a set of behaviors or outcomes that an investigator wishes to explain. The behaviors or outcomes are usually of social or clinical importance and serve as *criteria* in construct validation research (figure 3.1). The investigator then hypothesizes a set of features and processes that seem to account for the outcomes; these are *construct properties*. Finally, the investigator must select or develop two sorts of assessments: those that measure the construct properties sensitively (i.e., the assessment instrument) and those that tap the outcomes of the construct. Thus, the construct validation approach involves identifying (1) a set of behaviors or outcomes to be explained (the criteria), (2) hypothesized features or processes that are thought to produce the outcomes (these features or processes are actually the mechanisms of the targeted construct, i.e., dependence), and (3) measurement strategies that accurately assess the construct (processes) and its manifestations (i.e., the criteria; figure 3.1). The construct validation approach should have two important payoffs: it should inform people as to the nature of the construct, and it should simultaneously allow them to measure the construct accurately.

A construct validation approach is most needed when there is no single adequate measure of an entity;³ in such cases, the investigator must use multiple measures as

Figure 3.1 Nomological Net: Evaluation Context for a Model of Dependence and Its Relation to Genetic Variants

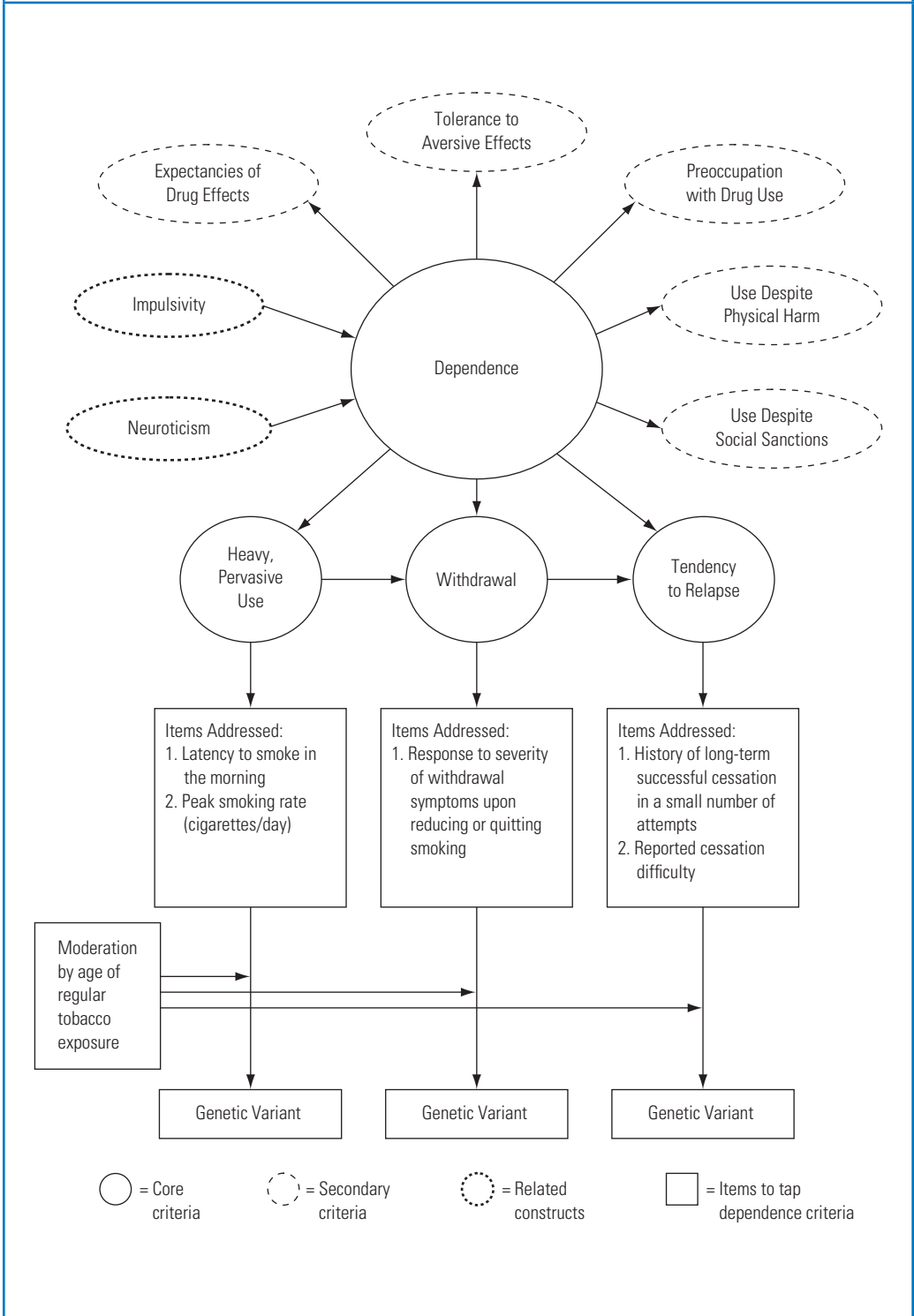

a means of estimating a person's standing on the targeted construct. The notion is that agreement or consensus across a group of related but imperfect indicators will yield better construct estimates than would the use of any single measure. Thus, a construct is a *latent variable* inferred from variables that can be directly observed (manifest variables—that is, the construct assessment or test). There would be no need to assess nicotine dependence as a latent variable if one could directly measure the pathological processes that cause it. For example, a definitive diagnosis of hypertension can be made in response to elevated blood pressure. In the absence of direct assessment of disease processes or pathognomonic signs, multiple converging measures can enhance diagnostic inferences.

The construct validation approach requires several distinct but interrelated questions to be addressed. For example, what are the criteria or outcomes that a nicotine-dependence measure should be able to predict? Just as the construct of gravity is invoked to explain the behavior of falling bodies, how can nicotine dependence be designed to explain certain clinical and societal phenomena? Figure 3.1 provides examples of core and secondary criteria that a model of nicotine dependence might comprise. Core criteria are those that are societally and clinically essential for the construct measures to explain (account for); secondary criteria are those that may provide useful information about the construct but are of somewhat lesser importance. The model depicted in figure 3.1, as an example, posits that, although nicotine dependence should be reflected in positive expectations about nicotine effects, the model's ability to predict relapse is more important.

A construct validation approach is a theory-based approach to epistemology. An investigator should select a dependence measure (items on a test) that accords with

the investigator's theory of dependence: it would measure those variables that reflect, in the investigator's opinion, the presence and magnitude of the critical underlying features or mechanisms of nicotine dependence. The theory also should explain why those hypothesized features or processes affect both the dependence measure as well as the criteria. In sum, in the construct validation approach, a test is a measure of a mechanism or cause, such as a measure of blood pressure, that predicts and explains a person's status on a set of socially or clinically important criteria (e.g., risk of stroke, heart disease, need for treatment). And, if the measure of the mechanism does indeed predict the criteria, the researcher not only validates the test but also simultaneously supports the theoretical model of the studied disorder. Finally, the researcher would like to see that the test has discriminative validity; that is, it is most sensitive to the particular construct that is targeted (nicotine dependence) and less sensitive to related, but not central, constructs (e.g., regular smoking, problems caused by tobacco use).

Note that the construct validation approach is somewhat different from alternative approaches that view addiction as a social construction that cannot be verified or evaluated on the basis of relations with objective criteria.³ In the customary treatment, addiction and dependence are viewed as equivalent to one another (but not equivalent to *physical dependence*, which is inferred from a withdrawal syndrome). Moreover, this treatment recognizes that dependence is a construction based upon social and theoretical perspectives, as does the approach advocated by West.³ The construct validation approach, however, illustrates how to evaluate the validity of one's strategy for measuring dependence on the basis of the empirical relations stipulated by a guiding theoretical model. Therefore, it permits different investigators to hold very different views of dependence,

3. The Nicotine-Dependence Phenotype

but at the same time, it provides a logical system for the simultaneous evaluation of both the theoretical and measurement models of dependence.

Most attempts to measure nicotine dependence have not used a formal construct validation approach. The field has, in general, attempted to measure nicotine-dependence criteria directly rather than attempting to measure the mechanisms or processes of nicotine dependence. For example, this is the approach modeled by the *DSM* and other diagnostic assessments. Such syndromal assessments are atheoretical and tend to focus on observable outcomes of a disorder. One reason for this approach is, no doubt, that investigators had only inchoate notions of dependence mechanisms or features and thus were unprepared to assess dependence mechanisms more

directly. In addition, the purpose of such clinical instruments typically is to detect suffering and compromised function, not to assess causal influences. Regardless of the reasons, investigators have usually tried to measure general outcomes or criteria of severe nicotine dependence rather than mechanisms.

Distal Measures of Dependence

Figure 3.2 depicts a “watershed” model of disorder. This model assumes that different etiologic paths may lead to clinical levels of symptomatology. Approaches may focus on end points that vary in terms of their proximity to specific genetic variants in the causal chain of the disorder. This model will be discussed in greater detail later.

Figure 3.2 Watershed Model of Gene-to-Phenotype Influence

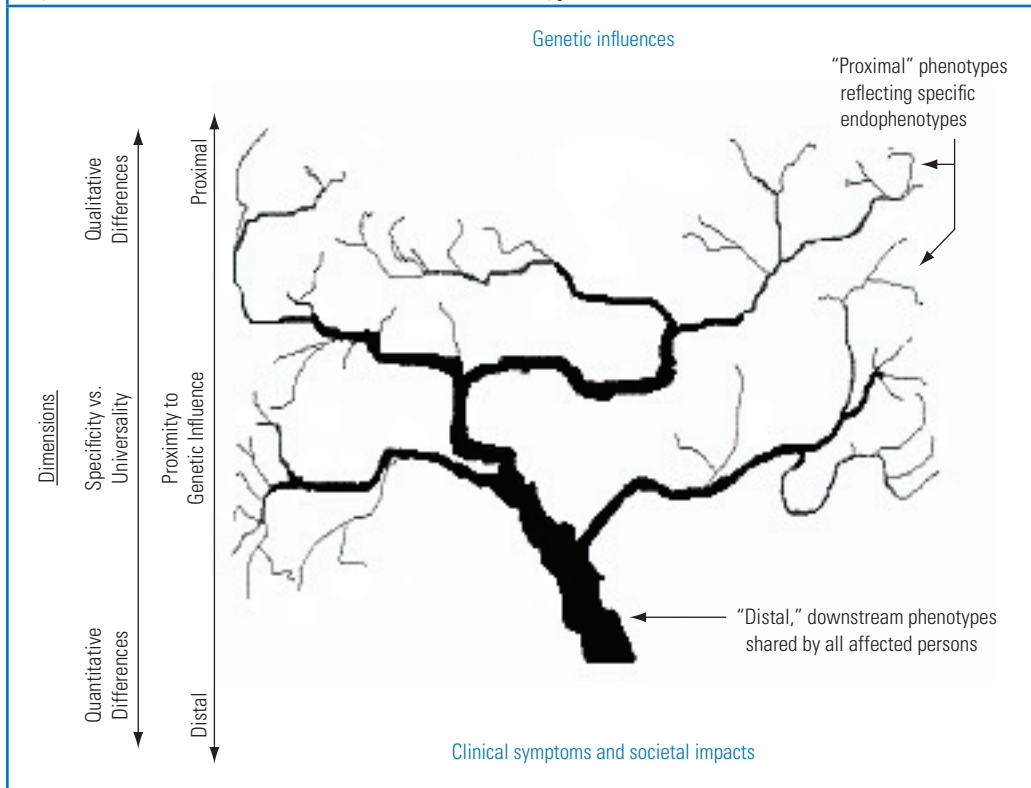

At this point it is worth noting that most nicotine-dependence assessments, thus far, have focused on assessing the “mature” or *distal* nicotine-dependence phenotype; that is, they have measured phenomena that are, no doubt, distant from, and nonspecific to, many of the underlying causal processes (including genetic variants) that contribute to the disorder. This has important implications for how nicotine dependence and genetic influences on it are viewed.

As noted, most research on nicotine dependence has used self-report measures that tap distal end products of dependence processes (e.g., smoking a great deal, being unable to quit) that have social and clinical import. These measures include scales contained in nosologies such as the *DSM*, as well as brief questionnaires such as the Fagerström Test for Nicotine Dependence (FTND).⁴ In addition, researchers have used subsets of items or individual items from such scales (e.g., the Heaviness of Smoking Index [HSI]).⁵ Such measures may have poor signal-to-noise ratios relative to biological mechanisms that underlie nicotine dependence and that may sensitively reflect status on particular genetic variants; that is, they may reflect numerous influences and are most likely causally remote from basic biological mechanisms of nicotine dependence (see figure 3.2). Despite these limitations, such distal measures have yielded clues as to the nature of nicotine dependence and its genetic influences.

The distal measures considered initially in this section (e.g., the FTND and psychiatric diagnostic criteria such as those in the *DSM-IV*^{1*} elicit information regarding the general consequences or characteristics of nicotine dependence. Thus, these measures

elicit information about how much people smoke, whether they experience withdrawal symptoms or craving, whether they tend to return to tobacco use once they stop, whether they have trouble controlling tobacco use, and so on. These measures were designed to capture major clinical manifestations of addiction,³ not to assess features of dependence with strong genetic association.

Fagerström Measures

The Fagerström Tolerance Questionnaire (FTQ),⁶ and measures derived from it, were intended to be unifactorial measures of nicotine dependence. These measures make up the FTQ itself, as well as the six-item FTND,⁴ and the two-item HSI.⁷ These measures are based on the construct of physical dependence, which was hypothesized to include facets such as the need to smoke early in the morning to alleviate overnight withdrawal, the need to smoke numerous cigarettes per day, and the invariance of smoking behavior—that is, smoking even when one is ill.⁶

Two questions on the FTND (i.e., questions 1 and 4) and the two questions of the HSI assume a pattern of daily smoking. It is very likely that scores on these items will have reduced validity if used with nondaily smokers.

Compared with the FTQ, the FTND has demonstrated better psychometric properties such as internal consistency.^{8–10} However, these improved reliability coefficients are still low^{8,11} and are below traditionally accepted standards for clinical use ($\alpha = .80$).¹²

Some studies show that the FTND has a two-factor structure, suggesting that it does

*The Cigarette Dependence Scale is also designed to assess a single factor of dependence. (See Etter, J. F., J. Le Houezec, and T. V. Perneger. 2003. A self-administered questionnaire to measure dependence on cigarettes: The cigarette dependence scale. *Neuropsychopharmacology* 28 (2): 359–70.) At present, there is too little evidence on this scale to permit its evaluation with regard to genetic mapping.

not measure a unitary construct of physical dependence.^{8,9,13–16} Factor analytic research tends to show that even if more than one factor is obtained, the two factors are highly correlated.^{13,17} Interitem correlations also reveal that not all items are highly related ($r = .06$ – $.39$).¹⁸ The various factor analytic studies differ in terms of factor-item linkages.^{8,13,16} However, the weight of the evidence suggests the existence of two factors, with one of the factors suggesting a pattern of compulsive smoking, and the other factor reflecting what is termed “morning smoking” (e.g., whether one smokes more in the morning than at other times). The items that typically load on the compulsive smoking factor are those that assess the number of cigarettes smoked per day, time to first cigarette, and difficulty refraining from smoking when ill. There is some variability in which specific items load on this compulsive smoking factor, no doubt because the factors are intercorrelated and some items are highly correlated with both factors.^{13,16} What is clear is that, in general, the first principal component or main factor is the compulsive smoking factor and that it accounts for the lion’s share of predictive validity of the FTND.⁸ Latent class analyses suggest that the FTND ranks smokers in a manner that corresponds fairly well to an empirically derived method.¹⁹

The HSI comprises only two items, which limits the relevance of internal consistency estimates. However, zero-order correlations between the two items in the measure indicate moderate levels of association (e.g., r ’s $\approx .30$).¹⁸ Both of these items tend to load statistically on a factor typically labeled “compulsive smoking.”

The FTND and HSI predict both behavioral and biochemical indices of smoking (e.g., carbon monoxide [CO], cotinine, lifetime amount smoked).^{4,5,7,14,20,21} This should not be surprising, given that the FTND and HSI directly assess smoking heaviness. However, it is encouraging to

note that smokers are able to estimate their amount of smoking as indexed by biochemical tests in response to single items (e.g., “How many cigarettes/day do you smoke?”). The FTND has demonstrated an ability to predict cessation outcomes in smoking cessation studies.^{18,22–25} However, the HSI appears to account for much of the predictive validity of the FTND.^{5,18,26} Population-based studies conducted in Australia, Canada, the United Kingdom, and the United States found that the two HSI items (number of cigarettes smoked per day and time to first cigarette [TTFC] in the morning) were the strongest predictors of quitting.^{27,28} Furthermore, later research has shown that a single item on both the FTND and HSI, the TTFC, predicts relapse vulnerability as well as, or better than, much longer multidimensional instruments.¹⁸ Additional population-based research shows that a single item on the HSI (TTFC) is highly effective in predicting the likelihood of future cessation.¹⁸ Finally, latent class analyses suggest that the TTFC is highly informative for discriminating empirically derived classes.¹⁹

The *DSM* and the *International Statistical Classification of Diseases and Related Health Problems*

Two different diagnostic systems commonly are used to diagnose tobacco dependence, and both typically are considered to be unidimensional measures of tobacco dependence. One is the *DSM-IV*,¹ which is based on an empirically driven, syndromal medical model, rather than on a theoretical model of dependence. The second is the *International Statistical Classification of Diseases and Related Health Problems, Tenth Revision (ICD-10)*,²⁹ an international diagnostic classification system that came into use in World Health Organization member states in 1994. Most of the extant research has utilized *DSM* criteria and

DSM-IV Criteria

1. Tolerance
2. Withdrawal
3. Use in larger amounts/over longer period than intended
4. Persistent desire/unsuccessful efforts to cut down or quit
5. Great deal of time using/recovering
6. Important activities given up
7. Continued use despite emotional/physical problems

HSI Questions^a

1. “At present, how long after waking do you wait before having your first cigarette (in mins)?”
2. “How many cigarettes do you smoke per day at present?”

^aHSI questions from Heatherton and colleagues,^{5(p793)}

will be the focus of this chapter’s review of diagnostic classifications of tobacco dependence.

Structured clinical interviews based on the *DSM* and the *ICD*, such as the World Mental Health Survey Initiative version of the Composite International Diagnostic Interview (CIDI)³⁰ or the National Institute of Mental Health Diagnostic Interview Schedule (DIS), comprise a series of branching questions that are aimed at eliciting information about features relevant to nicotine dependence; they have been translated into various languages and used in multiple population-based studies.^{31–34}

Data on the reliability and structure of diagnostic interview measures of nicotine dependence arise from studies using face-to-face administration strategies. Therefore, the following conclusions cannot necessarily be generalized to a different administration format. There is evidence

that the various structured diagnostic measures yield reliable diagnoses as assessed by test-retest reliability ($\kappa = .63$),³⁵ $\kappa = .88$,³³ and $\kappa = .73$.³⁶ One factor analysis indicated that responses to the CIDI had a strong single-factor structure,³⁷ although other factor analyses of the structured diagnostic items found that a two-factor structure was a better fit.^{38–40}

Evidence suggests that the small set of dichotomous *DSM* items can distinguish between light versus heavy smoking.³⁷ An epidemiological study found that the *DSM* (third edition revised [*DSM-III-R*]), as assessed by the DIS, was a significant, though weak, predictor of cigarette abstinence over one year, but that the FTND was a better predictor, and that number of cigarettes smoked per day was the best predictor.²⁶ Another study showed that *DSM-IV* diagnoses of nicotine dependence predicted heaviness of use and cessation outcome in a population-based study of college students.⁴¹ Several studies have shown that *DSM-IV* nicotine-dependence diagnosis is associated with greater risk of psychiatric comorbidities in adults and youth.^{35,42,43} In sum, there is substantial evidence that *DSM* and *ICD* diagnoses are meaningfully related to smoking heaviness and psychiatric status.

Multidimensional Measures of Nicotine Dependence

Multidimensional measures offer some promise in elucidating the nature of dependence and in helping to refine the phenotype so as to foster more informative genetic mapping. Figure 3.2 shows a watershed model of how genetic influences may affect a complex phenotype across ontogeny.⁴⁴ This model conveys the notion that a final disease phenotype may be the product of diverse types of influences, and that some influences may be operative for some people, while other influences are operative for other people. However, these

diverse “feeder stream” influences are somewhat compensatory and interchangeable with respect to contributing to “downstream” processes that produce mature features of nicotine dependence. It is conceivable that these influences may exert additive or interactive effects and that they might be differentially sensitive to environmental events. Such influences could be viewed as reflecting the myriad influences that constitute quantitative trait loci.

The assumption is, however, that there is a “final common pathway” (ultimate downstream) set of processes and symptoms that is manifest once a disorder achieves some level of severity. Thus, at clinical levels of a disorder, sufferers appear similar to one another, but this similarity may mask diverse etiologic paths. Diagnostic measures of dependence such as the *DSM*, FTND, and HSI are intended to index the “final common pathway” of nicotine-dependence processes, rather than the “feeder streams” (relatively discrete pathways) that may individually and collectively influence the disorder and that (in theory) share stronger relations with particular genetically influenced biological processes. These measures can be labeled “distal” in that they are relatively remote from the genetic variants that the phenotypic measures are intended to reflect.

The FTND, HSI, and the *DSM*-type diagnostic measures were intended to measure a unitary, synthetic clinical manifestation of dependence (albeit, the measures may not in fact be unidimensional). The two distal measures reviewed below are intended to be multifactorial. They were developed in response to emerging data that nicotine dependence itself appears to comprise multiple dimensions.⁴⁵ The relevance of such measures to genetic mapping is that they contain heterogeneous items, which may help elucidate the sorts of items that are, and are not, sensitive to genetic variants (permit distillation of the phenotype). Further, if nicotine dependence involves

multiple components, assessment of each dimension may permit the detection of subgroups of smokers who show unique or qualitatively different manifestations of dependence. Subgroups that differ on the basis of relevance or intensity of dependence dimensions are termed *mature subphenotypes* in this chapter. The concept of the “mature subphenotype” is based on the notion that some groups of smokers may differ qualitatively in dependence such that different measures of dependence are more sensitive to dependence in one subgroup versus another (figure 3.3). This would occur if the processes that contribute to the final common pathway of dependence (e.g., tolerance, tendency to relapse back to tobacco use, activation of incentive structures in response to nicotine anticipation) do not completely mask diversity in etiology.

Two relatively new multifactorial scales have been developed that are designed to identify somewhat distinct dimensions of nicotine dependence. These are reviewed here with an eye toward evaluating their basic features and their potential utility in genetics research. It is important to bear in mind that neither of the reviewed instruments was designed specifically to assess nicotine-dependence dimensions for the purpose of molecular genetics research; other goals were operative, such as isolating the relatively distinct motivational dimensions of dependence.

Nicotine Dependence Syndrome Scale

The Nicotine Dependence Syndrome Scale (NDSS) is a 19-item self-report measure developed to assess nicotine dependence on the basis of Edwards’s (1976) theory of the alcohol dependence syndrome.⁴⁶ Edwards’s theory identified the core elements of alcohol dependence as (1) narrowing of the repertoire of drinking behaviors, (2) increased salience of drink-seeking behaviors, (3) increased tolerance,

Figure 3.3 Etiologic Path and Locus of Phenotypic Assay

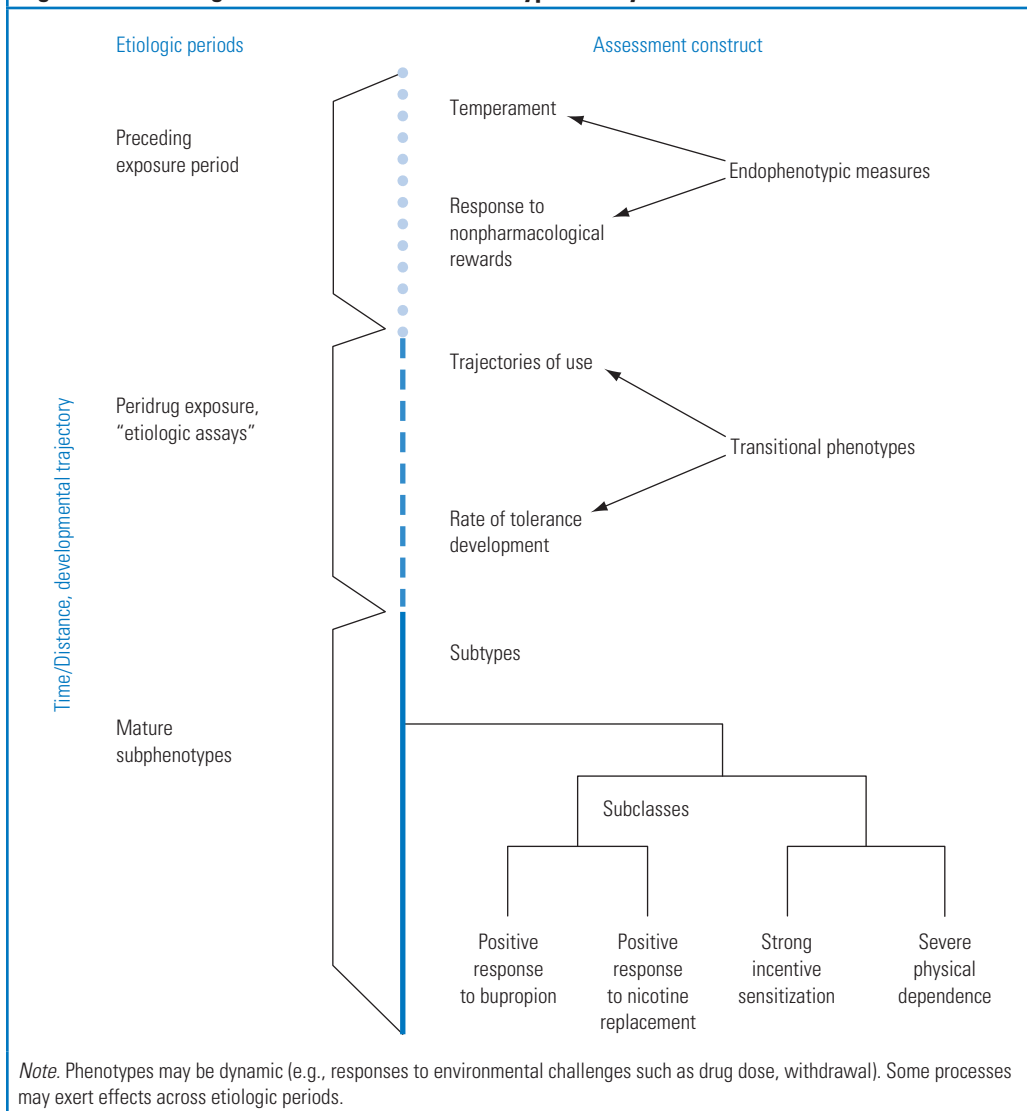

(4) occurrence of withdrawal symptoms, (5) use of alcohol to avoid or relieve withdrawal, (6) subjective awareness of a compulsion to drink, and (7) a tendency to resume alcohol use after abstinence.⁴⁷ The NDSS comprises five different subscales: Drive—craving, withdrawal and smoking compulsions; Priority—preference for smoking over other reinforcers; Tolerance—reduced sensitivity to the effects of smoking; Continuity—regularity

of smoking rate across place and time; and Stereotypy—the invariance of smoking. The NDSS has the advantages of a clear theoretical basis and evidence⁴⁶ that shows that either the whole scale, or some individual subscales, are significantly related to nicotine-dependence indices such as smoking heaviness, withdrawal measures, and other dependence measures such as the FTND. In addition, the NDSS can distinguish between chippers (chronically light smokers)

and heavy smokers.⁴⁸ Thus, it would be possible to use these subscales to select subgroups or types of smokers or to relate genetic variants to a continuous dependence subdimension represented by these scales.

Although the NDSS has promise as a measure of nicotine-dependence subtypes, the scale could be improved further for genetics research for the following reasons: (1) Some individual subscales have modest internal consistencies (or reliabilities), which undercut their use in measuring discrete dependence subtypes or elements.⁴⁹ (2) Some subscales comprise quite disparate types of items. For example, the Drive subscale mostly comprises items that measure withdrawal, but not exclusively. The somewhat heterogeneous item sets were apparently needed because of the breadth of the constructs targeted. This item heterogeneity also accounts, no doubt, for the modest internal consistencies of some of the subscales. Differential weighting of items via factor scores does not apparently mitigate this effect.^{49,50} (3) Like the other distal measures previously reviewed, the NDSS subscales do not appear to tap constructs that are tightly linked to relatively discrete, fundamental biological processes that should, themselves, reflect variation in the genetic variants of interest. Although the NDSS does not provide specific indices of particular biological processes, its subscales assess relatively discrete dimensions of nicotine dependence; these may shed light on the core features of dependence, which might, in turn, promote more effective assessment strategies.

Wisconsin Inventory of Smoking Dependence Motives

The Wisconsin Inventory of Smoking Dependence Motives (WISDM) is a 68-item scale that comprises 13 subscales.⁵⁰ The primary goal in developing the WISDM was to create a theory-based research instrument to identify fundamental

motivational processes that ultimately influence dependence criteria (e.g., relapse, withdrawal severity). In other words, the scale is designed to measure motivational influences that lead to dependence features or criteria.

The WISDM comprises the subscales listed in table 3.1 (table 3.1 also provides a rationale for each subscale). The WISDM has some advantages for genetics research. One is that the overall scale score and many of the subscales predict classic dependence criteria such as self-administration rate, withdrawal magnitude, and relapse.⁵⁰ Moreover, each subscale has acceptable reliability. This means it may be used profitably as an independent assay of a particular smoking motive.

The subscales were designed to reflect discrete motives that drive tobacco use in addicted individuals. Some of these motives may be associated with particular biological response systems and structures that may suggest genes that deserve investigation. As an example of this, the Taste/Sensory Processes subscale was developed because research showed the importance of gustatory and sensory cues in motivating smoking.^{51,52} Taste sensitivity, especially the ability to taste bitter flavors, is related to phenylthiocarbamide (PTC) haplotype status.⁵³ Subsequent research has shown that smokers who achieve higher scores on the Taste/Sensory Processes subscale tend to possess PTC haplotypes associated with an inability to taste bitter tastes.⁵⁴ In other words, those smokers who can taste bitter flavors are less likely to smoke for taste reasons. The importance of specificity in the assessment of dependence dimensions is suggested by the finding that the Taste/Sensory Processes subscale became more highly associated with PTC status once nontaste items were removed from the subscale. Thus, the relation depended on taste per se, rather than other orosensory factors.

Table 3.1 Subscales of the Wisconsin Inventory of Smoking Dependence Motives

Subscale	Construct rationale: evidence base
Affiliative Attachment	Use of addictive drugs, including nicotine, is motivated by the impact of the drug on social affection systems and is manifest as emotional attachment to the drug. ^{55,56}
Automaticity	Drug self-administration and supportive information processing becomes automated. ^{57,58}
Behavioral Choice/Melioration	Drug use is inversely proportional to constraints on access to drug and to other reinforcers. ⁵⁹
Cognitive Enhancement	Nicotine enhances cognitive processing or via suppression of withdrawal. ⁶⁰ This may be especially important to certain populations. ⁶¹
Craving	Craving reflects not only magnitude of physical dependence ⁶⁰ but also error signals indicative of conflict over drug-use decisions in such structures as the anterior cingular cortex. ⁶²
Cue Exposure/Associative Processes	Conditioned responses to drug cues activate drug motivational processing and encourage self-administration and may reflect activity in dopaminergic incentive systems. ⁶³
Loss of Control	Strong dependence motivation is related to the perception of loss of volition.
Negative Reinforcement	Drug use is motivated by strong negative affect occurring via either withdrawal or stressors; source of negative affect may be linked with relevant processing substrata such as the amygdala or extended amygdala. ⁵⁷
Positive Reinforcement	Drug use is motivated by desire to experience mood enhancement (rush, high) even in the absence of distress; may be linked to mesotelecephalic structures such as the nucleus accumbens. ^{64,65}
Social/Environmental Goals	Social cues associated with drug use can increase drug motivational processing or self-administration. ^{55,66}
Taste/Sensory Processes	Taste and orosensory processes play a strong motivational role in smoking; may be linked to the phenylthiocarbamide haplotype and associated gustatory sensory systems. ^{51,52,67}
Tolerance	Rate of tobacco clearance and tolerance to nicotine actions may permit high levels of self-administration; may be linked to nicotine metabolism or distributional tolerance in the brain. ^{68,69}
Weight Control	Nicotine appears to lower body weight set-point, and this may motivate nicotine self-administration, ⁷⁰ especially among those seeking weight loss; may be related to sensitivity to nicotine's effects on hypothalamic weight regulatory centers or to systems that affect taste hedonics.

Other subscales, such as Cue Exposure/Associative Processes and Positive Reinforcement, were designed to reflect activity in dopaminergic structures, such as the nucleus accumbens, that impart or mediate the processing of the incentive value of drug cues as well as drug induced pleasure or reward.^{63,71–73} Such responses may account for the potent impact of drug-paired cues on nicotine motivation.⁷⁴

Although the WISDM subscales hold some promise for reflecting relatively discrete

dimensions of nicotine dependence, like the NDSS subscales, they also have significant limitations. For example, psychometric analysis has shown that some of the subscales are highly correlated with one another and load onto a common factor. In other words, these subscales may measure a final common pathway (figure 3.2) more than a discrete dependence motive. In addition, although an attempt was made to link the targeted discrete motives with underlying biology, for many of the subscales the self-report dimensions are,

no doubt, only remotely related to activity in any particular biological system. Finally, it seems clear that even with 13 subscales, there are potentially discriminable dimensions that should be assessed but are not. For example, one could easily argue that one useful subphenotype might be the anticipatory excitement or arousal that precedes drug use in a motivated, deprived smoker.⁷⁵ Another target might be the anhedonia of withdrawal—that is, the inability to experience pleasure during withdrawal, which may be related to elevated reward threshold in mesotelencephalic dopaminergic systems.⁷⁶ Finally, it is unclear that some of the individual subscales of either the NDSS or the WISDM share strong relations with classic dependence criteria (e.g., relapse).^{46,50} Thus, the construct validity of each subscale must be demonstrated before strong inferences regarding nicotine dependence can be made (figure 3.1).

In summary, both multifactorial measures of nicotine dependence (i.e., the NDSS and the WISDM) have some promise for measuring relatively discrete dimensions of nicotine dependence, and these measures will, no doubt, prove useful as predictors of relapse, withdrawal, and other nicotine-dependence criteria. In addition, some particular subscales may have potential utility in molecular genetics research. However, some of the subscales are not ideal for this purpose. The constructs they target cannot be tightly related to an underlying biology, and some of the subscales appear to reflect broad, rather than specific, dimensions of nicotine dependence.

Smoking, Initiation of Smoking, and Distal Measures of Dependence

Distal measures have shown that nicotine dependence is under considerable genetic

control. Heritability of *DSM-III-R* nicotine dependence was estimated to be 60% in a sample of Vietnam veteran male twins⁷⁷ and 44% in Minnesota adolescents.⁷⁸ Moreover, biometric modeling suggests an overlap (60%) in the genetic substrata for smoking versus the development of nicotine dependence⁷⁹ but also a moderate residual genetic effect for nicotine dependence (22%). In general, such modeling shows proportionally larger genetic contributions to nicotine dependence than to smoking or smoking initiation and smaller environmental influences.^{80–86} Thus, evidence shows overlap in the genetic influences for initiation of smoking and the development of nicotine dependence, and genetic influence that is unique to dependence.^{87,88} Accordingly, distal measures have the potential to identify nicotine-dependence phenotypes that do, and do not, have associations with causal genetic variants.

Epidemiological research using distal measures also has revealed that heavy smoking and nicotine dependence can be extremely common, at times almost modal, across large populations. Thus, it is possible, or even likely, that large portions of the population possess genes that promote or permit such phenotypes. Under such a circumstance, it may be a more viable strategy to search for genetic influences that discourage or prevent regular tobacco use, rather than to identify the potentially ubiquitous variants that permit nicotine dependence; that is, variants that discourage nicotine dependence might have greater discriminative efficiency. There is precedent for this in the alcohol literature in which polymorphisms of the *ALDH2*2* and *ADH1*2* alleles appear to affect alcohol metabolism. A proposed mechanism of influence for these alleles is that they code for increased levels of the metabolite acetaldehyde, which may impart unpleasant peripheral effects

that discourage high levels of alcohol intake.^{89,90*}

Distal measures have also revealed another important general feature of nicotine dependence: it is not equivalent to regular smoking per se. Indeed, epidemiological data show that a significant proportion of daily smokers, perhaps one-half, do not warrant nicotine-dependence diagnoses.^{32,91} Thus, research shows that many individuals may engage in heavy amounts of smoking and yet never report having experienced strong withdrawal, that their smoking is out of control, or that they have given up important activities because of their smoking (i.e., with dependence indexed by *DSM* or *ICD-10* type of criteria). These observations are consistent with the notion that there appear to be degrees of severity in nicotine dependence even among inveterate smokers, at least to the extent that commonly used distal measures have some validity as measures of nicotine dependence. The researcher's task is to determine how to measure dependence in a manner that reflects its biological and genetic influences.

In summary, distal measures have revealed that (1) nicotine dependence is under considerable genetic control, (2) it is equivalent to neither regular smoking nor smoking initiation, and (3) its genetic origins are somewhat distinct from those that support or permit the development of regular smoking. These observations suggest that while regular smoking may be a component of nicotine dependence, nicotine dependence assays must go beyond assessments of smoking features per se to capture important dimensions of the construct.

A Core Dimension of Nicotine Dependence

One of the anomalies in dependence assessment is that although dependence measures often show poor internal consistency and poor relations with one another,^{33,49} factor analyses show that such measures often load highly onto common factors; even when the factor analyses suggest multiple factors, the factors are highly intercorrelated.^{46,50,92} In addition, zero-order correlations often show strong interrelations among particular dependence measures.^{18,50}

When items derived from the FTND, HSI, or diagnostic criteria are factor analyzed, they show that measures that tap into heaviness of smoking, and pervasiveness of smoking across time or occasion, tend to load most highly on principal component or initial factors. For instance, Muthén and Asparouhov³⁹ factor analyzed items tapping *DSM-IV*¹ symptoms of dependence in a general population sample. This research showed that symptoms were best accounted for by a multidimensional model. The pattern of covariation among the symptoms yielded a first factor with relatively high loadings for items assessing “tolerance,” “larger amounts,” and “time spent using.” “Tolerance” reflects taking increased amounts of nicotine/tobacco to achieve desired effects. “Larger amounts” reflects self-administering nicotine in larger amounts, or over longer periods of time than intended. “Time spent using” reflects the amount of time the individual expends in actual smoking, procuring cigarettes, and so on. Thus, the first factor seems to be highly related to the amount smoked and the amount of time spent smoking. The second

*Of course, protection versus vulnerability is a relative thing; one haplotype could be viewed as a vulnerability factor, or its complement could be considered a protective factor. However, it may be possible to show both protective and vulnerability effects versus a “neutral” haplotype. More to the point, the search for protective factors (versus vulnerabilities) might suggest different phenotypes, different genetic variants, different measurement cut-scores, and different experimental designs.

Inferences about Dependence Derived from Distal Measures

Many distal measures of nicotine dependence have modest psychometric properties (i.e., reliability and validity). For example, scales such as the Fagerström Tolerance Questionnaire (FTND)^a and scales comprising *Diagnostic and Statistical Manual of Mental Disorders (DSM)* items tend to have modest internal consistencies (scores on the items are not highly correlated with one another).^b There is also copious evidence that some dependence scales (e.g., the FTND and the *DSM* criteria) are not highly correlated with each other.^{b,c,d} A number of factors could account for this lack of agreement—for instance, measures or items that are poorly worded, a lack of variance in terms of the assessed construct in the sampled populations, error that differentially affects the measures, and the fact that the different assessments are measuring somewhat different constructs. Curiously, the lack of agreement of dependence measures is actually quite useful. It allows one to determine which types of measures are highly related to each other, and to dependence criteria, and which are not. This provides some insight into core features of dependence and permits the distillation of essential features. Data are considered in this chapter that link particular measures of dependence to principal dependence criteria (e.g., as depicted in figure 3.1).

It appears that the evidence of agreement or commonality among dependence measures is much greater than the evidence of disagreement or inconsistency. Moreover, the evidence of disagreement can be accounted for by logical distinctions among dependence constructs that are targeted by measures and by the fact that different measures or items are susceptible or vulnerable to different sources of error.

^aHeatherton, T. F., L. T. Kozlowski, R. C. Frecker, W. Rickert, and J. Robinson. 1989. Measuring the heaviness of smoking: Using self-reported time to the first cigarette of the day and number of cigarettes smoked per day. *British Journal of Addiction* 84 (7): 791–99.

^bPiper, M. E., D. E. McCarthy, and T. B. Baker. 2006. Assessing tobacco dependence: A guide to measure evaluation and selection. *Nicotine & Tobacco Research* 8 (3): 339–51.

^cBreslau, N., and E. O. Johnson. 2000. Predicting smoking cessation and major depression in nicotine-dependent smokers. *American Journal of Public Health* 90 (7): 1122–27.

^dMoolchan, E. T., A. Radzius, D. H. Epstein, G. Uhl, D. A. Gorelick, J. L. Cadet, and J. E. Henningfield. 2002. The Fagerström Test for Nicotine Dependence and the Diagnostic Interview Schedule: Do they diagnose the same smokers? *Addictive Behaviors* 27 (1): 101–13.

factor was somewhat more related to “persistent desired/unsuccessful efforts to cut down or quit,” and “continued use despite emotional/physical problems.”^{39(p1052)} Confidence in this solution is bolstered by the fact that it was obtained in three separate, relatively large groups of individuals (N s = 8,552–26,946). Thus, the three types of items that loaded onto the first factor reflect heaviness or consistency of use across time.

Other factor analytic studies have generated complementary patterns of findings. Lessov and colleagues⁹² constructed biometric models with a sample comprising male and female dizygotic and monozygotic

twins (as well as different-gender dizygotic twins) who all said that they had either experimented with, or tried, smoking ($N = 6,249$). As part of this research, the authors factor analyzed individual nicotine-dependence items obtained from the *DSM-IV* dependence criteria as well as the two items that constitute the HSI derived from the FTND.⁵ The authors reported a two-factor solution. The first factor consisted of the two HSI items (TTFC and cigarettes smoked per day [CPD]) and the *DSM-IV* Tolerance item (largest number of cigarettes smoked in a single day). The second factor consisted of DSM items concerning withdrawal, smoking more than intended, experiencing difficulty

quitting, and smoking despite physical or psychological problems. Again, the first factor extracted reflects the heaviness and pervasiveness of smoking. It is notable that the TTFC item loaded more highly on the first factor than on the second factor, upon which the withdrawal item loaded. This suggests that the TTFC item reflects a pattern of heavy smoking rather than severe withdrawal after overnight abstinence. These results are consistent with results obtained when FTND items are factor analyzed (results discussed earlier). That is, the principal component of such items is consistent with a pattern of heavy, pervasive smoking, and the TTFC item tends to load on this first factor.^{8,13} Research using multidimensional scales sheds additional light on these findings (discussed below).

Other research using distal instruments has yielded similar findings, with items reflecting heavy use constituting an initial factor explaining the majority of variance in the set of items or instruments,³⁸ while secondary factors reflect variance related to withdrawal severity, instrumental reasons for smoking (e.g., to suppress withdrawal), or an inability to quit. Although there is some variability in the results of such factor analyses (e.g., the principal axis and maximum likelihood factor analytic solutions in Breteler and colleagues¹³), the bulk of research suggests that most of the variance in diagnostic criteria and the FTND is captured by items that reflect a pattern of heavy smoking.

There are various reasons that such a pattern of results might not be interesting or important. For instance, it may be that items reflecting smoking heaviness have the greatest representation on the factor-analyzed⁹³ instruments, and this accounts for their high loadings on the initial factors. Or, it may be that items asking about smoking heaviness or pervasiveness are simply easier for smokers to answer than are other items, and therefore, they can be answered with relatively little error. This

might occur because such items have some fairly discrete referents (e.g., number of cigarettes smoked per day, time of day of initial smoking). However, while relative saturation of true score variance may account for relatively high levels of covariance among such items, such an effect, by itself, could not account for the substantial evidence that items that tap smoking pervasiveness and heaviness have impressively strong and consistent relations with some critical dependence criteria and also appear to reflect dispositions that are highly heritable.

The two items making up the HSI, in particular, have shown impressive relations with a host of behavioral and biochemical measures that reflect smoking heaviness.^{4,5,7,26,93} Interestingly, these items have also been more consistently predictive of the ability to quit smoking than perhaps any other set of dependence measures.¹⁸ For instance, in a Transdisciplinary Tobacco Use Research Center (TTURC) paper,¹⁸ the TTFC item in the FTND was shown to be superior to multiple alternative measures in predicting the likelihood of successful cessation. In fact, this item showed greater predictive validity than any instrument with which it was compared (e.g., the NDSS and its subscales, the WISDM and its subscales, and the FTND total score and any other single item from that scale). Interestingly, the TTFC item predicted relapse vulnerability better than did biochemical measures of smoke exposure such as CO, suggesting that it may reflect behavioral and motivational components of self-administration not entirely captured by drug dose delivered per se. These findings on the TTFC are impressive in that they were demonstrated in multiple clinical samples. In addition, this item was shown to predict cessation likelihood in population samples gathered in four different countries.¹⁸ While there is substantial evidence that the TTFC item is consistently predictive of quitting likelihood, there is also substantial evidence that *both* items of the HSI have impressive predictive

3. The Nicotine-Dependence Phenotype

validities, relative to other instruments, for both cessation likelihood and indices of tobacco consumption.^{3,7,8,26}

There is also substantial evidence that measures of smoking heaviness are highly heritable. For instance, in a study by Lessov and colleagues,⁹² items that loaded most highly on the first factor (*DSM-IV* Tolerance, TTFC, and CPD) had somewhat higher heritability estimates (additive genetic effects: variance components = .68–.73 as estimated via the *univariate* model) than did the other items. In addition, a later paper by Haberstick and colleagues estimated heritability coefficients for the FTND, the HSI, and individual items on those scales.⁹⁴ The sample comprised 1,154 young adults between 18 and 25 years of age who were from full-sibling, half-sibling, and twin pairs. Multivariate modeling revealed a highly heritable factor (76%), the strongest salient of which was time to first cigarette in the morning (i.e., TTFC). The HSI also generated a substantial heritability estimate (61%). These estimates agree with those generated by other studies.⁸⁸ Haberstick and colleagues⁹⁴ conclude that the TTFC item assesses an “urgency” to smoke throughout the day and is the “single best measure in the FTND for examining the genetic contributions to nicotine dependence.”^{94(p663)}

Therefore, the evidence suggests that items that tap heavy and pervasive smoking—for instance, smoking that begins perforce as soon as the individual awakens—assess a core feature of nicotine dependence, one that is highly heritable. This conclusion is buttressed by additional research, reviewed below, that uses the newly developed multifactorial measures of nicotine dependence. Thus, these measures appear to be serving one of the functions for which they were designed—that is, elucidating the nature of dependence.

As noted previously, the TTURC paper¹⁸ showed that the TTFC item was significantly related to both cigarettes smoked per day

and to relapse likelihood. In addition, this research showed that this item was highly correlated with a small number of subscales from the WISDM and NDSS nicotine dependence questionnaires. In particular, the TTFC was related to the Tolerance and Automaticity subscales from the WISDM and the Stereotypy subscale from the NDSS. These subscales appear to assess a pattern of smoking that is heavy and pervasive (fairly continuous across time and context) and that has become highly ingrained or automatic (i.e., does not involve conscious cognitive control).

It is interesting that the scales so highly correlated with the TTFC item are those that measure characteristic “late-emergent” dependence motives⁵⁰; that is, light smokers are relatively less likely to endorse these motives, relative to other sorts of motives (e.g., smoking for taste, smoking in response to environmental cues) than are heavy smokers. Figure 3.4 depicts the different logit curves reflecting scores on two WISDM subscales, Tolerance and Social/Environmental Goads, relative to cigarettes smoked per month. (The term *late emergent* refers to appearance across the continuum of smoking heaviness; these data may not reflect the order of emergence across time, because the data are cross-sectional and do not permit strong inferences about developmental patterns.) It is clear that the Tolerance subscale is relatively insensitive to light amounts of smoking but that scores increase exponentially at high smoking rates. (The Automaticity subscale showed a similar ogive pattern.⁵⁰) This suggests that items that tap a pervasive smoking pattern or tendency are particularly sensitive to high levels of smoking.

Latent profile modeling with the WISDM suggests that smoking that is heavy, pervasive, and automatic may be both necessary and sufficient for significant nicotine dependence. Across four separate samples of smokers, the WISDM

Figure 3.4 Logistic Regression Curves Predicting Scores on the WISDM Subscales from Cigarettes Smoked per Month: Examples of an Early-Emergent Motive (Social/Environmental Goals) and a Late-Emergent Motive (Tolerance)

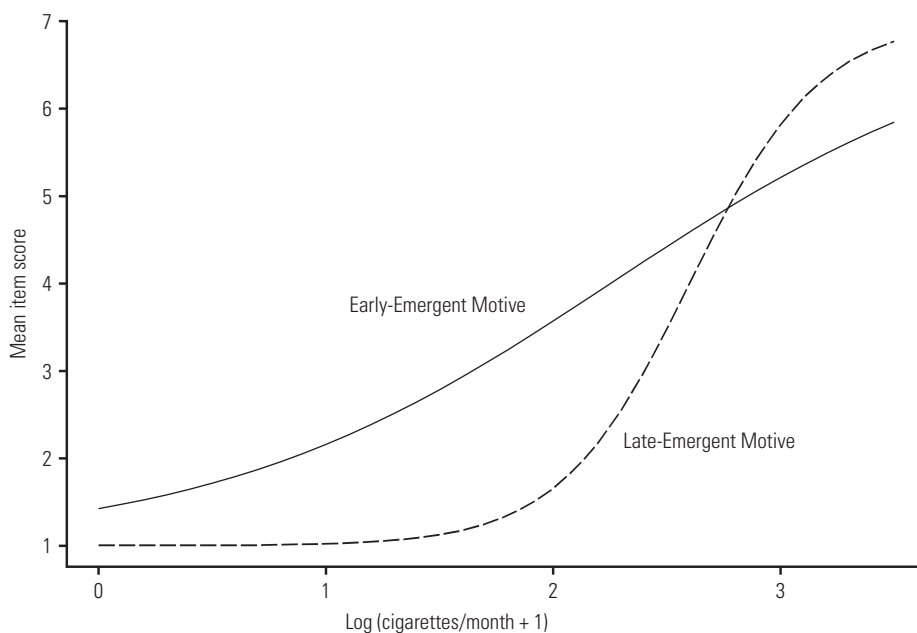

Note. This figure illustrates the different curves of the early-emergent motives and late-emergent motives, using the Social/Environmental Goals and Tolerance scales as prototypes of each motive, respectively. The early emergent motive has a higher intercept at low rates of smoking than does the late-emergent motive and has consistent linear growth as smoking rates increase. The late-emergent motive is not endorsed by light smokers but as smoking rates increase, there is an exponential increase in the rate of endorsement. WISDM = Wisconsin Inventory of Smoking Dependence Motives.

Automaticity, Tolerance, Craving, and Loss of Control subscales (table 3.1) characterized a unique smoker profile.⁹⁵ Some smokers had high scores on only these four subscales (figure 3.5). All other smokers showed subscale elevations that were of relatively equal magnitude across the subscale types. The results show that no group of smokers was significantly dependent without having elevations on these four subscales. Piper and colleagues,⁹⁵ therefore, labeled these subscales as “primary smoking motives scales.”

The latent profile analysis discussed above constitutes a person-centered analysis that highlights subscales that may be necessary for significant dependence development.

However, these results, by themselves, do not flesh out the construct validity of the amalgam of these subscales as a synthetic assay of nicotine dependence. To do this, Piper and colleagues⁹⁵ conducted variable-centered analyses in which status on the four primary motives scales was related to meaningful indices of nicotine dependence (see Muthén⁹⁶ for a discussion of the blending of person- and variable-centered approaches). The ability of these scales to predict these dependence criteria was compared to the predictive validities of the other WISDM subscales (labeled the “secondary motives” scales). Specifically, the relative predictive validities of each set of subscales were established.⁹⁵ It was then determined whether the secondary dependence motives

3. The Nicotine-Dependence Phenotype

Figure 3.5 Latent Class Results from the Combined Data Set

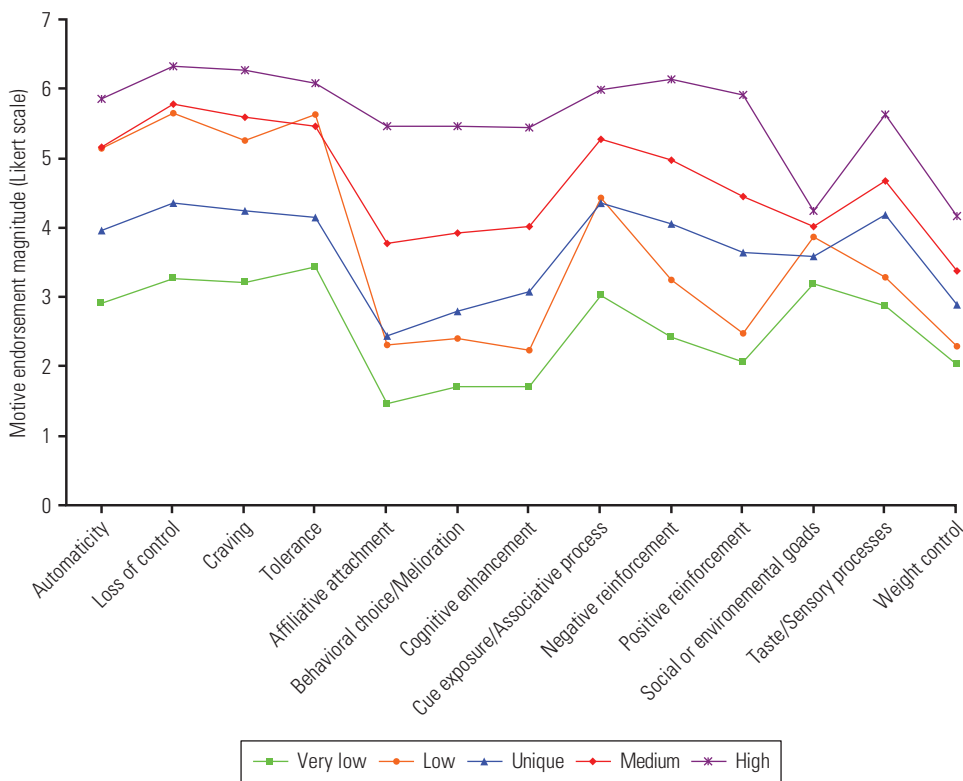

Note. The profiles generated via latent profile analyses of some 2,256 smokers from different data sets that contained both treatment seekers and general smoker populations. The same basic profile patterns were present in all four samples of smokers when they were analyzed separately.

could account for significant variance in dependence criteria once the primary motives scales were entered into regression models.

These variable-centered analyses indicate that a limited subset of WISDM subscales, the primary motives scales, carry the lion's share of predictive validity regarding nicotine dependence. The primary dependence motives scales (Automaticity, Craving, Loss of Control, and Tolerance), by themselves, were highly predictive of such important dependence criteria as ability to maintain abstinence, scores on other dependence measures (i.e., the FTND), smoking heaviness (i.e., cigarettes smoked per day, baseline CO), smoking history

(i.e., age of initiation, age of daily smoking, number of previous quit attempts), and the magnitude of the increase in craving that occurred immediately postquit.⁹⁵

The relative validity of these scales versus the secondary scales can be gauged from analyses in which the mean score for the primary dependence motives was entered into prediction models along with the mean score for secondary motives. Such analyses revealed that the predictive validity of the primary dependence motives scales was little affected by the addition of the secondary scale composite in the models. To an impressive degree, the primary scales remained consistently predictive of the dependence criteria in the multivariate

models, while the predictive relations of the secondary scales became weak or anomalous (negatively related to criteria). Finally, it is important to note that these four primary motives scales are highly coherent, with an average intercorrelation of about $r = 0.77$. Ironically, the multidimensional instruments might have contributed to the overall understanding of dependence by illuminating the “final common pathway” of dependence, rather than by assessing subphenotypes.

The notion that heavy, automatic smoking is indicative of dependence fits with other data in the field and is in accord with the view that, as dependence becomes entrenched, control over smoking is shifted from cognitive-control systems to automatic motor-control systems that execute self-administration without such control and, perhaps, without awareness.^{18,58,62} Thus, as smoking becomes ubiquitous and automatic, smokers may believe that it has become noncontingent with instrumental uses.^{13,97,98} Considerable basic behavioral and neuropharmacological research supports the notion that dependence involves a shift from instrumental, goal-driven behavior to automatized, habitual response patterns. As Everitt and Robbins⁹⁹ note in an influential review in 2005:

In theoretical terms, it seems reasonable to characterize such compulsive behavior as a maladaptive stimulus-response habit in which the ultimate goal of the behavior has been devalued so that the behavior is not directly under the control of the goal.... Rather, responding is governed by a succession of discriminative stimuli, which also function—when they are presented as a consequence of instrumental responses—as conditioned reinforcers. Hypothetically, such stimulus-response associative (‘habit’) learning occurs in parallel with instrumental action-outcome learning but, with extended training, eventually dominates behavioral output.^{99(p1485)}

Thus, smokers with this unique profile may represent highly dependent individuals in whom this process is more advanced or who are simply more aware of its occurrence (and therefore, rate secondary motives relatively low).

The Craving subscale of the WISDM was identified as one of the primary dependence motives. This is compatible with the notion that as addictive behavior becomes automatic, urges are caused by blockade of the automatized drug self-administration sequence.^{58,62} That is, the co-occurrence of strong craving and high levels of automaticity is supported by theory that links the two constructs mechanistically.

Another source of evidence further buttresses the notion that a pervasive pattern of heavy smoking indexes dependence. A study by Goedeker and Tiffany¹⁰⁰ used taxometric procedures to determine whether nicotine dependence constitutes a taxon (best conceptualized as a category of individuals qualitatively different from other individuals) or a continuum in which individuals lie on a relatively continuous range. The authors used data from the 2003 National Survey on Drug Use and Health ($N = 11,441$) and employed multiple criteria to assess the structure of dependence. The results supported the notion that nicotine dependence can be viewed as a taxon—a qualitatively discrete category. Approximately 48% of those smoking in the last 30 days belonged to this taxon, and members of this taxon were characterized by high scores on the FTND TTFC question (smoking relatively soon after awakening), by smoking a large number of cigarettes per day, and by high scores on three of the NDSS subscales: Drive, Continuity, and Tolerance. Drive taps craving intensity; Continuity taps smoking patterns that are consistent over time—that is, patterns that show little variation due to situational or temporal factors; and Tolerance assesses the tendency

or ability to smoke heavily without adverse impact. Thus, the taxon appears to be distinguished by measures that tap the same sorts of constructs that characterize the necessary and sufficient features of dependence as revealed in the latent profile research (i.e., the primary dependence motives)⁹⁵ and that are effective at predicting relapse.^{18,95} Thus, the hypothesized taxon is characterized by smoking that is heavy and pervasive throughout the day and by strong urges.

Additional evidence also supports the fundamental relation between a pervasive drug-use pattern and dependence. For example, Shiffman and Paty¹⁰¹ found that chippers (those who have established a stable pattern of infrequent smoking) and heavy smokers are distinguished by the fact that the former evidence smoking that is contextually discriminated, whereas the latter show patterns that are relatively heavy and invariant across time and place. In addition, as noted earlier, examination of posterior probabilities generated by latent class analyses show that items that assess pervasive, heavy smoking tend to distinguish classes that are highest in dependence.^{34,39,102}

The reviewed research suggests that the highly dependent person is *not* best distinguished by endorsements of smoking as a means of controlling affect, reducing withdrawal, experiencing a “high,” or controlling weight.^{18,95} This perspective meshes nicely with a great deal of behavioral animal research that shows that early in the course of drug self-administration the organism’s behavior is highly affected by the potency of the reinforcer. However, with extensive drug self-administration experience, the animal’s behavior seems more stimulus driven and noncontingent with the reinforcer.^{103,104} The data from the latent profile study⁹⁵ suggest that some smokers may become aware of this noncontingency and can report on it.

The data from the TTFC paper,¹⁸ the taxometric paper,¹⁰⁰ and the latent profile studies⁹⁵ all suggest that dependence is characterized by smoking that is not highly discriminated on contextual and temporal cues. One possibility is that truly dependent smoking takes on a life of its own and proceeds without cueing. This, however, would fly in the face of a great deal of evidence that shows that cues can powerfully affect self-administration and other indices of drug motivation,⁵⁷ and it would contradict the notion that addictive behavior reflects strong stimulus-response mapping.¹⁰⁴ Instead, it seems much more likely that smoking is highly cue dependent, but that the cueing is often relatively inaccessible to awareness. This might occur because the cues are interoceptive (e.g., reflective of falling levels of drug in the body), or are exteroceptive, but the cue–self-administration response sequence has become proceduralized and unfolds with little awareness.^{57,58,62}

One of the roles of dependence assessments is to provide insight into the nature of dependence processes—insights that extend beyond those afforded by the direct assessment of dependence criteria *per se*⁴⁹ (figure 3.1). The review of the evidence presented above suggests that the use of multidimensional dependence scales may be achieving this goal by casting in greater relief those behaviors and motives that are most tightly linked to dependence criteria. It is clear that the distal measures implicated in dependence in the above research (e.g., the Automaticity and Tolerance subscales) do not truly assess underlying dependence processes *per se*, but they may serve as manifestations of such processes—for instance, implicating mechanisms such as the strengthening of stimulus-response mapping.

The above analysis suggests that existing distal measures that are especially sensitive to pervasive, automatic, and heavy

smoking probably tap processes of greater biological significance and relevance to dependence than do measures that tap social or functional consequences of smoking or an awareness of such consequences. Therefore, measures such as the FTND that more uniformly tap pervasive, heavy smoking (and presumably related scales from multidimensional instruments)^{97,98} should yield stronger and more informative genetic relations than does the collection of *DSM* criteria. Evidence from behavioral and molecular genetics studies is beginning to support this hypothesis.^{92,94,105–107}

Covariation Among Measures of Dependence

If it is indeed the case that nicotine dependence can be assessed reliably by a relatively coherent set of items, this does not explain the lack of consistent covariation among dependence measures that was noted above.^{26,33,49,98} This lack of covariation is likely to be caused by several factors. First, the various dependence indices were developed with guidance from very different conceptual models of dependence (see West³), and as the construct validation model makes clear (figure 3.1), different conceptual models will generate very different types of items. For instance, the model that guided the development of the *DSM* measures defined “dependence” as a socially defined phenomenon indexed by a collection of indicants that, together, reflect severity. It is an implicit assumption of this model that the features should not necessarily be highly coherent in that they are intended to convey additive, and not necessarily redundant, information that indexes extent of behavioral, functional, and social disruption. Thus, such measures were designed, in part, to reflect awareness of diverse types of social and functional disruption, which could be viewed as *criteria*, or socially important outcomes, of dependence, rather than dependence processes per se (figure 3.1). One reason

that criteria may have modest relations with measures of dependence mechanisms (e.g., selected subscales of the NDSS or WISDM) is that measures of social or functional disruption are highly dependent upon the social and life context of individuals and the functional demands placed upon them. And, interestingly, as West³ points out, the diagnostic items used in the *DSM* and other major diagnostic inventories were designed originally to diagnose other types of addictive disorders in which the drug leads to greater social and functional impairment. Thus, these items may be of limited use in assessing mechanisms of tobacco dependence.³ This means that very different sources of error and extraneous influences likely affect criterion measures than affect core dependence measures—for example, patterns, types, and intensities of smoking.

The same principle applies to other criteria such as relapse. It should be of no surprise that there are inconsistent or modest relations between dependence measures and relapse likelihood in that relapse likelihood is strongly related to such variables as whether smoking is permitted in the home, the educational and income status of the individual, and the density of smoking cues in the person’s environment.^{18,108–111} Similarly, dependence measures often show modest relations with withdrawal severity.^{112–114} Withdrawal severity has been shown to reflect such environmental features as the presence of smoking cues.¹¹⁵ Many criteria measures are highly sensitive to contextual influences but are also necessary to make inferences about the construct validity of any dependence measure (figure 3.1). This raises questions about how to distill variance within criteria so they are maximally sensitive to biological or genetic influences and how to model dependence in the face of modest intercorrelations among the criteria.

There are other reasons that dependence measures may show modest relations

with one another. For instance, some measures may be more sensitive to dependence at different periods or intensities in its development.^{49,116,117} This is consistent with evidence that dependence items show different patterns of endorsement across different latent classes that are organized along an intensity dimension;^{102,118–120} that is, some types of items are more sensitive to low versus high levels of dependence, and other items are more sensitive to severe dependence. Thus, disagreement might be attributed to differences in the “difficulty level” of an item.¹²

Integrating Phenotypic Measures with Analytic Strategies

Selecting good measures of the phenotype is just one step in examining the relation between the phenotype and genetic variants (single nucleotide polymorphisms, alleles). One must decide how to use such measures so they sensitively capture differences among individuals in terms of nicotine dependence. This demands an integration of both theoretical and psychometric considerations.¹²

One strategy often used in genetics research is the construction or selection of groups that are intended to be maximally dissimilar in possession of targeted genetic variants. Ideally, one attempts to construct groups on the basis of phenotypic features, so one group has all the genetic influences that promote a disorder, while the other group has none (an “extreme” groups approach).

The information reviewed above suggests strategies that might be used to construct such groups. For example, it suggests that a group possessing the genetic complement for nicotine dependence should show high scores on the scales and items that reflect heavy, pervasive, automatic smoking (table 3.2). A critical question is whether the investigator needs to use additional criteria to determine membership in this group. For instance, the investigator must decide whether to make membership or nonmembership contingent upon factors such as additional dependence dimensions (in addition to the primary dependence features discussed above), the presence of person factors associated with type or severity of dependence (psychiatric comorbidity, gender), and factors that

Table 3.2 Dimensions on Which Groups Might Be Constructed to Contrast Putative High- and Low-Dependence Predispositions

High genetic proneness	Low genetic proneness
<ul style="list-style-type: none"> ▪ Smokes within 30 minutes of awakening ▪ Lifetime peak smoking >20 CPD ▪ Severe withdrawal upon reducing or quitting smoking ▪ Reports great difficulty in quitting/failure to quit in multiple attempts ▪ Daily smoker for at least 20 years ▪ High scores on WISDM subscales: Loss of Control, Automaticity, Tolerance, Craving ▪ High scores on NDSS subscales: Tolerance, Continuity, Drive 	<ul style="list-style-type: none"> ▪ Smokes after 30 minutes of awakening ▪ Lifetime peak smoking <15 CPD ▪ Mild or no withdrawal upon reducing or quitting smoking ▪ Reports ease of quitting in few attempts/successful long-term abstinence ▪ Initiated smoking before the age of 16 years ▪ Smoked daily for at least 1 year ▪ Currently a nonsmoker for at least 2 years ▪ Low scores on WISDM subscales: Loss of Control, Automaticity, Tolerance, Craving ▪ Low scores on NDSS subscales: Tolerance, Continuity, Drive

Note. CPD = cigarettes smoked per day; WISDM = Wisconsin Inventory of Smoking Dependence Motives; NDSS = Nicotine Dependence Syndrome Scale.

might moderate the relation of genetic variants with phenotypes.

Assessment of Complementary Dimensions of Dependence

Considerable evidence attests to the centrality of the primary smoking factors that have been highlighted (pervasive, automatic, and heavy smoking). In keeping with this, it may be beneficial to supplement the measures listed in table 3.2 with some additional measures that tap the same construct to achieve a more reliable index of this central construct. Thus, one might use biochemical measures of self-administration (serum cotinine levels), metabolic tolerance or clearance,¹²¹ and perhaps, laboratory measures of the automaticity of information processing related to self-administration and related constructs.⁵⁸

In addition, there may be some value in including other dependence characteristics to supplement the assays of primary factors. Ideally, one would wish to select assessments that are associated with fairly severe dependence and that are fairly highly heritable. Further, it seems best to select assays that are not highly infused with error. The considerations listed above suggest at least two types of measures that might be combined with measures of the *primary* or *core factors* to yield groups extreme across the breadth of the nicotine-dependence measurement domain—namely, measures that tap difficulty or inability to cut down or quit (control) smoking and severity of withdrawal symptoms (e.g., related *DSM*-type items). Including assessments of withdrawal and ability to cut down or stop among phenotypic measures is supported by three considerations: (1) Items tapping these factors are conceptually and psychometrically distinct from measures of smoking heaviness and pervasiveness (core features). For instance, they tend to load on different factors than do items measuring the primary factors.^{39,92} In fact,

the evidence is compelling that while measures of smoking heaviness and pervasiveness do account for variance in withdrawal severity and quitting ability, much of the variance in these criteria is orthogonal to heaviness indices.^{46,49} If these dependence criteria are critical to the construct, they should be reflected in group composition. (2) Items tapping ability to quit or cut down and tapping withdrawal severity tend to show high levels of endorsement by the most dependent smokers as revealed by latent class analyses.^{39,92,102} (3) At least with regard to global ratings of withdrawal intensity, there is evidence of only partial overlap with the heritability of items that measure the primary dependence factors.^{34,122,123} Therefore, the inclusion of such criteria for extreme group membership (i.e., ratings of ability to cut down or quit and withdrawal measures) might permit a more comprehensive gleaning of dependence-relevant genetic variants. The addition of measures of withdrawal and ability to cut down or stop smoking means that the criteria for extreme group membership would assess the five nicotine-dependence symptoms that Lessov and colleagues⁹² found had “high phenotypic and genetic factor loadings as well as high heritability: tolerance, time to first cigarette in the morning, number of cigarettes smoked per day, withdrawal, and difficulty quitting.”^{92(p875)} Moreover, items tapping these dimensions would correspond to the dimensions that Furberg and colleagues¹²⁴ identified as distinguishing latent classes of regular cigarette smokers: smoking heaviness and latency to smoke upon awakening, difficulty or inability to cut down or quit smoking, and severity of withdrawal symptoms.

Consideration of Person Factors

It is clear that smokers are a heterogeneous group. Moreover, some individual differences or person factors (stable traits), other than nicotine dependence per se, might reflect

a different type or severity of nicotine dependence. Do such differences have implications for genetic mapping? Might such factors be relevant to assessing the nicotine-dependence phenotype or suggest particular genetic targets for association with phenotypes? For example, phenotype measures could be modified to target the assessment of such person factors. Or, a researcher could take such person factors into account when constructing extreme groups. Thus, questions relating to person factors really speak to the notion of whether such factors organize types of nicotine dependence.

It is tempting to imagine that psychiatric comorbidity may reflect affective or motivational processes that create protean complexity in the nature or structure of nicotine dependence. There is certainly evidence that comorbidity affects the manifestation of nicotine dependence (hence its influence on nicotine dependence as depicted in figure 3.1). For example, nicotine dependence is highly comorbid with other psychiatric disorders. Rates of current alcohol abuse or dependence, mood disorder, anxiety disorder, or personality disorder are two to three times more prevalent among smokers than among nonsmokers.^{35,43} Not only are psychiatric comorbidities more common among smokers, but also smoking and nicotine dependence are also especially prevalent among those with such comorbidities.^{35,43,125,126} Thus, a person with a psychiatric disorder is much more likely to have nicotine dependence, and vice versa.

In addition, some data suggest that the presence of comorbidity not only indexes an increased likelihood of nicotine dependence but also a more severe form. For example, data show that smokers with psychiatric comorbidities smoke a disproportionately large number of cigarettes given their prevalence in the population,³⁵ suggesting heavier smoking among those with comorbidities. Further, analytic strategies

such as latent class analysis show that the presence of comorbidities helps define the classes that generate the most extreme scores on nicotine-dependence assays.^{21,35,43,102,127} Finally, there is evidence of substantial shared genetic influence on the regular use of tobacco and alcohol and on dependence on both substances.^{77,128,129}

Despite all the evidence linking externalizing disorders with nicotine dependence, there is little evidence that nicotine-dependence assessments, or construction of extreme groups, should be modified on the basis of comorbidity. Moreover, there are reasons for assuming that while comorbidity is associated with dependence severity, it does not index a qualitatively distinct subtype of dependence. In other words, even if such comorbidity affects the severity of dependence, this effect is captured by standard dependence assays. This is suggested by the studies showing that standard dependence measures are sensitive to comorbidity-linked increases in dependence.^{35,102} In addition, as noted earlier, some evidence suggests that personality dimensions associated with comorbidity are more tightly linked with smoking *initiation* than with severity of nicotine dependence.^{60,82,130,131} Thus, personality could affect exposure to environmental factors related to initiation (e.g., peers).^{132–137} Finally, individuals with no comorbidity become nicotine dependent. The goal of phenotypic refinement in the pursuit of genetic correlates dictates that investigators focus on phenotypic features that are necessary or sufficient, and psychiatric comorbidity is neither.

If psychiatric comorbidities are not intrinsic to dependence and do not organize meaningful nicotine-dependence taxa, what might explain the associations between comorbidity and nicotine-dependence measures? The available evidence makes various causal relations possible. It is possible that a personality dimension

such as behavioral undercontrol, which is associated with externalizing disorders and traits of risk-taking and impulsivity, increases the likelihood of initiating the use of diverse substances. Such traits may also increase exposure to environmental factors such as availability, modeling, and other peer group influences. Such environmental influences could account for why comorbidities seem to be associated with a particularly severe form of nicotine dependence.^{21,35,43,102,127} That is, the genetic diathesis for personality and/or comorbidity would influence initiation of nicotine use and, in addition, might yield environmental exposures that foster greater nicotine use over the lifetime (e.g., poor educational achievement, socializing with smoking or substance-using peers); hence, an active gene-environment correlation may be at work. It is, of course, possible that while psychopathology and associated personality dimensions do not produce different types of nicotine dependence, other factors do. For instance, there is evidence that gender interacts with nicotine-use motivation such that men tend to smoke more for nicotine receipt per se but women smoke more for nonpharmacological factors.¹³⁸ It may be that taste and correlated environmental factors have been rendered more reinforcing in women because of nicotine's ability to modulate incentive value.¹³⁹ Thus, it is possible that, among men, dependence phenotypes are more highly related to genes that influence direct pharmacological reinforcement. Among women, dependence may be more highly related to genes that influence incentive sensitization and related associative processes. At present, there is insufficient evidence to determine the relevance of such evidence for genetic mapping.⁹² Similarly, there is insufficient evidence, at present, to support tailored assessment on the basis of race.^{140,141} In sum, as opposed to the case of a disorder such as schizophrenia, for which there is some consensus that the diagnostic category comprises multiple distinct disorders, each

perhaps with unique genetic influences, it does not appear necessary at this point to try to target specific subtypes of severe nicotine dependence.

Preserving a Role for the Environment

Earlier, this chapter alluded to the important role of the environment in creating error in measures of nicotine dependence. For example, living in a home that has a smoking ban may cause one to smoke later in the day than would otherwise occur. This may bias TTFC items as measures of nicotine dependence.¹⁸ It is possible that such home smoking bans might ultimately reduce dependence, but this is merely a hypothesis, one that might require some time to unfold. Another example is smoking restrictions at work, which might reduce the number of cigarettes per day that individuals can smoke. Indeed, increasing environmental restrictions on smoking may affect the validity of inferences based upon all of the measures of heavy, pervasive, uniform, and automatic smoking that undergird the central core of available measures of nicotine dependence. In addition, the presence of smoking cues and cigarette availability might also lead to a greater likelihood of relapse to smoking in any given quit attempt. Researchers may take possible environmental influences into account in several ways. For instance, the investigator might use environmental features when constituting extreme groups, ensuring that members of both low- and high-dependence groups have few environmental restrictions on their smoking. Or, the researcher could use statistical procedures to perform partial variance in dependence assays. These options are discussed further below.

Environmental influences may play an additional role. Increasing attention is being directed at the notion that genetic variants may interact with environmental events or characteristics.¹⁴² Indeed, there

is evidence that such interactions may be relatively common. Moffitt and colleagues¹⁴³ list multiple examples in which the relation of genotype with the phenotype varied significantly as a function of some environmental factor.

In considering whether to pursue investigation of potential gene-environment interactions, it is important to consider whether there are good candidate environmental factors that significantly affect the disorder under study. Moffitt and colleagues¹⁴³ suggest that good candidates for environmental moderators, or risk factors (i.e., “environmental pathogens”), are variables that exert significant main effects on the disease severity or occurrence. This principle suggests numerous environmental factors that might moderate gene-environment interactions—for example, early exposure to smoking peers, chronic environmental stress/poverty, intrauterine exposure to nicotine, traumatic stress such as childhood or adolescent sexual assault/abuse, and alcohol intake.^{60,142,144} Thus, intrauterine, developmental, and adult-onset events, both episodic and chronic, could serve as pathogens.

One candidate moderator of particular interest is age of onset of significant nicotine exposure. There is substantial evidence for a sensitive developmental period after which tobacco exposure is relatively unlikely to yield nicotine dependence. Human research shows that an early onset of smoking is associated with greater consumption of cigarettes in adulthood,^{145–148} a relative inability to quit smoking,^{28,145,149,150} and a more severe form of nicotine dependence.^{34,102,151–153} Animal research shows that nicotine exposure during adolescence induces long-lasting biochemical, anatomical, physiological, and behavioral changes that differ markedly from those seen with adult exposure.^{154–157} In addition, adolescence is both a period

of heightened sensitivity to nicotine’s rewarding actions and a period of decreased sensitivity to nicotine’s aversive actions.^{158–162} Evidence suggests that adolescent exposure in rats results in increased nicotine self-administration that persists into adulthood.¹⁶³ Therefore, it is possible that genetic variants for nicotine dependence will become much more strongly associated with nicotine-dependence phenotypes among those individuals with early, rather than late, exposure (perhaps smoking before versus after 16 years of age).³⁴ In fact, later research shows a significant interaction between haplotypes of the *CHRNA5-A3-B4* subunit cluster and age of smoking onset, such that there are strong associations between haplotypes and a rather comprehensive set of dependence measures, including the FTND, WISDM, and relapse latency.^{164,165}

It is possible that a variable might not produce a significant main effect on nicotine-dependence measures but could still produce significant moderation (e.g., if the pathogen were active in the presence of a relatively rare allele/genotype). Therefore, one should also assess and test pathogens that are substantively important. For example, some theories emphasize the importance of stress as an important modulator of reinforcement via psychomotor stimulants,^{166,167} and other theories emphasize the role of peers, especially in terms of initiation.⁶⁰ In short, selection of candidate environmental variables in moderation models requires an examination of empirical evidence as well as theory.

Of course, moderated analyses include gene-pathogen relations as well as pathogen-phenotype relations. That is, one must decide not only which pathogen(s) to explore, but also which genetic variants would, in theory, affect behavioral or biological processes that are differentially affected by the pathogen. Therefore, one should have a model of the gene-pathogen relation that makes biological sense. Thus,

one advantage of testing moderated relations is that it forces one to think deeply about the potential causal links between genes, pathogens, and the phenotype.

Moffitt and colleagues¹⁴³ suggest a set of considerations to guide the selection of genetic variants (e.g., haplotypes, alleles) that might serve as good, independent variables in moderational models. For example, they note that candidate polymorphic variants should occur relatively frequently in the population. The notion is that if a gene exerted a powerful *main* effect on a significant disease process, its frequency would be suppressed because of decreased fitness (although it is unclear if risk for smoking would significantly decrease fitness). In addition, selection would be aided by evidence that the polymorphism has effects on brain systems relevant to a disorder and that it affects reactivity to the environmental pathogen/event under study. Thus, in the case of nicotine-dependence research, investigators using early exposure to tobacco as the environmental pathogen might study polymorphisms that are related to nicotine self-administration in animal research (chapter 4). Finally, the specificity of a particular gene-pathogen-disorder relation can be tested by systematic substitution of different polymorphisms and environmental pathogens into the analyses.

The study of moderation is compatible with the study of relatively specific mature subphenotypes. For example, moderated relations may pertain to only a subset of those with nicotine dependence; that is,

only a subpopulation *should* be affected by the targeted gene as a function of the environmental pathogen* (see table 3.3).

Thus far, researchers have not detected stable gene-environment interactions in molecular genetics investigations of nicotine dependence. There have been reports of an interaction between status on the serotonin transporter gene (*SLC6A4*) and neuroticism in the prediction of likelihood of being a smoker.^{168,169} However, as Lerman and colleagues¹⁶⁹ suggest, the interaction may be attributed to distinguishing between more and less highly heritable forms of neuroticism, or it may reflect epistatic effects. (See Kremer and colleagues¹⁷⁰ and Gerra and colleagues¹⁷¹ for further research on *5-HTTLPR* status and smoking.)

Findings of interactions would pose interpretive challenges.¹⁴³ For example, environmental exposures may appear to “cause” a phenotypic response, but the environmental exposure may occur because it is correlated with genes and therefore indexes only a third (genetic) variable effect. For example, reports of severe stress may reflect the presence of polymorphisms related to neuroticism. This possibility could be appraised by careful assessment of the phenotype before and after the occurrence of the stress or stressor.

There are other challenges to the evaluation of gene-environment interactions; principal among them is the appropriate measurement and modeling of the pathogen. Recall measures of environmental pathogens may be biased by a host of memory/recall

*Here, the reader may justifiably ask what is meant by a smoker “subpopulation” or mature subphenotype. This does not *necessarily* imply the existence of multiple taxa, that is, fundamentally different types of smokers in terms of dependence. Rather, the researcher might find that some smokers may differ qualitatively or quantitatively in the extent to which certain processes contribute or relate to dependence. However, these differences do not mean that core features or manifestations of dependence differ. For instance, smokers may differ in the extent to which they smoke for taste factors. However, despite this motivational difference, dependence per se could still be registered by standard dependence measures. Thus, smokers may differ in taste as a motive, and this may have a distinct genetic basis,⁵⁴ but the dependence of such smokers might still be captured well by the major distal phenotypic measures.

Table 3.3 Causal Paths from Genetic Variant to Distal Phenotypes

	Nicotine reward	Metabolic capacity	Taste/gustatory sensitivity	Incentive salience/sensitization	Cognitive control/impulsivity	Withdrawal	Affective control
Genetic variant candidates	<i>CHRNA2</i> <i>CHRNA7</i> <i>CHRNA5</i>	<i>CYP2D6</i> <i>CYP2A6</i> <i>CYP1A1</i>	<i>PTC</i>	<i>DRD2</i> <i>SLC6A3</i> <i>DRD4</i>	<i>MAOA/α4</i> subunit	$\alpha7$ subunit/ <i>GABA_A</i>	<i>SLC6A4</i>
Endophenotypic index candidates	Proteomic/expression patterns	Proteomic/expression patterns	Inability to taste bitter tastes	Enhanced nucleus accumbens activity to nondrug incentives	a. Behavioral Undercontrol b. P300 amplitude c. Poor Stroop test performance d. Attentional focus on dominant response e. Poor integration of caudal cingulate with amygdala (via fMRI)	Information processing performance after removal of an appetitive stimulus	a. Poor fear/anger extinction b. Internalizing symptoms upon stress exposure c. Poor subgenual cingulate-amygdala integration (via fMRI) d. Stronger urges in response to stress
Transitional/mature subphenotypes	a. Report of nicotine reward (“buzz,” “rush”) b. Rapid escalation of smoking upon initiation c. High self-administration rates	a. Rapid development of tolerance b. High self-administration rates	a. Taste motive for smoking	a. Strong nucleus accumbens response to nicotine anticipation	a. Rapid escalation of smoking upon initiation b. Externalizing comorbidity	Severe withdrawal symptoms upon drug abstinence	a. Relapse in response to stressors b. Smoking for stress relief
Distal phenotypes	a. Heavy, regular self-administration b. Withdrawal symptoms upon abstinence c. Tendency to relapse						

Note: fMRI = functional magnetic resonance imaging.

biases, and convenient self-report measures may not capture important temporal dynamics of such variables over time. In addition, one must decide at what age or developmental period the pathogen is most active. Furthermore, one must consider the latency between pathogen occurrence and its impact on the phenotype—addictive behavior tends to be relatively refractory over many years. This must be considered when trying to model the time course via which a pathogen might affect nicotine-dependence markers and at what etiologic stages such effects would be manifest. Although relapse latency might be reactive to a phasic environmental event, other markers of nicotine dependence might be relatively refractory. Moreover, Moffitt and colleagues¹⁴³ note that some pathogens exert cumulative effects^{172,173}—for example, living with a smoker. In sum, modeling the potential effects of a pathogen on nicotine dependence requires consideration of developmental period, etiologic period, the dose of pathogen needed to exert effects, the latency between pathogen exposure and disease end points, and which particular phenotypic features will be affected by the pathogen.

Improving Distal Measures

Earlier, this chapter reviewed evidence suggesting that existing distal measures have considerable potential in genetic mapping research. However, it is important that investigators be aware of the limitations of these measures. Such limitations not only should foster caution in drawing strong inferences regarding underlying mechanisms but should also serve as prods for the development of new phenotypic assessment strategies.

Although the reviewed data suggest some phenotype measures to use in future genetics research, restricting phenotypic measures to *DSM* and FTND items could significantly handicap researchers.

For example, use of a single item to measure withdrawal severity captures an impoverished domain of targeted constructs (e.g., *DSM*-type withdrawal items do not assess different types of withdrawal symptoms, such as urges and hunger). Also, different withdrawal symptoms show very different profiles or trajectories over time.¹⁷⁴ It is unlikely that global, temporally remote, single-item, self-report measures of withdrawal can capture the distinct dynamic patterns of withdrawal over time—patterns that account for differential likelihood of relapse.¹¹⁵ Further, at present, all of the commonly used distal measures rely upon self-report, and this assessment strategy may be influenced by broad attitudes and verbal resemblances that have little to do with the biological or genetic underpinnings of dependence. Moreover, diagnostic criteria, and similar sorts of categorical items, were not designed to possess optimal scale properties or to covary highly to achieve internal consistency. In addition, if used as a categorical diagnostic index, the *DSM* generates outcomes that do not agree with empirically based methods of nicotine-dependence classification such as latent class analysis. For example, a factor mixture analysis³⁹ did not correspond well with the scoring rules for dependence as specified in the *DSM-IV* (i.e., three of seven dependence symptoms must be endorsed). Many individuals placed in the highest class of dependence via factor mixture analysis did not satisfy the *DSM* threshold for dependence. (See Storr and colleagues¹⁹ with respect to correspondence between latent class analysis and FTND classifications of smokers.)

Thus, commonly used nicotine-dependence measures have clear limitations, which, in theory, should limit their effective use in genetic mapping. There are clearly opportunities for new approaches to dependence assessment. Obviously, one approach would be to develop superior measures of the same constructs.

For instance, it is by no means clear that the wording and structure of existing items are ideal for genetics research. Future research should attempt to improve upon the existing dependence items by examining issues such as whether their response options are ideal and whether the questions are posed at the proper “difficulty level.” It is also possible that some of the newer multidimensional dependence instruments might be psychometrically superior to the critical *DSM* and *FTND* items and assess the same or similar constructs.

Another strategy would be to make greater use of behavioral measures. For instance, one strategy would be to relate genetic variants to withdrawal data recorded via ecological momentary assessment methods or to laboratory measures such as compensatory behavior in response to nicotine restriction. These strategies seem to offer clear advantages. Behavioral measures tend to be face valid (their significance requires little inference), can be measured with precision, and should be relatively free of certain self-report biases (e.g., response styles).

Although the direct assessment of behavior or criteria has potential, it is not yet known whether this approach will be superior or inferior to the collection of general, synthetic, and impressionistic measures of withdrawal, or ability to quit smoking, and so on. For instance, measures of a single episode of withdrawal might overweight the idiosyncratic events affecting that quit attempt episode. Thus, the more impressionistic, global measure might provide a better synthesis of withdrawal across time and a better index of the attendant subjective distress. In addition, some evidence suggests that some temporally remote assessments of smoking and dependence can be surprisingly accurate and reliable.^{175,176} Thus, while complex behavioral or laboratory measures hold promise, they remain undelivered

promissory notes. Perhaps the optimal behavioral assays of nicotine dependence would require collection of data over long periods of time, permitting the statistical synthesis of data gathered across repeated episodes of cessation attempts and withdrawal. This would also permit extensive behavioral assessment of the heaviness or situational pervasiveness of smoking (e.g., time blocks per day in which no smoking occurs, average inter-cigarette interval, extent to which smoking is cue contingent), perhaps via ecological momentary assessment.¹⁷⁷

Concerns about the sensitivity of phenotypic measures to underlying biology anticipate issues to be addressed in later sections of this chapter that deal with the assessments of intermediate phenotypes—that is, more focal and specific measures of nicotine dependence.

A Summary of Inferences from Distal Measures Research

The picture of nicotine dependence emerging from the reviewed research is reflected in a fairly coherent set of core features: smoking is heavy and pervasive across time and place, occurs without significant cognitive control, and is related to strong urges. Although such features appear to constitute core, relatively coherent elements, dependence also seems to be reflected in somewhat distinct complementary factors. In particular, withdrawal severity and an inability to quit or cut down on nicotine or tobacco use seem to be important in this regard. Certainly, other constructs are related to dependence and predict dependence criteria. For instance, smoking for taste reasons (e.g., as assessed by the *WISDM Taste/Sensory Processes* subscale) is significantly related to dependence measures and to the likelihood of smoking.⁵⁴ Yet, research does not suggest that such factors are necessary or sufficient for severe dependence.^{54,95}

Such assessments may, in fact, reflect “upstream” vulnerabilities to initiate or escalate smoking (figure 3.2), but they do not strongly determine variance in “downstream” levels of severity.

New Directions for Phenotypic Research: Beyond Distal Measures

The measures discussed above are all “distal” measures—that is, measures reflecting dependence indices that are likely causally remote from the biological processes activated by relevant genetic variants (figure 3.2). As figure 3.2 makes clear, mature dependence phenotypes may, as implied by the developmental concept of equifinality, constitute one or more rather homogeneous outcomes of diverse etiologic paths. The use of distal measures may limit and distort the appraisal of nicotine dependence for a variety of reasons.

It is possible that many of the conclusions adopted in the earlier discussion are largely a product of the measures available to us. For instance, the evidence that nicotine dependence can be well modeled by a dimension of heavy, pervasive smoking may be due, in part, to the global and categorical nature of distal measures. If measures are employed that reflect specific candidate biological pathways to nicotine dependence, it is possible that our view of nicotine dependence might change. For example, as figure 3.2 depicts, there may be diverse genetically influenced factors that promote and permit tobacco use, and these ultimately summate to yield nicotine dependence. It is conceivable that different specific (ontogenetic) pathways are more meaningful for some individuals than for others. For example, one person’s heavy smoking might be driven by rapid nicotine metabolism,

whereas another person’s might be driven by strong dopaminergic response in brain incentive structures. “Downstream,” or distal, measures might not be sensitive to differences in such discrete pathways. An often used analogy is the case of a car (or clock) that will not run. General distal measures (e.g., lack of motion, lack of exhaust) will provide superficial evidence that something is wrong. However, more focused measures that are sensitive to particular mechanical pathways are needed to detect specific causal mechanisms. Thus, it may be that phenotypic measures targeted at specific biological pathways are needed to produce a group of smokers who share (are homogeneous for) a particular genetically mediated vulnerability to nicotine dependence. In theory, multidimensional dependence assessments such as the NDSS or WISDM might serve this need. However, such measures may inadequately target particular biological systems. Indeed, an exclusive reliance on self-report may preclude precise targeting. Finally, it may be the case that comprehensive characterization of the phenotype requires a developmental research strategy; that is, a richer portrayal of the phenotype may emerge from measures gathered across ontogeny (figures 3.2 and 3.3).

The above reasons, and others, encourage the use of phenotypic measures that are sensitive to specific causal pathways—pathways that are, in theory, more proximal to the biological effects of the polymorphisms under study and that are used in a developmentally informed manner. Dissatisfaction with global distal measures, and the desire to assess genetic risk across the development of disorders, have led to the assessment of intermediate phenotypes, or endophenotypes (see below).

A basic assumption of the endophenotypic approach is that genetic influences

will be more straightforward, and less complex, when the phenotype is relatively circumscribed (e.g., involving relatively few biological systems or processes), which should clarify the contributing genetic architecture. In addition, the endophenotype should be manifest relatively early in the causal chain leading to the syndrome of interest (it should be causally “upstream”; figure 3.2). The latter feature should enhance penetrance and, therefore, result in a stronger genetic signal. At the end of this section, some potential risks of the endophenotypic approach are reviewed. It is conceivable that mapping distal phenotypes could, under some circumstances, constitute a more efficient research strategy.

It is clear that genes do not encode for psychopathological syndromes or symptoms per se; however, they do encode for less complex biological and behavioral processes. Diseases or syndromes that affect multiple, diverse organ systems seem more likely to be affected by numerous causal influences, including genetic influences. Moreover, it also seems likely that as the number of genetic influences increases, so does the possibility of heterogeneity *across persons* in such influences. Measuring a distal outcome such as number of cigarettes smoked per day might obscure individual variation in phenotypic differences and genetic influences.

In short, using proximal phenotypes should enhance genetic mapping by tapping genetic signals with greater penetrance and by reducing multiple phenocopies.¹⁷⁸ An example of the advantage of relatively discrete phenotypic measures, and ones that are more tightly linked to underlying biology, can be found in the area of gene mapping in hypertension: stronger gene mapping was found for angiotensin-converting enzyme than for blood pressure or hypertension diagnosis.¹⁷⁹ Figure 3.2⁴⁴ conveys the notion that a final disease

phenotype may be the product of diverse types of influences, and that some influences may be operative for some people, while other influences are operative for other people. However, these diverse “feeder stream” influences are somewhat compensatory and interchangeable with respect to contributing to “downstream” processes that produce mature features of nicotine dependence. It is conceivable that these influences may exert additive or interactive effects and be differentially sensitive to environmental events. The assumption is, however, that there is a final common pathway (ultimate downstream) set of processes and symptoms that is manifest once a disorder achieves some level of severity. Thus, at clinical levels of a disorder, sufferers appear similar to one another, but this similarity may mask diverse etiologic paths.

Endophenotypes, or “intermediate” phenotypes, link disease-promoting or disease-permitting sequence variations in genes to lower-level biological processes and link lower-level biological processes to the downstream observable syndromes that constitute diagnostic categories of disorders.^{180,181} A genetic variant that affects an upstream process affects all the downstream processes that depend on it (figure 3.2). Thus, the genetic variants associated with a particular endophenotype should be associated with multiple (downstream) phenotypes that are causally dependent on that endophenotype. There may be considerable individual variation in the sets of possible upstream influences that contribute to nicotine dependence in one individual compared with another; that is, there is a final common pathway of processes, but highly heterogeneous influences may lead to that pathway. The next section discusses the concepts of “endophenotypes” and “transitional phenotypes” that differ from distal phenotypes in their specificity and causal priority.

Phenotypes along the Causal Chain of Dependence Development

In this chapter, the term *endophenotypes* is defined in a manner that is consistent with earlier definitions by Gottesman and others:^{44,181,182}

- Endophenotypes should be heritable. The endophenotype cannot transmit information about genetic differences if it is not sensitive to such differences. Although endophenotypes must be heritable, they may also be highly responsive to environmental manipulations.
- Endophenotypes should be associated with the causes, rather than the effects, of disorders. Ideally, endophenotypes should be located in the causal path to the disorder, not be a consequence of the disorder or its treatment. Endophenotypes may also be useful to the extent that they are markers of a disorder (i.e., they correlate meaningfully with phenotypes that are on the causal path). A causal role for an endophenotype is suggested by the endophenotype preceding the disorder ontogenetically or developmentally in affected individuals (figure 3.3). Moreover, it should not appear to be merely a prodromal or less intense manifestation of the disorder.
- Assuming the endophenotype is heritable, the presence or magnitude of the endophenotype should reflect the genetic relatedness to an individual diagnosed or affected by the disorder. Thus, if appetitive motivational response to an anticipated reward is a heritable endophenotype for nicotine dependence, then two individuals of biologically similar relatedness to a smoker should show the same level of this phenotype, even if these individuals are discordant for smoking. However, this situation may not hold even with useful endophenotypes: the endophenotype may be heritable, and may precede the appearance of a disorder, but may also be affected by environmental factors and by the disease process per se. For example, some schizophrenics show abnormalities of the prefrontal cortex and working memory, and these deficits predate schizophrenia onset, consistent with an endophenotype. However, the evidence suggests that these deficits are also exacerbated by the illness,⁴⁴ showing apparent reciprocal relations between the endophenotype and disorder (or perhaps its treatment or other consequences of the disorder). A similar complex relation has been found for hippocampal volume differences, with such volume differences being related to genetic load for schizophrenia in a stepwise manner, and yet, the genetic load for schizophrenia appears to render a person more susceptible to the effects of fetal hypoxia on hippocampal volume. In other words, genetic load appears to *moderate* the effects of hypoxia on hippocampal volume. Reverse causation of this nature¹⁸³ may certainly occur in nicotine dependence; that is, ingestion of nicotine may affect phenotypic assays. This calls for careful separation of endophenotypes and *transitional phenotypes* (discussed below).
- The endophenotype should not be redundant with disorder status; it should account for only a portion of the variance in disorder severity or course. The endophenotype is intended to reflect more discrete features or risk factors for a disorder than are reflected in the disorder per se. Because of this, multiple endophenotypes would need to be identified to account for significant variance in a disorder phenotype and to identify genetic variants that confer risk.
- The endophenotype is a mediator. The molecular genetic variant should account for significant variance in

the endophenotypic measure, and the endophenotypic measure should account for significant variance in the phenotype. Ultimately, one would need to use multimediator models to explain large proportions of variance in the phenotype. This means that one needs two theoretical models: one of the gene-endophenotype relation and one of an endophenotype-phenotype (disorder) relation. Successful use of the endophenotypic approach requires that investigators test causal models comprising (1) specific biologically relevant processes thought to contribute to clinically meaningful nicotine dependence (the endophenotype-phenotype model); (2) specific genetic variants thought to influence those biological processes (the gene-endophenotype model); and (3) an assessment plan that is sensitive to the specific biological process(es) and to the ultimate phenotype.

- Endophenotypes should be present before, or in the absence of, a disorder (figure 3.3). Thus, as noted earlier, the endophenotype truly conveys a risk factor and not a prodromal feature or disease manifestation. Thus, to permit the strongest causal inferences, endophenotypes should be assessed before the development of nicotine dependence and be present in nondependent individuals as a function of consanguinity. Thus, endophenotypes are both more specific than the clinical phenotype and possess temporal and causal priority. However, it may be useful to distinguish a host of factors significantly more specific than the clinical phenotype but that manifest only when disease causal processes have been induced. These might be termed *transitional phenotypes* (see figure 3.3). Unlike endophenotypes, these do not occur before exposure to a pathogen (e.g., high stress, nicotine). Tolerance development to nicotine would be an example of such a transitional

phenotype. Tolerance development could not be assessed directly outside of exposure to nicotine. Many of the important theories of nicotine dependence development really refer to phenomena that could be captured as transitional phenotypes. For example, the development of tolerance, withdrawal symptoms, sensitization to nicotine's incentive effects, and the development of conditioned reinforcement would all depend on exposure to the direct effects of nicotine. The distinction between endophenotypes and transitional phenotypes is an important one because very different causal claims are being made in the two cases. The distinction also has clear implications for experimental design: in the case of endophenotypes, one would assay, ideally, individuals with little or no nicotine exposure; in the case of transitional phenotypes, one would assay those who have initiated tobacco use.

- Endophenotypes should manifest causal effects across different levels of analysis or different points of the causal chain (table 3.4). Figure 3.6 shows a model in which an attention deficit endophenotype affects the likelihood of downstream transitional and mature phenotypes. In theory, the same polymorphisms might be related to phenotypic variance at all three stages of the causal path, to the extent that the endophenotypes were genetically influenced and served as setting events or instigators for the subsequent transitional and mature phenotypes. Thus, pleiotropy would be evident in these relations to the extent that an endophenotypic or transitional effect determined downstream manifestations of nicotine dependence. Of course, it is always possible that a phenotype that is associated with a developmentally early stage of smoking will not account for significant variance in measures of clinical, or mature, levels

Figure 3.6 Associating Genes with Phenotypic Stages

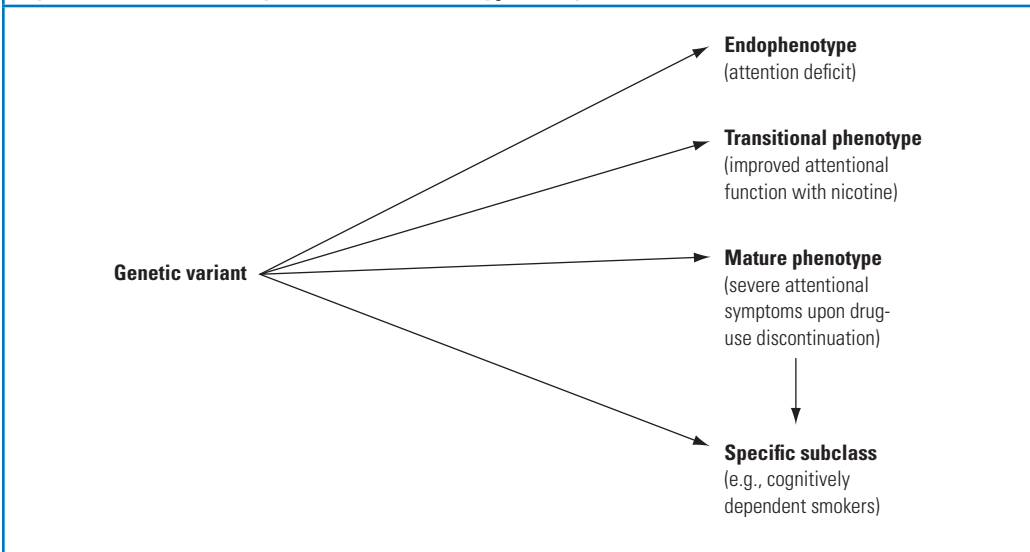

Table 3.4 Levels of Analysis in Characterizing the Phenotype

Level	Example
Transcripts/gene expression	Polypeptide synthesis
Postreceptor processing	Second-messenger response
Neurotransmitter system status	Response to nicotine challenge
Brain morphology	Density of receptor cell types
Physiological morphology and function	Liver clearance rates
Brain function	fMRI
Discrete cognitive processing	Anterior attentional function
Discrete behavioral domains	Smoking rate
Emergent cognitive function	IQ, memory
Emergent behavior/psychological traits	Personality, attitudes

Note. fMRI = functional magnetic resonance imaging.

of dependence. Such factors might be endophenotypes for initiation rather than dependence.

- Figure 3.3 makes another factor clear: it is likely that different genetic variants are associated with risk at the different levels of etiologic development. For example, some genetic variants may contribute to nicotine-dependence development only after considerable nicotine exposure (e.g., variants that foster tolerance or permit heavy nicotine use). Thus, as figure 3.3 illustrates, a complete theoretical model of nicotine dependence should address which biological processes, associated with which genetic variants, influence nicotine-dependence development at which points in the causal path. The ability to track a postulated causal path across levels of analysis and across points in the causal pathway adds greatly to the strength of inferences linking all elements in the phenotypic causal chain.
- Endophenotypes for one disorder should predict occurrence of genetically related disorders. Some disorders are

substantially correlated with one another, and their intercorrelation is due to shared genetic influences.

Caveats to Assessing Endophenotypes

Although there are clear potential advantages to a strategy that focuses on specific endophenotypes, potential hazards exist as well. That is, it is possible that greater progress might be made, and made more quickly, by concentrating on mapping distal, or clinical, phenotypes rather than endophenotypes. This might occur because the endophenotype may itself be a nonspecific or promiscuous causal influence, giving rise to myriad outcomes (e.g., not only nicotine dependence but also a variety of externalizing and attention deficit disorders). Thus, the probability of a criterion given a particular response is not equivalent to the probability of a response given the criterion ($P[C|R] \neq P[R|C]$). In this case, one might detect strong associations between an endophenotype and genetic variants, but the relation might have little to do with nicotine dependence per se. In addition, it is unavoidable that individuals with nicotine dependence will possess numerous candidate endophenotypes. It is clear that the distal phenotype (at least with a large representative sample) comprises all of the possible endophenotypes and their genetic substrata. It is only in this context that the relative and incremental value of the relevant genes can be determined. That is, the endophenotype per se will likely not provide a context that allows one to identify those genetic variants that are *relatively* influential. Thus, the value of a particular genetic variant becomes known only after its relation with the distal phenotype is known. It may be most efficient to try to ascertain this relation directly without recourse to the endophenotype.

Another concern is that some endophenotypes may be very difficult to

assess in a manner that is reliable and appropriate to the purpose of molecular genetics. For example, some potential endophenotypes (e.g., impulsivity) are very difficult to measure for any purpose and, in fact, may be more difficult to measure than is the distal nicotine-dependence phenotype. Related to this point, it is likely that only a portion of variance in an endophenotypic measure is, in fact, related to progression to a disorder end point. The task of refining endophenotypic measures appropriately could be tremendously difficult and time-consuming. Finally, it is important to remember that nicotine dependence, like other psychiatric disorders, is contextually and socially defined. A distal phenotype tells which individuals have developed a disorder despite, or because of, a host of environmental or developmental events. Different phenotypes (i.e., endophenotypes versus distal phenotypes) will reflect the influences of an entirely different set of developmental and environmental events. Thus, distal clinical measures may be most likely to reflect those genetic influences that create signal against a context of relevant environmental and life events. Of course, one could eventually discover and address these threats via endophenotypic research, but this might not be the most efficient strategy.

Finally, as noted earlier, there may be great value in studying specific subtypes among those in whom nicotine dependence is clearly present (*mature subphenotypes*; figure 3.3). These would, in theory, share the same virtue of specificity, as would endophenotypes and transitional phenotypes; that is, their greater specificity might permit stronger relations in genetic mapping than would occur with broader, more encompassing phenotypes. An example of a mature subphenotype might be smokers who are fast nicotine metabolizers or who smoke for taste reasons.^{54,68} The use of mature subphenotypes need not depend on the assumption that

nicotine dependence comprises multiple unique taxa. The approach might be profitable even if one assumes that the disorder is affected by distinct, continuously distributed dimensions (neuroticism, behavioral undercontrol, reward reactivity, taste sensitivity, and so on). The strategy might reveal populations of smokers for whom certain dependence processes are relatively important.

Causal Paths Comprising Endophenotypic, Transitional, and Distal Phenotypic Measures

Although questionnaires hold promise for elucidating the genetic basis of nicotine dependence, a better understanding of the molecular genetics of nicotine dependence may require the use of additional assessment strategies (e.g., imaging strategies;¹⁸⁴ see chapters 7 and 8).

A tremendous variety of endophenotypic and transitional phenotypic assessments are potentially available. However, many are possibly quite costly and labor-intensive. In such circumstances, the investigator wishing to assess and test relatively specific phenotypes should be guided by an explicit model of nicotine dependence. Figure 3.1 depicts a model based on distal measures of nicotine dependence, but if the models are needed to support an assessment of endophenotypic and transitional phenotypes, then causal paths should be articulated. These paths arise out of the available theories and data linking genetic variants with a developmental trajectory comprising (1) the endophenotypes that place a person at risk for experimentation and risk for initiation and progression to nicotine dependence, (2) the transitional phenotypes that become relevant once tobacco use commences, and (3) mechanisms via which endophenotypes and transitional phenotypes are related to clinical/distal measures of nicotine dependence and to mature subphenotypes.

Table 3.3 depicts a working model of how particular genetic variants might manifest different endophenotypes, transitional phenotypes, mature subphenotypes, and ultimately, distal phenotypes. These causal pathways are offered as illustrative exemplars and are not meant to constitute a complete model of nicotine dependence. However, there is some evidence that supports each causal pathway and its phenotypic markers. For example, all of the genetic variants have been linked to either smoking or nicotine dependence, or to constructs strongly implicated in risk for smoking or nicotine dependence, such as for nicotinic receptors/nicotine reward (e.g., *CHRNA2*),⁸² for taste sensitivity (*PTC*),⁴⁴ for the dopaminergic mechanisms/incentive salience and sensitization (e.g., *DRD2*, *DRD4*, *SLC6A3*),^{185–187} and metabolic capacity (e.g., *CYP2D6*, *CYP2A6*).^{188–190} Other relevant constructs might be impulsivity linked to decreased cognitive control (e.g., *MAOA*),^{181,191} withdrawal (e.g., *GABA_A* or $\alpha 7$ nAChRs),^{192–195} and affective control/stress recovery (*SLC6A4*).^{196–199} For purposes of illustration, a possible genetic influence will be traced across several selected causal paths.

Incentive Salience and Sensitization

Considerable evidence indicates that craving, especially cue-induced craving, appears to be related to activity in dopaminergic systems.^{63,200} This is indicated, in part, by responsiveness of dopaminergic, mesotelencephalic structures, such as the nucleus accumbens, to drug stimuli and drug anticipation in addicted populations.^{71,201,202} Dopaminergic responsivity might be reflected by both endophenotypic and transitional phenotype markers. The former would be assessed by functional magnetic resonance imaging (fMRI) assessment of activity in mesotelencephalic dopamine structures in response to anticipation of nonpharmacological reward (before any

lifetime nicotine exposure); transitional or mature subphenotypes could be assessed on the basis of activity in the same brain regions, but in response to anticipation of nicotine delivery to smokers.²⁰² These phenotypic variants, as well as more distal disease phenotypes, could be tested for their association with genetic variants that code for structural and functional properties of the dopamine system (e.g., *DRD2*, *SLC6A3*, and *DRD4* genes).^{185,186} Such variants have been associated with smoking,²⁰³ supporting their potential involvement in at least a subset of habitual smokers.

Cognitive Control and Impulsivity

With respect to the cognitive control/impulsivity causal path, a pattern of violence and impulsivity has been associated with a variable number tandem repeats polymorphism in *MAOA*, which encodes a key enzyme for the catabolism of serotonin and other neurotransmitters. The low-expression variant interacts with stressful experiences that occur early in life, with the combination predicting violent offenses in males.¹⁹¹ Imaging studies link this low-expression variant with poor integration among the amygdala, the subgenual and caudal portions of the cingulate gyrus, and with the orbitofrontal cortex.^{181,204} A great deal of evidence implicates the cingulate and prefrontal regions with an integrated cognitive-control system.^{205,206} A mounting body of evidence also implicates cognitive-control functioning, and activity in these brain regions, with drug/nicotine motivational processing.^{62,201,207} In addition, there is considerable evidence that impulsivity and related constructs, including externalizing psychopathologies, are related to initiation of smoking and intensity of nicotine dependence.⁶⁰ Certain laboratory tasks are sensitive to externalizing personality influences and the tendency to develop specific externalizing disorders, (e.g., P300 in the oddball task)²⁰⁸ and some tasks are sensitive to extreme dominant

response focus.²⁰⁹ Such tasks require no prior exposure to nicotine and, therefore, might serve as sensitive endophenotypic measures.

Genetic risk for reduced cognitive control might also be associated with transitional patterns such as the tendency to show rapid escalation once smoking begins.²¹⁰ Whether the candidate genetic variant and associated externalizing tendencies are causally determinant of initiation per se, or both initiation and nicotine-dependence development, must be elucidated by future longitudinal molecular genetics research. Thus, it is possible that some genetic variants might influence some upstream nodes of the causal chain (initiation) but not later causal processes directly leading to severe nicotine dependence.

Affective Coping

The affective coping causal path might be linked to *SLC6A4*, which contains a variable number tandem repeats variant in the 5' promoter region (*5-HTTLPR*), with reduced transcription with the short (S) allele relative to the long allele. Research shows that individuals with the S allele tend to report more internalizing symptoms or traits, and this predicts greater likelihood of depression in response to environmental adversity. In addition, evidence suggests that S allele carriers show unusually high levels of amygdala activity in response to stressors consistent with an inability to modulate affective reaction.^{197,198} Interestingly, the subgenual cingulate provides inhibitory feedback to the amygdala to regulate processing of environmental threats or stressors. In addition, studies have shown that the S allele carriers show reduced coupling of the subgenual cingulate and the amygdala, which was, in turn, associated with degree of internalizing symptoms.²¹¹ In sum, results suggest that possession of the S allele leads to weakened integration and inhibitory feedback from the subgenual cingulate and the amygdala, and this is

associated with reduced affective control (e.g., fear extinction).

In theory, an inability to control affective response may render a person more dependent on a drug for affective control. Affective control is a primary motive offered by dependent smokers,⁵⁰ and this is especially true of smokers with internalizing symptoms. A dependence on smoking for affective control may be one reason that individuals with internalizing disorders smoke more cigarettes than do other smokers and are more likely to be diagnosed with nicotine dependence.³⁵ In addition, both affect and cognitive-control mechanisms appear to account for urge occurrence,⁶² suggesting that smokers with impaired cognitive control, and a resultant inability to cope with negative affect via endogenous control mechanisms, may be especially likely to experience high levels of negative affect and urges and to relapse in response to stressors.

Thus, the available evidence suggests that the relevant effects of the S allele variant of *SLC6A4* may be detected with endophenotypic measures, such as the emotional Stroop paradigm,²¹² and fMRI or startle-probe measures of affective responsivity in response to stressors. Moreover, S allele carriers may report higher scores on the WISDM Negative Reinforcement subscale and show higher levels of relapse in response to stressors.

In sum, table 3.3 contains examples of strategies that might be used for genetic mapping before nicotine exposure (endophenotypic markers) and during the periexposure and postexposure periods (transitional and mature subphenotypic markers). The table collapses across transitional and mature subphenotypes for ease of exposition. The table makes clear that all genetic variants and the processes that they encode may lead to elevated levels on the distal phenotype measures

(but this is not to say that there will not be significant variation on such measures as a function of differences across the various causal paths). Thus, it is important to note that although two individuals may arrive at the same severity of nicotine dependence according to status on distal measures, the two individuals very likely are not equivalent at earlier stages of the causal chain (including genetic variants). This is why mature subphenotypic measures may detect differences among heavy smokers.

Finally, table 3.3 does not depict how the various causal paths might merge or interact. The table and the associated discussion make clear that causal paths reflect the synthesis of evidence related to functional significance of genetic variants, the constructs and processes related to smoking and nicotine dependence, and knowledge regarding measures that reflect nicotine dependence as well as endophenotype-related processes and other causal mechanisms.

Analytic Strategies

The scope of this chapter is such that approaches to data analysis cannot be discussed in depth. But certain conceptual issues should be mentioned so investigators might bear in mind how such considerations are relevant to their research goals. Data analysis in association studies is escalating dramatically in complexity because of advances in genotyping and the use of more complex phenotypes. For instance, phenotypes are being developed that involve complex developmental-change functions and stage-specific dependence measures. The complex causal models depicted in table 3.3 would also entail complex causal modeling. The discussion of analytic strategies that follows does not address how such complex phenotypes may be most effectively modeled. Chapters 5–9 address issues relevant to such complex phenotypic modeling. However, the discussion below

focuses on how distal phenotypes may be most effectively used in mapping analyses.

Constructing Extreme Groups

As noted earlier, one common strategy for associating genetic variants with phenotypes is via designing extreme groups.¹⁰⁵ In constructing extreme groups, the goal is to achieve a contrast of two groups, one of which comprises a full complement of genetic variants that promote vulnerability for nicotine dependence and has no variants that protect against dependence. The second group comprises variants that protect against nicotine dependence but has no variants that foster dependence. This is, obviously, an ideal that can only be approximated. One assumption in building extreme groups is that genetic vulnerabilities and protective factors cannot be expressed unless individuals have had some level of exposure to nicotine; that is, the assumption is that the genetic variants that affect smoking initiation differ from those that affect the development of dependence.^{79,81,82,213}

The review of the nicotine dependence measures and influences presented above suggests one strategy for formulating the two extreme groups. The dependent group members should show high scores on all of the measures listed in table 3.2 for high genetic proneness: they should smoke heavily, pervasively, automatically, and uniformly; smoke early in the day; report severe withdrawal upon attempts to quit; and report an inability to cut down or control their smoking. The nondependent group should, of course, have none of these features.

Both groups should have had some exposure to nicotine, although how extensive that exposure must be is unclear. If the investigator believes that there is a true nicotine-dependence taxon, then the genetic variants particular to that taxon

might be best captured by a contrast of two groups with extensive smoking histories—for instance, two groups comprising those who have smoked daily for at least one year. This would ensure that the two groups differ on variants that are relatively specific to dependence per se. To the extent that the groups differ greatly on exposure to tobacco, the more likely it is that differences in genetic variants may be related to factors that promote or retard smoking initiation per se versus dependence. Thus, it is incumbent upon the investigator to decide how specifically to target severe dependence per se in the search for genetic variants.

In forming extreme groups, investigators may wish to consider the timing of nicotine exposure in addition to the sheer amount of exposure. In keeping with the review of gene-environment interactions, investigators may wish to incorporate the notion that all individuals contrasted (in both of the extreme groups) have exposure to tobacco relatively early in life. This would be based upon the notion that early exposure is needed for the expression of genetic influences.^{21,34,162,214} It may be that late-onset experimentation is unlikely to lead to severe nicotine dependence even if an individual possesses genetic vulnerabilities.

Obviously, the investigator would wish to conduct additional analyses of results yielded by an extreme groups design. For instance, the investigator would wish to ensure that the effects of the contrast are not specific to gender and that the effects of early smoking are not produced by that variable's relations with syndromes of disinhibition (which would encourage early drug exposure). Such follow-up analyses would address the generality of the effects obtained and the underlying causes of such effects.

The extreme groups strategy is not without its drawbacks. Requiring subjects to be maximally divergent on a host of indicators

of dependence, as indicated in table 3.2, may lead to several problems. For example, even if the measures in table 3.2 agree with one another substantially, selecting on the basis of high scores on all of such measures might entail screening of tremendous numbers of individuals to identify subjects who are uniformly high, or low, across the diverse criteria. Not only might this be impractical and expensive, but it also raises concerns about the representativeness of the samples generated. For example, some forms of psychopathology are associated with very severe nicotine dependence;^{21,35,118,215} thus, it is possible that selecting extreme subjects might result in the unintentional selection of those with syndromal or subsyndromal comorbidities. This means that one might inadvertently select for genetic variants associated with conditions or dispositions associated with correlates of extreme nicotine dependence but that are not central to the construct. Of course, all of these concerns are related to where one sets cut-scores on the various measures.

An additional concern with constructing extreme groups is that it severely limits the sort of analytic strategies that one can use to explore the nature of the relations of genetic variants with the phenotypic measures.²¹⁶ For instance, as Preacher and colleagues²¹⁶ observe, use of the extreme groups design precludes characterization of genetic variant and phenotypic relations across the full range of these variables and may produce model misspecification. In addition, even with the use of taxometric procedures or signal detection methods, it is difficult to know where to place cut-scores to ensure that the dependent group exclusively comprises dependent individuals but does not entail excessive screening. Also, such designs entail the possibility of classification error beyond the usual measurement error assumed with classical test theory. Thus, the procedure may reduce reliability in ways that would be difficult to detect and correct. In particular, the use of extreme scores may

yield classification error due to regression to the mean as such scores are likely to be unstable across time. Of course, the use of multiple classification criteria would protect against this threat somewhat. Finally, it is true that extreme groups designs confer greater power and, therefore, are more likely to lead to higher likelihood of statistical significance relative to continuous designs with similar *N*s. However, these designs may produce significant effects even though effect sizes are trivial. Therefore, it seems advisable to use extreme groups designs in exploratory research—when a research area is in its infancy, costs are high, and a premium is placed upon detection of possible effects rather than an estimation of their magnitude. Of course, one should use an extreme groups design if it is clear that a nicotine-dependence taxon really exists,¹⁰⁰ because the nature of the design would match the true distribution of nicotine dependence. However, a good deal of research suggests that differences among smokers may be explained on the basis of different *intensities* of a single dimension, rather than reflecting distinct, qualitatively different types.^{102,118–120} (See also Muthén and Asparouhov 2006.³⁹)

One last observation about the structure or nature of nicotine dependence is relevant here. Questions about the structure of psychiatric disorders—whether it is taxonic or continuous—are very difficult to resolve. For example, it is possible that a continuous dimension may appear categorical or taxonic, while a categorical dimension may appear to be continuous, depending on scaling and measurement properties of the variables involved.²¹⁷ This means that even though an item generates scores that suggest the presence of two distinct groups of individuals, such a pattern may be caused by peaked indicators of a continuous dimension. Moreover, it is also the case that the categorical/continuous distinction is a false dichotomy. As Haslam and Kim note, “matters of kind and matters of degree,

itself [might] be a matter of degree.”^{218(p311)} Thus, nicotine dependence might be caused by a certain all-or-none genetic influence coupled with other graded genetic and environmental influences. In short, distinguishing the underlying structure of a disorder is a complex and difficult undertaking; thus, no definitive conclusions are possible at this time. The bottom line is that whenever investigators use an extreme groups design, they should be aware of the limitations and assumptions entailed.

Alternatives to Extreme Groups Classification

One strategy takes advantage of a theoretically guided selection of criterion measures; it reflects the multifactorial nature of nicotine dependence but does not require that individuals have uniformly extreme scores on all measures. This strategy involves combining measures so they reflect a linear dimension of nicotine dependence. One challenge with a combinatorial strategy is how to achieve proper or appropriate weighting of the predictors. Since the true relation between each nicotine-dependence indicator (criterion) and polymorphisms will likely be unknown, the investigator must devise a system for weighting the various predictors or criteria used to select subjects. Numerous strategies for this are possible.

One strategy is to construct an improper linear model²¹⁹ that comprises the principal nicotine-dependence indicators that the researcher believes will tap the major nicotine-dependence facets. In this approach, the researcher can use unit weighting, or weights based on substantive considerations, to create a composite—that is, adding subjects’ scores across the set of variables to create a somewhat continuous index of risk. Weights might reflect correlations among the nicotine-dependence criteria, heritability estimates yielded by biometric research, and the importance of

the criteria in the investigator’s theory of nicotine dependence. This composite would allow for compensatory contributions of variables such that high scores on some elements would compensate for low scores on other measures, and thus, in theory, all subjects could be included in analyses.

Further, the investigator might examine associations of selected polymorphisms with extremes on the composite dimension or on a quasi-continuous dimension constituted of quintiles or deciles of risk. If promising relations ultimately are found in such analyses, these relations could be unpackaged by examining relations of polymorphisms with individual elements of the composite. This strategy has several advantages: (1) inclusion of multiple indices of nicotine dependence; (2) potential to weight the nicotine-dependence indicators (variables) in a manner consistent with their theoretical importance or empirical support; (3) potential retention of most or all subjects; (4) ability to examine relations across a quasi-continuous distribution; (5) ability to unpackage relations with composite elements; and (6) a composite that, no doubt, is more reliable than any single composite element—a desirable feature when dealing with potentially unreliable categorical variables.

The model just presented is compatible with the view that (1) nicotine dependence is fostered or permitted by multiple polymorphisms; (2) persons with nicotine dependence are heterogeneous with respect to which polymorphisms are present (few or none are necessary and sufficient) due, in part, to the fact that some phenotypic measures are more relevant to some nicotine-dependence cases than to others; (3) different nicotine-dependence measures or criteria are modestly intercorrelated, reflecting somewhat distinct causal influences, including genetic influences; and, therefore, (4) the greatest likelihood of capturing a full complement of variants

promoting nicotine dependence is to use a composite comprising multiple nicotine-dependence criteria that index the various relevant polymorphism. If this approach is used, it should capture relevant genes even in the presence of epistasis and pleiotropy or genetic heterogeneity. Such potential causal influences could be examined when the composite measure is unpacked and its elements related to individual genotypes/haplotypes.

The analytic strategies outlined thus far have all been highly theory driven. Of course, an alternative to a theory-based approach is to use empirical search strategies or data-driven approaches²²⁰ to uncover gene, intermediate, and phenotype associations. It is possible that a lack of guiding theory, and a virtually limitless number of potential associations, might yield fortuitous associations and lack of replication.^{221,222} Moreover, a strongly empirical strategy merely forestalls the need to hypothesize biological mechanisms and achieve theoretical integration.

Other new approaches to data analysis combine strengths of a priori theoretical and empirical approaches. The approaches have been fostered by challenges and complexities posed by advances in genotyping, as well as increased recognition of the difficulties in modeling complex phenotypes. These complexities become even more pronounced with the “omicization” of observational studies and the availability of new genome-wide technologies for genomics, transcriptomics, metabolomics, proteomics, and so forth.²²³ Although much of this chapter has been focused on refining the phenotype and exploring endophenotype definitions, one must also pay close attention to how one measures the biologically relevant factors. Mimicking the move from the evaluation of a single polymorphism to evaluating haplotypes within a single candidate gene, the field is rapidly moving from the evaluation of a

single candidate gene to the investigation of numerous gene regions either within a suspected etiologic pathway or even on the genome-wide scale. Combine this wealth of genetic information with potential intermediate measures, biomarkers, environmental factors, endophenotypes, and distal phenotypes, and the “curse of dimensionality,” and multiple comparison issues quickly dampen any hope of a statistically significant result with conventional tests of association. However, in a similar fashion to how the watershed model (figure 3.2) provides a structure for the nicotine-dependence phenotype, structure for this statistical analysis can be gained via knowledge of the biology. Although standard multivariate techniques, such as linear regression, are one way of providing structure by limiting the analysis to main effects, two-way interactions, and so forth, these techniques quickly reach their limit with sparse data bias and unstable estimation when the number of terms approaches the number of individuals.^{224,225} This difficulty often forces the investigator into choosing a reduced or “best” model via a stepwise selection criterion—a procedure well known to lead the analyst astray of the true model and that, furthermore, does not include the uncertainty in model determination in final inference.^{226,227}

As an alternative, one may use hierarchical modeling and Bayesian model averaging to inform final inference via statistical modeling.^{228,229} Hierarchical modeling treats the coefficients from a regression model as random effects and incorporates known information about the relations among factors.^{230–233} This specifies a joint distribution that both stabilizes the final effect estimates and incorporates dependencies across multiple tests of association. In contrast, Bayes model averaging seeks to use prior knowledge to guide a stochastic model selection approach to models that include more biologically relevant terms.^{234,235}

Thus, instead of being faced with an impossible number of interacting terms and possible models, the process is reduced by using biological information to inform and guide the search procedure. In the process of the stochastic search, the data will serve to update the prior probability and disclose the impact of each factor via the posterior probability of the models selected. If the knowledge specifying the structure of the relations is very well defined, one may use structural equation modeling or, in the case of metabolic pathways, pharmacokinetic models to specify the topology between factors.²³⁶ Of course, such approaches are extremely model dependent and may have serious identifiability problems for intermediate latent variables if the study is limited to genes and distal phenotype measures only. However, one may enhance estimation within this framework by gathering intermediate or endophenotype measures on a small subsample of individuals and then performing a combined analysis (main study and substudy) to inform the latent structure of the topology.

Finally, in an extreme example of using the known biology and sampling schemes to inform an analysis, a novel approach is to adopt a Mendelian randomization approach in which genetic variants are used to make inferences about critical intermediates.^{183,237,238} The basic idea is that if a causal pathway is correctly specified, then the effect of an intermediate factor on an outcome can be estimated through the ratio of coefficients of the regression of the outcome on the gene and of the intermediate on the gene. Thus, the gene acts as a randomized control for the intermediate's effect on the outcome, helping to protect against reverse causation and unknown confounding effects.

An example of this might be if one or more genetic variants were found that resulted in high levels of cotinine to accrue in response to nicotine use. If this were found

to relate strongly to the nicotine-dependence phenotype, one might infer that a high level of cotinine is an important pathogen (at least for some people, if it is a moderator). Thus, in a gene-environment interaction approach, this would suggest a gene-gene interaction that would allow one to make inferences about a gene-environment interaction. Although the use of biology guiding statistical analysis is not new, the direct incorporation of that knowledge into statistical inference is still in its infancy. Questions still remain as to what kind of information is most relevant and how much of the final inference is dependent on prior structuring of the relations and topology.

Summary

One's model of nicotine dependence guides decisions about the measurement of the nicotine-dependence phenotype—whether such guidance is explicit or implicit. It is best if the investigator makes such guidance explicit by clearly articulating hypotheses about the nature of dependence processes, the biological origins of such processes, and how they manifest phenotypically. Research suggests that while nicotine dependence is multidimensional, measures that assess heavy, pervasive, and automatic smoking appear to capture core variance related to this construct. However, the investigator should consider how to incorporate the assessment of complementary dimensions of dependence, how to control for error in dependence assessments, and whether to incorporate gene-environment interactions into attempts at genetic mapping. More thorough assessment of the dependence construct may require the development of new dependence assays that are focused on relatively discrete biological mechanisms. In addition, a comprehensive portrayal of nicotine dependence may require the development of measures of intermediate and transitional phenotypes that capture processes in dependence across its

development. The investigator must also decide on how to integrate a model and assessment of dependence with particular experimental and analytic strategies. This endeavor should also be guided by the investigator's explicit hypotheses about the nature of dependence and how it should manifest across persons and across the developmental process. Finally, it is important to note that numerous theories of nicotine dependence are possible, and the investigator should systematically examine competing and distinct models.

Conclusions

1. Most widely used tests of nicotine dependence, such as the Fagerström Test for Nicotine Dependence and the *Diagnostic and Statistical Manual of Mental Disorders*, aggregate data across different dimensions of dependence, thereby compromising the reliability and validity of these measures. Evidence suggests, however, that selected items from these measures and from newly developed dependence scales can be relatively coherent, show fairly high heritability, and be consistently related to core dependence features such as relapse likelihood.
2. Although key variance associated with the dependence construct will be captured by measures of smoking rate, latency to smoke in the morning, and the likelihood or latency of relapse, other complementary measures should also be considered such as strength of withdrawal symptoms and perceived control over smoking. Analytic strategies should adjust for environmental factors such as home or work smoking restrictions, which, in theory, may reciprocally affect dependence itself.
3. Nicotine dependence involves both environmental and constitutional influences, and the effects of genetic variants associated with nicotine dependence require certain environmental conditions to influence the phenotype (at minimum, drug access and use). Determining which environmental features moderate genetic expression and how to incorporate such gene-environment interactions into genetic mapping remains an area for further study.
4. New developments in the assessment of the nicotine-dependence phenotype include the development of new multidimensional measures of nicotine dependence, including the Nicotine Dependence Syndrome Scale and the Wisconsin Inventory of Smoking Dependence Motives. These measures of mature dependence phenotypes provide the opportunity to measure relatively discrete dimensions of dependence and may permit more specific gene mapping.
5. In addition to greater specificity, it is vital to capture important developmental processes that may be masked by the mature nicotine-dependence phenotype. To obtain measures sensitive to particular biological mechanisms that may have close links to genetic variants, researchers may need to develop biological, behavioral, and cognitive neuroscience assays that complement self-report measures. These may include measures of endophenotypes, or intermediate phenotypes, that assess vulnerabilities to dependence that preexist nicotine use as well as transitional phenotypic measures that assess processes that change in response to drug exposure and that lead to mature dependence.
6. All stages of the genetic mapping of nicotine dependence should be guided by specific theory linking candidate genetic variants sequentially with critical biological and behavioral processes and, ultimately, with phenotypes of clinical significance.

References

- American Psychiatric Association. 1994. *Diagnostic and statistical manual of mental disorders: DSM-IV*. 4th ed. Washington, DC: American Psychiatric Association.
- Cronbach, L. J., and P. E. Meehl. 1955. Construct validity in psychological tests. *Psychological Bulletin* 52 (4): 281–302.
- West, R. 2006. Defining and assessing nicotine dependence in humans. In *Understanding nicotine and tobacco addiction*, Novartis Foundation Symposia No. 275, ed. G. Bock and J. Goode, 38–58. Indianapolis: Wiley Publishing.
- Heatherton, T. F., L. T. Kozlowski, R. C. Frecker, and K. O. Fagerström. 1991. The Fagerström Test for Nicotine Dependence: A revision of the Fagerström Tolerance Questionnaire. *British Journal of Addiction* 86 (9): 1119–27.
- Heatherton, T. F., L. T. Kozlowski, R. C. Frecker, W. Rickert, and J. Robinson. 1989. Measuring the heaviness of smoking: Using self-reported time to the first cigarette of the day and number of cigarettes smoked per day. *British Journal of Addiction* 84 (7): 791–99.
- Fagerström, K. O. 1978. Measuring degree of physical dependence to tobacco smoking with reference to individualization of treatment. *Addictive Behaviors* 3 (3–4): 235–41.
- Kozlowski, L. T., C. Q. Porter, C. T. Orleans, M. A. Pope, and T. Heatherton. 1994. Predicting smoking cessation with self-reported measures of nicotine dependence: FTQ, FTND, and HSI. *Drug and Alcohol Dependence* 34 (3): 211–16.
- Haddock, C. K., H. Lando, R. C. Klesges, G. W. Talcott, and E. A. Renaud. 1999. A study of the psychometric and predictive properties of the Fagerström Test for Nicotine Dependence in a population of young smokers. *Nicotine & Tobacco Research* 1 (1): 59–66.
- Payne, T. J., P. O. Smith, L. M. McCracken, W. C. McSherry, and M. M. Antony. 1994. Assessing nicotine dependence: A comparison of the Fagerström Tolerance Questionnaire (FTQ) with the Fagerström Test for Nicotine Dependence (FTND) in a clinical sample. *Addictive Behaviors* 19 (3): 307–17.
- Pomerleau, C. S., S. M. Carton, M. L. Lutzke, K. A. Flessland, and O. F. Pomerleau. 1994. Reliability of the Fagerström Tolerance Questionnaire and the Fagerström Test for Nicotine Dependence. *Addictive Behaviors* 19 (1): 33–39.
- Etter, J. F. 2005. A comparison of the content-, construct- and predictive validity of the cigarette dependence scale and the Fagerström test for nicotine dependence. *Drug and Alcohol Dependence* 77 (3): 259–68.
- Nunnally, J. C., and I. H. Bernstein. 1994. *Psychometric theory*. 3rd ed. New York: McGraw Hill.
- Breteler, M. H., S. R. Hilberink, G. Zeeman, and S. M. Lammers. 2004. Compulsive smoking: The development of a Rasch homogeneous scale of nicotine dependence. *Addictive Behaviors* 29 (1): 199–205.
- Etter, J. F., T. V. Duc, and T. V. Perneger. 1999. Validity of the Fagerström Test for Nicotine Dependence and of the Heaviness of Smoking Index among relatively light smokers. *Addiction* 94 (2): 269–81.
- John, U., C. Meyer, A. Schumann, U. Hapke, H. J. Rumpf, C. Adam, D. Alte, and J. Ludemann. 2004. A short form of the Fagerström Test for Nicotine Dependence and the Heaviness of Smoking Index in two adult population samples. *Addictive Behaviors* 29 (6): 1207–12.
- Radzius, A., J. J. Gallo, D. H. Epstein, D. A. Gorelick, J. L. Cadet, G. E. Uhl, and E. T. Moolchan. 2003. A factor analysis of the Fagerström Test for Nicotine Dependence (FTND). *Nicotine & Tobacco Research* 5 (2): 255–60.
- Chabrol, H., M. Niezborala, E. Chastan, J. L. Montastruc, and E. Mullet. 2003. A study of the psychometric properties of the Fagerström Test for Nicotine Dependence. *Addictive Behaviors* 28 (8): 1441–45.
- Baker, T. B., M. E. Piper, D. E. McCarthy, D. M. Bolt, S. S. Smith, S.-Y. Kim, S. Colby, et al. 2007. Time to first cigarette in the morning as an index of ability to quit smoking: Implications for nicotine dependence. *Nicotine & Tobacco Research* 9 Suppl. 4: S555–S570.
- Storr, C. L., B. A. Reboussin, and J. C. Anthony. 2005. The Fagerström test for nicotine dependence: A comparison of standard scoring and latent class analysis approaches. *Drug and Alcohol Dependence* 80 (2): 241–50.

20. Huang, C. L., H. H. Lin, and H. H. Wang. 2006. The psychometric properties of the Chinese version of the Fagerström Test for Nicotine Dependence. *Addictive Behaviors* 31 (12): 2324–27.
21. John, U., C. Meyer, H. J. Rumpf, A. Schumann, J. R. Thyrian, and U. Hapke. 2003. Strength of the relationship between tobacco smoking, nicotine dependence and the severity of alcohol dependence syndrome criteria in a population-based sample. *Alcohol and Alcoholism* 38 (6): 606–12.
22. Alterman, A. I., P. Gariti, T. G. Cook, and A. Cnaan. 1999. Nicodermal patch adherence and its correlates. *Drug and Alcohol Dependence* 53 (2): 159–65.
23. Campbell, I. A., R. J. Prescott, and S. M. Tjeder-Burton. 1996. Transdermal nicotine plus support in patients attending hospital with smoking-related diseases: A placebo-controlled study. *Respiratory Medicine* 90 (1): 47–51.
24. Patten, C. A., J. E. Martin, K. J. Calfas, J. Lento, and T. D. Wolter. 2001. Behavioral treatment for smokers with a history of alcoholism: Predictors of successful outcome. *Journal of Consulting and Clinical Psychology* 69 (5): 796–801.
25. Westman, E. C., F. M. Behm, D. L. Simel, and J. E. Rose. 1997. Smoking behavior on the first day of a quit attempt predicts long-term abstinence. *Archives of Internal Medicine* 157 (3): 335–40.
26. Breslau, N., and E. O. Johnson. 2000. Predicting smoking cessation and major depression in nicotine-dependent smokers. *American Journal of Public Health* 90 (7): 1122–27.
27. Hyland, A., R. Borland, Q. Li, H. H. Yong, A. McNeill, G. T. Fong, R. J. O'Connor, and K. M. Cummings. 2006. Individual-level predictors of cessation behaviours among participants in the International Tobacco Control (ITC) Four Country Survey. *Tobacco Control* 15 Suppl. 3: iii83–iii94.
28. Hymowitz, N., K. M. Cummings, A. Hyland, W. R. Lynn, T. F. Pechacek, and T. D. Hartwell. 1997. Predictors of smoking cessation in a cohort of adult smokers followed for five years. *Tobacco Control* 6 Suppl. 2: S57–S62.
29. World Health Organization. 2003. International Statistical Classification of Diseases, Tenth Revision (ICD-10). <http://www.who.int/classifications/apps/icd/icd10online/> (accessed December 29, 2008).
30. Haro, J. M., S. Arbabzadeh-Bouchez, T. S. Brugha, G. de Girolamo, M. E. Guyer, R. Jin, J. P. Lepine, et al. 2006. Concordance of the Composite International Diagnostic Interview Version 3.0 (CIDI 3.0) with standardized clinical assessments in the WHO World Mental Health surveys. *International Journal of Methods in Psychiatric Research* 15 (4): 167–80.
31. Breslau, N., S. P. Novak, and R. C. Kessler. 2004. Psychiatric disorders and stages of smoking. *Biological Psychiatry* 55 (1): 69–76.
32. Hughes, J. R., J. E. Helzer, and S. A. Lindberg. 2006. Prevalence of DSM/ICD-defined nicotine dependence. *Drug and Alcohol Dependence* 85 (2): 91–102.
33. Hughes, J. R., A. H. Oliveto, R. Riggs, M. Kenny, A. Liguori, J. L. Pillitteri, and M. A. MacLaughlin. 2004. Concordance of different measures of nicotine dependence: Two pilot studies. *Addictive Behaviors* 29 (8): 1527–39.
34. Pergadia, M. L., A. C. Heath, A. Agrawal, K. K. Bucholz, N. G. Martin, and P. A. Madden. 2006. The implications of simultaneous smoking initiation for inferences about the genetics of smoking behavior from twin data. *Behavior Genetics* 36 (4): 567–76.
35. Grant, B. F., D. S. Hasin, S. P. Chou, F. S. Stinson, and D. A. Dawson. 2004. Nicotine dependence and psychiatric disorders in the United States: Results from the National Epidemiologic Survey on Alcohol and Related Conditions. *Archives of General Psychiatry* 61 (11): 1107–15.
36. Koenen, K. C., B. Hitsman, M. J. Lyons, R. Niaura, J. McCaffery, J. Goldberg, S. A. Eisen, W. True, and M. Tsuang. 2005. A twin registry study of the relationship between posttraumatic stress disorder and nicotine dependence in men. *Archives of General Psychiatry* 62 (11): 1258–65.
37. Strong, D. R., C. W. Kahler, S. E. Ramsey, and R. A. Brown. 2003. Finding order in the DSM-IV nicotine dependence syndrome: A Rasch analysis. *Drug and Alcohol Dependence* 72 (2): 151–62.
38. Johnson, E. O., N. Breslau, and J. C. Anthony. 1996. The latent dimensionality of DIS/DSM-III-R nicotine dependence: Exploratory analyses. *Addiction* 91 (4): 583–88.
39. Muthén, B., and T. Asparouhov. 2006. Item response mixture modeling: Application

3. The Nicotine-Dependence Phenotype

- to tobacco dependence criteria. *Addictive Behaviors* 31 (6): 1050–66.
40. Radzius, A., J. Gallo, D. Gorelick, J. L. Cadet, G. Uhl, J. Henningfield, and E. Moolchan. 2004. Nicotine dependence criteria of the DIS and DSM-III-R: A factor analysis. *Nicotine & Tobacco Research* 6 (2): 303–8.
 41. Sledjeski, E. M., L. C. Dierker, D. Costello, S. Shiffman, E. Donny, and B. R. Flay. 2007. Predictive validity of four nicotine dependence measures in a college sample. *Drug and Alcohol Dependence* 87 (1): 10–19.
 42. Dierker, L. C., G. Canino, and K. R. Merikangas. 2006. Association between parental and individual psychiatric/substance use disorders and smoking stages among Puerto Rican adolescents. *Drug and Alcohol Dependence* 84 (2): 144–53.
 43. John, U., C. Meyer, H. J. Rumpf, and U. Hapke. 2004. Smoking, nicotine dependence and psychiatric comorbidity—A population-based study including smoking cessation after three years. *Drug and Alcohol Dependence* 76 (3): 287–95.
 44. Cannon, T. D., and M. C. Keller. 2006. Endophenotypes in the genetic analyses of mental disorders. *Annual Review of Clinical Psychology* 2:267–90.
 45. Hudmon, K. S., J. L. Marks, C. S. Pomerleau, D. M. Bolt, J. Brigham, and G. E. Swan. 2003. A multidimensional model for characterizing tobacco dependence. *Nicotine & Tobacco Research* 5 (5): 655–64.
 46. Shiffman, S., A. Waters, and M. Hickcox. 2004. The Nicotine Dependence Syndrome Scale: A multidimensional measure of nicotine dependence. *Nicotine & Tobacco Research* 6 (2): 327–48.
 47. Edwards, G., and M. M. Gross. 1976. Alcohol dependence: Provisional description of a clinical syndrome. *British Medical Journal* 1 (6017): 1058–61.
 48. Shiffman, S., and M. A. Sayette. 2005. Validation of the Nicotine Dependence Syndrome Scale (NDSS): A criterion-group design contrasting chippers and regular smokers. *Drug and Alcohol Dependence* 79 (1): 45–52.
 49. Piper, M. E., D. E. McCarthy, and T. B. Baker. 2006. Assessing tobacco dependence: A guide to measure evaluation and selection. *Nicotine & Tobacco Research* 8 (3): 339–51.
 50. Piper, M. E., T. M. Piasecki, E. B. Federman, D. M. Bolt, S. S. Smith, M. C. Fiore, and T. B. Baker. 2004. A multiple motives approach to tobacco dependence: The Wisconsin Inventory of Smoking Dependence Motives (WISDM-68). *Journal of Consulting and Clinical Psychology* 72 (2): 139–54.
 51. Rose, J. E., D. P. Tashkin, A. Ertle, M. C. Zinser, and R. Lafer. 1985. Sensory blockade of smoking satisfaction. *Pharmacology, Biochemistry, and Behavior* 23 (2): 289–93.
 52. Rose, J. E., M. C. Zinser, D. P. Tashkin, R. Newcomb, and A. Ertle. 1984. Subjective response to cigarette smoking following airway anesthetization. *Addictive Behaviors* 9 (2): 211–15.
 53. Wooding, S., U. K. Kim, M. J. Bamshad, J. Larsen, L. B. Jorde, and D. Drayna. 2004. Natural selection and molecular evolution in PTC, a bitter-taste receptor gene. *American Journal of Human Genetics* 74 (4): 637–46.
 54. Cannon, D. S., T. B. Baker, M. E. Piper, M. B. Scholand, D. L. Lawrence, D. T. Drayna, W. M. McMahon, et al. 2005. Associations between phenylthiocarbamide gene polymorphisms and cigarette smoking. *Nicotine & Tobacco Research* 7 (6): 853–58.
 55. Panksepp, J., B. Herman, R. Conner, P. Bishop, and J. P. Scott. 1978. The biology of social attachments: Opiates alleviate separation distress. *Biological Psychiatry* 13 (5): 607–18.
 56. Panksepp, J., B. Knutson, and J. Burgdorf. 2002. The role of brain emotional systems in addictions: A neuro-evolutionary perspective and new ‘self-report’ animal model. *Addiction* 97 (4): 459–69.
 57. Baker, T. B., M. E. Piper, D. E. McCarthy, M. R. Majeskie, and M. C. Fiore. 2004. Addiction motivation reformulated: An affective processing model of negative reinforcement. *Psychological Review* 111 (1): 33–51.
 58. Tiffany, S. T. 1990. A cognitive model of drug urges and drug-use behavior: Role of automatic and nonautomatic processes. *Psychological Review* 97 (2): 147–68.
 59. Vuchinich, R. E., and J. A. Tucker. 1988. Contributions from behavioral theories of choice to an analysis of alcohol abuse. *Journal of Abnormal Psychology* 97 (2): 181–95.
 60. Baker, T. B., T. H. Brandon, and L. Chassin. 2004. Motivational influences on cigarette smoking. *Annual Review of Psychology* 55: 463–91.

61. Molina, B. S., and W. E. Pelham. 2001. Substance use, substance abuse, and LD among adolescents with a childhood history of ADHD. *Journal of Learning Disabilities* 34 (4): 333–42, 351.
62. Curtin, J. J., D. E. McCarthy, M. E. Piper, and T. B. Baker. 2006. Implicit and explicit drug motivational processes: A model of boundary conditions. In *Handbook of implicit cognition and addiction*, ed. R. W. Wiers and A. W. Stacy, 233–50. Thousand Oaks, CA: Sage.
63. Robinson, T. E., and K. C. Berridge. 1993. The neural basis of drug craving: An incentive-sensitization theory of addiction. *Brain Research: Brain Research Reviews* 18 (3): 247–91.
64. Breiter, H. C., R. L. Gollub, R. M. Weisskoff, D. N. Kennedy, N. Makris, J. D. Berke, J. M. Goodman, et al. 1997. Acute effects of cocaine on human brain activity and emotion. *Neuron* 19 (3): 591–611.
65. Breiter, H. C., and B. R. Rosen. 1999. Functional magnetic resonance imaging of brain reward circuitry in the human. *Annals of the New York Academy of Sciences* 877: 523–47.
66. Aftanas, L., and S. Golosheykin. 2005. Impact of regular meditation practice on EEG activity at rest and during evoked negative emotions. *International Journal of Neuroscience* 115 (6): 893–909.
67. Rose, J. E., and W. A. Corrigan. 1997. Nicotine self-administration in animals and humans: Similarities and differences. *Psychopharmacology (Berl)* 130 (1): 28–40.
68. Malaiyandi, V., C. Lerman, N. L. Benowitz, C. Jepson, F. Patterson, and R. F. Tyndale. 2006. Impact of CYP2A6 genotype on pretreatment smoking behaviour and nicotine levels from and usage of nicotine replacement therapy. *Molecular Psychiatry* 11 (4): 400–409.
69. Siu, E. C., D. B. Wildenauer, and R. F. Tyndale. 2006. Nicotine self-administration in mice is associated with rates of nicotine inactivation by CYP2A5. *Psychopharmacology (Berl)* 184 (3–4): 401–8.
70. Schwid, S. R., M. D. Hirvonen, and R. E. Keesey. 1992. Nicotine effects on body weight: A regulatory perspective. *American Journal of Clinical Nutrition* 55 (4): 878–84.
71. Balfour, D. J. 2004. The neurobiology of tobacco dependence: A preclinical perspective on the role of the dopamine projections to the nucleus accumbens. *Nicotine & Tobacco Research* 6 (6): 899–912.
72. Kenny, P. J., and A. Markou. 2006. Nicotine self-administration acutely activates brain reward systems and induces a long-lasting increase in reward sensitivity. *Neuropsychopharmacology* 31 (6): 1203–11.
73. Shaham, Y., U. Shalev, L. Lu, H. De Wit, and J. Stewart. 2003. The reinstatement model of drug relapse: History, methodology and major findings. *Psychopharmacology (Berl)* 168 (1–2): 3–20.
74. Chaudhri, N., A. R. Caggiula, E. C. Donny, M. I. Palmatier, X. Liu, and A. F. Sved. 2006. Complex interactions between nicotine and nonpharmacological stimuli reveal multiple roles for nicotine in reinforcement. *Psychopharmacology (Berl)* 184 (3–4): 353–66.
75. Zinser, M. C., M. C. Fiore, R. J. Davidson, and T. B. Baker. 1999. Manipulating smoking motivation: Impact on an electrophysiological index of approach motivation. *Journal of Abnormal Psychology* 108 (2): 240–54.
76. Epping-Jordan, M. P., S. S. Watkins, G. F. Koob, and A. Markou. 1998. Dramatic decreases in brain reward function during nicotine withdrawal. *Nature* 393 (6680): 76–9.
77. True, W. R., H. Xian, J. F. Scherrer, P. A. Madden, K. K. Bucholz, A. C. Heath, S. A. Eisen, M. J. Lyons, J. Goldberg, and M. Tsuang. 1999. Common genetic vulnerability for nicotine and alcohol dependence in men. *Archives of General Psychiatry* 56 (7): 655–61.
78. McGue, M., I. Elkins, and W. G. Iacono. 2000. Genetic and environmental influences on adolescent substance use and abuse. *American Journal of Medical Genetics* 96 (5): 671–77.
79. Kendler, K. S., M. C. Neale, P. Sullivan, L. A. Corey, C. O. Gardner, and C. A. Prescott. 1999. A population-based twin study in women of smoking initiation and nicotine dependence. *Psychological Medicine* 29 (2): 299–308.
80. Boms, U., K. Silventoinen, P. A. Madden, A. C. Heath, and J. Kaprio. 2006. Genetic architecture of smoking behavior: A study of Finnish adult twins. *Twin Research and Human Genetics* 9 (1): 64–72.

81. Fowler, T., K. Lifford, K. Shelton, F. Rice, A. Thapar, M. C. Neale, A. McBride, and M. B. van den Bree. 2007. Exploring the relationship between genetic and environmental influences on initiation and progression of substance use. *Addiction* 102 (3): 413–22.
82. Greenbaum, L., K. Kanyas, O. Karni, Y. Merbl, T. Olender, A. Horowitz, A. Yakir, D. Lancet, E. Ben-Asher, and B. Lerer. 2006. Why do young women smoke? I: Direct and interactive effects of environment, psychological characteristics and nicotinic cholinergic receptor genes. *Molecular Psychiatry* 11 (3): 312–22, 223.
83. Munafó, M., E. Johnstone, M. Murphy, and R. Walton. 2001. New directions in the genetic mechanisms underlying nicotine addiction. *Addiction Biology* 6 (2): 109–117.
84. Pergadia, M. L., A. C. Heath, N. G. Martin, and P. A. Madden. 2006. Genetic analyses of DSM-IV nicotine withdrawal in adult twins. *Psychological Medicine* 36 (7): 963–72.
85. Sullivan, P. F., and K. S. Kendler. 1999. The genetic epidemiology of smoking. *Nicotine & Tobacco Research* 1 Suppl. 2: S51–S57, S69–S70.
86. Vink, J. M., A. L. Beem, D. Posthuma, M. C. Neale, G. Willemsen, K. S. Kendler, P. E. Slagboom, and D. I. Boomsma. 2004. Linkage analysis of smoking initiation and quantity in Dutch sibling pairs. *Pharmacogenomics Journal* 4 (4): 274–82.
87. Heath, A. C., K. M. Kirk, J. M. Meyer, and N. G. Martin. 1999. Genetic and social determinants of initiation and age at onset of smoking in Australian twins. *Behavior Genetics* 29 (6): 395–407.
88. Koopmans, J. R., W. S. Slutske, A. C. Heath, M. C. Neale, and D. I. Boomsma. 1999. The genetics of smoking initiation and quantity smoked in Dutch adolescent and young adult twins. *Behavior Genetics* 29 (6): 383–93.
89. Luczak, S. E., S. J. Glatt, and T. L. Wall. 2006. Meta-analyses of ALDH2 and ADH1B with alcohol dependence in Asians. *Psychological Bulletin* 132 (4): 607–21.
90. Quertemont, E. 2004. Genetic polymorphism in ethanol metabolism: Acetaldehyde contribution to alcohol abuse and alcoholism. *Molecular Psychiatry* 9 (6): 570–81.
91. Dierker, L. C., E. Donny, S. Tiffany, S. M. Colby, N. Perrine, and R. R. Clayton. 2007. The association between cigarette smoking and DSM-IV nicotine dependence among first year college students. *Drug and Alcohol Dependence* 86 (2–3): 106–14.
92. Lessov, C. N., N. G. Martin, D. J. Statham, A. A. Todorov, W. S. Slutske, K. K. Bucholz, A. C. Heath, and P. A. Madden. 2004. Defining nicotine dependence for genetic research: Evidence from Australian twins. *Psychological Medicine* 34 (5): 865–79.
93. Prokhorov, A. V., C. De Moor, U. E. Pallonen, K. S. Hudmon, L. Koehly, and S. Hu. 2000. Validation of the modified Fagerström tolerance questionnaire with salivary cotinine among adolescents. *Addictive Behaviors* 25 (3): 429–33.
94. Haberstick, B. C., D. Timberlake, M. A. Ehringer, J. M. Lessem, C. J. Hopfer, A. Smolen, and J. K. Hewitt. 2007. Genes, time to first cigarette and nicotine dependence in a general population sample of young adults. *Addiction* 102 (4): 655–65.
95. Piper, M. E., D. M. Bolt, S.-Y. Kim, S. J. Japuntich, S. S. Smith, and J. Niederdeppe. Forthcoming. A unique tobacco dependence phenotype suggests primary motives of tobacco dependence. *Journal of Abnormal Psychology*.
96. Muthén, B. 2006. Should substance use disorders be considered as categorical or dimensional? *Addiction* 101 Suppl. 1: 6–16.
97. Dijkstra, A., and D. Tromp. 2002. Is the FTND a measure of physical as well as psychological tobacco dependence? *Journal of Substance Abuse Treatment* 23 (4): 367–74.
98. Moolchan, E. T., A. Radzins, D. H. Epstein, G. Uhl, D. A. Gorelick, J. L. Cadet, and J. E. Henningfield. 2002. The Fagerström Test for Nicotine Dependence and the Diagnostic Interview Schedule: Do they diagnose the same smokers? *Addictive Behaviors* 27 (1): 101–13.
99. Everitt, B. J., and T. W. Robbins. 2005. Neural systems of reinforcement for drug addiction: From actions to habits to compulsion. *Nature Neuroscience* 8 (11): 1481–89.
100. Goedeker, K. C., and S. T. Tiffany. 2008. On the nature of nicotine addiction: A taxometric analysis. *Journal of Abnormal Psychology* 117 (4): 896–909.
101. Shiffman, S., and J. Paty. 2006. Smoking patterns and dependence: Contrasting chippers and heavy smokers. *Journal of Abnormal Psychology* 115 (3): 509–23.

102. Xian, H., J. F. Scherrer, S. A. Eisen, M. J. Lyons, M. Tsuang, W. R. True, and K. K. Bucholz. 2007. Nicotine dependence subtypes: Association with smoking history, diagnostic criteria and psychiatric disorders in 5440 regular smokers from the Vietnam Era Twin Registry. *Addictive Behaviors* 32 (1): 137–47.
103. Everitt, B. J., A. Dickinson, and T. W. Robbins. 2001. The neuropsychological basis of addictive behaviour. *Brain Research: Brain Research Reviews* 36 (2–3): 129–38.
104. Robbins, T. W., and B. J. Everitt. 1999. Drug addiction: bad habits add up. *Nature* 398 (6728): 567–70.
105. Bierut, L. J., P. A. Madden, N. Breslau, E. O. Johnson, D. Hatsukami, O. F. Pomerleau, G. E. Swan, et al. 2007. Novel genes identified in a high-density genome wide association study for nicotine dependence. *Human Molecular Genetics* 16 (1): 24–35.
106. Gelernter, J., C. Panhuysen, R. Weiss, K. Brady, J. Poling, M. Krauthammer, L. Farrer, and H. R. Kranzler. 2007. Genomewide linkage scan for nicotine dependence: Identification of a chromosome 5 risk locus. *Biological Psychiatry* 61 (1): 119–26.
107. Saccone, S. F., A. L. Hinrichs, N. L. Saccone, G. A. Chase, K. Konvicka, P. A. Madden, N. Breslau, et al. 2007. Cholinergic nicotinic receptor genes implicated in a nicotine dependence association study targeting 348 candidate genes with 3713 SNPs. *Human Molecular Genetics* 16 (1): 36–49.
108. Cui, Y., W. Wen, C. J. Moriarty, and R. S. Levine. 2006. Risk factors and their effects on the dynamic process of smoking relapse among veteran smokers. *Behavior Research and Therapy* 44 (7): 967–81.
109. Fernandez, E., A. Schiaffino, C. Borrell, J. Benach, C. Ariza, J. M. Ramon, J. Twose, M. Nebot, and A. Kunst. 2006. Social class, education, and smoking cessation: Long-term follow-up of patients treated at a smoking cessation unit. *Nicotine & Tobacco Research* 8 (1): 29–36.
110. Manchon Walsh, P., P. Carrillo, G. Flores, C. Masuet, S. Morchon, and J. M. Ramon. 2007. Effects of partner smoking status and gender on long term abstinence rates of patients receiving smoking cessation treatment. *Addictive Behaviors* 32 (1): 128–36.
111. Swan, G. E., H. S. Javitz, L. M. Jack, S. J. Curry, and T. McAfee. 2004. Heterogeneity in 12-month outcome among female and male smokers. *Addiction* 99 (2): 237–50.
112. Fagerström, K. O., and N. G. Schneider. 1989. Measuring nicotine dependence: A review of the Fagerström Tolerance Questionnaire. *Journal of Behavioral Medicine* 12 (2): 159–82.
113. Hughes, J. R., and D. Hatsukami. 1986. Signs and symptoms of tobacco withdrawal. *Archives of General Psychiatry* 43 (3): 289–94.
114. Kenford, S. L., S. S. Smith, D. W. Wetter, D. E. Jorenby, M. C. Fiore, and T. B. Baker. 2002. Predicting relapse back to smoking: Contrasting affective and physical models of dependence. *Journal of Consulting and Clinical Psychology* 70 (1): 216–27.
115. McCarthy, D. E., T. M. Piasecki, M. C. Fiore, and T. B. Baker. 2006. Life before and after quitting smoking: An electronic diary study. *Journal of Abnormal Psychology* 115 (3): 454–66.
116. Nichter, M., M. Nichter, P. J. Thompson, S. Shiffman, and A. B. Moscicki. 2002. Using qualitative research to inform survey development on nicotine dependence among adolescents. *Drug and Alcohol Dependence* 68 Suppl. 1: S41–S56.
117. Tiffany, S. T., C. A. Conklin, S. Shiffman, and R. R. Clayton. 2004. What can dependence theories tell us about assessing the emergence of tobacco dependence? *Addiction* 99 Suppl. 1: 78–86.
118. Lesch, O. M., A. Dvorak, I. Hertling, A. Klingler, M. Kunze, K. Ramskogler, G. Saletu-Zyhlarz, R. Schoberberger, and H. Walter. 2004. The Austrian Multicentre Study on Smoking: Subgroups of nicotine dependence and their craving. *Neuropsychobiology* 50 (1): 78–88.
119. Madden, P. A., K. K. Bucholz, S. H. Dinwiddie, W. S. Slutske, L. J. Bierut, D. J. Statham, M. P. Dunne, N. G. Martin, and A. C. Heath. 1997. Nicotine withdrawal in women. *Addiction* 92 (7): 889–902.
120. Storr, C. L., H. Zhou, K.-Y. Liang, and J. C. Anthony. 2004. Empirically derived latent classes of tobacco dependence syndromes observed in recent-onset tobacco smokers: Epidemiological evidence from a national probability sample survey. *Nicotine & Tobacco Research* 6 (3): 533–45.

3. The Nicotine-Dependence Phenotype

121. Benowitz, N. L., O. F. Pomerleau, C. S. Pomerleau, and P. Jacob 3rd. 2003. Nicotine metabolite ratio as a predictor of cigarette consumption. *Nicotine & Tobacco Research* 5 (5): 621–24.
122. Xian, H., J. F. Scherrer, P. A. Madden, M. J. Lyons, M. Tsuang, W. R. True, and S. A. Eisen. 2003. The heritability of failed smoking cessation and nicotine withdrawal in twins who smoked and attempted to quit. *Nicotine & Tobacco Research* 5 (2): 245–54.
123. Xian, H., J. F. Scherrer, P. A. Madden, M. J. Lyons, M. Tsuang, W. R. True, and S. A. Eisen. 2005. Latent class typology of nicotine withdrawal: Genetic contributions and association with failed smoking cessation and psychiatric disorders. *Psychological Medicine* 35 (3): 409–19.
124. Furberg, H., P. F. Sullivan, H. Maes, C. A. Prescott, C. Lerman, C. Bulik, and K. S. Kendler. 2005. The types of regular cigarette smokers: A latent class analysis. *Nicotine & Tobacco Research* 7 (3): 351–60.
125. Breslau, N. 1995. Psychiatric comorbidity of smoking and nicotine dependence. *Behavior Genetics* 25 (2): 95–101.
126. Milberger, S., J. Biederman, S. V. Faraone, L. Chen, and J. Jones. 1997. ADHD is associated with early initiation of cigarette smoking in children and adolescents. *Journal of the American Academy of Child & Adolescent Psychiatry* 36 (1): 37–44.
127. Hertling, I., K. Ramskogler, A. Dvorak, A. Klingler, G. Saletu-Zyhlarz, R. Schoberberger, H. Walter, M. Kunze, and O. M. Lesch. 2005. Craving and other characteristics of the comorbidity of alcohol and nicotine dependence. *European Psychiatry* 20 (5–6): 442–50.
128. Agrawal, A., A. C. Heath, J. D. Grant, M. L. Pergadia, D. J. Statham, K. K. Bucholz, N. G. Martin, and P. A. Madden. 2006. Assortive mating for cigarette smoking and for alcohol consumption in female Australian twins and their spouses. *Behavior Genetics* 36 (4): 553–66.
129. Swan, G. E., D. Carmelli, and L. R. Cardon. 1997. Heavy consumption of cigarettes, alcohol and coffee in male twins. *Journal of Studies on Alcohol* 58 (2): 182–90.
130. Cooper, M. L., P. K. Wood, H. K. Orcutt, and A. Albino. 2003. Personality and the predisposition to engage in risky or problem behaviors during adolescence. *Journal of Personality and Social Psychology* 84 (2): 390–410.
131. Elkins, I. J., S. M. King, M. McGue, and W. G. Iacono. 2006. Personality traits and the development of nicotine, alcohol, and illicit drug disorders: Prospective links from adolescence to young adulthood. *Journal of Abnormal Psychology* 115 (1): 26–39.
132. Grove, W. M., E. D. Eckert, L. Heston, T. J. Bouchard Jr, N. Segal, and D. T. Lykken. 1990. Heritability of substance abuse and antisocial behavior: A study of monozygotic twins reared apart. *Biological Psychiatry* 27 (12): 1293–304.
133. Hicks, B. M., R. F. Krueger, W. G. Iacono, M. McGue, and C. J. Patrick. 2004. Family transmission and heritability of externalizing disorders: A twin-family study. *Archives of General Psychiatry* 61 (9): 922–28.
134. Kendler, K. S., C. G. Davis, and R. C. Kessler. 1997. The familial aggregation of common psychiatric and substance use disorders in the National Comorbidity Survey: A family history study. *British Journal of Psychiatry* 170: 541–48.
135. Pickens, R. W., D. S. Svikis, M. McGue, and M. C. LaBuda. 1995. Common genetic mechanisms in alcohol, drug, and mental disorder comorbidity. *Drug and Alcohol Dependence* 39 (2): 129–38.
136. Slutske, W. S., A. C. Heath, S. H. Dinwiddie, P. A. Madden, K. K. Bucholz, M. P. Dunne, D. J. Statham, and N. G. Martin. 1998. Common genetic risk factors for conduct disorder and alcohol dependence. *Journal of Abnormal Psychology* 107 (3): 363–74.
137. Slutske, W. S., A. C. Heath, P. A. Madden, K. K. Bucholz, D. J. Statham, and N. G. Martin. 2002. Personality and the genetic risk for alcohol dependence. *Journal of Abnormal Psychology* 111 (1): 124–33.
138. Perkins, K. A., T. Doyle, M. Ciccocioppo, C. Conklin, M. Sayette, and A. Caggiula. 2006. Sex differences in the influence of nicotine dose instructions on the reinforcing and self-reported rewarding effects of smoking. *Psychopharmacology (Berl)* 184 (3–4): 600–607.
139. Chaudhri, N., A. R. Caggiula, E. C. Donny, S. Booth, M. A. Gharib, L. A. Craven, S. S. Allen, A. F. Sved, and K. A. Perkins. 2005. Sex differences in the contribution of nicotine and nonpharmacological stimuli to nicotine self-administration in rats. *Psychopharmacology (Berl)* 180 (2): 258–66.
140. Agrawal, A., M. T. Lynskey, P. A. Madden, K. K. Bucholz, and A. C. Heath. 2007. A latent class analysis of illicit drug abuse/

- dependence: Results from the National Epidemiological Survey on Alcohol and Related Conditions. *Addiction* 102 (1): 94–104.
141. Hu, M. C., M. Davies, and D. B. Kandel. 2006. Epidemiology and correlates of daily smoking and nicotine dependence among young adults in the United States. *American Journal of Public Health* 96 (2): 299–308.
 142. Swan, G. E., and C. N. Lessov. 2004. Gene-environment interaction in nicotine addiction: The need for a large-scale, collaborative effort. *Substance Use and Misuse* 39 (10–12): 2083–5.
 143. Moffitt, T. E., A. Caspi, and M. Rutter. 2005. Strategy for investigating interactions between measured genes and measured environments. *Archives of General Psychiatry* 62 (5): 473–81.
 144. Anda, R. F., J. B. Croft, V. J. Felitti, D. Nordenberg, W. H. Giles, D. F. Williamson, and G. A. Giovino. 1999. Adverse childhood experiences and smoking during adolescence and adulthood. *JAMA: The Journal of the American Medical Association* 282 (17): 1652–58.
 145. Breslau, N., and E. L. Peterson. 1996. Smoking cessation in young adults: Age at initiation of cigarette smoking and other suspected influences. *American Journal of Public Health* 86 (2): 214–20.
 146. Brome, U., K. Silventoinen, E. Lahelma, M. Koskenvuo, and J. Kaprio. 2004. Smoking cessation by socioeconomic status and marital status: The contribution of smoking behavior and family background. *Nicotine & Tobacco Research* 6 (3): 447–55.
 147. Chen, K., and D. B. Kandel. 1995. The natural history of drug use from adolescence to the mid-thirties in a general population sample. *American Journal of Public Health* 85 (1): 41–47.
 148. Hirschman, R. S., H. Leventhal, and K. Glynn. 1984. The development of smoking behavior: Conceptualization and supportive cross-sectional survey data. *Journal of Applied Social Psychology* 14 (3): 184–206.
 149. Chen, X., B. Stanton, S. Shankaran, and X. Li. 2006. Age of smoking onset as a predictor of smoking cessation during pregnancy. *American Journal of Health Behavior* 30 (3): 247–58.
 150. John, U., C. Meyer, U. Hapke, and H. J. Rumpf. 2004. Nicotine dependence and lifetime amount of smoking in a population sample. *European Journal of Public Health* 14 (2): 182–85.
 151. Grant, B. F. 1998. Age at smoking onset and its association with alcohol consumption and DSM-IV alcohol abuse and dependence: Results from the National Longitudinal Alcohol Epidemiologic Survey. *Journal of Substance Abuse* 10 (1): 59–73.
 152. John, U., C. Meyer, U. Hapke, H. J. Rumpf, and A. Schumann. 2004. Nicotine dependence, quit attempts, and quitting among smokers in a regional population sample from a country with a high prevalence of tobacco smoking. *Preventive Medicine* 38 (3): 350–58.
 153. Robinson, M. L., I. Berlin, and E. T. Moolchan. 2004. Tobacco smoking trajectory and associated ethnic differences among adolescent smokers seeking cessation treatment. *Journal of Adolescent Health* 35 (3): 217–24.
 154. Adriani, W., S. Spijker, V. Deroche-Gamonet, G. Laviola, M. Le Moal, A. B. Smit, and P. V. Piazza. 2003. Evidence for enhanced neurobehavioral vulnerability to nicotine during periadolescence in rats. *Journal of Neuroscience* 23 (11): 4712–16.
 155. Cruz, F. C., R. Delucia, and C. S. Planeta. 2005. Differential behavioral and neuroendocrine effects of repeated nicotine in adolescent and adult rats. *Pharmacology, Biochemistry, and Behavior* 80 (3): 411–17.
 156. Schochet, T. L., A. E. Kelley, and C. F. Landry. 2004. Differential behavioral effects of nicotine exposure in adolescent and adult rats. *Psychopharmacology (Berl)* 175 (3): 265–73.
 157. Slotkin, T. A. 2002. Nicotine and the adolescent brain: Insights from an animal model. *Neurotoxicology and Teratology* 24 (3): 369–84.
 158. Adriani, W., S. Macri, R. Pacifici, and G. Laviola. 2002. Peculiar vulnerability to nicotine oral self-administration in mice during early adolescence. *Neuropsychopharmacology* 27 (2): 212–14.
 159. Belluzzi, J. D., A. G. Lee, H. S. Oliff, and F. M. Leslie. 2004. Age-dependent effects of nicotine on locomotor activity and conditioned place preference in rats. *Psychopharmacology (Berl)* 174 (3): 389–95.
 160. O'Dell, L. E., A. W. Bruijnzeel, S. Ghozland, A. Markou, and G. F. Koob. 2004. Nicotine

- withdrawal in adolescent and adult rats. *Annals of the New York Academy of Sciences* 1021:167–74.
161. Shram, M. J., D. Funk, Z. Li, and A. D. Le. 2006. Periadolescent and adult rats respond differently in tests measuring the rewarding and aversive effects of nicotine. *Psychopharmacology (Berl)* 186 (2): 201–8.
 162. Vastola, B. J., L. A. Douglas, E. I. Varlinskaya, and L. P. Spear. 2002. Nicotine-induced conditioned place preference in adolescent and adult rats. *Physiology & Behavior* 77 (1): 107–14.
 163. Levin, E. D., A. H. Rezvani, D. Montoya, J. E. Rose, and H. S. Swartzwelder. 2003. Adolescent-onset nicotine self-administration modeled in female rats. *Psychopharmacology (Berl)* 169 (2): 141–49.
 164. Weiss, R. B., T. B. Baker, D. S. Cannon, A. von Niederhausern, D. M. Dunn, N. Matsumami, N. A. Singh, et al. 2008. A candidate gene approach identifies the CHR5A5-A3-B4 region as a risk factor for age-dependent nicotine addiction. *PLoS Genetics* 4 (7): e1000125.
 165. Baker, T. B., R. B. Weiss, D. Bolt, von Niederhausern A., M. C. Fiore, and et al. Forthcoming. Human neuronal acetylcholine receptor A5-A3-B4 haplotypes are associated with multiple nicotine dependence phenotypes. *Nicotine & Tobacco Research*.
 166. Koob, G. F. 2006. The neurobiology of addiction: A neuroadaptational view relevant for diagnosis. *Addiction* 101 Suppl. 1: 23–30.
 167. Sinha, R., M. Garcia, P. Paliwal, M. J. Kreek, and B. J. Rounsaville. 2006. Stress-induced cocaine craving and hypothalamic-pituitary-adrenal responses are predictive of cocaine relapse outcomes. *Archives of General Psychiatry* 63 (3): 324–31.
 168. Hu, S., C. L. Brody, C. Fisher, L. Gunzerath, M. L. Nelson, S. Z. Sabol, L. A. Sirota, et al. 2000. Interaction between the serotonin transporter gene and neuroticism in cigarette smoking behavior. *Molecular Psychiatry* 5 (2): 181–88.
 169. Lerman, C., N. E. Caporaso, J. Audrain, D. Main, N. R. Boyd, and P. G. Shields. 2000. Interacting effects of the serotonin transporter gene and neuroticism in smoking practices and nicotine dependence. *Molecular Psychiatry* 5 (2): 189–92.
 170. Kremer, I., R. Bachner-Melman, A. Reshef, L. Broude, L. Nemanov, I. Gritsenko, U. Heresco-Levy, Y. Elizur, and R. P. Ebstein. 2005. Association of the serotonin transporter gene with smoking behavior. *American Journal of Psychiatry* 162 (5): 924–30.
 171. Gerra, G., L. Garofano, A. Zaimovic, G. Moi, B. Branchi, M. Bussandri, F. Brambilla, and C. Donnini. 2005. Association of the serotonin transporter promoter polymorphism with smoking behavior among adolescents. *American Journal of Medical Genetics Part B, Neuropsychiatric Genetics* 135 (1): 73–78.
 172. Evans, G. W. 2004. The environment of childhood poverty. *American Psychologist* 59 (2): 77–92.
 173. Rutter, M., and D. Quinton. 1977. Psychiatric disorder: Ecological factors and concepts of causation. In *Ecological factors in human development*, ed. H. McGurk, 173–87. Amsterdam: North Holland Publishing.
 174. Piasecki, T. M., D. E. Jorenby, S. S. Smith, M. C. Fiore, and T. B. Baker. 2003. Smoking withdrawal dynamics: I. Abstinence distress in lapsers and abstainers. *Journal of Abnormal Psychology* 112 (1): 3–13.
 175. Hudmon, K. S., C. S. Pomerleau, J. Brigham, H. Javitz, and G. E. Swan. 2005. Validity of retrospective assessments of nicotine dependence: A preliminary report. *Addictive Behaviors* 30 (3): 613–37.
 176. Huerta, M., G. Chodick, R. D. Balicer, N. Davidovitch, and I. Grotto. 2005. Reliability of self-reported smoking history and age at initial tobacco use. *Preventive Medicine* 41 (2): 646–50.
 177. Shiffman, S., C. J. Gwaltney, M. H. Balabanis, K. S. Liu, J. A. Paty, J. D. Kassel, M. Hickcox, and M. Gnys. 2002. Immediate antecedents of cigarette smoking: An analysis from ecological momentary assessment. *Journal of Abnormal Psychology* 111 (4): 531–45.
 178. Pan, W. H., K. S. Lynn, C. H. Chen, Y. L. Wu, C. Y. Lin, and H. Y. Chang. 2006. Using endophenotypes for pathway clusters to map complex disease genes. *Genetic Epidemiology* 30 (2): 143–54.
 179. Kammerer, C. M., N. Gouin, P. B. Samollow, J. F. VandeBerg, J. E. Hixson, S. A. Cole, J. W. MacCluer, and L. D. Atwood. 2004. Two quantitative trait loci affect ACE activities in Mexican-Americans. *Hypertension* 43 (2): 466–70.
 180. Gottesman, I. I., and J. Shields. 1972. *Schizophrenia and genetics: A twin study vantage point*. New York: Academic Press.

181. Meyer-Lindenberg, A., and D. R. Weinberger. 2006. Intermediate phenotypes and genetic mechanisms of psychiatric disorders. *Nature Reviews Neuroscience* 7 (10): 818–27.
182. Gottesman, I. I., and T. D. Gould. 2003. The endophenotype concept in psychiatry: Etymology and strategic intentions. *American Journal of Psychiatry* 160 (4): 636–45.
183. Smith, G. D., and S. Ebrahim. 2004. Mendelian randomization: Prospects, potentials, and limitations. *International Journal of Epidemiology* 33 (1): 30–42.
184. Brody, A. L., M. A. Mandelkern, E. D. London, A. R. Childress, G. S. Lee, R. G. Bota, M. L. Ho, et al. 2002. Brain metabolic changes during cigarette craving. *Archives of General Psychiatry* 59 (12): 1162–72.
185. Erblich, J., C. Lerman, D. W. Self, G. A. Diaz, and D. H. Bovbjerg. 2005. Effects of dopamine D2 receptor (DRD2) and transporter (SLC6A3) polymorphisms on smoking cue-induced cigarette craving among African-American smokers. *Molecular Psychiatry* 10 (4): 407–14.
186. Hutchison, K. E., H. LaChance, R. Niaura, A. Bryan, and A. Smolen. 2002. The DRD4 VNTR polymorphism influences reactivity to smoking cues. *Journal of Abnormal Psychology* 111 (1): 134–43.
187. Swan, G. E., A. M. Valdes, H. Z. Ring, T. V. Khroyan, L. M. Jack, C. C. Ton, S. J. Curry, and T. McAfee. 2005. Dopamine receptor DRD2 genotype and smoking cessation outcome following treatment with bupropion SR. *Pharmacogenomics Journal* 5 (1): 21–29.
188. Boustead, C., H. Taber, J. R. Idle, and S. Cholerton. 1997. CYP2D6 genotype and smoking behaviour in cigarette smokers. *Pharmacogenetics* 7 (5): 411–14.
189. Garcia-Closas, M., N. Caporaso, K. Kelsey, and D. Christiani. 1997. Association between CYP1A1 polymorphism and smoking in a control population: Implications for the study of genetic factors on cancer risk. Abstract. *Proceedings of the American Association for Cancer Research* 38: 211.
190. Pianezza, M. L., E. M. Sellers, and R. F. Tyndale. 1998. Nicotine metabolism defect reduces smoking. *Nature* 393 (6687): 750.
191. Caspi, A., J. McClay, T. E. Moffitt, J. Mill, J. Martin, I. W. Craig, A. Taylor, and R. Poulton. 2002. Role of genotype in the cycle of violence in maltreated children. *Science* 297 (5582): 851–54.
192. Barik, J., and S. Wonnacott. 2006. Indirect modulation by alpha7 nicotinic acetylcholine receptors of noradrenaline release in rat hippocampal slices: Interaction with glutamate and GABA systems and effect of nicotine withdrawal. *Molecular Pharmacology* 69 (2): 618–28.
193. Grabus, S. D., B. R. Martin, and M. Imad Damaj. 2005. Nicotine physical dependence in the mouse: Involvement of the alpha7 nicotinic receptor subtype. *European Journal of Pharmacology* 515 (1–3): 90–93.
194. Krystal, J. H., J. Staley, G. Mason, I. L. Petrakis, J. Kaufman, R. A. Harris, J. Gelernter, and J. Lappalainen. 2006. Gamma-aminobutyric acid type A receptors and alcoholism: Intoxication, dependence, vulnerability, and treatment. *Archives of General Psychiatry* 63 (9): 957–68.
195. Nomikos, G. G., B. Schilström, B. E. Hildebrand, G. Panagis, J. Grenhoff, and T. H. Svensson. 2000. Role of alpha7 nicotinic receptors in nicotine dependence and implications for psychiatric illness. *Behavioural Brain Research* 113 (1–2): 97–103.
196. Caspi, A., K. Sugden, T. E. Moffitt, A. Taylor, I. W. Craig, H. Harrington, J. McClay, et al. 2003. Influence of life stress on depression: Moderation by a polymorphism in the 5-HTT gene. *Science* 301 (5631): 386–89.
197. Hariri, A. R., E. M. Drabant, K. E. Munoz, B. S. Kolachana, V. S. Mattay, M. F. Egan, and D. R. Weinberger. 2005. A susceptibility gene for affective disorders and the response of the human amygdala. *Archives of General Psychiatry* 62 (2): 146–52.
198. Hariri, A. R., V. S. Mattay, A. Tessitore, B. Kolachana, F. Fera, D. Goldman, M. F. Egan, and D. R. Weinberger. 2002. Serotonin transporter genetic variation and the response of the human amygdala. *Science* 297 (5580): 400–403.
199. Heinz, A., D. F. Braus, M. N. Smolka, J. Wrase, I. Puls, D. Hermann, S. Klein, et al. 2005. Amygdala-prefrontal coupling depends on a genetic variation of the serotonin transporter. *Nature Neuroscience* 8 (1): 20–21.
200. Berridge, K. C., and T. E. Robinson. 1998. What is the role of dopamine in reward: Hedonic impact, reward learning, or incentive salience? *Brain Research: Brain Research Reviews* 28 (3): 309–69.

3. The Nicotine-Dependence Phenotype

201. Due, D. L., S. A. Huettel, W. G. Hall, and D. C. Rubin. 2002. Activation in mesolimbic and visuospatial neural circuits elicited by smoking cues: Evidence from functional magnetic resonance imaging. *American Journal of Psychiatry* 159 (6): 954–60.
202. Gloria, R., H. Shaefer, J. Davis, M. Majeskie, B. Richmond, R. J. Davidson, and T. B. Baker. 2005. Impact of withdrawal of nicotine expectancy: An fMRI investigation of regional brain activity. Poster presented at the annual meeting of the Society for Psychophysiological Research, Lisbon.
203. Bierut, L. J., J. P. Rice, H. J. Edenberg, A. Goate, T. Foroud, C. R. Cloninger, H. Begleiter, et al. 2000. Family-based study of the association of the dopamine D2 receptor gene (DRD2) with habitual smoking. *American Journal of Medical Genetics* 90 (4): 299–302.
204. Meyer-Lindenberg, A., J. W. Buckholtz, B. Kolachana, A. R. Hariri, L. Pezawas, G. Blasi, A. Wabnitz, et al. 2006. Neural mechanisms of genetic risk for impulsivity and violence in humans. *Proceedings of the National Academy of Sciences of the United States of America* 103 (16): 6269–74.
205. Botvinick, M. M., T. S. Braver, D. M. Barch, C. S. Carter, and J. D. Cohen. 2001. Conflict monitoring and cognitive control. *Psychological Review* 108 (3): 624–52.
206. Fan, J., J. Fossella, T. Sommer, Y. Wu, and M. I. Posner. 2003. Mapping the genetic variation of executive attention onto brain activity. *Proceedings of the National Academy of Sciences of the United States of America* 100 (12): 7406–11.
207. Volkow, N. D., J. S. Fowler, and G. J. Wang. 2004. The addicted human brain viewed in the light of imaging studies: brain circuits and treatment strategies. *Neuropharmacology* 47 Suppl 1: 3–13.
208. Patrick, C. J., E. M. Bernat, S. M. Malone, W. G. Iacono, R. F. Krueger, and M. McGue. 2006. P300 amplitude as an indicator of externalizing in adolescent males. *Psychophysiology* 43 (1): 84–92.
209. Vitale, J. E., J. P. Newman, J. E. Bates, J. Goodnight, K. A. Dodge, and G. S. Pettit. 2005. Deficient behavioral inhibition and anomalous selective attention in a community sample of adolescents with psychopathic traits and low-anxiety traits. *Journal of Abnormal and Child Psychology* 33 (4): 461–70.
210. Chassin, L., D. B. Fora, and K. M. King. 2004. Trajectories of alcohol and drug use and dependence from adolescence to adulthood: The effects of familial alcoholism and personality. *Journal of Abnormal Psychology* 113 (4): 483–98.
211. Pezawas, L., A. Meyer-Lindenberg, E. M. Drabant, B. A. Verchinski, K. E. Munoz, B. S. Kolachana, M. F. Egan, V. S. Mattay, A. R. Hariri, and D. R. Weinberger. 2005. 5-HTTLPR polymorphism impacts human cingulate-amygdala interactions: A genetic susceptibility mechanism for depression. *Nature Neuroscience* 8 (6): 828–34.
212. Hendricks, P. S., J. W. Ditte, D. J. Drobes, and T. H. Brandon. 2006. The early time course of smoking withdrawal effects. *Psychopharmacology (Berl)* 187 (3): 385–96.
213. Vink, J. M., G. Willemsen, and D. I. Boomsma. 2005. Heritability of smoking initiation and nicotine dependence. *Behavior Genetics* 35 (4): 397–406.
214. Belluzzi, J. D., R. Wang, and F. M. Leslie. 2005. Acetaldehyde enhances acquisition of nicotine self-administration in adolescent rats. *Neuropsychopharmacology* 30 (4): 705–12.
215. John, U., C. Meyer, H. J. Rumpf, and U. Hapke. 2004. Self-efficacy to refrain from smoking predicted by major depression and nicotine dependence. *Addictive Behaviors* 29 (5): 857–66.
216. Preacher, K. J., D. D. Rucker, R. C. MacCallum, and W. A. Nicewander. 2005. Use of the extreme groups approach: A critical reexamination and new recommendations. *Psychological Methods* 10 (2): 178–92.
217. Golden, R. R., and M. J. Mayer. 1994. Peaked indicators: A source of pseudotaxonicity of a latent trait. In *Assessing individual differences in human behavior: New concepts, methods, and findings*, ed. D. Lubinski and R. V. Dawis, 93–105. Palo Alto, CA: Davies-Black.
218. Haslam, N., and H. C. Kim. 2002. Categories and continua: A review of taxometric research. *Genetic, Social, and General Psychology Monographs* 128 (3): 271–320.
219. Dawes, R. M. 1979. The robust beauty of improper linear models in decision making. *American Psychologist* 34 (7): 571–82.
220. Hastie, T., R. Tibshirani, and J. Friedman. 2001. *The elements of statistical learning*. New York: Springer.

221. Carlsten, C., and W. Burke. 2006. Potential for genetics to promote public health: Genetics research on smoking suggests caution about expectations. *JAMA: The Journal of the American Medical Association* 296 (20): 2480–82.
222. Lerman, C., and G. E. Swan. 2002. Non-replication of genetic association studies: Is DAT all, folks? *Nicotine & Tobacco Research* 4 (3): 247–9.
223. Hunter, D. J. 2006. Genomics and proteomics in epidemiology: Treasure trove or “high-tech stamp collecting”? *Epidemiology* 17 (5): 487–89.
224. Greenland, S. 2000. When should epidemiologic regressions use random coefficients? *Biometrics* 56 (3): 915–21.
225. Greenland, S., J. A. Schwartzbaum, and W. D. Finkle. 2000. Problems due to small samples and sparse data in conditional logistic regression analysis. *American Journal of Epidemiology* 151 (5): 531–39.
226. Greenland, S. 1993. Methods for epidemiologic analyses of multiple exposures: A review and comparative study of maximum-likelihood, preliminary-testing, and empirical-Bayes regression. *Statistics in Medicine* 12 (8): 717–36.
227. Robins, J. M., and S. Greenland. 1986. The role of model selection in causal inference from nonexperimental data. *American Journal of Epidemiology* 123 (3): 392–402.
228. Thomas, D. C. 2005. The need for a systematic approach to complex pathways in molecular epidemiology. *Cancer Epidemiology, Biomarkers & Prevention* 14 (3): 557–9.
229. Thomas, D. C. 2006. High-volume “-omics” technologies and the future of molecular epidemiology. *Epidemiology* 17 (5): 490–91.
230. Conti, D. V., and J. S. Witte. 2003. Hierarchical modeling of linkage disequilibrium: Genetic structure and spatial relations. *American Journal of Human Genetics* 72 (2): 351–63.
231. Greenland, S. 2000. Principles of multilevel modelling. *International Journal of Epidemiology* 29 (1): 158–67.
232. Witte, J. S. 1997. Genetic analysis with hierarchical models. *Genetic Epidemiology* 14 (6): 1137–42.
233. Witte, J. S., S. Greenland, R. W. Haile, and C. L. Bird. 1994. Hierarchical regression analysis applied to a study of multiple dietary exposures and breast cancer. *Epidemiology* 5 (6): 612–21.
234. Conti, D. V., V. Cortessis, J. Molitor, and D. C. Thomas. 2003. Bayesian modeling of complex metabolic pathways. *Human Heredity* 56 (1–3): 83–93.
235. Conti, D. V., and W. J. Gauderman. 2004. SNPs, haplotypes, and model selection in a candidate gene region: The SIMPLe analysis for multilocus data. *Genetic Epidemiology* 27 (4): 429–41.
236. Cortessis, V., and D. C. Thomas. 2003. Toxicokinetic genetics: An approach to gene-environment and gene-gene interactions in complex metabolic pathways. In *Mechanistic considerations in the molecular epidemiology of cancer*, ed. P. Bird, P. Boffetta, P. Buffler, and J. Rice, 127–50. Lyon, France: IARC Scientific Publications.
237. Brennan, P. 2004. Commentary: Mendelian randomization and gene-environment interaction. *International Journal of Epidemiology* 33 (1): 17–21.
238. Thomas, D. C., and D. V. Conti. 2004. Commentary: The concept of ‘Mendelian randomization’. *International Journal of Epidemiology* 33 (1): 21–25.

4

Mouse Models and the Genetics of Nicotine Dependence

Scott W. Rogers, Thomas J. Gould, and Timothy B. Baker

Detailed studies of inbred mouse strains have provided remarkable insights into how genetics shape complex processes, ranging from cancer susceptibility to immunity. The mouse models of response to addictive substances such as nicotine are now showing similar promise for revealing the underlying complex genetics and physiological mechanisms contributing to dependence. This chapter examines key issues in using mouse models for nicotine dependence, including

- *The molecular biology of the nicotinic acetylcholine receptors and how these receptors contribute to tissue-specific responses within the context of strain-specific genetic background*
- *The interaction of nicotine with physiological systems through oral, intravenous, and subcutaneous administration and how experimental results from these routes of administration in mice may relate to the physiology of human smoking*
- *The way mouse models recapitulate many basic features of nicotine dependence in humans, including behavioral reinforcement, self-administration, development of tolerance, and altered reward-related behavior*

On the basis of available evidence, and given its receptiveness to genetic manipulation, the mouse model appears to hold promise as a powerful tool for understanding how genetics and behavioral measures combine to individualize the response to nicotine.

The analyses described herein were supported by National Institute of Health grants AA015515, AG17517, CA/DA84718, CA/DA19706, DA01749, and HL72903. The authors acknowledge the Val A. Browning Charitable Foundation of Utah.

Introduction

This chapter provides an evidence-based review of issues in using mouse models for genetic research in nicotine dependence, including the biology of neuronal nicotinic acetylcholine receptors (nAChRs), issues in the administration and metabolism of nicotine, experimental design, and strain selection considerations, and aspects of behavioral responses to nicotine in mice. These factors all contribute to a knowledge base for the design of effective mouse model research that, in turn, may contribute to further understanding of the genetic basis of nicotine dependency in humans.

Experimentally defining the genetics that shape the brain—and ultimately the behaviors it controls, such as those leading to the complex outcomes of dependence—is a challenging but promising endeavor. Humans and mice share a close genetic and physiological relationship; comparisons of the human and mouse genomes indicate 85% identity. These genomes compare favorably in their susceptibility to many simple and complex genetic diseases including those related to addictive drugs such as nicotine. Intensive inbreeding has provided many hundreds of genetically isogenic strains with phenotypically distinct features that have been very successfully exploited to identify and often define the genetics of well over 100 models of human disease.¹ Some mouse strains also display responses that closely parallel responses and behaviors seen in humans. These strain-specific genetic characteristics are stable over decades of inbreeding,² providing considerable stability in gene-phenotype relations. Mice have additional features conducive to long-term developmental research—for example, relatively small size, economical maintenance, and rapid development.

Factors such as these, together with the species' amenability to genetic manipulation, allow for the study of complex genetic contributions to behaviors that occur in a nexus of physical maturation and environmental exposure. Consistent with these virtues, mouse strains were recognized more than four decades ago³ as a resource for examining the distinct and often highly varied responses to nicotine on behavior. Subsequent studies have extended these early observations to provide considerable insight into how the genetics of this animal model can be exploited to examine a broad range of mechanisms through which nicotine imparts its effects, including possible physiological substrata of nicotine dependence.⁴⁻⁸

At the same time, caution is needed when embarking upon experiments using the mouse model system. Among the most important is the consideration that behavioral-genetic relations are fine-tuned over the natural history of this species. Thus, mice may—or may not—be physically able or behaviorally motivated to perform tasks that would be appropriate for closely related species such as rats.² Therefore, each experiment and finding must be evaluated as to species-specific response to stressors (e.g., noise, time of day, handling); appropriateness of experimental manipulations, equipment, and assessment strategy (e.g., platform height, visual lines); and strain and species limitations in behavioral and adaptive repertoires (e.g., congenital retinal degeneration in C3H mice).

Animal models of dependence not only involve inferences and generalizations across species (e.g., mouse to human), but they also involve inferences and generalizations across behavioral and physiological phenomena. Investigations are predicated on the assumption that the behaviors (e.g., conditioned place preferences) and physiological responses (e.g., receptor

upregulation) observed have relevance to human dependence. Thus, experimental procedures must be appropriate for both the organism and for transspecific inferences regarding dependence processes. Investigators must not only consider species and strain differences, and the validity of their dependence assays, but they must also consider other issues, such as developmental processes and how these may affect the biological and behavioral processes relevant to dependence, as well as render behavioral assays that are more or less appropriate.

Of course, dependence phenomena are, no doubt, affected by multiple gene-phenotype relations. This means that the considerations and caveats listed above may be conditional upon the particular genetic variants targeted. Different variants will exert different influences on biological and behavioral processes, and these will show different patterns as a function of development, strain and species, and dependence assay. Thus, a significant goal of genetic mapping of nicotine dependence in the mouse is the strategic selection of experimental strategies that (1) are appropriate for the behavioral repertoire of the organism, (2) target behavioral and biological processes of relevance to clinical dependence phenomena, (3) are developmentally appropriate both in terms of the animal's repertoire and in terms of targeted dependence processes, and, perhaps most important, (4) cosegregate with the targeted genetic variants.

Within this context, an overview is provided of what is known of how gene function, within the context of mouse-strain-specific anatomical architecture and physiology, can shape the varied behavioral responses to nicotine. This overview is intended to permit a more meaningful interpretation of past research and foster improved experimental strategies to model homologous processes that contribute to nicotine dependence between mice and humans.

Nicotinic Receptor Functional Diversity

The family of neuronal nAChRs are excellent and obvious “candidate genes” for examining the genetics contributing to the physiological process of nicotine dependence because they are a defined target of this agent's action. However, these receptors do not act alone; their function in the broader genetic context of multiple genes and biological cascades must also be considered. This complexity is reflected in dramatic differences among mouse strains in response to acute and/or chronic administration of nicotine. In the brain, the sustained presence of nicotine alters neurotransmission at the level of the synapse because, unlike the endogenous neurotransmitter acetylcholine, it is neither rapidly degraded, nor is it actively removed from the synapse. This sustained presence can lead to both persistent activation of some nAChRs as well as induction of a desensitized or “nonactive” state that reverses slowly, or possibly in some cases, not at all.⁹⁻¹² Chronic nicotine exposure may also induce the curious phenomenon of “upregulation”; that is, the number of high-affinity nicotine-binding sites in the brain actually increases.^{13,14} However, not all nAChRs are of high affinity, nor do they all upregulate. Further, other mouse strain differences that have not traditionally been assumed to be directly influenced by nicotine, such as strain differences in pro-inflammatory status or metabolic rates, may partly account for strain differences in nicotine sensitivity and behavioral response.^{8,15,16} Therefore, the considerable genetic variability across mouse strains is likely to summate across all of these processes. It is important to consider the complex interplay of regionally specific nAChR expression, the nature of the specific behavioral tests employed, and physiological responses to identify genetic contributions to the effects of nicotine, especially those contributing to the development of dependence.

Molecular Biology of the nAChR Gene Family

Acetylcholine receptors, like other ligand-activated neurotransmitter receptors, consist of two major subtypes: the metabotropic muscarinic receptors and fast-ionotropic nicotinic receptors.^{9,12,17} Both share the property of being activated by the endogenous neurotransmitter acetylcholine, and they are both expressed in neuronal and nonneuronal cells throughout the body. The metabotropic receptors are second-messenger, G-coupled, seven-transmembrane proteins classically defined as activated by muscarine and inhibited by atropine. The other subtype of acetylcholine receptors comprises the microsecond-fast ionotropic cationic channel acetylcholine receptors that are distinguished by their sensitivity to nicotine (figures 4.1 and 4.2).

Although all receptor channels are permeable to sodium ions, which are the major agent of depolarization, there is also variable permeability to calcium. Because calcium is an important mediator of second-messenger and posttranslational processes such as gene expression and proteolysis, the regulation of local calcium concentrations imparted by various nAChRs is an important element in how these receptors contribute to establishing physiological microdomains and impact on overall metabolic tone. All subunits (figure 4.1) also share a conserved structure of a large extracellular N-terminal domain and four transmembrane domains, as well as a cytoplasmic domain of variable size and sequence that resides between the third and fourth domain (also referred to as the 3+1 configuration). Each subunit also harbors a cysteine (Cys) loop in the extracellular domain that is defined by two cysteines that, in the mammalian subunits, are separated by 13 intervening amino acids (figure 4.1). The 3+1 transmembrane domain arrangement in combination with the Cys-loop defines an extended family

of ligand-activated ion channels that, in addition to nAChRs, includes GABA_A, glycine, and 5HT3 (serotonin) receptors.

All mammals examined so far share a similar nAChR genetic composition of 17 homologous subunits.^{17,20} These are classified into alpha and nonalpha subunits on the basis of the presence of a Cys-Cys pair in the major extracellular domain near the entrance of the first transmembrane crossing (figure 4.1). A Cys-Cys pair is required (but not necessarily sufficient) for agonist binding to form the ligand-binding site for receptor activation, and it imparts the “alpha” designation. Subunits without this primary structural feature receive the nonalpha designation.²⁰ This leads to the subdivision of nAChRs into the muscle or neuronal nAChR subtypes. The muscle receptors consist of five subunits (α 1 and nonalpha subunits named β 1, delta, gamma, and epsilon). The neuronal nAChR subunits consist of the alpha-like subunits termed α 2, α 3, α 4, α 5, α 6, α 7, α 9, α 10 (α 8 is an avian-specific subunit) and three nonalpha subunits termed β 2, β 3, and β 4, respectively. The term *neuronal* was applied to these subunits on the basis of their cloning from the neuronal-like PC-12 pheochromocytoma cell line and brain-derived complementary DNA (cDNA) libraries.²¹ In general, the number assigned reflects the order of discovery. Although the present review focuses on nicotine and its effects on functional states of the central nervous system (CNS), ample evidence indicates that most “neuronal” nAChR subunits are also expressed by neuronal and nonneuronal cell types throughout the body, where they influence multiple physiological and metabolic processes.^{22–24}

Assembly and Functional Diversity of nAChRs

The mature nAChR is a pentamer assembled from varied combinations of the starting

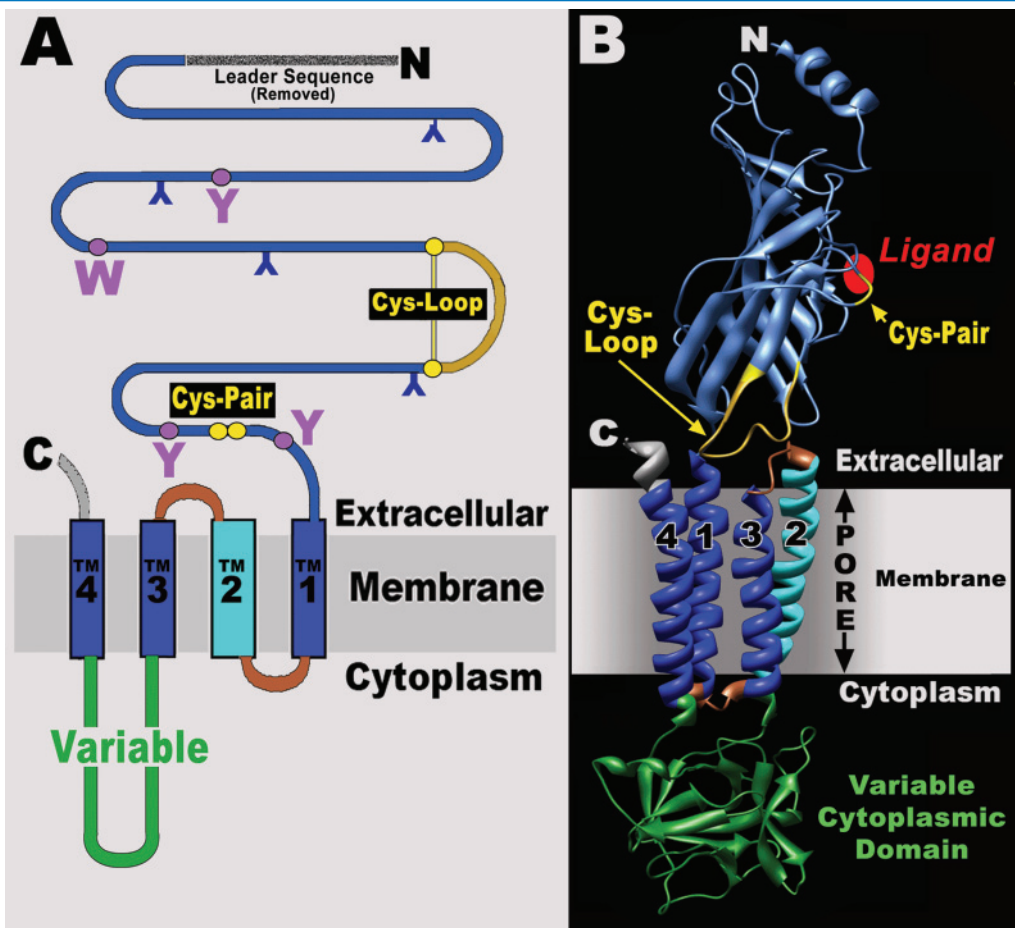
Figure 4.1 Nicotinic Receptor Subunit Structure

Note. Panel A. A linear presentation is shown of the basic structure shared by all neuronal nicotinic acetylcholine receptors (nAChRs). This includes an extracellular domain, four transmembrane domains (TMs), and a cytoplasmic domain that is located between TM3 and TM4 and varies considerably in size and amino acid sequence between subunits. TM2 lines the ion channel. Short connecting sequences between TM1 and TM2 (cytoplasmic) and TM2 and TM3 (extracellular) are shown in brown and contribute to channel gating and receptor flexibility. The highly conserved Cys-loop structural motif (extracellular domain) places nAChRs in the superfamily of ligand-gated ion channels (see text). All alpha subunits by definition contain a Cys-pair that is important for binding ligand, which is absent in nonalpha subunits. The extracellular domain is initially translated with a leader sequence that is prototypically removed. The extracellular domain also includes glycosylation sites (blue "Y"), and amino acids that in addition to the Cys-pair are important to ligand binding (in purple; tyrosines (Y) and a tryptophan (W)). Panel B. The 3-dimensional folded structure of the nAChR subunit in panel A is depicted, as reported by Unwin.¹⁸ Molecular graphics images were produced using the Chimera package from the Resource for Biocomputing, Visualization, and Informatics at the University of California, San Francisco¹⁹ (NIH P41 RR-01081). The color coding is matched between panels, although glycosylation is omitted. Also not shown in this depiction, but returned to in figure 4.2, are the tyrosine and tryptophan amino acids that, with the loop harboring the Cys-pair, form the ligand-binding site (red circle). Sequence differences among nAChR subunits in these domains contribute to the unique ligand selectivity and functional properties of the assembled receptors (see text).

subunit pool (figure 4.2). In the muscle, this is a developmentally regulated process in which receptors develop such that they comprise two $\alpha 1$ subunits separated by an

intervening subunit that is either a gamma (immature muscle), or epsilon (mature muscle) along with two additional subunits including one $\beta 1$ and delta (figure 4.2).

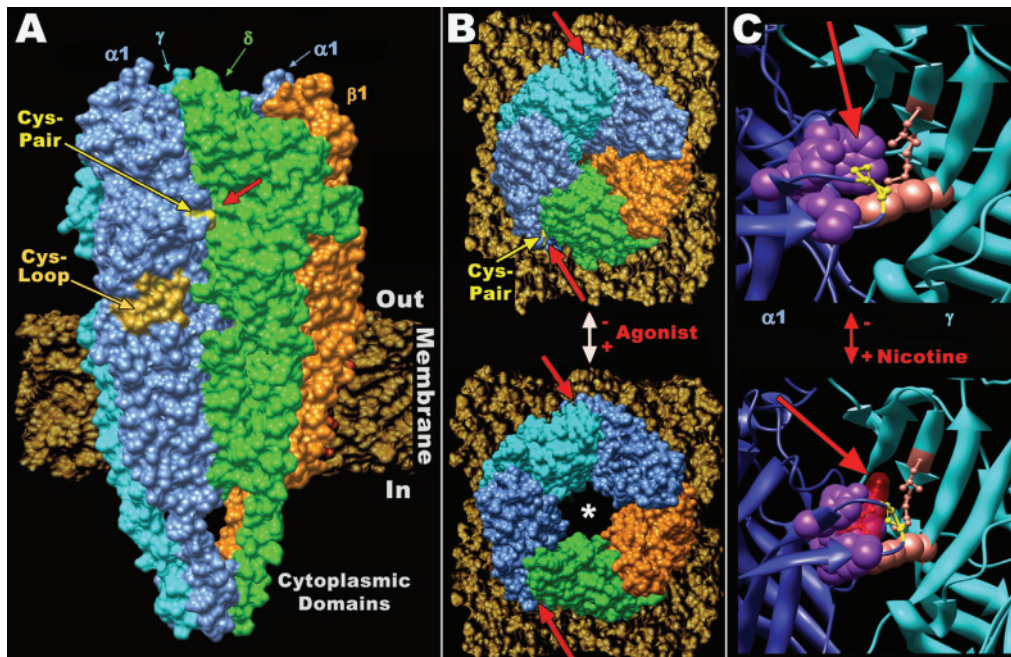
Figure 4.2 Three-Dimensional Structure of the Nicotinic Acetylcholine Receptor (nAChR)







Note. Panel A. A side view is shown of the Torpedo (muscle-like) completely assembled nicotinic receptor as resolved by Unwin.¹⁸ Five subunits coassemble to form a tubelike structure through the membrane. The alpha subunits (α 1) are paired with either a delta or gamma subunit. The beta subunit (β 1) fills the fifth position and does not directly participate in ligand binding, although it does influence receptor pharmacology and function. In this receptor, the cytoplasmic domains are depicted as single alpha helices that form a loosely associated structure within the cell. Note how the Cys-loop approaches the extracellular membrane surface. Panel B. The image in panel A is rotated 90° to look down on the receptor from the extracellular face. In this image, the organization of subunits around a central pore is apparent. When two agonist molecules (e.g., acetylcholine or nicotine) bind in the ligand-binding pocket between the α 1 subunits and their respective adjacent subunits (red arrows), there is a conformational change to increase the pore size (gate the channel) and permit ion passage, as shown by an asterisk. Upon removal of the agonist, the receptor closes, however, close if the agonist remains associated with the ligand-binding site, which is termed desensitization. Panel C. A closer view of the ligand-binding site (red arrow) between the α 1 and adjacent γ subunit shows how the Cys-pair (yellow), tyrosines, and the tryptophan (depicted by purple and shown in figure 4.1, panel A) converge in the 3-dimensional structure to form a “pocket” within the structure of the receptor. Also contributing to this pocket are amino acids from the adjacent subunit (pink). When a ligand occupies the pocket, as shown in the lower panel for nicotine (red), the receptor closes around it to induce a conformational change that gates the channel. Through varying subunit assembly, the contributions by unique amino acid sequences to this pocket and the activation mechanisms for pore opening customize the function of the various nAChRs to their physiological function.

The rules of neuronal receptor assembly are less well defined (figure 4.3). Some nAChRs are homomeric, including those assembled exclusively from α 7 subunits²⁵ or possibly α 9 subunits,²⁶ respectively. Others are heteromeric and are, in general, formed from at least two alpha subunits (including α 2, α 3, α 4, α 6, α 7, and α 9) and structural subunits including α 5, α 10, β 2, β 3, and β 4. In this case, it is notable that the alpha

designation applies to α 5 and α 10 because of the presence of the Cys-Cys pair, but neither can form a ligand-binding site or functional receptor without coassembly with other alpha subunits.

Examples of how various subunits alter receptor function and subcellular localization are abundant. Receptors constructed from various combinations

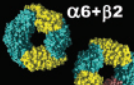
Figure 4.3 Influence of Subunit Composition on Nicotinic Receptors

PROMINENT RECEPTORS	 $\alpha 1+\beta 1+\delta$ (γ or ϵ)	 $\alpha 9$ $\alpha 9+\alpha 10$	 $\alpha 7$	 $\alpha 3+\beta 4$	 $\alpha 6+\beta 2$ $\alpha 6+\beta 2+\beta 3$	 $\alpha 4+\beta 2$
MAJOR LOCATION	Muscle	Sensory Epithelium, Peripheral Cells	Peripheral Cells, Interneurons	Autonomic Ganglia	Basal Ganglia	CNS Neurons
FUNCTION	Muscle Contraction, Development	Vesicle Release	High Calcium, Neurotransm., Intracel. Signals	Symp. & Parasymp. Control	Modulate Dopamine Release	Upregulation, Modulate GABA Release
DISEASE	Myasthenia gravis	Hearing, Autoimmune, Heart?	Schizophrenia, AD, Inflammation	Autonomic Dysfunction, Cardiovascular?	Parkinsons Disease, Addiction	AD, Epilepsy, Aging, Addiction

Note. Examples are given of the local expression of nicotinic receptors of different subunit composition where they contribute to both tissue-specific physiological and disease processes (see text). Major receptor subtypes (viewed from the top) are depicted in proposed subunit stoichiometries, which, except for the muscle receptor, are not known and may vary (see text). Also absent are receptors harboring $\alpha 2$ or other possible combinations (e.g., $\alpha 4\beta 4$) whose physiological functions are not well defined. The use of “peripheral cells” refers to both neuronal and nonneuronal cells located outside of the central nervous system. CNS = central nervous system; Symp. = sympathetic; Neurotransm. = neurotransmission; Parasymp. = parasympathetic; Intracel. = intracellular; GABA = γ -aminobutyric acid; AD = Alzheimer’s disease.

of alpha and structural subunits exhibit dramatic differences in ligand affinity, agonist and antagonist efficacy, rates of desensitization, and response to modulators (figure 4.3). Although alpha subunits control much of the determinants of selectivity for ligand binding, the nonalpha subunits have a significant impact on function. One of the earliest examples^{27,28} of this was the finding that when nAChRs composed of $\alpha 3\beta 4$ subunits were exposed to an agonist, bursts of activity followed that were often clustered and of relatively long duration. In contrast the $\alpha 3\beta 2$ receptors exhibit frequent and rapid bursting.

Customizing these properties is consistent with the need to adjust their function within the context of local physiological demands or neurotransmission specifications (figure 4.3). Hence, receptors harboring the $\beta 4$ subunit tend to be expressed during development in autonomic ganglia where they provide longer and more sustained bursts to enhance their functional impact. Receptors with the $\beta 2$ subunit are more often involved in modulating neurotransmission in which rapid and precise bursting is favored.^{12,29-31} Subsequent investigations have shown that $\beta 4$ also

imparts novel pharmacological properties involving altered agonist and antagonist efficacy³²⁻³⁴ and altered sensitivity to other compounds including sensitivity to zinc,³⁵ mercury,³⁶ and cocaine.^{37,38}

Another example of how receptor heterogeneity can be generated from a limited array of subunits is through altering either the stoichiometry of $\alpha 4\beta 2$ -containing receptors (figure 4.4), or whether a subunit such as $\alpha 5$ is included in the structural fifth position to close the receptor (figure 4.4). Of note is that receptors with considerably different pharmacological, physical, and ion permeability can be generated from these receptors of varied, but similar, subunit composition.^{39,40} In a similar context, the homomeric $\alpha 7$ nAChR provides another example of how local regulation of the expression of a relatively few subunits can dramatically influence the diversity of how the overall system response will be affected by nAChRs. This receptor desensitizes rapidly, but while the channel is open, it is highly calcium permeable.¹² This receptor also tends to localize away from the synaptic junction and has been reported to aggregate in lipid rafts,^{41,42} indicating that local increases

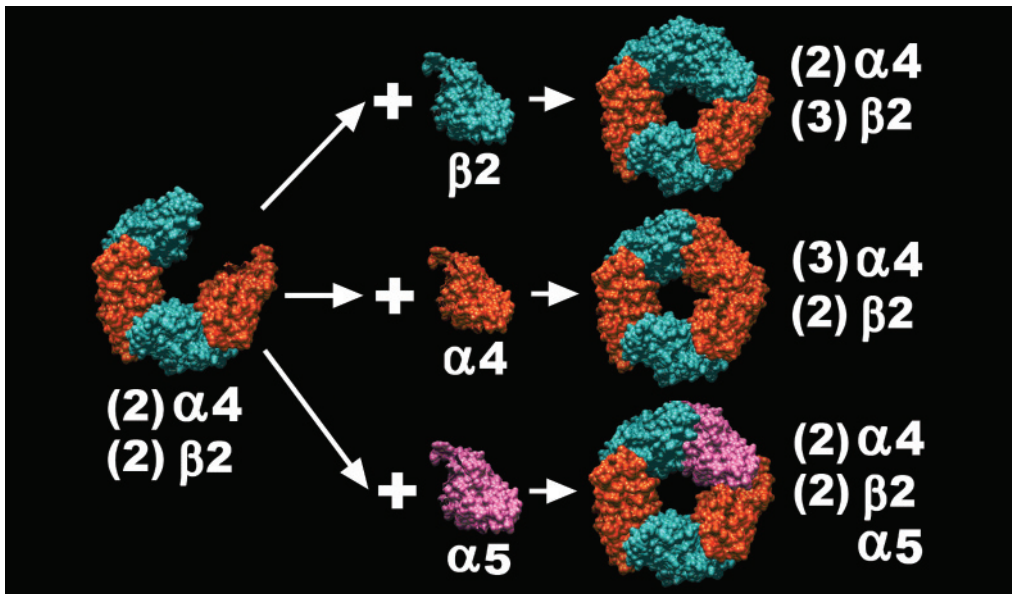
Figure 4.4 Nicotinic Receptors of Closely Related Subunit Composition Differing in Function through Variation in Subunit Stoichiometry

Note. Measuring or predicting the contribution of different subunits to neuronal nicotinic receptors is complicated by the possibility that receptors of similar (if not identical) subunit composition, but different relative stoichiometries, can be assembled in different cells or brain regions. This is depicted for $\alpha 4\beta 2$ receptors where the fifth position of the receptor can be filled by an additional $\alpha 4$, $\beta 2$, or $\alpha 5$ subunit. Depending upon which receptor is assembled, there are notable differences in their expression, affinity for ligand,⁴⁶ and function, including susceptibility to magnitude and the rate at which desensitization occurs, as well as degree of calcium permeability.^{39,40} The possibility that inflammatory cytokines can influence this process⁴⁷ further emphasizes how genetic strain background can influence nicotinic receptor expression and function and reveals that much remains to be determined about how receptor assembly influences the effects of nicotine in mouse strains and different pathologies.

in calcium can impart signaling through calcium-activated second-messenger systems. This further distinguishes the $\alpha 7$ nAChR from other nAChRs and even other ligand-activated ion channels. However, calcium permeability and sensitivity to agonists and antagonists can be altered by the coexpression of additional nAChR subunits. Finally, the structural subunits such as $\alpha 5$ nAChR also exert an effect on function and subcellular localization.⁴³ When this subunit is coassembled with $\alpha 7$ nAChR in heterologous expression systems, the receptors have similar but distinct properties, including altered rates of desensitization relative to the homomeric channel. Similarly, if $\alpha 5$ incorporates into receptors containing $\alpha 3\beta 2$ nAChR subunits,^{44,45} the resulting receptor exhibits

distinguishing functional characteristics, but the differences tend to be small. In contrast, if this subunit incorporates into receptors with $\alpha 3\beta 4$ nAChRs, as in the peripheral nervous system,⁴⁵ the burst duration of the resulting receptor channel is increased almost threefold.

Another practical concern is how subunit diversity affects interpretation of experiments that use ligand binding or limited pharmacological methods to infer identity or changes in nAChRs during a treatment regime. For example, muscarinic versus nicotinic receptor contribution may be blurred in some instances because nAChRs comprising either homomeric $\alpha 9$ or heteromeric $\alpha 9\alpha 10$ subunits are sensitive to blockade by the traditionally

muscarinic antagonist atropine.^{48,49} Similarly, the function of $\alpha 3$ -containing receptors⁵⁰ and $\alpha 4\beta 4$ nAChRs⁵¹ can be modulated in a dose-dependent manner by relatively high concentrations of this “muscarinic” receptor antagonist, although such concentrations are commonly used in buffers by electrophysiologists to ensure that only nAChRs are recorded in response to acetylcholine administration. Consequently, investigations may yield confusing or possibly misleading results when only a single assay of nAChR function is used. Certain other nAChRs of diverse subunit composition may also have overlapping pharmacology, or they are simply not detected by available methods. This could be true of $\alpha 9$ and $\alpha 9\alpha 10$ nAChRs, which might be mistaken for $\alpha 7$ subtype receptors because they also exhibit exquisite sensitivity to α -bungarotoxin.²⁶ Although overlap of these respective receptor subtypes appears to be very small in central systems, there is substantial $\alpha 9$ -subtype expression in peripheral systems,^{52–55} and consequently, the identity of the nAChR subtype being measured must be carefully assigned.

Finally, traditional ligand-binding determination methods (e.g., high-affinity nicotine or α -bungarotoxin binding) may be inadequate to infer the finer aspects of nAChR involvement in local circuitry, especially in regions such as the hippocampus. It is now well established that the nAChR systems in this limbic region affect both inhibitory and excitatory tone through modulating inhibitory interneuron activity.^{56–58} In particular, differing combinations of $\alpha 7$, $\alpha 4\beta 2$, and $\alpha 3\beta 4$ nAChRs, respectively, have been implicated in collectively establishing theta-wave synchronization^{59–61} and mechanisms of long-term potentiation.^{11,58,59,62–64} Therefore, mixed combinations of receptors on restricted numbers of inhibitory interneurons whose location is strategically placed within the circuit will

contribute significantly to establishing the hippocampal activity imparting a behavior. However, methods to distinguish among the expression of these various receptors can be very challenging technically. In some cases, they are missed entirely when high-affinity nicotine or α -bungarotoxin binding methods are used, or if their overall abundance is too low to be detectable over the background from the entire cellular milieu. However, the addition of new high-affinity ligands (e.g., the frog toxin epibatidine) or some with varied, but defined, nAChR subtype selectivity (e.g., the α -conotoxin MII) are proving to be of exceptional value for identifying the coexpression of these receptors.⁶⁵ Nevertheless, the limitations of such assays should be borne in mind when designing new studies or when evaluating extant data. The lack of sensitivity and specificity of such assays may be responsible for some of the inconsistent results yielded by early studies in this area.

Customizing Local nAChR Function through Limiting Subunit Expression

Among the first discoveries following the discovery of the cDNA family of nAChR subunits was that their expression in the brain was restricted to subunit-specific patterns that overlapped in various brain regions.^{12,66–68} This manifests in considerable overlap: $\alpha 4$ and $\beta 2$ are widely and coincidentally expressed.^{65,69} Together, they form the majority of high-affinity nicotine-binding sites in the CNS and are the primary receptor to undergo upregulation in response to nicotine.⁷⁰ Another receptor, $\alpha 7$, is also expressed throughout the CNS, but not in all regions. Its relatively high permeability to calcium and rapid desensitization to nicotine make it a particularly important subunit for regulating second-messenger and transcriptional mechanisms (see below

and figure 4.3). However, there is incomplete understanding of the contribution of each subunit to proposed regional specialization of nAChR structure and function (figures 4.3 and 4.4). This is due, in part, to measurements that rely solely upon RNA analysis. Such analyses can vary in sensitivity, and do not provide spatial resolution of the final receptor product, which can be located very distantly from the site of synthesis because of processes such as axonal transport. One example of this is the expression of the $\beta 4$ subunit in the adult CNS. The expression of this subunit was originally reported to be highly restricted to only a very few brain regions, most notably the medial habenula,^{71,72} or in the peripheral nervous system with $\alpha 3$.⁷³ When other studies were conducted that used assays of increased sensitivity and resolution,⁷⁴ including single-cell polymerase chain reaction (PCR),⁷⁵ $\beta 4$ was found to be more widely expressed in the CNS.^{76,77} Similarly, immunohistochemical measurement of $\beta 4$ reveals that this subunit may be expressed at sites very distal to the cell body, as in axon terminal fields of the barrel cortex whose cell bodies originate in the ventral thalamus, or in terminal fields of the lateral lemniscus within the inferior colliculus.⁷⁸ Therefore, the site of the nAChR contribution to regulating local circuitry may be distal from its site of synthesis.

In the many brain regions, electrophysiological recordings and immunolocalization reveal a more complicated story.^{11,64,79–81} Nicotinic receptors can be located presynaptically, postsynaptically, and nonsynaptically (e.g., aggregates of $\alpha 7$ nAChR) on both pyramidal and nonpyramidal interneurons. Differential subcellular localization can, in turn, lead to at least three different, and often complementary, outcomes on cell response.^{9,12,64} First, when located presynaptically, depolarization through these nAChRs can add to or sustain

the activation of voltage-gated calcium channels to enhance neurotransmitter (either excitatory or inhibitory) release. Second, when nAChRs are localized to the postsynaptic face of the synapse, they can participate directly in promoting fast-excitatory neurotransmission. Finally, as when located in lipid rafts, the collective activation of these receptors can directly affect the intensity of local intracellular ion concentrations to influence downstream pathways, leading to changes in gene expression, metabolic and physiological stasis, and even proteolytic mechanisms.

One example of when different nAChRs are coexpressed to combine to modulate the overall tone in a local circuit involves the GABAergic interneurons of the hippocampus. In fact, no fewer than three subclasses of these inhibitory interneurons can be distinguished on the basis of the unique expression of different nAChR subtypes^{64,79} such as $\alpha 7$, $\alpha 4\beta 2$, and $\alpha 3\beta 4$, respectively, although some interneuron subtypes also express combinations of these receptor types and possibly others.⁷⁵ These interneurons collectively play an important role in the magnitude of GABAergic inhibition exerted by nAChR activation in the CA1 region. For example, activation of interneurons harboring the $\alpha 7$ nAChR in the stratum lacunosum moleculare is strongly inhibited to produce a selective disinhibition of the dendritic segments of pyramidal neurons innervated by axon terminals of the perforant path. In contrast, activation of $\alpha 4\beta 2$ nAChRs inhibit interneurons in the stratum radiatum and stratum lacunosum moleculare to produce disinhibition of dendritic areas innervated by both neuron types. Moreover, nAChR immunoreactivity has been localized to astrocytes in this brain region.^{69,81} Given that these astrocytes release agents that interact with glutamate receptors to maintain excitatory “tone,”⁸² it is not surprising that the nAChRs have been implicated in neurological diseases ranging from schizophrenia to Tourette

syndrome to neurodegeneration, as seen in Alzheimer's disease (figure 4.3). Therefore, when assessing the impact of nAChRs with respect to nAChR subunit composition, the magnitude of expression, the site of final receptor localization, and the anatomical context in which nAChRs are expressed are important considerations in unraveling the strain-specific effects of nicotine responses.

Nicotine's Function as Agonist and Antagonist

Ligand-activated ion channels, by necessity, are transmembrane proteins that when fully assembled create a hydrated receptor channel permeable to selected ions that are regulated by conditions of the extracellular, intracellular, and transmembrane environment (figure 4.2). Notably, ion-channel receptors reside in a constant equilibrium between open and closed states, and their tendency to open is carefully regulated through the presence of neurotransmitters or other agents that broadly fall under the functionally defined categories of agonist (activator) or antagonist (inhibitor). Nicotine is most often viewed as an agonist of nAChRs. However, this compound is not rapidly degraded or transported away from the receptor (as are normal endogenous transmitters), and in the absence of compensating mechanisms, the sustained presence of an agonist would lead to increased receptor opening and, in turn, cell death (figure 4.2). The compensatory mechanism in this case is the process of receptor desensitization, which permits the receptor to close in the presence of sustained agonist exposure. When acetylcholine is the neurotransmitter, desensitization is brief, because this endogenous transmitter is rapidly degraded by acetylcholine esterases. In contrast, nicotine may accumulate in the receptor vicinity; this has the effect of actually favoring the desensitized or the nonfunctional state. Notably,

persistent, elevated concentrations of an agonist can even result in a state of deep desensitization that can lead to complete receptor inactivation or degradation.¹² In practical terms, this produces cases in which nicotine becomes a potent inhibitor of receptor function that can actually exceed the antagonism accomplished by many pharmacological agents designed for this purpose. Consequently, the effect of nicotine on a system may, in some cases, be more accurately ascribed to sustained receptor inactivation rather than to activation.

Whether activation or desensitization dominates the effect of nicotine is, in part, determined by the receptor subtype(s) expressed. For example, some receptors are activated by very low concentrations of nicotine but become desensitized as the concentration increases (e.g., $\alpha 7$ subtypes), while others ($\alpha 3\beta 4$ subtypes) may be fully activated only at concentrations at the high end of physiological relevancy.^{12,64} In some cases, both conditions may occur, as in the nucleus accumbens, where most nAChRs desensitize (or even inactivate) rapidly to nicotine,⁸³ yet dopamine overflow related to nAChR activation persists well after exposure.^{84–86} Other mechanisms associated with nicotine's actions may actually be imparted through indirect or conditional mechanisms. These include the production of nicotine metabolites or mediators of stress responses such as salt imbalance (especially if nicotine tartrate is used) or local pH (also note that nicotine is most stable when acidic).⁸⁷ Further, the differential expression of nAChRs by multiple cell types can collectively influence the activation of additional signaling pathways such as those that are downstream of cyclic adenosine monophosphate–response element binding (CREB) activation (see below and Brunzell and colleagues⁸⁸) or the enhancement of nitric oxide release.^{89,90} So, while the focus of this review is on the impact of this drug on immediate nicotinic cholinergic mechanisms and

responses, a full causal account could be highly complex because other signaling and neurotransmission systems are, no doubt, also involved. While this has produced some confusion, it emphasizes the need to view the nAChR system as a modulator of physiological “tone.” This also includes the influence of the rate of nicotine administration, its absolute dose, and its local persistence. This suggests that the route of administration is a vital element of experimental design and is discussed later in this chapter.

Nicotinic Receptor Upregulation

When a tissue receives sustained exposure to nAChR ligands such as nicotine, the curious phenomenon of upregulation occurs. This was first recognized when quantitation of high-affinity nicotine-binding sites from brain tissue taken from rats¹³ or DBA/2 mice exposed to chronic nicotine,¹⁴ revealed that such sites were increased by as much as fourfold over nonnicotine-treated controls. Further, this was similar to the increased number of high-affinity nicotine-binding sites measured in brain tissues from smokers.^{91,92} Subsequently, upregulation has been measured directly using brain imaging methods such as quantitative dynamic single-photon-emission computed tomography of the living baboon brain⁹³ and in human smokers.⁹⁴ Immunoprecipitation studies of the high-affinity nicotine-binding sites in rats first demonstrated that the $\alpha 4\beta 2$ subtype of nAChR was essential to both high-affinity binding and coincident upregulation in response to nicotine.⁷⁰ This property is intrinsic to this receptor-subunit composition because upregulation of this receptor occurs in all animals so far examined and in receptors expressed in heterologous expression systems including transfected human embryonic kidney cells.⁹⁵ The importance of subunit composition is critical to the relative degree of upregulation, and in

fact, not all nAChRs exhibit this property (e.g., all receptors harboring $\alpha 4\beta 2$ appear to upregulate, while receptors composed of $\alpha 4\beta 4$ show reduced upregulation, and those harboring $\alpha 3$ do not upregulate⁹⁵). Mice deficient for $\beta 2$ through subunit knockout exhibit essentially no high-affinity binding sites and do not upregulate receptors.^{96,97} Therefore, the identity of the alpha and beta subunits contributes qualitatively and quantitatively to upregulation. This phenomenon, which has been related to the development of reinforcement (see Picciotto and colleagues⁹⁸ and below), produces a situation in which there are more receptors but the overall function is reduced.^{12,64} Also, because upregulation influences receptor subtypes preferentially, the importance of this process to optimizing the performance of local circuitry is likely to be equally specialized (figure 4.3), as indicated by the dominance of $\alpha 4\beta 2$ in central systems such as the basal ganglia and hippocampus versus the autonomic nervous system, where the majority of receptors are composed of $\alpha 3\beta 4$ subunits.^{17,73,99}

The cellular mechanisms underlying this important cellular phenomenon are not yet resolved, and the published explanations can differ, often from the same laboratory.^{100–102} What these studies and others seem to suggest is that multiple mechanisms underlie this effect, including increased assembly efficiency,¹⁰³ altered receptor stoichiometry,^{46,102} increased export from the endoplasmic reticulum and increased surface trafficking,^{101,104} altered affinity for ligand,¹⁰⁵ and decreased degradation.^{100,106} It is likely that upregulation reflects the summation of several processes whose regulation and relative contribution depend upon the cell type, the subunits expressed by a cell, and conditions in the surrounding environment (figure 4.4).

Finally, some reports suggest that some receptors may downregulate in response

to nicotine. For example, chronic exposure to nicotine downregulates the expression of $\alpha 6$ -containing receptors in mice and rats,^{107,108} however, those composed of $\alpha 6\beta 3$ are unregulated by chronic nicotine in transfected cells.¹⁰⁶ Therefore, while the understanding of upregulation, and possibly downregulation, remains cloudy, the importance of this process to the outcome of nicotine's effects on behavior are certain and are revisited below. Thus, the issue of receptor down- or upregulation is just one more consideration that investigators must ponder when attempting to link genetic variants and physiological substrata with dependence-related phenotypes.

Routes of Nicotine Administration: Interaction of the Drug with Physiological Systems

Just as age, gender, and general health affect nicotine metabolism in people,^{15,16,109} the same is true of mice (figure 4.5). Also, how nicotine enters the body can affect nicotine effects in ways that must be carefully considered when attempting to draw inferences about nicotine actions and their genetic bases. Although plasma levels of nicotine are easily determined, such levels may not accurately reflect functional exposure of critical, or targeted, tissue. In fact, tissue levels of nicotine can vary dramatically from plasma levels. Researchers have characterized the effects of 24 hours of constant intravenous (IV) infusion of nicotine on tissue distribution and concentration of nicotine in rabbits.^{8,15,16,109} In such studies, the brain, heart, liver, and gastrointestinal tract contained three- to fourfold more nicotine than did the plasma, whereas the increment in muscle and lung was

approximately twofold. The major site of excretion, the kidneys, can exceed a 21-fold increment. One curiosity is that adipose tissue exhibits relatively poor nicotine retention (approximately one-half the concentration of plasma). Nicotine also crosses the placenta¹⁶ and is concentrated in breast milk in which concentrations can reach threefold that of plasma.⁸ Nicotine also concentrates in the brain or lungs following direct infusion and may achieve concentrations tenfold greater than those of the plasma. Finally, nicotine delivered directly to the rat lung becomes concentrated in that tissue and is slow to enter into circulation.¹¹⁰ These data show highly variable concentrations of nicotine in different tissues or body compartments and that specific concentrations reflect route of administration.

An often overlooked concern is that some methods of administration may introduce undesirable contaminants, such as lipopolysaccharides (LPSs), or induce local inflammatory events. Using saline as the control in these experiments is inadequate in that the contaminants in the saline are generally nonpyrogenic (LPS-free), whereas nicotine from the shelf or other commercial sources is likely to have been contaminated at some time with small amounts of bacteria. Several researchers have discussed this issue.¹¹¹⁻¹¹³ It is possible that conditions related to chronic inflammation such as fatigue and cachexia could complicate, and even be confused with, the drug effect. Consequently, the duration of exposure, route of administration, and the tissue being examined are important variables when assessing the effects of nicotine. Therefore, since no single route of administration models all aspects of the behavioral components of nicotine dependence, it is important to carefully define the behavior or motivational phenomenon of interest and to employ a route of administration that is both

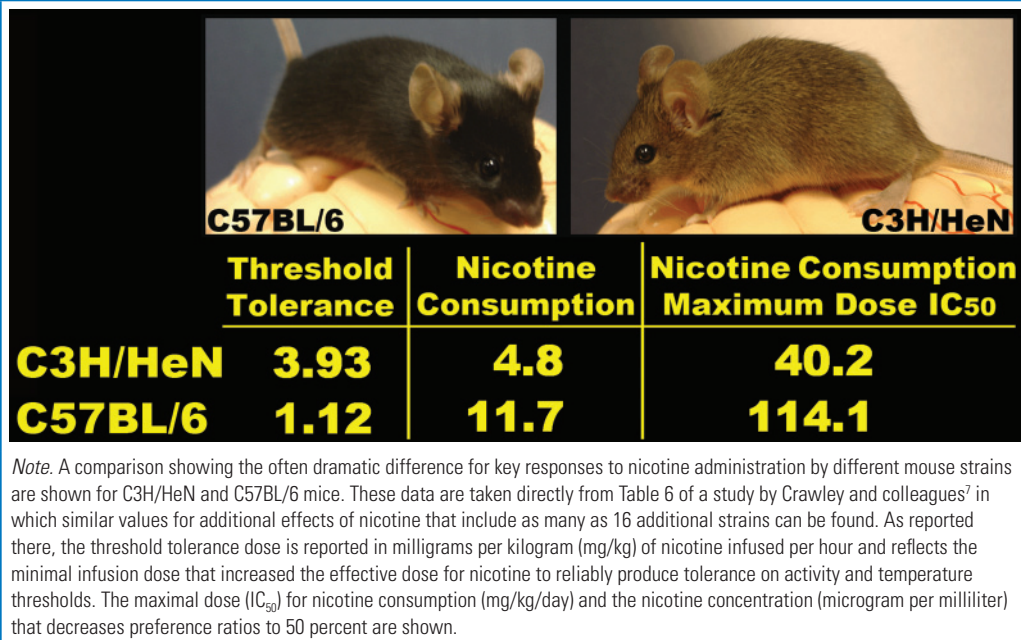
Figure 4.5 Genetic Influences on Nicotine Tolerance and Self-Administration

theoretically relevant and does not create artifacts that mask or distort target effects. A review by Matta and colleagues⁸ provides an outstanding and comprehensive resource for questions concerning routes of nicotine administration for the mouse.

Intravenous Nicotine Administration

IV administration is a commonly used delivery system to study the effects of nicotine. The tendency for a behavior to become routine or automatic may contribute to high levels of drug use.^{114,115} Similarly, cues associated with nicotine self-administration may also elicit strong dopaminergic neurotransmission and instigate increased self-dosing.⁸³ If these elements are not represented in the phenotype, important genetic bases of nicotine dependence and vulnerability may go undetected. One way this has been dealt with, especially in rats, is through establishing regimes that allow for nicotine self-administration through

control of IV injection of nicotine.^{116–120} This introduces a rapid rise in plasma nicotine during active cycles that resembles the pulsatile use of nicotine seen in humans. One disadvantage is that active cycles of infusion may produce nicotine concentrations that exceed plasma concentrations achieved by normal physiological routes by possibly as much as 10-fold.¹²¹ This exceedingly high concentration of nicotine can produce unanticipated and possibly nonphysiological effects, including rapid and generalized receptor desensitization (or even receptor inactivation). Also, the drug can readily exceed 100 microns in the vicinity of the injection to produce undesirable side effects, such as neuronal death by excitotoxicity.^{122–124} Therefore, the control of nonspecific effects (possibly via a receptor knockout mouse as described below) is important if an experimental goal is to distinguish the behavioral outcome as being related to a rapid increase in receptor activation or possibly reduced receptor function.

Subcutaneous Nicotine Administration

The osmotic minipump,^{125–127} an efficient subcutaneous method for administration of nicotine into the periphery or brain, has been used with success for many years (for a review, see Marks and colleagues¹⁴). It permits relatively prolonged periods of exposure (perhaps as long as six weeks) and affords control over the rate and timing of infusion. In addition, removal of the minipumps allows investigators to match the specific duration of withdrawal with changes in cellular events. Thus, for experiments in which withdrawal-induced changes in cell signaling are assessed, use of the minipump may be more advantageous than methods that do not allow for precise timing of cessation of nicotine administration, such as oral self-administration.

As with every method of chronic nicotine administration, some disadvantages exist, but they are often specific to experimental design and focus. For instance, implantation and removal of the pump requires minor surgery; although the surgery lasts fewer than five minutes, the use of anesthesia or introduction of other confounding effects such as animal handling may be problematic for some studies. Also, a potential problem is that weight gain could affect dosage;⁸ however, this depends on the length of the study and may be a greater concern for studies in rats, which may show greater weight gain than do mice. Finally, any discussion of methods of chronic nicotine administration must consider how the model relates to features of human nicotine dependence that may be important to elucidating its genetic substrata. For instance, the minipump system does not involve a self-administration ritual. Studies have shown that self-administration ritual and response to environmental cues may influence behaviors related to nicotine dependence.^{128–130} In addition, the minipump

continuously administers nicotine in comparison to episodic administration. There is evidence that rate of rise time of nicotine receipt in critical brain regions determines certain hedonic reactions to the drug such as elation and euphoria, “buzz,” “rush,” and “high.”^{131–133} However, smokers may exhibit different patterns of smoking, with some smokers seeking boosts in plasma nicotine levels and other smokers attempting to maintain steady-state plasma nicotine levels.^{50,134}

As a result, it is not clear how best to model human nicotine consumption, and it is not clear if different genetics are involved in the different consumption patterns. The use of different methods of chronic nicotine administration in mice would allow for this genetic question to be investigated. Finally, no matter what method of delivery is chosen, it must be remembered that the half-life of nicotine in the mouse is approximately 7–10 minutes,¹³⁵ compared to approximately 60 minutes in rats¹³⁶ and approximately 120 minutes in humans.¹³⁷ Thus, intermittent administration of nicotine that will produce similar plasma steady-state levels of nicotine as seen in smokers may be difficult to achieve because of the short half-life in mice.

Oral Administration

Oral administration of nicotine (e.g., via drinking water) has become increasingly popular as a method to achieve chronic or long-term nicotine exposure in primates and rodents.⁸ This route of administration also has some physiological and sensory relevance to humans who self-administer tobacco or nicotine orally. For instance, smokeless tobacco and nicotine aerosols involve oral use, and much of the available nicotine ultimately is swallowed.¹³⁸ The main advantage of using drinking water as a vehicle is that it is relatively easy, inexpensive, and reduces considerably the handling and manipulation of the

animal. In addition, it yields plasma nicotine concentrations that are similar to those observed in smokers, and because most drinking occurs in the evening hours, this method reproduces the cyclic (episodic) increase and decrease of nicotine administration that occurs in smokers.⁸ For example, drinking-water administration yields plasma nicotine levels that range from 10–20 nanograms per milliliter (ng/mL);^{8,88,139,140} these levels are similar to the lower ranges observed in smokers.

Further, oral nicotine produces a broad range of effects associated with chronic nicotine exposure and dependence, effects that were originally obtained in animals with IV-injection methods—for example, receptor upregulation, tolerance, neuroprotection,^{77,141–145} and mouse-strain-specific responses reflective of physical dependence.¹⁴⁶ However, nicotine in drinking water, like injection, does not replicate the prolonged exposure of the oral mucosa to nicotine, which is an important determinant of nicotine absorption with some methods of human self-administration.⁸

Other problems encountered with this method of administration include the bitter taste of nicotine (which can limit consumption in a strain-specific manner⁸) and the failure of some mice to tolerate the amount of nicotine consumed, possibly because of toxicity and occasionally irritation of the gastrointestinal tract. The bitter taste is usually overcome by supplementing the drinking water with 1%–2% saccharin. Animals receiving only saccharin water are routinely used in studies to ensure control for nonspecific effects.^{8,88,139,140}

For oral administration, it is important to use nicotine in the free-base form to avoid the complications related to tartrate salt. The authors of this chapter found that C57BL/6, CBA/HeN, and C3H strains

can all be administered oral nicotine for time periods ranging from several weeks to years.^{81,139,147} Finally, while taste may constrain dependence development in some mouse strains, this may not be a problem to the extent that taste sensitivity plays a significant role in affecting dependence vulnerability in humans.¹⁴⁸

In terms of how route of administration affects intake and dose, reports examining the biological activity of cotinine—the major metabolite of nicotine—raise interesting questions about the impact of nicotine and the suitability of different dosing paradigms. Administration of cotinine to rhesus monkeys and rats can recapitulate many of nicotine's effects, including protective effects to differentiated PC-12 cell survival, but it fails to induce receptor upregulation.¹⁴⁹ However, cotinine is generally much less efficacious than is nicotine,¹⁴³ although it occurs at greater concentrations in the plasma. This must be kept in mind when evaluating nicotine effects yielded by systems such as direct nicotine infusion into the brain. This strategy provides little opportunity for nicotine metabolism and might obviate the effects of cotinine in a manner inconsistent with human nicotine use and dependence. At the very least, such pathways must also be considered when assessing the genetic contribution to the addictive process, especially when extrapolating to humans.

Finally, the route of administration may have additional unintended consequences on the outcome of experiments and possibly mask important aspects of nicotine biology. For example, different routes of nicotine administration (e.g., injection versus oral) may enhance or abrogate nicotine's anti-inflammatory effects in ways not yet entirely defined.^{24,150} Curiously, to the extent that nicotine administration is anti-inflammatory, it would allow some mouse strains to tolerate experimental

The Metabolic Fate of Nicotine

The extent to which the features of nicotine use and dependence are related to metabolite levels and actions requires further investigation. What is clear is that catabolism of nicotine promotes differential responses to nicotine and that both route of administration and strain-specific genetics contribute to this effect. There is evidence that metabolism is an important influence on nicotine self-administration and magnitude of drug effect. For example, studies of rats, mice, and humans^a show significant intraspecific variability in nicotine metabolism, including differences in plasma levels of several major catabolites such as cotinine.^{b,c,d} Among humans, disparities in nicotine intake have been directly related to differences among individuals in their respective rates of nicotine catabolism.^e Further, altered oxidation of nicotine,^{c,f} and conversion to cotinine in some individuals, corresponds with an allelic form of the principal enzyme of nicotine metabolism, CYP2A6.^{a,c} In mice, the CYP2A6 homologue is Cyp2a5; this, too, appears to contribute to differential nicotine consumption behaviors between strains, as witnessed in male F2 mice that exhibit increased Cyp2a5 expression^g and corresponding changes in metabolic rates and increased nicotine self-administration. Basically, slow metabolism may produce an accumulation of nicotine and toxicity (e.g., activation of muscle receptors or autonomic neurons), and thereby contribute to limited intake. Rapid clearance, however, decreases the effective pharmacological dose.

^aSwan, G. E., N. L. Benowitz, C. N. Lessov, P. Jacob 3rd, R. F. Tyndale, and K. Wilhelmsen. 2005. Nicotine metabolism: The impact of CYP2A6 on estimates of additive genetic influence. *Pharmacogenetics and Genomics* 15 (2): 115–25.

^bSvensson, C. K. 1987. Clinical pharmacokinetics of nicotine. *Clinical Pharmacokinetics* 12 (1): 30–40.

^cMessina, E. S., R. F. Tyndale, and E. M. Sellers. 1997. A major role for CYP2A6 in nicotine C-oxidation by human liver microsomes. *Journal of Pharmacology and Experimental Therapeutics* 282 (3): 1609–14.

^dTerry Jr., A. V., C. M. Hernandez, E. J. Hohnadel, K. P. Bouchard, and J. J. Buccafusco. 2005. Cotinine, a neuroactive metabolite of nicotine: Potential for treating disorders of impaired cognition. *CNS Drug Reviews* 11 (3): 229–52.

^ePerez-Stable, E. J., B. Herrera, P. Jacob 3rd, and N. L. Benowitz. 1998. Nicotine metabolism and intake in black and white smokers. *JAMA: The Journal of the American Medical Association* 280 (2): 152–56.

^fSiu, E. C., and R. F. Tyndale. 2007. Non-nicotine therapies for smoking cessation. *Annual Review of Pharmacology and Toxicology* 47:541–64.

^gNakajima, Y., A. M. DelliPizzi, C. Mallouh, and N. R. Ferreri. 1996. TNF-mediated cytotoxicity and resistance in human prostate cancer cell lines. *Prostate* 29 (5): 296–302.

conditions that would otherwise be intolerable because of inflammatory complications. In effect, alternative routes of nicotine administration can affect pro-inflammatory systems differently; this may compromise both reproducibility and possibly the translatability of results to other systems. Of course, this remains to be clearly demonstrated experimentally, but the possibility that the route and rate of administration can influence experiments and even modulate strain-specific responses to this drug remains an important open question.

The Mouse Model of Nicotine Dependence

Basics of Experimental Design

Researchers using animal models have often observed that “mice are not little rats.” Similarly, a mouse is not just a mouse; different strains can vary dramatically in characteristics^{2–4,7} that may directly or indirectly affect phenotypic measures

(figure 4.5). Although the laboratory rat has been used extensively for examining the behavioral effects of nicotine, the mouse as a model system is relatively new. The basic premise that the mouse model can be successfully exploited to reveal human-related traits is supported by more than three decades of successful translational research conducted by immunologists and cancer biologists. Although the application of the mouse to complex behavioral traits is relatively new, the popularity of books such as *What's Wrong with My Mouse?*¹⁵¹ and similarly oriented introductory “how-to” Web sites is indicative of the growing interest in this model system.

Numerous mouse-rat differences make it hazardous to extrapolate across these species. For instance, the mouse is, in general, much less sensitive to nicotine than is the rat.⁸ Nevertheless, the mouse has several advantages. First, the mouse model has a long and detailed record for being used successfully to measure the effects of nicotine on behavior, physiology, biochemistry, and a variety of diseases. Second, the mouse is particularly amenable to well-defined genetic and pharmacological experimental manipulation, and this model has been used successfully to reveal key nAChRs important in mediating the effects of nicotine. Third, heterogeneity in the response of different mouse strains to nicotine provides a valuable opportunity to identify strain-linked genetic differences that affect the magnitude and persistence of nicotine's effects. Fourth, genes can be readily manipulated through methods of homologous recombination. Finally, mice are much cheaper to acquire and maintain in large numbers. Although the many mouse varieties provide a remarkable array of experimental opportunities, the selection of the strain appropriate to the experimental paradigm is crucial, and this topic is discussed below.

Selecting a Mouse Strain

Ultimately, the goal for using mice in the study of nAChR biology is to understand

how nicotine use leads to dependence. Chronic nicotine use and the phenotypes of dependence are closely associated, in both humans and other animals, with concurrent physiological changes in nAChR function and expression. The measurement of acute and chronic effects of nicotine administration in at least 19 mouse strains has yielded a remarkable database. This database quantitatively describes multiple genetically influenced physiological and behavioral differences in the effects of nicotine exposure.⁷

Studies using genetic manipulation of mouse nAChR subunits in combination with pharmacological and functional measures are beginning to add experimental details that contribute to the understanding of strain-related results and to the design of future genetic analyses of nicotine dependence. Excellent resource information is available regarding these selections in an extensive and growing database including hundreds of strain- and gender-specific behavioral and physiological traits of mice that can be accessed on the Web from the Mouse Genome Informatics database.^{152,153}

Upon selecting the best strain, it is important to ensure it has the desired phenotype and genotype. For example, certain inbred colonies can undergo subtle genetic drift relative to a colony at another institution, making it important that the strain of mouse selected actually exhibits the reported traits. One example of the influence of strain-related genetic drift is that very young DBA/2 mice exhibit sensitivity to auditory seizure if purchased from Jackson Laboratory but not if obtained from Charles River Laboratories.¹⁵⁴ The problem of unknown genotype can be particularly serious in studies that routinely mix multiple strain backgrounds during the production of knockout or knockin mice. This can lead to unexpected phenotypes. Problems caused by strain mixture may arise when a newly

made transgenic mouse is crossed with a parent from a different strain. For instance, transgenic mice may be crossed to CBA mice to increase hybrid vigor and enhance the possibility of obtaining offspring. However, CBA mice experience hereditary retinal degeneration that, despite their dark black eyes, renders them severely visually impaired, if not blind. When these animals are used in experiments that require the use of visual cues for the behavioral endpoint, they can produce spurious results of limited value (e.g., see discussion by Crawley and colleagues⁷).

Similar problems of unexpected phenotypes can occur in homologous recombination experiments that are most easily accomplished in stem cells from two mouse strain backgrounds (129 and FVB/N) and then commonly backcrossed into the C57BL/6 mouse. Notable, and often substantial, differences in the basic neuroanatomy between the 129 and B6 strains are of sufficient relevance to warrant one mouse brain atlas to show these differences side by side (e.g., corpus callosum agenesis in strain 129¹⁵⁵). As a consequence, it is not surprising that 129/Sv mice are impaired on many learning tasks.⁷ Crossing them with other mouse strains produces a complex background in which the respective parental gene interactions and related but ill-defined environmental interactions¹⁵⁶ can impart a significant range of interactive effects not necessarily controlled for by litter mates.

When using backcrossed mice, an important issue is how many backcrosses ensure genetic background homogeneity. One common approach is to use mice following 6 to 10 backcrosses into the desired parental strain. However, this method is highly subjective. Detailed analyses suggest that even after 10 backcrosses, which can take three years to complete, there is little guarantee that strain purity will exceed the optimal target of approximately 99%. The purity of the parental background can

vary considerably among offspring; by some estimates, as much as ~5% of the genetic variation may remain even after as many as 50 random backcrosses.¹⁵⁶ Ideally, marker-assisted, accelerated, backcrossing strategies, also referred to as speed congenics, should be used to optimize backcrossing efficiency, minimize the time required to accomplish the optimal genetic background, and ensure optimal genetic uniformity among the animals being compared. In this method, strain-specific PCR-based procedures that are commercially available (e.g., Charles River Laboratories, Harlan Sprague, Dawley, Inc., or Jackson Laboratory) permit assessment of strain-specific DNA marker density of at least 15 centimeters on all chromosomes for no fewer than 15 commonly used strains. This quantifies background contamination and permits selection of strains with more than 95% of the desired parental strain background, often with fewer than five backcrosses.

Nicotine and Behavioral Changes

Addictive substances share common features, including an ability to produce behavioral reinforcement, promote self-administration, and alter reward-related behavior. The mouse model recapitulates each of these basic features of dependence and has facilitated the identification of genetic, neural, and behavioral substrata promoting these changes. This section will review mouse models of reinforcement, self-administration, reward, and tolerance, with emphasis on the genetic and neural systems that are implicated by these models.

Reinforcement

The reinforcing properties of nicotine are often assessed by studies that measure the ability of nicotine to maintain

self-administration. In mice, both IV and oral nicotine self-administration models have demonstrated nicotine reinforcement. Both will be discussed below. As a note, the reporting of nicotine doses varies across studies. Some studies report nicotine doses as base weight, and some studies using nicotine tartrate salt report nicotine doses as salt weight. To facilitate comparisons across studies, doses are standardized to reflect base weight. In addition, one of the difficulties in comparing genetic influences across studies is that methodologies often vary. Factors that can vary across studies include strains used, doses used and effective doses, routes of administration, and treatment of the mice. This chapter attempts to provide information on doses tested, strains used, and methodological variables for the self-administration studies and the studies examining reward and tolerance. Factors that influence reinforcement include nAChR properties, genetics, developmental changes, and nonnicotinic neural mechanisms. The following sections provide an overview of these factors.

Intravenous Nicotine Self-Administration

Inferences Regarding Critical nAChRs

Self-administration has helped both to reveal the behavioral properties of nicotine reinforcement and to elucidate the neural substrates of reinforcement from the level of neural area, to receptor subtypes, to underlying cell-signaling cascades. Multiple early studies suggest that high-affinity nAChRs are involved in the reinforcing effects of nicotine. First, IV self-administration of nicotine and other high-affinity nAChR agonists was examined in NMRI mice.¹⁵⁷ Each self-administration session began with administration of a priming infusion of the test compound for that session. A range of nicotine doses was tested (0.01, 0.03, 0.04, and 0.06 milligrams per kilogram [mg/kg]/

infusion); the 0.01 and 0.03 mg/kg/infusion doses of nicotine were both associated with increased nose pokes (the drug-contingent response), but the rate of nose pokes for higher doses (0.04 and 0.06 mg/kg/infusion) was no different from the rate in yoked controls. Self-administration was also seen for the high-affinity nAChR agonists cytisine (at doses of 0.025, 0.05, and 0.075 mg/kg/infusion) and lobeline (at doses of 0.25, 0.5, and 0.75 mg/kg/infusion); however, self-administration of the high-affinity nAChR agonists ABT-418 and epibatidine was not seen at the doses tested.

Studies in nAChR subunit knockout and knockin mice have produced direct evidence in support of the high-affinity nAChRs, especially $\beta 2$ -containing nAChRs, in promoting the reinforcing effects of nicotine. Mice deficient in $\beta 2$ nAChRs failed to self-administer nicotine and did not develop behaviors consistent with reinforcement.^{96,158,159} In these studies, $\beta 2$ knockout mice were trained first to execute nose pokes for cocaine (0.8 mg/kg/infusion) by responding to an active versus inactive port in an operant chamber. After achieving an asymptotic level of response, wild-type mice were switched to saline or 0.03 mg/kg/infusion of nicotine and $\beta 2$; knockout mice were switched to 0.03 mg/kg/infusion of nicotine. The rates of nose pokes significantly decreased for wild-type mice receiving saline and $\beta 2$ knockout mice receiving nicotine, but not for wild-type mice receiving nicotine.

Direct drug infusion has been a powerful approach for identifying nAChRs subtypes involved in the reinforcing effects and also for identifying the associated neural substrata. Direct infusion of pharmacological agents into the ventral tegmental area (VTA), an area shown to be involved in drug-seeking behavior, has established VTA nAChR involvement in self-administration.¹⁶⁰ In rats, direct infusion of the $\alpha 4\beta 2$ nAChR-favoring

antagonist dihydro- β -erythroidine (DH β E) into the VTA disrupted IV nicotine self-administration, suggesting that the reinforcement effect of nicotine emanated from high-affinity nAChRs in the VTA, such as the $\alpha 4\beta 2$ nAChR.¹⁶¹

Studies in mice have similarly demonstrated the involvement of VTA high-affinity nAChRs in the reinforcing effects of nicotine. Besson and colleagues¹⁶² examined if wild-type and $\beta 2$ knockout mice would self-administer either the vehicle, 100 ng of nicotine, or 200 ng of nicotine directly into the VTA. This study used a hybrid self-administration paradigm that required the mice to navigate a Y-maze. One arm of the Y-maze was associated with direct infusion of nicotine into the VTA. Wild-type mice showed a high level of self-administration for both doses of nicotine, and self-administration decreased when nicotine was replaced with the vehicle. In contrast, $\beta 2$ knockout mice had equal levels of the vehicle and nicotine self-administration. However, when nicotine was switched to morphine, the level of drug self-administration in $\beta 2$ knockout mice increased. This suggests that $\beta 2$ -containing nAChRs in the VTA are not involved in generalized reinforcing effects of drugs of abuse but are specifically involved in the reinforcing effects of nicotine. This was further substantiated¹⁶³ by showing that viral-mediated reexpression of the $\beta 2$ subunit in the VTA of $\beta 2$ mice would restore IV nicotine self-administration. This study also used the hybrid Y-maze self-administration paradigm with one arm associated with direct infusion of 36 ng of nicotine into the VTA. Infusion of nicotine into the VTA of wild-type mice, but not $\beta 2$ knockout mice, was reinforcing. However, the reexpression of the $\beta 2$ subunit in the $\beta 2$ knockout mice was associated with increased intra-VTA nicotine self-administration.

Because $\beta 2$ is widely expressed in the nervous system and is a promiscuous subunit, subsequent studies explored

the roles that different alpha subunits play in processes that may mediate self-administration. Such studies have revealed that $\alpha 6$ is particularly important to neurons of the VTA and basal ganglia,^{107,164–167} where it forms receptors composed of $\alpha 4\alpha 6\beta 2\beta 3$ subunits.⁶⁸ In fact, receptors harboring $\alpha 6$ may be disproportionately upregulated,¹⁰² or possibly downregulated,^{107,108} in response to chronic nicotine. In either case, this reinforces the hypothesis that this subunit plays a special role in the effects of nicotine related to self-administration and reinforcement.

In summary, studies demonstrate an important role of $\beta 2$ -containing nAChRs in the reinforcing effects of nicotine. Factors that influence $\beta 2$ -containing nAChR function, such as the inclusion of other subunits (e.g., $\alpha 6$) or other less defined genetic considerations, should alter nicotine self-administration. However, genetic influences on $\beta 2$ -containing nAChR function may not be the only factors that contribute variation in nicotine self-administration.

Behavioral Genetics of Self-Administration

Behavioral genetics studies that have compared oral nicotine self-administration across inbred strains of mice have helped to advance understanding of the genetics of nicotine dependence. For instance, in a study that compared oral self-administration of nicotine, ethanol, amphetamine, and aspartame between C57BL/6 inbred mice and DBA/2 inbred mice, clear differences were observed.¹⁶⁸ Because the focus of this monograph is on nicotine, only the treatment procedure for nicotine will be presented.

After eight days of habituation to the two-bottle-choice cages, one bottle was replaced with a 0.38-microgram per milliliter ($\mu\text{g}/\text{mL}$) nicotine bottle. After two days, the nicotine concentration was increased to 0.61 $\mu\text{g}/\text{mL}$ for two days, followed by

0.96 µg/mL for two days. The 0.96-µg/mL concentration was followed by four days at 1.54 µg/mL, six days at 2.42 µg/mL, and then eight days at each of the following concentrations: 3.84, 6.14, 9.60, 15.36, 24.19, and 38.39 µg/mL of nicotine. C57BL/6 mice displayed a greater preference for nicotine than did the DBA/2 mice. This was also true for ethanol and amphetamine, but not for aspartame, which DBA/2 mice preferred. Because C57BL/6 and DBA/2 mice are inbred strains, variance in behavior between the strains reflects the influence of genetics on the behavior. Thus, the results from this study demonstrate the existence of genetic influences on nicotine, ethanol, amphetamine, and aspartame oral self-administration. The study also suggests that the genetic influences on aspartame self-administration differ from those affecting nicotine, ethanol, and amphetamine self-administration.

A similar procedure was used in an expanded inbred mouse-strain survey of oral nicotine self-administration.⁶ C57BL/6, C3H, DBA/2, BUB, A, and ST/b mice were presented with a two-bottle choice: nicotine versus vehicle. The vehicle was either water or 2% saccharin. The concentration of nicotine changed from 10 to 20 to 35 to 50 to 65 to 80 to 100 to 125 to 160 to 200 µg/mL every four days. Increased nicotine concentration was inversely related to nicotine consumption, and this relationship was influenced by genetics. The concentration of nicotine that produced a 50% decrease in consumption relative to the 10 µg/mL concentration was compared across strains. This concentration was highest in C57BL/6 mice, followed by DBA mice, then BUB, A, C3H, and ST/b mice, respectively. Saccharin influenced nicotine intake only in C57BL/6 mice at low nicotine concentrations and in ST/b mice across all nicotine concentrations.

Comparable results were found in another strain survey of oral nicotine self-administration.¹⁶⁹ A two-bottle-choice

paradigm was used to compare oral self-administration of water and escalating doses of nicotine (1.75, 3.51, 8.77, 17.54, 26.31, and 35.08 µg/mL; five days of administration per level) across C57BL/6, C3H/J, DBA/2, ST/b inbred mice, NMRI outbred mice, and an A/J×NMRI cross. As reported before, strain differences existed in amount of nicotine consumed. C57BL/6 consumed the most nicotine, followed by C3H/J mice, the A/J×NMRI cross, DBA/2 mice, NMRI mice, and ST/b mice. Clearly, genetics contributes to differences in oral nicotine self-administration; however, in all three studies nicotine consumption was lower than vehicle consumption. Therefore, in these studies, it is unclear if genetics is influencing preference for nicotine or sensitivity to aversive effects of nicotine. One strategy for addressing this question would be to compare oral nicotine self-administration and IV nicotine self-administration across strains of inbred mice to determine if genetics of oral and IV nicotine self-administration are similar. This type of study remains to be done; most mouse behavioral genetic studies of nicotine self-administration have used oral nicotine self-administration.

One study directly tested if preference for oral self-administration of nicotine over water could be established.¹⁷⁰ Outbred CD-1 mice were maintained on a water-restriction schedule with water access limited to two hours. Mice were then presented with a two-bottle choice of water versus 10 mg/L nicotine for a two-hour period. In a follow-up experiment, the concentration of nicotine was reduced to the following levels every two days: 7, 5, 3.5, and 2.5 mg/liter (L). Mice preferred nicotine-containing solutions to water, and as the concentration of nicotine decreased, the fluid intake for nicotine, but not for water, increased. Individual differences in nicotine preference were then assessed. Mice were given another choice of a vehicle or 10 mg/L of nicotine; however, the vehicle

used a 10% sucrose solution to mask the bitter taste of the drug. After six days of training, the vehicle was switched to water and preference for nicotine was measured. A significant preference for nicotine was seen on day seven. This preference decreased over subsequent days. However, when mice were segregated by preference for nicotine on day seven, two subpopulations emerged: one showed preference for nicotine over all days of testing (days 7–10), and the other showed no preference for nicotine. This study suggests that in outbred mice, naturally occurring genetic variance could contribute to preference for oral nicotine; however, follow-up studies are needed to determine if polymorphisms exist between the two subpopulations.

A study that strongly suggests that genetic variance influences oral nicotine self-administration examined if expression of *Cyp2a5*—the homologue of the human gene *CYP2A6*, which codes for an enzyme involved in the metabolism of nicotine—is correlated with levels of oral nicotine self-administration.¹⁷¹ Because C57BL/6 mice show high levels of nicotine consumption and ST/b mice show low levels, F2 mice from a C57BL/6×ST/b cross were segregated into high and low oral nicotine consumers to test if levels of *Cyp2a5* protein similarly segregated. In male F2 mice, high nicotine consumption was associated with higher levels of *Cyp2a5* protein and, not surprisingly, faster metabolism of nicotine, suggesting that the genes involved in nicotine metabolism can influence oral nicotine self-administration. The same effect was not seen in female mice; thus, the expression of this phenotype may be linked to gender. The findings from this study, combined with the other behavioral genetics studies reviewed here, demonstrate how polymorphisms can alter nicotine self-administration and potentially influence nicotine dependence. Although genetic factors influence nicotine self-administration, environmental and developmental factors

most likely interact with genetics to alter nicotine self-administration.

Modeling Developmental Factors in Nicotine Reinforcement

A relationship exists between childhood exposure to tobacco industry promotional activities and risk for initiation of tobacco use (for a review, see DiFranza and colleagues¹⁷²). Thus, identifying variables that contribute to adolescent nicotine consumption may prove critical for the successful treatment and prevention of nicotine dependence. A limited number of studies in mice have examined factors that influence oral nicotine consumption in adolescent mice. One study compared oral nicotine consumption in outbred CD-1 mice across early (24–35 days), middle (37–48 days), and late (50–61 days) adolescence.¹⁷⁰ Water-restricted mice were given two-hour access to two bottles—water versus a 10 mg/L solution of nicotine—for six days, after which the nicotine concentration was reduced to 7 mg/L for the next three days, and then to 5 mg/L for the last three days. The youngest group demonstrated a preference for nicotine; nicotine and water consumption was equal in the mid-adolescence group, and the late adolescence group showed a trend for avoidance of the nicotine solution. These results suggest that early adolescence may be a critical period for increased risk of nicotine consumption.

Two factors that may contribute to adolescent nicotine intake are gender and novelty-seeking behavior. Gender differences in oral nicotine consumption by adolescent C57BL/6 mice (35 days of age) were examined using a two-bottle-choice paradigm.¹⁷³ Mice had access to the vehicle (2% saccharin) and one of six doses of nicotine (10, 25, 50, 75, 100, or 200 µg/mL) for seven days. When adjusted for body weight, female adolescent mice consumed more nicotine than did males. Adolescent smoking in humans can be associated with increased novelty-seeking

behavior or attempts to mitigate teenage angst and anxiety. A study in C57BL/6 mice directly examined if individual differences in novelty-seeking behavior or anxiety correlated with oral nicotine self-administration.¹⁷⁴ At postnatal day 30, novelty-seeking behavior and anxiety were assessed using the hole-board activity box. After testing, nicotine consumption was measured for 10 days using a two-bottle-choice paradigm: water versus 10 µg/L nicotine. No correlations existed between novelty seeking and anxiety. However, adolescent mice classified as high novelty seeking consumed more nicotine than did adolescent mice classified as low novelty seeking; no relation was found between anxiety levels and nicotine consumption. These results agree with results from human research that show that novelty seeking, or a personality trait of disinhibition, is a risk factor for smoking (chapters 3 and 5).

Involvement of Extra-Nicotinic Mechanisms

An interaction among nAChRs and other neurotransmitter systems, most notably changes in dopamine signaling, appears to be critical to the reinforcing effects of nicotine in the VTA. One study examined involvement of dopamine D1 receptors in the reinforcing effects of nicotine infused into the VTA.¹⁶² Four groups of C57BL/6 mice were trained in the Y-maze intra-VTA nicotine self-administration paradigm. Mice received either the vehicle infused into the VTA, 10 ng of nicotine infused into the VTA, 100 ng of nicotine infused into the VTA, or 100 ng of nicotine infused 2.3 millimeters dorsal of the VTA. The 10-ng and 100-ng doses of nicotine infused into the VTA were more reinforcing compared to vehicle and nicotine infusions dorsal to the VTA. The D1 dopamine receptor antagonist SCH 23390 and the high-affinity $\alpha 4\beta 2$ nAChR antagonist DH β E blocked the reinforcing effects of intra-VTA nicotine self-administration. These results suggest

that nicotine activation of high-affinity nAChRs (e.g., $\alpha 4\beta 2$ nAChRs) in the VTA may modulate D1 dopamine receptor activity and reinforcement.

Studies suggest that both metabotropic and *N*-methyl-D-aspartic acid (NMDA) glutamate receptors are also involved in the reinforcing effects of nicotine. Sorger and colleagues investigated the role of the metabotropic glutamate receptor 5 (mGluR5) in nicotine self-administration in DBA/2 mice.¹⁷⁵ DBA/2 mice were trained to execute nose pokes for either saline or one of four doses of nicotine (0.016, 0.048, 0.16, 0.48 µg/infusion, IV self-administration). Only the 0.048-µg dose of nicotine was associated with increased nose pokes compared to the yoked control. This increase was blocked by administration of 2-methyl-6-(phenylethynyl)-pyridine, an mGluR5 antagonist. The involvement of the glutamate system in IV nicotine self-administration was further investigated by examining the effects of the NMDA receptor channel blocker memantine on self-administration.¹⁷⁶ A yoked experimental design was used, and Swiss mice in the active chamber executed nose pokes for either 0, 0.03, 0.06, or 0.11 µg of nicotine. The 0.06-µg dose of nicotine was associated with the greatest increase in nose pokes. This effect was blocked by memantine. Subsequently, however, the pharmacological specificity of this agent has been extended to include $\alpha 7$ nAChRs,¹⁷⁷ which could cloud the interpretation of this effect as being mediated solely through NMDA receptors. However, as reviewed earlier, the reinforcing effects of nicotine appear to be largely dependent on high-affinity nAChRs and relatively independent of $\alpha 7$ nAChRs.^{11,158,162,178}

Clearly, the nicotinic and the glutamate systems interact to support self-administration of nicotine; however, the mechanism underlying this interaction remains unclear and possibly multifaceted. Certainly, glutamate receptor (GluR)

function is modified by nicotine acting through nAChRs, as reported by multiple electrophysiological examinations.^{62,64,179–181} However, additional cell-mediated mechanisms, including alteration of GluR transport by the neurons¹⁸² and the modification of susceptibility to proteolysis,¹⁸³ must be included in considerations of how nicotine affects this major excitatory system.

Finally, in addition to dopamine and glutamate involvement in the reinforcing effects of nicotine, GABA may also be involved. The effects of the GABA_B receptor agonist baclofen on IV nicotine self-administration was assessed in mice; unfortunately, the study did not specify the strain of mice.¹⁸⁴ Mice in the chamber with the active nicotine (0.03 mg/kg/infusion)-associated port executed significantly more nose pokes than did yoked controls. Baclofen decreased responding at the nicotine-associated port, suggesting that activation of GABA_B receptors decreases the reinforcing effects of nicotine. A thorough explanation for the reinforcing effects of nicotine acting through other neurotransmitter systems, including dopaminergic, glutamate, and GABA, requires more detailed investigation. It remains clear, however, that modulation of these systems through both nAChRs and related polymorphisms is likely to form the basis of the complex genetic components that combine to define the reinforcing effects of nicotine for individuals.

The cellular and molecular changes triggered by activation of nAChRs and other neuropharmacological systems that underlie the reinforcing effect of nicotine (e.g., dopamine, glutamate, and GABA systems) may involve altered calcium-mediated cell signaling. Swiss albino mice were trained to execute a nose poke for 0, 0.01, 0.02, 0.03, or 0.04 mg/kg/infusion of nicotine.¹⁸⁵ The dose-response curve was an inverted function; the 0.02- and 0.03-mg/kg/infusion doses of nicotine produced significant increases in nose

pokes, with the 0.03-mg/kg/infusion dose producing the largest change. A 2.4-mg/kg dose of the nAChR antagonist mecamylamine blocked the reinforcing effects of 0.03 mg/kg/infusion of nicotine but had no effect on responding in the saline control group. In addition, the L-channel calcium antagonist isradipine dose dependently inhibited the reinforcing properties of 0.03 mg/kg/infusion of nicotine without altering baseline levels of nose pokes. Additional work is needed to further elucidate the molecular substrata of the reinforcing effects of nicotine because genetic influences on these substrata could contribute to variability in the reinforcing effects of nicotine.

In summary, self-administration studies in mice that examined the reinforcing effects of nicotine have demonstrated that mice will self-administer nicotine and have identified the neural and genetic substrata involved. For example, these studies have demonstrated that high-affinity nAChRs in the VTA are involved in nicotine self-administration and that calcium-mediated cell signaling is also involved. In addition, these studies have shown that genetic variation contributes to variation in nicotine self-administration, and they have identified the *Cyp2a5* gene, which is involved in nicotine metabolism, as a gene potentially linked to nicotine self-administration. Finally, these studies have identified potential risk factors that may, in general, contribute to adolescent nicotine use: age, gender, and risk-taking behavior.

Nicotine and Reward

Conditioned place preference (CPP) is used as a model to investigate the rewarding effects of nicotine.¹⁸⁶ Nicotine administration is repeatedly paired with one chamber, and saline administration is repeatedly paired with a second. The mouse or rat is then given access to both chambers,

and greater time spent in the chamber previously paired with nicotine is taken as a measure of preference for nicotine. In addition to measuring the rewarding properties of nicotine, CPP also measures the ability to form associations between the effects of nicotine and a contextual environment. Thus, for any manipulation that disrupts CPP, it must be determined if the manipulation is altering learning or reward processes. Experiments using CPP to investigate the rewarding effects of nicotine in mice have identified procedural variables that affect the development of nicotine CPP and have identified underlying neural and genetic substrata involved in CPP.

Research using CPP provides a complementary perspective to research on self-administration. Although self-administration should, in theory, reflect the hedonic or rewarding impact of nicotine on the mouse, it may also reflect other factors as well. One such factor is nicotine metabolism, which might affect tolerance to the repeated doses of nicotine used in self-administration studies, but be somewhat less relevant to the effects of acute doses delivered in CPP studies. Other differences between the self-administration and CPP paradigms could “select out” different genetic associates; for example, different sorts of learning are involved (Pavlovian versus instrumental), and only the self-administration paradigm permits the organism control over drug administration. Thus, it is quite likely that the two approaches will show different data patterns across strains and involvement of different neurotransmitter systems. However, the fact that all addictive drugs support both drug self-administration and CPP acquisition suggests that both are sensitive to drug reinforcement.

External variables that can influence CPP include the dose of nicotine and prehandling. The effects of four different doses of nicotine (0.25, 0.5, 1.0, or 2.0 mg/kg) on

CPP were tested in Swiss-Webster mice.¹⁸⁷ Mice showed a preference for the chamber previously paired with 0.5 mg/kg of nicotine but avoided the chamber previously paired with 2.0 mg/kg of nicotine. No significant preference or avoidance was seen for the 0.25-mg/kg or 1.0-mg/kg doses. This study demonstrates that the effects of nicotine can shift from rewarding to aversive, depending on the dose of nicotine used in mice. Another study examined both the effects of prehandling on CPP in ICR mice and the effects of different doses of nicotine on CPP.¹⁸⁸ CPPs for multiple doses of nicotine (0.1, 0.25, 0.35, 0.5, 0.7, or 1.0 mg/kg) were measured; only the 0.5-mg/kg dose was associated with CPP, but only for prehandled mice. Both studies suggest that a 0.5-mg/kg dose of nicotine is rewarding, as measured by CPP. In addition, prehandling can affect the development of CPP, but it is unclear if this is a strain-specific effect and specifically related to CPP or anxiety levels of the mice.

Strain Differences

As discussed, external variables such as prehandling can affect CPP, but internal factors such as genetics also influence nicotine CPP. Studies comparing inbred strains of mice and studies using selective breeding have shown that differences in nicotine CPP are associated with genotype.

In a study using selective breeding, three lines of mice derived from heterogeneous stock mice were tested in CPP: a line in which 0.75 mg/kg of nicotine depressed locomotor activity, a line in which the same dose increased locomotor activity, and a randomly bred line.¹⁸⁹ A 0.75-mg/kg dose of nicotine produced CPP in the line generated by random breeding and the line bred for the stimulatory effects of nicotine on locomotor activity. In contrast, the same dose produced conditioned place aversion in the line bred for sensitivity to the locomotor depressant effects of nicotine. These results suggest that genes involved in the psychostimulant effects

of nicotine may also be involved in the rewarding effects of nicotine. Another study compared CPP across inbred strains of mice to test if natural genetic variance contributed to differences in the rewarding effects of nicotine. Multiple doses of nicotine were tested for CPP in C57BL/6 mice (0.05, 0.1, 0.3, 0.5, or 0.7 mg/kg) and in DBA/2J mice (0.3, 0.7, or 1 mg/kg¹⁸⁸). The C57BL/6 mice showed significant CPP for the 0.3-mg/kg dose of nicotine, but the DBA/2J mice did not show even a trend toward CPP. Both of these studies demonstrate that genotype contributes to phenotype for nicotine CPP.

A direct comparison between the genetic influences on CPP versus nicotine self-administration can be made by comparing results from studies that contrasted these measures in DBA/2 and C57BL/6 mice. Studies previously discussed in this chapter found that C57BL/6 mice consumed more nicotine than did DBA/2 mice.^{6,168,169} Similar differences were found for CPP. These results suggest that C57BL/6 mice are more sensitive to the effects of nicotine that may support dependence. Furthermore, these results could suggest that common genes are involved in CPP and oral nicotine self-administration; however, caution must be exercised because an extensive comparison across multiple inbred strains, using multiple nicotine doses and behavioral assays, is necessary to strengthen this argument.

Involvement of Receptor and Neurotransmitter Systems

In addition to identifying genetic influences on nicotine CPP, mouse studies have also examined receptor subtype involvement in CPP. The effects of the broad-spectrum nAChR antagonist mecamylamine, the high-affinity nAChR antagonist DH β E, and the α 7 nAChR antagonist methyllycaconitine citrate (MLA) on nicotine CPP were assessed in ICR mice.¹⁸⁸ Both mecamylamine and DH β E significantly decreased nicotine CPP

for a 0.5-mg/kg dose of nicotine, whereas a nonsignificant trend toward attenuated CPP was seen with MLA. This study suggests that high-affinity nAChRs, such as the α 4 β 2 nAChR, are involved in the rewarding effects of nicotine.

Another study examined the nAChR subtypes involved in nicotine CPP by using both pharmacological and genetic inhibition of nAChR subunits.¹⁹⁰ Multiple nicotine doses were tested for CPP in (1) C57BL/6 mice, (2) β 2 nAChR subunit knockout mice and corresponding wild-type mice, and (3) α 7 nAChR subunit knockout mice and corresponding wild-type mice. C57BL/6 mice showed significant CPP for 0.3 and 0.5 mg/kg of nicotine but not for 0.1, 0.7, or 1.0 mg/kg nicotine. In β 2 knockout mice, neither 0.5, 1.0, nor 2.0 mg/kg of nicotine produced CPP, but in wild-type mice, both 0.5 and 1.0 mg/kg produced CPP. The α 7 knockout mice and wild-type mice both showed nicotine CPP. Further demonstrating a critical role of β 2-containing but not α 7-containing nAChRs in CPP, the α 4 β 2 antagonist DH β E blocked nicotine (0.5 mg/kg) CPP in C57BL/6 mice, but the α 7 nAChR antagonist MLA had no effect on nicotine CPP. Thus, β 2-containing nAChRs appear to be involved in nicotine CPP.

In addition to the nicotinic acetylcholinergic system, other neurotransmitter systems may also be involved in CPP. In mice, studies have suggested that the adenosine, endogenous cannabinoid, and neuropeptide systems may all be involved in the effects of nicotine on reward. Adenosine 2_A (A_{2A}) knockout mice and wild-type mice were tested for the development of CPP to a 0.18- and a 0.35-mg/kg dose of nicotine.¹⁹¹ Wild-type mice developed CPP for 0.18 mg/kg of nicotine but not for 0.35 mg/kg of nicotine. The A_{2A} knockout mice did not develop CPP for either dose. Also, both wild-type mice and A_{2A} knockout mice showed conditioned taste aversion to saccharin that was paired with a 1.75-mg/kg intraperitoneal (IP)

dose of nicotine. The A_{2A} receptor appears to be involved in the rewarding effects of nicotine but not its aversive effects. This also suggests that A_{2A} is involved in mediating the appetitive effects of nicotine and not in nicotine-based associative processes.

Another study from the same laboratory examined the role of the endogenous cannabinoid CB1 receptor in CPP for nicotine.¹⁹¹ CPP was tested for 0.04, 0.09, or 0.18 mg/kg of nicotine in CB1 knockout mice and wild-type mice. The 0.18-mg/kg dose of nicotine produced CPP in wild-type mice, but no dose of nicotine produced CPP in the CB1 knockout mice. The antinociceptive effects of nicotine, however, were not disrupted in CB1 knockout mice. Thus, CB1 receptors may modulate the rewarding effects of nicotine, and drugs altering the cannabinoid system, such as the CB1 antagonist rimonabant, may have therapeutic potential for assisting in smoking cessation (for a review see Siu and Tyndale¹⁷¹).

Multiple studies suggest that the rewarding effects of nicotine can be modulated by neuropeptides, perhaps through effects at the mu opioid receptor. CPP for 0.09, 0.18, or 0.35 mg/kg of nicotine was compared between preproenkephalin knockout mice and wild-type mice.¹⁹² Wild-type mice developed CPP for the 0.18-mg/kg dose, whereas the preproenkephalin knockout mice did not show CPP for any dose tested. The 0.18-mg/kg dose of nicotine increased dopamine levels in the nucleus accumbens of wild-type, but not knockout, mice. Thus, the endogenous enkephalin system may be involved in the rewarding effects of nicotine through altering dopamine signaling. Preproenkephalin stimulates mu opioid receptors, and consequently, mu opioid receptors may be involved in the effects of nicotine on CPP. Pharmacological studies and studies in mu opioid receptor knockout mice have directly tested if the mu opioid receptor is involved in the rewarding effects

of nicotine. In NMR1 mice, nicotine CPP was successfully demonstrated for 1 mg/kg and 2 mg/kg of nicotine but not for 0.5 or 0.75 mg/kg of nicotine.¹⁹³ The mu opioid receptor antagonist naloxone blocked CPP for 1 mg/kg of nicotine, providing evidence for the involvement of mu opioid receptors in nicotine CPP. Genetic inhibition of mu opioid receptor function also disrupts nicotine CPP. No CPP for nicotine was seen in mu opioid knockout mice for all doses of nicotine tested (0.09, 0.18, and 0.35 mg/kg), which contrasts with findings with the wild-type mice that showed CPP for the 0.18-mg/kg dose but not for the 0.09- or 0.35-mg/kg doses of nicotine.¹⁹⁴ The mu opioid receptor does not appear to be involved in all of the effects of nicotine because deletion of the mu opioid gene did not alter the locomotor depressive effects of nicotine. The processes activated by mu opioid receptors, however, that are involved in nicotine CPP are not well understood but may involve changes in gene expression.

The transcription factor CREB is involved in learning and memory,¹⁹⁵ and in dependence;¹⁹⁶ mu opioid receptors may mediate the rewarding effects of nicotine through activation of CREB.¹⁹⁰ In wild-type mice, 0.35 mg/kg of nicotine produced CPP, but 0.70 mg/kg of nicotine produced conditioned place aversion. The 0.35-mg/kg dose of nicotine was associated with increased levels of phosphorylated CREB in the nucleus accumbens and VTA. Both CPP and the increased levels of phosphorylated CREB were reduced by pretreatment with naloxone. In addition, mu opioid knockout mice did not show increased levels of phosphorylated CREB after treatment with the same dose of nicotine. These results suggest that mu opioid receptor activation of CREB may be critically involved in CPP. In support, the same study found the CREB^{Δ6} knockout mice did not show CPP for 0.35 mg/kg of nicotine but did show conditioned place aversion for 0.7 mg/kg of

nicotine. Thus, cell-signaling cascades that activate CREB may be critically involved in the rewarding effects of nicotine, and activation of the mu opioid receptor may be one pathway that leads to reward-related increased activation of CREB. Not all effects of nicotine, however, involve activation of CREB, as demonstrated by intact, conditioned place aversion for nicotine in CREB^Δ knockout mice.

Another transcription factor that may be involved in CPP is Fosb.¹⁹⁷ Both wild-type and Fosb knockout mice were tested for the development of CPP. At 0.2 mg/kg, wild-type mice showed CPP, which shifted to aversion at doses of 0.8 and 2.0 mg/kg. In contrast, Fosb knockout mice did not develop CPP for any dose tested (0.025–2.0 mg/kg) but did show aversion for doses of 0.6 mg/kg and higher. These results show that while Fosb knockout mice can learn (i.e., they show conditioned place aversion), they do not seem sensitive to the rewarding effects of nicotine. Furthermore, the knockout mice also showed reduced oral intake of 50-μg/mL nicotine in a two-bottle-choice paradigm, suggesting that Fosb is involved in processes common to CPP and choice of nicotine consumption.

Two studies examined the role of the cell-signaling molecule nitric oxide in nicotine CPP in Swiss-Webster mice. Nitric oxide is critically involved in some forms of synaptic plasticity^{198,199} and may contribute to the addictive effects of drugs of abuse such as nicotine.²⁰⁰ In one study, mice successfully developed CPP for 0.5 mg/kg of nicotine,²⁰¹ unless given the nitric oxide synthase inhibitor 7-nitroindazole (25 mg/kg). However, 7-nitroindazole had no effect on lithium-chloride conditioned place aversion, suggesting that the effects of 7-nitroindazole on CPP were not due to a generalized learning deficit. Another study investigated if the nitric oxide precursor L-arginine would enhance nicotine CPP.²⁰² Multiple nicotine doses (0.25, 0.5, 0.75, 1.0, and 2.0 mg/kg)

were tested in CPP, and both the 1.0- and 2.0-mg/kg dose produced nicotine CPP. Interesting, L-arginine alone also produced CPP at doses of 200 and 500 mg/kg, but not at doses of 50, 100, or 150 mg/kg. When ineffective doses of nicotine and L-arginine were paired together, CPP resulted. Both the nAChR antagonist mecamylamine and the nitric oxide synthase inhibitor L-nitro-amino-methyl-ester blocked the acquisition, but not the expression of, CPP for the 1.0-mg/kg dose of nicotine. Together, the results from these studies suggest that nitric oxide mediates important functions associated with acquisition of nicotine CPP.

In summary, mouse research shows that nicotine reward is highly dose dependent. Specifically, as dose is increased from inert levels, mice first show robust CPPs, but ultimately, place aversions develop as doses are progressively increased. In addition, even within a strain, doses effective for establishing CPP can vary across studies. This suggests that CPP is sensitive to methodological and environmental factors, such as the construction of the apparatus and handling. Studies comparing inbred mice suggest that C57BL/6 mice may be particularly sensitive to the rewarding effects of nicotine. Further genetic studies are needed to elucidate strain differences in the rewarding effects of nicotine and to determine if common genetic substrata mediate the rewarding, aversive, and activating effects of nicotine. For instance, the stimulatory effects of nicotine and the rewarding effects of nicotine may be genetically linked. In addition, mouse studies have aided in identifying the neural substrates of the rewarding effects of nicotine. High-affinity nAChRs, such as the $\alpha 4\beta 2$ nAChR, appear to be critically involved in the rewarding effects of nicotine. The effects of nicotine at nAChRs may result in the activation of cell-signaling molecules such as nitric oxide and CREB that have been shown to be involved in drug dependence.

Tolerance

The rewarding and reinforcing effects of nicotine are not the only effects of nicotine that contribute to nicotine dependence; physiological adaptations that occur with chronic nicotine administration may lead to nicotine dependence and tolerance. Tolerance is a shift in the dose-response curve to the right following exposure to the drug in question. That is, with increased drug exposure, and resulting tolerance, an increasing amount of drug is required to produce a given magnitude of effect.

Tolerance has been demonstrated after both acute and chronic nicotine administration for the effects of nicotine on multiple behaviors and physiological responses. Studies in mice have elucidated the neural and genetic substrata associated with the development of tolerance and have helped identify neural adaptations that occur with chronic nicotine administration (figure 4.5). Much of the research discussed below addresses the topic of behavioral tolerance—that is, tolerance to behavioral or physiological effects of a drug that is not accounted for by enhanced drug clearance. Animals also acquire dispositional tolerance, which means enhanced clearance or metabolism of a drug as a function of prior exposure. The latter phenomenon has been discussed in the context of *Cyp2a5* expression.¹⁷¹ The following sections review both acute and chronic tolerance. Significantly more is known about chronic tolerance, permitting a review of behavioral, genetic, and neural factors (from the level of the receptor to downstream cell-signaling cascades) involved in tolerance.

Acute Tolerance

Single injections of nicotine can produce tolerance to some of the direct effects of nicotine. The development and duration of such acute tolerance for the effects

of nicotine on antinociception, body temperature, and motor activity were investigated in ICR mice.²⁰³ Mice were treated with 4 mg/kg of nicotine and then challenged with a 2-mg/kg subcutaneous (SC) dose. The time to maximum tolerance and the duration of acute tolerance varied across tasks; maximum acute tolerance for the antinociceptive effects of nicotine was seen at between 30 and 60 minutes, and recovery from acute tolerance occurred after 6 hours; maximum acute tolerance for nicotine-induced motor impairments occurred between 3 and 6 hours and dissipated by 24 hours, and maximum acute tolerance for nicotine-induced hypothermia occurred between 2 and 4 hours and lasted 6 hours. The effect of intrathecal administration (i.e., injection into cerebral spinal fluid at the spinal cord) on the development of acute tolerance for the antinociceptive effects of nicotine was also tested. Maximal acute tolerance was seen at 5–10 minutes, and effective doses for the initial induction of tolerance ranged between 0.5 to 1 µg. Acute tolerance was disrupted by the calcium channel blocker nimodipine administered either via SC or intrathecal injections, suggesting that changes in calcium levels contribute to the development of acute tolerance.

Genetics may contribute to variability in acute tolerance. Miner and Collins²⁰⁴ found that pretreating DBA mice with doses of a nicotine subthreshold for inducing seizures (1 or 2 mg/kg) either 15 or 30 minutes before testing for nicotine-induced seizures produced acute tolerance; by 60 minutes, acute tolerance was lost. In C3H mice, only pretreatment with the 2-mg/kg dose of nicotine resulted in acute tolerance and only when pretreatment was 7.5 minutes before testing for nicotine-induced seizures. These results suggest that genetic differences between DBA and C3H mice account for the increased sensitivity for acute tolerance in the DBA mice. The authors propose that nicotine inactivation of nAChRs may

account for the observed acute tolerance and that strain differences in desensitization or inactivation of nAChRs may underlie the strain differences in acute tolerance.

Less is known about the genetic factors that influence the likelihood or magnitude of such acute tolerance compared with chronic tolerance. In addition, there is little evidence from the human literature that indicates a role for tolerance in dependence.

Chronic Tolerance

Tolerance that develops after chronic treatment of nicotine has also been demonstrated on numerous measures. In theory, chronic tolerance might be related to dependence because higher levels of tolerance may permit higher rates of self-administration, which, in turn, result in greater effects on dependence processes. Although not a great deal of evidence links degree of chronic tolerance with tendency to self-administer nicotine, there are data showing that prolonged exposure to nicotine inures mice to the aversive effects of nicotine that they experience secondary to self-administration. The effects of chronic nicotine exposure on subsequent nicotine IV self-administration and the development of tolerance to the aversive effects of nicotine were assessed in DBA/2 mice.²⁰⁵ Nose pokes delivered either saline, or one of four doses of nicotine (0.016, 0.048, 0.16, 0.48 $\mu\text{g}/\text{infusion}$), to the mouse executing the nose poke and to a yoked control. The 0.048 $\mu\text{g}/\text{infusion}$ dose of nicotine was associated with a higher rate of nose pokes by mice in the chamber with the active port compared to the yoked mice. After self-administration, one-half of the mice were implanted with SC minipumps that delivered 6.3 mg/kg/day of nicotine or saline for 14 days. After removal of the pumps, the highest dose of nicotine (0.48 $\mu\text{g}/\text{infusion}$) self-administered was aversive in mice chronically treated with saline but not in mice chronically treated with nicotine. These data suggest that

chronic nicotine exposure renders the organism less sensitive to the aversive effects of nicotine that is self-administered.

Behavioral Analysis of Tolerance

In many tolerance studies, the experimenter controls nicotine administration; however, oral self-administration can also induce tolerance. Tolerance for the acute effects of nicotine (1 mg/kg) on the depression of locomotor activity and on the induction of hypothermia was measured in mice that had access for 30 days to either 2% saccharin, 50 $\mu\text{g}/\text{mL}$ of nicotine in 2% saccharin, 100 $\mu\text{g}/\text{mL}$ of nicotine in 2% saccharin, or 200 $\mu\text{g}/\text{mL}$ of nicotine in 2% saccharin.¹⁴⁰ The 200- $\mu\text{g}/\text{mL}$, but not the 100- $\mu\text{g}/\text{mL}$, oral nicotine group showed tolerance for the effects of acute nicotine on both locomotor activity and body temperature. In another study that assessed the development of tolerance with oral nicotine self-administration, ICR mice had access for 42 days to either 2% saccharin, 50 $\mu\text{g}/\text{mL}$ of nicotine in 2% saccharin, 100 $\mu\text{g}/\text{mL}$ of nicotine in 2% saccharin, or 200 $\mu\text{g}/\text{mL}$ of nicotine in 2% saccharin.¹⁴⁶ On day 43, tolerance for the effects of 2.5 mg/kg of nicotine on nociception and body temperature was measured. Tolerance was seen for all doses of oral nicotine with the 200- $\mu\text{g}/\text{mL}$ dose of nicotine producing the most tolerance. This dose produced a plasma nicotine level of 15.85 ± 10.54 ng/mL. Both of these studies demonstrate that self-administration of nicotine can produce tolerance for the effects of nicotine on multiple behaviors.

The majority of the studies examining the development of tolerance in mice have focused on tolerance for the effects of nicotine on physiological and locomotor responses, but nicotine can also alter cognition. A series of experiments has examined how the effects of nicotine on learning change as nicotine administration is shifted from acute

to chronic administration. In C57BL/6 mice, acute nicotine enhanced contextual conditioning^{206,207}—that is, learning to associate a specific context with a stimulus such as a foot shock (for a review see Gould²⁰⁸). If, however, C57BL/6 mice are treated for 14 days with a chronic dose of nicotine (6.3 mg/kg/day, SC) producing the same plasma nicotine level as seen with the acute dose of nicotine (0.09 mg/kg) that enhanced contextual conditioning, no enhancement of contextual conditioning is seen. Thus, even though plasma nicotine levels were similar, the behavioral effects of the acute and chronic nicotine were not the same; acute nicotine treatment enhanced contextual conditioning, whereas chronic nicotine treatment failed to enhance contextual conditioning, suggesting the development of tolerance.²⁰⁹ It should be noted that plasma nicotine levels in mice treated acutely and chronically with nicotine (13 ng/mL) were within the range of plasma nicotine levels (10–50 ng/mL) demonstrated by smokers.^{210,211}

The above results demonstrate the development of tolerance for the effects of nicotine on cognition. The neural adaptations responsible for this behavioral change are unknown, but studies examining tolerance for the effects of nicotine on locomotor activity and physiological responses have identified accompanying changes in receptor density and function. This research is consistent with other research showing that behavioral tolerance cannot be explained by degree of dispositional tolerance. It must involve separate CNS neural adaptations that permit one animal to compensate for the disruptive effects of a drug, while another animal with the same level of the drug in its body shows greater drug effects. This phenomenon has, of course, many precedents with other drugs of abuse, with studies showing that most adaptation to drug-induced behavioral disruption is caused by learning mechanisms, rather than dispositional tolerance.^{212,213}

Behavioral Genetics of Tolerance and Putative Substrata

Experiments conducted three decades ago provided early evidence of strain differences in tolerance. In one study,²¹⁴ DBA/2 and C57BL/6 mice were compared on the development of tolerance to nicotine. Mice received three daily IP injections of 1 mg/kg of nicotine for two, four, or seven days. Genotype and gender both contributed to variance in developing tolerance to the effects of nicotine on Y-maze activity. C57BL/6 male mice developed tolerance most rapidly, and DBA/2 male mice had the latest onset of tolerance; female mice of both genotypes developed tolerance at the same rate, but C57BL/6 female mice showed greater tolerance. A subsequent study examined the effects of chronic IV administration of 2, 4, or 6 mg/kg of nicotine for 10 days on nicotine and α -bungarotoxin binding as well as the effects of acute nicotine on Y-maze activity and rears, acoustic startle, heart rate, respiration rate, and body temperature in both DBA/2 and C3H/2 inbred mice.²¹⁵ DBA/2 and C3H/2 mice differed in the development of tolerance, but not in ³H-nicotine binding or α -bungarotoxin binding, the two means available at that time for quantitation of nAChR expression.

The effects of chronic nicotine treatment were also extended to compare effects of chronic nicotine on tolerance and nAChR binding in C57BL/6, DBA/2, C3H/2, and BALB/cBy mice.⁵ Mice were treated with 3 mg/kg/hour of nicotine intravenously for 10 days. Assays included tolerance to the acute effects of nicotine on Y-maze activity, startle response, heart rate, respiratory rate, and body temperature. This research revealed substantial interspecific variability in response to chronic nicotine exposure. Only C3H mice developed tolerance for the effects of nicotine on acoustic startle. However, C57BL/6, DBA/2, and BALB/cBy mice, but not C3H mice, all showed tolerance to the effects of nicotine on Y-maze

activity and body temperature. In addition, BALB/cBy mice showed tolerance for the effects of nicotine on heart rate. No strains showed tolerance for the effects of nicotine on respiratory rate, a measure of nAChR function in the autonomic nervous system. All four strains showed similar increases in nicotine binding in the cortex, hippocampus, midbrain, striatum, hypothalamus, and hindbrain after chronic nicotine treatment. Another marker of nicotine receptor expression, α -bungarotoxin binding, varied across strains in those areas of the brain after chronic nicotine treatment. DBA/2 mice showed increased binding in the cortex, hippocampus, and hypothalamus; C57BL/6 mice showed increased binding in the hindbrain and hippocampus; BALB/cBy mice showed increased binding in the hindbrain and hypothalamus, and C3H mice showed increased binding only in the hypothalamus. In sum, this early research showed considerable variability in tolerance development across inbred mouse strains and across physiological systems in response to nicotine exposure.

Genetic analysis was also used to examine the dose-dependent effects of chronic nicotine treatment on tolerance and changes in binding in A, C57BL/6, DBA/2, C3H/2, and BUB/Bn mice.⁵ Mice were chronically infused with 0, 0.5, 1.0, 2.0, 4.0, or 6.0 mg/kg/hour of nicotine intravenously for 10 days and then tested for tolerance to the acute effects of nicotine on Y-maze activity and rears, acoustic startle, heart rate, respiration rate, and body temperature. C57BL/6 mice were more sensitive to the effects of chronic nicotine than C3H/2 and BUB/Bn mice in that the latter showed tolerance for only the highest doses tested; A and DBA/2 mice were intermediate. Changes in nAChR binding were measured in the cortex, cerebellum, colliculi, hindbrain, hippocampus, hypothalamus, midbrain, and striatum. All strains showed increased nicotine binding after chronic nicotine treatment, but variability across

strains was seen for sensitivity to doses and for brain regions affected. For instance, A mice showed less change in binding across brain regions, and changes in binding were seen at higher doses, whereas C57BL/6 mice showed changes in binding in all brain regions and the lowest dose of nicotine-increased binding in six of the eight regions tested. Changes in α -bungarotoxin binding associated with chronic nicotine treatment were also seen but to a lesser extent than with nicotine binding.

Interestingly, changes in receptor binding may not exclusively explain tolerance. The time course for the development of tolerance for the effects of nicotine on locomotor activity, as measured by Y-maze activity and rears, body temperature, and heart rate, were compared with the time course for the effects of chronic treatment on nAChR binding in DBA mice.¹⁴ DBA mice were infused with 4 mg/kg/hour of nicotine, and tolerance was assessed after 1, 2, 4, 8, or 12 days of treatment. Maximal tolerance to the effects of an acute dose of 0.75 mg/kg of nicotine was seen after four days of treatment, and the development of tolerance corresponded to increased binding of nicotine in the cortex, midbrain, hindbrain, hippocampus, and hypothalamus. Chronic nicotine treatment was also associated with increased α -bungarotoxin binding in the cortex and hippocampus, but the increase in low-affinity nAChR binding occurred before the development of tolerance. Tolerance for the effects of nicotine on Y-maze locomotor activity and rears was lost after 8 days, tolerance to the acute effects of nicotine on body temperature was lost after 12–16 days, and tolerance to the acute effects of nicotine on heart rate was lost after 20 days. Nicotine binding, however, returned to control levels after 8 days, and α -bungarotoxin binding returned to control levels after only 4 days. These results suggest that changes in nAChR density may, in part, contribute to tolerance, but may not be the only mechanism involved because receptor binding returned to control

levels before all of the physiological measures of tolerance returned to control levels. This result is consistent with a great deal of other evidence that behavioral tolerance involves complex learning processes.^{212,213}

Although the above studies collectively established a genetic basis for the response to nicotine and changes in receptor properties, they also preceded molecular studies revealing that beyond simply those systems detected by nicotine and α -bungarotoxin binding, there is a diverse genetic richness in the genes that constitute the nAChR family and that collectively contribute to the functional and regionally specific effects of nicotine on the organism.

Involvement of nAChR and Other Neurotransmitter Systems

It is important to establish which nAChRs are implicated in chronic tolerance phenomena. As reviewed earlier, $\alpha 4\beta 2$ nAChRs are involved in CPP and nicotine self-administration; thus, a logical question is whether the same receptors are involved in tolerance. Although early studies, based almost entirely upon ligand-binding measurements, indicated that a variety of receptors appear to underlie the development of tolerance, subsequent directed genetic studies have helped elucidate the nAChR subtypes that play a central role in the development and/or expression of tolerance. $\beta 2$ nAChR subunit knockout mice treated chronically with 0, 1, 2, or 4 mg/kg/hour of IV nicotine for 10 days did not develop tolerance for the effects of nicotine on Y-maze activity and body temperature, but instead, showed increased sensitivity to the acute effects of nicotine after chronic treatment, suggesting that $\beta 2$ -containing nAChRs are involved in the development of tolerance for these measures.⁹⁷ Furthermore, mice with a single point mutation (Leu9' \rightarrow Ala9') that was associated with increased sensitivity of $\alpha 4$ -containing nAChRs exhibited heightened development of tolerance.¹⁷⁸

Mice were treated daily with a single 15- μ g/kg nicotine IP injection for nine days, and body temperature was measured. The Leu9' mutant mice developed tolerance to the effects of nicotine on body temperature by day nine, but the wild-type mice did not develop tolerance. In contrast to the $\beta 2$ and $\alpha 4$ nAChR subunits, which appear to be involved in tolerance, the $\alpha 7$ nAChR subunit may not be involved in tolerance because $\alpha 7$ -null mice exhibit normal development of tolerance to the effects of nicotine on schedule reinforcement.²¹⁶ Although the $\alpha 7$ subunit does not appear to be as important as once thought in this process, caution must be exercised; these studies used different measures of tolerance, and it is possible that the nAChRs involved in tolerance are measurement specific.

In sum, the results of the behavioral genetic analysis of tolerance provide several important insights into the effects of nicotine. First, these studies demonstrate that genetic variation contributes to the development of tolerance for the effects of nicotine. Second, these studies illustrate the potential for the use of the nAChR subunit null mouse in that they accurately complement most pharmacological and functional studies and demonstrate how mutations to genes coding for nAChR subunits can alter sensitivity to nicotine.

As in self-administration, other nonnicotinic systems may interact during tolerance development. For instance, there is evidence in DBA/2 mice of an interaction between the nicotinic and muscarinic acetylcholinergic systems. DBA/2 mice were treated chronically with IV administration of 8 mg/kg/hour of nicotine, 1 mg/kg/hour of oxotremorine (muscarinic agonist), or a vehicle for 10 days.²¹⁷ After chronic treatment, the acute effects of 2 mg/kg of nicotine or 0.2 mg/kg of oxotremorine on rotorod performance, Y-maze activity, heart rate, respiratory rate, and body temperature were measured, along with

nicotine and α -bungarotoxin binding. For all tests, tolerance was seen for both drugs. In addition, mice chronically treated with oxotremorine showed cross-tolerance with nicotine for nicotine-induced heart rate and body temperature change. Interestingly, mice chronically treated with oxotremorine showed decreased binding at muscarinic receptors, but no change in nicotine and α -bungarotoxin binding. In contrast, mice chronically treated with nicotine showed increased nicotine and α -bungarotoxin binding, but no change in muscarinic receptor binding. In addition to demonstrating cross-tolerance between muscarinic and nicotinic agonists, this study once again demonstrates that tolerance to the effects of nicotine can develop independent of changes in nAChR binding; mice treated chronically with oxotremorine showed tolerance for the effects of nicotine on heart rate and body temperature but did not show changes in binding at nAChRs.

The mu opioid receptor may also be involved in the development of tolerance to at least one effect of nicotine. C57BL/6 mice were treated chronically with nicotine (three daily SC injections of 1.75 mg/kg) for 12 days. Locomotor responses and nociception were measured on even-numbered days for 5 minutes (locomotor activity) and for 15 minutes (nociception) after nicotine injection.²¹⁸ After the last test, mu opioid binding was assessed. Tolerance was seen for nicotine-induced antinociception but not for the disruptive effects of nicotine on locomotor activity. Chronically treated mice had decreased mu opioid binding in the caudate-putamen and in the nucleus accumbens. Tolerance was also tested in mu opioid receptor knockout mice. These mice developed tolerance to the antinociceptive effects of nicotine faster than did wild-type mice. These results suggest that nicotine-mediated changes in mu opioid receptor function may contribute to the development of tolerance for the antinociceptive effects of nicotine.

Cell Signaling

Studies in mice have demonstrated that chronic nicotine treatment is often associated with an increase in nAChR density but a decrease in the function of those nAChRs.^{11,64} However, such changes in the nAChRs do not always correlate with the onset and duration of tolerance. This suggests that effects downstream of nAChR activation may be involved in tolerance. Changes in calcium-related cell signaling may be involved in the development of tolerance. The relationship between calcium signaling and the development of tolerance for the effects of nicotine on locomotor activity and nociception was measured in ICR mice.²¹⁹ Mice were treated chronically for 10 days with 2 mg/kg of SC nicotine twice daily. Tolerance was seen for the locomotor-impairing effects of nicotine and for the antinociceptive effects of nicotine. Mice that developed tolerance also showed cross-tolerance for the effects of BAY K 8644, a calcium channel agonist, and thapsigargin, which increases intracellular calcium concentrations, on locomotor activity and nociception. These results suggest that calcium signaling (possibly an $\alpha 3$ nAChR subtype) may be involved in the development of tolerance for some effects of nicotine. In further support of the involvement of calcium signaling in the development of tolerance to the effects of nicotine, drugs that alter calcium signaling altered tolerance.²²⁰ Mice treated chronically with 24 mg/kg/day (SC, minipump) of nicotine for 14 days were concurrently treated with a calcium channel antagonist, a calcium channel agonist, or a vehicle, and tolerance for the antinociceptive effects of nicotine was then measured. Twice daily injections of the L-type calcium channel antagonists nimodipine and verapamil blocked the development of tolerance; whereas twice-daily injections of BAY K 8644 enhanced the development of tolerance. In addition, the study found that tolerant mice had

higher levels of calcium calmodulin protein kinase II in the spinal cord, and infusion of the calcium calmodulin protein kinase II antagonist KN-62 into the spinal cord decreased tolerance for the antinociceptive effects of nicotine. These results strongly suggest that calcium-mediated cell signaling is involved in the development of tolerance for the effects of nicotine on nociception.

The involvement of calcium in nicotine tolerance has also been demonstrated for tolerance to the anxiogenic effects of nicotine.²²¹ Swiss mice treated with daily injections of 0.04 mg/kg of nicotine for seven days showed tolerance for the anxiogenic effects of nicotine. However, in mice that received nicotine injections paired with injections of L-type, voltage-dependent, calcium channel antagonists (nimodipine, flunarizine, diltiazem, or verapamil), tolerance was blocked. Thus, while chronic nicotine treatment is associated with receptor level changes and the development of tolerance, changes in intracellular calcium cell signaling may also be critically involved in such tolerance development.

In summary, studies of the neural and cellular substrates of tolerance in mice have identified receptor subtypes and cell-signaling molecules involved in tolerance. The $\alpha 4$ -containing and $\beta 2$ -containing nAChRs appear to be critically involved in tolerance to the effects of nicotine, although the role of $\alpha 7$ nAChRs may be less direct. In addition to nAChRs, muscarinic acetylcholinergic receptors and mu opioid receptors may also be involved in tolerance to the effects of nicotine. The cellular mechanisms involved in tolerance appear to involve calcium-mediated cell signaling because calcium channel antagonists decreased tolerance, and agonists increased tolerance.

It is important to bear in mind, however, that the functional role of tolerance to human nicotine dependence remains unclear. It is unclear that dispositional

tolerance to nicotine²²² or behavioral tolerance^{223,224} are causally determinant of nicotine reinforcement and dependence. Future research should address the extent to which the different types of tolerance are related to core features of dependence, such as a pervasive pattern of drug use. Further understanding of the neural and genetic substrata of tolerance, and how these compare with other causal influences on dependence, may elucidate the role of tolerance in dependence development.

Additional Directions for Research on the Nicotine-Dependence Phenotype in Mice

Given the tremendous potential created by the availability of well-characterized mouse strains and both knockout and knockin preparations, there is a great need to use such tools to explore genetic influences on phenotypes that provide additional insight into the processes involved in nicotine dependence. Additional assays, both physiological and behavioral, should be used to expand understanding of the genetic contributors to the critical motivational processes of dependence.

Extended Central and Peripheral Effects of Nicotine Observed in Mice

Alteration in nAChR function may also provide insights into nicotine effects on central and peripheral components of complex behaviors. For example, the roles of $\alpha 7$ and $\alpha 4\beta 2$ receptors are implicated in nicotine-induced enhancement of cognition, including working memory, learning, and attention.²²⁵ This relation is particularly strong in rodents; the loci of this effect

appear to be the hippocampus and the amygdala.^{206,226–229} In C57BL/6 mice, acute nicotine enhanced hippocampus-dependent, but not hippocampus-independent, fear conditioning.^{207,229} This enhancement of hippocampus-dependent forms of fear conditioning by nicotine is mediated by $\alpha 4\beta 2$ nAChRs. DH β E, the high-affinity nAChR antagonist, blocked the nicotine enhancement;²³⁰ $\beta 2$ knockout mice did not show the enhancement of hippocampus-dependent fear conditioning, but $\alpha 7$ knockout mice did.^{230,231} The mechanisms that modulate fear-based learning may be relevant to nicotine dependence, given the substantial evidence that affect control is a powerful motive for smoking in humans.²³²

Glutamate receptor systems are directly involved in learning and synaptic plasticity.^{233–235} Accordingly, one mechanism through which nicotine can enhance learning and memory, in addition to modulating inhibitory tone and circuitry in regions such as the hippocampus (above), is via interaction with the glutamate system.²³⁶ For example, chronic nicotine increases the phosphorylation state of the NR2B subunit, which correlates with a long-lasting component of long-term potentiation.²³⁷ Similarly, chronic nicotine self-administration in rats corresponds with region-specific increases in NR2A mRNA expression (e.g., the auditory cortex), whereas thalamic NR2B messenger RNA (mRNA) levels decline.²³⁸ In addition, protein levels that these subunits share also increased particularly in mesocorticolimbic regions.²³⁹ Nicotine can also act on dopamine cell bodies to regulate glutamatergic inputs to these distal neurons that do not experience direct nAChR activation.^{80,142,183,240,241} Finally, nicotine modulation of activity-dependent limited proteolysis of the GluR1 C-terminus has been described.¹⁸³ Because the C-terminus of this AMPA-GluR subunit is critical to association with proteins of the synaptic spine, it is possible that nicotine increases GluR1

expression through altering trafficking of the receptor. The common feature of these studies is, however, that nicotine's effects via glutamate receptor expression (even acting via the same receptor) may be very different, or even opposite, within the same learning or memory paradigm, depending upon the anatomical location of nicotine's actions.

Nicotine influences on gene-transcription cascades could be very important and highly strain specific. Genes and their protein products do not work alone; they are part of complex metabolic cascades that impart a change in "state" to the cell, eventually resulting in a change in function or behavior in the organism. Researchers in the field are aware of examples that extend from the regulation of the classic pathways of intermediary metabolism to later discoveries of complex cascades that regulate cell functions, including the induction of gene transcription and proteolytic cascades that determine cell survival or death through apoptosis.²⁴² This also means that changing the function of just one element, possibly because of a dysfunction of a pathway external to the one being examined, can change how these cascades proceed and how they eventually influence ultimate end points or states. In mice, the administration of nicotine can lead to persistent *c-Fos* activation^{243,244} as well as to changes in fibroblast growth factor-2 mRNA,^{245,246} nerve growth factor and tyrosine kinase B in the hippocampus,²⁴⁷ and activation of CREB.⁸⁸ In tissue culture, reports indicate that nicotine increases the corticotropin-releasing factor and, as noted above, inhibits lipopolysaccharide induction of certain inflammatory cytokines (e.g., interleukin (IL)-1 and IL-8;^{150,248}) or signaling through the receptor. This latter study suggests that nicotine inhibits the nuclear factor-kappa B transcriptional system,²⁴⁹ although in other cell types, antagonism between $\alpha 7$ activity and tumor necrosis factor- α (TNF- α)-initiated, ceramide-related metabolic cascades has been reported.¹⁴⁴

Distinguishing strain-specific systems that differ in ways relevant to nicotine dependence from those that vary because of unrelated genetic differences (e.g., the original reasons many of these strains were selected, such as H2 functions) is not straightforward. Factors that also influence nicotine dependence, such as drug metabolism or absorption, increase the complexity of the problem of genetic dissection. This is particularly true in mouse strains that are particularly “sensitive” (or possibly very “insensitive”) to nicotine for which toxicity or seizure sensitivity due to particularly robust catabolism or clearance, versus compound accumulation, may mask correlations in seeking signaling cascades relevant to receptor function. The advent of microchip analysis of whole-genome quantitative transcript screening (e.g., Affymetrix) seems a likely future direction to begin the experimental dissection of the magnitude and specificity of the strain response to defined drug administration.

Aging

One measure of normal age-related decline in the CNS is the diminishment and eventual dysfunction of the limbic cholinergic system that, in its most severe form, manifests in pathologies of dementia, including Alzheimer’s disease (AD; figure 4.1). Although studies that examine the state of the cholinergic neurotransmitter receptors in aging and dementia often focus upon muscarinic receptor expression, the loss of neuronal nAChRs precedes muscarinic receptor loss and is often much more extensive in human brains afflicted with AD relative to age matched controls.^{17,250–253}

Mouse strains, like humans, exhibit a striking range in life span, ranging from two to three years in non-cancer-prone strains,²⁵⁴ and they exhibit an onset of age-related decline in nAChR expression that is strain specific.^{139,147,255} One example of this is seen in the hippocampus of aged CBA

and C57BL/6 mice. In both strains, the expression of the $\alpha 4$ nAChR is diminished with age, but this loss is much more severe in CBA than in C57BL/6 when compared with adults of the same strain.¹⁴⁷ Also observed in the hippocampal CA1 region is a significant loss of $\alpha 7$ nAChR expression by aged CBA/J but not by C57BL/6 mice. In contrast, the $\beta 4$ nAChR is preferentially diminished in C57BL/6 mice. Coincident with the loss of the $\alpha 4$ nAChR in the CBA/J strain is a significant age-related increase in nAChR staining of astrocytes,^{69,81,147} which has also been reported in cases with AD.^{256–258} These results suggest that mouse strains of different genetic backgrounds undergo dissimilar age-related changes in the expression of nAChRs.

The strain-related differences noted above have implications for how age will affect an animal’s response to various toxic assaults. For example, either nicotine or acutely administered TNF- α can be neuroprotective when applied individually, but when applied together, neuroprotection is abolished.¹⁴² In contrast, $\alpha 4$ -receptor subtypes provide neuroprotection to assault produced by the toxic amyloid beta-peptide 25-35 (Abeta 25-35).¹⁴⁴ Therefore, loss of receptors containing $\alpha 4$ would significantly increase susceptibility to age-associated assault by Abeta 25-35. At the same time, loss of $\alpha 7$ activation would enhance susceptibility to excitotoxic challenges (e.g., NMDA) such as those associated with ischemic damage or with the presence of TNF- α , including reduced apoptosis. Combining these findings suggests that in the aged brain, a CBA mouse is likely to be relatively more susceptible to Abeta toxicity, while the C57BL/6 is more susceptible to excitotoxicity. More to the point, these studies indicate that early genetic predispositions may have important impacts upon the lifelong dynamics of nAChR function, and hence, dependence processes. Research shows age-related changes in quitting success;^{259,260} it is possible that

age-related sensitivities to toxins could affect trajectories of dependence across the life span. Finally, therapeutic interventions in patients, including the use of memantine, which has been proposed to inhibit glutamate receptors and which interacts with $\alpha 7$,¹⁷⁷ could have widely differing impacts on the recipient that are consistent with the individual's genetic background.

Novel Behavioral Phenotypes

Although research with mouse models has already yielded very valuable information about the nature of nicotine dependence and its genetic substrata, progress might be enhanced by use of new phenotypic measures that could be used along with manipulations of strain differences, knockout/knockin status, agonist and antagonist administration, and other strategies designed to implicate particular physiological and genetic mechanisms. Several behavioral paradigms may assess relatively more specific, dependence-linked motivational processes than are assessed by traditional CPP or self-administration paradigms. In a sense, these would represent phenotypes similar to the intermediate and mature subphenotypes discussed in chapter 3. One such novel phenotype would be to examine the ability of nicotine to enhance either the incentive value or reinforcing value of nonpharmacological stimuli. For instance, in regard to the latter effect, Caggiula and colleagues^{261,262} have shown that nicotine enhances the execution of behavior maintained by salient nonnicotine reinforcers. Thus, nicotine appears to modulate the reinforcing value of other stimuli. This may be one reason that nicotine produces such an intransigent dependence, despite its being a relatively weak primary reinforcer.²⁶¹ Similarly, activity in mesencephalic dopamine structures could be monitored to assess how nicotine modulates the incentive value of nonpharmacological stimuli (as opposed to their reinforcing effects).²⁶³

Another potentially useful phenotype might be the increase in reward threshold for electrical brain stimulation produced by nicotine withdrawal. Research by Epping-Jordan and colleagues has shown that nicotine withdrawal elevates the magnitude of stimulation required to sustain reliable self-stimulation.²⁶⁴ Subsequent research suggests that cues associated with withdrawal may similarly decrease activity in brain reward systems via associative mechanisms.²⁶⁵ A well-defined association between cues and withdrawal may provide a sensitive index of the motivational impact of withdrawal, which appears to be an important determinant of ability to quit smoking.²³² Notably, some studies also demonstrated little impact of the $\beta 2$ -knockout mouse on behaviors related to somatic signs of withdrawal,^{162,266} indicating that these behaviors are separable from those of reinforcement and subject to dissection through additional genetic approaches. Future development and use of phenotypic assessment should reflect a triangulation of theories of human drug motivation, data on implicated genetic variants and their functions, and evidence regarding the behavioral and biological processes that are implicated in the various behavioral paradigms.

Summary

Given the tremendous potential created by the availability of well-characterized mouse strains and knockout and knockin preparations, it is vital that such tools be used to explore genetic influences on phenotypes that provide additional insight into the processes involved in nicotine dependence. The reviewed evidence shows that nAChR expression and function is customized through interplay with genetic background to ensure optimal modulation of neurotransmitter receptor functions important to survival and the specialized needs of the organism. Therefore, there is

a need to recognize that behavioral tests must be customized to the mouse, and care must be taken when findings with mice are extrapolated to other rodents or humans. Such translational validation also requires that both similarities and differences in nAChR expression and function be considered in experimental design. Finally, although the potential value of mouse models has not yet been realized, the available data show that such models can display principal behavioral and biological features of nicotine dependence. In addition, such models have already implicated particular genetic variants and biological systems in the development and expression of nicotine dependence.

Conclusions

1. Substantial differences exist between mouse strains in their response to the acute or chronic administration of nicotine. These differences implicate specific neuronal nicotinic acetylcholine receptors within a broader genetic context, which suggests a central role for these genetic variants in nicotine dependence in humans.
2. The three most common routes of administration (intravenous, subcutaneous, and oral) for nicotine in rodents vary in the degree to which they model key features of human nicotine dependence, such as the behavioral features of self-administration and the acute and chronic physiological effects of nicotine. Each administration route offers advantages and disadvantages. Intravenous self-administration permits self-administration but may entail receptor-level response artifacts due to high dosages. Subcutaneous administration allows experimenter control of dosage and withdrawal over long time periods at a cost of precluding self-administration. Oral administration via drinking water permits chronic nicotine exposure and produces evidence of dependence, but is subject to specific possible side effects, making this issue an important variable in research design.
3. While mice generally are less sensitive to nicotine than are rats, mouse models now have a strong research base for nicotine effects. Mice are amenable to genetic and pharmacological experimental manipulation. They exhibit heterogeneity in strain-specific responses to nicotine, and methods of homologous recombination permit manipulation of specific genes. Data now link specific mouse strains to genetically influenced differences in the effects of nicotine exposure that can facilitate further study of nicotinic acetylcholine receptor biology in mice.
4. Mouse models link nicotine self-administration to high-affinity nicotinic acetylcholine receptors, genetic differences, developmental factors, and other potential mechanisms of dependence. These models have, in addition, linked nicotine reward in the form of conditioned place preference with genetic strain differences and specific receptor subtypes and have linked acute and chronic nicotine tolerance with other genetic and receptor differences. The models have also linked the $\alpha 7$ and $\alpha 4\beta 2$ receptors with nicotine enhancement of working memory, learning, and attention and have shown strain-specific aging effects on nicotinic acetylcholine receptor expression.
5. Although substantial differences exist in the biology of nicotinic acetylcholine receptor expression and function between mice, other rodents, and humans, nascent research in mouse models for nicotine dependence shows considerable promise in furthering understanding of the biology and genetics of nicotine dependence.

References

1. Bedell, M. A., D. A. Largaespada, N. A. Jenkins, and N. G. Copeland. 1997. Mouse models of human disease. Part II: Recent progress and future directions. *Genes & Development* 11 (1): 11–43.
2. Wahlsten, D., A. Bachmanov, D. A. Finn, and J. C. Crabbe. 2006. Stability of inbred mouse strain differences in behavior and brain size between laboratories and across decades. *Proceedings of the National Academy of Sciences of the United States of America* 103 (44): 16364–69.
3. Bovet, D., F. Bovet-Nitti, and A. Oliverio. 1966. Effects of nicotine on avoidance conditioning of inbred strains of mice. *Psychopharmacologia* 10 (1): 1–5.
4. Marks, M. J., J. A. Stitzel, and A. C. Collins. 1989. Genetic influences on nicotine responses. *Pharmacology, Biochemistry, and Behavior* 33 (3): 667–78.
5. Marks, M. J., S. M. Campbell, E. Romm, and A. C. Collins. 1991. Genotype influences the development of tolerance to nicotine in the mouse. *Journal of Pharmacology and Experimental Therapeutics* 259 (1): 392–402.
6. Robinson, S. F., M. J. Marks, and A. C. Collins. 1996. Inbred mouse strains vary in oral self-selection of nicotine. *Psychopharmacology (Berl)* 124 (4): 332–39.
7. Crawley, J. N., J. K. Belknap, A. Collins, J. C. Crabbe, W. Frankel, N. Henderson, R. J. Hitzemann, et al. 1997. Behavioral phenotypes of inbred mouse strains: Implications and recommendations for molecular studies. *Psychopharmacology (Berl)* 132 (2): 107–24.
8. Matta, S. G., D. J. Balfour, N. L. Benowitz, R. T. Boyd, J. J. Buccafusco, A. R. Caggiula, C. R. Craig, et al. 2007. Guidelines on nicotine dose selection for in vivo research. *Psychopharmacology (Berl)* 190 (3): 269–319.
9. Albuquerque, E. X., E. F. Pereira, N. G. Castro, M. Alkondon, S. Reinhardt, H. Schroder, and A. Maelicke. 1995. Nicotinic receptor function in the mammalian central nervous system. *Annals of the New York Academy of Sciences* 757:48–72.
10. Fenster, C. P., J. H. Hicks, M. L. Beckman, P. J. Covernton, M. W. Quick, and R. A. Lester. 1999. Desensitization of nicotinic receptors in the central nervous system. *Annals of the New York Academy of Sciences* 868:620–23.
11. Dani, J. A., D. Ji, and F. M. Zhou. 2001. Synaptic plasticity and nicotine addiction. *Neuron* 31 (3): 349–52.
12. Hogg, R. C., M. Raggenbass, and D. Bertrand. 2003. Nicotinic acetylcholine receptors: From structure to brain function. *Reviews of Physiology, Biochemistry and Pharmacology* 147:1–46.
13. Schwartz, R. D., and K. J. Kellar. 1985. In vivo regulation of [3H]acetylcholine recognition sites in brain by nicotinic cholinergic drugs. *Journal of Neurochemistry* 45 (2): 427–33.
14. Marks, M. J., J. A. Stitzel, and A. C. Collins. 1985. Time course study of the effects of chronic nicotine infusion on drug response and brain receptors. *Journal of Pharmacology and Experimental Therapeutics* 235 (3): 619–28.
15. Benowitz, N. L. 1986. Clinical pharmacology of nicotine. *Annual Review of Medicine* 37:21–32.
16. Svensson, C. K. 1987. Clinical pharmacokinetics of nicotine. *Clinical Pharmacokinetics* 12 (1): 30–40.
17. Gotti, C., and F. Clementi. 2004. Neuronal nicotinic receptors: From structure to pathology. *Progress in Neurobiology* 74 (6): 363–96.
18. Unwin, N. 1998. The nicotinic acetylcholine receptor of the Torpedo electric ray. *Journal of Structural Biology* 121 (2): 181–90.
19. Pettersen, E. F., T. D. Goddard, C. C. Huang, G. S. Couch, D. M. Greenblatt, E. C. Meng, and T. E. Ferrin. 2004. UCSF Chimera—A visualization system for exploratory research and analysis. *Journal of Computer Chemistry* 25 (13): 1605–12.
20. Lukas, R. J., J. P. Changeux, N. Le Novère, E. X. Albuquerque, D. J. Balfour, D. K. Berg, D. Bertrand, et al. 1999. International Union of Pharmacology. XX. Current status of the nomenclature for nicotinic acetylcholine receptors and their subunits. *Pharmacological Reviews* 51 (2): 397–401.
21. Boulter, J., K. Evans, D. Goldman, G. Martin, D. Treco, S. Heinemann, and J. Patrick. 1986. Isolation of a cDNA clone coding for a possible neural nicotinic acetylcholine receptor alpha-subunit. *Nature* 319 (6052): 368–74.
22. Conti-Fine, B. M., D. Navaneetham, S. Lei, and A. D. Maus. 2000. Neuronal nicotinic receptors in non-neuronal cells: New

- mediators of tobacco toxicity? *European Journal of Pharmacology* 393 (1–3): 279–94.
23. Sharma, G., and S. Vijayaraghavan. 2002. Nicotinic receptor signaling in nonexcitable cells. *Journal of Neurobiology* 53 (4): 524–34.
 24. Gahring, L. C., and S. W. Rogers. 2005. Neuronal nicotinic acetylcholine receptor expression and function on nonneuronal cells. *AAPS Journal* 7 (4): E885–E894.
 25. Drisdell, R. C., and W. N. Green. 2000. Neuronal alpha-bungarotoxin receptors are alpha7 subunit homomers. *Journal of Neuroscience* 20 (1): 133–39.
 26. Elgoyhen, A. B., D. E. Vetter, E. Katz, C. V. Rothlin, S. F. Heinemann, and J. Boulter. 2001. Alpha10: A determinant of nicotinic cholinergic receptor function in mammalian vestibular and cochlear mechanosensory hair cells. *Proceedings of the National Academy of Sciences of the United States of America* 98 (6): 3501–506.
 27. Papke, R. L., J. Boulter, J. Patrick, and S. Heinemann. 1989. Single-channel currents of rat neuronal nicotinic acetylcholine receptors expressed in *Xenopus* oocytes. *Neuron* 3 (5): 589–96.
 28. Papke, R. L., and S. F. Heinemann. 1991. The role of the beta 4-subunit in determining the kinetic properties of rat neuronal nicotinic acetylcholine alpha 3-receptors. *Journal of Physiology* 440:95–112.
 29. Winzer-Serhan, U. H., and F. M. Leslie. 1997. Codistribution of nicotinic acetylcholine receptor subunit alpha3 and beta4 mRNAs during rat brain development. *Journal of Comparative Neurology* 386 (4): 540–54.
 30. Conroy, W. G., and D. K. Berg. 1998. Nicotinic receptor subtypes in the developing chick brain: Appearance of a species containing the alpha4, beta2, and alpha5 gene products. *Molecular Pharmacology* 53 (3): 392–401.
 31. Morley, B. J., and H. K. Happe. 2000. Cholinergic receptors: Dual roles in transduction and plasticity. *Hearing Research* 147 (1–2): 104–12.
 32. Harvey, S. C., F. N. Maddox, and C. W. Luetje. 1996. Multiple determinants of dihydro-beta-erythroidine sensitivity on rat neuronal nicotinic receptor alpha subunits. *Journal of Neurochemistry* 67 (5): 1953–59.
 33. Parker, M. J., A. Beck, and C. W. Luetje. 1998. Neuronal nicotinic receptor beta2 and beta4 subunits confer large differences in agonist binding affinity. *Molecular Pharmacology* 54 (6): 1132–39.
 34. Parker, M. J., S. C. Harvey, and C. W. Luetje. 2001. Determinants of agonist binding affinity on neuronal nicotinic receptor beta subunits. *Journal of Pharmacology and Experimental Therapeutics* 299 (1): 385–91.
 35. Hsiao, B., D. Dweck, and C. W. Luetje. 2001. Subunit-dependent modulation of neuronal nicotinic receptors by zinc. *Journal of Neuroscience* 21 (6): 1848–56.
 36. Mirzoiian, A., and C. W. Luetje. 2002. Modulation of neuronal nicotinic acetylcholine receptors by mercury. *Journal of Pharmacology and Experimental Therapeutics* 302 (2): 560–7.
 37. Francis, M. M., R. W. Vazquez, R. L. Papke, and R. E. Oswald. 2000. Subtype-selective inhibition of neuronal nicotinic acetylcholine receptors by cocaine is determined by the alpha4 and beta4 subunits. *Molecular Pharmacology* 58 (1): 109–19.
 38. Zachariou, V., B. J. Caldarone, A. Weathers-Lowin, T. P. George, J. D. Elsworth, R. H. Roth, J. P. Changeux, and M. R. Picciotto. 2001. Nicotine receptor inactivation decreases sensitivity to cocaine. *Neuropsychopharmacology* 24 (5): 576–89.
 39. Zhou, Y., M. E. Nelson, A. Kuryatov, C. Choi, J. Cooper, and J. Lindstrom. 2003. Human alpha4beta2 acetylcholine receptors formed from linked subunits. *Journal of Neuroscience* 23 (27): 9004–15.
 40. Tapia, L., A. Kuryatov, and J. Lindstrom. 2007. Ca²⁺ permeability of the (alpha4)₃(beta2)₂ stoichiometry greatly exceeds that of (alpha4)₂(beta2)₃ human acetylcholine receptors. *Molecular Pharmacology* 71:769–76.
 41. Bruses, J. L., N. Chauvet, and U. Rutishauser. 2001. Membrane lipid rafts are necessary for the maintenance of the (alpha)7 nicotinic acetylcholine receptor in somatic spines of ciliary neurons. *Journal of Neuroscience* 21 (2): 504–12.
 42. Oshikawa, J., Y. Toya, T. Fujita, M. Egawa, J. Kawabe, S. Umemura, and Y. Ishikawa. 2003. Nicotinic acetylcholine receptor alpha 7 regulates cAMP signal within lipid rafts. *American Journal of Physiology: Cell Physiology* 285 (3): C567–C574.
 43. Girod, R., G. Crabtree, G. Ernstrom, J. Ramirez-Latorre, D. McGehee, J. Turner, and L. Role. 1999. Heteromeric complexes

- of alpha 5 and/or alpha 7 subunits. Effects of calcium and potential role in nicotine-induced presynaptic facilitation. *Annals of the New York Academy of Sciences* 868: 578–90.
44. Wang, F., V. Gerzanich, G. B. Wells, R. Anand, X. Peng, K. Keyser, and J. Lindstrom. 1996. Assembly of human neuronal nicotinic receptor alpha5 subunits with alpha3, beta2, and beta4 subunits. *Journal of Biological Chemistry* 271 (30): 17656–65.
 45. Wang, N., A. Orr-Urtreger, J. Chapman, Y. Ergun, R. Rabinowitz, and A. D. Korczyn. 2005. Hidden function of neuronal nicotinic acetylcholine receptor beta2 subunits in ganglionic transmission: Comparison to alpha5 and beta4 subunits. *Journal of the Neurological Sciences* 228 (2): 167–77.
 46. Nelson, M. E., A. Kuryatov, C. H. Choi, Y. Zhou, and J. Lindstrom. 2003. Alternate stoichiometries of alpha4beta2 nicotinic acetylcholine receptors. *Molecular Pharmacology* 63 (2): 332–41.
 47. Gahring, L. C., E. L. Days, T. Kaasch, M. Gonzalez de Mendoza, L. Owen, K. Persiyonov, and S. W. Rogers. 2005. Pro-inflammatory cytokines modify neuronal nicotinic acetylcholine receptor assembly. *Journal of Neuroimmunology* 166 (1–2): 88–101.
 48. Verbitsky, M., C. V. Rothlin, E. Katz, and A. B. Elgoyhen. 2000. Mixed nicotinic-muscarinic properties of the alpha9 nicotinic cholinergic receptor. *Neuropharmacology* 39 (13): 2515–24.
 49. Baker, E. R., R. Zwart, E. Sher, and N. S. Millar. 2004. Pharmacological properties of alpha 9 alpha 10 nicotinic acetylcholine receptors revealed by heterologous expression of subunit chimeras. *Molecular Pharmacology* 65 (2): 453–60.
 50. Patterson, F., N. Benowitz, P. Shields, V. Kaufmann, C. Jepson, P. Wileyto, S. Kucharski, and C. Lerman. 2003. Individual differences in nicotine intake per cigarette. *Cancer Epidemiology, Biomarkers & Prevention* 12 (5): 468–71.
 51. Zwart, R., R. G. Van Kleef, and H. P. Vijverberg. 1999. Physostigmine and atropine potentiate and inhibit neuronal alpha 4 beta 4 nicotinic receptors. *Annals of the New York Academy of Sciences* 868: 636–39.
 52. Kurzen, H., H. Berger, C. Jager, W. Hartschuh, H. Naher, A. Gratchev, S. Goerdts, and M. Deichmann. 2004. Phenotypical and molecular profiling of the extraneuronal cholinergic system of the skin. *Journal of Investigative Dermatology* 123 (5): 937–49.
 53. Peng, H., R. L. Ferris, T. Matthews, H. Hiel, A. Lopez-Albaitero, and L. R. Lustig. 2004. Characterization of the human nicotinic acetylcholine receptor subunit alpha (alpha) 9 (CHRNA9) and alpha (alpha) 10 (CHRNA10) in lymphocytes. *Life Sciences* 76 (3): 263–80.
 54. Dvorakova, M., K. S. Lips, D. Bruggmann, J. Slavikova, J. Kuncova, and W. Kummer. 2005. Developmental changes in the expression of nicotinic acetylcholine receptor alpha-subunits in the rat heart. *Cell and Tissue Research* 319 (2): 201–9.
 55. Galvis, G., K. S. Lips, and W. Kummer. 2006. Expression of nicotinic acetylcholine receptors on murine alveolar macrophages. *Journal of Molecular Neuroscience* 30 (1–2): 107–108.
 56. Albuquerque, E. X., E. F. Pereira, R. Bonfante-Cabarcas, M. Marchioro, H. Matsubayashi, M. Alkondon, and A. Maelicke. 1996. Nicotinic acetylcholine receptors on hippocampal neurons: Cell compartment-specific expression and modulatory control of channel activity. *Progress in Brain Research* 109:111–24.
 57. Ji, D., and J. A. Dani. 2000. Inhibition and disinhibition of pyramidal neurons by activation of nicotinic receptors on hippocampal interneurons. *Journal of Neurophysiology* 83 (5): 2682–90.
 58. McGehee, D. S. 2002. Nicotinic receptors and hippocampal synaptic plasticity ... it's all in the timing. *Trends in Neurosciences* 25 (4): 171–72.
 59. Hasselmo, M. E., J. Hay, M. Ilyn, and A. Gorchetnikov. 2002. Neuromodulation, theta rhythm and rat spatial navigation. *Neural Networks* 15 (4–6): 689–707.
 60. Lester, H. A., C. Fonck, A. R. Tapper, S. McKinney, M. I. Damaj, S. Balogh, J. Owens, J. M. Wehner, A. C. Collins, and C. Labarca. 2003. Hypersensitive knockin mouse strains identify receptors and pathways for nicotine action. *Current Opinion in Drug Discovery & Development* 6 (5): 633–39.
 61. Siok, C. J., J. A. Rogers, B. Kocsis, and M. Hajos. 2006. Activation of alpha7 acetylcholine receptors augments stimulation-induced hippocampal theta oscillation. *European Journal of Neuroscience* 23 (2): 570–74.

62. Radcliffe, K. A., and J. A. Dani. 1998. Nicotinic stimulation produces multiple forms of increased glutamatergic synaptic transmission. *Journal of Neuroscience* 18 (18): 7075–83.
63. Levin, E. D., and A. H. Rezvani. 2002. Nicotinic treatment for cognitive dysfunction. *Current Drug Targets: CNS and Neurological Disorders* 1 (4): 423–31.
64. Alkondon, M., and E. X. Albuquerque. 2004. The nicotinic acetylcholine receptor subtypes and their function in the hippocampus and cerebral cortex. *Progress in Brain Research* 145:109–20.
65. Marks, M. J., P. Whiteaker, and A. C. Collins. 2006. Deletion of the alpha7, beta2, or beta4 nicotinic receptor subunit genes identifies highly expressed subtypes with relatively low affinity for [3H]epibatidine. *Molecular Pharmacology* 70 (3): 947–59.
66. Deneris, E. S., J. Boulter, J. Connolly, E. Wada, K. Wada, D. Goldman, L. W. Swanson, J. Patrick, and S. Heinemann. 1989. Genes encoding neuronal nicotinic acetylcholine receptors. *Clinical Chemistry* 35 (5): 731–37.
67. Wada, E., K. Wada, J. Boulter, E. Deneris, S. Heinemann, J. Patrick, and L. W. Swanson. 1989. Distribution of alpha 2, alpha 3, alpha 4, and beta 2 neuronal nicotinic receptor subunit mRNAs in the central nervous system: A hybridization histochemical study in the rat. *Journal of Comparative Neurology* 284 (2): 314–35.
68. Gotti, C., M. Zoli, and F. Clementi. 2006. Brain nicotinic acetylcholine receptors: Native subtypes and their relevance. *Trends in Pharmacological Sciences* 27 (9): 482–91.
69. Gahring, L. C., K. Persiyonov, D. Dunn, R. Weiss, E. L. Meyer, and S. W. Rogers. 2004. Mouse strain-specific nicotinic acetylcholine receptor expression by inhibitory interneurons and astrocytes in the dorsal hippocampus. *Journal of Comparative Neurology* 468 (3): 334–46.
70. Flores, C. M., S. W. Rogers, L. A. Pabreza, B. B. Wolfe, and K. J. Kellar. 1992. A subtype of nicotinic cholinergic receptor in rat brain is composed of alpha 4 and beta 2 subunits and is up-regulated by chronic nicotine treatment. *Molecular Pharmacology* 41 (1): 31–37.
71. Duvoisin, R. M., E. S. Deneris, J. Patrick, and S. Heinemann. 1989. The functional diversity of the neuronal nicotinic acetylcholine receptors is increased by a novel subunit: Beta 4. *Neuron* 3 (4): 487–96.
72. Boulter, J., A. O'Shea-Greenfield, R. M. Duvoisin, J. G. Connolly, E. Wada, A. Jensen, P. D. Gardner, et al. 1990. Alpha 3, alpha 5, and beta 4: Three members of the rat neuronal nicotinic acetylcholine receptor-related gene family form a gene cluster. *Journal of Biological Chemistry* 265 (8): 4472–82.
73. Wang, N., A. Orr-Urtreger, and A. D. Korczyk. 2002. The role of neuronal nicotinic acetylcholine receptor subunits in autonomic ganglia: Lessons from knockout mice. *Progress in Neurobiology* 68 (5): 341–60.
74. Dineley-Miller, K., and J. Patrick. 1992. Gene transcripts for the nicotinic acetylcholine receptor subunit, beta4, are distributed in multiple areas of the rat central nervous system. *Brain Research: Molecular Brain Research* 16 (3–4): 339–44.
75. Sudweeks, S. N., and J. L. Yakel. 2000. Functional and molecular characterization of neuronal nicotinic ACh receptors in rat CA1 hippocampal neurons. *Journal of Physiology* 527 Pt. 3: 515–28.
76. Azam, L., U. H. Winzer-Serhan, Y. Chen, and F. M. Leslie. 2002. Expression of neuronal nicotinic acetylcholine receptor subunit mRNAs within midbrain dopamine neurons. *Journal of Comparative Neurology* 444 (3): 260–74.
77. Quik, M., and J. M. Kulak. 2002. Nicotine and nicotinic receptors; relevance to Parkinson's disease. *Neurotoxicology* 23 (4–5): 581–94.
78. Gahring, L. C., K. Persiyonov, and S. W. Rogers. 2004. Neuronal and astrocyte expression of nicotinic receptor subunit beta4 in the adult mouse brain. *Journal of Comparative Neurology* 468 (3): 322–33.
79. Alkondon, M., and E. X. Albuquerque. 2002. A non-alpha7 nicotinic acetylcholine receptor modulates excitatory input to hippocampal CA1 interneurons. *Journal of Neurophysiology* 87 (3): 1651–54.
80. Mansvelder, H. D., and D. S. McGehee. 2002. Cellular and synaptic mechanisms of nicotine addiction. *Journal of Neurobiology* 53 (4): 606–17.
81. Gahring, L. C., K. Persiyonov, E. L. Days, and S. W. Rogers. 2005. Age-related loss of neuronal nicotinic receptor expression in the aging mouse hippocampus corresponds with cyclooxygenase-2 and PPAR gamma expression and is altered by long-term NS398 administration. *Journal of Neurobiology* 62 (4): 453–68.

82. Guidetti, P., G. E. Hoffman, M. Melendez-Ferro, E. X. Albuquerque, and R. Schwarcz. 2007. Astrocytic localization of kynurenine aminotransferase II in the rat brain visualized by immunocytochemistry. *Glia* 55 (1): 78–92.
83. Balfour, D. J. 2002. Neuroplasticity within the mesoaccumbens dopamine system and its role in tobacco dependence. *Current Drug Targets: CNS and Neurological Disorders* 1 (4): 413–21.
84. Benwell, M. E., and D. J. Balfour. 1992. The effects of acute and repeated nicotine treatment on nucleus accumbens dopamine and locomotor activity. *British Journal of Pharmacology* 105 (4): 849–56.
85. Iyaniwura, T. T., A. E. Wright, and D. J. Balfour. 2001. Evidence that mesoaccumbens dopamine and locomotor responses to nicotine in the rat are influenced by pretreatment dose and strain. *Psychopharmacology (Berl)* 158 (1): 73–79.
86. Nisell, M., G. G. Nomikos, and T. H. Svensson. 1994. Systemic nicotine-induced dopamine release in the rat nucleus accumbens is regulated by nicotinic receptors in the ventral tegmental area. *Synapse* 16 (1): 36–44.
87. Abdrakhmanova, G., L. Cleemann, J. Lindstrom, and M. Morad. 2004. Differential modulation of beta2 and beta4 subunits of human neuronal nicotinic acetylcholine receptors by acidification. *Molecular Pharmacology* 66 (2): 347–55.
88. Brunzell, D. H., D. S. Russell, and M. R. Picciotto. 2003. In vivo nicotine treatment regulates mesocorticolimbic CREB and ERK signaling in C57Bl/6J mice. *Journal of Neurochemistry* 84 (6): 1431–41.
89. Shimohama, S., A. Akaike, and J. Kimura. 1996. Nicotine-induced protection against glutamate cytotoxicity. Nicotinic cholinergic receptor-mediated inhibition of nitric oxide formation. *Annals of the New York Academy of Sciences* 777:356–61.
90. Toborek, M., R. Garrido, A. Malecki, S. Kaiser, M. P. Mattson, B. Hennig, and B. Young. 2000. Nicotine attenuates arachidonic acid-induced overexpression of nitric oxide synthase in cultured spinal cord neurons. *Experimental Neurology* 161 (2): 609–20.
91. Benwell, M. E., D. J. Balfour, and J. M. Anderson. 1988. Evidence that tobacco smoking increases the density of (-)-[3H] nicotine binding sites in human brain. *Journal of Neurochemistry* 50 (4): 1243–47.
92. Perry, D. C., M. I. Davila-Garcia, C. A. Stockmeier, and K. J. Kellar. 1999. Increased nicotinic receptors in brains from smokers: Membrane binding and autoradiography studies. *Journal of Pharmacology and Experimental Therapeutics* 289 (3): 1545–52.
93. Kassiou, M., S. Eberl, S. R. Meikle, A. Birrell, C. Constable, M. J. Fulham, D. F. Wong, and J. L. Musachio. 2001. In vivo imaging of nicotinic receptor upregulation following chronic (-)-nicotine treatment in baboon using SPECT. *Nuclear Medicine and Biology* 28 (2): 165–75.
94. Staley, J. K., S. Krishnan-Sarin, K. P. Cosgrove, E. Krantzler, E. Frohlich, E. Perry, J. A. Dubin, et al. 2006. Human tobacco smokers in early abstinence have higher levels of beta2* nicotinic acetylcholine receptors than nonsmokers. *Journal of Neuroscience* 26 (34): 8707–14.
95. Xiao, Y., and K. J. Kellar. 2004. The comparative pharmacology and up-regulation of rat neuronal nicotinic receptor subtype binding sites stably expressed in transfected mammalian cells. *Journal of Pharmacology and Experimental Therapeutics* 310 (1): 98–107.
96. Picciotto, M. R., M. Zoli, and J. P. Changeux. 1999. Use of knock-out mice to determine the molecular basis for the actions of nicotine. *Nicotine & Tobacco Research* 1 Suppl. 2: S121–S125; discussion S139–S140.
97. McCallum, S. E., A. C. Collins, R. Paylor, and M. J. Marks. 2006. Deletion of the beta 2 nicotinic acetylcholine receptor subunit alters development of tolerance to nicotine and eliminates receptor upregulation. *Psychopharmacology (Berl)* 184 (3–4): 314–27.
98. Picciotto, M. R., B. J. Caldarone, D. H. Brunzell, V. Zachariou, T. R. Stevens, and S. L. King. 2001. Neuronal nicotinic acetylcholine receptor subunit knockout mice: Physiological and behavioral phenotypes and possible clinical implications. *Pharmacology & Therapeutics* 92 (2–3): 89–108.
99. Mao, D., R. P. Yasuda, H. Fan, B. B. Wolfe, and K. J. Kellar. 2006. Heterogeneity of nicotinic cholinergic receptors in rat superior cervical and nodose Ganglia. *Molecular Pharmacology* 70 (5): 1693–99.
100. Peng, X., V. Gerzanich, R. Anand, P. J. Whiting, and J. Lindstrom. 1994. Nicotine-induced increase in neuronal

- nicotinic receptors results from a decrease in the rate of receptor turnover. *Molecular Pharmacology* 46 (3): 523–30.
101. Kuryatov, A., J. Luo, J. Cooper, and J. Lindstrom. 2005. Nicotine acts as a pharmacological chaperone to up-regulate human alpha4beta2 acetylcholine receptors. *Molecular Pharmacology* 68 (6): 1839–51.
 102. Parker, S. L., Y. Fu, K. McAllen, J. Luo, J. M. McIntosh, J. M. Lindstrom, and B. M. Sharp. 2004. Up-regulation of brain nicotinic acetylcholine receptors in the rat during long-term self-administration of nicotine: Disproportionate increase of the alpha6 subunit. *Molecular Pharmacology* 65 (3): 611–22.
 103. Corringer, P. J., J. Sallette, and J. P. Changeux. 2006. Nicotine enhances intracellular nicotinic receptor maturation: A novel mechanism of neural plasticity? *Journal de Physiologie (Paris)* 99 (2–3): 162–71.
 104. Ren, X. Q., S. B. Cheng, M. W. Treuil, J. Mukherjee, J. Rao, K. H. Braunewell, J. M. Lindstrom, and R. Anand. 2005. Structural determinants of alpha4beta2 nicotinic acetylcholine receptor trafficking. *Journal of Neuroscience* 25 (28): 6676–86.
 105. Vallejo, Y. F., B. Buisson, D. Bertrand, and W. N. Green. 2005. Chronic nicotine exposure upregulates nicotinic receptors by a novel mechanism. *Journal of Neuroscience* 25 (23): 5563–72.
 106. Tumkosit, P., A. Kuryatov, J. Luo, and J. Lindstrom. 2006. Beta3 subunits promote expression and nicotine-induced up-regulation of human nicotinic alpha6* nicotinic acetylcholine receptors expressed in transfected cell lines. *Molecular Pharmacology* 70 (4): 1358–68.
 107. Lai, A., N. Parameswaran, M. Khwaja, P. Whiteaker, J. M. Lindstrom, H. Fan, J. M. McIntosh, S. R. Grady, and M. Quik. 2005. Long-term nicotine treatment decreases striatal alpha 6* nicotinic acetylcholine receptor sites and function in mice. *Molecular Pharmacology* 67 (5): 1639–47.
 108. Mugnaini, M., M. Garzotti, I. Sartori, M. Pilla, P. Repeto, C. A. Heidbreder, and M. Tessari. 2006. Selective down-regulation of [(125)I]Y0-alpha-copotoxin MII binding in rat mesostriatal dopamine pathway following continuous infusion of nicotine. *Neuroscience* 137 (2): 565–72.
 109. U.S. Department of Health and Human Services. 1988. *The health consequences of smoking: Nicotine addiction. A report of the Surgeon General* (DHHS publication no. [CDC] 88-8406). Atlanta: U.S. Department of Health and Human Services, Public Health Service, Centers for Disease Control, National Center for Chronic Disease Prevention and Health Promotion, Office on Smoking and Health. <http://profiles.nlm.nih.gov/NN/B/B/Z/D>.
 110. Brewer, B. G., A. M. Roberts, and P. P. Rowell. 2004. Short-term distribution of nicotine in the rat lung. *Drug and Alcohol Dependence* 75 (2): 193–98.
 111. Aicher, A., C. Heeschen, M. Mohaupt, J. P. Cooke, A. M. Zeiher, and S. Dimmeler. 2003. Nicotine strongly activates dendritic cell-mediated adaptive immunity: Potential role for progression of atherosclerotic lesions. *Circulation* 107 (4): 604–11.
 112. Kubota, Y., S. Takahashi, and H. Sato. 2004. Significant contamination of superoxide dismutases and catalases with lipopolysaccharide-like substances. *Toxicology In Vitro* 18 (5): 711–18.
 113. Nerurkar, S. S., P. J. McDevitt, G. F. Scott, K. O. Johanson, R. N. Willette, and T. L. Yue. 2005. Lipopolysaccharide (LPS) contamination plays the real role in C-reactive protein-induced IL-6 secretion from human endothelial cells in vitro. *Arteriosclerosis, Thrombosis, and Vascular Biology* 25 (9): e136.
 114. Curtin, J. J., N. P. Barnett, S. M. Colby, D. J. Rohsenow, and P. M. Monti. 2005. Cue reactivity in adolescents: measurement of separate approach and avoidance reactions. *Journal of Studies on Alcohol* 66 (3): 332–43.
 115. Tiffany, S. T. 1990. A cognitive model of drug urges and drug-use behavior: Role of automatic and nonautomatic processes. *Psychological Review* 97 (2): 147–68.
 116. Corrigan, W. A., and K. M. Coen. 1989. Nicotine maintains robust self-administration in rats on a limited-access schedule. *Psychopharmacology (Berl)* 99 (4): 473–78.
 117. Ostrowski, J., J. E. Sims, C. H. Sibley, M. A. Valentine, S. K. Dower, K. E. Meier, and K. Bomszyk. 1991. A serine/threonine kinase activity is closely associated with a 65-kDa phosphoprotein specifically recognized by the kappa B enhancer element. *Journal of Biological Chemistry* 266 (19): 12722–33.
 118. Donny, E. C., A. R. Caggiola, S. Knopf, and C. Brown. 1995. Nicotine self-administration in rats. *Psychopharmacology (Berl)* 122 (4): 390–94.

119. Walensky, L. D., S. Blackshaw, D. Liao, C. C. Watkins, H. U. Weier, M. Parra, R. L. Haganir, J. G. Conboy, N. Mohandas, and S. H. Snyder. 1999. A novel neuron-enriched homolog of the erythrocyte membrane cytoskeletal protein 4.1. *Journal of Neuroscience* 19 (15): 6457–67.
120. DeNoble, V. J., and P. C. Mele. 2006. Intravenous nicotine self-administration in rats: Effects of mecamylamine, hexamethonium and naloxone. *Psychopharmacology (Berl)* 184 (3–4): 266–72.
121. Harvey, D. M., S. Yasar, S. J. Heishman, L. V. Panlilio, J. E. Henningfield, and S. R. Goldberg. 2004. Nicotine serves as an effective reinforcer of intravenous drug-taking behavior in human cigarette smokers. *Psychopharmacology (Berl)* 175 (2): 134–42.
122. Carlson, J., B. Armstrong, R. C. Switzer 3rd, and G. Ellison. 2000. Selective neurotoxic effects of nicotine on axons in fasciculus retroflexus further support evidence that this a weak link in brain across multiple drugs of abuse. *Neuropharmacology* 39 (13): 2792–98.
123. Carlson, J., K. Noguchi, and G. Ellison. 2001. Nicotine produces selective degeneration in the medial habenula and fasciculus retroflexus. *Brain Research* 906 (1–2): 127–34.
124. Ciani, E., S. Severi, R. Bartesaghi, and A. Contestabile. 2005. Neurochemical correlates of nicotine neurotoxicity on rat habenulo-interpeduncular cholinergic neurons. *Neurotoxicology* 26 (3): 467–74.
125. Fung, Y. K., and Y. S. Lau. 1991. Differential effects of chronic nicotine administration on dopaminergic receptor binding sites in rat nigrostriatal and mesolimbic regions. *General Pharmacology* 22 (1): 117–19.
126. Fung, Y. K., and Y. S. Lau. 1992. Chronic effects of nicotine on mesolimbic dopaminergic system in rats. *Pharmacology, Biochemistry, and Behavior* 41 (1): 57–63.
127. Benwell, M. E., D. J. Balfour, and C. E. Birrell. 1995. Desensitization of the nicotine-induced mesolimbic dopamine responses during constant infusion with nicotine. *British Journal of Pharmacology* 114 (2): 454–60.
128. Perkins, K. A., L. H. Epstein, and J. R. Jennings. 1991. Smoking as a cue for subjective and behavioral responses to a stressor. *Journal of Substance Abuse* 3 (1): 29–38.
129. Perkins, K. A., L. H. Epstein, J. Grobe, and C. Fonte. 1994. Tobacco abstinence, smoking cues, and the reinforcing value of smoking. *Pharmacology, Biochemistry, and Behavior* 47 (1): 107–12.
130. Donny, E. C., A. R. Caggiula, C. Rose, K. S. Jacobs, M. M. Mielke, and A. F. Sved. 2000. Differential effects of response-contingent and response-independent nicotine in rats. *European Journal of Pharmacology* 402 (3): 231–40.
131. Perkins, K. A., E. Donny, and A. R. Caggiula. 1999. Sex differences in nicotine effects and self-administration: Review of human and animal evidence. *Nicotine & Tobacco Research* 1 (4): 301–15.
132. Robinson, J. D., P. M. Cinciripini, S. T. Tiffany, B. L. Carter, C. Y. Lam, and D. W. Wetter. 2007. Gender differences in affective response to acute nicotine administration and deprivation. *Addictive Behaviors* 32 (3): 543–61.
133. Shiffman, S., S. G. Ferguson, and C. J. Gwaltney. 2006. Immediate hedonic response to smoking lapses: Relationship to smoking relapse, and effects of nicotine replacement therapy. *Psychopharmacology (Berl)* 184 (3–4): 608–18.
134. Russell, M. A., and C. Feyerabend. 1978. Cigarette smoking: A dependence on high-nicotine boli. *Drug Metabolism Reviews* 8 (1): 29–57.
135. Petersen, D. R., K. J. Norris, and J. A. Thompson. 1984. A comparative study of the disposition of nicotine and its metabolites in three inbred strains of mice. *Drug Metabolism and Disposition* 12 (6): 725–31.
136. Miller, R. P., K. S. Rotenberg, and J. Adir. 1977. Effect of dose on the pharmacokinetics of intravenous nicotine in the rat. *Drug Metabolism and Disposition* 5 (5): 436–43.
137. Benowitz, N. L., P. Jacob 3rd, R. T. Jones, and J. Rosenberg. 1982. Interindividual variability in the metabolism and cardiovascular effects of nicotine in man. *Journal of Pharmacology and Experimental Therapeutics* 221 (2): 368–72.
138. Bergstrom, J. 2004. Tobacco smoking and chronic destructive periodontal disease. *Odontology* 92 (1): 1–8.
139. Rogers, S. W., L. C. Gahring, A. C. Collins, and M. Marks. 1998. Age-related changes in neuronal nicotinic acetylcholine receptor subunit alpha4 expression are modified by long-term nicotine administration. *Journal of Neuroscience* 18 (13): 4825–32.

140. Sparks, J. A., and J. R. Pauly. 1999. Effects of continuous oral nicotine administration on brain nicotinic receptors and responsiveness to nicotine in C57Bl/6 mice. *Psychopharmacology (Berl)* 141 (2): 145–53.
141. Akaike, A., Y. Tamura, T. Yokota, S. Shimohama, and J. Kimura. 1994. Nicotine-induced protection of cultured cortical neurons against N-methyl-D-aspartate receptor-mediated glutamate cytotoxicity. *Brain Research* 644 (2): 181–87.
142. Carlson, N. G., A. Bacchi, S. W. Rogers, and L. C. Gahring. 1998. Nicotine blocks TNF- α -mediated neuroprotection to NMDA by an alpha-bungarotoxin-sensitive pathway. *Journal of Neurobiology* 35 (1): 29–36.
143. Buccafusco, J. J., and A. V. Terry Jr. 2003. The potential role of cotinine in the cognitive and neuroprotective actions of nicotine. *Life Sciences* 72 (26): 2931–42.
144. Gahring, L. C., E. L. Meyer, and S. W. Rogers. 2003. Nicotine-induced neuroprotection against N-methyl-D-aspartic acid or beta-amyloid peptide occur through independent mechanisms distinguished by pro-inflammatory cytokines. *Journal of Neurochemistry* 87 (5): 1125–36.
145. Pauly, J. R., C. M. Charriez, M. V. Guseva, and S. W. Scheff. 2004. Nicotinic receptor modulation for neuroprotection and enhancement of functional recovery following brain injury or disease. *Annals of the New York Academy of Sciences* 1035: 316–34.
146. Grabus, S. D., B. R. Martin, A. M. Batman, R. F. Tyndale, E. Sellers, and M. I. Damaj. 2005. Nicotine physical dependence and tolerance in the mouse following chronic oral administration. *Psychopharmacology (Berl)* 178 (2–3): 183–92.
147. Gahring, L. C., K. Persyanov, and S. W. Rogers. 2005. Mouse strain-specific changes in nicotinic receptor expression with age. *Neurobiology of Aging* 26 (6): 973–80.
148. Cannon, D. S., T. B. Baker, M. E. Piper, M. B. Scholand, D. L. Lawrence, D. T. Drayna, W. M. McMahon, et al. 2005. Associations between phenylthiocarbamide gene polymorphisms and cigarette smoking. *Nicotine & Tobacco Research* 7 (6): 853–58.
149. Terry Jr., A. V., C. M. Hernandez, E. J. Hohnadel, K. P. Bouchard, and J. J. Buccafusco. 2005. Cotinine, a neuroactive metabolite of nicotine: Potential for treating disorders of impaired cognition. *CNS Drug Reviews* 11 (3): 229–52.
150. Pavlov, V. A., H. Wang, C. J. Czura, S. G. Friedman, and K. J. Tracey. 2003. The cholinergic anti-inflammatory pathway: A missing link in neuroimmunomodulation. *Molecular Medicine* 9 (5–8): 125–34.
151. Crawley, J. N. 2000. *What's wrong with my mouse?: Behavioral phenotyping of transgenic and knockout mice*. New York: John Wiley & Sons.
152. Jackson Laboratory. Mouse genome informatics. <http://www.informatics.jax.org> (accessed August 8, 2007).
153. Eppig, J. T., C. J. Bult, J. A. Kadin, J. E. Richardson, J. A. Blake, A. Anagnostopoulos, R. M. Baldarelli, et al. 2005. The Mouse Genome Database (MGD): From genes to mice—a community resource for mouse biology. *Nucleic Acids Research* 33:D471–D475.
154. Gahring, L. C., H. S. White, S. L. Skradski, N. G. Carlson, and S. W. Rogers. 1997. Interleukin-1 α in the brain is induced by audiogenic seizure. *Neurobiology of Disease* 3 (4): 263–69.
155. Hof, P. R., W. G. Young, F. E. Bloom, P. V. Belichenko, and M. R. Celio. 2000. *Comparative cytoarchitectonic atlas of the C57BL/6 and 129/Sv mouse brains*. New York: Elsevier.
156. Wahlsten, D. 1982. Genes with incomplete penetrance and the analysis of brain development. In *Genetics of the Brain*, ed. I. Liebllich, 267–391. New York: Elsevier Biomedical Press.
157. Rasmussen, T., and M. D. Swedberg. 1998. Reinforcing effects of nicotinic compounds: Intravenous self-administration in drug-naive mice. *Pharmacology, Biochemistry, and Behavior* 60 (2): 567–73.
158. Picciotto, M. R., M. Zoli, V. Zachariou, and J. P. Changeux. 1997. Contribution of nicotinic acetylcholine receptors containing the beta 2-subunit to the behavioural effects of nicotine. *Biochemical Society Transactions* 25 (3): 824–29.
159. Epping-Jordan, M. P., M. R. Picciotto, J. P. Changeux, and E. M. Pich. 1999. Assessment of nicotinic acetylcholine receptor subunit contributions to nicotine self-administration in mutant mice. *Psychopharmacology (Berl)* 147 (1): 25–26.
160. Self, D. W. 2004. Regulation of drug-taking and -seeking behaviors by neuroadaptations in the mesolimbic dopamine system. *Neuropharmacology* 47 Suppl. 1: 242–55.

161. Corrigan, W. A., K. M. Coen, and K. L. Adamson. 1994. Self-administered nicotine activates the mesolimbic dopamine system through the ventral tegmental area. *Brain Research* 653 (1–2): 278–84.
162. Besson, M., V. David, S. Suarez, A. Cormier, P. Cazala, J. P. Changeux, and S. Granon. 2006. Genetic dissociation of two behaviors associated with nicotine addiction: Beta-2 containing nicotinic receptors are involved in nicotine reinforcement but not in withdrawal syndrome. *Psychopharmacology (Berl)* 187 (2): 189–99.
163. Maskos, U., B. E. Molles, S. Pons, M. Besson, B. P. Guiard, J. P. Guilloux, A. Evrard, et al. 2005. Nicotine reinforcement and cognition restored by targeted expression of nicotinic receptors. *Nature* 436 (7047): 103–7.
164. Charpantier, E., P. Barneoud, P. Moser, F. Besnard, and F. Sgard. 1998. Nicotinic acetylcholine subunit mRNA expression in dopaminergic neurons of the rat substantia nigra and ventral tegmental area. *Neuroreport* 9 (13): 3097–3101.
165. Champtiaux, N., Z. Y. Han, A. Bessis, F. M. Rossi, M. Zoli, L. Marubio, J. M. McIntosh, and J. P. Changeux. 2002. Distribution and pharmacology of alpha 6-containing nicotinic acetylcholine receptors analyzed with mutant mice. *Journal of Neuroscience* 22 (4): 1208–17.
166. Zoli, M., M. Moretti, A. Zanardi, J. M. McIntosh, F. Clementi, and C. Gotti. 2002. Identification of the nicotinic receptor subtypes expressed on dopaminergic terminals in the rat striatum. *Journal of Neuroscience* 22 (20): 8785–89.
167. Quik, M., and J. M. McIntosh. 2006. Striatal alpha6* nicotinic acetylcholine receptors: Potential targets for Parkinson's disease therapy. *Journal of Pharmacology and Experimental Therapeutics* 316 (2): 481–89.
168. Meliska, C. J., A. Bartke, G. McGlacken, and R. A. Jensen. 1995. Ethanol, nicotine, amphetamine, and aspartame consumption and preferences in C57BL/6 and DBA/2 mice. *Pharmacology, Biochemistry, and Behavior* 50 (4): 619–26.
169. Aschhoff, S., K.-C. Schrott, D. B. Wildenauer, and E. Richter. 2000. Nicotine consumption of several mouse strains using a two bottle choice paradigm. *Journal of Experimental Animal Science* 40 (4): 171–77.
170. Adriani, W., S. Macri, R. Pacifici, and G. Laviola. 2002. Peculiar vulnerability to nicotine oral self-administration in mice during early adolescence. *Neuropsychopharmacology* 27 (2): 212–14.
171. Siu, E. C., and R. F. Tyndale. 2007. Non-nicotinic therapies for smoking cessation. *Annual Review of Pharmacology and Toxicology* 47:541–64.
172. DiFranza, J. R., R. J. Wellman, J. D. Sargent, M. Weitzman, B. J. Hipple, and J. P. Winickoff. 2006. Tobacco promotion and the initiation of tobacco use: Assessing the evidence for causality. *Pediatrics* 117 (6): e1237–e1248.
173. Klein, L. C., M. M. Stine, D. J. Vandenberg, C. A. Whetzel, and H. M. Kamens. 2004. Sex differences in voluntary oral nicotine consumption by adolescent mice: A dose-response experiment. *Pharmacology, Biochemistry, and Behavior* 78 (1): 13–25.
174. Abreu-Villaca, Y., F. E. Queiroz-Gomes, A. P. Dal Monte, C. C. Filgueiras, and A. C. Manhaes. 2006. Individual differences in novelty-seeking behavior but not in anxiety response to a new environment can predict nicotine consumption in adolescent C57BL/6 mice. *Behavioural Brain Research* 167 (1): 175–82.
175. Sorger, S. B., Y. Paterson, P. J. Fink, and S. M. Hedrick. 1990. T cell receptor junctional regions and the MHC molecule affect the recognition of antigenic peptides by T cell clones. *Journal of Immunology* 144 (3): 1127–35.
176. Blokhina, E. A., V. A. Kashkin, E. E. Zvartau, W. Danysz, and A. Y. Bespalov. 2005. Effects of nicotinic and NMDA receptor channel blockers on intravenous cocaine and nicotine self-administration in mice. *European Neuropsychopharmacology* 15 (2): 219–25.
177. Aracava, Y., E. F. Pereira, A. Maelicke, and E. X. Albuquerque. 2005. Memantine blocks alpha7* nicotinic acetylcholine receptors more potently than n-methyl-D-aspartate receptors in rat hippocampal neurons. *Journal of Pharmacology and Experimental Therapeutics* 312 (3): 1195–1205.
178. Tapper, A. R., S. L. McKinney, R. Nashmi, J. Schwarz, P. Deshpande, C. Labarca, P. Whiteaker, M. J. Marks, A. C. Collins, and H. A. Lester. 2004. Nicotine activation of alpha4* receptors: Sufficient for reward, tolerance, and sensitization. *Science* 306 (5698): 1029–32.
179. McGehee, D. S., M. J. Heath, S. Gelber, P. Devay, and L. W. Role. 1995. Nicotine enhancement of fast excitatory synaptic transmission in CNS by presynaptic receptors. *Science* 269 (5231): 1692–96.

180. Broide, R. S., and F. M. Leslie. 1999. The alpha7 nicotinic acetylcholine receptor in neuronal plasticity. *Molecular Neurobiology* 20 (1): 1–16.
181. Girod, R., N. Barazangi, D. McGehee, and L. W. Role. 2000. Facilitation of glutamatergic neurotransmission by presynaptic nicotinic acetylcholine receptors. *Neuropharmacology* 39 (13): 2715–25.
182. Snyder, E. M., Y. Nong, C. G. Almeida, S. Paul, T. Moran, E. Y. Choi, A. C. Nairn, et al. 2005. Regulation of NMDA receptor trafficking by amyloid-beta. *Nature Neuroscience* 8 (8): 1051–58.
183. Meyer, E. L., L. C. Gahring, and S. W. Rogers. 2002. Nicotine preconditioning antagonizes activity-dependent caspase proteolysis of a glutamate receptor. *Journal of Biological Chemistry* 277 (13): 10869–75.
184. Fattore, L., G. Cossu, M. C. Martellotta, and W. Fratta. 2002. Baclofen antagonizes intravenous self-administration of nicotine in mice and rats. *Alcohol and Alcoholism* 37 (5): 495–98.
185. Martellotta, M. C., A. Kuzmin, E. Zvartau, G. Cossu, G. L. Gessa, and W. Fratta. 1995. Isradipine inhibits nicotine intravenous self-administration in drug-naive mice. *Pharmacology, Biochemistry, and Behavior* 52 (2): 271–74.
186. Fudala, P. J., and E. T. Iwamoto. 1986. Further studies on nicotine-induced conditioned place preference in the rat. *Pharmacology, Biochemistry, and Behavior* 25 (5): 1041–49.
187. Risinger, F. O., and R. A. Oakes. 1995. Nicotine-induced conditioned place preference and conditioned place aversion in mice. *Pharmacology, Biochemistry, and Behavior* 51 (2–3): 457–61.
188. Grabus, S. D., B. R. Martin, S. E. Brown, and M. I. Damaj. 2006. Nicotine place preference in the mouse: Influences of prior handling, dose and strain and attenuation by nicotinic receptor antagonists. *Psychopharmacology (Berl)* 184 (3–4): 456–63.
189. Schechter, M. D., S. M. Meehan, and J. B. Schechter. 1995. Genetic selection for nicotine activity in mice correlates with conditioned place preference. *European Journal of Pharmacology* 279 (1): 59–64.
190. Walters, C. L., S. Brown, J. P. Changeux, B. Martin, and M. I. Damaj. 2006. The beta2 but not alpha7 subunit of the nicotinic acetylcholine receptor is required for nicotine-conditioned place preference in mice. *Psychopharmacology (Berl)* 184 (3–4): 339–44.
191. Castane, A., G. Soria, C. Ledent, R. Maldonado, and O. Valverde. 2006. Attenuation of nicotine-induced rewarding effects in A_{2A} knockout mice. *Neuropharmacology* 51 (3): 631–40.
192. Berrendero, F., V. Mendizabal, P. Robledo, L. Galeote, A. Bilkei-Gorzo, A. Zimmer, and R. Maldonado. 2005. Nicotine-induced antinociception, rewarding effects, and physical dependence are decreased in mice lacking the preproenkephalin gene. *Journal of Neuroscience* 25 (5): 1103–12.
193. Zarrindast, M. R., N. Faraji, P. Rostami, H. Sahraei, and H. Ghoshouni. 2003. Cross-tolerance between morphine- and nicotine-induced conditioned place preference in mice. *Pharmacology, Biochemistry, and Behavior* 74 (2): 363–69.
194. Berrendero, F., B. L. Kieffer, and R. Maldonado. 2002. Attenuation of nicotine-induced antinociception, rewarding effects, and dependence in mu-opioid receptor knock-out mice. *Journal of Neuroscience* 22 (24): 10935–40.
195. Silva, A. J., J. H. Kogan, P. W. Frankland, and S. Kida. 1998. CREB and memory. *Annual Review of Neuroscience* 21:127–48.
196. Nestler, E. J. 2004. Molecular mechanisms of drug addiction. *Neuropharmacology* 47 Suppl. 1: 24–32.
197. Zhu, H., M. Lee, S. Agatsuma, and N. Hiroi. 2007. Pleiotropic impact of constitutive fosB inactivation on nicotine-induced behavioral alterations and stress-related traits in mice. *Human Molecular Genetics* 16 (7): 820–36.
198. Hawkins, R. D., H. Son, and O. Arancio. 1998. Nitric oxide as a retrograde messenger during long-term potentiation in hippocampus. *Progress in Brain Research* 118:155–72.
199. Medina, L., K. D. Anderson, E. J. Karle, and A. Reiner. 1995. An ultrastructural double-label immunohistochemical study of the enkephalinergic input to dopaminergic neurons of the substantia nigra in pigeons. *Journal of Comparative Neurology* 357 (3): 408–32.
200. Vleeming, W., B. Rambali, and A. Opperhuizen. 2002. The role of nitric oxide in cigarette smoking and nicotine addiction. *Nicotine & Tobacco Research* 4 (3): 341–48.

201. Martin, J. L., and Y. Itzhak. 2000. 7-Nitroindazole blocks nicotine-induced conditioned place preference but not LiCl-induced conditioned place aversion. *Neuroreport* 11 (5): 947–49.
202. Sahraei, H., M. Falahi, M. R. Zarrindast, M. Sabetkasaei, H. Ghoshooni, and M. Khalili. 2004. The effects of nitric oxide on the acquisition and expression of nicotine-induced conditioned place preference in mice. *European Journal of Pharmacology* 503 (1–3): 81–87.
203. Damaj, M. I., S. P. Welch, and B. R. Martin. 1996. Characterization and modulation of acute tolerance to nicotine in mice. *Journal of Pharmacology and Experimental Therapeutics* 277 (1): 454–61.
204. Miner, L. L., and A. C. Collins. 1988. Effect of nicotine pretreatment on nicotine-induced seizures. *Pharmacology, Biochemistry, and Behavior* 29 (2): 375–80.
205. Semenova, S., A. Bespalov, and A. Markou. 2003. Decreased prepulse inhibition during nicotine withdrawal in DBA/2J mice is reversed by nicotine self-administration. *European Journal of Pharmacology* 472 (1–2): 99–110.
206. Gould, T. J., and J. M. Wehner. 1999. Nicotine enhancement of contextual fear conditioning. *Behavioural Brain Research* 102 (1–2): 31–3.
207. Gould, T. J., and J. Stephen Higgins. 2003. Nicotine enhances contextual fear conditioning in C57BL/6J mice at 1 and 7 days post-training. *Neurobiology of Learning and Memory* 80 (2): 147–57.
208. Gould, T. J. 2006. Nicotine and hippocampus-dependent learning: Implications for addiction. *Molecular Neurobiology* 34 (2): 93–107.
209. Davis, J. A., J. R. James, S. J. Siegel, and T. J. Gould. 2005. Withdrawal from chronic nicotine administration impairs contextual fear conditioning in C57BL/6 mice. *Journal of Neuroscience* 25 (38): 8708–713.
210. Benowitz, N. L., H. Porchet, and P. Jacob 3rd. 1989. Nicotine dependence and tolerance in man: Pharmacokinetic and pharmacodynamic investigations. *Progress in Brain Research* 79:279–87.
211. Henningfield, J. E., and R. M. Keenan. 1993. Nicotine delivery kinetics and abuse liability. *Journal of Consulting and Clinical Psychology* 61 (5): 743–50.
212. Baker, T. B., and S. T. Tiffany. 1985. Morphine tolerance as habituation. *Psychological Review* 92 (1): 78–108.
213. Cepeda-Benito, A., K. W. Davis, J. T. Reynoso, and J. H. Harraid. 2005. Associative and behavioral tolerance to the analgesic effects of nicotine in rats: Tail-flick and paw-lick assays. *Psychopharmacology (Berl)* 180 (2): 224–33.
214. Hatchell, P. C., and A. C. Collins. 1977. Influences of genotype and sex on behavioral tolerance to nicotine in mice. *Pharmacology, Biochemistry, and Behavior* 6 (1): 25–30.
215. Marks, M. J., J. A. Stitzel, and A. C. Collins. 1986. Dose-response analysis of nicotine tolerance and receptor changes in two inbred mouse strains. *Journal of Pharmacology and Experimental Therapeutics* 239 (2): 358–64.
216. Naylor, C., D. Quarta, C. Fernandes, and I. P. Stolerman. 2005. Tolerance to nicotine in mice lacking alpha7 nicotinic receptors. *Psychopharmacology (Berl)* 180 (3): 558–63.
217. Marks, M. J., and A. C. Collins. 1985. Tolerance, cross-tolerance, and receptors after chronic nicotine or oxotremorine. *Pharmacology, Biochemistry, and Behavior* 22 (2): 283–91.
218. Galeote, L., B. L. Kieffer, R. Maldonado, and F. Berrendero. 2006. Mu-opioid receptors are involved in the tolerance to nicotine antinociception. *Journal of Neurochemistry* 97 (2): 416–23.
219. Damaj, M. I. 1997. Altered behavioral sensitivity of Ca(2+)-modulating drugs after chronic nicotine administration in mice. *European Journal of Pharmacology* 322 (2–3): 129–35.
220. Damaj, M. I. 2005. Calcium-acting drugs modulate expression and development of chronic tolerance to nicotine-induced antinociception in mice. *Journal of Pharmacology and Experimental Therapeutics* 315 (2): 959–64.
221. Biala, G., and B. Budzynska. 2006. Effects of acute and chronic nicotine on elevated plus maze in mice: Involvement of calcium channels. *Life Sciences* 79 (1): 81–88.
222. Benowitz, N. L., O. F. Pomerleau, C. S. Pomerleau, and P. Jacob 3rd. 2003. Nicotine metabolite ratio as a predictor of cigarette consumption. *Nicotine & Tobacco Research* 5 (5): 621–24.
223. Perkins, K. A. 2002. Chronic tolerance to nicotine in humans and its relationship to

- tobacco dependence. *Nicotine & Tobacco Research* 4 (4): 405–22.
224. Perkins, K. A., M. Broge, D. Gerlach, M. Sanders, J. E. Grobe, C. Cherry, and A. S. Wilson. 2002. Acute nicotine reinforcement, but not chronic tolerance, predicts withdrawal and relapse after quitting smoking. *Health Psychology* 21 (4): 332–39.
 225. Levin, E. D., F. J. McClernon, and A. H. Rezvani. 2006. Nicotinic effects on cognitive function: Behavioral characterization, pharmacological specification, and anatomic localization. *Psychopharmacology (Berl)* 184 (3–4): 523–39.
 226. Bettany, J. H., and E. D. Levin. 2001. Ventral hippocampal alpha 7 nicotinic receptor blockade and chronic nicotine effects on memory performance in the radial-arm maze. *Pharmacology, Biochemistry, and Behavior* 70 (4): 467–74.
 227. Levin, E. D. 2002. Nicotinic receptor subtypes and cognitive function. *Journal of Neurobiology* 53 (4): 633–40.
 228. Addy, N. A., A. Nakijama, and E. D. Levin. 2003. Nicotinic mechanisms of memory: Effects of acute local DHbetaE and MLA infusions in the basolateral amygdala. *Brain Research Cognitive Brain Research* 16 (1): 51–57.
 229. Gould, T. J., O. Feiro, and D. Moore. 2004. Nicotine enhances trace cued fear conditioning but not delay cued fear conditioning in C57BL/6 mice. *Behavioural Brain Research* 155 (1): 167–73.
 230. Davis, J. A., and T. J. Gould. 2006. The effects of DHBE and MLA on nicotine-induced enhancement of contextual fear conditioning in C57BL/6 mice. *Psychopharmacology (Berl)* 184 (3–4): 345–52.
 231. Wehner, J. M., J. J. Keller, A. B. Keller, M. R. Picciotto, R. Paylor, T. K. Booker, A. Beaudet, S. F. Heinemann, and S. A. Balogh. 2004. Role of neuronal nicotinic receptors in the effects of nicotine and ethanol on contextual fear conditioning. *Neuroscience* 129 (1): 11–24.
 232. Baker, T. B., M. E. Piper, D. E. McCarthy, M. R. Majeskie, and M. C. Fiore. 2004. Addiction motivation reformulated: An affective processing model of negative reinforcement. *Psychological Review* 111 (1): 33–51.
 233. Fanselow, M. S., and J. J. Kim. 1994. Acquisition of contextual Pavlovian fear conditioning is blocked by application of an NMDA receptor antagonist D,L-2-amino-5-phosphonovaleric acid to the basolateral amygdala. *Behavioral Neuroscience* 108 (1): 210–12.
 234. Fanselow, M. S., J. J. Kim, J. Yipp, and B. De Oca. 1994. Differential effects of the N-methyl-D-aspartate antagonist DL-2-amino-5-phosphonovalerate on acquisition of fear of auditory and contextual cues. *Behavioral Neuroscience* 108 (2): 235–40.
 235. Lisman, J. 2003. Long-term potentiation: Outstanding questions and attempted synthesis. *Philosophical Transactions of the Royal Society of London: Series B, Biological Sciences* 358 (1432): 829–42.
 236. Gould, T. J., and M. C. Lewis. 2005. Coantagonism of glutamate receptors and nicotinic acetylcholinergic receptors disrupts fear conditioning and latent inhibition of fear conditioning. *Learning & Memory* 12 (4): 389–98.
 237. Yamazaki, Y., Y. Jia, R. Niu, and K. Sumikawa. 2006. Nicotine exposure in vivo induces long-lasting enhancement of NMDA receptor-mediated currents in the hippocampus. *European Journal of Neuroscience* 23 (7): 1819–28.
 238. Hsieh, C. Y., F. M. Leslie, and R. Metherate. 2002. Nicotine exposure during a postnatal critical period alters NR2A and NR2B mRNA expression in rat auditory forebrain. *Brain Research: Developmental Brain Research* 133 (1): 19–25.
 239. Wang, F., H. Chen, J. D. Steketeer, and B. M. Sharp. 2007. Upregulation of ionotropic glutamate receptor subunits within specific mesocorticolimbic regions during chronic nicotine self-administration. *Neuropsychopharmacology* 32 (1): 103–9.
 240. Prendergast, M. A., B. R. Harris, S. Mayer, R. C. Holley, J. R. Pauly, and J. M. Littleton. 2001. Nicotine exposure reduces N-methyl-D-aspartate toxicity in the hippocampus: Relation to distribution of the alpha7 nicotinic acetylcholine receptor subunit. *Medical Science Monitor* 7 (6): 1153–60.
 241. Dajas-Bailador, F. A., P. A. Lima, and S. Wonnacott. 2000. The alpha7 nicotinic acetylcholine receptor subtype mediates nicotine protection against NMDA excitotoxicity in primary hippocampal cultures through a Ca(2+) dependent mechanism. *Neuropharmacology* 39 (13): 2799–2807.
 242. Salvesen, G. S. 2002. Caspases and apoptosis. *Essays in Biochemistry* 38:9–19.

243. Merlo Pich, E., C. Chiamulera, and L. Carboni. 1999. Molecular mechanisms of the positive reinforcing effect of nicotine. *Behavioural Pharmacology* 10 (6–7): 587–96.
244. Marttila, K., H. Raattamaa, and L. Ahtee. 2006. Effects of chronic nicotine administration and its withdrawal on striatal FosB/DeltaFosB and c-Fos expression in rats and mice. *Neuropharmacology* 51 (1): 44–51.
245. Belluardo, N., G. Mudo, G. Caniglia, Q. Cheng, M. Blum, and K. Fuxe. 1999. The nicotinic acetylcholine receptor agonist ABT-594 increases FGF-2 expression in various rat brain regions. *Neuroreport* 10 (18): 3909–13.
246. Mousa, S., and S. A. Mousa. 2006. Cellular and molecular mechanisms of nicotine's pro-angiogenesis activity and its potential impact on cancer. *Journal of Cellular Biochemistry* 97 (6): 1370–78.
247. Rattray, M. 2001. Is there nicotinic modulation of nerve growth factor? Implications for cholinergic therapies in Alzheimer's disease. *Biological Psychiatry* 49 (3): 185–93.
248. Wendell, K. J., and S. H. Stein. 2001. Regulation of cytokine production in human gingival fibroblasts following treatment with nicotine and lipopolysaccharide. *Journal of Periodontology* 72 (8): 1038–44.
249. Wang, H., H. Liao, M. Ochani, M. Justiniani, X. Lin, L. Yang, Y. Al-Abed, et al. 2004. Cholinergic agonists inhibit HMGB1 release and improve survival in experimental sepsis. *Nature Medicine* 10 (11): 1216–21.
250. Kellar, K. J., P. J. Whitehouse, A. M. Martino-Barrows, K. Marcus, and D. L. Price. 1987. Muscarinic and nicotinic cholinergic binding sites in Alzheimer's disease cerebral cortex. *Brain Research* 436 (1): 62–68.
251. Schulz, D. W., G. A. Kuchel, and R. E. Zigmond. 1993. Decline in response to nicotine in aged rat striatum: Correlation with a decrease in a subpopulation of nicotinic receptors. *Journal of Neurochemistry* 61 (6): 2225–32.
252. Perry, E., C. Martin-Ruiz, M. Lee, M. Griffiths, M. Johnson, M. Piggott, V. Haroutunian, et al. 2000. Nicotinic receptor subtypes in human brain ageing, Alzheimer and Lewy body diseases. *European Journal of Pharmacology* 393 (1–3): 215–22.
253. Picciotto, M. R., and M. Zoli. 2002. Nicotinic receptors in aging and dementia. *Journal of Neurobiology* 53 (4): 641–55.
254. Goodrick, C. L. 1975. Life-span and the inheritance of longevity of inbred mice. *Journal of Gerontology* 30 (3): 257–63.
255. Zhang, X., G. Wahlstrom, and A. Nordberg. 1990. Influence of development and aging on nicotinic receptor subtypes in rodent brain. *International Journal of Developmental Neuroscience* 8 (6): 715–21.
256. Amenta, F., E. Bronzetti, M. Sabbatini, and J. A. Vega. 1998. Astrocyte changes in aging cerebral cortex and hippocampus: A quantitative immunohistochemical study. *Microscopy Research and Technique* 43 (1): 29–33.
257. Teaktong, T., A. Graham, J. Court, R. Perry, E. Jaros, M. Johnson, R. Hall, and E. Perry. 2003. Alzheimer's disease is associated with a selective increase in alpha7 nicotinic acetylcholine receptor immunoreactivity in astrocytes. *Glia* 41 (2): 207–11.
258. Yu, W. F., Z. Z. Guan, N. Bogdanovic, and A. Nordberg. 2005. High selective expression of alpha7 nicotinic receptors on astrocytes in the brains of patients with sporadic Alzheimer's disease and patients carrying Swedish APP 670/671 mutation: A possible association with neuritic plaques. *Experimental Neurology* 192 (1): 215–25.
259. Mody, R. R., and M. J. Smith. 2006. Smoking status and health-related quality of life: As findings from the 2001 Behavioral Risk Factor Surveillance System data. *American Journal of Health Promotion* 20 (4): 251–58.
260. Nollen, N. L., M. S. Mayo, L. Sanderson Cox, K. S. Okuyemi, W. S. Choi, H. Kaur, and J. S. Ahluwalia. 2006. Predictors of quitting among African American light smokers enrolled in a randomized, placebo-controlled trial. *Journal of General Internal Medicine* 21 (6): 590–95.
261. Chaudhri, N., A. R. Caggiula, E. C. Donny, M. I. Palmatier, X. Liu, and A. F. Sved. 2006. Complex interactions between nicotine and nonpharmacological stimuli reveal multiple roles for nicotine in reinforcement. *Psychopharmacology (Berl)* 184 (3–4): 353–66.
262. Palmatier, M. I., F. F. Evans-Martin, A. Hoffman, A. R. Caggiula, N. Chaudhri, E. C. Donny, X. Liu, et al. 2006. Dissociating the primary reinforcing and reinforcement-enhancing effects of nicotine using a rat self-administration paradigm with concurrently available drug and environmental reinforcers. *Psychopharmacology (Berl)* 184 (3–4): 391–400.

263. Robinson, T. E., and K. C. Berridge. 1993. The neural basis of drug craving: An incentive-sensitization theory of addiction. *Brain Research: Brain Research Reviews* 18 (3): 247–91.
264. Epping-Jordan, M. P., S. S. Watkins, G. F. Koob, and A. Markou. 1998. Dramatic decreases in brain reward function during nicotine withdrawal. *Nature* 393 (6680): 76–9.
265. Kenny, P. J., and A. Markou. 2005. Conditioned nicotine withdrawal profoundly decreases the activity of brain reward systems. *Journal of Neuroscience* 25 (26): 6208–12.
266. Salas, R., F. Pieri, and M. De Biasi. 2004. Decreased signs of nicotine withdrawal in mice null for the beta4 nicotinic acetylcholine receptor subunit. *Journal of Neuroscience* 24 (45): 10035–39.

Developmental Trajectories of Tobacco Use and Their Relation to Tobacco Dependence

Given the variation of smoking behavior patterns within the population, as well as their potential for being classified as heritable traits, patterns of smoking behavior over time hold promise as a future basis for genetic studies of nicotine dependence. This part examines issues in the study of trajectories of tobacco use, ranging from the results of existing studies to their relationship with other trajectories, such as alcohol use or substance abuse.

The first chapter in this part examines the literature exploring developmental trajectories of cigarette smoking between adolescence and adulthood, together with results from a population study examining these trajectories. A subsequent chapter explores genetic modeling issues in the study of smoking trajectories and behavior, including methodological and conceptual issues, statistical modeling considerations, prior genetic studies, and research applying an item-response theory (IRT) approach to an analysis of smoking trajectories. The closing chapter of this part uses an empirical example from a cohort study to explore whether these trajectories should be considered unique to tobacco or are best conceptualized as general pathways underlying substance use.

5

Developmental Trajectories of Cigarette Smoking from Adolescence to Adulthood

Laurie Chassin, Patrick J. Curran, Clark C. Presson,
Steven J. Sherman, and R. J. Wirth

Patterns of smoking behavior over time exhibit substantial variation, and these patterns, in turn, hold the potential to inform possible phenotypes of tobacco use and dependence. This chapter examines the literature concerning developmental trajectories of cigarette smoking between adolescence and adulthood. It also presents an empirical example that examines these trajectories by using data from the Indiana University Smoking Survey. Specific areas discussed include

- *Past studies describing smoking trajectories and their antecedents and correlates*
- *Empirically identified trajectories of smoking from adolescence to adulthood*
- *Statistical approaches for potentially identifying unique trajectory classes from empirical data*
- *Results from a dynamic cluster analysis of tobacco use trajectories from the ages of 10 to 42 years in a sample initially recruited from a midwestern school system*

The data discussed in this chapter provide a framework for a three-chapter section in this monograph exploring aspects of cigarette smoking trajectories and their potential to inform further genetic research. In particular, these data point to several key areas for further study, linking these trajectories of smoking behavior to possible dynamic or developmental phenotypes of nicotine dependence.

The analyses described herein were supported by National Institute of Health grant DA013555. The authors thank Jon Macy and the families of the Indiana University Smoking Survey for their assistance in data collection and Denise Kruszewski for assistance with literature reviews.

Introduction

In attempting to identify phenotypes of cigarette smoking, is it potentially informative to consider heterogeneity in trajectories of smoking from adolescence to adulthood? Moreover, could these developmental patterns be useful for genetic analyses of smoking behavior? This chapter considers developmental trajectories of cigarette smoking as part of a broader section within this monograph (chapters 5–7) that examines tobacco use trajectories and their role in informing an understanding of phenotypes of smoking behavior. This chapter reviews the literature on trajectories of cigarette smoking from adolescence to adulthood, raises methodological issues, and provides an empirical example of these trajectories in relation to aspects of adult smoking phenotypes.

A central premise of this monograph is that the adult smoking phenotype used in the field of behavioral genetics is a crude and heterogeneous phenotype that is not ideal for genetic study (or for studies of etiological mechanisms more broadly). Efforts to refine this phenotype include distinguishing among adult smokers on features such as amount smoked, the presence or absence of particular dependence symptoms, failed cessation, maximum length of abstinence, and other factors, as well as on the basis of candidate endophenotypes (chapters 8 and 9). However, developmental considerations about the initiation, acquisition, and course of cigarette smoking from adolescence to adulthood may also contribute to an understanding of smoking phenotypes. For example, different stages of the smoking acquisition process (e.g., initial onset versus progression) differ in their heritability,^{1,2} suggesting that different points along smoking trajectories may be influenced by different etiological

factors (see chapter 3). Moreover, other features of developmental trajectories of smoking—including age of onset, speed of acceleration in smoking rate, variability versus persistence in smoking over time, and trajectories of associated use of other substances (e.g., alcohol, marijuana)—may all be useful in defining more homogeneous phenotypes for genetic analysis.^{3,4}

These research questions require data about adolescent origins to inform the identification of smoking phenotypes in adulthood. However, the need to understand adult outcomes is not the only reason for an interest in the adolescent origins of smoking trajectories. For example, an understanding of heterogeneity in adolescent smoking phenotypes is itself important for understanding the etiology of adolescent smoking and for the development of preventive intervention targeted at adolescent age groups. Thus, for multiple reasons, it is useful to examine developmental aspects of smoking trajectories from their initial onset through adulthood to identify multiple pathways and the mechanisms underlying these pathways.

Because this is a chapter on trajectories of smoking behavior, and not tobacco dependence, it is also important to note questions that this chapter will not address. It does not cover theoretical issues in the conceptualization of dependence. This discussion is provided in chapter 3. It does not discuss the issues that are raised in modeling genetically informative samples; these are covered in chapter 6. Finally, trajectories of cigarette smoking do not occur in isolation but are associated with other forms of substance use. A consideration of smoking trajectories in combination with other substance use is provided in chapter 7, along with an empirical example of smoking and alcohol-use trajectories.

A Developmental Psychopathology Perspective: Studying Multiple Trajectories over Time

Although a comprehensive treatment of a developmental psychopathology perspective is beyond the scope of this chapter, it is important to embed the study of smoking trajectories within this broader conceptual and empirical context. Developmental psychopathology has been defined as the study of “the origins and course of individual patterns of behavioral maladaptation.”^{5(p18)} This definition places maladaptive behavior within the context of normal development, as well as in relation to the interplay between an individual’s internal and external contexts in which neurobiological development and psychosocial experience are proposed to influence each other in reciprocal fashion.⁶

A developmental psychopathology perspective recognizes that different influences may determine the initiation of behavior as opposed to the maintenance of that behavior (as also hypothesized by stage models of cigarette smoking—for example, Mayhew and colleagues⁷—and the “watershed” model in chapter 3). Moreover, from this perspective, it is hypothesized that multiple, differing etiological pathways may lead ultimately to the same outcome (*equifinality*). In addition, it is hypothesized that any given risk factor may produce a range of diverse outcomes (*multifinality*).⁸

A developmental psychopathology perspective thus leads to the study of multiple trajectories of behavior over time so as to be able to identify and explain these diverse patterns of development. Such pathways are probabilistic in nature, rather

than reified “groups,” and it is possible for an individual to change trajectories in response to some change in risk and protective factors. Methods used to study multiple trajectories include both traditional variable-centered approaches (in which predictor variables are related to some outcome) and person-centered approaches (in which relatively homogeneous subgroups are identified and studied).

For the purposes of this monograph, an important question is whether thinking about multiple developmental pathways or trajectories of smoking over the life span can be useful for refining phenotypes of smoking to be used in genetic research. In other words, does it make sense to consider dynamic or developmental phenotypes of smoking? As noted by Pickles and Hill,⁹ the notion of “pathways” or trajectories is not only a rich metaphor but also one that raises many questions and challenges (including whether such pathways are actually empirically identifiable). For more information, the reader is referred to extended discussions in Pickles and Hill.⁹ Other references include Gottlieb and Willoughby¹⁰ for a study considering the comorbidity of attention deficit hyperactivity disorder (ADHD) and smoking and Bergman and colleagues¹¹ for an extended discussion of person-centered research methods.

Adolescent Cigarette Smoking and Tobacco Dependence

Adolescence is the developmental period during which smoking (and other substance use) is most commonly initiated. In 2005, 9.3% of 8th graders, 14.9% of 10th graders, and 23.2% of 12th graders reported smoking in the past 30 days of a survey.¹² As with most forms of substance use, smoking rises to a peak prevalence in the age period of 18–25 years,^{13,14} but unlike other forms of substance use, which decline after the mid-20s, smoking is more persistent.^{13,14}

Perhaps this is true because smoking is legal, addictive, and does not immediately impair performance.

Compared with information about the prevalence of adolescent cigarette smoking, less is known about tobacco dependence in adolescence because this has been a later focus of research attention. Two commonly used measurement methods involve modifications of the Fagerström Tolerance Questionnaire (FTQ)¹⁵ or the *Diagnostic and Statistical Manual of Mental Disorders (DSM)* criteria.¹⁶ These two approaches produce only modest concordance in classifying adolescents, except at high levels of smoking of at least 16 cigarettes per day.¹⁷

Moreover, as has been shown for other forms of substance-use disorders, some caution is warranted in applying adult dependence measures to adolescents.¹⁸ Whether or not the construct of dependence is similar for adults and adolescents, the functioning of particular items and criteria may differ. Additional research is needed on the measurement equivalence of tobacco dependence criteria over the life span (see chapter 6 for an empirical example of studying measurement equivalence over age).

Reported prevalence rates of tobacco dependence among adolescent smokers have varied widely depending on sampling, definitions of dependence, and definitions of adolescent smoking. A review by Colby and colleagues¹⁹ reports rates between 20% for a proxy *DSM* diagnosis among 12- to 17-year-olds who smoked in the past year and 68% for a diagnosis based on FTQ criteria among 13- to 17-year-olds who smoked one pack or more per day. Kandel and colleagues¹⁷ found that the majority of adolescent daily smokers met criteria for dependence (87% according to *DSM* criteria and 63% according to Fagerström criteria). In addition, there were no race/ethnicity differences in prevalence when smoking intake was controlled. Using the criteria of

the *International Statistical Classification of Diseases and Related Health Problems, Tenth Revision (ICD-10)*, O'Loughlin and colleagues²⁰ found that 65.9% of 7th grade daily smokers were dependent. Thus, the majority of adolescent daily smokers appear to show tobacco dependence.

Whether or not they meet full diagnostic criteria, adolescents commonly report individual dependence symptoms. Kandel and colleagues²¹ found that tolerance, impaired control, and withdrawal were the most common *DSM* Fourth Edition (*DSM-IV*) symptoms reported in a multiethnic sample of 6th–10th graders. Colby and colleagues¹⁹ reported that most adolescent smokers retrospectively recalled at least one withdrawal symptom, either as part of a quit attempt or during periods when they were restricted from smoking. As with adult smokers, withdrawal symptoms are common.²² Craving is the most commonly reported symptom (see also Rojas and colleagues²³). However, reports of withdrawal symptoms are influenced by expectancies.²⁴ Prokhorov and colleagues²⁵ note that withdrawal symptoms such as irritability, depression, insomnia, and trouble in concentrating can be characteristic of adolescents in general, rather than specific to tobacco withdrawal (see Hughes²² for a similar point concerning the adult epidemiological literature).

There are some data concerning the amount of time and exposure required for adolescent smokers to develop dependence. Using retrospective data from the National Comorbidity Survey, Breslau and colleagues²⁶ found that the onset of *DSM* Third Edition Revised nicotine dependence typically occurred at least one year after the onset of daily smoking. Gervais and colleagues²⁷ used a prospective study of 7th graders and reported that a 25% cumulative probability of attaining an *ICD* tobacco dependence diagnosis occurred at 41 months after the first puff of a cigarette.

In a longitudinal study of a multiethnic sample of 6th–10th graders, Kandel and colleagues²¹ found that a 25% cumulative probability of attaining *DSM-IV* nicotine dependence occurred 23 months after tobacco use onset.

In contrast to the onset of the full dependence diagnosis, there is a shorter time to the first symptom of dependence. Kandel and colleagues²¹ found that 25% of adolescent tobacco users experienced *DSM-IV* symptoms within five months of use. DiFranza and colleagues²⁸ found that among the 40% of ever-smoking adolescents who reported dependence symptoms, the median latency from monthly smoking to the onset of symptoms was 21 days for girls and 183 days for boys.

Some researchers have suggested that adolescents experience dependence symptoms not only quickly but also at very low levels of consumption.²¹ For example, O'Loughlin and colleagues²⁰ reported that, among 7th graders, 19.4% of weekly smokers met *ICD-10* dependence criteria. Dierker and colleagues²⁹ found a similar prevalence (22%) by using *DSM-IV* diagnostic criteria with college freshmen who had smoked in the past week. When considering the presence of *any* symptom (rather than the full diagnostic criteria), even higher percentages of adolescents report symptoms at low levels of consumption. For example, among a sample of adolescents who smoked in the past three months, some reported symptoms even though they had smoked only once or twice.²⁰ Similarly, in a sample of 7th graders, DiFranza and colleagues²⁸ found that the median frequency of smoking at the onset of symptoms was only two cigarettes, one day per week. These studies are noteworthy for their multiple measures and frequent assessments but also have sampling limitations in terms of somewhat low or unreported participation rates (a common problem in these kinds of studies).

Few studies have compared adolescents and adults in terms of the relation between consumption and dependence. Kandel and Chen³⁰ examined a proxy measure of *DSM* dependence in the National Household Survey on Drug Abuse data and found that adolescents met dependence criteria at lower levels of smoking intake than did adults. They concluded that adolescents are particularly vulnerable to becoming tobacco dependent. However, these differences between adolescents and adults might reflect cohort rather than age effects. In a 2001 study, Breslau and colleagues²⁶ suggest that members of more recent age cohorts who adopted smoking, despite widespread public knowledge about its negative effects, may be particularly deviant in personality and represent a subsample of the population who have a high probability of developing into committed (and dependent) smokers. Because age and cohort are confounded in these studies, it is not possible to separate these two interpretations, and both effects might be operative. Moreover, other researchers have suggested that, rather than a “hardening” of smoking, changes in tobacco control and prevention and in the social acceptability of smoking have produced a “softening” of smoking. A 2006 study indicated that in recent decades, smokers have decreased the number of cigarettes that they smoke,³¹ suggesting a substantial prevalence of light smoking. Whether or not smoking has been “hardening” or “softening” or both (i.e., becoming more bimodal), significant changes have been occurring in the United States both in tobacco control and prevention activities and in social norms about smoking. Given the powerful role of cultural and social norms, tobacco policies (e.g., taxation, youth access laws) and changes in the overall prevalence of smoking in the United States, it is important for research on adolescent smoking trajectories to consider historical and cohort effects on the findings.³²

In general, the adolescent literature suggests a relation between increased levels of consumption and the probability of tobacco dependence. However, this relation is far from perfect, and some adolescents report symptoms at low levels of smoking.²⁹ Reports of dependence symptoms at very low levels of intake may have multiple interpretations including problems of measurement (e.g., dependence symptoms being nonspecific), the possibility that tobacco dependence is a multidimensional construct (with only some dimensions related to smoking rate), and the possibility that there are heterogeneous subgroups of adolescents who are dependent on tobacco, some at quite low levels of consumption.¹⁹

In addition to these interpretations, adolescents may show dependence symptoms at low levels of intake because they are particularly sensitive (compared with adults) to developing tobacco dependence. This interpretation is consistent with data from rodent models that compare adolescent versus adult exposure to nicotine. Levin and colleagues³³ found that female rats that began self-administration in adolescence showed significantly higher levels of self-administration than those who began in adulthood. This difference in rate of self-administration lasted into adulthood. Similarly, Adriani and colleagues³⁴ found that early-adolescent mice exhibited a spontaneous drive to oral nicotine (compared to water), which was not demonstrated by middle or late adolescents. In addition, early-adolescent nicotine exposure led to significant place conditioning, which was not seen for either late-adolescent or adult exposure.

Although the mechanisms underlying these age differences are not well understood, the unique effects of adolescent exposure compared with adult exposure to nicotine self-administration may be mediated through differential sensitivity to nicotine effects. Levin and colleagues³³ found that

adolescent rats showed more hypothermia to nicotine than did adults at a given dose, although adult rats showed more activity reduction. Belluzzi and colleagues³⁵ replicated these activity reduction effects with male rats and suggested that locomotor inhibition may be an aversive effect of nicotine that is more pronounced in adults than in adolescents. However, age differences in nicotine response may be further modified by sex differences³⁶ and by exposure to nicotine in combination with alcohol.³⁷

There may also be developmental differences in nicotine withdrawal. For example, O'Dell and colleagues³⁸ found that adolescent rats showed decreased sensitivity to withdrawal after chronic nicotine administration. They also suggested that nicotine exposure in adolescence may produce maximal reinforcing effects and minimal aversive effects, thus promoting rapid acceleration of self-administration. Moreover, in rats, adolescent nicotine exposure even for a brief period (intermittent doses with twice-daily injections) at low dosage levels (producing plasma concentrations as little as 1/10 of regular smokers) has been reported to produce nicotinic acetylcholine receptor upregulation in brain regions associated with nicotine dependence. This may make the adolescent brain particularly sensitive to nicotine effects.³⁹ Taken together, these data suggest that adolescence may be a unique period of biological vulnerability, during which nicotine exposure produces particularly rapid escalation in trajectories of nicotine consumption that may persist over time as well as increased vulnerability for dependence because of differential sensitivity to nicotine effects.

Of course, significant caution is required in generalizing from animal models to human adolescents, given differences in methods of administration, dosages, and contextual factors such as restrictions on access to tobacco, the social and peer context of

self-administration, and self-selection into smoking for human adolescents. In other words, there are likely to be substantial genetic, environmental, and gene-environment correlation and interactions that affect whether human adolescents begin to smoke as well as the timing of their smoking onset. Finally, even in the rodent model, the empirical evidence concerning age differences in nicotine response is not always clear-cut. The evidence has shown variation with gender, and with the task or paradigm that is used, as well as interactions with exposure to other substances.^{36,37,40} More needs to be learned concerning the mechanisms underlying these age-dependent effects as well as their magnitude and persistence over time.

This hypothesis of age-dependent vulnerabilities to the effects of tobacco has also been proposed for other forms of substance use (see Spear and Varlinskaya⁴¹ for a review of alcohol data). Moreover, in addition to hypotheses concerning adolescent-specific vulnerabilities to substance-use effects, other models that are based in the study of neurobiological development suggest that adolescents are particularly vulnerable to risk-taking behaviors more broadly (which would include the use of tobacco and other substances). These models note that adolescents manifest a biologically driven disjunction between increased levels of novelty/sensation seeking and the lack of fully developed self-regulation mechanisms (see Steinberg⁴² for a review). These models view adolescents' special vulnerability for substance use as a function of broader developmental characteristics rather than specific substance-use effects. These alternative models do not necessarily oppose each other in terms of explaining adolescence as a particularly vulnerable period for the initiation of cigarette smoking and other substance use. However, the notion of differential vulnerability to nicotine effects further predicts that

adolescent initiation (compared with later onsets) will be more likely to be accompanied by higher consumption levels, steeper acceleration and greater persistence over time, and the development of dependence at lower levels of consumption.

Biologically based approaches offer a different (although not necessarily competing) interpretation from psychosocial models, which have also sought to explain why substance use is typically initiated in adolescence and then shows declines in adulthood. Psychosocial models often conceptualize adolescence as a high-risk period for substance-use initiation, because of adolescents' drives for independence, adult status, and peer acceptance, all of which can be seemingly facilitated by the adoption of "problem behaviors" such as cigarette smoking and other substance use.⁴³ The transition to adulthood (ages 18–25 years) has been viewed as a time of increasing diversity in trajectories (see Schulenberg and colleagues⁴⁴ for a review). During these years, the relative homogeneity and external control within the high school environment is replaced with less external structure and increased choices, including choices of entry into multiple roles (e.g., student, worker, spouse, and parent). The transition to adulthood is marked by decreased regulation by parents, which might lead to escalations in substance use, but also by increased responsibility for the performance of adult roles, which might lead to decreased substance use.⁴⁵ Thus, both psychosocial and biologically based models provide differing, but not mutually exclusive, interpretations of age-related trajectories of tobacco and other substance use.

Studies of Genetic Influences on Adolescent Smoking

Surprisingly, given the interest in genetic influences on tobacco use, few high-quality studies have focused on the family

aggregation of adolescent tobacco use.⁴⁶ In fact, even basic data on the relation between adolescent smoking and parental smoking have been conflicting, with some reviews suggesting only very weak relations between parental smoking and adolescent smoking onset.⁴⁷ However, methodological limitations prevent firm conclusions. Many studies do not directly measure parental smoking (relying instead on adolescent reports), do not differentiate biological parents from adoptive or foster parents, do not adequately define the phenotype of parental smoking (often failing to differentiate between parental nonsmoking and former smoking),⁴⁸ and do not consider possible effects of prenatal exposure (see Avenevoli and Merikangas⁴⁶ for a detailed methodological critique of this literature).

Similarly, studies have not carefully defined the phenotype of adolescent smoking. Parental smoking may be more strongly related to adolescents' smoking rate or early age of onset rather than adolescents' global smoking status. Finally, studies often dismiss the role of parental smoking if its effects are eliminated when other variables (such as peer smoking) are entered into predictive models. However, such a pattern is consistent with the mediation of parental smoking effects by peer smoking and does not by itself argue that the relation between parental smoking and adolescent smoking is an artifact or unimportant.

The literature on twin and adoption studies of adolescent substance use (including tobacco use) has been reviewed by Hoyer and colleagues,⁴⁹ who reported that both genetic and environmental influences were important. Heritability of tobacco use in their review ranged across studies from 36% to 60% and was stronger for tobacco than for alcohol or marijuana use. For example, McGue and colleagues,⁵⁰ using the Minnesota Twin Family Study (MTFS) sample, reported that approximately 50% of

the variance in smoking initiation (studied in late adolescence) was attributable to genetic influences, with no significant effects of shared environment. Han and colleagues⁵¹ studied lifetime tobacco use in the MTFS and found stronger evidence of shared environment and a pattern that was suggestive of (but not significant for) gender differences. Finally, Rhee and colleagues⁵² found (both for lifetime tobacco use and for "problem use," as defined by presence of a dependence symptom) that female adolescents showed greater heritability and weaker shared environment effects than did male adolescents. They reported that this gender difference was inconsistent with the adult literature.⁵² A later analysis of retrospective life calendar data in a sample of male twin pairs⁵³ suggests that nicotine use in adolescence shows strong family environment effects that decline in importance through young adulthood whereas genetic effects were weak in adolescence and increased with age.

As noted elsewhere in this monograph (chapters 2 and 6), heritability estimates for adolescent smoking vary depending on which adolescent smoking phenotypes are selected for study. Koopmans and colleagues⁵⁴ found stronger heritabilities for amount of smoking than for initiation. This is consistent with conclusions of other reviews (see chapter 2 and Rende and Waldman⁵⁵) that environmental influences are more important in determining adolescents' initial tobacco exposure, whereas genetic influences are more important for determining reactions to that exposure. This pattern likely reflects the heterogeneity of adolescent smoking initiation. For example, some adolescent initiation of smoking will not progress past low levels of experimentation.⁵⁶ This developmentally limited experimentation may be only weakly related to genetic influence.

This supports the use of a developmental trajectory approach to identifying

phenotypes in which developmentally limited experimentation needs to be distinguished from other forms of adolescent smoking that may start earlier, escalate steeply over time, and persist over long periods. However, exceptions to these findings should also be noted. For example, McGue and colleagues⁵⁰ found similar results when studying smoking initiation and nicotine dependence in late adolescence. Maes and colleagues,⁵⁷ when studying an adult sample, found high heritabilities and an overlapping contribution of genetic factors for tobacco initiation, persistence, and nicotine dependence.

The adolescent literature (compared with the adult literature) also shows more shared environment effects on tobacco use.⁵¹ White and colleagues,⁵⁸ in a longitudinal study using the Australian Twin Registry, found that common environmental influences were the most important factors influencing adolescent smoking, although for older adolescents and young adults, genetic factors were also important. Rende and colleagues⁵⁹ used National Longitudinal Study of Adolescent Health (Add Health) data to model current smoking, by using twins, full siblings, and half siblings, and found both significant heritability and significant shared environment effects. It is noteworthy that the authors found significant shared environment effects on high levels of smoking frequency, a more “severe” phenotype than smoking initiation.

Shared environment effects may reflect multiple influences including (but not limited to) general parenting behaviors, such as monitoring, support, and control, and parental socialization about smoking such as home smoking restrictions and smoke-free homes.⁶⁰ There have been some attempts to explain shared environment effects as due to the effects of parental smoking (which might reflect modeling mechanisms, greater access to cigarettes, greater exposure to secondhand

smoke, greater exposure to tobacco promotional advertising, and/or more permissive attitudes of parents toward their adolescents’ smoking). However, these findings are conflicting. Boomsma and colleagues⁶¹ found that the association between parental smoking and adolescent smoking was due to genetic factors. They suggested that common environmental influences might reflect parenting behaviors and family environment, rather than parental smoking. For example, common environment effects might include parents’ home smoking restrictions. However, White and colleagues⁵⁸ found that controlling for parental smoking reduced the common environmental effect. Differences between the findings of these two studies may be methodological. White and colleagues⁵⁸ used adolescent reports of parental smoking, whereas Boomsma and colleagues⁶¹ used parent reports. Interestingly, White and colleagues⁵⁸ also found that peer smoking reduced the genetic effect. They suggested that genetic influences in adolescent smoking may act indirectly by influencing adolescents’ choice of friends (although these findings weakened by late adolescence and young adulthood). These attempts to examine the relation of peer and parental smoking to the genetic and shared environment influences on adolescent smoking illustrate the importance of the gene-environment covariation in understanding the smoking acquisition process. That is, parental genotype and parental smoking likely covary with a wide variety of social environment factors including general parenting; parents’ attitudes, values, and rules about their adolescents’ smoking; adolescents’ exposure to secondhand smoke (or conversely to smoke-free homes); and even adolescents’ exposure to tobacco industry promotional items and advertising.

In addition to gene-environment covariation, there are likely to be important influences of gene-environment interactions

on adolescent smoking, although few studies have examined such interactions. Timberlake and colleagues⁶² examined the moderating effect of religiosity on smoking among late adolescents/emerging adults (aged 18–27 years) from Add Health. They found that self-rated religiousness weakened the magnitude of genetic influence on smoking initiation (defined as having smoked an entire cigarette). Similar findings have been reported for alcohol-use initiation.⁵⁴ Surprisingly, however, organized religious activity had no moderating effect. Timberlake and colleagues⁶² hypothesized that organized religious activity may reflect parental pressure, whereas self-rated religiousness might constitute a more genuine reflection of the adolescent's religious commitment. In any case, these results serve to highlight the potential importance of larger cultural and social environmental factors in moderating the magnitude of genetic effects. Given the lack of studies that test gene-environment interaction in adolescent smoking, this is an important area for future investigation.

Finally, several studies have investigated the genetic underpinnings of the association among different forms of adolescent substance use. Young and colleagues⁶³ studied a large sample of adolescents aged 12–18 years and defined the “problem” use of a substance by the presence of at least one symptom. They found that the correlation among substance-use behaviors was driven by both common genetic and common environment factors (as well as special twin environment factors) but that the more “severe” phenotypes (i.e., problem substance use as opposed to substance use) showed stronger genetic correlations. Similarly, McGue and colleagues⁶⁴ found a highly heritable factor that accounted for the association among multiple forms of disinhibitory psychopathology (including substance use) among 17-year-old twins from the MTFs. Interestingly, earlier problem behavior (retrospectively assessed)

was only weakly heritable, but the link between early problem behavior and later disinhibitory psychopathology was genetically mediated. From the perspective of developmental trajectories of smoking, these findings suggest that a trajectory of stable, persistent smoking over time might show more genetic influence than adolescent smoking does at any one given point in time.

Although the literature is quite small, there have also been a few molecular genetic studies of adolescent smoking, several of which have focused on the dopamine system. Audrain-McGovern and colleagues⁶⁵ followed 615 adolescents from 9th to 11th grade. They found no effects of *SLC6A3* (dopamine transporter genetic variants) but found that *DRD2* genetic variants were related to smoking progression. Specifically, adolescents with previous smoking experience were more likely to increase their smoking as a function of increased *DRD2*AI* alleles, and this effect was stronger for adolescents with depressive symptoms. However, there were no effects for adolescent never smokers, suggesting that different stages of smoking progression may have different determinants. The authors suggest that *DRD2* genetic variants may index greater reward value from smoking and that depressed adolescents (who lack other sources of positive experiences) may be particularly susceptible to such increased reward value.

However, as noted in chapter 2, *DRD2* has been associated with numerous addictive and affective disorders, so these effects are not specific to tobacco. Findings from an Australian longitudinal adolescent study^{66,67} reported a protective effect for the **K4* allele of the *TH* gene, which is involved in dopamine synthesis. The authors hypothesize that this protective effect may work by increasing endogenous dopamine levels or by reducing the perceived reward of nicotine. However, their findings of a

protective effect were limited to a strict definition of nicotine dependence, which included high frequency (more than six days per week), high quantity (more than 10 cigarettes per day), shorter periods of abstinence (smoking within one hour of waking), and stability (present at two waves of longitudinal measurement). These findings illustrate the potential importance of carefully defined phenotypes of smoking.

Laucht and colleagues⁶⁸ also studied the dopamine pathway and focused on the *DRD4* exon III polymorphism associated with novelty seeking. They studied a sample of 15-year-olds from the Mannheim Study of Risk Children, which followed infants who were oversampled for obstetrical and psychosocial risk. They found that the *DRD4**7-repeat allele was associated with greater smoking among males (including lifetime smoking, amount smoked, and earlier onset), but not among females. Moreover, novelty seeking mediated this relation, suggesting that novelty seeking is a potential endophenotype, at least among adolescent males. For females, however, there was an interaction between the *DRD4**7-repeat allele and the long allele of *5-HTTLPR*. Females who lacked the *DRD4**7-repeat allele and who were homozygous for the long allele of *5-HTTLPR* smoked the most.⁶⁹ This demonstrates both the potential importance of gene-gene interaction and of gender differences in the mechanisms underlying adolescent smoking. However, given the possibility of chance findings with multiple tests, these interactions require confirmation in multiple studies.

The short-short genotype of *5-HTTLPR* has also been associated with increased smoking among adolescents. Gerra and colleagues⁷⁰ found this genotype to be associated with smoking and with early onset (before 15 years of age), heavy smoking (more than 10 cigarettes per day), as well as with novelty seeking, irritability, and

underachievement. Finally, several studies focused on *CYP2A6*, which inactivates nicotine to cotinine. Studying adolescents from the longitudinal McGill University Study on the National History of Nicotine Dependence, O'Loughlin and colleagues⁷¹ defined nicotine dependence as more than three *ICD* symptoms. They found that those smokers who became dependent were more likely to have 1 or 2 copies of the inactive *CYP2A6**2 or *4 variant. In contrast, Audrain-McGovern and colleagues⁷² found that slower metabolizers (those with *CYP2A6* variants) had a significantly slower growth in tobacco dependence symptoms from grades 9 to 12. Differences in study findings may be due to many methodological differences between the studies including differing ages of measurement and definitions of dependence (categorical *ICD* diagnoses in O'Loughlin and colleagues⁷¹ and changes over time in Fagerström-type symptomatology in Audrain-McGovern and colleagues⁷²). A meta-analysis of adult studies⁷³ failed to find any relation between the *CYP2A6* genotype and smoking status or amount smoked, but the authors also noted limitations in these conclusions due to the generality and heterogeneity of these smoking phenotypes. In addition, association studies have high false-positive rates.

In general, findings from genetic studies of adolescent smoking echo the conclusions of Lessov and colleagues⁷⁴ from the adult data: although heritable factors are important, there are also important common environmental influences (particularly on smoking initiation) as well as complex interactions both among multiple genes and between genetic and environmental factors. Moreover, inconsistent findings across studies reflect multiple factors, including variation in study designs and ascertainment, and high rates of false positives, but also wide variation in smoking phenotypes that are studied. Finally, low participation rates in molecular genetic

studies can jeopardize both the internal and external validity of the conclusions (e.g., several studies^{66,71} had participation rates of 55% or less).

Developmental Trajectories

Age of Smoking Onset

To this point, age of onset has been discussed mostly as it relates to age-dependent nicotine effects in animal studies along with associated alterations in neural systems that, in turn, make it more likely that tobacco use will escalate and persist over time. These studies assign a causal role to adolescent exposure in producing steep acceleration in tobacco use. In other words, adolescence is thought to be a biological period of vulnerability during which exposure to tobacco increases risk for accelerating smoking by changing neural pathways.

However, age-dependent nicotine effects and associated changes in neural systems may not be the only reason that an early age of smoking onset is associated with acceleration and persistence. Rather, adolescents who begin tobacco use at particularly early ages may have unique characteristics, and their smoking may be maintained by different factors compared to those with late (after age 18) onset.^{13,56} Perhaps early- and late-onset smoking represent two distinct subgroups (or what are called *transitional phenotypes* in chapter 3). For defining endophenotypes and phenotypes for the genetic study of tobacco dependence, this is an alternative model of adolescent exposure in which both early use and rapid acceleration are caused by a common underlying vulnerability (potentially one or more endophenotypes).

A similar hypothesis concerning age of onset has been advanced in the developmental psychopathology literature concerning antisocial behavior⁷⁵ in which childhood-onset, life-course-persistent delinquency

is thought to be more strongly associated with inadequate parenting, neurocognitive problems, and violence. On the other hand, adolescent-onset delinquency is not characterized by these features; it is seen as more normative and more strongly linked to peer influence. Differences between childhood-onset, life-course-persistent delinquency and adolescent-onset delinquency are maintained into adulthood.⁷⁶ Moffitt's⁷⁵ developmental taxonomy of antisocial behavior illustrates the potential importance of developmental trajectories in understanding the heterogeneity that underlies adult phenotypes and when trying to create more homogeneous subgroups. Alternatively, differing ages of onset may simply reflect a continuum of severity with those having the highest levels of risk factors showing earliest entry,⁴³ or they may reflect differences in environmental opportunity and access to cigarettes. Thus, age of smoking onset is likely to have multiple determinants.

In terms of smoking trajectories, early smoking onset has been associated with steeper acceleration in smoking rate, greater persistence over time, and greater likelihood of developing dependence.^{56,77,78} Note that this association does not mean that all early onset inevitably produces heavy smoking and dependence. As described later, some subgroups of early-onset smokers show experimental or developmentally limited patterns that do not persist over time.^{56,79} Nevertheless, age of onset is related to greater risk for persistence and heavy use. Moreover, early-onset smoking has been reported to be more strongly related to parental smoking, whereas later onset (but still under 15 years of age) was related to peer (but not parental) smoking.⁸⁰ Similarly, a subgroup of smokers with early onset, steep acceleration, and persistence of heavy smoking over time also had the highest levels of smoking among biological parents.⁵⁶ These findings are consistent with reports that age of smoking onset

is heritable.^{81,82} Moreover, Broms and colleagues⁸¹ found that the same genetic influences on age of smoking onset did not account for the amount of smoking or smoking cessation, suggesting that age of onset may have distinct genetic underpinnings. Ling and colleagues⁸³ reported that a polymorphism of the dopamine transporter gene was associated with early onset of smoking and that it also magnified the relation between early onset and dependence.

Age of smoking onset has also been related to child psychopathology (see review by Upadhyaya and colleagues⁸⁴). For example, ADHD has been associated with earlier initiation of regular smoking,^{85,86} even after controlling for comorbidity.⁸⁷ A combination of conduct disorder and ADHD may be particularly predictive.⁸⁸ In contrast, anxiety disorders have been associated with delayed smoking onset,⁸⁹ although different forms of anxiety disorder may have different impacts. At least for alcohol use,⁹⁰ generalized anxiety disorder symptoms were associated with greater risk for initiation, whereas separation anxiety symptoms were associated with decreased risk.

Although some data suggest that early onset of smoking may constitute a unique phenotype in terms of showing different predictors than does late-onset smoking,^{56,80} such a conclusion is still premature. First, few studies have contrasted early- and late-onset smoking, and much of the data concerning age of onset comes from retrospective studies, which might suffer from forward telescoping bias. For example, Johnson and Schultz,⁹¹ using national interview data, found that older age at interview (within a given birth year) was less likely to produce a report of early smoking onset (see also Parra and colleagues⁹²). Second, there is no specific age of onset that has been identified as “early,” and this definition is likely to change within a social, cultural, and historical context. Third, it is

unclear whether early-onset smoking is a unique phenotype distinct from other forms of early-onset substance use. For example, Yoon and colleagues⁹³ found that multiple forms of early substance use (including but not limited to smoking before 15 years of age) were linked to reduced P300 amplitude, which itself was highly heritable. They suggest that a failure in top-down control of behavior (as manifested by reduced P300 amplitude) may be one endophenotype that accounts for genetic influences on adolescent substance use more broadly (particularly for males). Thus, an early onset of smoking may also be associated with early onset of alcohol and other drug use, and these may be markers for an endophenotype associated with the “externalizing” spectrum broadly defined, not necessarily associated uniquely with tobacco use.

Rate of Acceleration from Initiation to Regular Smoking or Dependence

Another feature of developmental trajectories that might define a smoking phenotype is the speed at which an adolescent transitions from initial onset to regular smoking or dependence, or in other words, the slope of the growth curve of tobacco use.⁹⁴ Rate of acceleration itself may be a phenotype that reflects vulnerability to dependence on the basis of reactions to initial tobacco exposure as an endophenotype.⁹⁵ Retrospective data suggest that smoking is generally reported by study participants as an aversive experience initially; however, there is variability in how participants rate the experience. Participants who reported their initial experiences as relatively more positive (e.g., who report relaxation or a “buzz”) and relatively less aversive were more likely to become smokers.^{96–98} Thus, sensitivity to the pleasurable effects of nicotine and/or insensitivity to the negative effects are potential endophenotypes that might determine the speed of smoking acquisition (see chapter 8 for a detailed review of this

literature). However, the extant data are largely confined to retrospective self-reports of unknown dose amounts. More research is needed to determine whether individual differences in sensitivity to smoking's effects predict the degree of acceleration of smoking acquisition.

Importantly, a subsequent study empirically identified heterogeneity in trajectories of dependence symptoms over 36 months among novice smokers from a multiethnic sample of 6th–10th graders.⁹⁹ Using latent growth mixture modeling, the authors found that 47% of the sample developed no dependence symptoms. In contrast, 21% developed symptoms rapidly (within the first year), averaged more than two symptoms, and showed persistent symptoms, whereas 18% developed symptoms rapidly but averaged somewhat fewer symptoms and did not persist. Finally, 14% developed symptoms more slowly. Among those who developed symptoms rapidly, those who persisted showed significantly more parental tobacco dependence than did those who remitted. Moreover, compared to those whose symptoms developed more slowly, those who rapidly developed persisting symptoms showed more pleasant initial sensitivity and more conduct disorder symptoms. These data suggest that rapid acceleration and persistence of dependence symptoms may be informative phenotypes.

Empirically Identified Trajectories of Adolescent Smoking

Although adolescence is the typical age of smoking onset, there is substantial variability in age of onset, in steepness of acceleration, and in persistence over time. As noted above, this heterogeneity may reflect different phenotypes of smoking, which may be influenced by

different underlying mechanisms and endophenotypes. Researchers have begun to empirically examine heterogeneity in the course of smoking over time in longitudinal studies. Studies are reviewed here that have examined tobacco use from early adolescence through either adolescence or adulthood (see table 5.1 for a summary of these studies). Only studies of tobacco use are in this review; studies of the joint trajectories of tobacco and alcohol or other drug use are reviewed in chapter 7.

For the youngest adolescent ages, Abroms and colleagues¹⁰⁰ examined trajectories of smoking from 6th to 9th grade by using growth mixture modeling with “stages” of smoking (ranging from no intention to smoke to smoking more than three cigarettes per month) as the outcome variable. Results showed five trajectory classes: never smokers, intenders, delayed escalators (who averaged monthly smoking by 9th grade), early experimenters, and early users (who averaged smoking three or more times per month by the end of 7th grade). Early users were an early-onset, sharply accelerating (albeit small) subgroup who surprisingly were distinguished from never smokers by decreased depression (unlike the other groups).

In another study, Vitaro and colleagues⁸⁰ distinguished among groups who started at 11, 12, and 13 years of age, and found that early onset was associated with antisocial behavior. Colder and colleagues¹⁰¹ followed a similar age group (aged 12–16 years) by using growth mixture modeling. Similar to Abroms and colleagues,¹⁰⁰ they also identified an early-onset group (with onset between 12 and 13 years of age) that rapidly escalated to heavy smoking. A later-onset (after 14 years of age) group escalated less quickly and reached lower levels of smoking by 16 years of age. The remaining three groups were light smokers. Audrain-McGovern and colleagues⁶⁵ identified a never-smoker group, an experimenter

Table 5.1 Studies of Smoking Trajectories

Authors/ Year	Age	Gender	Ethnicity	Definition of smoking	Statistical analysis	Trajectory groups	Endophenotype findings	Comments
Chassin et al. 2000 ⁹⁶	11–31 years	51% male	96% Non- Hispanic Caucasian	0 = not currently smoking 1 = up to monthly smoking 2 = up to weekly smoking 3 = weekly or more smoking, but only 10 or fewer cigarettes a day 4 = weekly or more smoking of 11–20 cigarettes per day 5 = weekly or more smoking of 20 or more cigarettes a day	Abstainer and erratic groups were defined a priori Latent class growth analysis mixture modeling	Abstainers (60%) Erratics (.02%) Early stables (12%) Late stables (16%) Quitters (5%) Experimenters (6%)	Abstainers reported lower levels of depression and lower levels of personality risk (including extraversion and conscientiousness). Early, stable group reported higher levels of depression than other groups.	
Colder et al. 2001 ¹⁰¹	12–16 years	52% female	79% Caucasian 18% African American 3% Asian Pacific/Asian Indian 0.3% Other	1 = used to smoke, but now I don't 2 = I've only tried a few puffs 3 = a few cigarettes per month or less 4 = less than a pack per week 5 = about a pack per week 6 = about one-half pack per day 7 = 1 pack per day or more	Piecewise latent growth mixture modeling	Early, rapid escalators Late, moderate escalators Late, slow escalators Stable, light escalators Stable puffers	None reported.	Percentages of sample in each trajectory group not reported.

Table 5.1 Studies of Smoking Trajectories (continued)

Authors/ Year	Age	Gender	Ethnicity	Definition of smoking	Statistical analysis	Trajectory groups	Endophenotype findings	Comments
Juon et al. 2002 ¹⁰²	6–32 years	52.2% female	99% African American	Frequency and quantity of smoking	Multiple logistic regression	Nonsmokers (37%) Former smokers (12.9%) Current smokers/late adopters (25.6%) Current smokers/early adopters (24.1%)	Current smokers/early adopters were more likely to display antisocial behaviors in 1st grade and young adulthood than did nonsmokers and the other two smoker groups. Current smokers/early adopters were more likely to report both depression and drug problems than did nonsmokers.	
Soldz and Cui 2002 ¹⁰³	6th–12th grade	55% female	79%–87% Caucasian 7%–9% African American 6%–9% Hispanic	0 = no cigarette use during the past month 1 = moderate use (≤40 cigarettes) during the past month 2 = heavy use (≥40 cigarettes) during past month	Generalized estimating equations approach	Nonsmokers (72.2%–93.5%) Light smokers (5.3%–8.9%) Heavy smokers (1.2%–20%)	Class truancy was related to smoking across grades.	
White et al. 2002 ¹⁰⁴	12–31 years	50% female	92% Caucasian	Frequency of smoking in the past year and typical quantity per day	Latent growth mixture modeling Multinomial logistic regression analyses	Nonsmokers (39.6%) Occasional smokers (19%) Heavy smokers (1.2%–20%)	Higher sensation seeking was linked with increased probability of belonging to a smoking trajectory group as well as heavier smoking over time. Delinquency and depression were not found to predict smoking group membership.	

Authors/ Year	Age	Gender	Ethnicity	Definition of smoking	Statistical analysis	Trajectory groups	Endophenotype findings	Comments
Audrain- McGovern et al. 2004 ¹⁰⁵	14–18 years	52% female	63% Caucasian 12% Hispanic 11% Asian 8% African American 6% other	0 = never smoker 1 = puffer (never having smoked a whole cigarette) 2 = experimenter (<100 cigarettes ever) 3 = current smoker (smoked <20 days in last 30 days and >100 in lifetime) 4 = frequent (smoked ≥20 days in last 30 days and >100 in lifetime)	Latent class growth modeling	Early/fast adopters (8%) Late/slow adopters (24%) Experimenters (23%) Never smokers (45%)	Adolescents higher in novelty seeking and depressive symptoms were more likely to be early/ fast adopters and late/ slow adopters than never smokers or experimenters.	

Table 5.1 Studies of Smoking Trajectories (continued)

Authors/ Year	Age	Gender	Ethnicity	Definition of smoking	Statistical analysis	Trajectory groups	Endophenotype findings	Comments
Orlando et al. 2004 ¹⁰⁶	13–23 years	52% male	67% Caucasian 10% African American 11% Hispanic 8% Asian 4% Other	0 = nonsmoker in past year 1 = <3 times in past year and <3 times in past month 2 = 3–10 times in past year and <3 times in past month 3 = 11± times in past year and <3 times in past month OR 3–5 times in past month 4 = 6± days in past month and <3 cigarettes per day 5 = 6± days in past month and about one-half pack per day 6 = 6± days in past month and about one-half pack per day 7 = 6± days in past month and 1 pack or more per day	Latent growth mixture modeling Multinomial logistic regression analyses	Non smokers (28%) Stable highs (6%) Early increasers (10%) Late increasers (10%) Decreasers (6%) Triers (40%)	At 13 and 15 years of age, nonsmokers reported fewer deviant behaviors and internalizing symptoms than did other smoking groups. At age 23, late increasers were more likely than triers and nonsmokers to have engaged in deviant behavior in the past year. Also, at 23 years of age, nonsmokers reported fewer internalizing symptoms than early increasers and late increasers.	

Authors/ Year	Age	Gender	Ethnicity	Definition of smoking	Statistical analysis	Trajectory groups	Endophenotype findings	Comments
Stanton et al. 2004 ¹⁰⁷	9–18 years	Not reported	96% Caucasian 4% Maori/ Polynesian	Count of number of cigarettes smoked in past month	Latent growth mixture modeling Multinomial logistic regression analyses	Early, rapid escalators (11.4%) Late, rapid escalators (38.8%) Late, moderate escalators (14.3%) Late, slow escalators (11.4%) Stable puffers (12.7%) Late, slow escalators- puffers (11.4%)	Attention deficit disorder predicted early, rapid escalators, as well as late, slow escalators-puffers. Conduct disorder was an early predictor of smoking. Depression and behavior problems were a predictor of midadolescent smoking.	Sample comprised only New Zealanders.
Vitaro et al. 2004 ⁸⁰	10–15 years	50.7% female	>90% Caucasian and French speaking	Number of cigarettes smoked during the week and during the day before data collection	Latent growth mixture modeling Logistic regression analyses	Never smokers (75.4%) 11–12-year-old starters (5.7%) 12–13-year-old starters (11.1%) 13–14-year-old starters (7.9%)	Membership in the 11–12- year-old starter group was associated with increased antisocial behaviors.	Antisocial behavior was analyzed as part of a composite general maladjustment score.
White et al. 2004 ¹⁰⁸	10–25 years	100% male	42% Caucasian (C) 56% African American (AA) 2% Other/ Mixed	At screening, if ever tried tobacco, even a puff, and if so, what age (age of onset) At subsequent assessments, lifetime use, past year use, and number of cigarettes smoked per day	Latent class growth modeling Hierarchical logistic regression	Nonsmokers: C: 44.3% AA: 55.9% Occasional smokers: C: 23.7% AA: 27.3% Heavy smokers: C: 32% AA: 16.7%	None reported.	Separate trajectories were examined for Caucasians and African Americans.

Table 5.1 Studies of Smoking Trajectories (continued)

Authors/ Year	Age	Gender	Ethnicity	Definition of smoking	Statistical analysis	Trajectory groups	Endophenotype findings	Comments
Abroms et al. 2005 ¹⁰⁰	6th–9th grade	Not reported	Not reported	0 = did not smoke in past 30 days or past 12 months and had no intention of smoking in high school 1 = did not smoke in past 30 days or 12 months but intended to smoke at least 1 or 2 times in high school 2 = smoked in the past 12 months but not in past 30 days 3 = smoked 1 to 2 times in the past 30 days 4 = smoked 3 or more times in the past 30 days	Latent growth mixture modeling Logistic regression to examine risk factors	Never smokers (41.2%) Intenders (33.5%) Delayed escalators (8.9%) Early experimenters (13.9%) Early users (2.5%)	Higher levels of deviance acceptance were associated with being an intender, an early experimenter, and an early user compared to a never smoker. Higher levels of depression decreased the likelihood of being an early user rather than a never smoker.	Ages not reported.
Karp et al. 2005 ¹⁰⁹	12–17 years	64.8% female	100% Canadian	For 3-month intervals, number of days smoked each month and average number of cigarettes smoked per day each month	Individual growth curve modeling Latent class growth modeling	Low initial use, gradual increase (72.4%) Low initial use, rapid increase (11.1%) Low initial use, then increase in use, then decrease in use (10.8%) High-intensity initial use, then decrease in use (5.7%)	Depression, novelty seeking, and impulsivity did not seem to predict class membership.	All participants were novice smokers on entering the study.

Authors/ Year	Age	Gender	Ethnicity	Definition of smoking	Statistical analysis	Trajectory groups	Endophenotype findings	Comments
Brook et al. 2006 ¹⁰	14–26 years	51% female	51% African American (AA) 49% Puerto Rican (PR)	1 = none 2 = a few cigarettes or less per week 3 = 1–5 cigarettes per day 4 = about one-half pack per day 5 = about 1 pack per day 6 = more than 1 pack per day	Latent growth mixture modeling	Non smokers: AA: 56% PR: 36.5% Maturing out: AA: 6.9% PR: 12.9% Late starting: AA: 19.2% PR: 18.4% Early starting: AA: 20.3% PR: 25%	None reported.	
Riggs et al. 2007 ⁸	12–24 years	44% female	84% Non- Hispanic Caucasian	Amount smoked per week	Latent class growth analysis	Abstainers (47%) Low users (24%) Late, heavy users (16%) Early, heavy users (12%)	None reported.	Late is defined as after 15 years of age.
Maggi et al. 2007 ¹¹ Maggi 2008 ¹²	10–21 years	49.3% female		Separate models for probability of trying a cigarette and smoking frequency	Latent class growth analysis	Stable nonsmokers (48.4%) Late experimenters- nonsmokers (17.2%) Experimenters-daily smokers (5.8%) Late experimenters- daily smokers (4.1%) Early experimenters- occasional smokers (10.5%) Late experimenters (13.9%)	None reported.	Late is defined as after ages 14–15 years. Sample from Canadian National Longitudinal Survey of Children and Youth.

Table 5.1 Studies of Smoking Trajectories (continued)

Authors/ Year	Age	Gender	Ethnicity	Definition of smoking	Statistical analysis	Trajectory groups	Endophenotype findings	Comments
Bernat et al. 2008 ⁹	12–19 years	49% female	85% Non- Hispanic Caucasian	Frequency of smoking (from never user to smoked most days)	Latent class growth analysis	Non smokers (55%) Triers (17%) Occasional users (10%) Early, established smokers (7%) Late, established smokers (7%) Decliners (4%)	None reported.	Community sampling using random digit dialing; 58.5% response rate.
Lessov- Schlagger et al. 2008 ¹³	13–24 years	49% female	92% Non- Hispanic Caucasian 2% Hispanic 3% Black 2% Native American	Quantity smoked in the past week	Latent class growth analysis	Experimenters (48.5%) Late increasers (16.3%) Early increasers (15.5%) Quitters (9.2%) Persistent (10.5%)	None reported.	Nonadopters excluded. Late is defined as after 18 years of age.

group, a late/slow adopter group, and a small (8%) early/fast adopter group. The two adopter groups showed elevated novelty seeking.

Wills and colleagues¹¹⁴ followed students from 6th to 10th grade. Using cluster analysis, they distinguished stable nonsmokers and experimenters from three smoking groups that varied by age of onset: early (by 6th grade), intermediate (by 9th grade), and late (by 10th grade). Looking at psychosocial risk factors, their results suggested a continuum of risk in which early, intermediate, and late onset were ordered from highest to lowest risk. Moreover, they noted that scores on the risk factors changed over time, leading to an increased risk just before smoking onset.

Thus, rather than unique phenotypes, these findings are most consistent with a continuum model of time-varying risk with smoking onset resulting from an increase in psychosocial and/or genetic risk. However, because of the short developmental span of assessment, all of the onset groups that were identified in this study might still be considered “early” in developmental terms.

Finally, Karp and colleagues¹⁰⁹ focused on only a subsample of participants who had already begun to smoke and followed them from an average age of 13 to 17 years. Because all participants were smokers, no differentiation of age of onset can be made in this study. Over this short time span, most of the participants (72%) remained at low levels of smoking. However, the other 28% escalated their smoking, divided among rapid, low, and moderate groups, with the rapidly accelerating group representing 6% of the sample. Escalating youth were more likely to show symptoms of nicotine dependence, but other predictors did not differentiate among the groups (perhaps because all of these participants were already smokers and most remained at low levels of smoking during the study).

Several studies traced trajectories to slightly older ages of 18–21 years. Stanton and colleagues¹⁰⁷ modeled monthly smoking in the Dunedin study and found six trajectory classes. Again, there was an early, rapidly escalating group, but also a later (after 13 years of age), escalating group, and both ended at 18 years of age with high levels of smoking. Note that the definition of “late” escalation was still “early” in adolescence (13 years of age), which might account for both these groups’ steep acceleration and high final smoking rates. Early, rapid escalators had higher conduct problems at 13 years of age than did all of the other groups and higher depression at 15 years of age than all but the late, moderate escalators. Early, rapid escalators also had higher attention deficit scores than the late, moderate escalators (but did not differ from the other groups).

Soldz and Cui¹⁰³ followed a large sample of students through 12th grade. Using cluster analysis, they identified nonsmokers, quitters, experimenters, early escalators, late escalators, and stable smokers. These findings are noteworthy for identifying a small quitting group that was absent in the other studies. Psychosocial protective factors (e.g., church attendance, time with fathers) were highest in nonsmokers, compared with continuous smokers, who showed an elevated risk profile. A similarly small group of decliners (4% of the sample) was identified by Bernat and colleagues⁷⁹ in a study of adolescents (aged 12–19 years). These “decliners” are intriguing because (unlike experimenter groups that are often identified) they show high levels of smoking frequency. Moreover, unlike the quitters in the Soldz and Cui study, the decliners showed elevated baseline risk profiles (compared to nonsmokers). However, the findings warrant replication because no measure of smoking quantity was considered and, unlike other studies, there was no “early stable” smoking group, so that very early onset was not present. Given the participation rate

(58.5%), perhaps the highest risk adolescents were absent from the sample. Finally, Maggi and colleagues¹¹¹ and Maggi¹¹² assessed trajectories for participants in the Canadian National Longitudinal Survey of Children and Youth. They found that a group of occasional smokers were not distinguishable from daily smokers until the age of 21 years.

Although there have been few studies, most researchers agree on the existence of a group with early onset, steep acceleration (or stably high levels of smoking from an early age), and high final levels of smoking. This group was also elevated, in general, in profiles of psychosocial risk. There was also substantial agreement about the existence of light-smoking groups, often associated with later onset. However, it is difficult to draw conclusions about a life course trajectory of smoking from studies that track the behavior only through high school. Age-related patterns of substance use more broadly (i.e., alcohol and illegal drugs) typically show adolescent initiation, peaks in emerging adulthood (ages 18–25 years), and later declines. In other words, some forms of substance use are developmentally limited and some persist.¹¹⁵ Thus, to adequately map heterogeneity in smoking trajectories requires studies that span the early years of onset to adulthood to differentiate both early versus late onset and developmentally limited versus persistent use.

Very few studies have tracked smoking over such long age periods. White and colleagues¹⁰⁴ studied adolescents who were recruited through random telephone sampling and examined a quantity-frequency measure of cigarette use. They found three groups: a heavy smoking group that showed steep acceleration and heavy smoking, an occasional smoking group that “matured out” after 18 years of age, and a nonsmoking group. Female gender was associated with maturing out, and higher disinhibition was associated with regular smoking. However, adolescent risk factors did not differentiate

the occasional and heavy groups. This lack of differentiation is likely due to the fact that the two smoking groups did not significantly differ in age of onset and because this study had a relatively small sample size for trajectory group differentiation.

Orlando and colleagues¹⁰⁶ tracked a large school-based sample from 13 to 23 years of age. They identified nonsmokers, stable high smokers, early increasers (increases between 13 and 14 years of age), late increasers (after 18 years of age), decreasers, and triers. Importantly, they found substantial onset after high school that has not often been recognized and cannot be found by studies that track participants only through high school. However, by 23 years of age, the different trajectory groups merged into two groups: low- and high-frequency smokers. An identical finding was reported by Lessov-Schlaggar and colleagues,¹¹³ who studied a smaller sample from adolescence to 24 years of age. Moreover, these authors¹¹³ found that smoking more than a few cigarettes per week in adolescence resulted in similar levels of nicotine dependence (as least as measured by the Fagerström Test for Nicotine Dependence and the Nicotine Dependence Syndrome Scale). These findings suggest that early onset is not very informative about adult smoking outcomes. In contrast, Riggs and colleagues⁷⁸ found that an early-onset-trajectory group showed more frequent weekly smoking and greater reported dependence than a later-onset-trajectory group at 24 years of age. Differences between these studies may reflect the fact that the “late” groups in the studies by Orlando and colleagues¹⁰⁶ and Lessov-Schlaggar and colleagues¹¹³ increased smoking after 18 years of age whereas the “late” group in the study by Riggs and colleagues⁷⁸ increased smoking after 15 years of age. However, the question of whether heterogeneity in adolescent age and smoking course predicts adult smoking levels and adult nicotine dependence may be difficult to resolve when participants

are followed only until the ages of 23 or 24 years. It is possible that developmentally limited smoking had not yet declined and that further divergence would occur after the age range of the mid-20s.

Chassin and colleagues⁵⁶ studied a large school-based sample of ages 11 to 31 years. They removed two a priori groups (abstainers and a small group of erratic smokers who showed periods of relapse and remission) and empirically identified four groups described here. Early, stable smokers showed middle-school onset (ages 12–13 years) and averaged daily smoking by 15 years of age. They attained a high level of smoking (averaging more than one-half pack per day by 18 years of age) and stayed stable over the study. Late-onset smokers did not transition to weekly smoking until after 18 years of age and averaged less than one-half pack per day at their peak. An experimenter group never progressed past weekly smoking, and a quitter group declined after 21 years of age (similar to other forms of substance-use behavior). The early, stable and the erratic groups showed the riskiest profile on psychosocial factors. They were the least socially conventional, and their parents and peers were most likely to smoke. Interestingly, although both the early, stable and the experimenter groups showed early smoking onset, the experimenters were less likely to have parents who smoked (perhaps reflecting the heritability of smoking persistence). The late, stable group showed low levels of early risk factors and higher levels of college attendance. Their late onset might reflect transition out of the supervision provided in the parental home as well as some college environment factors. Surprisingly, a “chipper,” or very light smoker, group did not emerge, perhaps reflecting its low prevalence in the population (or its correlation with late-onset smoking).

It is worth noting the similarities between the two studies. Both Orlando and

colleagues¹⁰⁶ and Chassin and colleagues⁵⁶ identified an early-onset, rapidly accelerating group, and both identified substantial late (after high school) onset. Both studies also identified an experimental group that does not progress to regular smoking. However, the Chassin study did not find that the trajectories merged into two outcomes (high smoking and low smoking). Differences between the two studies might reflect the ethnic distribution of the samples. The Chassin sample was almost entirely non-Hispanic Caucasian. There were also possible cohort effects in that the two studies were five years apart in their baseline data collections. Finally, because the Chassin study tracked participants longer into adulthood, greater differentiation of smoking trajectories as a function of developmentally limited smoking might have been achieved.

One important issue in describing trajectories of smoking is potential ethnic differences. Four studies have focused on African American samples. In one study, Juon and colleagues¹⁰² examined data from the Woodlawn study that followed inner city (predominantly low socioeconomic status) 1st graders to the age of 33 years. Rather than empirically identifying trajectories, they divided participants into nonsmokers, former smokers, late-onset smokers (after 18 years of age), and early-onset smokers. Compared to late-onset smokers, early-onset smokers were more likely to have been rated as aggressive by their 1st grade teachers, to have moved less often, to have had more lax parental supervision, and to have had more drug problems. Thus, early onset was generally associated with a profile of greater psychosocial risk in this study as it was with the other studies of ethnically diverse or Caucasian samples described above.

In another study, White and colleagues¹⁰⁸ modeled trajectories of the number of cigarettes smoked each day separately for African Americans and whites in the

Pittsburgh Youth Study, a prospective, longitudinal study of males that oversampled high-risk children and tracked them from ages 10 to 25 years. For each race, the three identified groups were nonsmokers, light smokers, and heavy smokers. However, there were differences in prevalence such that whites began smoking earlier and reached higher quantities of smoking than did African Americans. Similarly, Blitstein and colleagues¹¹⁶ found that African Americans were more likely to show slow progression than rapid progression in their smoking. Brook and colleagues¹¹⁰ modeled trajectories for African American and Puerto Rican adolescents aged 14–26 years and identified a group of nonsmokers, maturing-out smokers, late-starting smokers, and early-starting smokers. Although few studies have examined ethnicity, these findings converge in suggesting ethnic differences in onset and speed of progression that should be considered in describing smoking trajectories.

In short, among the few studies that have examined smoking trajectories from adolescence to adulthood, there is some convergence in terms of identifying an early-onset group that is either stably high or rapidly escalating, a later-onset group, and light-smoking groups that do not progress to regular smoking. However, there are important discrepancies, such as whether multiple trajectories do and do not diverge in their “final” endpoints and whether conceptually expected (but possibly low prevalence) groups such as stable light smokers (i.e., chippers) can be empirically identified. Studies have not empirically identified relapsing and remitting groups because (in all likelihood) these forms of growth are very complex to model. Most important, other than the fact that early-onset, sharply accelerating, and persistent groups are usually the most “at-risk” groups in terms of familial smoking, psychosocial risk, and measures of externalizing and internalizing problems, there is

little evidence that any one trajectory group constitutes a unique phenotype characterized by specific endophenotypes. Indeed, some studies have not been able to empirically predict different smoking trajectories (other than differentiating between smoking and nonsmoking groups). However, very little work has been done to link the hypothesized preexposure endophenotypes (see table 5.1 and chapter 8) to trajectories that might constitute dynamic phenotypes of smoking. This is an important direction for future research. Finally, these studies have been limited to cigarette smoking and have not considered trajectories of dependence symptoms or of other forms of tobacco use.

Statistical Models for Evaluating Alternative Developmental Phenotypes of Smoking Behavior

To this point, multiple possible developmental phenotypes have been described that can be hypothesized to underlie the onset and maintenance of smoking behavior. For example, one hypothesized phenotype might be defined by age of onset, such that children who begin smoking at a very young age might constitute a unique subgroup. Another phenotype might be hypothesized to be reflected in the latency from onset to regular or heavy smoking. Yet another phenotype might be evidenced in smoking persistence over age, such that individuals who repeatedly fail to quit (or never attempt to quit) form an important homogeneous phenotypic subgroup. Finally, phenotypes might be represented by combinations of these features that are captured by developmental trajectories that show particular ages of onset, slopes of acceleration, peaks of smoking rates,

and persistence of smoking over time. These are just a few examples of many different observable behaviors or patterns of behavior over time that might indicate developmental phenotypes of smoking.

Given the heterogeneity in hypothesized phenotypes of interest, there is correspondingly no single statistical model that will allow for the optimal empirical evaluation of the viability of all of these phenotypes. Instead, a statistical model must be selected that most closely corresponds to the theoretical model of the phenotype.^{117,118} For example, if a hypothesized phenotype postulates age of onset as a critical component, then survival analysis might be the ideal strategy. Alternatively, if a hypothesized phenotype is focused on time from onset to a transition to a category or stage of dependence, then latent transition analysis might be most appropriate. Because this chapter focuses on developmental trajectories (i.e., patterns of smoking behavior over development) as potential phenotypes, statistical methods for clustering developmental trajectories are emphasized. However, this is in no way meant to suggest that these methods are the only (or even necessarily the optimal) way to empirically evaluate smoking phenotypes. Rather, the goal is to provide a brief review of analytic methods for clustering growth trajectories, to summarize the relative strengths and weaknesses of these approaches, and to provide an empirical example of these techniques through the analysis of a large longitudinal study of smoking behavior.

Growth Curve Modeling

A core premise of the discussion so far is that the identification of phenotypes of smoking behavior might be well served by considering developmental trajectories of smoking-related behaviors and outcomes. This requires the collection and analysis of repeated-measures data, for which

there are a plethora of analytic options. Traditional methods such as repeated-measures analysis of variance (ANOVA) and multivariate analysis of variance have long been known to be limited by strict underlying assumptions that are rarely met in practice.¹¹⁹ Examples include the requirements of complete case data, equally spaced assessments, and normally distributed repeated measures. However, over the past two decades, a number of significant improvements in statistical models for repeated measures data have been introduced that overcome nearly all of these prior limitations. Because variations of these models arose within multiple literatures, there are various terms to which these are commonly referred. Examples include growth curve models, random coefficient models, latent curve models, and latent trajectory models. The evolution of growth curve models can be broadly traced to two modeling traditions: mixed (or multilevel) models and structural equation models (SEMs). Although there are a small number of important differences between models estimated within the mixed and SEM traditions, it is well known that these two approaches are isomorphic under a broad set of conditions.^{120–124}

The standard growth curve model is based on the principle that a set of observed repeated measures drawn from a sample of individuals can be adequately reproduced as a function of an underlying, unobserved developmental trajectory.^{119,125,126} The functional form of the trajectory might be linear, curvilinear, or characterized by some constant level that does not systematically change over time. Fitting a growth model to the observed statistics results in sample estimates of the parameters that define the underlying trajectory.^{127–129} To accomplish this, one or more latent factors are used to define the functional form of the trajectory. The means of the latent factors are the *fixed effects* of the model and represent the estimated trajectory pooling across all individuals

in the sample. The variances of the latent factors are the *random effects* of the model and represent the degree of individual variability around the fixed effects. Finally, one or more covariates can be included to test for systematic differences in the parameters that govern the trajectories as a function of the covariates (e.g., to identify characteristics of individuals who begin at a higher level and increase at a steeper rate over time). There are a number of powerful extensions to the standard growth curve model, and these have been widely used in many studies of development and change (see Bollen and Curran¹³⁰ for a comprehensive review of these models).

Growth modeling methods might provide one important approach to the study of developmental phenotypes for cigarette smoking. For example, a particular genotype or putative endophenotype score could be used to predict the slope of a growth curve, such that the genotype or endophenotype predicted steeper acceleration in smoking trajectories (see Audrain-McGovern and colleagues⁷² for an empirical example). Thus, if variation in acceleration of trajectories is a phenotype of interest, growth modeling provides a useful method for testing such phenotypes. Similarly, if early, heavy smoking is a phenotype of interest, then a particular genotype or endophenotype could be used to predict the intercept of the growth curve at a specific age of interest. Finally, the intercept and slope components of a developmental trajectory of smoking could themselves be used as predictors of a distal outcome such as nicotine dependence or some other measured characteristic. Taken together, growth curve models can be used to evaluate a number of important questions related to individual differences in developmental trajectories and their potential relation to smoking phenotypes and endophenotypes.

Despite the significant advantages growth curve models offer, they have limitations.

Of greatest importance for this chapter, a strong underlying assumption of the standard growth model is that all individuals are sampled from a single population. This, in turn, implies that the population is governed by a single multivariate distribution of trajectory parameters from which all individuals in the sample are randomly drawn. For example, a population might be characterized by an overall trajectory that is defined by some mean intercept and linear slope. Further, there is a bivariate distribution of individual intercepts and individual slopes around these mean trajectory values. Particular individuals might be characterized by intercept values that are larger or smaller than others or by linear slopes that are steeper or less steep than others. Importantly, though, all individual trajectories are assumed to be drawn from this single bivariate population distribution. In this conceptualization, phenotypes are viewed as arrayed on a continuum of severity rather than as qualitatively different categories that represent discontinuous, separate populations.

The assumption that the sample is drawn from a single (or *homogeneous*) population is perfectly reasonable in many research applications. However, this assumption presents a substantial limitation if there is theoretical reason to believe that individuals within a single sample may have been drawn from one of several populations. Although the standard growth model can be expanded to explicitly incorporate multiple populations,^{127,131} this is only possible if the grouping variable has been directly observed. Examples of observed grouping variables include gender, ethnicity, treatment condition, or observed genotype. However, significant challenges arise if the grouping variable has not been, or might never be, directly observed. A salient example of this is in the study of phenotypes. A single sample might consist of individuals drawn from one of several populations

(or phenotypic groups), yet these groups are inextricably mixed when using a standard single sample growth model. Further, the multiple group growth model is not a viable strategy because the phenotypic group membership is not directly observed. The challenge then becomes estimating the existence of these discrete groups on the basis of patterns of observed responses drawn from a single sample of individuals.^{132,133} Fortunately, a broad class of analytic methods exists that allows for the clustering of trajectories into two or more discrete groups.

Clustering Trajectories

A long and rich history drawn from fields including statistics, biostatistics, psychometrics, econometrics, and criminology has focused on the complex task of seeking empirical evidence for the existence of unobserved groups. A wide array of techniques have been developed including cluster analysis, latent class analysis, latent profile analysis, finite mixture modeling, and growth mixture modeling. A comprehensive exploration of these techniques is, however, beyond the scope of this chapter; see Bauer and Curran,^{134,135} Muthén,¹³⁶ and Nagin¹³⁷ for reviews.

The shared foundation of these analytic approaches is that an apparently homogenous sample of individuals is in actuality drawn from two or more discrete populations. Failure to properly model the mixing of multiple populations (or *population heterogeneity*) can lead to biased or invalid conclusions about the structural relations that exist within any of the multiple populations.¹³⁸ That is, fitting a model to the aggregation of multiple populations will likely not accurately reflect any one population, much less the full set. However, here lies the challenge: because population membership was not directly observed in the sample, the existence

of these groups must be inferred on the basis of other measured characteristics of the sample. Key analytic tasks include the identification of the optimal number of groups, the proper specification of structural relations of the observed variables within each group, and the probabilistic assignment of each individual as a member of each of the multiple groups.

Traditional clustering techniques make assignments of individuals to groups based on ad hoc measures such as the sum of distances or the sum of squared Euclidean distances from the mean (or *centroid*) of each cluster. A prominent example of this is the classic method of *k*-means clustering.¹³⁹ This is an iterative approach in which variability is maximized between groups and minimized within groups. The *k*-means approach typically begins with the placement of *k*-points into the data space, where *k* represents the number of clusters. This set of points defines the initial group centroids. Next, each individual observation is assigned membership to the group that is defined by the closest centroid. Once all of the observations have been assigned to a cluster, a new set of centroids are computed on the basis of the individuals assigned to that group. This process is then repeated until the change in centroids from one iteration to the next is negligible. Although this is a straightforward and sometimes useful clustering procedure, the strong assumption of perfect reliability of measures, the sensitivity to outliers, and the ad hoc nature of class assignment has limited the use of this approach in practice.

Subsequent clustering methods incorporate likelihood-based approaches to estimation in which class extraction, class membership probabilities, and covariate relations are estimated simultaneously. Two closely related yet distinct approaches are increasingly used for clustering trajectories. The first approach does not incorporate random effects associated with the growth

process within class and is sometimes referred to as latent class growth analysis (LCGA) because of the shared similarities of this approach with traditional latent class analysis.^{140,141} The second approach allows for the estimation of random effects within each class and is sometimes referred to as growth mixture modeling/models (GMM) because of the shared similarities of this approach with finite mixture modeling.¹⁴² The historical lines of development that ultimately led to these methods span more than a century.^{141–149} Drawing on these prior developments, two individuals can be predominantly credited with the latest methods of LCGA and GMM: Daniel Nagin and Bengt Muthén.

LCGA has primarily been developed by Daniel Nagin and his colleagues.^{133,137,150,151} Like latent class analysis,¹⁵² LCGA assumes conditional independence within class. As such, the within-class trajectory model is defined only by fixed effects. A mean trajectory is thus estimated for all individuals within a class, but there is no individual variability around these class-specific mean values. Posterior probabilities are estimated that reflect the probability that each individual belongs to each of the total number of classes. The effects of covariates can be included in LCGA, but these influences are limited to either predicting the set of class membership probabilities, or predicting class membership itself if each individual has been assigned to a single class on the basis of the posterior probabilities. LCGA has a variety of strengths, including the ability to directly model continuous, truncated continuous, and discrete repeated measures, and the expansion of the model to forming classes on the basis of simultaneous trajectories of two constructs over time.

GMM has primarily been developed by Bengt Muthén and his colleagues.^{132,136,153,154} Like finite mixture modeling,¹⁴² GMM assumes a multivariate normal distribution of the observations within each class. This, in

turn, allows for the estimation of a growth model within each class that is characterized by both fixed and random effects. Like LCGA, an overall mean growth function is estimated within each class; however, there is also the ability to incorporate individual variability around these mean values. This, in turn, allows for the inclusion of covariates as predictors of class membership, of the growth process within class, or both. One of several close ties between the two techniques is that restricting the within-class variability to zero in GMM is an equivalent parameterization to LCGA. Further, if only a single class is extracted in GMM, this is equivalent to the standard single group latent curve model. And if class membership is directly observed, then GMM is equivalent to the standard multiple group latent curve model (e.g., Bollen and Curran,¹³⁰ Chapter 6). More standard growth models can thus be viewed as restricted parameterizations of the more general GMM.¹⁵⁴ Growth mixture models also offer a variety of strengths including the incorporation of continuous, nonnormal, and discrete outcomes, as well as a number of advantages provided by the general SEMs (e.g., multiple indicator latent factors and formal tests of mediation).

The LCGA and GMM approaches to estimating population heterogeneity in longitudinal trajectories represent an exciting advance that has salient implications for the study of phenotypes in that these analytic techniques offer a close correspondence to the theoretical model of different developmental trajectories as phenotypes of smoking behavior. However, because these methods are new, there is still much to learn about their performance under a variety of research conditions. Further, as with any advanced statistical technique, a number of challenges are encountered when fitting these models to longitudinal data in practice,^{134,135,137,155–157} and both the advantages and challenges must be understood.

This chapter has already articulated many of the potential strengths associated with alternative techniques for clustering developmental trajectories over time. However, important issues must be considered when using these techniques. Because of space constraints, it is not possible to present a comprehensive discussion of all of these issues; see Bauer and Curran,^{134,135,155} Muthén,^{136,154,156} Nagin,^{133,137} and Nagin and Tremblay¹⁵⁷ for more detailed explorations. Instead, several specific issues are explored that are particularly salient in the empirical study of smoking phenotypes.

Theoretical Distinctions between Discrete and Continuous Phenomena

Possibly one of the most challenging issues immediately encountered when considering the use of clustering methods to empirically study smoking phenotypes is fundamentally philosophical. There has been a centuries-old conflict over the very nature of taxa and continua and the intersections between the two. The primary issue at hand is whether phenotypes are characterized as discrete, continuous, or some intersection of the two.^{158–163}

For example, consider two distinct phenotypes that are based upon a set of repeated observations taken on a sample of individuals over time. The first might be defined by individuals characterized by an early onset (i.e., *intercept*) and steep acceleration (i.e., *slope*) of use, and a second by individuals characterized by a later onset and less steep acceleration of use. Any given individual uniquely belongs to one phenotype or the other. In contrast, consider the same set of individuals observed on the same set of repeated observations. However, instead of distinctly belonging to one of two groups, the developmental growth process is characterized by a continuous bivariate distribution of intercepts and slopes; some individuals begin earlier and others later,

and some increase more steeply and others less so. This latter situation is the same as that described earlier for the single-group growth curve model. Although from this single-group model some arbitrary cutoff might be defined that forms two groups, in reality the developmental process operates across a smooth (but not necessarily normal) continuum. This is not to say that some cutoff would not be of potential use (e.g., as in clinical diagnoses), but it would be theoretically invalid to conclude that two distinct groups exist in the population.

Although some argue that a potentially flawed model might still provide a useful summary of a set of observed data,¹⁶⁴ the misattribution of discrete versus continuous processes is particularly challenging in the search for potential phenotypes.¹⁵⁵ That is, if the goal is to identify observable characteristics that might identify an underlying genotype, the arbitrary creation of discrete groups in the presence of true continua would be of limited use. Great care must be taken from both theoretical and empirical perspectives in the accumulation of evidence for or against the existence of discrete phenotypes. As explored further below, several conditions might lead to the spurious identification of multiple classes when in actuality none exist. Appreciation of these potential alternative explanations for the identification of multiple classes will aid in building a cumulative science.

Static Versus Dynamic Clustering

Once it has been determined that there is a theoretical foundation for the positing of multiple classes, the next challenge is to determine whether groups will be based on static or dynamic methods of clustering. Whereas static clusters are typically based on data derived from a single cross-sectional assessment, dynamic clusters are based on longitudinal data assessed repeatedly over time. From a static perspective, only the

characteristics of an individual at a given fixed point of development are informative with regard to their association with a particular phenotype. A salient example is a simple assessment of the presence or absence of nicotine dependence, although other static phenotype groups have been posited. Importantly, the characteristics of the trajectory that an individual may have traversed to arrive at that particular point in development are not of interest (or, at a minimum, the information has no predictive utility).

Given the notion of equifinality (as seen in “watershed” or stage models of smoking; e.g., in chapter 3) it is possible that regardless of the multiple pathways that led initially into variation in smoking onset and acceleration, the only relevant phenotypes of nicotine dependence are the “mature” phenotypes that define variation in ultimate nicotine dependence and inability to abstain. If so, then dynamic phenotypes such as trajectories of smoking behavior are of potential but time-limited interest and are ultimately replaced by other static phenotypes. In contrast, a dynamic perspective not only considers the characteristics of an individual at a particular point in development but also explicitly considers the path that individual followed through the years leading up to the particular fixed point. For example, although three individuals might all report nicotine dependence at 25 years of age, one may have reached that point with an initial onset in early adolescence, one with an onset in late adolescence, and one with an onset in early adulthood. These very different ages of onset may aid in the identification of developmentally informed phenotypes of smoking behavior, the distinction of which would have been wholly occluded if only considering nicotine dependence at 25 years of age. An example of the importance of dynamic phenotypes was proposed by Shaw and colleagues,¹⁶⁵ who found that it was the trajectory of *change* in

the thickness of the cerebral cortex rather than simply the thickness itself that was related to intelligence. From a statistical standpoint, the implementation of static and dynamic clustering techniques can lead to fundamentally different groupings of the same sample of individuals. As such, the selection of the optimal analytic approach has significant implications for both the inferences drawn from a given research study and for the development of an integrated understanding of empirical findings across existing literatures. The ultimate empirical reconciliation would primarily depend on the identification of meaningful genotypic differences as a function of static versus dynamic clustering.

Estimation of Within-Class Variability

Assuming an interest in the estimation of dynamic clusters, the next challenge is to determine which analytic approaches best correspond to the theoretical model under study. Whereas LCGA does not incorporate random variability in the growth process within class, GMM can include or omit these within-class random effects. The estimation of random effects for the growth process offers several advantages, including the incorporation of one or more predictors of the random growth parameters within class.¹³⁶ However, the omission of random effects also offers several advantages, including greater stability of estimation and correspondence to the hypothesized homogeneity within class.¹³⁷ This is an important decision because the inclusion or exclusion of within-class random effects for the growth parameters can directly influence the number of classes that are extracted from the same sample data.¹³⁵ One obvious strategy would be to fit models with and without within-class random effects and compare the correspondence between the two. If any observed differences are minimal, then the choice between the two parameterizations is less salient. However, in reality it is likely that the

solutions will differ, possibly substantially so. Moreover, the available theoretical models of smoking behavior are not well enough developed to determine whether random effects should be estimated within each class. As such, it falls on the applied researcher to consider the advantages and disadvantages of these approaches and make an informed and justifiable decision.

Importance of Nonnormality

As with the finite mixture models upon which it is based, GMM makes a strong assumption of within-class multivariate normality for both the repeated measures and the random trajectories. This assumption, in turn, dictates that the marginal distributions of the repeated measures (that is, the distribution of the measures for the fully aggregated sample) be nonnormally distributed. This is a straightforward result of mixing two or more normal distributions; under all but a small number of atypical conditions, the distribution of the mixture of two or more normal distributions must itself be, by definition, nonnormally distributed.¹⁴⁸ This assumption is what allows for the very extraction of multiple classes from a single sample. The complex nonnormal distribution for the aggregated sample can be approximated by the extraction of two or more normal distributions defined by different means and variances. Indeed, this is the most direct tie between GMM and the classic finite mixture model.¹³⁵

Yet, this assumption poses a vexing problem, particularly when applying GMM within many areas of substance-use research. Namely, it has been shown that not only is marginal nonnormality a necessary condition for multiple class extraction but also is a *sufficient* condition.¹³⁴ Computer simulation studies have shown that when modestly nonnormal data are generated from a single homogeneous population, GMM identifies multiple groups 100% of the

time.¹³⁴ Of course, this is precisely what the model is intended to do; multiple normal within-class distributions are estimated to approximate the more complex nonnormal aggregate distribution. A fundamental error, however, would be to conclude that multiple groups exist within the population when the optimal fitting multiple class model resulted solely as a function of the nonnormal aggregate distribution.¹⁵⁵

This issue poses a key challenge when applying these techniques to the study of smoking phenotypes. Given the very nature of the construct under study, many observable measures of smoking behavior are not going to follow a normal distribution. But how does one know if this nonnormality is due to the inappropriate aggregation of data drawn from multiple classes, or instead, is simply an accurate reflection of the distribution of the construct? No analytic method was found that will distinguish which of these two conditions most likely accounts for the observed nonnormality of the measures under study. Further, it is unclear how GMM might best be used to empirically test for population heterogeneity when it is highly likely (if not nearly certain) that multiple classes will be extracted on the basis of the marginal distribution alone. More specifically, how is a research hypothesis subjected to potential falsification when the outcome is known before the test is conducted?

As with prior challenges, it is commonly recommended that theory be used as a guide under such circumstances. However, it is not always clear how this might actually be accomplished. In some sense, this presents a basic Aristotelian syllogism: if the aggregate data are nonnormally distributed, multiple classes will be extracted regardless of population heterogeneity; smoking-related measures are nonnormally distributed; thus, multiple classes will be extracted when fitted to smoking-related measures, regardless of population heterogeneity. As addressed

later, an important strategy is to avoid the reification of class extraction from a single sample of data. A triangulation of findings from multiple studies using multiple outcomes may offer the best strategy when searching for evidence of smoking-related phenotypes.

Proper Model Specification

Just as multiple classes can be extracted to approximate a nonnormal aggregate distribution, multiple classes can also be extracted to “absorb” the bias introduced by the estimation of a misspecified model.¹³⁵ The model misspecification might arise from the incorrect parameterization of the functional form of the trajectory, from the exclusion of one or more structural parameters, or from the omission of nonlinear relations among two or more constructs. Regardless of source, it has been shown that an incorrect model fitted to data drawn from a single population can result in the identification of multiple classes when none truly exist.¹³⁵ Given the ubiquity of misspecified models in applied research,¹⁶⁶ the potential for spurious class extraction related to model misspecification poses another key challenge when applying these methods to the study of smoking phenotypes.

Alternative Spans of Study

Given that the focus of this chapter has been on identifying potential smoking phenotypes from the estimation of developmental trajectories, an obvious challenge is the impact of the developmental span under study. Of course, alternative developmental spans of study do not typically pose a challenge within a given study. That is, most applications will use all of the repeated observations that are available for analysis. However, this poses a much greater challenge when attempting to identify consistent findings from the existing literature. Consider two

hypothetical developmental phenotypes of smoking: one that consists of a late onset, modest acceleration, stable plateau, and a rapid decline to a low level of use, and the other consisting of precisely the same pattern except for a rapid decline to complete cessation. If one study were to follow a sample up to the point of decline, whereas another were to follow a sample past the point of decline, the resulting classes would likely be quite different between the two studies.^{167,168} The fact that different groups are obtained for different spans of measurement does not negate the validity of the obtained groups. As expected theoretically, individuals can change their trajectories with a change in risk or protective factors, and certain trajectory groups would not be hypothesized to appear until certain ages. For example, developmentally limited or late-onset forms of substance use cannot be distinguished until well into adulthood. However, changes in identified trajectory groups with changes in developmental span pose a salient challenge when one attempts to draw a broader understanding about the characteristics of the underlying population from multiple studies covering multiple developmental stages. A similar problem may occur in terms of alternative frequencies of repeated assessments. That is, assessments that occur frequently (e.g., daily, weekly, or monthly) can capture complex fluctuations in the outcome variable that will be lost when assessments occur more rarely over longer intervals (yearly or less than yearly).

Inclusion Versus Exclusion of Abstainers

A long-standing issue that arises in almost any study of substance use is how to best handle stable abstainers (see chapter 6 for a more detailed discussion). One (often unsatisfactory) option is to simply delete these from the analysis. This is clearly not ideal given both the discarding of valuable data and the introduction of a biased sample

relative to the population from which it was drawn. A second option is to treat abstainers as a unique class before the execution of the clustering analysis. Thus, abstainers are an “observed” class whose existence need not be estimated; they are then added to the other classes that are identified via the clustering techniques. Although preferable to omitting these data entirely, the possibility remains that some abstainers truly are using but either denied this use or misrecorded their responses, or that a true abstainer is quite close to becoming a first-time user. Treating all of these as complete abstainers does not allow for the possibility of these other issues. Finally, newer techniques have been developed that allow for a hybrid-type modeling approach in which one model is fitted to a 0/1 dichotomy of no use versus use, and another model is fitted simultaneously to those who are reporting use.¹⁶⁹ These techniques are quite promising but need to be more fully explored.

Summary

There are several important hypothesized developmental phenotypes of smoking behavior, each of which can be empirically evaluated by using one of a number of analytical methodologies. Techniques such as survival analysis, latent transition analysis, and growth curve modeling can be used with varying degrees of success to empirically evaluate these predictions. This chapter has focused on one such approach—namely, methods for clustering developmental trajectories. As described earlier, these methods offer multiple potential advantages for the study of phenotypes of smoking behavior. However, it is also important to closely consider challenges that arise when using these methods in practice. This chapter considers some of the particularly important issues that arise when studying smoking phenotypes on the basis of the clustering of developmental trajectories over time. The goal is to highlight these challenges

so that future applications of trajectory clustering techniques may be cognizant of these issues and proceed in a thoughtful and careful manner.

An Empirical Example: Trajectories in the Indiana University Smoking Survey

To provide an empirical example of these issues raised by modeling smoking trajectories, a series of models are presented using data from the Indiana University Smoking Survey. The focus is on a comparison of two time windows (ages 10 to 32 years and 10 to 42 years), relating static indicators of adult nicotine dependence to clusters that are dynamic (developmental smoking trajectories estimated via LCGA). These analyses allow for three important comparisons. First, the same sample can be used to directly compare the optimal number of groups based on a 22-year developmental window with the optimal number of groups based on a 32-year developmental window. This will demonstrate whether different phenotypic groups might be identified if the same sample were followed over a longer developmental period. Second, the stability of group membership can be examined. That is, the extent to which an individual assigned to a particular phenotype in the shorter window remains a member of that same phenotype in the longer window can be assessed. Finally, the relation between adult nicotine dependence and trajectory group membership examines whether these trajectory groups have any systematic implications for nicotine dependence. Taken together, these analyses will offer a concrete empirical demonstration of both several key advantages and several specific challenges that are encountered when using these techniques in practice.

The Indiana University Smoking Survey is an ongoing, cohort-sequential study of the natural history of cigarette smoking that began in 1980.^{13,56,170,171} Between 1980 and 1983, all consenting 6th–12th graders in a county school system in the Midwest completed annual surveys (total N who were assessed at least once = 8,487). The sample included 10 cohorts that correspond to the graduating classes of 1980–1989. Follow-ups were conducted in 1987 (73% retention, $N = 6,234$, ages 15–25 years), 1993 (73% retention, $N = 6,223$, ages 21–32 years), and 1999 (71% retention, $N = 6,068$, ages 27–37 years), as well as 2005 (70% retention, $N = 5,931$, ages 32–42 years). Because the sample was 96% non-Hispanic Caucasian, ethnic differences were not considered.

Sample representativeness has been described in detail elsewhere.^{13,171} Demographically, the sample is similar to the community from which it was drawn: 64% marriage rates in this sample compared with 66% among adults of similar ages in the Midwest,¹⁷² and 97% high school graduation rates in the sample compared with 92% among adults of similar ages in the Midwest.¹⁷³ At the last completed follow-up (1999), the smoking rate in the sample was 26%, the same rate found statewide.¹⁷⁴ Thus, the sample is representative of its community; that is, predominantly white and well educated.

Attrition biases have been discussed in detail elsewhere.^{171,175} For each follow-up, those who were lost were compared with those who were retained in terms of their earlier data. Dropouts were more likely to be smokers and have more positive attitudes and beliefs about smoking. They also had parents and friends who were more likely to smoke (effect sizes ranging from r^2 of .01 to .02). Because of the consistent pattern of findings, some caution is warranted when making generalizations.

For these analyses, two subsamples of participants were selected. First, trajectories

were modeled using the first six waves of measurement, selecting participants who had been measured at least once (ages ranged from 10 to 32 years, and 51% were males). Next, these results were compared with trajectories obtained from considering the entire available data (waves 1–8, age range = 10–42 years, 51% male).

Procedures

Adolescent data were collected with group-administered questionnaires in school. In 1987, these procedures were followed for cohorts who were still in high school. For cohorts who had graduated from high school (and for all participants in 1993 and after), a survey was sent by mail and followed up by telephone interviews if questionnaires were not returned. Participants were paid \$15 for mailed surveys, and in 1999, they also were entered into a lottery for prizes of \$200. At the 2005 follow-up, mailed surveys with telephone interview follow-ups were again used with participant fees (\$30) and lottery incentives.

Measures

Smoking Level

Smoking level was determined by two items. Participants reported their current smoking status as “never smoked, not even a single puff”; “smoked once or twice ‘just to try’ but not in the last month”; “do not smoke, but in the past I was a regular smoker”; “smoke regularly but no more than once a month”; “smoke regularly, but no more than once a week”; or “smoke regularly and more than once a week.” Participants also reported the number of cigarettes they typically smoked each day (from 0 to 20 or more). To improve the validity of self-reported smoking status in adolescence, a bogus pipeline was used from 1981 to 1983. As reported elsewhere,¹⁷¹ a study using an unannounced bioassay with a subsample

of the participants supported the validity of the self-reports.

For these analyses, responses were combined into a six-level variable to reflect current smoking at each measurement wave, reflecting both frequency and quantity of smoking as follows: 0 = not currently smoking (nonsmokers, ex-smokers, those who had smoked once or twice, but not in the past month); 1 = up to monthly smoking; 2 = up to weekly smoking; 3 = weekly or more smoking, but only 10 or fewer cigarettes per day; 4 = weekly or more smoking of 11–20 cigarettes per day; and 5 = weekly or more smoking of 20 or more cigarettes each day. In some cases, responses to these items were ambiguous, and additional items were consulted concerning the number of cigarettes smoked yesterday and the time since the last cigarette was smoked.

Adult Tobacco Dependence

Tobacco dependence was measured with the Fagerström measure as well as by examining two individual items: number of cigarettes smoked in a typical day and time to first cigarette in the morning.

Family History of Smoking

Family history of smoking was based on participants' reports of lifetime smoking among their biological parents at waves 5 and 6. Family history was scored positive if at least one biological parent was reported to be a smoker.

Data Analysis

Individual, time-specific, smoking behavior scores were modeled over ages 10–32 years (using waves 1–6) and ages 10–42 years (using waves 1–8) with LCGA. However, several groups were constructed a priori. Individuals who reported never having

smoked a single puff or having smoked once or twice “just to try” but never progressing beyond this category at any measurement were defined a priori as continuous abstainers ($N = 4,642$ in waves 1–6, and $N = 4,298$ in waves 1–8). Individuals who were never measured as smokers but only as “ex-smokers” were defined a priori as stable quitters ($N = 672$ in waves 1–6, and $N = 669$ in waves 1–8). Individuals who reported periods of smoking, quitting, and then smoking again were defined a priori as a “relapsing/remitting” group ($N = 535$ in waves 1–6, and $N = 874$ in waves 1–8). All other participants were clustered empirically.

All LCGA model estimation was performed using Proc Traj^{133,176} as available for Statistical Analysis Software (SAS). A series of latent class models were estimated ranging from one to seven classes assuming a censored normal (0, 5) response distribution. No user-supplied start values were used in the initial models. A number of criteria were used to select the “best” model for the two age ranges. The criteria included an overall reduction in the Bayesian Information Criterion¹⁷⁷ and Akaike Information Criterion^{178,179} to be less than 100 for the next largest class as well as for the model to remain stable (with the addition of and changes to subsequent start values) and consistent with substantive theory. Model selection for waves 1–6 and 1–8 was done independently of each other.

Once the appropriate models were chosen, the modal probability of class membership was used to place individuals into a particular class (the class for which their membership probability was highest). These classes serve as the independent variables in all further analyses. Class or “group” membership was used to predict several outcomes including Fagerström dependence, number of cigarettes smoked in a typical day, time to first morning cigarette, and family history of smoking. Each outcome was evaluated independently.

For dichotomous outcomes, logistic regression was employed and parameter estimates were obtained using SAS's Logistic procedure. Each model consisted of dummy-coded class membership variables (0 for not in the class, 1 for in the class). Abstainers were zero on all membership variables. Linear contrasts were then used to test for significant differences between each class's ability to predict the outcome. Continuous outcomes were predicted with ANOVAs.

Results

LCGA Results

A five-class solution was found to be optimal for waves 1–6. As seen in figure 5.1, the five classes were experimenters (4.5%); developmentally limited smokers (3.4%); early-onset, persistent smokers (7.4%); high-school-onset, persistent smokers (9.9%); and late-onset, persistent smokers

(6.4%). As noted earlier, a priori groups were stable abstainers (54%), stable quitters (8%), and relapsing/remitters (6%). Experimenters began smoking early (around 11 years of age), but never smoked more than occasionally, and generally quit smoking by 21 years of age. Developmentally limited smokers started smoking around the age of 16 years, smoked regularly but averaged around 10 cigarettes per day at their peak, and gave up smoking by 27 years of age. Early-onset, persistent smokers typically started around the age of 11 years and increased their smoking quickly to a peak of more than one-half pack per day, which they maintained over development. High-school-onset, persistent smokers started around 14 years of age, quickly increased their smoking, and although never quite as heavy as the early group, continued to smoke heavily. Late-onset, persistent smokers started around the age of 18 years and quickly became moderate smokers.

Figure 5.1 Five-Class Solution for Waves 1–6

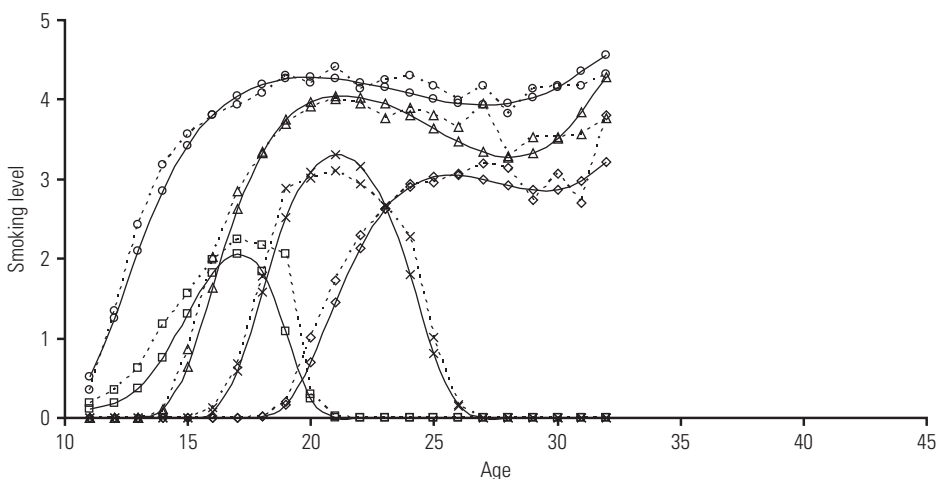

Note. Smoking level was determined by participants' reported frequency and quantity of smoking, expressed numerically as follows: 0 = not currently smoking (nonsmokers, ex-smokers, those who had smoked once or twice, but not in the past month); 1 = up to monthly smoking; 2 = up to weekly smoking; 3 = weekly or more smoking, but only 10 or fewer cigarettes per day; 4 = weekly or more smoking of 11–20 cigarettes per day; and 5 = weekly or more smoking of 20 or more cigarettes each day. Dotted lines denote observed trajectories. Solid lines denote model-implied trajectories. Experimenters are denoted by squares; developmentally limited smokers by "x"s; early-onset, persistent smokers by circles; high-school-onset, persistent smokers by triangles; and late-onset, persistent smokers by diamonds.

As seen in table 5.2, the gender makeup of the groups was generally evenly split, except for the late-onset, persistent group, which had significantly more males compared to every other group except for the relapsing/remitting groups. However, there was a stronger relation between group membership and education. When measured at wave 6, the sample of participants reporting education data had approximately 36% of individuals with BA degrees or higher. The least educated group comprised the early-onset, persistent smokers (3.4% of whom had completed a college degree). They significantly differed from all other groups. Other groups with relatively low levels of educational attainment were the high-school-onset group (14.4% with BAs or higher) and the relapsing/remitting group (13.5% with BAs or higher), who significantly differed from all other groups but not from each other. The abstainers were the most highly educated group (47.9% with BAs or higher), and they significantly differed from all other groups. Late-onset and developmentally limited groups were also relatively well educated (approximately 38% with BAs or higher) and did not significantly differ from each other.

A six-class solution was found to be optimal for waves 1–8. As seen in figure 5.2, the six classes were experimenters (4.2%); developmentally limited smokers (4.7%); successful quitters (2.4%); early-onset, persistent smokers (8.4%); high-school-onset, persistent smokers (8.7%); and late-onset, persistent smokers (3.1%). Compared to the waves 1–6 model, this model produced one additional class: successful quitters. As noted earlier, the a priori groups were stable abstainers (50.4%), stable quitters (7.8%), and relapsing/remitters (10.24%). Similar to the experimenters who were identified in waves 1–6, this experimenter group began smoking around the age of 11 years, never smoked more than occasionally, and, in general, quit smoking by the age of 22 years. Similarly, the developmentally limited group generally started around the age of 16 years, smoked more on average than did the experimenters, (but less than one-half pack at their peak), and gave up smoking by the age of 30 years. As in the waves 1–6 model, the early-onset, persistent group typically started smoking around the age of 11 years, increased their smoking behavior quickly, and maintained the highest level of smoking over the course of

Table 5.2 Trajectory Group Sizes and Relationship with Gender and Educational Attainment

Waves	N		%		Gender (% female)		College degree or higher (%)	
	1–6	1–8	1–6	1–8	1–6	1–8	1–6	1–8
Abstainers	4,642	4,298	54.39	50.36	49.59 ^a	50.58 ^{ab}	47.85	56.50 ^a
Stable quitters	672	669	7.87	7.84	48.21 ^a	46.64 ^{ab}	35.00 ^{ac}	47.73 ^b
Developmentally limited	288	398	3.37	4.66	45.83 ^{ab}	43.97 ^{ab}	38.37 ^a	59.31 ^a
Experimenters	381	362	4.46	4.24	51.44 ^a	55.25 ^a	28.01 ^c	41.60 ^b
Early onset	628	715	7.36	8.38	48.57 ^a	48.04 ^{ab}	3.44	6.90
Successful quitters	—	208	—	2.44	—	57.21 ^{ab}	—	38.71 ^b
High school onset	844	744	9.89	8.72	50.89 ^a	44.62 ^b	14.42 ^b	24.32 ^c
Late onset	544	266	6.37	3.12	38.60 ^{bc}	30.83	37.78 ^a	45.89 ^b
Relapse/remmit	535	874	6.27	10.24	45.05 ^{ac}	46.00 ^{ab}	13.45 ^b	26.17 ^c
Total	8,534		100		48.59		36.19	45.75

Note. Groups that share subscripts do not significantly differ from one another ($p < .05$).

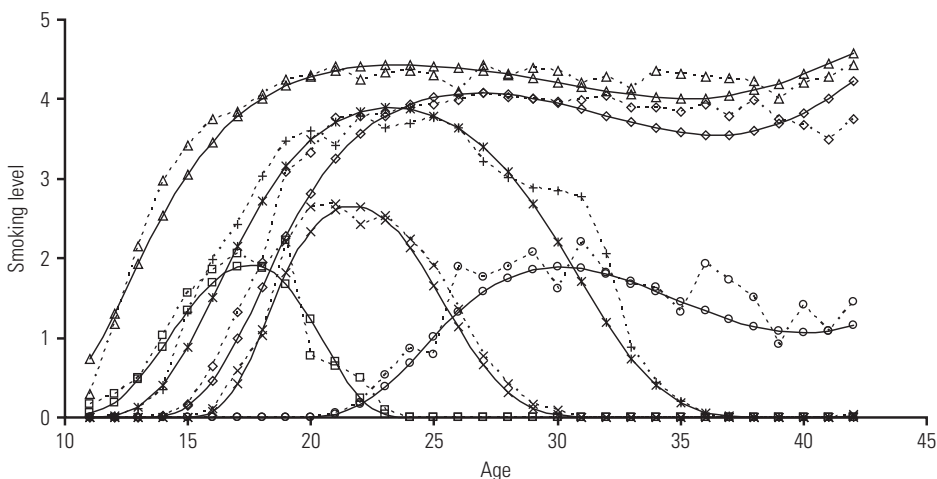
Figure 5.2 Six-Class Solution for Waves 1–8

Note. Smoking level was determined by participants' reported frequency and quantity of smoking, expressed numerically as follows: 0 = not currently smoking (nonsmokers, ex-smokers, those who had smoked once or twice, but not in the past month); 1 = up to monthly smoking; 2 = up to weekly smoking; 3 = weekly or more smoking, but only 10 or fewer cigarettes per day; 4 = weekly or more smoking of 11–20 cigarettes per day; and 5 = weekly or more smoking of 20 or more cigarettes each day. Dotted lines denote observed trajectories. Solid lines denote model-implied trajectories. Experimenters are denoted by squares; developmentally limited smokers by "x"s; quitters by pluses (+); early-onset, persistent smokers by circles; high-school-onset, persistent smokers by triangles; and late-onset, persistent smokers by diamonds.

the study (more than one-half pack per day). High-school-onset, persistent smokers (as described in the waves 1–6 model) began to smoke around the age of 16 years and smoked fairly heavily over development (almost as much as the early-onset group). The late-onset, persistent group identified in the waves 1–8 model tended to start a little later (21 years of age) than in the waves 1–6 model (18 years of age). Moreover, this group generally increased more slowly and maintained a relatively low level of smoking behavior. Successful quitters (the group that did not emerge in the waves 1–6 model) started slightly later, around the age of 12 years, smoked fairly heavily for many years, and eventually quit in adulthood (by 37 years of age).

As shown in table 5.2, the pattern of gender and education differences was quite similar to the waves 1–6 model. The groups were generally evenly split in gender, with

the percentage of females in a group ranging from 30.83% (late onsetters, who significantly differed from all other groups) to 57.21% (successful quitters who did not differ from any other group except for late onsetters).

As with the waves 1–6 model, a strong relation was found with educational attainment. When measured at wave 8, 45.8% of the sample who reported their educational attainment had completed a BA degree or higher. The trajectory group with the highest educational attainment was the developmentally limited smokers (59.3% with BAs or higher), and they did not significantly differ from the abstainers (56.5%). Other groups with relatively high levels of educational attainment were the stable quitters (47.7% with BAs or higher), experimenters (41.6% with BAs or higher), successful quitters (38.7% with BAs or higher), and late-onset smokers (45.9% with

BAs or higher), and these groups did not significantly differ from each other. As in the waves 1–6 model, the lowest level of educational attainment was found for the early-onset, persistent group (only 6.9% with a BA degree or higher), and this group significantly differed from all others. The high-school-onset group (24.3% with a BA or higher) and the relapsing/remitting group (26.2% with a BA or higher) were also relatively less educated and significantly differed from all other groups, but not from each other.

Stability of Classification across the Models

In general, group membership remained fairly consistent across analyses. As can be seen in table 5.3, a large proportion of the sample (81.9% of the total sample, 64.6% of the empirically classified subsample) was classified in the same group across the different age span models. Moreover, differences in classification across models were theoretically reasonable. Of those who were stable abstainers in waves 1–6, 93% were still abstainers 10 years later, and those who changed categories were most likely to become late-onset, persistent smokers or successful quitters. Of those who were stable quitters in waves 1–6, 82% were stable quitters 10 years later, and those who were not were categorized as relapsing/remitters. Of those who were developmentally limited smokers in waves 1–6, 62% were classified in the same group 10 years later, and those who were not were most likely to be classified as relapsing/remitters. Of those who were experimenters in waves 1–6, 77% were classified in the same group 10 years later, and those who were not were most likely to be classified as relapsing/remitters. Of those who were early-onset, persistent smokers in waves 1–6, 90% were classified in the same group 10 years later, and those who were not were most often classified as successful quitters or experimenters.

Table 5.3 Stability of Classification across the Waves 1–6 and Waves 1–8 Models

Waves 1–6	Waves 1–8 trajectory group										Total
	Abstainers	Stable quitters	Developmentally limited	Experimenters	Early onset	Successful quitters	High school onset	Late onset	Relapse/remit		
Abstainers	4,298	115	3	3	0	3	76	128	16	4,642	
Stable quitters	0	554	0	0	0	0	0	0	118	672	
Developmentally limited	0	0	178	16	0	5	28	1	60	288	
Experimenters	0	0	5	292	6	1	4	0	73	381	
Early onset	0	0	0	24	563	24	0	0	17	628	
Successful quitters	0	0	0	0	0	0	0	0	0	0	
High school onset	0	0	65	27	146	137	433	0	36	844	
Late onset	0	0	147	0	0	38	203	137	19	544	
Relapse/remit	0	0	0	0	0	0	0	0	535	535	
Total	4,298	669	398	362	715	208	744	266	874	8,534	

The largest difference between the two models is seen in the successful quitting group, which did not emerge in the earlier years. The waves 1–8 successful quitting group was drawn primarily from the high-school-onset and late-onset smokers in waves 1–6. This finding indicates that a later onset of smoking is associated with greater likelihood of successful cessation.

In a parallel finding, there was somewhat less stability in the waves 1–6 high-school-onset smokers, with 51% classified in the same group 10 years later. Those who changed groups were likely to be classified as either early onset (reflecting the similarities between middle school and high school onset) or successful quitters (reflecting those who succeeded in cessation).

Finally, there was low stability in the waves 1–6 late-onset smokers, with only 25% being classified as late onset in the waves 1–8 model. Those who were late-onset smokers in the waves 1–6 model were most likely to be classified as high school onset in the waves 1–8 model (37%), reflecting the ambiguity of their onset at the age of 18 years as somewhat like adolescents and somewhat like adults. Moreover, a substantial number of the waves 1–6 late-onset smokers (27%) were classified as developmentally limited smokers in the waves 1–8 model, reflecting the fact that they stopped smoking by adulthood. Conversely, the late-onset group that emerged in the waves 1–8 model was drawn mostly from the waves 1–6 late-onset smokers and abstainers and showed a later age of onset than did the first model (22 years of age rather than 18 years).

Family History Analysis

Logistic regression models that related trajectory group membership to family history of smoking produced similar results for the waves 1–6 and waves 1–8 groups.

In both models, the lowest likelihood of having a smoking parent was for late-onset smokers, abstainers, and developmentally limited smokers, who did not significantly differ from each other. In the waves 1–6 model, the highest likelihood of having a smoking parent was for early-onset, high-school-onset, and relapsing/remitting groups, who differed from the other groups, but not from each other. In the waves 1–8 model, the highest likelihood of having a smoking parent was for the early-onset and the successful quitter groups, who significantly differed from abstainers and late-onset smokers, but not from each other (table 5.4).

Indicators of Adult Nicotine Dependence: Amount Smoked, Time to First Cigarette, and Fagerström Dependence Diagnoses

For both the waves 1–6 and 1–8 models, the groups who smoked at the end of the trajectory (early onset, high school onset, late onset, and relapsing/remitting) were compared on indicators of nicotine dependence measured at wave 8 (ANOVAs and logistic regressions in table 5.5). (Note that this analysis examines current dependence at wave 8, but does not identify the timing of onset of dependence). The findings for the two models were quite similar. For both waves 1–6 and 1–8 groupings, the early-onset, high-school-onset, and late-onset groups significantly differed from each other in both models on all indicators. The early-onset group showed the highest percentage of tobacco dependence (more than one-half of the group); this percentage was strikingly higher than the late-onset group (12%–19% in the second model). Similarly, the early-onset group smoked at high levels (averaging one pack per day), whereas the late-onset group was closer to “chippers” (averaging seven cigarettes per day for the waves 1–8 late-onset group). Also paralleling these findings, the early-onset group was more

Table 5.4 Relationship of Trajectory Group Membership to Family History of Smoking

	Waves 1–6		Waves 1–8	
	<i>N</i>	With at least 1 smoking parent (%)	<i>N</i>	With at least 1 smoking parent (%)
Abstainers	3,359	67.40 ^a	3,154	66.93 ^a
Stable quitters	452	71.68 ^{ab}	451	71.40 ^{ac}
Developmentally limited	269	68.77 ^{ab}	353	69.12 ^{ac}
Experimenters	310	73.23 ^{bc}	290	74.48 ^{abc}
Early onset	327	85.02 ^d	390	83.85 ^{bc}
Successful quitters	—	—	164	86.59 ^{bd}
High school onset	622	81.19 ^{cd}	519	78.23 ^{cd}
Late onset	460	67.61 ^{ab}	217	63.59 ^a
Relapse/remit	432	80.32 ^{bcd}	693	77.20 ^{cd}
Total % with a smoking parent		71.27		
Total <i>N</i>		6,231		

Note. Groups that share superscripts do not significantly differ from one another ($p < .05$).

Table 5.5 Relationship of Trajectory Group Membership to Smoking Dependence Indices in Wave 8

	Waves 1–6			Waves 1–8		
	Dependent using FTND ≥ 6 (%)	Number of cigarettes smoked in 1 day	Smoke first cigarette of day immediately (<5 min.) (%)	Dependent, using FTND ≥ 6 (%)	Number of cigarettes smoked in 1 day	Smoke first cigarette of day immediately (<5 min.) (%)
Early onset	59.0 ^a	22.1 ^a	41.4 ^a	54.4 ^a	22.0 ^a	39.4 ^a
High school onset	34.0 ^b	17.1 ^b	22.0 ^b	31.7 ^b	16.3 ^b	19.1 ^b
Late onset	18.8 ^c	12.0 ^c	10.7 ^c	11.9 ^c	6.7 ^c	6.9 ^c
Relapse/remit	34.7 ^b	16.5 ^b	19.5 ^b	25.3 ^d	13.6 ^d	13.5 ^d
Overall	38.8	17.6	24.9	34.6	16.1	21.4

Note. Groups that share superscripts do not significantly differ from one another ($p < .05$). FTND = Fagerström Test for Nicotine Dependence.

likely to smoke the first cigarette of the day immediately upon awakening (39%–41% of these groups in the two models), whereas less than 10% of the late-onset groups did this.

Differences between the waves 1–6 and waves 1–8 models involved the relapsing/remitting group. For the waves 1–6 model, this group resembled the high-school-onset group on all indicators, whereas it significantly differed from the early- and late-onset group on these same indicators. In the waves 1–8 model, the relapsing/remitting group was

distinctly and significantly different from all of the other groups and was the second lowest (to the late-onset group) in indicators of nicotine dependence.

Discussion

These findings demonstrate both the potential utility and some of the challenges involved with empirically identifying multiple developmental trajectories of smoking. Analyses revealed meaningful heterogeneity in trajectories that would be

relevant for genetic studies. Results also showed that static assessment at any one time point has limitations. For example, early-onset smoking is correlated with steep acceleration and high persistence. Examining only a single age point of onset, however, would not reveal this finding because some of these early onsetters will merely experiment and not progress to regular smoking. However, a developmental trajectory that combines early onset, steep acceleration, and high persistence produces the highest risk for adult dependence and shows high levels of family history of smoking. This suggests a phenotype of interest for genetic analysis. The very low educational attainment of this group also suggests the presence of other risk factors (as identified in other studies, table 5.1). Thus, the low educational attainment may reflect the effects of endophenotypes that undermine educational success, such as conduct problems, impulsivity, behavioral undercontrol, and attention deficit. It is also important to assess the possible role of low socioeconomic status (which also constrains educational attainment).

Although the early-onset, persistent group is clearly at highest risk, the differences between the early-onset and high-school-onset groups appear to be quantitative and dimensional, rather than demonstrating a qualitatively distinct etiological pathway of smoking acquisition. These trajectories show both steep acceleration and persistence at high levels of smoking, although the early-onset group was somewhat elevated in indicators of adult dependence and somewhat lower in educational attainment. Thus, the available data suggest that there is simply a difference in severity between the early-onset and high-school-onset groups (although a consideration of predictors of trajectories might reveal other patterns).

Moreover, even among adolescents whose onset of smoking is early in adolescence, some became successful quitters (albeit a

small prevalence). These successful quitters had family histories of smoking equivalent to the early-onset group, suggesting that a simple genetic explanation of cessation is likely to be insufficient. The similarities between the early-onset and successful quitting groups in family history is consistent with a stage model demonstrating multifinality, so that similar factors may have led the quitters and persistent groups to initiate smoking, but different factors (possibly arising in adulthood) ultimately determine successful smoking cessation. Interestingly, the groups differed in educational attainment, so perhaps social contextual and intrapersonal factors related to success in higher education may provide some way to distinguish successful quitters from early-onset, persistent smokers.

Although the early-onset and high-school-onset groups appear to represent continuous distributions of risk, the late-onset group appears more qualitatively distinct. In fact, in many ways, late-onset group members resembled abstainers. They have low levels of familial smoking and high levels of educational attainment. They also show low levels of adult smoking and dependence. In these ways, they resemble tobacco “chippers,” who may be relatively less vulnerable to tobacco dependence. Thus, whatever mechanisms produced their late-onset smoking, these mechanisms may be different from those that underlie early and high school smoking acquisition. This late-onset group has been underrecognized and understudied, unless they are considered to be the same as “chippers” (light smokers).

The findings also demonstrate several challenges that arise in attempting to empirically identify multiple trajectories of smoking. For example, although the groups obtained from waves 1–6 and 1–8 were substantially similar in terms of classification, the solutions were not identical. Changes in group classification occur with changes in the ages under

study, sample characteristics, variations in smoking measures and other factors, and these changes make it challenging to examine the robustness of trajectories derived across different studies. However, it is also important to note that some of the differences between the waves 1–6 and 1–8 models reflect meaningful developmental changes, and that trajectories measured at different stages of the life course would be expected to differ. For example, trajectories of developmentally limited or late-onset smoking cannot emerge until a sufficient age span is measured. Moreover, individuals can change trajectory groups with a meaningful change in their smoking behavior (i.e., individuals may smoke at high levels but then become successful long-term quitters). Future research might explore such meaningful developmental changes by using methods developed to identify “regime switching” (i.e., switching between trajectory groups¹⁸⁰).

Moreover, the findings were produced by a combination of approaches in which some groups were defined a priori and others were derived empirically. For example, a wholly empirical approach could not differentiate individuals who were always measured as abstainers from those who were always measured as ex-smokers since both groups would need to have identical scores to enter into the model. Also, these analyses did not examine modeling solutions that incorporate within-class variability, and all of these modeling decisions will affect the trajectory groups produced.

Finally, although not necessarily a limitation of this approach, these analyses did not address many questions that go beyond the scope of a single chapter. For example, tobacco use was not examined in forms other than cigarette smoking (which may affect patterns and trajectories of smoking). In addition, prospective predictors of these trajectories (other than family history of smoking) were not examined nor were

trajectory group memberships related to hypothesized endophenotypes.

Future Research Directions

The literature review and empirical example provided in this chapter point to several directions for future research. The first task is a better specification of the relation between trajectories of smoking behavior and the development of nicotine dependence, as well as the relation between adolescent and adult trajectories. Given stage models (such as the “watershed” model in chapter 3), developmental trajectories of smoking acquisition may better be considered as “transitional” phenotypes whose etiological determinants differ from those that underlie the phenotypes of nicotine dependence. Thus, developmental phenotypic information may be very important at particular stages in the smoking trajectory to mark diverse etiological mechanisms underlying acquisition, but these diverse pathways may become relatively less important in the presence of tobacco dependence. In addition, the measurement equivalence of tobacco dependence symptoms over the life span requires further study to determine the similarities and differences between tobacco dependence in adolescence and adulthood. More research is needed on the heterogeneity in time course and predictors of the transitions from initial exposure to dependence. Moreover, further research is required to understand the age-specific effects of initial nicotine exposure, which have shown a significant relation between an early age of onset and steeper acceleration over time. The mechanisms underlying this relation require further exploration in both animal and human models.

Another important question is whether a particular individual feature of a trajectory (e.g., age of onset or steepness of

acceleration) is the important phenotype or whether it is more useful to consider an entire trajectory group. The probabilistic nature of empirically identified trajectories (which change with different measures and age spans and from which individuals may enter and exit over time) creates a conflict with the goal of defining “true” and unchanging groups for genetic analysis. Moreover, different research approaches are needed to determine whether phenotypes are best considered as categorical “groups” or as representations of an underlying continuous dimension. For future research on multiple trajectories of smoking, an accumulating literature on the subject will help to determine whether empirically identified trajectory groups are reliable across different samples, and whether there are important ethnic differences in these groups. Moreover, very few studies relate these trajectories to measured genotypes or that examine trajectories in genetically informative samples (see chapter 7 for an example). More studies are needed to understand these areas. It may also be useful to consider tobacco within a context of other substance use (chapter 7) or broader “externalizing” disorders because the underlying genotype may reflect a broader tendency to disinhibition rather than a specific risk for tobacco dependence. Along with this consideration, studies are needed that relate smoking trajectories to indicators of hypothesized endophenotypes and to indicators of tobacco dependence.

Finally, practical issues must be considered in this type of research. Unless reliable and valid methods can be developed to retrospectively reconstruct trajectories, these must be derived from costly longitudinal studies. Moreover, within longitudinal studies, there are trade-offs between intensity and frequency of measurement intervals. For example, more frequent and more intense measurements provide greater resolution of transition points but require greater participant

commitment and greater financial resources. These studies also require large sample sizes if heterogeneity in trajectories is of interest (especially given the high prevalence of nonsmoking). A useful approach may be to target important ages or high-risk groups or to use accelerated longitudinal designs. One potentially helpful strategy may be to take advantage of existing longitudinal data sets by adding measures of endophenotypes (as well as genetic data) that are not time varying or age dependent. These represent some of a number of open questions that remain to be addressed through future research.

Summary

As demonstrated in this chapter, a consideration of developmental trajectories of cigarette smoking has potential for refining phenotypes of smoking for genetic analysis and for illuminating etiological mechanisms. Research has demonstrated meaningful heterogeneity in age of onset, slope of acceleration, and peaks and persistence of use. These features have been found to be significantly related to some hypothesized endophenotypes as well as to indicators of tobacco dependence. In a very small number of studies, these trajectory features have also been related to genetic variability. However, this literature is still in a very early stage. It is premature to conclude that smoking trajectories (or even individual features of trajectories) will constitute important phenotypes of smoking.

At the same time, the study presented here demonstrates that developmental aspects of trajectories of smoking acquisition may be useful in refining phenotypes of smoking. There is evidence (including the evidence provided in the empirical example) that heterogeneity in trajectories is related to indicators of nicotine dependence in adulthood. Identifying these trajectories may

help to illuminate the multiple etiological pathways that underlie the development of tobacco dependence. The next chapters in this section extend this work to genetically informative designs (chapter 6) and to the consideration of dual trajectories of tobacco and alcohol use in a genetically informative design (chapter 7).

Conclusions

1. Previous studies (and the empirical example presented in the chapter) have identified multiple developmental trajectories of tobacco use from adolescence to adulthood. These trajectory groups, which vary in age of onset, rate of acceleration, and persistence of smoking over time also vary in their antecedents and correlated risk factors. These trajectories may be informative as developmental phenotypes for genetic studies of tobacco use.
2. Statistical approaches such as latent class growth analysis and growth mixture modeling can be useful in evaluating developmental trajectories of smoking behavior. However, challenges in using these approaches include the handling of within-class random effects, the impact of a nonnormal aggregate distribution on the classes extracted, the need for proper model specification and parameterization, the span of evaluated data, and the impact of abstainers on the model.
3. Analysis of a 25-year cohort-sequential study of smoking behavior identified six distinct trajectories of smokers across eight waves of data collection. These trajectory groups were experimenters; developmentally limited smokers; early-onset, persistent smokers; high-school-onset, persistent smokers; late-onset, persistent smokers; and successful quitters, with a priori groups of stable abstainers, stable quitters, and relapsing/remitters. Trajectory group membership was related to educational attainment, family history of smoking, and indicators of nicotine dependence.

References

- Kendler, K. S., M. C. Neale, P. Sullivan, L. A. Corey, C. O. Gardner, and C. A. Prescott. 1999. A population-based twin study in women of smoking initiation and nicotine dependence. *Psychological Medicine* 29 (2): 299–308.
- Madden, P. A., A. C. Heath, N. L. Pedersen, J. Kaprio, M. J. Koskenvuo, and N. G. Martin. 1999. The genetics of smoking persistence in men and women: A multicultural study. *Behavior Genetics* 29 (6): 423–31.
- Lerman, C., and W. Berrettini. 2003. Elucidating the role of genetic factors in smoking behavior and nicotine dependence. *American Journal of Medical Genetics Part B, Neuropsychiatric Genetics* 118 (1): 48–54.
- Swan, G. E., K. S. Hudmon, L. M. Jack, K. Hemberger, D. Carmelli, T. V. Khroyan, H. Z. Ring, et al. 2003. Environmental and genetic determinants of tobacco use: Methodology for a multidisciplinary, longitudinal family-based investigation. *Cancer Epidemiology, Biomarkers & Prevention* 12 (10): 994–1005.
- Sroufe, L. A., and M. Rutter. 1984. The domain of developmental psychopathology. *Child Development* 55 (1): 17–29.
- Cicchetti, D. 2006. Development and psychopathology. In *Developmental psychopathology, vol. 1, theory and method*, 2nd ed., ed. D. Cicchetti and D. J. Cohen, 1–24. Hoboken, NJ: Wiley.
- Mayhew, K. P., B. R. Flay, and J. A. Mott. 2000. Stages in the development of adolescent smoking. *Drug and Alcohol Dependence* 59 Suppl. 1: S61–S81.
- Sroufe, L. A. 1997. Psychopathology as an outcome of development. *Development and Psychopathology* 9 (2): 251–68.
- Pickles, A., and J. Hill. 2006. Developmental pathways. In *Developmental psychopathology, vol. 1, theory and method*, 2nd ed., ed. D. Cicchetti and D. J. Cohen, 211–43. Hoboken, NJ: Wiley.
- Gottlieb, G., and M. T. Willoughby. 2006. Probabilistic epigenesis of psychopathology. In *Developmental psychopathology, vol. 1, theory and method*, 2nd ed., ed. D. Cicchetti and D. J. Cohen, 673–700. Hoboken, NJ: Wiley.
- Bergman, L. R., A. von Eye, and D. Magnusson. 2006. Person-oriented research strategies in developmental psychopathology. In *Developmental psychopathology, vol. 1, theory and method*, 2nd ed., ed. D. Cicchetti and D. J. Cohen, 850–88. Hoboken, NJ: Wiley.
- Johnston, L. D., P. M. O'Malley, J. G. Bachman, and J. E. Schulenberg. 2006. *Monitoring the Future: National results on adolescent drug use; Overview of key findings, 2005* (NIH publication no. 06-5882). Bethesda, MD: US Department of Health and Human Services, National Institutes of Health, National Institute on Drug Abuse. <http://www.monitoringthefuture.org/pubs/monographs/overview2005.pdf>.
- Chassin, L., C. C. Presson, J. S. Rose, and S. J. Sherman. 1996. The natural history of cigarette smoking from adolescence to adulthood: Demographic predictors of continuity and change. *Health Psychology* 15 (6): 478–84.
- Chen, K., and D. B. Kandel. 1995. The natural history of drug use from adolescence to the mid-thirties in a general population sample. *American Journal of Public Health* 85 (1): 41–47.
- Fagerström, K. O. 1978. Measuring degree of physical dependence to tobacco smoking with reference to individualization of treatment. *Addictive Behaviors* 3 (3–4): 235–41.
- American Psychiatric Association. 1994. *Diagnostic and statistical manual of mental disorders: DSM-IV*. 4th ed. Washington, DC: American Psychiatric Association.
- Kandel, D., C. Schaffran, P. Griesler, J. Samuolis, M. Davies, and R. Galanti. 2005. On the measurement of nicotine dependence in adolescence: Comparisons of the mFTQ and a DSM-IV-based scale. *Journal of Pediatric Psychology* 30 (4): 319–32.
- Chung, T., C. S. Martin, and K. C. Winters. 2005. Diagnosis, course, and assessment of alcohol abuse and dependence in adolescents. *Recent Developments in Alcoholism* 17:5–27.
- Colby, S. M., S. T. Tiffany, S. Shiffman, and R. S. Niaura. 2000. Are adolescent smokers dependent on nicotine? A review of the evidence. *Drug and Alcohol Dependence* 59 Suppl. 1: S83–S95.
- O'Loughlin, J., J. DiFranza, R. F. Tyndale, G. Meshefedjian, E. McMillan-Davey, P. B. Clarke, J. Hanley, and G. Paradis. 2003. Nicotine-dependence symptoms

- are associated with smoking frequency in adolescents. *American Journal of Preventive Medicine* 25 (3): 219–25.
21. Kandel, D. B., M. C. Hu, P. C. Griesler, and C. Schaffran. 2007. On the development of nicotine dependence in adolescence. *Drug and Alcohol Dependence* 91 (1): 26–39.
 22. Hughes, J. R. 2007. Effects of abstinence from tobacco: etiology, animal models, epidemiology, and significance: a subjective review. *Nicotine & Tobacco Research* 9 (3): 329–39.
 23. Rojas, N. L., J. D. Killen, K. F. Haydel, and T. N. Robinson. 1998. Nicotine dependence among adolescent smokers. *Archives of Pediatrics & Adolescent Medicine* 152 (2): 151–56.
 24. Killen, J. D., S. Ammerman, N. Rojas, J. Varady, F. Haydel, and T. N. Robinson. 2001. Do adolescent smokers experience withdrawal effects when deprived of nicotine? *Experimental and Clinical Psychopharmacology* 9 (2): 176–82.
 25. Prokhorov, A. V., K. S. Hudmon, P. M. Cinciripini, and S. Marani. 2005. “Withdrawal symptoms” in adolescents: A comparison of former smokers and never-smokers. *Nicotine & Tobacco Research* 7 (6): 909–13.
 26. Breslau, N., E. O. Johnson, E. Hiripi, and R. Kessler. 2001. Nicotine dependence in the United States: Prevalence, trends, and smoking persistence. *Archives of General Psychiatry* 58 (9): 810–16.
 27. Gervais, A., J. O’Loughlin, G. Meshefedjian, C. Bancej, and M. Tremblay. 2006. Milestones in the natural course of onset of cigarette use among adolescents. *Canadian Medical Association Journal* 175 (3): 255–61.
 28. DiFranza, J. R., J. A. Savageau, N. A. Rigotti, K. Fletcher, J. K. Ockene, A. D. McNeill, M. Coleman, and C. Wood. 2002. Development of symptoms of tobacco dependence in youths: 30 month follow up data from the DANDY study. *Tobacco Control* 11 (3): 228–35.
 29. Dierker, L. C., E. Donny, S. Tiffany, S. M. Colby, N. Perrine, and R. R. Clayton. 2007. The association between cigarette smoking and DSM-IV nicotine dependence among first year college students. *Drug and Alcohol Dependence* 86 (2–3): 106–14.
 30. Kandel, D. B., and K. Chen. 2000. Extent of smoking and nicotine dependence in the United States: 1991–1993. *Nicotine & Tobacco Research* 2 (3): 263–74.
 31. O’Connor, R. J., G. A. Giovino, L. T. Kozlowski, S. Shiffman, A. Hyland, J. T. Bernert, R. S. Caraballo, and K. M. Cummings. 2006. Changes in nicotine intake and cigarette use over time in two nationally representative cross-sectional samples of smokers. *American Journal of Epidemiology* 164 (8): 750–5.
 32. Chassin, L., C. C. Presson, S. J. Sherman, and K. Kim. 2003. Historical changes in cigarette smoking and smoking-related beliefs after 2 decades in a midwestern community. *Health Psychology* 22 (4): 347–53.
 33. Levin, E. D., A. H. Rezvani, D. Montoya, J. E. Rose, and H. S. Swartzwelder. 2003. Adolescent-onset nicotine self-administration modeled in female rats. *Psychopharmacology (Berl)* 169 (2): 141–49.
 34. Adriani, W., S. Macri, R. Pacifici, and G. Laviola. 2002. Peculiar vulnerability to nicotine oral self-administration in mice during early adolescence. *Neuropsychopharmacology* 27 (2): 212–14.
 35. Belluzzi, J. D., A. G. Lee, H. S. Oliff, and F. M. Leslie. 2004. Age-dependent effects of nicotine on locomotor activity and conditioned place preference in rats. *Psychopharmacology (Berl)* 174 (3): 389–95.
 36. Faraday, M. M., B. M. Elliott, and N. E. Grunberg. 2001. Adult vs. adolescent rats differ in biobehavioral responses to chronic nicotine administration. *Pharmacology, Biochemistry, and Behavior* 70 (4): 475–89.
 37. Rezvani, A. H., and E. D. Levin. 2004. Adolescent and adult rats respond differently to nicotine and alcohol: Motor activity and body temperature. *International Journal of Developmental Neuroscience* 22 (5–6): 349–54.
 38. O’Dell, L. E., A. W. Bruijnzeel, S. Ghosland, A. Markou, and G. F. Koob. 2004. Nicotine withdrawal in adolescent and adult rats. *Annals of the New York Academy of Sciences* 1021:167–74.
 39. Abreu-Villaca, Y., F. J. Seidler, D. Qiao, C. A. Tate, M. M. Cousins, I. Thillai, and T. A. Slotkin. 2003. Short-term adolescent nicotine exposure has immediate and persistent effects on cholinergic systems: Critical periods, patterns of exposure, dose thresholds. *Neuropsychopharmacology* 28 (11): 1935–49.

5. Developmental Trajectories of Cigarette Smoking

40. Olmstead, M. C. 2006. Animal models of drug addiction: Where do we go from here? *Quarterly Journal of Experimental Psychology (Colchester)* 59 (4): 625–53.
41. Spear, L. P., and E. I. Varlinskaya. 2005. Adolescence. Alcohol sensitivity, tolerance, and intake. *Recent Developments in Alcoholism* 17:143–59.
42. Steinberg, L. 2004. Risk taking in adolescence: What changes, and why? *Annals of the New York Academy of Sciences* 1021:51–58.
43. Jessor, R., and S. L. Jessor. 1977. *Problem behavior and psychosocial development: A longitudinal study of youth*. New York: Academic Press.
44. Schulenberg, J. E., A. J. Sameroff, and D. Cicchetti. 2004. The transition to adulthood as a critical juncture in the course of psychopathology and mental health. *Development and Psychopathology* 16 (4): 799–806.
45. Bachman, J. G., K. N. Wadsworth, P. M. O'Malley, L. D. Johnston, and J. E. Schulenberg. 1997. *Smoking, drinking, and drug use in young adulthood: The impacts of new freedoms and new responsibilities*. Mahwah, NJ: Lawrence Erlbaum.
46. Avenevoli, S., and K. R. Merikangas. 2003. Familial influences on adolescent smoking. *Addiction* 98 Suppl. 1: 1–20.
47. Conrad, K. M., B. R. Flay, and D. Hill. 1992. Why children start smoking cigarettes: Predictors of onset. *British Journal of Addiction* 87 (12): 1711–24.
48. Bauman, K. E., V. A. Foshee, M. A. Linzer, and G. G. Koch. 1990. Effect of parental smoking classification on the association between parental and adolescent smoking. *Addictive Behaviors* 15 (5): 413–22.
49. Hopfer, C. J., T. J. Crowley, and J. K. Hewitt. 2003. Review of twin and adoption studies of adolescent substance use. *Journal of the American Academy of Child & Adolescent Psychiatry* 42 (6): 710–19.
50. McGue, M., I. Elkins, and W. G. Iacono. 2000. Genetic and environmental influences on adolescent substance use and abuse. *American Journal of Medical Genetics* 96 (5): 671–77.
51. Han, C., M. K. McGue, and W. G. Iacono. 1999. Lifetime tobacco, alcohol and other substance use in adolescent Minnesota twins: Univariate and multivariate behavioral genetic analyses. *Addiction* 94 (7): 981–93.
52. Rhee, S. H., J. K. Hewitt, S. E. Young, R. P. Corley, T. J. Crowley, and M. C. Stallings. 2003. Genetic and environmental influences on substance initiation, use, and problem use in adolescents. *Archives of General Psychiatry* 60 (12): 1256–64.
53. Kendler, K. S., E. Schmitt, S. H. Aggen, and C. A. Prescott. 2008. Genetic and environmental influences on alcohol, caffeine, cannabis, and nicotine use from early adolescence to middle adulthood. *Archives of General Psychiatry* 65 (6): 642–82.
54. Koopmans, J. R., W. S. Slutske, G. C. van Baal, and D. I. Boomsma. 1999. The influence of religion on alcohol use initiation: Evidence for genotype X environment interaction. *Behavior Genetics* 29 (6): 445–53.
55. Rende, R., and I. Waldman. 2006. Behavioral and molecular genetics and developmental psychopathology. In *Developmental Psychopathology, vol. 1, theory and method*, 2nd ed., ed. D. Cicchetti and D. J. Cohen, 427–64. Hoboken, NJ: Wiley.
56. Chassin, L., C. C. Presson, S. C. Pitts, and S. J. Sherman. 2000. The natural history of cigarette smoking from adolescence to adulthood in a midwestern community sample: Multiple trajectories and their psychosocial correlates. *Health Psychology* 19 (3): 223–31.
57. Maes, H. H., P. F. Sullivan, C. M. Bulik, M. C. Neale, C. A. Prescott, L. J. Eaves, and K. S. Kendler. 2004. A twin study of genetic and environmental influences on tobacco initiation, regular tobacco use and nicotine dependence. *Psychological Medicine* 34 (7): 1251–61.
58. White, V. M., J. L. Hopper, A. J. Wearing, and D. J. Hill. 2003. The role of genes in tobacco smoking during adolescence and young adulthood: A multivariate behaviour genetic investigation. *Addiction* 98 (8): 1087–1100.
59. Rende, R., C. Slomkowski, J. McCaffery, E. E. Lloyd-Richardson, and R. Niaura. 2005. A twin-sibling study of tobacco use in adolescence: Etiology of individual differences and extreme scores. *Nicotine & Tobacco Research* 7 (3): 413–19.
60. Farkas, A. J., E. A. Gilpin, M. M. White, and J. P. Pierce. 2000. Association between household and workplace smoking restrictions and adolescent smoking. *JAMA*:

- The Journal of the American Medical Association* 284 (6): 7171–22.
61. Boomsma, D. I., J. R. Koopmans, L. J. Van Doornen, and J. F. Orlebeke. 1994. Genetic and social influences on starting to smoke: A study of Dutch adolescent twins and their parents. *Addiction* 89 (2): 219–26.
 62. Timberlake, D. S., S. H. Rhee, B. C. Haberstick, C. Hopfer, M. Ehringer, J. M. Lessem, A. Smolen, and J. K. Hewitt. 2006. The moderating effects of religiosity on the genetic and environmental determinants of smoking initiation. *Nicotine & Tobacco Research* 8 (1): 123–33.
 63. Young, S. E., S. H. Rhee, M. C. Stallings, R. P. Corley, and J. K. Hewitt. 2006. Genetic and environmental vulnerabilities underlying adolescent substance use and problem use: General or specific? *Behavior Genetics* 36 (4): 603–15.
 64. McGue, M., W. G. Iacono, and R. Krueger. 2006. The association of early adolescent problem behavior and adult psychopathology: A multivariate behavioral genetic perspective. *Behavior Genetics* 36 (4): 591–602.
 65. Audrain-McGovern, J., C. Lerman, E. P. Wileyto, D. Rodriguez, and P. G. Shields. 2004. Interacting effects of genetic predisposition and depression on adolescent smoking progression. *American Journal of Psychiatry* 161 (7): 1224–30.
 66. Anney, R. J., C. A. Olsson, M. Lotfi-Miri, G. C. Patton, and R. Williamson. 2004. Nicotine dependence in a prospective population-based study of adolescents: The protective role of a functional tyrosine hydroxylase polymorphism. *Pharmacogenetics* 14 (2): 73–81.
 67. Olsson, C., R. Anney, S. Forrest, G. Patton, C. Coffey, T. Cameron, A. Hassett, and R. Williamson. 2004. Association between dependent smoking and a polymorphism in the tyrosine hydroxylase gene in a prospective population-based study of adolescent health. *Behavior Genetics* 34 (1): 85–91.
 68. Laucht, M., K. Becker, M. El-Faddagh, E. Hohm, and M. H. Schmidt. 2005. Association of the DRD4 exon III polymorphism with smoking in fifteen-year-olds: A mediating role for novelty seeking? *Journal of the American Academy of Child & Adolescent Psychiatry* 44 (5): 477–84.
 69. Skowronek, M. H., M. Laucht, E. Hohm, K. Becker, and M. H. Schmidt. 2006. Interaction between the dopamine D4 receptor and the serotonin transporter promoter polymorphisms in alcohol and tobacco use among 15-year-olds. *Neurogenetics* 7 (4): 239–46.
 70. Gerra, G., L. Garofano, A. Zaimovic, G. Moi, B. Branchi, M. Bussandri, F. Brambilla, and C. Donnini. 2005. Association of the serotonin transporter promoter polymorphism with smoking behavior among adolescents. *American Journal of Medical Genetics Part B, Neuropsychiatric Genetics* 135 (1): 73–78.
 71. O’Loughlin, J., G. Paradis, W. Kim, J. DiFranza, G. Meshfedjian, E. McMillan-Davey, S. Wong, J. Hanley, and R. F. Tyndale. 2004. Genetically decreased CYP2A6 and the risk of tobacco dependence: A prospective study of novice smokers. *Tobacco Control* 13 (4): 422–28.
 72. Audrain-McGovern, J., N. Al Koudsi, D. Rodriguez, E. P. Wileyto, P. G. Shields, and R. F. Tyndale. 2007. The role of CYP2A6 in the emergence of nicotine dependence in adolescents. *Pediatrics* 119 (1): e264–e274.
 73. Carter, B., T. Long, and P. Cinciripini. 2004. A meta-analytic review of the CYP2A6 genotype and smoking behavior. *Nicotine & Tobacco Research* 6 (2): 221–27.
 74. Lessov, C. N., G. E. Swan, H. Z. Ring, T. V. Khroyan, and C. Lerman. 2004. Genetics and drug use as a complex phenotype. *Substance Use and Misuse* 39 (10–12): 1515–69.
 75. Moffitt, T. E. 1993. Adolescence-limited and life-course-persistent antisocial behavior: A developmental taxonomy. *Psychological Review* 100 (4): 674–701.
 76. Moffitt, T. E., A. Caspi, H. Harrington, and B. J. Milne. 2002. Males on the life-course-persistent and adolescence-limited antisocial pathways: Follow-up at age 26 years. *Development and Psychopathology* 14 (1): 179–207.
 77. Breslau, N., and E. L. Peterson. 1996. Smoking cessation in young adults: Age at initiation of cigarette smoking and other suspected influences. *American Journal of Public Health* 86 (2): 214–20.
 78. Riggs, N. R., C. P. Chou, C. Li, and M. A. Pentz. 2007. Adolescent to emerging adulthood smoking trajectories: When do smoking trajectories diverge, and do they predict early adulthood nicotine dependence? *Nicotine & Tobacco Research* 9 (11): 1147–54.

5. Developmental Trajectories of Cigarette Smoking

79. Bernat, D. H., D. J. Erickson, R. Widome, C. L. Perry, and J. L. Forster. 2008. Adolescent smoking trajectories: Results from a population-based cohort study. *Journal of Adolescent Health* 43 (4): 334–40.
80. Vitaro, F., B. Wanner, M. Brendgen, C. Gosselin, and P. L. Gendreau. 2004. Differential contribution of parents and friends to smoking trajectories during adolescence. *Addictive Behaviors* 29 (4): 831–35.
81. Boms, U., K. Silventoinen, P. A. Madden, A. C. Heath, and J. Kaprio. 2006. Genetic architecture of smoking behavior: A study of Finnish adult twins. *Twin Research and Human Genetics* 9 (1): 64–72.
82. Heath, A. C., K. M. Kirk, J. M. Meyer, and N. G. Martin. 1999. Genetic and social determinants of initiation and age at onset of smoking in Australian twins. *Behavior Genetics* 29 (6): 395–407.
83. Ling, D., T. Niu, Y. Feng, H. Xing, and X. Xu. 2004. Association between polymorphism of the dopamine transporter gene and early smoking onset: An interaction risk on nicotine dependence. *Journal of Human Genetics* 49 (1): 35–39.
84. Upadhyaya, H. P., D. Deas, K. T. Brady, and M. Kruesi. 2002. Cigarette smoking and psychiatric comorbidity in children and adolescents. *Journal of the American Academy of Child & Adolescent Psychiatry* 41 (11): 1294–1305.
85. Lambert, N. M., and C. S. Hartsough. 1998. Prospective study of tobacco smoking and substance dependencies among samples of ADHD and non-ADHD participants. *Journal of Learning Disabilities* 31 (6): 533–44.
86. Molina, B. S., and W. E. Pelham Jr. 2003. Childhood predictors of adolescent substance use in a longitudinal study of children with ADHD. *Journal of Abnormal Psychology* 112 (3): 497–507.
87. Milberger, S., J. Biederman, S. V. Faraone, L. Chen, and J. Jones. 1997. ADHD is associated with early initiation of cigarette smoking in children and adolescents. *Journal of the American Academy of Child & Adolescent Psychiatry* 36 (1): 37–44.
88. Flory, K., and D. R. Lynam. 2003. The relation between attention deficit hyperactivity disorder and substance abuse: What role does conduct disorder play? *Clinical Child and Family Psychology Review* 6 (1): 1–16.
89. Costello, E. J., A. Erkanli, E. Federman, and A. Angold. 1999. Development of psychiatric comorbidity with substance abuse in adolescents: Effects of timing and sex. *Journal of Clinical Child Psychology* 28 (3): 298–311.
90. Kaplow, J. B., P. J. Curran, A. Angold, and E. J. Costello. 2001. The prospective relation between dimensions of anxiety and the initiation of adolescent alcohol use. *Journal of Clinical Child Psychology* 30 (3): 316–26.
91. Johnson, E. O., and L. Schultz. 2005. Forward telescoping bias in reported age of onset: An example from cigarette smoking. *International Journal of Methods in Psychiatric Research* 14 (3): 119–29.
92. Parra, G. R., S. E. O'Neill, and K. J. Sher. 2003. Reliability of self-reported age of substance involvement onset. *Psychology of Addictive Behaviors* 17 (3): 211–18.
93. Yoon, H. H., W. G. Iacono, S. M. Malone, and M. McGue. 2006. Using the brain P300 response to identify novel phenotypes reflecting genetic vulnerability for adolescent substance misuse. *Addictive Behaviors* 31 (6): 1067–87.
94. Donny, E. C., S. T. Lanza, R. L. Balster, L. M. Collins, A. Caggiula, and P. P. Rowell. 2004. Using growth models to relate acquisition of nicotine self-administration to break point and nicotinic receptor binding. *Drug and Alcohol Dependence* 75 (1): 23–35.
95. Eissenberg, T., and R. L. Balster. 2000. Initial tobacco use episodes in children and adolescents: Current knowledge, future directions. *Drug and Alcohol Dependence* 59 Suppl. 1: S41–S60.
96. Chen, X., A. Stacy, H. Zheng, J. Shan, D. Spruijt-Metz, J. Unger, J. Gong, et al. 2003. Sensations from initial exposure to nicotine predicting adolescent smoking in China: A potential measure of vulnerability to nicotine. *Nicotine & Tobacco Research* 5 (4): 455–63.
97. DiFranza, J. R., J. A. Savageau, K. Fletcher, J. K. Ockene, N. A. Rigotti, A. D. McNeill, M. Coleman, and C. Wood. 2004. Recollections and repercussions of the first inhaled cigarette. *Addictive Behaviors* 29 (2): 261–72.
98. Hirschman, R. S., H. Leventhal, and K. Glynn. 1984. The development of smoking behavior: Conceptualization and supportive cross-sectional survey data. *Journal of Applied Social Psychology* 14 (3): 184–206.

99. Hu, M. C., B. Muthén, C. Schaffran, P. C. Griesler, and D. B. Kandel. 2008. Developmental trajectories of criteria of nicotine dependence in adolescence. *Drug and Alcohol Dependence* 98 (1–2): 94–104.
100. Abroms, L., B. Simons-Morton, D. L. Haynie, and R. Chen. 2005. Psychosocial predictors of smoking trajectories during middle and high school. *Addiction* 100 (6): 852–61.
101. Colder, C. R., P. D. Mehta, K. Balanda, R. T. Campbell, K. Mayhew, W. R. Stanton, M. Pentz, and B. R. Flay. 2001. Identifying trajectories of adolescent smoking: An application of latent growth mixture modeling. *Health Psychology* 20 (2): 127–35.
102. Juon, H. S., M. E. Ensminger, and K. D. Sydnor. 2002. A longitudinal study of developmental trajectories to young adult cigarette smoking. *Drug and Alcohol Dependence* 66 (3): 303–14.
103. Soldz, S., and X. Cui. 2002. Pathways through adolescent smoking: A 7-year longitudinal grouping analysis. *Health Psychology* 21 (5): 495–504.
104. White, H. R., R. J. Pandina, and P. H. Chen. 2002. Developmental trajectories of cigarette use from early adolescence into young adulthood. *Drug and Alcohol Dependence* 65 (2): 167–78.
105. Audrain-McGovern, J., D. Rodriguez, K. P. Tercyak, J. Cuevas, K. Rodgers, and F. Patterson. 2004. Identifying and characterizing adolescent smoking trajectories. *Cancer Epidemiology, Biomarkers & Prevention* 13 (12): 2023–34.
106. Orlando, M., J. S. Tucker, P. L. Ellickson, and D. J. Klein. 2004. Developmental trajectories of cigarette smoking and their correlates from early adolescence to young adulthood. *Journal of Consulting and Clinical Psychology* 72 (3): 400–410.
107. Stanton, W. R., B. R. Flay, C. R. Colder, and P. Mehta. 2004. Identifying and predicting adolescent smokers' developmental trajectories. *Nicotine & Tobacco Research* 6 (5): 843–52.
108. White, H. R., D. Nagin, E. Replogle, and M. Stouthamer-Loeber. 2004. Racial differences in trajectories of cigarette use. *Drug and Alcohol Dependence* 76 (3): 219–27.
109. Karp, I., J. O'Loughlin, G. Paradis, J. Hanley, and J. DiFranza. 2005. Smoking trajectories of adolescent novice smokers in a longitudinal study of tobacco use. *Annals of Epidemiology* 15 (6): 445–52.
110. Brook, J. S., K. Pahl, and Y. Ning. 2006. Peer and parental influences on longitudinal trajectories of smoking among African Americans and Puerto Ricans. *Nicotine & Tobacco Research* 8 (5): 639–51.
111. Maggi, S., C. Hertzman, and T. Vaillancourt. 2007. Changes in smoking behaviors from late childhood to adolescence: Insights from the Canadian National Longitudinal Survey of Children and Youth. *Health Psychology* 26 (2): 232–40.
112. Maggi, S. 2008. Changes in smoking behaviours from late childhood to adolescence: 4 years later. *Drug and Alcohol Dependence* 94 (1–3): 251–53.
113. Lessov-Schlaggar, C. N., H. Hops, J. Brigham, K. S. Hudmon, J. A. Andrews, E. Tildesley, D. McBride, L. M. Jack, H. S. Javitz, and G. E. Swan. 2008. Adolescent smoking trajectories and nicotine dependence. *Nicotine & Tobacco Research* 10 (2): 341–51.
114. Wills, T. A., J. A. Resko, M. G. Ainette, and D. Mendoza. 2004. Smoking onset in adolescence: A person-centered analysis with time-varying predictors. *Health Psychology* 23 (2): 158–67.
115. Zucker, R. A. 1986. The four alcoholisms: A developmental account of the etiologic process. *Nebraska Symposium on Motivation* 34:27–83.
116. Blitstein, J. L., L. A. Robinson, D. M. Murray, R. C. Klesges, and S. M. Zbikowski. 2003. Rapid progression to regular cigarette smoking among nonsmoking adolescents: Interactions with gender and ethnicity. *Preventive Medicine* 36 (4): 455–63.
117. Curran, P. J., and M. T. Willoughby. 2003. Implications of latent trajectory models for the study of developmental psychopathology. *Development and Psychopathology* 15 (3): 581–612.
118. Wohlwill, J. F. 1991. Relations between method and theory in developmental research: A partial-isomorphism view. In *Annals of Theoretical Psychology*, vol. 7, ed. P. van Geert and L. P. Mos, 91–138.
119. Rogosa, D. R., and J. B. Willett. 1985. Understanding correlates of change by modeling individual differences in growth. *Psychometrika* 50 (2): 203–28.
120. Bauer, D. J. 2003. Estimating multilevel linear models as structural equation models. *Journal of Educational and Behavioral Statistics* 28 (2): 135–67.

5. Developmental Trajectories of Cigarette Smoking

121. Curran, P. J. 2003. Have multilevel models been structural equation models all along? *Multivariate Behavioral Research* 38 (4): 529–69.
122. Mehta, P. D., and M. C. Neale. 2005. People are variables too: Multilevel structural equations modeling. *Psychological Methods* 10 (3): 259–84.
123. Raudenbush, S. W. 2001. Toward a coherent framework for comparing trajectories of individual change. In *New methods for the analysis of change*, ed. L. M. Collins and A. G. Sayer, 35–64. Washington, DC: American Psychological Association.
124. Willett, J. B., and A. G. Sayer. 1994. Using covariance structure analysis to detect correlates and predictors of individual change over time. *Psychological Bulletin* 116 (2): 363–81.
125. Bryk, A. S., and S. W. Raudenbush. 1987. Application of hierarchical linear models to assessing change. *Psychological Bulletin* 101 (1): 147–58.
126. Meredith, W., and J. Tisak. 1990. Latent curve analysis. *Psychometrika* 55 (1): 107–22.
127. McArdle, J. J. 1988. Dynamic but structural equation modeling of repeated measures data. In *The handbook of multivariate experimental psychology*, vol. 2, ed. J. R. Nesselroade and R. B. Cattell, 561–614. New York: Plenum Press.
128. McArdle, J. J. 1989. Structural modeling experiments using multiple growth functions. In *Learning and individual differences: Abilities, motivation and methodology*, ed. P. Ackerman, R. Cudeck, and R. Kanfer, 71–117. Hillsdale, NJ: Lawrence Erlbaum.
129. McArdle, J. J. 1991. Structural models of developmental theory in psychology. In *Annals of Theoretical Psychology*, vol. VII, ed. P. Van Geert and L. P. Mos, 139–60. New York: Plenum Press.
130. Bollen, K. A., and P. J. Curran. 2005. *Latent curve models: A structural equation perspective*. Hoboken, NJ: Wiley.
131. Muthén, B. O., and P. J. Curran. 1997. General longitudinal modeling of individual differences in experimental designs: A latent variable framework for analysis and power estimation. *Psychological Methods* 2 (4): 371–702.
132. Muthén, B. O., and K. Shedden. 1999. Finite mixture modeling with mixture outcomes using the EM algorithm. *Biometrics* 55 (2): 463–69.
133. Nagin, D. S. 1999. Analyzing developmental trajectories: A semiparametric, group-based approach. *Psychological Methods* 4 (2): 139–57.
134. Bauer, D. J., and P. J. Curran. 2003. Distributional assumptions of growth mixture models: Implications for overextraction of latent trajectory classes. *Psychological Methods* 8 (3): 338–63.
135. Bauer, D. J., and P. J. Curran. 2004. The integration of continuous and discrete latent variable models: potential problems and promising opportunities. *Psychological Methods* 9 (1): 3–29.
136. Muthén, B. O. 2004. Latent variable analysis: Growth mixture modeling and related techniques for longitudinal data. In *Handbook of quantitative methodology for the social sciences*, ed. D. Kaplan, 345–68. Newbury Park, CA: Sage Publications.
137. Nagin, D. S. 2005. *Group-based modeling of development*. Cambridge, MA: Harvard University Press.
138. Muthén, B. O. 1989. Latent variable modeling in heterogeneous populations. *Psychometrika* 54:557–85.
139. MacQueen, J. B. 1967. Some methods for classification and analysis of multivariate observations. In *Proceedings of 5th Berkeley Symposium on Mathematical Statistics and Probability*, vol. 1, 281–97. Berkeley, CA: Univ. of California Press.
140. Clogg, C. C. 1995. Latent class models. In *Handbook of statistical modeling for the social and behavioral sciences*, ed. G. Arminger, C. C. Clogg, and M. E. Sobel, 311–59. New York: Plenum.
141. Lazarsfeld, P. F., and N. W. Henry. 1968. *Latent structure analysis*. Boston, MA: Houghton Mifflin.
142. McLachlan, G., and D. Peel. 2000. *Finite mixture models*. New York: John Wiley and Sons.
143. Arminger, G., and P. Stein. 1997. Finite mixtures of covariance structure models with regressors. *Sociological Methods & Research* 26 (2): 148–82.
144. Arminger, G., P. Stein, and J. Wittenberg. 1999. Mixtures of conditional mean- and covariance-structure models. *Psychometrika* 64 (4): 475–94.
145. Dolan, C. V., and H. L. J. van der Maas. 1998. Fitting multivariate normal finite mixtures

- subject to structural equation modeling. *Psychometrika* 63 (3): 227–53.
146. Gibson, W. A. 1959. Three multivariate models: Factor analysis, latent structure analysis, and latent profile analysis. *Psychometrika* 24 (3): 229–52.
147. Jedidi, K., H. S. Jagpal, and W. S. DeSarbo. 1997. Finite-mixture structural equation models for response-based segmentation and unobserved heterogeneity. *Marketing Science* 16 (1): 39–59.
148. Pearson, K. 1894. Contributions to the mathematical theory of evolution. *Philosophical Transactions of the Royal Society of London A* 185:71–110.
149. Yung, Y.-F. 1997. Finite mixtures in confirmatory factor-analysis models. *Psychometrika* 62 (3): 297–330.
150. Nagin, D. S., and K. C. Land. 1993. Age, criminal careers, and population heterogeneity: Specification and estimation of a nonparametric, mixed Poisson model. *Criminology* 31 (3): 327–62.
151. Nagin, D. S., and R. E. Tremblay. 2001. Analyzing developmental trajectories of distinct but related behaviors: A group-based method. *Psychological Methods* 6 (1): 18–34.
152. Lazarsfeld, P. F. 1950. Some latent structures. In *The American soldier: Studies in social psychology in World War II*, vol. 4, ed. S. A. Stouffer. Princeton, NJ: Princeton Univ. Press.
153. Muthén, B. O. 2001. Second-generation structural equation modeling with a combination of categorical and continuous latent variables: New opportunities for latent class/latent growth modeling. In *New methods for the analysis of change*, ed. L. M. Collins and A. Sayer, 291–322. Washington, DC: American Psychological Association.
154. Muthén, B. O. 2002. Beyond SEM: General latent variable modeling. *Behaviormetrika* 29 (1): 81–117.
155. Bauer, D. J., and P. J. Curran. 2003. Overextraction of latent trajectory classes: Much ado about nothing? *Psychological Methods* 8 (3): 384–93.
156. Muthén, B. O. 2003. Statistical and substantive checking in growth mixture modeling: Comment on Bauer and Curran (2003). *Psychological Methods* 8 (3): 369–77; discussion 384–93.
157. Nagin, D. S., and R. E. Tremblay. 2005. Developmental trajectory groups: Fact or a useful statistical fiction. *Criminology* 43 (4): 873–904.
158. Beauchaine, T. P., and E. Waters. 2003. Pseudotaxonicity in MAMBAC and MAXCOV analyses of rating-scale data: Turning continua into classes by manipulating observer's expectations. *Psychological Methods* 8 (1): 3–15.
159. Markon, K. E., and R. F. Krueger. 2006. Information-theoretic latent distribution modeling: Distinguishing discrete and continuous latent variable models. *Psychological Methods* 11 (3): 228–43.
160. Meehl, P. E. 1967. Theory-testing in psychology and physics: A methodological paradox. *Philosophy of Science* 34 (2): 103–15.
161. Meehl, P. E. 1968. *Detecting latent clinical taxa, II: A simplified procedure, some additional hitmax cut locators, a single-indicator method, and miscellaneous theorems* (Report No. PR-68-2). Minneapolis, MN: Univ. of Minnesota, Research Laboratories of the Department of Psychiatry.
162. Meehl, P. E. 1992. Factors and taxa, traits and types, differences of degree and differences in kind. *Journal of Personality* 60 (1): 117–74.
163. Waller, N. G., and P. E. Meehl. 1998. *Multivariate taxometric procedures: Distinguishing types from continua*. Thousand Oaks, CA: Sage.
164. Cudeck, R., and S. J. Henly. 2003. A realistic perspective on pattern representation in growth data: Comment on Bauer and Curran (2003). *Psychological Methods* 8 (3): 378–83; discussion 384–93.
165. Shaw, P., D. Greenstein, J. Lerch, L. Clasen, R. Lenroot, N. Gogtay, A. Evans, J. Rapoport, and J. Giedd. 2006. Intellectual ability and cortical development in children and adolescents. *Nature* 440 (7084): 676–79.
166. MacCallum, R. C. 2003. 2001 presidential address: Working with imperfect models. *Multivariate Behavioral Research* 38 (1): 113–39.
167. Eggleston, E. P., J. H. Laub, and R. J. Sampson. 2004. Methodological sensitivities to latent class analysis of long-term criminal trajectories. *Journal of Quantitative Criminology* 20 (1): 1–26.
168. Jackson, K. M., and K. J. Sher. 2006. Comparison of longitudinal phenotypes based on number and timing of assessments: A systematic comparison of trajectory

- approaches II. *Psychology of Addictive Behaviors* 20 (4): 373–84.
169. Olsen, M. K., and J. L. Schafer. 2001. A two-part random-effects model for semicontinuous longitudinal data. *Journal of the American Statistical Association* 96 (454): 730–45.
170. Chassin, L., C. C. Presson, M. Bensenberg, E. Corty, R. W. Olshavsky, and S. J. Sherman. 1981. Predicting adolescents' intentions to smoke cigarettes. *Journal of Health and Social Behavior* 22 (4): 445–55.
171. Chassin, L., C. C. Presson, S. J. Sherman, and D. A. Edwards. 1990. The natural history of cigarette smoking: Predicting young-adult smoking outcomes from adolescent smoking patterns. *Health Psychology* 9 (6): 701–16.
172. Lugaila, T. A. 1998. Marital status and living arrangements: March 1998 (update). Current Population Reports, vol. P20-514. Washington, DC: U.S. Government Printing Office. <http://www.census.gov/prod/99pubs/p20-514.pdf>.
173. Day, J. C., and A. E. Curry. 1998. Educational attainment in the United States: March 1998 (update). Current Population Reports, P20–513. Washington, DC: U.S. Government Printing Office. <http://www.census.gov/prod/3/98pubs/p20-513.pdf>.
174. Holtzman, D., E. Powell-Griner, J. C. Bolen, and L. Rhodes. 2000. State- and sex-specific prevalence of selected characteristics—Behavioral Risk Factor Surveillance System, 1996 and 1997. *Morbidity and Mortality Weekly Report* 49 (6): 1–39.
175. Rose, J. S., L. Chassin, C. C. Presson, and S. J. Sherman. 1996. Demographic factors in adult smoking status: Mediating and moderating influences. *Psychology of Addictive Behaviors* 10 (1): 28–37.
176. Jones, B. L., D. S. Nagin, and K. Roeder. 2001. A SAS procedure based on mixture models for estimating developmental trajectories. *Sociological Methods & Research* 29 (3): 374–93.
177. Schwarz, G. 1978. Estimating the dimension of a model. *Annals of Statistics* 6 (2): 461–64.
178. Akaike, H. 1973. Information theory and an extension of the maximum likelihood principle. In *Proceedings of the Second International Symposium on Information Theory*, ed. B. N. Petrov and F. Csaki, 267–81. Budapest: Akademiai Kiado.
179. Akaike, H. 1974. A new look at the statistical model identification. *IEEE Transactions on Automatic Control* 19 (6): 716–23.
180. Dolan, C. V., V. D. Schmittmann, G. H. Lubke, and M. C. Neale. 2005. Regime switching in the latent growth curve mixture model. *Structural Equation Modeling* 12 (1): 94–119.

6

Genetic Modeling of Tobacco Use Behavior and Trajectories

Hermine H. Maes and Michael C. Neale

Genetic studies have provided strong evidence that heritable factors generate individual differences in smoking behavior. Shared environmental factors appear to play a larger role in tobacco use at earlier ages. Improved modeling techniques hold the potential to better differentiate between genetic and environmental factors in tobacco use. This chapter examines genetic modeling issues in the study of smoking trajectories and behavior, including

- *Methodological and conceptual issues such as inferring potential dependence and trajectories in nonsmokers, issues in measurement invariance, and the use of epidemiological methods in genetically informative studies*
- *Statistical modeling considerations such as the use of structural equation modeling (SEM) to assess whether covariation between traits is due to genetic or environmental causes, the identification of genetic latent classes, and the analysis of molecular genetic data from linkage and association studies*
- *A review of prior genetic studies of smoking behavior, including twin and extended twin family studies, multivariate genetic studies, and molecular genetic studies*
- *A study applying an item response theory (IRT) approach to an analysis of smoking trajectories with data from the Virginia Twin Registry, examining tobacco initiation, regular tobacco use, and items on the modified version of the Fagerström Tolerance Questionnaire (FTQ)*

The IRT study in this chapter underscores the importance of assessing measurement invariance in establishing the heritability of nicotine dependence and its variation with gender.

The analyses described herein were supported by Public Health Service grant RR008123 and National Institute of Health grants CA085739, CA093423, DA011287, DA016977, DA018673, MH001458, MH049492, MH065322, MH068521, and a grant from the Virginia Tobacco Settlement Foundation. Mx development was previously supported by Public Health Service grants RR008123 and National Institute of Health grant MH001458. Data were kindly provided by Dr. Kenneth S. Kendler and the Mid-Atlantic Twin Registry.

Introduction

This chapter examines issues in studying the heritability of tobacco use behavior and trajectories and their methodological implications for future genetic research in nicotine dependence. Its goal is to follow the discussion of tobacco use trajectories in chapter 5 to examine what can be learned about these trajectories through studies using genetically informed data. Areas discussed include methodological and conceptual issues, a review of existing genetic studies of smoking, and the results from a multivariate genetic analysis of nicotine dependence using the Virginia Twin Registry.

A key question in many epidemiological studies is the extent to which parents influence their children. For example, one may ask whether parental cigarette smoking in and of itself increases the chance that their children will smoke. At the simplest level, one might compare the proportion of smokers in parents whose children smoke to the parents whose children do not. A higher rate of smoking in the parents of smokers may be taken as evidence that behavioral modeling is operating; that is, children have learned their behavior from their parents. Alternatively, it might be thought that the secondhand smoke ingested by the child of a smoker kindles the smoking habit. In practice, however, such conclusions may be unwarranted, because—except in the case of adoption—parents share genetic factors with their children. Genetically informative research designs, such as data collected from monozygotic and dizygotic twins, or from adopted and biological relatives, permit a closer inspection of the nature of parent-child resemblance, and indeed, of any association between a putative risk factor and an outcome. In principle, any random effect, such as variation in level or slope in a growth curve model, or membership in

a particular latent trajectory class, may be partitioned into genetic and environmental components. However, the value of data collected from family members does not end here. In addition to the potential to resolve genetic and environmental components of variance, it is possible to measure covariance between variables that cannot be measured with data from unrelated individuals. For example, one can test whether liability to initiate smoking is related to quantity smoked or propensity to become nicotine dependent. Such information is of particular value when one considers whether to expend efforts on the prevention of tobacco initiation or on the alteration of trajectories of tobacco consumption once initiation has occurred. Therefore, this chapter provides a review of these methods, with a view to integrating both molecular and nonmolecular approaches into the same framework.

First, some of the methodological and conceptual issues in tobacco use research are considered. A statistical framework is then discussed within which these issues may be tackled. The approach is general enough to encompass both latent trait and latent class models and is suited to a wide variety of both genetic and nongenetic analyses. This methodological review is followed by a substantive one, considering the findings of genetic studies of smoking initiation on nicotine dependence. The final section applies multivariate genetic analysis of tobacco use and nicotine-dependence symptoms to data collected from relatives in the Virginia Twin Registry. The results are described in more detail than those of published studies because these results integrate a focus on assessing the phenotype with the traditional partitioning of the variance of that phenotype into genetic and environmental sources. The analyses also take into account that nicotine dependence is contingent on smoking initiation and progression to regular smoking.

Methodological and Conceptual Issues

One of the problems with studying tobacco use is that many of the symptoms and signs of abuse or dependence are *contingent*. Thus, it is not possible to observe the rate of increase in use of cigarettes in those who have never smoked. Whether it is correct to regard the nonsmoker's increase in cigarette consumption as zero is an empirical question. There is an assumption that a nonsmoker does not experience symptoms of nicotine dependence. However, in trying to understand the population from an epidemiological perspective, it is often better to ask the question of whether a nonsmoker would have experienced symptoms of dependence if he or she had initiated cigarette use. Certain research designs permit such inferences. For example, data from pairs of siblings might show that nicotine-dependence symptoms are more common in individuals with a sibling who has also become a tobacco user than in those with a sibling who has not. Such data imply a relationship between initiation and dependence. Ordinarily, with data collected from unrelated individuals, it is typically not possible to assess the relationship between initiation and dependence symptoms because dependence data are missing in those who have not initiated. Therefore, the modeling of this contingent type of data is described.

A similar issue arises with the analysis of the relationship between age at onset of tobacco use and its sequelae, such as trajectory. While it is possible to compare trajectories of those who initiate at a young age to those who initiated at a later age, it remains impossible to examine the trajectories of those who have not initiated use. Again, a research design that includes data collected from relatives provides a framework within which the relationship between age at onset and liability to use may be estimated. In this

context, it becomes possible to tease apart factors that influence initiation, which, in turn, influences trajectory, from those that influence trajectory only.¹ In addition, it may prove useful to examine substance use as a function of time onset rather than of chronological age.²

One of the impediments to research on behavioral and psychological traits, such as tobacco use, is that behavior is intrinsically difficult to measure. For the most part, the quantification of daily tobacco use is limited to an ordinal scale (0, 1–5, 6–10, 11–20, 20+), and the assessment of symptoms of dependence is typically only binary (e.g., do you find it difficult to cut down?). Many of the more modern models for the analysis of growth or change have been developed on the assumption that measurement has been at the *interval* level. For the most part, it is not wise to simply pretend that the data have been measured on a continuous scale and proceed with data analysis as usual. However, it is often possible to extract continuous-level information from ordinal data by modeling it appropriately,³ although at the cost of additional computer time. Yet, even given an appropriate analytical framework for ordinal data, things can go wrong at the measurement level. For example, a questionnaire item—do you find it difficult to wait for your first cigarette of the day—may provide a good indicator of dependence for those attending high school if smoking at home is not permitted. Those who no longer live at home may never have to wait, and therefore, the question loses its relevance as a measure of dependence. Such failures of *measurement invariance* are important to detect and should be controlled wherever possible.^{4–7} That is, it is important to distinguish change in behavior or symptoms over time from change in the way that the measurement instrument works. This chapter examines this issue of measurement invariance with data from twins assessed with the FTQ.⁸

Many statistical frameworks are constructed around the assumption that the population is homogeneous in some respect. Thus, a simple regression equation, $y = \beta_0 + \beta_1 x$, implies that the effect of the independent variable x on the dependent variable y is the same for all subjects in the sample. In practice, however, it is possible that the strength of the regression—for example, between liability to initiate tobacco use and liability to progress to nicotine dependence—varies as a function of other variables. Such *moderation* of relationships may occur as a function of either variables that have been measured, such as age or gender, or of variables that have not been measured, such as an unidentified polymorphism at a particular region of the genome or the quantity of secondhand smoke experienced as a child.

Much progress has been made in tying together statistical methods used in epidemiological studies of unrelated individuals with those in use with genetically informative studies. For example, analyses of growth curves, measurement invariance, factor analysis, and latent class analysis all have been adapted and extended for use with data collected from relatives. Multilevel analysis might be considered to be almost ubiquitous in the study of relatives in that the family provides a level. However, it is clear that several areas have yet to be implemented for use in family data. For example, factor mixture modeling and growth curve transition modeling are in need of further development. While technical challenges remain (e.g., the likelihood of longitudinal ordinal data collected on a large pedigree may involve numerical integration over a very large number of dimensions), this is an area of active research. The future, with improvements in computer architecture and software that exploit it, holds much promise for furthering the understanding of genetic and environmental factors in the etiology, development, and interaction of complex traits.

Statistical Framework

Structural Equation Modeling

The majority of statistical modeling of genetically informative data is carried out within the framework of SEM. In its basic form, SEM involves the specification of two types of variables: (1) observed variables that have been directly measured and (2) latent variables that have not been directly measured. Two types of relationship between these variables may be specified: linear regression and covariance. This type of model may be represented as a path diagram^{9–11} in which observed variables are shown as boxes, latent variables are shown as circles, regression paths are drawn as single-headed arrows from the independent variable to the dependent variable, and covariance paths are shown as double-headed arrows. Any description of the model, be it a simple list of the paths involved, or matrices thereof, or a correctly drawn path diagram, is mathematically complete and can be used to derive predicted covariances between variables. Three extensions of this framework are becoming popular. One is the depiction of means,¹² usually drawn as a triangle that has a constant value of one, which enables specification of mean structure as well as of covariances.¹³ The second is the specification of “definition variables,” which are values attached to specific paths in the diagram. These may specify a different predicted covariance structure for every subject in the sample.¹⁴ They are thus of value in the specification of models for data that were collected at different sets of ages, as opposed to the unlikely scenario that, for example, all subjects were assessed precisely on their 10th, 12th, and 15th birthdays.¹⁵ The third extension is that the population may be described as a mixture of two or more subpopulations in which different mean and/or covariance structures exist. This third addition subsumes latent class and latent profile analyses as special cases; growth curve

mixture modeling is a popular example.^{16,17} This framework is referred to as “extended structural equation modeling” (i.e., XSEM).

Originally, SEM was devised for the analysis of data that were distributed according to the multivariate normal distribution, and it is still used in this way in many applications. The addition of mean structures, which may differ according to group or definition variables, makes the method appropriate for the analysis of data that are distributed according to a conditional multivariate normal distribution (the data from the sample as a whole will not be normally distributed if there are group mean differences). Applications to binary or ordinal data have become popular, because such data are commonly encountered in behavioral and other research. For the most part, these methods shift the distributional assumption to a level above the actual measurement, such that it is assumed that there is an underlying normal distribution of liability in the population, but that it is only possible to discriminate whether a given subject falls in a particular range or band of this distribution. For example, if a subject indicates that he or she has tried smoking cigarettes, as do some 60% of subjects, then the subject’s liability is assumed to be in the top 60% of the distribution, or above a threshold of -0.253 measured in z -score units. It turns out that with ordinal data with at least three categories, it is possible to estimate the same parameters as in the continuous case by fixing the first threshold at zero, the second threshold at one, and estimating the mean and variance of the measure instead.³ It is also possible to fit growth curves to binary item data,^{18,19} although item-specific variances are confounded with item means in this case.

Structural Equation Model for Twin Data

The basic path diagram for the analysis of data collected from pairs of monozygotic

and dizygotic twins—the most widely used genetically informative design²⁰—is shown in figure 6.1. The diagram includes three variance components: additive genetic factors (A), which correlate perfectly between monozygotic twins and .5 between dizygotic twins; common or shared environmental factors (C), which correlate perfectly between twins regardless of their zygosity; and random or specific environmental factors (E), which are those influences unique to each member of a twin pair (including measurement error and genotype by specific environment interaction). The key to identifying the parameters of this model (the regression paths a , c , and e) is the availability of three statistics: the variance, the covariance between monozygotic twins, and the covariance between dizygotic twins. These data, together with the equal environment assumption (for more details, consult, for example, Loehlin and Nichols,²¹ Rose and colleagues,²² and Kendler and colleagues²³ for theoretical and empirical reasons that the equal environment assumption is unlikely to be violated), allow unique estimates of the parameters to be obtained. Alternatively, one could include a dominance parameter (D) instead of shared environment; the effects of both are confounded in the classical twin design. It is important to note that the classical twin study is really just a starting point for the genetic epidemiological investigation of a trait. Extending the design to include, for example, adoptees, parents and offspring, half siblings, or more distant relatives allows for resolving a greater variety of genetic and environmental parameters, such as genetic nonadditivity and assortative mating,²⁴ which are assumed to be zero when fitting the ACE model. Other assumptions include no genotype by environment correlation or interaction. The power of the classical twin study has been described in detail for the continuous case²⁵ and the ordinal case.²⁶ Of note is that for ordinal data, three times the sample size is needed for equivalent

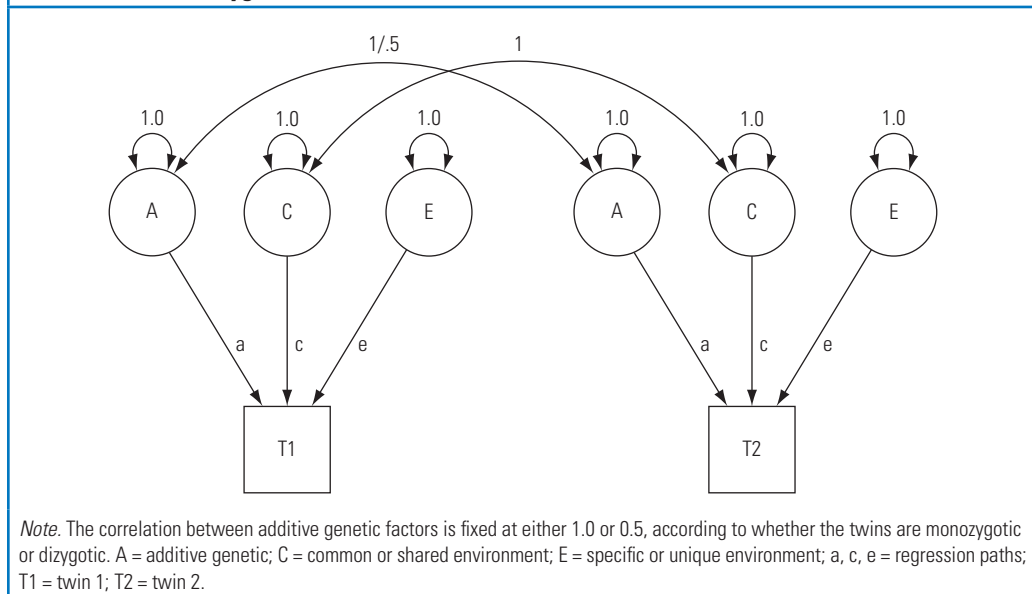
Figure 6.1 Basic Path Diagram for the Analysis of Data Collected from Pairs of Monozygotic and Dizygotic Twins

power to the continuous case when the threshold is at the optimal 50%, and this ratio increases rapidly for more extreme thresholds. In general, the twin study has more power to reject false models when the true world involved shared environmental effects than when familial aggregation was genetic. While false models that involve no familial aggregation are easy to reject, models including incorrectly specified sources of resemblance (e.g., AE instead of CE) are difficult to reject.

The basic ACE model can be straightforwardly extended to multivariate or longitudinal data. In the multivariate context, it becomes possible to partition *covariation* into the same components as is variation. Thus, one can establish whether two traits covary primarily because the same genetic factors influence both or because the same environmental factors do so. In addition, it is possible to detect relationships between variables that do not covary within an individual but, in fact, share genetic and environmental factors whose

influences counterbalance—for example, a correlation of +.7 due to environmental factors but −.7 because of genetic factors. This same partitioning of covariation between traits may be applied to the same trait measured on repeated occasions to address whether development and change have primarily genetic or environmental origins. Four specific extensions to this model are considered below.

Extensions of the Basic Twin Model

Extended Twin Family Studies

While twin studies provide an excellent design to disentangle genetic and shared environmental influences, several assumptions are made, and only a limited number of sources of variance can be estimated simultaneously (A, C, and E or A, D, and E, with C and D being confounded). Three statistics provide the information for the partition: the total phenotypic variance,

the monozygotic covariance, and the dizygotic covariance. Data from other types of relatives provide additional, qualitatively different statistics, which (subject to identification of the model) permit estimation of additional sources of variance. Conceptually, this approach is similar to that used in plant and animal breeding experiments in which different types of cross provide information about different types of genetic effect.²⁷ Early contributions to developing methods for the analysis of data from human populations were provided by Jencks,²⁸ Eaves and colleagues,^{29,30} and Fulker.³¹

Extending the twin design to include siblings allows a test of whether twins resemble each other more than do regular siblings. The usual way to model the addition of siblings is as a special twin environment variance component, T , for which twins (monozygotic or dizygotic) are specified to correlate perfectly, while siblings are specified to correlate with zero. Several potential contributors to a variance component are specified in this way. The most obvious source is twins who share trait-influencing environmental factors to a greater extent than do siblings. A second possibility is that twins influence each other, although typically this would result in different total variances of monozygotic, dizygotic, and siblings. A third potential contributor is interaction between age or cohort and the variable under study. Nontwin siblings are commonly measured at different ages and may therefore have reduced similarity compared with siblings measured at the same age and time. The addition of half siblings or adoptive siblings also permits estimation of genetic dominance as well as shared environmental influences—two sources that are confounded in the classical twin study.

Further extensions, such as including parents of twins, provide a test for the presence of assortative mating (process of mate selection based on the phenotype) and

cultural transmission or whether parents influence their children's behavior through environmental pathways in addition to passing on their genes. Different mechanisms could account for environmental transmission: (1) parents can influence the environment of their children directly; this is referred to as phenotypic cultural transmission (or P [phenotype] to C [shared environment] transmission); and (2) the parental environment directly influences the children's environment, which is known as social homogamy (C to C transmission). Similarly, assortment, evidenced through significant marital correlations, can be a function of the phenotypes of the spouses (phenotypic assortative mating). Alternatively, social homogamy may result in spousal concordance, or direct influence between the spouses may lead to increased similarity over time. The extended twin kinship model, which extends the classical twin study with not only siblings and parents but also spouses and children of twins, was developed³² for simultaneous estimation of additive and dominance genetic as well as unique and shared environmental (cultural transmission, nonparental, special twin) factors in the presence of assortment. The specification includes phenotypic cultural transmission and phenotypic assortative mating.³³ It is important to note that the correlation between parents and their children alone provides information to sort out whether parents directly influence their children's smoking behavior in that they also share genes with one another. However, a design that includes additional types of relatives (with differing degrees of genetic similarity), such as monozygotic and dizygotic twins, allows one to disentangle genetic from environmental transmission and “controls for” the genetic relatedness of parents and offspring.

Another design that also allows for disentangling genetic from environmental transmission is the children of twins (COT) design, which collects data from adult twin

pairs and their children (and possibly their spouses). One specific application relevant to tobacco use research is the comparison of the prevalence of smoking initiation in children and the parent-offspring correlation as a function of the smoking status of the parents: either nonsmoker, former smoker, or current smoker.

Multivariate Factor Model

A basic model for multivariate data collected from twins is shown for one member of a twin pair in figure 6.2. This model, known as a “latent phenotype” or “common pathway” model,^{34,35} includes three latent phenotypes (factors) that influence all the observed measures (shown in squares). It is a natural extension of a psychometric common factor model to twin data. All the

covariation between twins’ items occurs through correlations between the additive genetic (A) and common environment (C) latent variables in twin 1 and their counterparts in twin 2. These correlations are fixed, in accordance with genetic theory, at 1.0 for monozygotic twins for both A and C, and at .5 and 1.0 for A and C, respectively, in dizygotic twins. Note that residual or “measure-specific” covariation between an observed measure and that of the co-twin may occur through the A and C paths shown at the bottom of the figure. Also note that the variance components A, C, and E for factor 1 may correlate with their counterparts for factors 2 and 3. Thus, there is an analog of the oblique factor model in psychometrics.

An important submodel of this three-factor model is one in which the path coefficients

Figure 6.2 Three-Factor Latent Phenotype Model

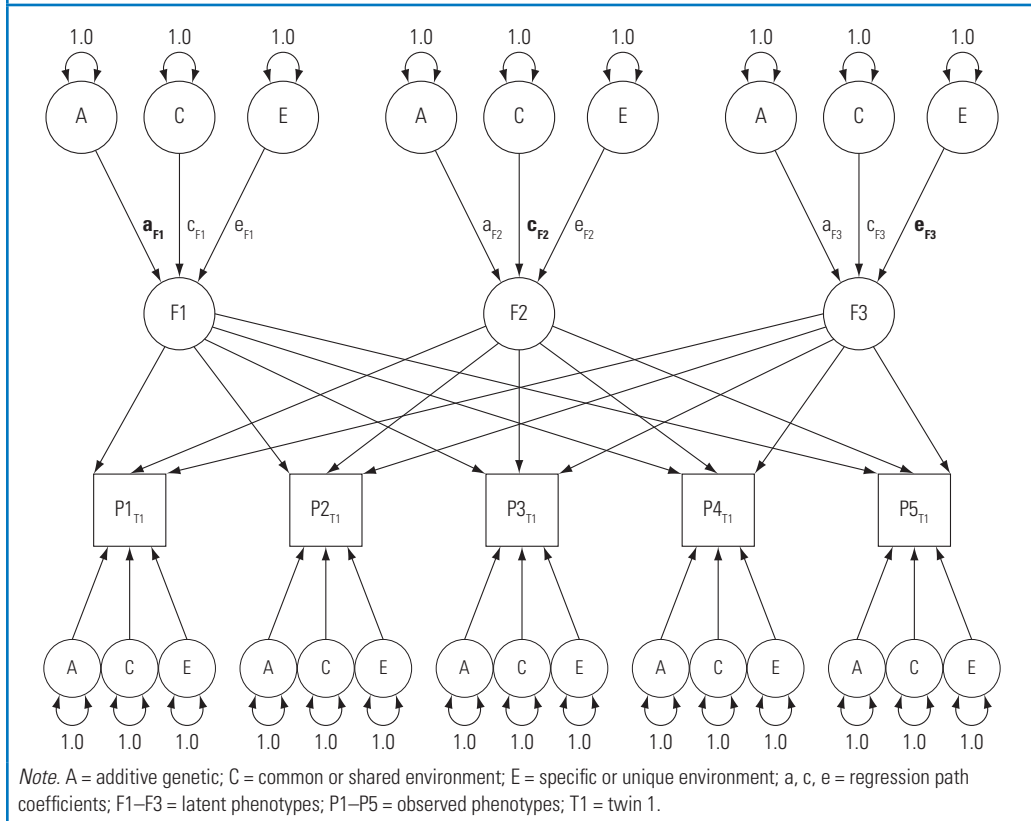

a_{F2} , a_{F3} , c_{F1} , c_{F3} , e_{F1} , and e_{F2} are fixed to zero, and the coefficients (a_{F1} , c_{F2} , and e_{F3}) are fixed to unity. This submodel, known as the “independent pathway” or “biometric factor” model,^{34,35} estimates loadings from variance components that are specified as having only one source of variation. Another important submodel is one in which only one latent phenotype is specified; that is, $F2$ and $F3$ are omitted. This model is often called the “common pathway” model, because the genetic and environmental components (at the top of the diagram) are combined into a latent common factor before they affect the measured variables.

Causal Contingent Common Pathway Model

To analyze contingent data, such as the presence of symptoms of nicotine dependence, for which nicotine use is prerequisite, a simplified bivariate model is used. The model is necessarily simplified because not all the data that would ordinarily identify a multivariate model for twin data are available. There is no information on the within-person covariance between initiation and progression because there is no variation in initiation when progression is

observed. However, it is possible to estimate the strength of this relationship in twin data because the co-twin data provide a proxy form of information about the relationship between progression and initiation. Thus, this information comes from discordant pairs; that is, one twin progresses from initiation but the co-twin does not progress. The diagram in figure 6.3 shows progression regressed onto initiation. Each variable has its own A, C, and E components, which are specific to either initiation or progression. All covariance between these two variables is assumed to arise via the regression path. This model has a number of extensions, including the multivariate case and more than two-stage phenomena.^{36,37} The key here is the use of twins to overcome the problem of systematically missing data, which is exploited in the application below in the section “Item Response Theory Approach: Application to Virginia Twin Registry Data.” Ordinarily, it is not possible to identify the loading of a binary initiation variable on a common factor when the remaining items that load on the factor (e.g., measures of dependence) are contingent on it. However, when data are collected from twins, and when the factors correlate, the model is identified.³⁸

Figure 6.3 Causal Contingent Common Pathway Model

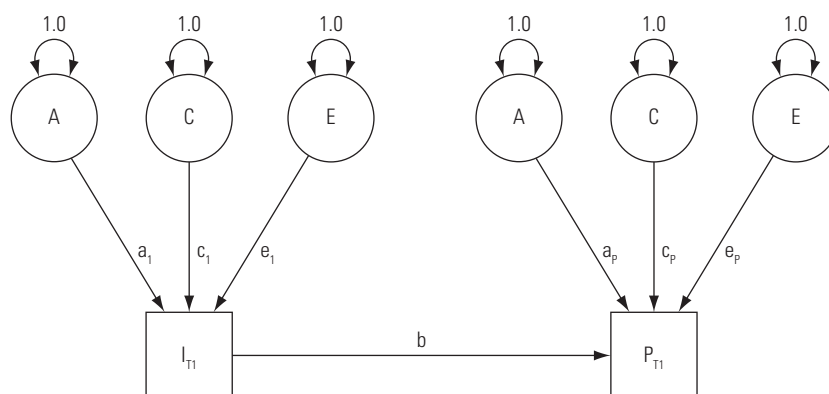

Note. A = additive genetic; C = common or shared environment; E = specific or unique environment; a, c, e, and b = regression path coefficients; I = initiation; P = progression; T1 = twin 1.

Item Response Theory

In both clinical practice and research, it is common practice to collect data on the presence or absence of multiple symptom criteria for a given disorder or trait. The item-level data are often collapsed into either a single affected versus unaffected classification or summarized into a score by summing the endorsed symptoms. For example, the Fagerström criteria are widely used to provide an nicotine-dependence score (either FTQ or Fagerström Test for Nicotine Dependence [FTND]) or a binary dependence diagnosis. Both types of summary statistic have problems. In the binary classification case, much of the available information is not utilized. The sum score approach assumes that the criteria are equally important. These assumptions can be tested in an item response framework. In addition, one can evaluate the role of potential covariates, such as gender and age, on the measurement of the phenotype of interest. For genetic studies, failure of these assumptions can lead to erroneous conclusions about the genetic architecture of the trait of interest. Lubke and Neale³⁹ noted that studies of genotype by environment interaction, including genotype by age and genotype by gender interactions, are subject to potential confounding of measurement artifacts when sum scores or diagnoses are analyzed. Since changes in heritability over time or across groups are fundamental to the genetic analysis of trajectories, it is a crucial first step to assess whether one is measuring the same construct at different times and with the same accuracy. Therefore, these methods are applied in the section below, “Item Response Theory Approach: Application to Virginia Twin Registry Data.”

Genetic Latent Growth Curve Models

Of particular interest to those studying trajectories of tobacco use is the information provided by structured latent growth curve (LGC) models. These models are described

in detail in chapter 5. Their treatment here is brief and focuses on their extension to genetically informative data,⁴⁰ nonlinear models, and switching. By way of preamble, the authors of this chapter support “putting the individual back in growth curves” as proposed by Mehta and West.¹⁵ That is, arbitrary categorization of subjects into age bands (e.g., 10 years old, 11 years old) should be avoided if possible, and the analysis should proceed at the raw data level with subjects’ actual ages at testing. This method eliminates the biases that can accrue when there is variation between subjects’ ages at a particular occasion of measurement. The LGC model is essentially a factor model with some specific restrictions. In the linear case, it is hypothesized that there is random variation in two factors: initial level and slope. These factors may be correlated. A natural extension of this model for genetically informative data is, therefore, to apply the variance and covariance partitioning to these latent variables. Thus, with twin data, one expects the variation in the level and slope factors to arise from the action of genetic and environmental (C or E) factors, and the covariance between level and slope can be partitioned in the same way. In addition, one can partition the residual occasion-specific variance into the three usual A, C, and E sources. Note, however, that this departs from the idea that the residual variance is purely random measurement error; such a model would eliminate the A and C components and may be fitted to explicitly test this hypothesis. Initial attempts to model growth data collected from relatives⁴¹ used a two-stage approach in which individual growth curves were estimated (to obtain person scores for level and slope), followed by biometric analysis of the scores themselves. This is a practical approach that is suitable when all subjects are measured at equal intervals. However, when data are missing or there is variation in the intervals between measurements, the individual growth curves will vary in their accuracy. The initial summary step does not

capture these differences in precision and therefore may yield biased or inaccurate estimates of the biometrical parameters. It is for this reason that one should prefer, whenever possible, single-step analysis of what has been measured.⁴²

A critical issue in LGC modeling is the assumption that growth is linear. While it is likely that the majority of variation in many traits will be captured by this component, it is unlikely to be the case for all traits, especially those measured over a wide range of ages. This was recognized as early as the eighteenth century by Malthus,⁴³ who developed mathematical equations for alternative growth curves. Fundamental work by Browne⁴⁴ provided methods to fit such nonlinear growth curves to data. Perhaps due, in part, to limitations of some of the popular software packages, such nonlinear growth curves have not proved popular.⁴⁴ Fitting such models is not technically difficult, even for the case of data from relatives⁴⁵ with very long time series; these are typically handled by using time series analysis.⁴⁶ Ecological momentary assessments, which may contain thousands of repeated measures for each individual, present an obvious technical challenge. Research in this area typically extracts summary statistics in a two-stage approach. While practical, there may be unwarranted or undesirable assumptions in such an approach, which a more direct analytic method could avoid if it became practical.

The assessment of tobacco use patterns is no different from most other behavioral and psychological domains in that it typically begins with a collection of binary or ordinal items. The analysis of such measures represents a serious challenge for growth curve modeling because the methods were developed for continuous data. Two main challenges present themselves. One is that computing the likelihood of ordinal data is typically done by integrating the multivariate normal distribution. In a growth curve

model with m occasions of measurement, multiple integrals must be computed over as many dimensions as there are occasions, which becomes computationally intensive with more than 10 dimensions. This problem is more acute with data from relatives; pairs of twins doubles the number of dimensions of integration, and larger pedigrees (e.g., size f) further exacerbate the problem to mf integration. Worse still, when measures of dependence are being derived from a set of p items, mpf dimensional integration is needed. It is nonetheless possible to apply models for both mean and covariance structure (of which LGCs are an example) to ordinal data, as described by Mehta and colleagues³ and Wirth and Edwards.⁴⁷ The second key issue in the analysis of multivariate data (such as a measure derived from a number of questionnaire items) is that it is very important to assess measurement invariance.⁵ Analysis of sum scores could provide misleading results influenced by variance specific to any of the items rather than by the factor itself. Conversely, analysis of individual items subsumes factor variance and item-specific variance for which patterns of familial resemblance (and relative magnitude of variance components) may differ.

An addition to modeling of growth curve mixture models is the notion of switching⁴⁸ in which individuals may belong to different trajectory groups at different times. The specification of these models is not straightforward, because it is necessary to consider all possible latent states in which an individual might be at each occasion of measurement. With r trajectory classes and s occasions of measurement, there are r^s possible states for each individual and, thus, r^s components to the mixture distribution. The situation is exacerbated when the model is extended to data collected from pairs of relatives in that r^{2s} components are required. One may therefore envisage analysis of relatively few occasions of measurement

with this approach. Nevertheless, this approach has some attraction for the analysis of data on nicotine use. Transitions between user and nonuser classes are of key importance in the study of the uptake and cessation of tobacco use. In future work, it is hoped to extend the model to the genetic epidemiology of the probability of transitions between different latent states.

Genetic Latent Class Models

Historically, latent class models and factor models developed separately. Factor models can be traced to the work of Spearman.⁴⁹ Latent class analysis was developed in the mid-twentieth century.^{50,51} Although its use has been less widespread than that of latent trait models (which have been very popular for the last 20 years), it is still a popular method.⁵² Under certain circumstances, latent class models and factor models are equally able to account for mean and covariance structure;⁵³ they have distinct conceptual frameworks and can be distinguished by analysis of raw data.³⁹ In the latent class model, the population is regarded as a mixture of subgroups, whose item response probabilities (or item means and variances in the continuous case, known as the latent profile model) vary between the groups. Within each subgroup, the items are specified to be uncorrelated (the assumption of *conditional independence*). The model is one example of a finite mixture model;⁵⁴ along with other such models, it is becoming popular in many areas.

Eventually, structural equation models and latent class models were combined in a single comprehensive model.^{55–60} Slightly different combined models have been proposed with names including “finite mixture structural equation model,” “mixtures of conditional mean- and covariance-structure models,”⁵⁵ and “finite mixture confirmatory factor models.”⁵⁸ In what follows, the combined model is referred to as the “factor mixture model”

(FMM). The FMM features two types of latent variables—namely, a latent class variable and one or more continuous factors within each class. The continuous factors have several observed indicators (e.g., items of a questionnaire), which can be binary, ordinal, or continuous. The FMM is therefore a model for multivariate data. Muthén and Asparouhov⁴⁰ describe application of an FMM to data collected from twins. These models may be fitted with either Mx or Mplus.

Several genetic latent class models were described by Eaves and colleagues.⁶¹ In these models, the conditional independence assumption is retained, both within individuals and across relatives. Complexity arises in the modeling of familial resemblance for class membership. Several choices are possible. A simple Mendelian model of a diallelic major locus that controls class membership (*AA* versus *Aa* versus *aa* genotypes corresponding to three latent classes) would yield a pattern of identical class membership for monozygotic twin pairs with frequencies p^2 , $2pq$, and q^2 , where $p = 1 - q$ is the frequency of allele *A* in the population. The dizygotic proportions of class membership are more complex, involving pairs discordant for class membership, but are straightforward to derive. It is also possible to construct a two-class concatenation of this single locus model, where genotypes *AA* and *Aa* are both associated with class 1, while *aa* is associated with class 2. Eaves and colleagues also describe more complex models that specify a binary environmental factor that interacts with the major locus to generate four classes. The environmental factor is allowed any degree of association between relatives, according to the pattern

$$\begin{array}{cc} \alpha^2 + \delta & \alpha\beta - \delta \\ \alpha\beta - \delta & \beta^2 + \delta \end{array}$$

where $\alpha = 1 - \beta$ is the frequency of the first environmental condition, and δ is

the association parameter for familial resemblance, which has to satisfy the range constraint

$$0 < (\alpha\beta - \delta) / [(\alpha^2 + \delta)(\beta^2 + \delta)]^{1/2} < 1$$

Such nonlinear inequality constraints are easily specified in Mx or MPlus, although no implementation of the model was found. Other specifications of familial resemblance for class membership are possible. Gillespie and Neale⁶² described a finite mixture distribution model for genotype by environment interaction in which a major locus, a continuous threshold model, a shared environment, or a nonshared environment factor controlled group membership. This area is underdeveloped in genetic modeling, particularly in view of developments such as growth curve mixture modeling.^{48,56,63,64}

Molecular Genetic Analysis

Linkage Analysis

The focus of structural equation modeling of data has largely been on testing the significance and quantifying the contributions of genetic and environmental latent sources of variance to individual traits or the comorbidity of traits. This is referred to as either “basic” or “advanced genetic epidemiology.” The 1990s saw a huge upswing in the analysis of data collected from molecular genetic studies, which continues to increase to this day. These studies attempt to establish whether measured specific genetic variants contribute to variation in the trait of interest and thus identify the actual genes involved. There are two main types of molecular genetic study: linkage and association. Linkage analysis uses related individuals to evaluate the correlation between similarity at a genetic locus with similarity of the trait value. Association studies mostly employ unrelated individuals and compare the frequency of genetic variants at a locus in

cases and controls. Typically, these analyses are repeated for a range of locations across the genome, either using a candidate gene approach or by scanning the genome. While traditionally a limited set of markers across the genome was included, genome-wide association studies now employ chips with a million loci. This section describes in brief the connection between structural equation modeling and linkage analysis, setting the stage for the integration of models for gene action with growth curves or stages of tobacco use trajectories.

Linkage analysis is closely analogous to the analysis of twin data. In practice, the molecular biologist assays several markers along the genome. Originally, these markers were chosen to be highly polymorphic, such that there were some 15–20 different alleles at a “microsatellite” locus, and some 300–400 loci were placed at approximately equal intervals along the genome. Today, a larger number of two-allele loci are usually assayed, using single nucleotide polymorphism (SNP) genotyping technologies. In either case, the idea in linkage analysis is to assess how many alleles a pair of siblings (for example) share at a particular location along the genome. Sib pairs can then be classified into those sharing zero, one, or two alleles identical by descent (IBD) at the locus. The possible IBD configurations for sib pairs can be tabulated by labeling parents’ alleles as *AB* for the father and *CD* for the mother.^{65,66} Their possible offspring are *AC*, *AD*, *BC*, and *BD*; the possible pairwise combinations of these offspring are shown in table 6.1. The cells of this table indicate the number of alleles shared IBD by each of the 16 possible sib pair types. Since each combination is expected to be equally frequent, the expectation is that one-fourth of the pairs will be IBD 2, one-half will be IBD 1, and one-fourth will be IBD 0.

Detection of linkage occurs when IBD 2 pairs are more similar than IBD 1 pairs, who in

Table 6.1 Number of Alleles Shared Identical by Descent for a Pair of Full Siblings

	<i>AC</i>	<i>AD</i>	<i>BC</i>	<i>BD</i>
<i>AC</i>	2	1	1	0
<i>AD</i>	1	2	0	1
<i>BC</i>	1	0	2	1
<i>BD</i>	0	1	1	2

Note. Parental genotypes are *AB* and *CD*.

turn are more similar than IBD 0 pairs. This is very much the same as the twin study apart from three important exceptions. First, rather than fitting an ACE model, an estimate is made of the contributions to the variance of the genetic variants at a specific locus, the quantitative trait locus (QTL), the residual familial factors (F), and unique environmental factors (E), sometimes referred to as the QFE model. Second, the IBD 0 pairs correspond to unrelated pairs, such as adopted children reared in the same family. Third, the information about IBD sharing is imperfect because the markers do not unambiguously classify sib pairs into those sharing 0, 1, or 2 alleles IBD. There are two main approaches to overcoming this limitation. One is to use an estimate of π , the proportion of alleles shared IBD, and π is specified as the covariance between the variance component that represents the effect of the QTL. Alternatively, and mathematically more consistent, the imperfect classification can be represented as a mixture distribution.^{67,68} The likelihood of a sibling pair's phenotypes can be written as the weighted sum of three likelihoods: the IBD status is zero, one, or two. In either approach, one uses the definition variable approach described above in the subsection on "Structural Equation Modeling" to specify the model. The significance for linkage is evaluated by the logarithm of odds (LOD) score, a statistic that represents the likelihood of the odds of linkage over the odds of no linkage. Criteria have been established to classify results as suggestive, significant, or confirmed evidence for linkage.⁶⁹

In practice, most linkage analysis is conducted with specialized software such as Merlin⁷⁰ or GENEHUNTER.⁷¹ However, such programs are designed for the analysis of a single trait. Fortunately, they permit export of IBD probabilities that can be used in other software for modeling multivariate or longitudinal data or simply modeling traits that are assessed by using a collection of binary or ordinal items. For example, it is possible to conduct a linkage scan for quantitative trait loci that cause variation in level or slope of a growth curve model.

Association Analysis

Association analysis is in principle simpler than linkage analysis in that it can be conducted with groups of cases and controls. Conceptually, the idea is to compare between groups the allele frequency at a particular locus. From a statistical point of view, this is a simple comparison that can be conducted using a χ^2 test. However, certain pitfalls have the potential to generate false positives or false negatives. One is population admixture in which there exist two or more subpopulations whose allele frequencies differ and whose trait mean values differ for entirely different reasons. Several approaches exist to control for such admixture (or stratification). One is to obtain a set of alleles in noncoding regions of the genome to assess whether there is stratification.⁷² A second is to use data collected from relatives.⁷³ Since families come from the same stratum of the population, any allele-phenotype association observed within families cannot be due to population stratification. An additional advantage of the family-based research design is that it permits joint analysis of linkage and association information, which in turn assists with fine mapping of quantitative trait loci.⁷⁴

There is much focus on genome-wide association studies, which have become practical to conduct with the advent of inexpensive SNP chips. These microarray

chips permit the assaying of a very large number (500,000, for example) of SNPs across the genome. Such density permits exploitation of linkage disequilibrium in which short strands of DNA are transmitted intact with low chance of recombination. Thus, it becomes possible to identify very small regions likely to contain a polymorphism that accounts for variation in a trait. Much of the software development in this area is targeted at the rapid analysis of this large number of data points and with handling the high type 1 statistical error rates that ensue. Redden and Allison⁷⁵ note that assortative mating can increase the risk of type 1 error in association studies. Again, the focus is single trait oriented rather than multivariate. However, it has been noted that association data have considerable potential to resolve alternative pathways between phenotypes.⁷⁶ The integration of association data into a more sophisticated modeling framework is straightforward in principle, but much remains in the way of opportunities to develop and test the models. For example, in a latent growth curve mixture model, one might specify that alleles at a locus affect the mean of the level or growth factors. Alternatively, one might specify that an individual's class membership probabilities are a function of genotype. Thus, one would explicitly model the allele effects as another model parameter. A simpler two-step approach would be to assess allele frequencies between those classified as belonging to one or another class. This latter method would have the advantage of analytic simplicity at the cost of losing the information about the precision of the class membership classification.

Review of Genetic Studies of Smoking

The role of genes and environment in initiating smoking has been the subject of a growing number of twin and family studies and several reviews.^{77,78} Evidence from these

studies generally points to an important role of genetic factors in explaining individual differences in starting to smoke. In addition to additive genetic factors, however, shared environmental factors also contribute significantly to the variation, especially in adolescent samples. The literature is reviewed here from a range of perspectives, with the aim of providing a better understanding of the process of developing the smoking habit and subsequent dependence. As shown in epidemiological studies, approximately 50% of the individuals who start to smoke continue to do so and go on to become dependent on nicotine. Prevalence rates for adults in 2006 suggest that 42% have ever smoked in their lifetime and 24% of men and 18% of women still were smoking.⁷⁹ One obvious question is whether the factors that lead to individuals starting to smoke also contribute to whether they persist in their smoking behavior. First, this section reviews the most prominent twin studies on adolescent smoking. Second, additional information is considered that can be obtained from extending the classical twin design to other relatives—for example, parents, siblings, and spouses. Third, the focus is on studies that have included measures of smoking initiation and progression to discern the role of genes and environment to the different stages of the smoking process. Finally, molecular studies of adolescent smoking are reviewed to show how the direct assessment of molecular genetic polymorphisms can enhance understanding of the trajectory from initiating the smoking habit to nicotine dependence.

Twin Studies of Adolescent Smoking

Eight published papers were identified that report results from twin studies on smoking behavior in adolescence. The first, by Boomsma and colleagues,⁸⁰ reported data on 1,600 Dutch adolescents aged 13–22 years, concluding that the majority

of interindividual variation in smoking behavior was due to shared environmental factors (59%), with 31% attributed to genetic factors. Results, however, were not consistent across age groups, with heritability estimates decreasing with age in males but increasing in females. When age was included in the analyses, 9% of the variance could be accounted for by age, reducing the proportion explained by shared environmental factors to 50%. Furthermore, the shared environmental factors differed between males and females (correlation between shared environmental factors, $r_c = .65$). A follow-up study including more than 2,600 pairs of Dutch adolescents⁸¹ showed a more consistent trend of an increasing role of genetic factors in smoking behavior from ages 12 to 22 years, with a corresponding decline in the contribution of shared environmental factors. Up to age 17, heritability was not significantly different from zero. However, 33% (95% confidence interval [CI], 31%–54%) of the variance was attributed to genetic factors in young adult females, and 66% (95% CI, 43%–86%) in males. Again, shared environmental factors, which accounted for the majority of the variance in adolescence, appeared partially different for males and females. Similar results were obtained in a sample of 1,419 16-year-old Finnish twin pairs.⁸² Shared environmental factors accounted for the majority of the variance in smoking behavior (having smoked 50 cigarettes or more)—75% in males and 63% in females. Heritability was estimated at 17% and 30%, respectively. In analyzing FinnTwin12 smoking data from twins and their classmate controls, heritability (h^2) was 11% and shared environment could be split into familial influences (49%) and school-based neighborhood effects (24%).^{83,84}

Data from 16-year-old twins ($N = 159$) studied in the first wave of the Virginia Twin Study of Adolescent Behavioral Development⁸⁵ suggested that additive genetic factors accounted for 65% (95% CI,

10%–93%) of the variance in liability to lifetime smoking and 60% (95% CI, 0%–93%) for current tobacco use, with nonsignificant contributions of shared environmental factors (18% and 21%, respectively). While the prevalence of smoking was statistically different for males and females, the contribution of genetic and environmental factors did not differ by gender. Gender differences were also not statistically significant in analyses of 500 17- to 18-year-old twin pairs from the Minnesota Twin Family Study,⁸⁶ resulting in estimates of 36% for the heritability of tobacco use and 44% for shared environmental factors. When analyzed separately by gender, the predominant source of variance was genetic (59%) for males and shared environmental (71%) for females. An updated report⁸⁷ on a slightly larger sample ($N = 626$) with primarily additional female twins showed a heritability of 56% for ever having used tobacco and a smaller contribution of shared environmental factors (30%). Genetic factors were the predominant source of variance in males (48%) and females (62%). The contributions of both genes (38%) and shared environment (52%) were significant in data from 682 twin pairs (306 biological siblings and 74 adoptive sibling pairs) aged 12 to 19 years assessed by the Center for Antisocial Drug Dependence in Colorado.⁸⁸ Again, gender differences were not statistically significant. The slightly larger role of the shared environment is consistent with the inclusion of younger adolescents.

Shared environmental factors were also the predominant (52%) source of variation in smoking initiation in a sample of 414 same-gender twin pairs aged 13–18 years from the Australian Twin Registry (ATR).⁸⁹ Heritability reduced from 22% to zero when the model was adjusted for smoking by peers and parents. While shared environmental factors were more important in males, and genetic factors accounted for the largest proportion of variance in females, the gender difference

was not significant. Data from two follow-up waves showed a gradual shift from shared environmental to genetic influences, with each accounting for about 35% of the variance in 18- to 25-year-olds, consistent with results from other studies. A 2005 study, using a genetically informative subsample of 2,142 sibling pairs, aged 11–20 years, participating in two waves of the National Longitudinal Study of Adolescent Health,⁹⁰ presented heritability estimates for smoking frequency of 52% and between 28% and 35% for high levels of smoking frequency. The role of shared environmental factors was greater for high levels of smoking frequency (25%–38%) than for overall smoking frequency (7%). In contrast to previous studies, smoking frequency was used rather than a measure of smoking initiation.

As discussed in a review of twin and adoption studies of adolescent substance use,⁹¹ shared environmental influences appear stronger in younger adolescents,

whereas genetic influences are more substantial in older adolescents and young adults (figure 6.4). However, it is possible that the earliest stage of cigarette smoking (i.e., first experimentation) is mostly due to environmental factors, whereas later stages (conditioned on previous exposure to nicotine) are more likely to be due to genetic factors. The issue with many studies is that the presence of smoking initiation is determined by a somewhat vague item, such as, “Have you ever smoked?” It is possible that this question is more likely to be interpreted by a younger adolescent (i.e., one closer to first exposure to cigarettes) as “whether they’ve ever tried even a single cigarette,” while by older adolescents or young adults as meaning onset of regular smoking. Studies that use such a vague measure of initiation with a broad age range may inadvertently be measuring different behaviors (i.e., different stages of the smoking habit) in early adolescents compared with those subjects

Figure 6.4 Estimates of the Contributions of Additive Genetic (a^2) and Shared Environmental (c^2) Factors to Smoking Initiation by Sample, Age, and Gender in Published Studies of Adolescent Twins

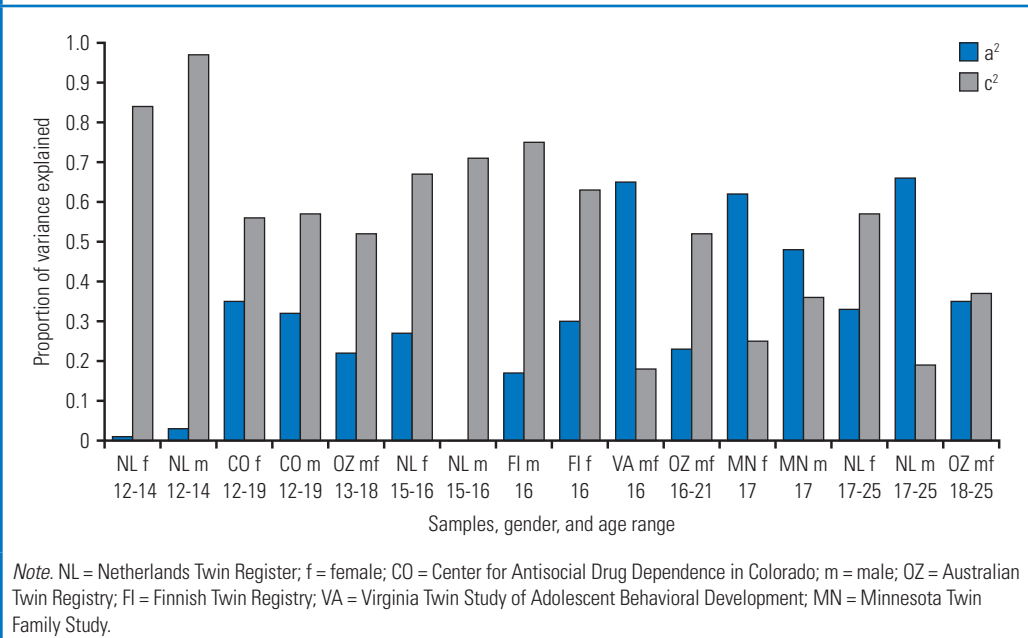

in young adulthood. It should also be noted that these comparisons are based on estimates from studies with varying sample size and thus varying precision. Ideally, a meta-analysis should be undertaken that appropriately accounts for these differences. Alternatively, a mega-analysis that combines the raw data of several related studies would provide more accurate estimates of the potentially changing role of genes and environment across adolescence.

Extended Genetic Epidemiology

Extended Twin Family Studies of Transmission of Smoking

Relatively few studies have either included or analyzed data collected from other relatives. Rhee and colleagues reported results of fitting a model to data on twins, nontwin siblings, and adoptees.^{88,92} The major finding was that the proportions of variance associated with the special twin environment and with genetic dominance were small. Data from the Netherlands Twin Register suggested significant assortment between spouses, with the correlation between husband and wife for “currently smoking” larger than for “ever smoking.”⁸⁰ Furthermore, there was no evidence that parental smoking encouraged smoking in their offspring, as resemblance between parents and offspring was significant, but rather low, and could be completely accounted for by genetic relatedness. If included, cultural transmission estimates were negative. Similar results were obtained for data on twins and their parents from the Finnish Twin Registry,⁸² showing significant assortment (husband-wife correlation = .42), and low but significant parent-offspring correlations.

Nongenetic analyses of data on 3,906 twins confirmed significant associations between the smoking behavior of the twin with that of the co-twin. Odds ratios, ranked highest

to lowest, were given when an individual had a smoking monozygotic co-twin, a smoking same-gender dizygotic co-twin, or a smoking opposite-gender dizygotic co-twin—suggesting a role for both genetic factors and gender. In addition, associations were also significant for smoking behavior of parents, siblings, and friends, and were gender dependent (stronger associations for same-gender smoking family members).^{93,94} In fact, the risk to initiate smoking when having friends who smoke was similar to that of having a smoking co-twin and greatly exceeded that of having a parent who smokes.

Similarly, data from the Virginia 30,000 Study, including about 15,000 twins and their first degree relatives (parents, siblings, spouses, children), showed little evidence for the role of parents in influencing the smoking behavior of their children through other than genetic pathways.^{95,96} Analyses of these extended twin kinship data supported the role of additive genetic factors, accounting for more than one-half of the variance in smoking initiation, partly due to the consequences of assortative mating, which was highly significant. About 20% of the variance was accounted for by specific environmental factors. Furthermore, the contributions of shared environment and special twin environment were both significant. The environmental paths from the parents to their children were estimated to be negative, but this was not significant. Note that these analyses were based on data from different generations of adults and should ideally be performed on data sets of adolescent twins augmented with parents.

Multivariate Genetic Studies

Only a few studies have investigated whether the same genetic or the same environmental factors account for the co-occurrence of several smoking behaviors. Genetic analyses of data from young adult Australian twins⁹⁷ reporting any cigarette use were undertaken to examine whether there are genetic

factors specific to nicotine withdrawal after controlling for factors for smoking progression and quantity smoked. Significant genetic overlap was found for smoking progression, quantity smoked, and nicotine withdrawal, but evidence for specific genetic influence to nicotine withdrawal remained. An extension of the causal contingent common (CCC) pathway models (see also the subsection below, “Progression from Smoking Initiation to Nicotine Dependence”) was used to explore the interrelationship of smoking age at onset, cigarette consumption, and smoking persistence.⁹⁸ Smoking initiation was operationalized as an ordinal variable with three categories—nonsmokers, late-onset smokers, and early-onset smokers—assuming a single underlying distribution and thus referred to as age at onset. This allows the authors to fit a full multivariate model, rather than the CCC pathway model, according to Heath and colleagues,⁹⁹ and partition both the variation and covariation into genetic and environmental contributions. The authors found significant heritability for all three phenotypes in males and females and slightly higher genetic correlations in males than in females. The relationship of smoking age of onset, cigarette consumption, and smoking persistence was also mostly due to shared genetic influences. A similar analysis of age at initiation, amount of smoking, and smoking cessation was done on data from adult Finnish twins.¹⁰⁰ The study found that genetic factors were important in amount of smoking and smoking cessation, but these were largely independent of genetic influences on age at initiation.

Progression from Smoking Initiation to Nicotine Dependence

Most individuals who initiate smoking progress to regular smoking, and many become dependent on nicotine.⁷⁹ It is, therefore, important to evaluate whether the same factors influence whether someone starts to smoke and whether one continues

to smoke. Reports that analyze measures of persistence or dependence without taking initiation into account assume that the dimensions underlying initiation and progression are independent (if only smokers are included) or assume that persistence is an extreme version of initiation on the same single liability dimension (if nonsmokers are included but score zero on the progression measures). Heath and colleagues¹⁰¹ recognized this and developed alternative models to test these assumptions. First, studies are reviewed that estimated the role of genes and environment on the measure of dependence without taking initiation into account. McGue and colleagues⁸⁷ reported no gender differences in the role of genetic and environmental factors for nicotine dependence in a sample of 626 17-year-old twin pairs, with genes accounting for 44% and shared environment for 37% of the variance. Although Rhee and colleagues⁸⁸ found no significant gender differences for initiation, shared environmental factors were significant for tobacco use and problem use in males but not in females, explaining 45%–48% of the variance in a sample of more than 1,000 twins and siblings. Heritability estimates were 24%–26% in males and 95% in females, respectively.

As far as known, only one study has simultaneously analyzed data on smoking initiation and persistence in a juvenile sample. Koopmans and colleagues¹⁰² published analyses from 1,676 Dutch adolescents. They found separate smoking initiation and quantity dimensions, which were not completely independent. The total heritability of quantity smoked was estimated at 86%. Five studies were found of smoking initiation and progression in adults. Data from 4,000 male twin pairs from the Vietnam Era Twin (VET) Registry¹⁰³ found that genetic and shared environmental factors accounted for 50% and 30%, respectively, of the variance in liability to initiate smoking. However, no evidence for shared environment was found for factors specific to persistence,

for which variation was estimated to be 70% additive genetic. Significant heritability for nicotine dependence (60%) was also found in a follow-up study of 3,356 male VET Registry pairs.¹⁰⁴ Using nonmetric multidimensional scaling, Heath and colleagues¹⁰⁵ found that the etiologic factors that determined which individuals were at risk of becoming smokers differed from those that influenced age of smoking initiation. The role of genes and shared environment in the onset of smoking differed by cohort and gender, and only genetic factors accounted for twin resemblance in the age at which smoking onset occurred.

As described above, Kendler and colleagues¹ developed a model that estimates the correlation between liability to smoking initiation and liability to nicotine dependence and applied it to data on 1,898 female twins from the Virginia Twin Registry. Results indicated that etiological factors that influence initiation and dependence, while overlapping, are not perfectly correlated. Thus, genetic factors contributed 72% to variance in liability to nicotine dependence, of which 69% also influence initiation and 31% are unique to nicotine dependence. Madden and colleagues¹⁰⁶ fitted a similar correlated liability dimensions model to data from large samples of male and female same-gender twins from three countries—Australia (1,535 pairs), Sweden (5,916 pairs), and Finland (4,438 pairs)—further subdivided by age bands. The authors also found that familial influence on risk for persistence in smoking cannot be entirely explained by the same factors responsible for risk of smoking initiation. Total genetic variance for smoking persistence ranged between 39% and 48% in women and 42% and 45% in men, of which only 7%–35% was accounted for by factors in common with initiation. Although shared environmental factors contributed significantly to smoking initiation, there were no significant additional shared environmental contributions to smoking persistence.

Maes and colleagues³⁷ extended the liability models to include smoking initiation, regular tobacco use, and nicotine dependence, and applied them to data on both female and male twins from the Virginia Twin Registry. Results showed that the liabilities to all three stages of smoking behavior were correlated, with 80% of the variance in liability shared between initiation and regular use, and 50% between regular use and nicotine dependence.³⁷ The heritability of nicotine dependence was estimated at 62%, of which 24% was specific to nicotine dependence, 10% shared with regular tobacco use, and the remaining 28% shared with smoking initiation as well. Data on 1,572 Dutch adult twins also showed that the smoking initiation dimension is not independent from the nicotine-dependence dimension.¹⁰⁷ As shown in other data sets, shared environmental factors contributed significantly to the variance in liability to initiation but not to nicotine dependence, which was strongly (75%) influenced by genetic factors (figure 6.5).

Assessment of Nicotine Dependence

Almost all studies that measure nicotine dependence use either a sum score or a binary diagnosis. The most widely used measures are the FTQ⁸ items and the criteria based on the *Diagnostic and Statistical Manual of Mental Disorders (DSM)*,¹⁰⁸ either of which may be dichotomized by imposing a threshold for affection status. The latter approach reduces the information available, which, in genetic studies, would typically result in reduced statistical power.^{26,109} Using sum scores assumes that the scale of measurement is invariant and that the underlying liability is unidimensional. The FTQ correlates with other proposed measures of nicotine dependence such as carbon monoxide, nicotine, and cotinine levels.⁸ However, the nicotine rating and inhalation items were found to be unrelated to biochemical measures, and a revised scoring was proposed, the FTND.¹¹⁰ Both

Figure 6.5 Estimates of the Contributions of Additive Genetic Factors in Common with Initiation (a^2_i), Total Additive Genetic (a^2), and Shared Environmental (c^2) Factors to Smoking Persistence by Sample, Gender, Age, and Measure of Persistence

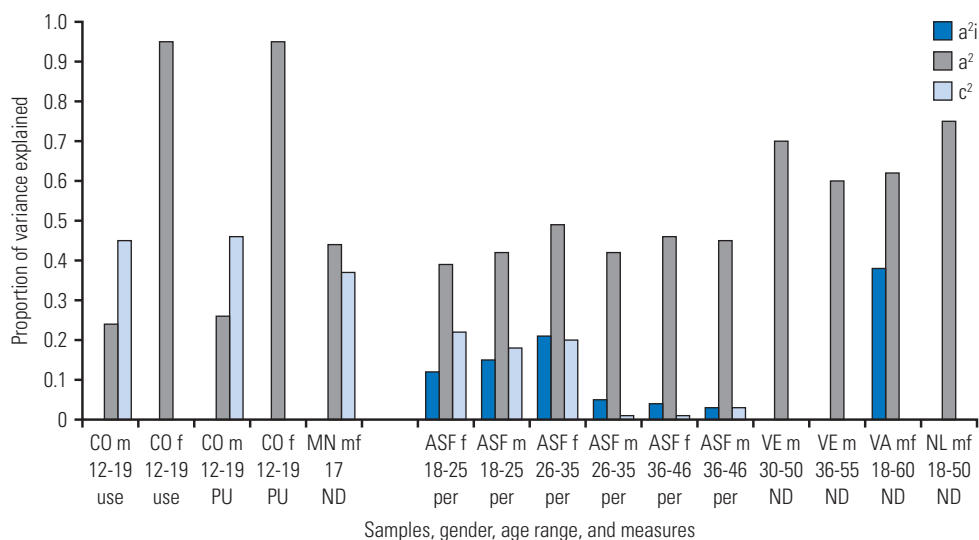

Note. The first five studies do not take initiation into account. CO = Center for Antisocial Drug Dependence in Colorado; m = male; MN = Minnesota Twin Family Study; f = female; ASF = Australian, Swedish, and Finnish Twin Registries; VE = Vietnam Era Twin Registry; VA = Virginia Twin Registry; use = tobacco use; PU = problem tobacco use; per = persistent tobacco use; ND = nicotine dependence.

the FTQ and the FTND were highly reliable, and internal consistency was greater for the FTND than for the FTQ.¹¹¹ Retrospectively assessed FTQ-FTND scale scores also have acceptable reliability.¹¹² Furthermore, the six FTQ items were positively correlated with cotinine values in adolescent smokers.¹¹³

Several studies have attempted to evaluate the dimensionality of nicotine dependence using factor analysis of either the FTQ or the FTND items. An exploratory factor analysis of FTND in young adult smokers resulted in two factors.¹¹⁴ The first factor, labeled “smoking pattern,” included items assessing the number of cigarettes smoked per day, time to first cigarette, difficulty refraining from smoking, and smoking when ill. The second factor, labeled “morning smoking,” consisted of two items measuring whether one smokes more in the morning and whether the first cigarette is most

satisfying. Confirmatory factor analysis, however, only confirmed the first factor. Similar factors resulted from an exploratory factor analysis of FTND in an adult sample, with a third factor related to the brand of cigarettes when all eight FTQ items were included.¹¹⁵ These analyses were repeated in the drug abuse patient sample, with similar results, except that time to first cigarette loaded on both factors.¹¹⁶ Factors were named “persistence in maintaining nicotine levels during waking hours” and “urgency in restoring nicotine levels after nighttime abstinence.” A confirmatory analysis in hospital patients confirmed that the items of the FTND were best modeled as two correlated factors with a cross-loading.¹¹⁷ Furthermore, a four-item single factor (“daytime smoking factor”) fitted the data reasonably well. This confirms previous studies showing that both the four-item and the Heavy Smoking Index

(based on two FTND items: the number of cigarettes smoked per day and the time to first cigarette) represent the FTND well.^{118,119} Few studies have compared the questionnaire-based FTQ-FTND measures with those based on structured interviews (i.e., *DSM, the International Statistical Classification of Diseases and Related Health Problems*), and have found only moderate concordance,^{120,121} which may indicate that they tap into different aspects of nicotine dependence. Only one analysis was found that was based on factor analysis/item response of nicotine-dependence measures using a genetically informative sample. In a genetic factor analysis of nicotine-dependence items measured in adult Australian twins, item covariation was best captured by two genetic but one shared environmental factor for both women and men; however, item factor loadings differed by gender.¹²² None of these studies included initiation as an item. Later in this chapter, results are presented from a genetic item analysis of adult Virginia twin data that include both initiation and regular smoking in the analysis. As nicotine-dependence symptoms were only assessed in individuals who had initiated smoking and become regular smokers, it is shown here how including these conditional items affects the estimates of factor loadings and thresholds.

Genetic Latent Growth Curves and Latent Class Analysis

Although the epidemiological literature on growth curve and latent class analysis of smoking behavior is rapidly expanding (chapter 5), genetically informative applications of this type of analysis were not identified.

Molecular Genetic Studies of Smoking

Besides the extensive literature on genetic epidemiological studies of smoking behavior

and nicotine dependence, the literature on gene-finding approaches for nicotine dependence is increasing rapidly, reflecting the general trend in the genetic analysis of complex traits. The major results from linkage and association studies on smoking behavior and nicotine dependence are briefly summarized below. Given that very few molecular genetic studies of smoking behavior have included adolescent subjects, results are provided from adult samples.

Linkage Studies

In 2003, three linkage scans of smoking-related measures had been completed. Since then, at least seven more have been published and others are under way. The first genome scan was conducted using a sample of 130 sibling pairs concordant for nicotine dependence from Christchurch, New Zealand (CNZ) and a replication sample from Richmond, Virginia.¹²³ Several publications have resulted from data made available to investigators participating in Genetic Analysis Workshops (GAW). As part of GAW11, data on 105 families from the Collaborative Studies on Genetics of Alcoholism (COGA) were examined for linkage for smoking-related traits, including smoking initiation, and habitual smoking, defined as ever smoking at least one pack (20 cigarettes) daily for six months or more.¹²⁴ Data from a genome scan with 330 extended families participating in the Framingham Heart Study (FHS) were made available to investigators participating in GAW13, resulting in several reports on maximum cigarettes per day (maxcig)¹²⁵ on a typical day.

Several genome scans have been performed with samples initially selected for phenotypes other than smoking. As part of a Netherlands Twin Study of Anxious Depression (NETSAD) collaborative project, a genome scan was performed on 646 sibling pairs in 212 families for the three smoking phenotypes: smoking initiation, maxcig, and

age of first cigarette.¹²⁶ A scan for regular and persistent tobacco use was performed with data collected from a community sample of Mission Indians as part of a larger study exploring risk factors for substance dependence.¹²⁷ Another scan was conducted using a Yale University sample originally collected for linkage analyses of anxiety disorders, which also included a measure of cigarette smoking.¹²⁸ Similarly, data on tobacco use and nicotine dependence were available for a sample ascertained for affected sibling pair linkage studies of cocaine or opioid dependence.¹²⁹ In the latter study, analyses were conducted separately for subjects with European American versus African American descent.

A number of studies have been published on samples specifically ascertained for smoking behavior. A linkage study focused entirely on a sample of African American origin from the Mid-South Tobacco Family (MSTF)¹³⁰ cohort, with assessments of tobacco use and nicotine dependence. Swan and colleagues¹³¹ performed a genome-wide screen for nicotine dependence susceptibility loci on tobacco use data collected from families obtained through participants in the Smoking in Families Study (SMOFAM). Saccone and colleagues¹³² analyzed a smoking quantitative trait in Australian and Finnish families with at least one heavy smoker. In 2006, the first study in linkage analysis for smoking initiation and cigarette consumption was published that incorporates gender differences by using Australian twin families (ATR).¹³³ None of the reported linkage scans of smoking-related phenotypes have included data from adolescents.

Published linkage scans have resulted in only a few regions that have exceeded levels of genome-wide significance.¹³⁴ Saccone and colleagues¹³² reported the largest LOD score (5.98) for nicotine use on chromosome 22q12. The second highest LOD score (4.22) was found for maxcig on chromosome 20 at 72 centimorgans (cM),¹³² which replicates

an earlier result in the FHS sample.^{135,136} A similarly high LOD (4.17) was reported for chromosome 10 between 92 and 94 cM for quantity smoked¹³⁰ in the MSTF sample. Furthermore, this result was supported by suggestive linkage in the same location for three other nicotine dependence measures. This region was part of a broader region initially reported by Straub and colleagues¹²³ for which the highest LOD score (1.28) for nicotine dependence was obtained in the CNZ sample. A modest signal (LOD 2.16) was also found for a location close to this region (80 cM) for FTND in a European American sample.¹²⁹ An LOD score of 3.71 was found for smoking rate in the FHS sample on chromosome 11 at 70 cM.¹³⁵ This result has not been replicated so far, although a modest LOD score of 1.64 was found at 87 cM for heavy smoking.¹²⁴ Suggestive evidence for linkage (LOD = 3.04) was also reported at 95 cM on chromosome 5 for FTND.¹²⁹

At least 12 other 10-cM chromosomal regions contain positive findings from at least two different samples; however, neither reach criteria for significant linkage. For chromosome 5, Vink and colleagues¹³⁷ reported an LOD of 2.09 at 205 cM for age at first cigarette in NETSAD, and Saccone and colleagues¹²⁵ obtained an LOD of 1.02 at 100 cM for maxcig in FHS. Five reports converged on locations between 50 and 65 cM on chromosome 6 with LOD scores ranging from 1.1 to 3 for different tobacco use phenotypes.^{126,127,133,137,138} Four reports converge on an area on chromosome 7 between 140 and 164 cM.^{127,131–133} Two regions on chromosome 8 showed some evidence for linkage: one between 24 and 31 cM for maxcig and nicotine dependence in the FHS and SMOFAM, the other between 110 and 115 cM for regular tobacco use in the Mission Indian and FHS samples. The largest region identified, with seven “hits,” is in a 25-cM region (91–116 cM) on chromosome 9 for phenotypes ranging from lifetime smoking to nicotine dependence. An additional

region on chromosome 9 (between 165 and 172 cM) also showed modest to suggestive evidence for linkage for ever smoking (COGA sample) and maxcig (in the FHS). Two positive reports were found for an area between 38 and 43 cM on chromosome 11 in the MSTF and the ATR. On chromosome 13 (41–42 cM), two positive linkage signals were found for quantity smoked, one in FHS and the other in MSTF. LOD scores between 1.29 and 3 were reported for the exact same location on chromosome 14 (88 cM) in three independent samples (COGA, NETSAD, and the FHS). Another region with support from at least two samples includes locations 127 and 135 cM on chromosome 15 for smoking rate (FHS) or ever smoking (COGA).¹²⁹ Given the range of phenotypes, methods, selection criteria, and sample sizes, the accumulated data have at least identified regions of interest for susceptibility loci for nicotine use phenotypes. Collaborations and meta-analyses might assist in resolving some of these findings.¹³⁹

Association Studies

The number of association studies of candidate genes for smoking initiation and nicotine dependence has grown steadily. A search identified only 10 studies published before 2000 and five or less papers per year from 2001 to 2003. Yet, in 2004, 13 papers were published on the subject, a trend that has continued with 17 papers in 2005 and 15 in 2006, bringing the total to more than 70 articles.

Several reviews have summarized the findings.^{140–146} They can be broadly divided into four categories: (1) metabolism of nicotine, (2) nicotine receptors, (3) the dopaminergic reward system, and (4) the serotonergic reward system. Obvious candidate genes are those that influence the metabolism of nicotine, such as the cytochrome P-450 (CYP) system. Interest has focused on *CYP2A6*, which is

involved in the metabolism of nicotine to cotinine. At least 10 out of 14 studies show significant associations to smoking behavior, primarily smoking status and quantity, with 3 reporting positive associations with nicotine dependence. The second group of candidates are genes involved in sensitivity to nicotine, the major addictive substance in tobacco. Evidence from mouse knockouts suggests that the gene coding for the nicotinic acetylcholine receptor beta2-subunit (*CHRNA2*) is necessary for the full reinforcing properties of nicotine. Four studies of humans did not find association between *CHRNA2* and smoking initiation or nicotine dependence. However, a nominally significant allelic and genotypic association was found for *CHRNA2* and three other nicotinic cholinergic receptors and smoking initiation.¹⁴⁷ Furthermore, some evidence suggests variation in the *CHRNA4* gene may be associated with reduced risk for nicotine dependence. Two other receptors (*CHRNA1* and *CHRNA5*) have also been implicated in the risk for nicotine dependence.

A third group of studies has examined the association of smoking with variations in genes involved in the dopamine system, motivated by findings that the mesolimbic dopaminergic system appears to play a significant role in the reinforcing effects of addictive drugs, including nicotine. A number of studies have examined the association between several aspects of smoking behavior and variants in the dopamine receptors and a repeat polymorphism in the dopamine transporter protein (DAT/SLC6A3). About two-thirds of the findings for *DRD2* suggested an association with smoking status. Evidence for an association of DAT with smoking behavior was even stronger: five out of six reports presented significant positive findings. Analyses of other dopamine receptors (*DRD4*, *DRD5*) have largely produced nonsignificant results. A number of studies have examined genes related to dopamine synthesis or degradation.

Mostly significant associations have been reported for DOPA decarboxylase (DDC) and dopamine β -hydroxylase (D β H) with, respectively, three out of three and three out of four studies showing significant results. Several studies have examined polymorphisms in the monoamine oxidase (*MAOA*, *MAOB*), catechol-*O*-methyl transferase (*COMT*), and tyrosine hydroxylase (*TH*) genes with mixed results.

The fourth group of genes examined in association studies of smoking involves the serotonin system on the basis of evidence that nicotine withdrawal may be modulated by serotonergic transmission. The most studied gene in this system is the serotonin transporter *5-HTT*, particularly the functional polymorphism *5-HTTLPR*, which is implicated in alcoholism and major depression. These studies have produced conflicting results, with one-half of the reports indicating a significant association. Variation in another serotonin system gene, *TPH*, has been associated with smoking behavior in three out of five reports. Finally, other genes have been tested for associations with smoking behavior, such as the phosphatase and tensin homolog gene (*PTEN*), and the cholecystikinin gene (*CCK*), but so far these results have not been replicated.

In addition, two genome-wide association studies of nicotine dependence have nominated several novel genes while also identifying known candidate genes.^{148,149}

In summary, although this research area is in an early stage, and may be limited by several methodological weaknesses, various trends are starting to emerge. Most studies did not examine nicotine dependence directly; they used smoking status as the outcome. Sample sizes have tended to be relatively modest, the statistical criteria have been liberal, and multiple testing has been common. Therefore, the chance that these findings contain false positive results is high.

Item Response Theory Approach: Application to Virginia Twin Registry Data

This section applies the psychometric factor model to data on nicotine initiation and dependence collected from twins. The model is described above in the subsection “Item Response Theory.” These analyses are novel in that initiation and dependence are being analyzed together, exploiting the information on co-twins’ dependence as a function of a twin’s initiation status. The model tests for measurement noninvariance of nicotine dependence as a function of age and gender and their interaction.

Subjects

Participants in the present investigation were drawn from two longitudinal studies of adult twins, conducted in parallel;¹ the first consisted of female-female twin pairs (FF) and the second of male-male and male-female twin pairs (MMMF). Each sample was obtained from the population-based Virginia Twin Registry, which is now part of the Mid-Atlantic Twin Registry. The first study was of zygosity determination and was based on questionnaire responses and DNA polymorphisms when required.¹⁵⁰ Telephone interviews were collected from 1,846 individuals in the FF study and from 4,959 individuals in the MMMF study. The final sample includes 1,503 monozygotic males, 1,085 dizygotic males, 1,078 monozygotic females, 768 dizygotic females, and 2,371 dizygotic opposite-gender twin pairs.

Measures

Interviews for both the FF and MMMF studies were highly homologous. In the MMMF study, all common forms of tobacco

self-administration (cigarettes, cigars, pipe tobacco, chewing tobacco, snuff) were assessed, whereas FF study participants were asked only about cigarettes. The focus was on tobacco initiation (TI), regular tobacco use (RTU), and items on the modified version of the FTQ.⁸ TI was defined according to the responses to the questions “have you ever smoked cigarettes?” and the follow-up query “not even once?” RTU was defined as the use of an average of at least seven cigarettes per week for a minimum of four weeks. Individuals who met criteria for RTU were given the FTQ. This scale consists of eight items; three are scored on a two-point scale (number of cigarettes per day, inhale, nicotine level of cigarette brand) and five on a one-point scale (first cigarette soon after waking, difficulty refraining when forbidden, smoking when ill in bed, smoking most in morning, first cigarette most satisfying). The revised FTND¹¹⁰ scale includes only six items (inhale and nicotine level were dropped), with two other items scored on a three-point scale (number of cigarettes per day, first cigarette soon after waking).¹¹⁰ It should be noted that the FTQ and FTND scales are not universally agreed-upon definitions of nicotine dependence, and results obtained with other measures—that is, *DSM* criteria¹⁰⁸—could vary.

Methods

IRT models were used to estimate parameters that represent the “locations” of items on a latent continuum. The model describes the probability of a discrete response to an item as a function of a person parameter (their location on the latent trait) and one or more item parameters. In the two-parameter case, one parameter represents the location, and in the case of attainment testing, is referred to as the “item difficulty.” The second parameter estimates the discrimination of the item—that is, the degree to which the item distinguishes between persons who have different scores on the latent trait. This second parameter characterizes the slope of

the item characteristic curve. The difficulty parameter relates to the location of the curve on the continuum. These models can be extended to data on pairs of twins, and the trait variance can be partitioned into sources due to additive genetic, shared environmental, and specific environmental factors. The parameterization of these models is similar to that of the common pathway/latent phenotype model,²⁰ which allows for variance partitioning at two levels: (1) the latent trait—that is, nicotine dependence, and (2) the residual item variances. The parameters of the genetic IRT model thus include item discrimination parameters (which correspond to factor loadings), item difficulties (which correspond to thresholds), and genetic and environmental parameters of the items and construct. As is typical for twin analyses, factor loadings are constrained to be the same for monozygotic and dizygotic twins. This assumption seems reasonable because it is unlikely that zygosity has a main effect on the measurement of the latent trait; however, it could be evaluated empirically by testing for measurement invariance of factor loadings as a function of zygosity. In the present analysis, item thresholds were also constrained to be equal across zygosity. Again, this assumption could be relaxed to test for possible sibling interaction, which results in differences in thresholds by zygosity.¹⁵¹ All analyses were performed using the Mx statistical modeling package,¹⁴ Mx scripts are available on the Mx website.¹⁵² Note that for identification purposes, the variance of the factor was fixed to one (but allowed to differ as a function of the covariates) and an estimate was made of all factor loadings rather than arbitrarily fixing one factor loading to one. This has implications for the choice of model testing for measurement invariance.

Results

The twin sample contained 6,805 individuals; 55% were male and 44% were female.

The mean age was 36.2 (standard deviation 8.6) years with a range of 20.4–59.5 years. Overall, 78% reported lifetime TI, and 54% had smoked regularly and thus completed the FTQ. Consistent with previous analyses, which included TI and RTU when estimating the contributions of genetic and environmental factors to nicotine dependence in the CCC pathway model, TI and RTU were included together with the eight FTQ items, assuming neither independence nor unidimensionality of TI and nicotine dependence. Results were compared by using the traditional eight FTQ items, allowing for multiple thresholds as necessary, and the revised six FTND items. Results showed that factor loadings were consistently higher when including TI and RTU compared to those from analyses that (1) included TI alone and (2) included neither of the conditional variables (figure 6.6A). Similarly, prevalences were consistently lower when including TI and RTU, properly adjusting these parameters for the fact that only a selected sample was given the FTQ (figure 6.6B). Of note is that the genetic and environmental parameters were biased when not taking TI and RTU into account. These findings were observed for males and females.

When comparing results from analyses including the FTQ scoring with those including only the six FTND items, the two items not included in the FTND showed a different pattern of factor loadings and prevalences than the other items (figures 6.7A and 6.7B). The inhale item showed very high prevalence, resulting in little variance; the high-nicotine-level item exhibited the lowest factor loadings and clear difference in prevalence by gender. Therefore, the presentation of the results of the genetic analyses with IT, RTU, and the six FTND items is limited here, although the results using the full FTQ items did not differ substantially.

A strict order of model testing was followed and measurement properties were evaluated

before testing alternative genetic models. One of the common hypotheses to test with twin data for females and males is whether the contributions of genes and environment are the same (in magnitude and nature) between both genders. However, if differences exist in the assessment of the phenotype in the two genders, then false conclusions may be drawn from genetic analyses if these measurement differences are not taken into account.⁴ For example, one might conclude that the heritability for the latent phenotype of interest is significantly greater in females than in males, when in fact there are significant gender differences in the factor loadings and/or thresholds, but not in the sources of individual differences. Accordingly, a series of homogeneity and heterogeneity models were fitted to evaluate the degree of measurement invariance (see Neale and Cardon²⁰ for a detailed description of heterogeneity models).

Homogeneity models assume that the contributions of genes and environment to the variance (both at the level of the factor, and at the item level, that is, residual variances) are equal for both genders. First, a measurement invariant model was used in which factor mean and variance, factor loadings, and thresholds were the same by gender and age. Then the factor mean and/or factor variance were tested for difference by gender and age (given the large age distribution of the sample) and their interaction. Further testing was conducted to determine significant effects of the covariates on the factor loadings in addition to the factor mean or on the item thresholds in addition to the factor variance. Given that one estimates all factor loadings and fixes the factor variance, one cannot at this stage estimate all factor loadings in addition to the factor variance. Finally, the most saturated measurement model was fitted allowing for covariate effects on both the item thresholds and factor loadings. This series of tests was then repeated for heterogeneity models,

Figure 6.6 Estimates of Factor Loadings (A) and Thresholds (B) of Nicotine-Dependence Items in Female Twins from the Virginia Twin Registry

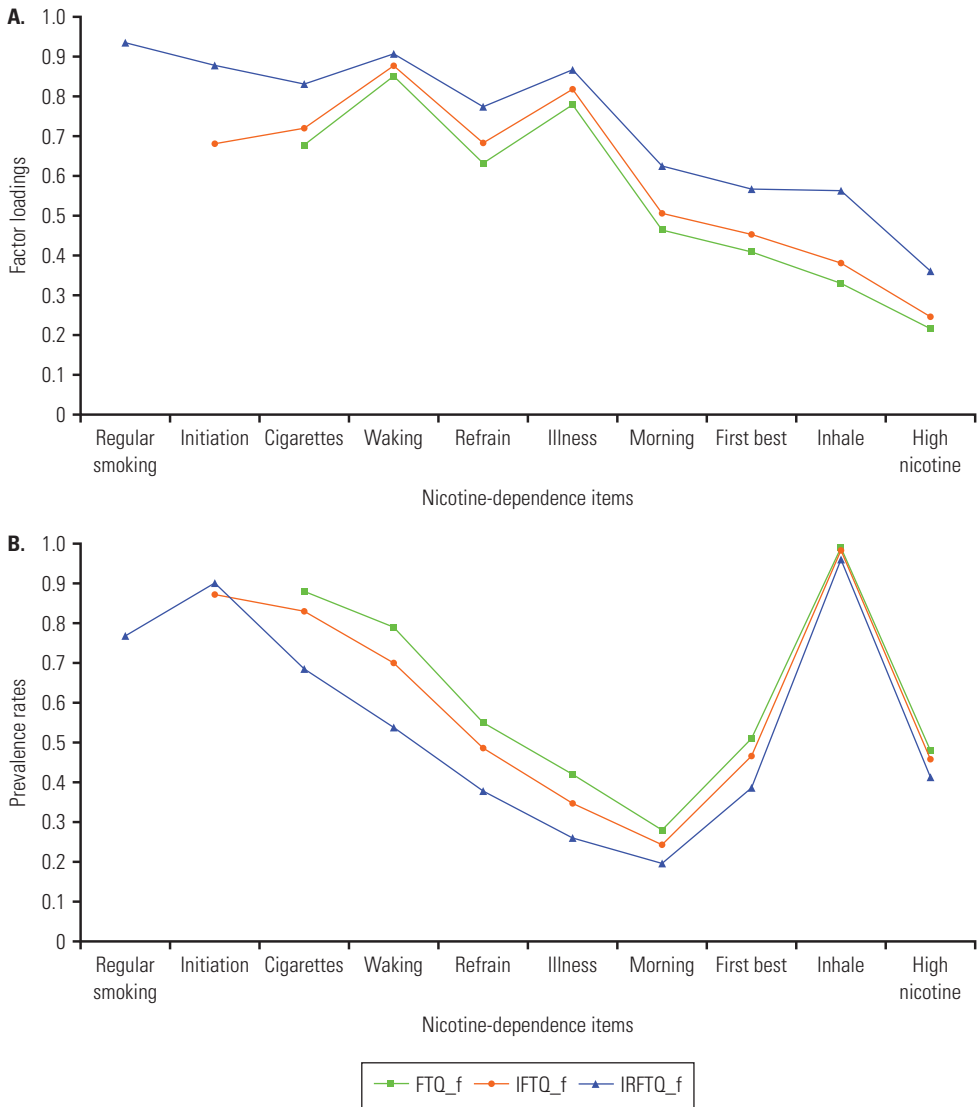

Note. Separate lines depict the effect of including tobacco initiation (TI) and regular tobacco use (RTU) items. FTQ = Fagerström Tolerance Questionnaire; f = female; IFTQ = FTQ items plus initiation; IRFTQ = FTQ items plus initiation and regular tobacco use.

which allow the magnitude of the genetic and environmental contributions to differ by gender. A comparison of the two series of models provides a gender heterogeneity test for the role of genes and environment. Table 6.2 presents selected results from these genetic analyses of nicotine dependence.

When fitting the homogeneity models (columns 2–4) to the adult nicotine-dependence data, significant effects were found of gender and age on both the factor mean and factor variance (models 2 and 3). Differences by gender and age were then tested at the item level—that is, differences

Figure 6.7 Estimates of Factor Loadings (A) and Thresholds (B) of Nicotine-Dependence Items Plotted by Gender and Measurement Instrument (FTQ or FTND Scale)

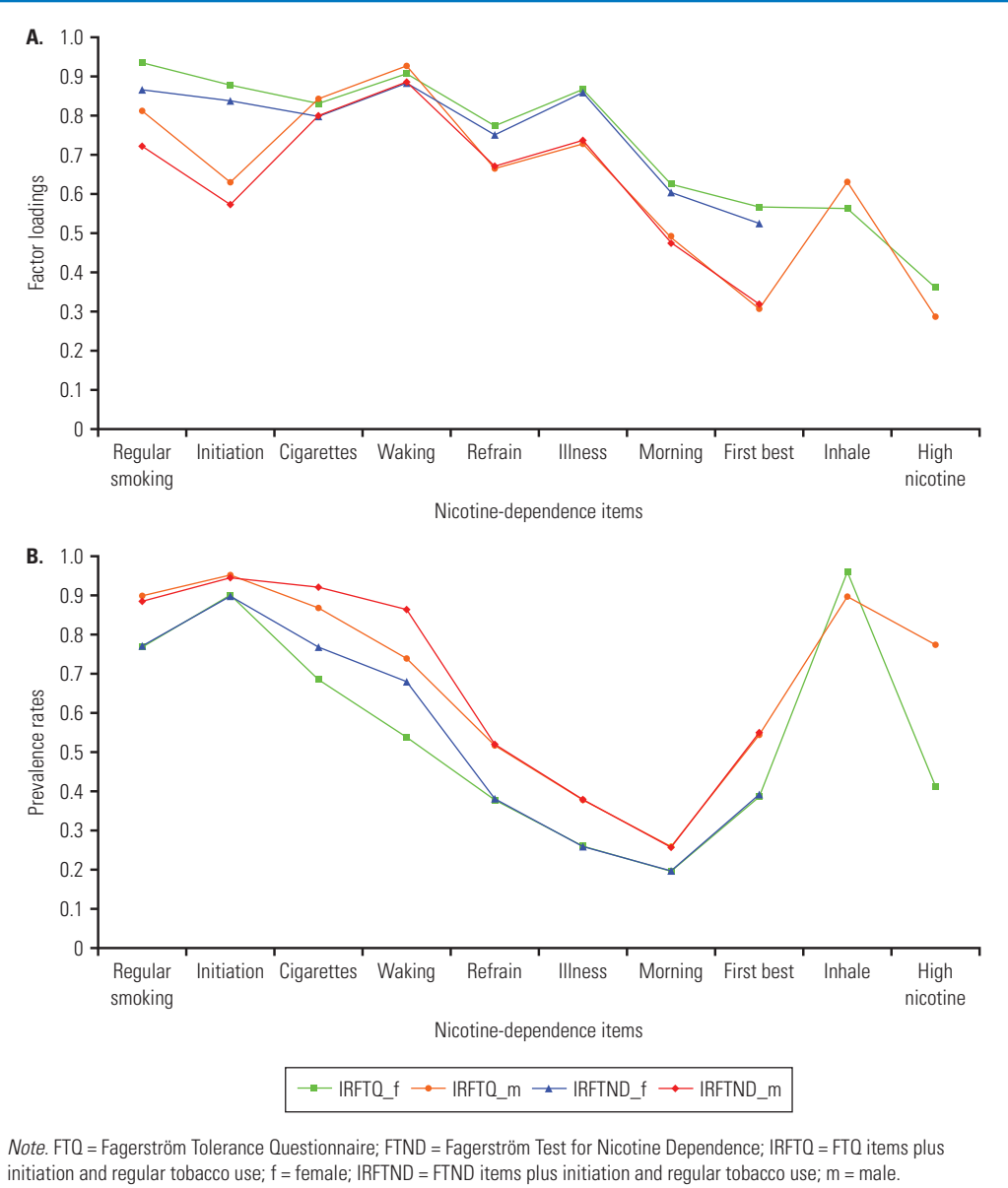

in thresholds and factor loadings. Results indicated that thresholds were significantly different by age (model 4) and gender (model 5). Furthermore, factor loadings differed significantly by age (model 6) and between males and females (model 7). When testing was conducted for measurement

invariance of the factor loadings allowing for differences in thresholds by gender, age and their interaction, only gender differences in factor loadings were found to be significant (model 9). Similar results were obtained when heterogeneity models were fitted (columns 5–7). The gender heterogeneity

Table 6.2 Results from Fitting Measurement Noninvariance and Gender Heterogeneity Models to Nicotine Initiation and Dependence Data Collected from Twins

	Homogeneity models			Heterogeneity models			Gender heterogeneity test		
	-2LL	ep	AIC	-2LL	ep	AIC	$\Delta\chi^2$	df	p
1. Invariance	52474.92	38	-24729.1	52436.76	57	-24729.2	38.16	18	0.00
Factor mean and factor variance									
2. Age	52075.79	42	-25120.2	52039.78	61	-25118.2	36.01	18	0.01
3. Gender	52075.19	42	-25120.8	52044.87	61	-25113.1	30.33	18	0.05
Item thresholds and factor variance									
4. Age	52259.44	49	-24922.6	52222.72	68	-24921.3	36.72	18	0.01
5. Gender	51976.54	49	-25205.5	51952.14	68	-25191.9	24.40	18	0.14
Factor mean and factor loadings									
6. Age	52046.74	49	-25135.3	52014.43	68	-25129.6	32.31	18	0.02
7. Gender	52017.26	49	-25164.7	51989.19	68	-25154.8	28.07	18	0.06
Item thresholds and factor loadings									
8. Age	51765.04	70	-25375.0	51747.36	89	-25354.6	17.68	18	0.48
9. Gender	51742.11	70	-25397.9	51724.14	89	-25377.9	17.97	18	0.46
Submodels of model 9									
10. GE variance of factor	51732.84	73	-25401.2				9.27	2	0.01
11. GE variance of items	51733.48	86	-25374.5				8.63	16	0.93

Note. -2LL = minus twice the log-likelihood of the data; ep = number of estimated parameters; AIC = Akaike Information Criterion; $\Delta\chi^2$ = difference chi-square statistic; df = degrees of freedom; p = probability; GE = genetic and environmental.

tests (last three columns, 8–10) compare the corresponding homogeneity and heterogeneity models. For the measurement invariant models (model 1), as well as for models with limited measurement variance—that is, age variant and gender invariant (models 2, 4, and 6)—the gender heterogeneity tests are significant, suggesting that the contributions of genes and environment to the factor and the items differ significantly. However, when allowing for gender differences at the measurement level (thresholds and factor loadings), the combined genetic and environmental parameters—that is, at the factor and item level—did not differ significantly between males and females, resulting in homogeneity model 9 as the best fitting model (by the Akaike Information Criterion [AIC]).

A further exploration was made of whether the difference in fit between homogeneity

and heterogeneity models 9, although not significant, was explained by differences in the genetic and environmental contributions to the factor variance or to the residual item variances. A model allowing for different magnitudes of genetic and environmental contributions to the latent construct (but equating genetic and environmental parameters at the item level between the genders) (model 10) further significantly improved the overall fit of the model over model 9 and resulted in a lower AIC. The converse—different variance components at the item level but not at the factor level (model 11)—did not result in improvement of fit over model 9. Thus, the overall conclusion is that significant gender differences exist at the measurement level (both thresholds and factor loadings). If one is prepared to assume that the same factors are operating in males and females of different ages, and that the measurement

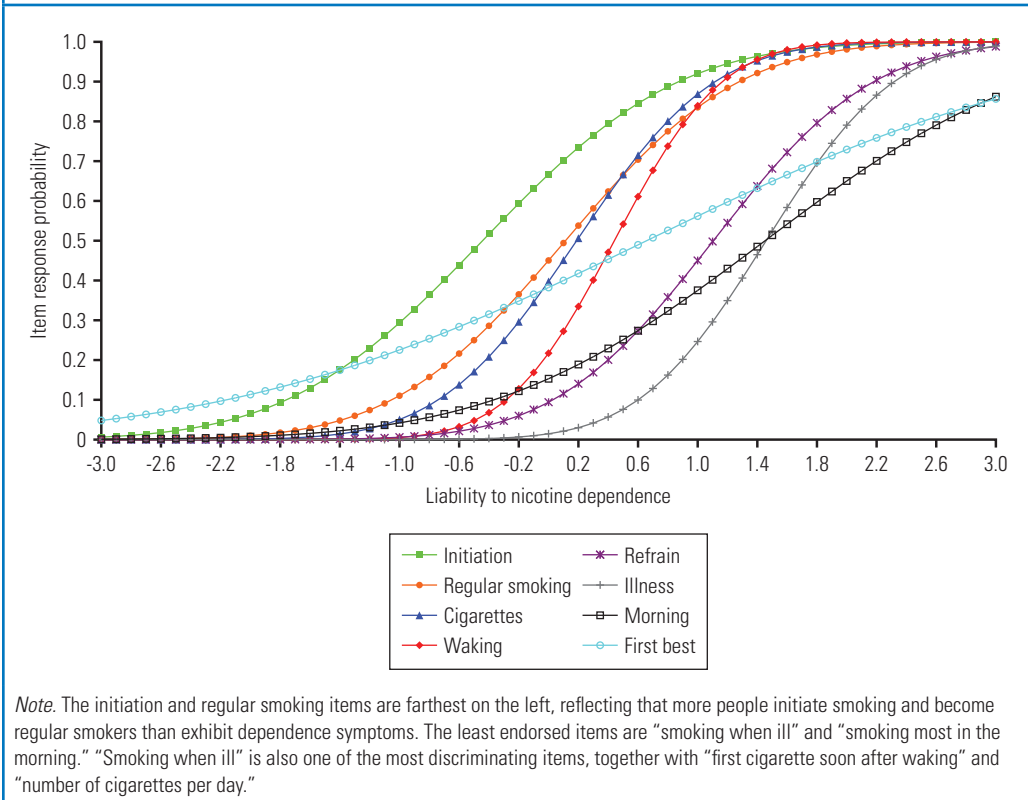
Figure 6.8 Estimates of Nicotine-Dependence Item Characteristic Curves for 20-Year-Old Females

noninvariance is due to differential sensitivity of certain items, then it would appear that the genetic and environmental factors have different magnitudes of effect at the factor level, but not at the item level. Age also has a significant effect on the thresholds but not on the factor loadings. If these differences in measurement had been ignored, it would have been wrongly concluded that the genetic and environmental contributions were different for males and females not only at the factor level but also at the item level.

The information about the contributions of the individual items to the latent construct of nicotine dependence is best viewed using ICCs in which the slope of the curve reflects the factor loading or indicates how well the item discriminates people who have nicotine

dependence from those who have not. The threshold corresponds to the point of inflection of the curve that marks the level at which individuals have a 50% chance of endorsing the item and relates to the endorsement frequency of the items. Thus, the higher the factor loading, the steeper the curve; the higher the threshold, the more to the right of the underlying liability distribution is the curve. As these measurement parameters may be moderated by gender and age, the curves will depend on the particular values of the covariates. Figure 6.8 shows the ICCs for 20-year-old females.

The curves have fairly good coverage in that from -2 to 3 SDs there is likely to be variation in the response patterns. Below -2 SDs, almost all respondents would likely

respond in the lowest category on all items. At +3 SDs, responses would be almost all in the highest response category, although some 15% may be expected not to do so for the “first best” and “morning” items. Because of its relatively flat slope, the “first best” item would also be most likely to be responded to positively at the low end of the scale. In a sum score approach, this item would therefore perform inconsistently and might be considered for deletion.

When curves were compared by the level of the covariates, the ICCs for males are shifted to the left compared to those for females, reflecting the more frequent endorsement of most of the items by males than by females. Similarly, curves for older individuals are shifted to the left of those of younger individuals. The slopes of the curves differ only by gender, and all but one (first cigarette soon after waking) is steeper for males than females. The same information is gleaned from figures 6.9A and 6.9B, which depict the factor loadings and thresholds, respectively.

Separate lines represent the different levels of the categorical covariates. For continuous covariates, such as age, estimates are shown for minimum and maximum of the range of the covariate in the sample. The remaining two panels of figure 6.9 present the estimates of the genetic variance (heritability) of each of the items separately for the heritability through the common factor and the residual heritability. The heritability of the latent factor is also shown. Note that the latter was significantly different in males and females, explaining, respectively, 80% and 58% of the variance. Thus, the heritability of the items resulting from the latent factor also differed by gender and reflects the factor loadings of the items.

Interestingly, the pattern of genetic contributions to the residual variance of the items, independent of the latent nicotine-dependence factor, is quite distinct,

with initiation and regular smoking exhibiting the largest genetic variance specific to them. This is consistent with previous results from fitting CCC pathway models to these data, which suggested that the genetic factors for TI, RTU, and nicotine dependence were correlated, but not identical dimensions, and that specific genetic factors influence each stage of the smoking behavior continuum. Shared environmental factors contributed about 20% to the latent nicotine-dependence factor in females but were negligible in males (not shown). They also accounted for zero to 8% of the residual item variances. Specific environmental factors explained about 20% of the factor variance in males and females, and between 18% and 32% of the residual item variances, except for “smoking most in morning” and “first cigarette most satisfying,” which accounted for about 65% of the variance.

Study Conclusions

This analysis has shown the importance of taking the assessment of nicotine dependence into account when estimating the role of genetic and environmental factors in the liability to nicotine dependence. When measurement invariance of nicotine initiation and dependence by age and gender was assumed, significant gender heterogeneity was found in the contributions of genes and environment to both age and gender at the factor level and the item level. However, when measurement invariance was accounted for, the overall gender heterogeneity test was not significant, suggesting no differences in the magnitude of genetic and environmental influences in males and females. Model fit further improved when these influences were allowed to differ at the factor level but not the item level. One could argue that when measurement is not invariant by gender, the common factor is measuring something different, or at least the latent factor is measured on a different metric in males and females, which makes it difficult to

Figure 6.9 Estimates of Factor Loadings (A), Thresholds (B), Genetic Variance Components Due to the Factor (C), and Residual Item-Specific Genetic Variance Components (D) in Virginia Twin Registry Males

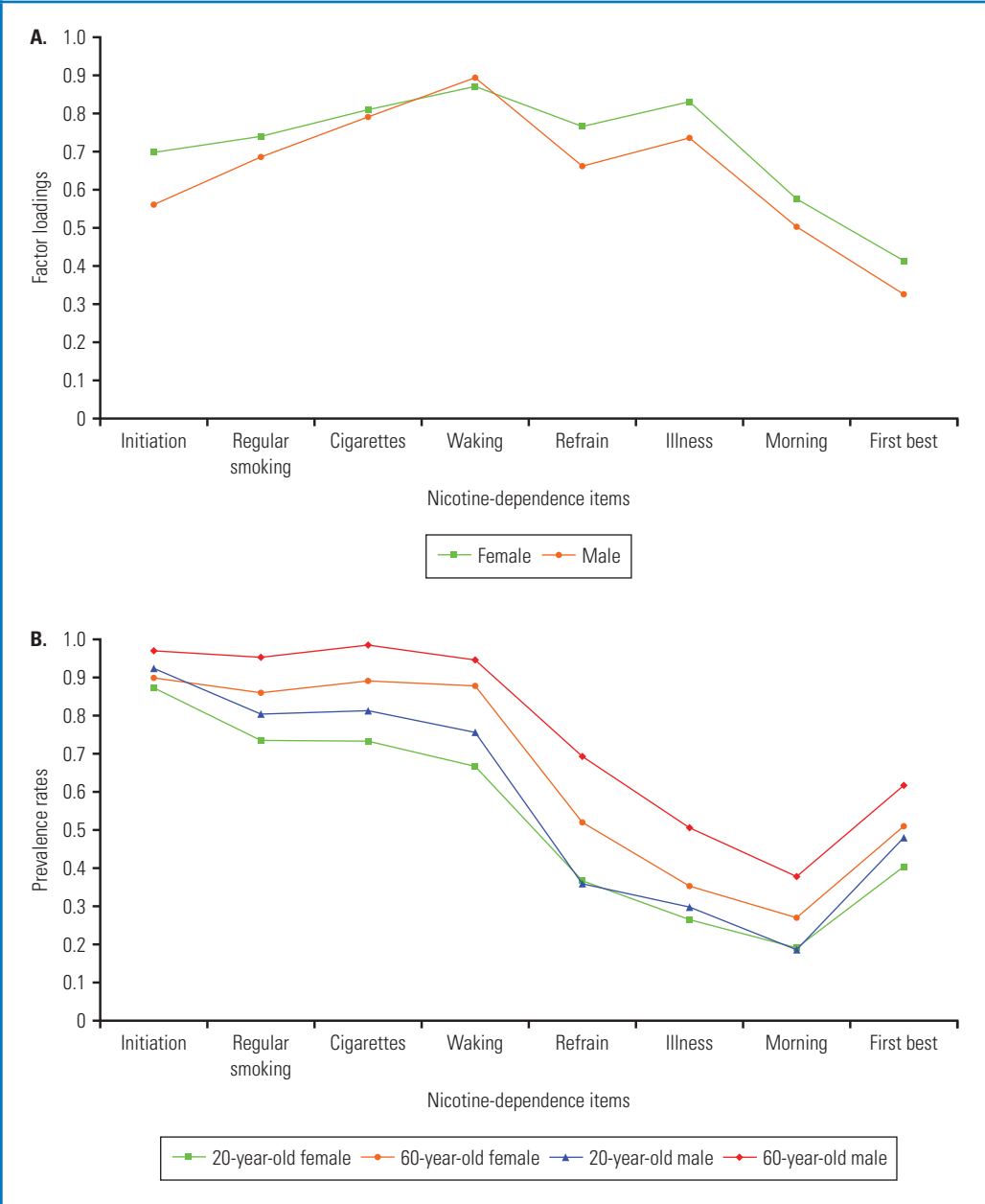

interpret results of differences in heritability of the common factor. Although caution in interpretation is needed, it is argued that by allowing for limited measurement

differences—due to differential sensitivity of items by gender—inferences about heterogeneity of heritability by gender at the latent factor become more meaningful.

Figure 6.9 Estimates of Factor Loadings (A), Thresholds (B), Genetic Variance Components Due to the Factor (C), and Residual Item-Specific Genetic Variance Components (D) in Virginia Twin Registry Males (*continued*)

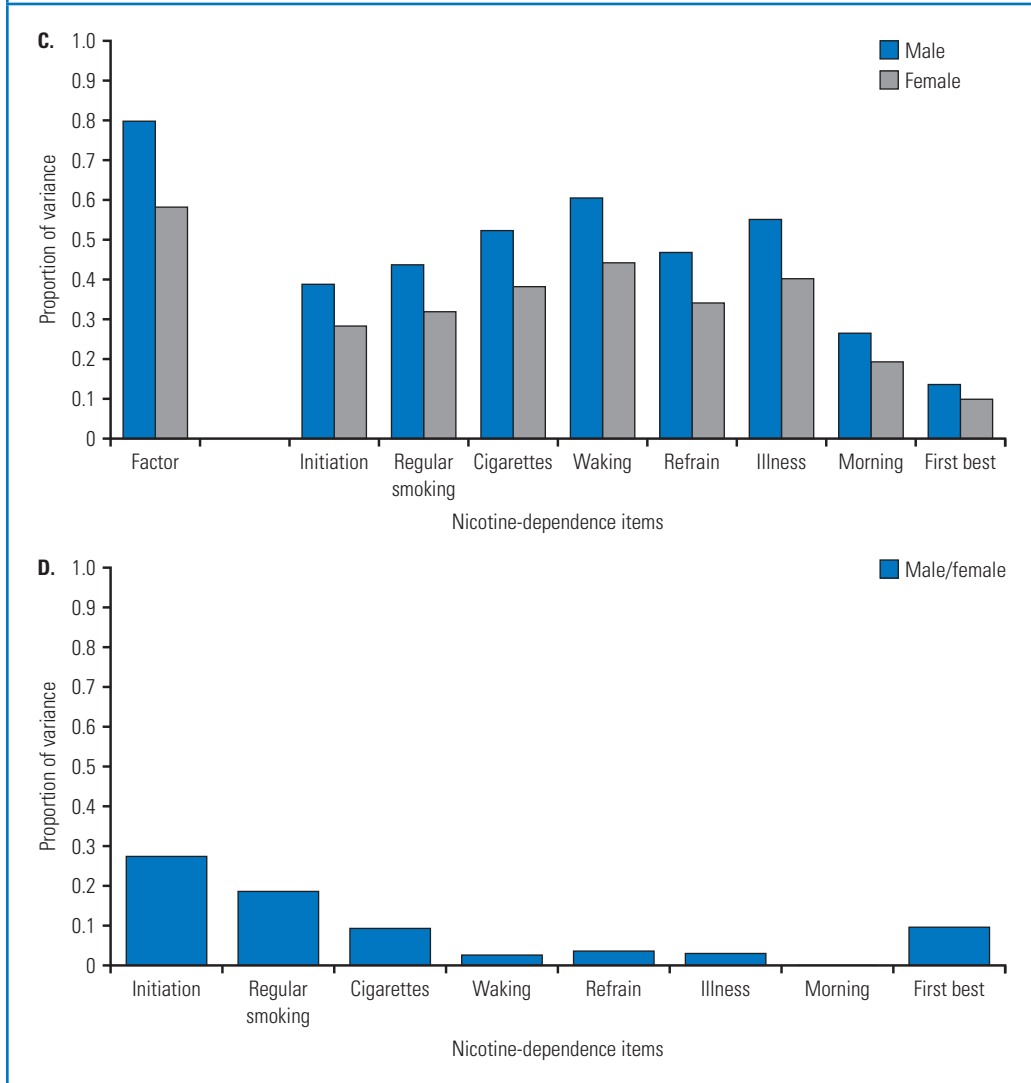

In the current application, factor loadings are slightly shifted upward in males versus females and prevalences are consistently higher in males and older individuals. In situations in which some items have substantially higher factor loadings and/or thresholds in one gender and other items in the other gender, comparing gender heterogeneity at the factor level may become problematic.

Second, it appears that an item response framework is to be preferred over a sum score approach in which differential item functioning would be obscured and each item weighted equally, regardless of their correlation with the latent construct to be measured. Finally, as was shown previously in using the CCC pathway model to estimate the heritability of nicotine dependence, and repeated in the current

analysis, it is important to include smoking initiation and regular smoking to obtain unbiased estimates of the factor loadings and thresholds. Factor scores from such an analysis should provide a more accurate quantitative phenotype that will improve the ability to find and replicate susceptibility genes for nicotine dependence.

Previous studies of the heritability of nicotine dependence reported estimates between .4 and .7, with little evidence for gender differences. The current analysis estimated heritability of nicotine dependence to be .8 in males and .6 in females. These estimates are significantly different. Estimates of factor loadings and thresholds increased or decreased up to .2 units when measurement variance was allowed and conditional variables such as initiation and regular smoking were included. At this point, one can only speculate about whether this difference proves to be relevant in the search for specific genes or environments that influence smoking behavior and whether it might guide prevention efforts.

Limitations

Although the twin study is one of the most powerful designs to estimate the contributions of genetic and environmental factors to a phenotype of interest, several assumptions are made. One of the most often voiced criticisms of the classical twin study is the equal environments assumption, which states that the degree to which trait-relevant environments are shared is the same for monozygotic and dizygotic twins. In one of the few formal examinations of the validity of the equal environment assumption in twin studies, it appeared not to be violated for regular smoking.¹⁵³ Some assumptions can be tested, that is, the random mating can be evaluated when data on spouses are available. A common way to include such data with the twin

design is by extending it with their parents. The twin-parent design also allows one to disentangle genetic transmission from environmental transmission, which are confounded in nuclear family parent-offspring correlations. Other designs, however, such as adoption studies or COT designs may be more powerful to sort out transmission from parents to offspring.

Another limitation of studies is the vague assessment of the phenotype. Typically, smoking initiation is assessed with simple questions such as, “Have you ever smoked?” However, how initiation is operationalized for data analysis varies considerably, or the same question may be interpreted differently by younger and older individuals or vary by the status/stage of an individual’s smoking behavior. With regard to nicotine dependence, the FTND is widely used, although it is not considered the gold standard. Typically, a sum score is derived, although factor analyses have suggested that factor loadings vary considerably and that two factors might better account for the item correlations. There also appears to be limited overlap between the FTND-based and *DSM*-based assessment of nicotine dependence.

Except for six studies of smoking behavior in adolescents, the majority of the research has focused on adult samples. It is likely incorrect to assume that the same results would be obtained with adolescent samples. Additional complications arise, however, when using data on adolescents in that adolescents have not passed through the main period of uptake of smoking behavior. Thus, the data are left censored and may require approaches based on survival analysis.

While most studies have included both males and females, this is not true for ethnicity, and no adolescent studies on non-Caucasian populations were found. Furthermore, the vast majority of studies on adults are based on Caucasian samples.

Redden and Allison⁷⁵ note that assortative mating can increase the risk of type I error in association studies; accordingly, this is a risk for association studies of nicotine initiation and dependence.

Summary

The main goal of this chapter is to provide a review of methods for, and applied analyses of, the genetic epidemiological study of nicotine dependence. A secondary aim is to demonstrate that data collected from relatives provide qualitatively different information, which can be used to overcome certain limitations of data collected from unrelated individuals. In the process, the ability to assess the relationship between initiation and dependence by estimating parameters of a factor model applied to data on nicotine initiation as well as the FTND, was exploited. In addition to providing the reader with a general impression of the genetic epidemiology of nicotine dependence, this review has identified a number of further opportunities for model development and data analysis.

Data from relatives do not merely provide a way to partition variation into genetic and environmental components. Especially important for the study of tobacco use, abuse, and dependence is the potential to examine the association between initiation and subsequent progression. The proxy information gleaned from comparing the rate of progression in pairs of relatives who are concordant for initiation to the rate in those who are discordant for initiation allows a number of hypotheses and assumptions to be tested. At the most basic level, one can assess measurement invariance assumptions, which address whether dependence items perform equally well at measuring the latent trait of nicotine dependence in males and females and at different ages. To some extent, this is a *sine qua non* of epidemiological research into

complex behavioral traits. In the absence of measurement invariance tests, one cannot draw unambiguous conclusions about development, trajectories, or even the efficacy of treatments.

Conclusions

1. Data from twin studies suggest that shared environmental factors are the predominant source of familial resemblance in liability to smoking initiation in young adolescents, while additive genetic factors appear more important in older adolescents.
2. Results from extended twin designs show that significant assortative mating exists for smoking initiation and that the parent-child correlations can be almost entirely accounted for by genetic factors. This implies a limited environmental influence of parental smoking initiation on smoking initiation in their children.
3. In contrast to the significant role of shared environmental factors in smoking initiation, the liability to smoking persistence and nicotine dependence appears to be primarily accounted for by additive genetic factors. Furthermore, the liabilities to initiation and progression appear to be substantially correlated. Molecular genetic studies may be expected to find some genetic variants that contribute specifically to initiation—some that are specific to dependence and some that contribute to both.
4. Future development and applications of genetic latent growth curve models and genetic latent class models promise to improve the understanding of the role of genes and environment in smoking trajectories and transitions from nonsmoker to smoking dependence.
5. The search for susceptibility loci for smoking-related traits, either through

linkage or association studies, has not identified any convincing replicated findings. However, several genomic regions and several candidate genes have been found to be associated with smoking behavior in more than one study.

6. Improving the assessment of nicotine initiation and dependence by allowing for differences in measurement by age and gender and taking conditionality into account might provide more accurate estimates of the contributions

of genes and environment to different stages of smoking.

7. Meta-analyses or mega-analyses of studies of smoking phenotypes—both genetic epidemiological and molecular genetic—should prove useful in summarizing the available data and results. Possibly, certain data sets may produce results that are outliers, and controlling for their effects would permit finer resolution between hypotheses and more accurate parameter estimates.

References

1. Kendler, K. S., M. C. Neale, P. Sullivan, L. A. Corey, C. O. Gardner, and C. A. Prescott. 1999. A population-based twin study in women of smoking initiation and nicotine dependence. *Psychological Medicine* 29 (2): 299–308.
2. Sung, M., A. Erkanli, A. Angold, and E. J. Costello. 2004. Effects of age at first substance use and psychiatric comorbidity on the development of substance use disorders. *Drug and Alcohol Dependence* 75 (3): 287–99.
3. Mehta, P. D., M. C. Neale, and B. R. Flay. 2004. Squeezing interval change from ordinal panel data: Latent growth curves with ordinal outcomes. *Psychological Methods* 9 (3): 301–33.
4. Lubke, G. H., C. V. Dolan, and M. C. Neale. 2004. Implications of absence of measurement invariance for detecting sex limitation and genotype by environment interaction. *Twin Research* 7 (3): 292–98.
5. Meredith, W. 1993. Measurement invariance, factor analysis and factorial invariance. *Psychometrika* 58 (4): 525–43.
6. Vandenberg, R. J., and C. E. Lance. 2000. A review and synthesis of the measurement invariance literature: Suggestions, practices, and recommendations for organizational research. *Organizational Research Methods* 3 (1): 4–69.
7. Vandenberg, R. J. 2002. Toward a further understanding of an improvement in measurement invariance methods and procedures. *Organizational Research Methods* 5 (2): 139–58.
8. Fagerström, K. O., and N. G. Schneider. 1989. Measuring nicotine dependence: A review of the Fagerström Tolerance Questionnaire. *Journal of Behavioral Medicine* 12 (2): 159–82.
9. Wright, S. 1934. The method of path coefficients. *Annals of Mathematical Statistics* 5: 161–215.
10. Bollen, K. A. 1989. *Structural equations with latent variables*. Oxford, UK: John Wiley & Sons.
11. Wright, S. 1921. Correlation and causation. *Journal of Agricultural Research* 20:557–85.
12. Sörbom, D. 1974. A general method for studying differences in factor means and factor structures between groups. *British Journal of Mathematical and Statistical Psychology* 27: 229–39.
13. McArdle, J. J., and S. M. Boker. 1986. *RAMpath - path diagram software*. Denver: Data Transforms.
14. Neale, M. C., S. M. Boker, G. Xie, and H. H. Maes. 1997. *Mx: Statistical modeling*. 4th ed. Richmond, VA: Virginia Commonwealth Univ.
15. Mehta, P. D., and S. G. West. 2000. Putting the individual back into individual growth curves. *Psychological Methods* 5 (1): 23–43.
16. Muthén, B. 2001. Latent variable mixture modeling. In *New developments and techniques in structural equation modeling*, ed. G. A. Marcoulides and R. E. Schumacker, 1–33. Mahwah, NJ: Lawrence Erlbaum.
17. Bauer, D. J., and P. J. Curran. 2003. Distributional assumptions of growth mixture models: Implications for overextraction of latent trajectory classes. *Psychological Methods* 8 (3): 338–63.
18. Raudenbush, S. W. 2001. Comparing personal trajectories and drawing causal inferences from longitudinal data. *Annual Review of Psychology* 52:501–25.
19. Stanek, E. J. 3rd, and S. R. Diehl. 1988. Growth curve models of repeated binary response. *Biometrics* 44 (4): 973–83.
20. Neale, M. C., and L. R. Cardon. 1992. *Methodology for genetic studies of twins and families*. New York: Kluwer Academic/Plenum Publishers.
21. Loehlin, J. C., and R. C. Nichols. 1976. *Heredity, environment, and personality: A study of 850 sets of twins*. Austin, TX: Univ. of Texas Press.
22. Rose, R. J., J. Kaprio, C. J. Williams, R. Viken, and K. Obremski. 1990. Social contact and sibling similarity: Facts, issues, and red herrings. *Behavior Genetics* 20 (6): 763–78.
23. Kendler, K. S., M. C. Neale, R. C. Kessler, A. C. Heath, and L. J. Eaves. 1994. Parental treatment and the equal environment assumption in twin studies of psychiatric illness. *Psychological Medicine* 24 (3): 579–90.
24. Truett, K. R., L. J. Eaves, E. E. Walters, A. C. Heath, J. K. Hewitt, J. M. Meyer, J. Silberg, M. C. Neale, N. G. Martin, and K. S. Kendler. 1994. A model system for analysis of family resemblance in extended kinships of twins. *Behavior Genetics* 24 (1): 35–49.

25. Martin, N. G., L. J. Eaves, M. J. Kearsy, and P. Davies. 1978. The power of the classical twin study. *Heredity* 40 (1): 97–116.
26. Neale, M. C., L. J. Eaves, and K. S. Kendler. 1994. The power of the classical twin study to resolve variation in threshold traits. *Behavior Genetics* 24 (3): 239–58.
27. Mather, K., and J. L. Jinks. 1982. *Biometrical genetics 3rd ed.* New York: Chapman and Hall.
28. Jencks, C. 1972. *Inequality: A reassessment of the effect of family and schooling in America.* New York: Basic Books.
29. Eaves, L. J., K. A. Last, P. A. Young, and N. G. Martin. 1978. Model-fitting approaches to the analysis of human behaviour. *Heredity* 41 (3): 249–320.
30. Young, P. A., L. J. Eaves, and H. J. Eysenck. 1980. Intergenerational stability and change in the causes of variation in personality. *Personality and Individual Differences* 1 (1): 35–55.
31. Fulker, D. W. 1982. Extensions of the classical twin method. *Progress in Clinical and Biological Research* 103 Pt A: 395–406.
32. Eaves, L., A. Heath, N. Martin, H. Maes, M. Neale, K. Kendler, K. Kirk, and L. Corey. 1999. Comparing the biological and cultural inheritance of personality and social attitudes in the Virginia 30,000 study of twins and their relatives. *Twin Research* 2 (2): 62–80.
33. Maes, H. H., M. C. Neale, N. G. Martin, A. C. Heath, and L. J. Eaves. 1999. Religious attendance and frequency of alcohol use. Same genes or same environments: A bivariate extended twin kinship model. *Twin Research* 2 (2): 169–79.
34. Kendler, K. S., A. C. Heath, N. G. Martin, and L. J. Eaves. 1987. Symptoms of anxiety and symptoms of depression. Same genes, different environments? *Archives of General Psychiatry* 44 (5): 451–57.
35. McArdle, J. J., and H. H. Goldsmith. 1990. Alternative common factor models for multivariate biometric analyses. *Behavior Genetics* 20 (5): 569–608.
36. Neale, M. C., E. Harvey, H. H. Maes, P. F. Sullivan, and K. S. Kendler. 2006. Extensions to the modeling of initiation and progression: Applications to substance use and abuse. *Behavior Genetics* 36 (4): 507–24.
37. Maes, H. H., P. F. Sullivan, C. M. Bulik, M. C. Neale, C. A. Prescott, L. J. Eaves, and K. S. Kendler. 2004. A twin study of genetic and environmental influences on tobacco initiation, regular tobacco use and nicotine dependence. *Psychological Medicine* 34 (7): 1251–61.
38. Neale, M. C., S. H. Aggen, H. H. Maes, T. S. Kubarych, and J. E. Schmitt. 2006. Methodological issues in the assessment of substance use phenotypes. *Addictive Behaviors* 31 (6): 1010–34.
39. Lubke, G., and M. C. Neale. 2006. Distinguishing between latent classes and continuous factors: Resolution by maximum likelihood? *Multivariate Behavioral Research* 41 (4): 499–532.
40. Muthén, B., and T. Asparouhov. 2006. Item response mixture modeling: Application to tobacco dependence criteria. *Addictive Behaviors* 31 (6): 1050–66.
41. Baker, L. A., C. Reynolds, and E. Phelps. 1992. Biometrical analysis of individual growth curves. *Behavior Genetics* 22 (2): 253–64.
42. Neale, M. C., E. Roysamb, and K. Jacobson. 2006. Multivariate genetic analysis of sex limitation and G x E interaction. *Twin Research and Human Genetics* 9 (4): 481–89.
43. Malthus, T. R. 1789. *An essay on the principle of population as it affects the future improvement of society, with remarks on the speculations of Mr. Godwin, M. Condorcet, and other writers.* London: J. Johnson.
44. Browne, M. W. 1984. Asymptotically distribution-free methods for the analysis of covariance structures. *British Journal of Mathematical and Statistical Psychology* 37 (Pt 1): 62–83.
45. Neale, M. C., and J. J. McArdle. 2000. Structured latent growth curves for twin data. *Twin Research* 3 (3): 165–77.
46. Box, G., G. M. Jenkins, and G. Reinsel. 1994. *Time series analysis: Forecasting and control.* 3rd ed. Englewood Cliffs, NJ: Prentice Hall.
47. Wirth, R. J., and M. C. Edwards. 2007. Item factor analysis: Current approaches and future directions. *Psychological Methods* 12 (1): 58–79.
48. Dolan, C. V., V. D. Schmittmann, G. H. Lubke, and M. C. Neale. 2005. Regime switching in the latent growth curve mixture model. *Structural Equation Modeling* 12 (1): 94–119.

49. Spearman, C. 1904. 'General intelligence,' objectively determined and measured. *American Journal of Psychology* 15 (2): 201–93.
50. Lazarsfeld, P. F., and N. W. Henry. 1968. *Latent structure analysis*. Boston, MA: Houghton Mifflin.
51. Lazarsfeld, P. F. 1950. Some latent structures. In *The American soldier: Studies in social psychology in World War II*, vol. 4, ed. S. A. Stouffer. Princeton, NJ: Princeton Univ. Press.
52. Vermunt, J. K., and J. Magidson. 2002. Latent class cluster analysis. In *Advances in latent class analysis*, ed. J. Hagenaars and A. McCutcheon, 89–106. Cambridge, UK: Cambridge Univ. Press.
53. Bartholomew, D. J. 1987. *Latent variable models and factor analysis*. New York: Oxford Univ. Press.
54. McLachlan, G., and D. Peel. 2000. *Finite mixture models*. New York: John Wiley and Sons.
55. Arminger, G., P. Stein, and J. Wittenberg. 1999. Mixtures of conditional mean- and covariance-structure models. *Psychometrika* 64 (4): 475–94.
56. Dolan, C. V., and H. L. J. van der Maas. 1998. Fitting multivariate normal finite mixtures subject to structural equation modeling. *Psychometrika* 63 (3): 227–53.
57. Jedidi, K., H. S. Jagpal, and W. S. DeSarbo. 1997. Finite-mixture structural equation models for response-based segmentation and unobserved heterogeneity. *Marketing Science* 16 (1): 39–59.
58. Yung, Y.-F. 1997. Finite mixtures in confirmatory factor-analysis models. *Psychometrika* 62 (3): 297–330.
59. Muthén, B. O. 2001. Second-generation structural equation modeling with a combination of categorical and continuous latent variables: New opportunities for latent class/latent growth modeling. In *New methods for the analysis of change*, ed. L. M. Collins and A. Sayer, 291–322. Washington, DC: American Psychological Association.
60. Muthén, B. O., and K. Shedden. 1999. Finite mixture modeling with mixture outcomes using the EM algorithm. *Biometrics* 55 (2): 463–69.
61. Eaves, L. J., J. L. Silberg, J. K. Hewitt, M. Rutter, J. M. Meyer, M. C. Neale, and A. Pickles. 1993. Analyzing twin resemblance in multisymptom data: Genetic applications of a latent class model for symptoms of conduct disorder in juvenile boys. *Behavior Genetics* 23 (1): 5–19.
62. Gillespie, N. A., and M. C. Neale. 2006. A finite mixture model for genotype and environment interactions: Detecting latent population heterogeneity. *Twin Research and Human Genetics* 9 (3): 412–23.
63. Muthén, B., T. Asparouhov, and I. Rebollo. 2006. Advances in behavioral genetics modeling using Mplus: Applications of factor mixture modeling to twin data. *Twin Research and Human Genetics* 9 (3): 313–24.
64. Li, F., T. E. Duncan, and H. Hops. 2001. Examining developmental trajectories in adolescent alcohol use using piecewise growth mixture modeling analysis. *Journal of Studies on Alcohol* 62 (2): 199–210.
65. Li, M. D. 1976. *First course in population genetics*. Pacific Grove, CA: Boxwood Press.
66. Morton, N. E. 1982. *Outline of genetic epidemiology*. New York: Karger.
67. Fulker, D. W., and S. S. Cherny. 1996. An improved multipoint sib-pair analysis of quantitative traits. *Behavior Genetics* 26 (5): 527–32.
68. Eaves, L. J., M. C. Neale, and H. Maes. 1996. Multivariate multipoint linkage analysis of quantitative trait loci. *Behavior Genetics* 26 (5): 519–25.
69. Lander, E., and L. Kruglyak. 1995. Genetic dissection of complex traits: Guidelines for interpreting and reporting linkage results. *Nature Genetics* 11 (3): 241–47.
70. Abecasis, G. R., S. S. Cherny, W. O. Cookson, and L. R. Cardon. 2002. Merlin—rapid analysis of dense genetic maps using sparse gene flow trees. *Nature Genetics* 30 (1): 97–101.
71. Kruglyak, L., M. J. Daly, M. P. Reeve-Daly, and E. S. Lander. 1996. Parametric and nonparametric linkage analysis: A unified multipoint approach. *American Journal of Human Genetics* 58 (6): 1347–63.
72. Pritchard, J. K., and N. A. Rosenberg. 1999. Use of unlinked genetic markers to detect population stratification in association studies. *American Journal of Human Genetics* 65 (1): 220–28.
73. Fulker, D. W., S. S. Cherny, P. C. Sham, and J. K. Hewitt. 1999. Combined linkage and association sib-pair analysis for quantitative traits. *American Journal of Human Genetics* 64 (1): 259–67.

74. Cardon, L. R., and G. R. Abecasis. 2000. Some properties of a variance components model for fine-mapping quantitative trait loci. *Behavior Genetics* 30 (3): 235–43.
75. Redden, D. T., and D. B. Allison. 2006. The effect of assortative mating upon genetic association studies: Spurious associations and population substructure in the absence of admixture. *Behavior Genetics* 36 (5): 678–86.
76. van den Oord, E. J., and H. Snieder. 2002. Including measured genotypes in statistical models to study the interplay of multiple factors affecting complex traits. *Behavior Genetics* 32 (1): 1–22.
77. Sullivan, P. F., and K. S. Kendler. 1999. The genetic epidemiology of smoking. *Nicotine & Tobacco Research* 1 Suppl. 2: S51–S57, S69–S70.
78. Li, M. D. 2003. The genetics of smoking related behavior: A brief review. *American Journal of the Medical Sciences* 326 (4): 168–73.
79. Centers for Disease Control and Prevention. 2007. Cigarette smoking among adults—United States, 2006. *Morbidity and Mortality Weekly Report* 56 (44): 1157–61.
80. Boomsma, D. I., J. R. Koopmans, L. J. Van Doornen, and J. F. Orlebeke. 1994. Genetic and social influences on starting to smoke: A study of Dutch adolescent twins and their parents. *Addiction* 89 (2): 219–26.
81. Koopmans, J. R., L. J. van Doornen, and D. I. Boomsma. 1997. Association between alcohol use and smoking in adolescent and young adult twins: A bivariate genetic analysis. *Alcoholism, Clinical and Experimental Research* 21 (3): 537–46.
82. Kaprio, J., D. I. Boomsma, K. Heikkilä, M. Koskenvuo, K. Romanov, R. J. Rose, R. J. Viken, and T. Winter. 1995. Genetic variation in behavioral risk factors to risk for atherosclerosis: A twin family study of smoking and cynical hostility. In *Atherosclerosis X: Proceedings of the Xth International Symposium on Atherosclerosis*, ed. F. P. Woodford, J. Davignon, and A. Sniderman, 634–37. Amsterdam: Elsevier Science.
83. Dick, D. M., S. Barman, and T. Pitkänen. 2006. Genetic and environmental influences on the initiation and continuation of smoking and drinking. *Socioemotional development and health from adolescence to adulthood*, ed. L. Pulkkinen, J. Kaprio, and R. J. Rose, 126–45. New York: Cambridge Univ. Press.
84. Rose, R. J., R. J. Viken, D. M. Dick, J. E. Bates, L. Pulkkinen, and J. Kaprio. 2003. It does take a village: Nonfamilial environments and children's behavior. *Psychological Science* 14 (3): 273–77.
85. Maes, H. H., C. E. Woodard, L. Murrelle, J. M. Meyer, J. L. Silberg, J. K. Hewitt, M. Rutter, et al. 1999. Tobacco, alcohol and drug use in eight- to sixteen-year-old twins: The Virginia Twin Study of Adolescent Behavioral Development. *Journal of Studies on Alcohol* 60 (3): 293–305.
86. Han, C., M. K. McGue, and W. G. Iacono. 1999. Lifetime tobacco, alcohol and other substance use in adolescent Minnesota twins: Univariate and multivariate behavioral genetic analyses. *Addiction* 94 (7): 981–93.
87. McGue, M., I. Elkins, and W. G. Iacono. 2000. Genetic and environmental influences on adolescent substance use and abuse. *American Journal of Medical Genetics* 96 (5): 671–77.
88. Rhee, S. H., J. K. Hewitt, S. E. Young, R. P. Corley, T. J. Crowley, and M. C. Stallings. 2003. Genetic and environmental influences on substance initiation, use, and problem use in adolescents. *Archives of General Psychiatry* 60 (12): 1256–64.
89. White, V. M., J. L. Hopper, A. J. Wearing, and D. J. Hill. 2003. The role of genes in tobacco smoking during adolescence and young adulthood: A multivariate behaviour genetic investigation. *Addiction* 98 (8): 1087–1100.
90. Rende, R., C. Slomkowski, J. McCaffery, E. E. Lloyd-Richardson, and R. Niaura. 2005. A twin-sibling study of tobacco use in adolescence: Etiology of individual differences and extreme scores. *Nicotine & Tobacco Research* 7 (3): 413–19.
91. Hopfer, C. J., T. J. Crowley, and J. K. Hewitt. 2003. Review of twin and adoption studies of adolescent substance use. *Journal of the American Academy of Child & Adolescent Psychiatry* 42 (6): 710–19.
92. Jedidi, K., H. S. Jagpal, and W. S. DeSarbo. 1997. STEMM: A general finite mixture structural equation model. *Journal of Classification* 14 (1): 23–50.
93. Vink, J. M., G. Willemsen, R. C. Engels, and D. I. Boomsma. 2003. Smoking status of parents, siblings and friends: Predictors of regular smoking? Findings from a longitudinal twin-family study. *Twin Research* 6 (3): 209–17.

94. Vink, J. M., G. Willemsen, and D. I. Boomsma. 2003. The association of current smoking behavior with the smoking behavior of parents, siblings, friends and spouses. *Addiction* 98 (7): 923–31.
95. Maes, H. H., M. C. Neale, K. S. Kendler, N. G. Martin, A. C. Heath, and L. J. Eaves. 2006. Genetic and cultural transmission of smoking initiation: An extended twin kinship model. *Behavior Genetics* 36 (6): 795–808.
96. Maes, H. H., M. C. Neale, and K. S. Kendler. 2006. Testing for measurement invariance in genetic analyses of smoking and nicotine dependence. *American Journal of Medical Genetics Part B, Neuropsychiatric Genetics* 141B (7): 700.
97. Pergadia, M. L., A. C. Heath, N. G. Martin, and P. A. Madden. 2006. Genetic analyses of DSM-IV nicotine withdrawal in adult twins. *Psychological Medicine* 36 (7): 963–72.
98. Morley, K. I., M. T. Lynskey, P. A. Madden, S. A. Treloar, A. C. Heath, and N. G. Martin. 2007. Exploring the inter-relationship of smoking age-at-onset, cigarette consumption and smoking persistence: Genes or environment? *Psychological Medicine* 37 (9): 1357–67.
99. Heath, A. C., N. G. Martin, M. T. Lynskey, A. A. Todorov, and P. A. Madden. 2002. Estimating two-stage models for genetic influences on alcohol, tobacco or drug use initiation and dependence vulnerability in twin and family data. *Twin Research* 5 (2): 113–24.
100. Broms, U., K. Silventoinen, P. A. Madden, A. C. Heath, and J. Kaprio. 2006. Genetic architecture of smoking behavior: A study of Finnish adult twins. *Twin Research and Human Genetics* 9 (1): 64–72.
101. Heath, A. C., P. A. Madden, and N. G. Martin. 1998. Statistical methods in genetic research on smoking. *Statistical Methods in Medical Research* 7 (2): 165–86.
102. Koopmans, J. R., W. S. Slutske, A. C. Heath, M. C. Neale, and D. I. Boomsma. 1999. The genetics of smoking initiation and quantity smoked in Dutch adolescent and young adult twins. *Behavior Genetics* 29 (6): 383–93.
103. True, W. R., A. C. Heath, J. F. Scherrer, B. Waterman, J. Goldberg, N. Lin, S. A. Eisen, M. J. Lyons, and M. T. Tsuang. 1997. Genetic and environmental contributions to smoking. *Addiction* 92 (10): 1277–87.
104. True, W. R., H. Xian, J. F. Scherrer, P. A. Madden, K. K. Bucholz, A. C. Heath, S. A. Eisen, M. J. Lyons, J. Goldberg, and M. Tsuang. 1999. Common genetic vulnerability for nicotine and alcohol dependence in men. *Archives of General Psychiatry* 56 (7): 655–61.
105. Heath, A. C., K. M. Kirk, J. M. Meyer, and N. G. Martin. 1999. Genetic and social determinants of initiation and age at onset of smoking in Australian twins. *Behavior Genetics* 29 (6): 395–407.
106. Madden, P. A., A. C. Heath, N. L. Pedersen, J. Kaprio, M. J. Koskenvuo, and N. G. Martin. 1999. The genetics of smoking persistence in men and women: A multicultural study. *Behavior Genetics* 29 (6): 423–31.
107. Vink, J. M., G. Willemsen, and D. I. Boomsma. 2005. Heritability of smoking initiation and nicotine dependence. *Behavior Genetics* 35 (4): 397–406.
108. American Psychiatric Association. 2000. *Diagnostic and Statistical Manual of Mental Disorders*, 4th ed., text rev. (DSM-IV-TR). Arlington, VA: American Psychiatric Publishing.
109. Aggen, S. H., M. C. Neale, and K. S. Kendler. 2005. DSM criteria for major depression: Evaluating symptom patterns using latent-trait item response models. *Psychological Medicine* 35 (4): 475–87.
110. Heatherton, T. F., L. T. Kozlowski, R. C. Frecker, and K. O. Fagerström. 1991. The Fagerström Test for Nicotine Dependence: A revision of the Fagerström Tolerance Questionnaire. *British Journal of Addiction* 86 (9): 1119–27.
111. Pomerleau, C. S., S. M. Carton, M. L. Lutzke, K. A. Flessland, and O. F. Pomerleau. 1994. Reliability of the Fagerström Tolerance Questionnaire and the Fagerström Test for Nicotine Dependence. *Addictive Behaviors* 19 (1): 33–39.
112. Hudmon, K. S., C. S. Pomerleau, J. Brigham, H. Javitz, and G. E. Swan. 2005. Validity of retrospective assessments of nicotine dependence: A preliminary report. *Addictive Behaviors* 30 (3): 613–37.
113. Prokhorov, A. V., C. De Moor, U. E. Pallonen, K. S. Hudmon, L. Koehly, and S. Hu. 2000. Validation of the modified Fagerström Tolerance Questionnaire with salivary cotinine among adolescents. *Addictive Behaviors* 25 (3): 429–33.
114. Haddock, C. K., H. Lando, R. C. Klesges, G. W. Talcott, and E. A. Renaud. 1999. A study of the psychometric and predictive properties of the Fagerström Test for

- Nicotine Dependence in a population of young smokers. *Nicotine & Tobacco Research* 1 (1): 59–66.
115. Radzius, A., E. T. Moolchan, J. E. Henningfield, S. J. Heishman, and J. J. Gallo. 2001. A factor analysis of the Fagerström Tolerance Questionnaire. *Addictive Behaviors* 26 (2): 303–10.
 116. Radzius, A., J. J. Gallo, D. H. Epstein, D. A. Gorelick, J. L. Cadet, G. E. Uhl, and E. T. Moolchan. 2003. A factor analysis of the Fagerström Test for Nicotine Dependence (FTND). *Nicotine & Tobacco Research* 5 (2): 255–40.
 117. Richardson, C. G., and P. A. Ratner. 2005. A confirmatory factor analysis of the Fagerström Test for Nicotine Dependence. *Addictive Behaviors* 30 (4): 697–709.
 118. de Leon, J., F. J. Diaz, E. Becona, M. Gurpegui, D. Jurado, and A. Gonzalez-Pinto. 2003. Exploring brief measures of nicotine dependence for epidemiological surveys. *Addictive Behaviors* 28 (8): 1481–6.
 119. John, U., C. Meyer, A. Schumann, U. Hapke, H. J. Rumpf, C. Adam, D. Alte, and J. Ludemann. 2004. A short form of the Fagerström Test for Nicotine Dependence and the Heaviness of Smoking Index in two adult population samples. *Addictive Behaviors* 29 (6): 1207–12.
 120. Kandel, D., C. Schaffran, P. Griesler, J. Samuolis, M. Davies, and R. Galanti. 2005. On the measurement of nicotine dependence in adolescence: Comparisons of the mFTQ and a DSM-IV-based scale. *Journal of Pediatric Psychology* 30 (4): 319–32.
 121. Hughes, J. R., A. H. Oliveto, R. Riggs, M. Kenny, A. Liguori, J. L. Pillitteri, and M. A. MacLaughlin. 2004. Concordance of different measures of nicotine dependence: Two pilot studies. *Addictive Behaviors* 29 (8): 1527–39.
 122. Lessov, C. N., N. G. Martin, D. J. Statham, A. A. Todorov, W. S. Slutske, K. K. Bucholz, A. C. Heath, and P. A. Madden. 2004. Defining nicotine dependence for genetic research: Evidence from Australian twins. *Psychological Medicine* 34 (5): 865–79.
 123. Straub, R. E., P. F. Sullivan, Y. Ma, M. V. Myakishev, C. Harris-Kerr, B. Wormley, B. Kadambi, et al. 1999. Susceptibility genes for nicotine dependence: A genome scan and followup in an independent sample suggest that regions on chromosomes 2, 4, 10, 16, 17 and 18 merit further study. *Molecular Psychiatry* 4 (2): 129–44.
 124. Bierut, L. J., J. P. Rice, A. Goate, A. L. Hinrichs, N. L. Saccone, T. Foroud, H. J. Edenberg, et al. 2004. A genomic scan for habitual smoking in families of alcoholics: Common and specific genetic factors in substance dependence. *American Journal of Medical Genetics A* 124 (1): 19–27.
 125. Saccone, N. L., E. L. Goode, and A. W. Bergen. 2003. Genetic analysis workshop 13: Summary of analyses of alcohol and cigarette use phenotypes in the Framingham Heart Study. *Genetic Epidemiology* 25 Suppl. 1: S90–S97.
 126. Vink, J. M., A. L. Beem, D. Posthuma, M. C. Neale, G. Willemsen, K. S. Kendler, P. E. Slagboom, and D. I. Boomsma. 2004. Linkage analysis of smoking initiation and quantity in Dutch sibling pairs. *Pharmacogenomics Journal* 4 (4): 274–82.
 127. Ehlers, C. L., and K. C. Wilhelmsen. 2006. Genomic screen for loci associated with tobacco usage in Mission Indians. *BMC Medical Genetics* 7:9.
 128. Gelernter, J., X. Liu, V. Hesselbrock, G. P. Page, A. Goddard, and H. Zhang. 2004. Results of a genomewide linkage scan: Support for chromosomes 9 and 11 loci increasing risk for cigarette smoking. *American Journal of Medical Genetics Part B, Neuropsychiatric Genetics* 128 (1): 94–101.
 129. Gelernter, J., C. Panhuysen, R. Weiss, K. Brady, J. Poling, M. Krauthammer, L. Farrer, and H. R. Kranzler. 2007. Genomewide linkage scan for nicotine dependence: Identification of a chromosome 5 risk locus. *Biological Psychiatry* 61 (1): 119–26.
 130. Li, M. D., T. J. Payne, J. Z. Ma, X. Y. Lou, D. Zhang, R. T. Dupont, K. M. Crews, G. Somes, N. J. Williams, and R. C. Elston. 2006. A genomewide search finds major susceptibility loci for nicotine dependence on chromosome 10 in African Americans. *American Journal of Human Genetics* 79 (4): 745–51.
 131. Swan, G. E., H. Hops, K. C. Wilhelmsen, C. N. Lessov-Schlaggar, L. S. Cheng, K. S. Hudmon, C. I. Amos, et al. 2006. A genome-wide screen for nicotine dependence susceptibility loci. *American Journal of Medical Genetics Part B, Neuropsychiatric Genetics* 141 (4): 354–60.
 132. Saccone, S. F., M. L. Pergadia, A. Loukola, U. Broms, G. W. Montgomery, J. C. Wang, A. Agrawal, et al. 2007. Genetic linkage to

- chromosome 22q12 for a heavy-smoking quantitative trait in two independent samples. *American Journal of Human Genetics* 80 (5): 856–66.
133. Morley, K. I., S. E. Medland, M. A. Ferreira, M. T. Lynskey, G. W. Montgomery, A. C. Heath, P. A. Madden, and N. G. Martin. 2006. A possible smoking susceptibility locus on chromosome 11p12: Evidence from sex-limitation linkage analyses in a sample of Australian twin families. *Behavior Genetics* 36 (1): 87–99.
 134. Sham, P. 1997. *Statistics in human genetics*. London: Hodder Arnold.
 135. Li, M. D., J. Z. Ma, R. Cheng, R. T. Dupont, N. J. Williams, K. M. Crews, T. J. Payne, R. C. Elston, and Framingham Heart Study. 2003. A genome-wide scan to identify loci for smoking rate in the Framingham Heart Study population. *BMC Genetics* 4 Suppl. 1: S103.
 136. Goode, E. L., M. D. Badzioch, H. Kim, F. Gagnon, L. S. Rozek, K. L. Edwards, and G. P. Jarvik. 2003. Multiple genome-wide analyses of smoking behavior in the Framingham Heart Study. *BMC Genetics* 4 Suppl. 1: S102.
 137. Vink, J. M., D. Posthuma, M. C. Neale, S. P. Eline, and D. I. Boomsma. 2005. Genome-wide linkage scan to identify loci for age at first cigarette in Dutch sibling pairs. *Behavior Genetics* 36 (1): 100–111.
 138. Duggirala, R., L. Almasy, and J. Blangero. 1999. Smoking behavior is under the influence of a major quantitative trait locus on human chromosome 5q. *Genetic Epidemiology* 17 Suppl. 1: S139–S144.
 139. Lewis, S. J., S. Zammit, D. Gunnell, and G. D. Smith. 2005. A meta-analysis of the MTHFR C677T polymorphism and schizophrenia risk. *American Journal of Medical Genetics Part B, Neuropsychiatric Genetics* 135 (1): 2–4.
 140. Lerman, C., and W. Berrettini. 2003. Elucidating the role of genetic factors in smoking behavior and nicotine dependence. *American Journal of Medical Genetics Part B, Neuropsychiatric Genetics* 118 (1): 48–54.
 141. Li, M. D. 2006. The genetics of nicotine dependence. *Current Psychiatry Reports* 8 (2): 158–64.
 142. Batra, V., A. A. Patkar, W. H. Berrettini, S. P. Weinstein, and F. T. Leone. 2003. The genetic determinants of smoking. *Chest* 123 (5): 1730–9.
 143. Li, M. D., J. Z. Ma, and J. Beuten. 2004. Progress in searching for susceptibility loci and genes for smoking-related behaviour. *Clinical Genetics* 66 (5): 382–92.
 144. Munafó, M. R., T. G. Clark, E. C. Johnstone, M. F. G. Murphy, and R. T. Walton. 2004. The genetic basis for smoking behavior: A systematic review and meta-analysis. *Nicotine & Tobacco Research* 6 (4): 583–98.
 145. Tyndale, R. F. 2003. Genetics of alcohol and tobacco use in humans. *Annals of Medicine* 35 (2): 94–121.
 146. Al Koudsi, N., and R. F. Tyndale. 2005. Genetic influences on smoking: A brief review. *Therapeutic Drug Monitoring* 27 (6): 704–9.
 147. Greenbaum, L., K. Kanyas, O. Karni, Y. Merbl, T. Olender, A. Horowitz, A. Yakir, D. Lancet, E. Ben-Asher, and B. Lerer. 2006. Why do young women smoke? I: Direct and interactive effects of environment, psychological characteristics and nicotinic cholinergic receptor genes. *Molecular Psychiatry* 11 (3): 312–22, 223.
 148. Bierut, L. J., P. A. Madden, N. Breslau, E. O. Johnson, D. Hatsukami, O. F. Pomerleau, G. E. Swan, et al. 2007. Novel genes identified in a high-density genome wide association study for nicotine dependence. *Human Molecular Genetics* 16 (1): 24–35.
 149. Uhl, G. R., Q. R. Liu, T. Drgon, C. Johnson, D. Walther, and J. E. Rose. 2007. Molecular genetics of nicotine dependence and abstinence: Whole genome association using 520,000 SNPs. *BMC Genetics* 8:10.
 150. Spence, J. E., L. A. Corey, W. E. Nance, M. L. Marazita, K. S. Kendler, and R. M. Schieken. 1988. Molecular analysis of twin zygosity using VNTR DNA probes. Abstract. *American Journal of Human Genetics* 43 (3): A159.
 151. Eaves, L. 1976. A model for sibling effects in man. *Heredity* 36 (2): 205–14.
 152. Neale, M. About Mx. <http://www.vcu.edu/mx/about-mx.html> (accessed December 24, 2008).
 153. Kendler, K. S., M. C. Neale, C. J. MacLean, A. C. Heath, L. J. Eaves, and R. C. Kessler. 1993. Smoking and major depression. A causal analysis. *Archives of General Psychiatry* 50 (1): 36–43.

7

Trajectories of Tobacco Use from Adolescence to Adulthood: Are the Most Informative Phenotypes Tobacco Specific?

Kristina M. Jackson, Kenneth J. Sher, Richard J. Rose, and Jaakko Kaprio

The relationship between developmental trajectories of smoking and other substance use may provide clues for a genetic vulnerability to nicotine dependence, which, in turn, may inform smoking phenotypes for genetic analysis. This chapter examines the evidence base for linkages between substance-use trajectories as well as the results of an original empirical study examining smoking and alcohol use over time across a cohort group of male twins from Finland. Areas discussed include

- *Common versus specific liability to substance-use disorders*
- *Covariate relationships between smoking and other substance-abuse trajectories*
- *Conjoint trajectories of smoking and other substances, including alcohol, marijuana, and polysubstance use*

Available evidence points to the possible existence of general underlying factors for substance-use and tobacco-specific pathways, both of which may link to genetic phenotypes. Moreover, the cohort study examined in this chapter supports the existence of heritable genetic traits for general substance-abuse trajectories on the basis of comparisons between monozygotic and dizygotic twins. The link between such trajectories and a genetic basis for nicotine dependence remains an area for further study.

The analyses described herein were supported by National Institute of Health grants AA017242, AA11998, AA13938, and AA13987. The data collection from *Finn Twin16-25* was supported by National Institute of Health grants AA00145, AA08315, AA12502, and by the Academy of Finland Centre of Excellence on Complex Disease Genetics.

Introduction

As described in chapter 5 of this volume, an unresolved question is whether phenotypic information is best conceptualized as tobacco specific or as describing a broader spectrum of substance use or disinhibition. Accordingly, the goal of this chapter is to examine the utility of considering joint trajectories of tobacco and other substance use, drawing on trajectories of tobacco and alcohol use as an empirical example. Moreover, as discussed in chapters 5 and 6, almost no empirical work exists on the heritability of these trajectories. After a review of the literature, joint trajectories of alcohol and tobacco use with a genetically informative (twin) sample are characterized, and the extent to which these trajectories overlap across substance is described. Findings from the empirical example will have implications regarding the extent to which trajectories are unique to tobacco or whether they can be conceptualized as general pathways of substance use.

Resolving the question of tobacco-specific phenotypes versus general substance use is critical for identifying key etiological and maintaining processes, developing theory-based prevention programs, and allocating resources for prevention activities. Broad, substance-general phenotypes could reflect underlying shared individual vulnerability factors (e.g., affective dysregulation, impaired self-control, reward seeking, conventionality) or common environmental influences (peer affiliation, substance availability) on use. Individual and environmental factors might act alone or may operate in combination for promoting or inhibiting multiple forms of substance use. In contrast, tobacco-specific phenotypes could reflect individual differences in sensitivity to the rewarding and punishing effects of nicotine (and associated variables inherent in smoking) alone and in interaction with cultural variables and tobacco control and prevention policies.

Importance of Studying Substance-Use Comorbidity

A wealth of literature supports the high concurrent use of nicotine with other substances. This is particularly true for cigarette smoking and alcohol use,¹⁻⁴ but also for use of tobacco with marijuana and other drugs.⁵⁻⁷ During adolescence, smoking is highly associated with use of other substances such as alcohol, marijuana, and other drugs,⁸⁻¹⁷ and tobacco use often precedes both alcohol-use¹⁸ and substance-use disorders, including alcohol dependence.¹⁹

By using a nationally representative sample, onset and persistence of drinking and smoking in adolescence were each predicted by prior use of the other substance.²⁰ This smoking-drinking association persists into emerging adulthood.²¹⁻²³ One nationally representative college student sample revealed that over 98% of smokers reported prior-year drinking, and those who initiated regular smoking at an early age were at greatest risk for drinking. Likewise, current smoking and regular smoking were overrepresented among those who drank, particularly at high or risky levels.²⁴ Compared with nonsmokers, young adults with tobacco dependence and nondependent smokers had increased odds of being diagnosed with an alcohol or illicit drug disorder.²⁵

The health consequences of tobacco use in conjunction with other substance use can be severe. Concurrent use of tobacco and alcohol acts synergistically to produce greater health risks than expected from the additive effects of each substance,² including elevated rates of esophageal,^{26,27} laryngeal,²⁸⁻³⁰ and oral cancers.^{29,31,32}

Although the case for considering tobacco use in conjunction with other substance use for estimating health risks

(i.e., consequences) is now well established, consideration of tobacco use in the context of other substance use may be just as important for understanding etiological processes. Extant research has suggested several possible mechanisms underlying substance-use comorbidity. Directional (perhaps causal) associations include cross-tolerance and cueing as well as reciprocal antagonism; for example, individuals may use nicotine to counteract alcohol's debilitating effects on cognitive skills.^{33,34}

Alternatively, a common-vulnerability model suggests that different substances share important third-variable precursors and hence are likely to co-occur. Using prospective data, Jackson and colleagues³⁵ demonstrated that the prospective association between tobacco- and alcohol-use disorders could be explained by a general traitlike tendency to use both substances as opposed to directional associations between the two. Such underlying tendencies to use both substances appear

Phenotypes Based on Comorbidity and Course

Comorbidity has traditionally been viewed as a cross-sectional phenomenon—that is, the existence of two or more conditions occurring at a single point in time (even when sequencing information is used to classify one condition as “primary” and the comorbid condition as “secondary.”^a Implicit in the traditional approach is that each comorbid condition is adequately characterized as a static entity. Subsequent data (described elsewhere in this chapter), however, emphasize the importance of the course of single disorders or conditions, suggesting that comorbidity should be viewed in the context of the longitudinal course of each co-occurring condition. Despite the surge of longitudinal research on comorbidity, however, “too little attention has been given to the implications of diagnostic course...both singly and across related disorders.”^{b(p.956)}

Although the explicit diagnostic criteria sets introduced in the third edition of the *Diagnostic and Statistical Manual of Mental Disorders* and subsequent revisions^{c,d,e} represent a major advance in psychiatric phenotype definition by rejuvenating the Kraepelinian approach to diagnosis, these criteria represent only a partial embrace of a Kraepelinian approach that equally emphasized syndrome description by using specific behavioral indicators and longitudinal course.^b To a large extent, formal diagnostic nosology has not kept up with either developmental theory or data that highlight the importance of considering both longitudinal course and co-occurring comorbidity as informative phenotypes. Corresponding (e.g., parallel) courses suggest similar developmental timing of use across substances. Developmental transitions such as change in living situation or attainment of traditional roles associated with career and family may exert common influence on use of different substances. Understanding the extent to which pattern of use of different substances overlap can provide the foundation for understanding factors contributing to substance use, abuse, and dependence and can suggest the existence of particular subtypes that may benefit from targeted prevention or treatment efforts.

^aSchuckit, M. A., R. M. Anthenelli, K. K. Bucholz, V. M. Hesselbrock, and J. Tipp. 1995. The time course of development of alcohol-related problems in men and women. *Journal of Studies on Alcohol* 56 (2): 218–25.

^bWidiger, T. A., and L. A. Clark. 2000. Toward DSM-V and the classification of psychopathology. *Psychological Bulletin* 126 (6): 946–63.

^cAmerican Psychiatric Association. 1980. *Diagnostic and Statistical Manual of Mental Disorders: DSM III*. 3rd ed. Washington, DC: American Psychiatric Association.

^dAmerican Psychiatric Association. 1987. *Diagnostic and Statistical Manual of Mental Disorders: DSM-III-R*. 3rd rev. ed. Washington, DC: American Psychiatric Association.

^eAmerican Psychiatric Association. 1994. *Diagnostic and Statistical Manual of Mental Disorders: DSM-IV*. 4th ed. Washington, DC: American Psychiatric Association.

to be, at least partially, genetic in origin. Given the high statistical association between tobacco and alcohol use and the finding that there appears to be a shared, genetically transmitted vulnerability to use both substances, it is possible and perhaps even likely that the most informative smoking phenotypes for genetic analysis will be those that simultaneously consider smoking and other substance use as associated features.

Common Versus Specific Liability to Substance-Use Disorders

Models Supporting a Common Underlying Substance-Use Factor

An influential model of substance use—the gateway theory—suggests that use of tobacco, alcohol, and drugs follows a progressive sequence of involvement from licit to illicit substances. In general, the sequence starts with use of alcohol and/or tobacco products, followed by marijuana use, proceeding to other illicit drug use (see Kandell³⁶ for a review). Thus, the idea that tobacco use is comorbid with use of other substances is refined whereby tobacco serves as a “gateway” to use of other drugs; that is, smoking is necessary but not sufficient for subsequent substance use. This sequencing is robust to gender, ethnicity/culture, and age of initiation, and has been demonstrated in numerous cross-sectional and prospective analytic approaches, including prevention trials.³⁶ Research demonstrating that early smoking^{18,37–39} leads to subsequent alcohol and drug use also supports the gateway theory. However, some research has led to conclusions that a common-factor model based on propensity and opportunity to use substances serves as a more parsimonious alternative.⁴⁰

In contrast to the gateway theory, a body of research suggests that the associations among smoking, drinking, and marijuana and other substance use are a function of a common factor of substance-use vulnerability. This idea has received attention from various camps, initially by Jessor and Jessor in their problem behavior theory (PBT).⁴¹ PBT conceptualizes substance use as one of a number of behaviors (also including delinquency and precocious sexual activity) associated with a deviant lifestyle in rejection of the conventional values of society. This theory stands up to replication using different samples^{42,43} and long-term follow-up.⁴⁴ Applications of this theory show robust support for PBT.^{45,46}

A number of researchers have added to the evidence that a common factor underlies substance use and other problem behaviors. A body of studies by Krueger and colleagues using both quantitative^{47,48} and behavior-genetic^{48,49} approaches support a common externalizing dimension underlying substance dependence, antisocial behaviors, and a disinhibited personality. This work, however, only considers alcohol, marijuana, and other drug dependence; information regarding the degree to which smoking loads on a common externalizing factor is lacking. Consistent with the work by these authors, McGue and colleagues suggest that a common trait of disinhibition underlies use of alcohol, tobacco, and illicit drugs as well as other problem behaviors.^{50,51} Supporting this idea, indices of behavioral undercontrol (e.g., constraint, novelty seeking, psychoticism,^{52,53} as well as conduct disorder and attention deficit hyperactivity disorder [ADHD]^{54,55} increase the risk of alcohol, tobacco, and marijuana use in adolescents. King and colleagues⁵⁶ demonstrated prospective relationships between childhood externalizing disorders (conduct disorder, oppositional defiant disorder, ADHD), internalizing disorders (major depressive disorder, and for girls

only, overanxious disorder and separation anxiety disorder), and substance use in early adolescence. Externalizing psychopathology predicted having tried alcohol, nicotine, and marijuana by 14 years of age as well as regular and advanced experience with these substances. Internalizing disorders showed much weaker effects, with only major depression at 11 years of age showing a significant relationship with substance use at 14 years of age. Hence, a large and growing body of empirical literature implicates the existence of general mechanisms linking adolescent problem behavior and disinhibitory psychopathology in adulthood.

Further, Lynskey and colleagues⁵⁷ presented evidence that much of the association between smoking, drinking, and marijuana use in adolescence could be explained by a factor representing individual vulnerability to substance use. Newcomb and colleagues⁵⁸ demonstrated that alcohol, marijuana, and other drug use are indicators of a common substance-use factor, and the influence of risk factors on use of these substances is mediated through the common factor. This factor was also evident across different developmental stages.⁵⁹ In addition, Vanyukov and colleagues⁶⁰ showed that a substantial proportion of the variance in liability to use substances is shared between substances.

Finally, the idea of a common substance-use factor is supported by models of substance-use behavior that have been shown to generalize across different types of substances. These include Petraitis and colleagues'⁶¹ integrative theory of triadic influence (see also Flay and Petraitis⁶²) and the social development model of Catalano, Hawkins, and colleagues^{63,64} as well as West's⁶⁵ synthesis of different models of addiction.

However, some research has failed to identify a common factor that underlies substance use and other problem

behaviors.^{66,67} Willoughby and colleagues⁶⁸ identified a substance-use factor distinct from other problem behaviors such as delinquency and aggression. Likewise, White and Labouvie⁶⁹ showed in a community sample that substance use (including alcohol, tobacco, and illicit drug use) and delinquency represented two dimensions of problem behavior. In addition, in contrast to work suggesting a common underlying substance-use factor, several studies suggest that use of different types of substances may be better represented by separate (but correlated) factors. These studies demonstrate that use of alcohol loads on a factor separate from smoking⁷⁰ or drug use,^{71,72} although Zhang and colleagues⁷² demonstrated that drinking, drug use, and delinquency loaded strongly on a higher-order deviance factor. Likewise, Dembo and colleagues⁷³ noted some specificity of alcohol use beyond a general deviance factor that included marijuana use (as well as delinquency).

Osgood and colleagues⁷⁴ proposed that associations between various deviant behaviors can be attributed to general deviance during adolescence at a point at which behaviors such as substance use and sexual activity are much less normative; however, as youth age, behaviors become more acceptable and show greater specificity. The finding by Resnicow and colleagues⁷⁵ that substance use loaded on the same factor as carrying a weapon and stealing, but not more normative school problems and (low) positive behaviors, supports this notion. White⁷⁶ noted that certain problem behaviors cluster at different developmental periods. White suggested that youth experiment with different problem behaviors across adolescence but that many of these behaviors do not become established behavior patterns. In summary, there appears to be a strong general factor indicating susceptibility to varied forms of substance use, but there remains

considerable substance-specific residual vulnerability, and evidence for overlap with other problem behaviors is more limited.

Shared Genetic Risk

Consistent with the phenotypic work supporting a common general dimension of substance use and evidence for common correlates across substances, a good portion of genetic risk for substance-use disorders is carried through one major common factor.⁷⁷ Twin data provide ample evidence for a general underlying genetic risk factor that increases liability to use tobacco and alcohol, including measures of alcohol volume,^{78–81} intoxication,⁸² and alcohol dependence.⁸³ Comparable findings have been shown for tobacco dependence and alcohol dependence^{84,85} (also see Volk and colleagues⁸⁶ for evidence of specificity of genetic effects). Extending this work further, there is evidence for a common genetic influence mediating concurrent tobacco, alcohol, and marijuana use⁸⁷ and problem use,⁸⁸ with tobacco and marijuana showing the strongest genetic overlap. In a study by Yoon and colleagues,⁸⁹ P3 amplitude, shown to be highly heritable in adolescent boys, is associated with various indices of use of different substances (e.g., early use, frequency of use, maximum use across cigarettes, alcohol, and illicit drugs). This finding extends the work demonstrating that a common genetic vulnerability underlies substance use in general.

Also consistent with the problem behavior theory, although not directly relevant to understanding smoking phenotypes, some studies have documented common genetic factors underlying alcohol and drug dependence.^{49,90–92} In general, Hottelma and colleagues⁷⁹ noted that common genetic liability may be attributable to variation in genetically influenced personality traits (e.g., sensation seeking) or variation in biological substrates, which may include genetic influences on variation in the reward

system.⁹³ Consistent with evidence for a common genetic influence, genetically informed family studies also show familial transmission of smoking, alcohol use, marijuana use, and illicit drug use.^{94–96}

Approaches to Research on Substance-Use Prevention

Evidence of a common externalizing factor suggests the design of relatively generic prevention strategies that target multiple problem behaviors.⁵¹ Numerous studies that have adopted a general approach in prevention of adolescent substance use show evidence of reduced use of alcohol, tobacco, and marijuana across multiple community, school-based, and high-risk populations^{97–103} and reduced use of illicit drugs;¹⁰⁴ however, see Brown and colleagues¹⁰⁵ for failure to detect program effects specifically for smoking.

However, it is important to note that several macro-level environmental factors can influence the availability and social acceptability of specific substances. Local and cultural social norms can differ across substances. For example, for the last several decades in the United States, the college environment has promoted heavy episodic drinking but not regular smoking as a normative behavior.¹⁰⁶ Moreover, formal alcohol and tobacco prevention and control policies (e.g., taxation, minimum age laws, advertising bans) can be applied to both substances in a roughly equal manner or differentially, and the nature of this balance presumably has implications for overall comorbidity and the relative degree of common versus unique environmental influence across substances. Other substance-control policies for tobacco use (e.g., smoking bans; see Hopkins and colleagues¹⁰⁷) and alcohol use (e.g., social host and dram shop liability laws, zoning of outlets; see Wagenaar and colleagues¹⁰⁸) are substance specific and presumably unique. This larger environmental context

highlights the importance of considering a range of environmental variables that might condition both manifest comorbidity and the relative contribution of genes, environments, and their interaction within a given population.

Review of Trajectory Literature

Chapter 5 of this volume reviews the literature on smoking trajectories; consequently, this literature is summarized here only to the extent that it is relevant to this discussion. First, the large and growing literature on trajectories of alcohol and marijuana/drug use is described in greater detail. Then, literature characterizing the associations between trajectories of one substance and use of other substances is reviewed, considering associations with time-invariant substance use as well as course of co-occurring substance use.

Trajectories of Alcohol Involvement

Consistent with theoretical work on course of alcohol involvement^{109–111} and complementing a wide body of subtyping literature in the alcohol field,¹¹² a large number of studies have characterized the developmental course of drinking over adolescence and young adulthood. Although results with respect to the specific characterization of course and associated prevalences vary somewhat from study to study, investigations are consistent in identifying four broad classes that vary in age of onset, magnitude and direction of slope, and severity of use: a nonuser/stable low-user course, a chronic high-use course, a decreasing course, and an escalating course. Not unexpectedly, trajectories derived from adolescent samples tend to detect courses typified by escalation, whereas samples that include young adults

reveal decreasing courses. For example, studies that follow adolescent drinking often show two groups of escalators that differ in age of onset and slope.^{113–116} In contrast, studies examining drinking in young adult samples are more likely to detect a decreasing or “developmentally limited” course.^{117–119} Some studies assessing a sample across the developmental transition from adolescence to young adulthood also identify a “fling” or “time-limited” trajectory,^{118,120,121} which, in studies using a younger or older sample, may manifest itself as an increasing or a developmentally limited course.

Although most of these studies have focused on a broad developmental span covering a number of years, a few studies have explored alcohol involvement over the course of a single year^{122–124} to resolve more-fine-grained changes in drinking behavior over shorter intervals. These fine-grained studies identify patterns of use primarily characterized by slope (e.g., stable behavior versus behavior that escalates or declines over time).

Drinking course has been defined along indices of alcohol involvement such as heavy/binge drinking,^{113,115,116,118–121,125} quantity/frequency,^{114,126,127} problem drinking,^{128,129} alcohol dependence,¹³⁰ or a composite of drinking items.¹³¹ Subsequent work examined congruence of trajectories across different indices of alcohol involvement (alcohol-use disorder, alcohol dependence, alcohol consequences, heavy drinking, and alcohol quantity/frequency¹¹⁷). Consistent with the existing body of literature, there was similarity in trajectory shapes (i.e., courses) across diverse indices, although predicted prevalences varied across measure.

Trajectories of Marijuana Involvement

Far fewer studies have characterized developmental course for frequency of

marijuana use,^{132–136} but findings have generally been consistent with regard to course shape and prevalence, with the majority of individuals being classified as abstainers/nonusers (ranging from 41% to 82%, with higher rates among adolescent samples). All studies identified a chronic high group marked by early onset and heavy use. A later-onset, escalating course was observed in three of the five studies. Not surprisingly, this group was the largest in the study with the longest time frame (covering ages 13–23 years). Additional groups were marked either by moderate occasional use or by reduced use.

Trajectories of Polysubstance Use

Some researchers assume but do not explicitly test comparability of substance-use course by using indices based on a composite of multiple substances at the point of trajectory identification. Using a large adolescent sample, Wills and colleagues¹³⁷ classified substance-use trajectories by using a composite of frequency of alcohol use, heavy alcohol use, tobacco use, and marijuana use. Although one-half of the sample consisted of nonusers, there were sizable subgroups characterized by experimentation and varying degrees of escalation. Clark and colleagues¹³⁸ identified course of substance-use-disorder symptoms based on retrospective report by using a sample of young adult males diagnosed with a substance-use disorder. Trajectories of substance-use problems varied across severity and onset age, with groups ranging from early-onset, severe, to improved (decrease), to mild or minimal problems. In addition, on the basis of indices of onset and intensity, Labouvie and White¹³⁹ detected three substance-specific trajectories (heavy smoking, heavy alcohol use, and heavy drug use) as well as a common-substance, adolescent-limited course, suggesting both specificity and commonality across courses of different types of substance use.

Associations between Substance-Use Trajectories and Other Substance Involvement

A number of studies indicate that smoking courses can be differentiated as a function of involvement with other substances (alcohol, marijuana, and other drug use) as measured at a single time point (e.g., as a baseline correlate or as an outcome), and smoking behavior (measured at a single time point) can differentiate alcohol and marijuana courses. These studies advance comorbidity research by considering the dynamic nature of at least one of the substances, but the arbitrary nature of which variable to consider as primary, and which as covariate, highlights the need for a true multivariate (i.e., multisubstance) approach to deriving trajectories.

Smoking Trajectories with Alcohol and Marijuana Use

Smoking behavior that is characterized by early onset and heavy use is robustly associated with marijuana use and, to a less consistent degree, with alcohol involvement. This is true when looking at substance-use correlates at baseline, as outcomes, or as time-varying covariates that track the smoking courses. White and colleagues¹⁴⁰ demonstrated that smokers endorsed more frequent alcohol, marijuana, and other drug use at baseline than did nonsmokers, although substance use did not differentiate between heavy/regular smoking and occasional smoking. Wills and colleagues¹⁴¹ showed that both (heavy) drinking and marijuana use tracked smoking frequency during early- to mid-adolescence. That is, those smokers characterized by early onset showed greatest use, and nonsmokers the lowest use, with experimenters showing

low but still elevated rates compared with nonsmokers. In addition, Brook and colleagues¹⁴² found that early-onset smokers with continuous use over adolescence and emerging adulthood were more likely to be diagnosed with alcohol dependence and illicit drug dependence than nonsmokers and smokers who had later onset of smoking or who showed reduced use over time. Moreover, late-starting smokers were more likely to be diagnosed with drug dependence than were nonsmokers. Finally, Juon and colleagues¹⁴³ showed that drug abuse/dependence during adulthood was highest for those assigned to a smoking class on the basis of reported use and age of onset and was lowest for those classified as nonsmokers.

After identifying four courses of smoking in adolescence (early adopters, late adopters, experimenters, and never smokers), Audrain-McGovern and colleagues¹⁴⁴ examined lifetime alcohol and marijuana use both as baseline predictors and as time-varying covariates. All smoking courses differed from never smokers on alcohol and marijuana use, and both early and late adopters showed greater use of marijuana (and alcohol for late adopters only) than did experimenters. For the most part, early and late adopters did not differ from one another as a function of other substance use.

Orlando and colleagues¹⁴⁵ characterized courses defined by smoking frequency over adolescence and emerging adulthood. They also tracked heavy drinking and marijuana over the study interval. No differences were observed in heavy drinking at 13 or 18 years of age, but at 15 years of age both the stable high and early, increasing courses showed greater drinking than did all other groups. Drinking rates were lowest for nonsmokers, with rates for late increasers and experimenters (“triers”) falling between nonsmokers and those with declining smoking rates. A similar pattern

was observed for marijuana use, but it was more consistently associated with smoking across time (at 13, 15, and 18 years of age). Early adulthood alcohol and drug problems showed similar patterns, with those characterized by a stable high smoking course and by an early-onset, increasing course most likely to report substance-use problems (by 23 years of age) and nonsmokers or triers least likely to report problems. Using the same data, but limiting the sample to women and extending outcomes to 29 years of age, revealed the same patterns.¹⁴⁶

Soldz and Cui¹⁴⁷ identified the extent to which substance use tracked courses of adolescent past-month smoking quantity. They portrayed a pattern of marijuana use that very closely paralleled smoking, with similar findings for alcohol use. Continuous smokers had the highest rates of marijuana and alcohol use, and early-smoking escalators also started at low or moderate levels but escalated rapidly to high rates of drinking and marijuana use. Experimenters and late escalators were also similar, both showing escalating use of marijuana and alcohol toward the end of high school. In addition, smoking quitters showed more substance use than did nonsmokers but only minimally so (indicating a pattern of experimentation).

Finally, using data from the prospective Dunedin sample, Stanton and colleagues¹⁴⁸ showed that alcohol and marijuana use tracked smoking patterns over preadolescence and adolescence, with highest rates of substance use among rapid escalators. Again, indicators of alcohol use (past-month drinking, intention to get drunk) were less associated with smoking than was marijuana use. In sum, those with smoking trajectories characterized by early initiation or elevated use tend to report greater baseline substance use and subsequent problems or abuse/dependence.

Drinking Trajectories with Smoking and Marijuana/ Drug Use

Few of the many studies characterizing course of alcohol involvement examine smoking or marijuana-use correlates. Windle and colleagues¹²¹ showed an association with heavy drinking course for men only; moderate or high heavy drinking (but not very high heavy drinking) was associated with heavier baseline smoking. Men with high or very high drinking also were more likely to report marijuana use at baseline. In contrast, women were more likely to report baseline marijuana use if they belonged to an infrequent or time-limited drinking course. D'Amico and colleagues¹²³ showed that adolescents who were consistently heavy drinkers over the course of a year reported higher rates of smoking and marijuana use and initiated smoking, regular smoking, and marijuana use at a younger age than did nonheavy drinkers or individuals whose drinking increased over the course of the year.

Hill and colleagues¹¹⁵ demonstrated that those whose heavy drinking began early and was persistently high were more likely to use drugs in early adolescence; likewise, reported lifetime history of drug use obtained during adolescence was higher for those with courses marked by early drinking experience.¹¹³ In addition, those with increasing rates of heavy drinking were most likely to be diagnosed subsequently with drug-use disorder,¹¹⁵ whereas non-heavy-drinking individuals were less likely than any heavy drinking group to develop subsequent drug abuse.¹¹³ Finally, Schulenberg and colleagues¹¹⁹ showed that time-varying measures of illicit drug use very closely paralleled heavy drinking trajectories, and Wiesner and colleagues¹⁴⁹ found that regular drinkers (those with chronic high alcohol use) were overrepresented with regard to marijuana and other drug use.

Marijuana Trajectories with Smoking and Alcohol Use

Studies characterizing marijuana trajectories suggest that those with an early onset show increased likelihood of being diagnosed with a lifetime alcohol-use disorder,¹³⁶ as well as increased alcohol use at study outset^{134,136} or study end¹³² and hard drug use at study end.^{132,133} These studies also were more likely to report early onset for drinking and smoking.¹³⁴ Correspondingly, the low- or nonusing marijuana groups showed the lowest rates of smoking and drinking. Alcohol involvement was also high among those whose marijuana use declined over time. Occasional users tended to fall in the middle for drug use,¹³³ and those whose marijuana use increased to a high rate reported heavy drinking at study end.¹³² Although not formally testing concordance between the two courses, Schulenberg and colleagues¹³⁵ demonstrated that both frequency of smoking and binge drinking closely tracked courses of marijuana during the developmental period (ages 18–24 years) under consideration.

Modeling Conjoint Trajectories of Substance Use

Researchers have begun exploring the extent to which various risk behaviors or disorders “travel together” over time, with an emerging literature that uses a developmental framework to examine co-occurrence of use of different substances. The available body of work is described, with acknowledgment that this is a rapidly evolving field. Table 7.1 presents characteristics of this literature, describing for each study the nature of the sample, the developmental period under investigation, the number of waves, the measures from which trajectories were

derived, the trajectory group structure and prevalence, and the type of analytic model.

Tobacco and Alcohol

Four studies were found that have modeled trajectories of both smoking and drinking. Orlando and colleagues¹⁵⁵ extracted five classes (and an a priori nonusing class) from indicators of drinking and smoking frequency when the two substances were modeled together in a single model. They demonstrated that, for the most part, smoking and drinking during adolescence and emerging adulthood tracked one another. A large group of normative users was observed (consisting of experimental smokers and moderate drinkers). Additional groups included those who exhibited chronic high use of both tobacco and alcohol, two groups whose substance use increased over time, and those who maintained their alcohol use but quit smoking. There was no evidence for a group of smokers whose drinking remitted, suggesting that smoking may be an indicator of a more severe form of drinking. Belonging to an early substance-use class was predicted by factors such as disrupted nuclear family, lower parental education, poor grades, and being white. In addition, nonusers and normative users revealed better overall health and life satisfaction, higher college graduation rates, fewer delinquent and violent behaviors, and fewer alcohol and drug problems.

A similar study was conducted using panel data from the Monitoring the Future project.¹⁵⁴ Group membership was identified on the basis of both smoking and (heavy) drinking. Perhaps because the large sample size ($N > 32,000$) permitted identification of classes with relatively low prevalence, seven groups were identified, including nonusers, chronic high users, those who smoked but did not drink, those who consumed alcohol but did not smoke, and three classes whose drinking was moderate but whose

pattern of smoking differed (moderate, late onset, or decreasing). Hence, unlike the Orlando and colleagues study,¹⁵⁵ a group of individuals who smoked but did not drink was observed. This may be due to the age under investigation, with the Orlando study targeting individuals earlier in adolescence (13 years of age versus 18 years) and tracking behavior until 23 years of age (versus 26 years); drinking rates tend to drop off in mid-adolescence but smoking tends to be more stable. Jackson and colleagues¹⁵⁴ demonstrated that some risk factors were relatively unique to the substance being predicted (e.g., parent education, gender, and race) and may exhibit additive effects in predicting smoking and drinking. In contrast, religiosity was a risk factor common to both smoking and drinking. Perhaps of greatest interest, alcohol expectancies and delinquency showed a “masked” effect whereby their association with smoking could be attributed to smoking’s association with drinking.

Using a high-risk college sample, Jackson and colleagues³⁵ identified five classes derived on the basis of both tobacco and alcohol involvement (specifically, tobacco dependence and alcohol-use disorders). Consistent with the Orlando study¹⁵⁵ and Jackson and colleagues,¹⁵⁴ an earlier study by Jackson and colleagues³⁵ observed a chronic high class for both substances, a class characterized by alcohol involvement but not tobacco involvement, and a nondiagnosing class. In addition, as in their later study,¹⁵⁴ Jackson and colleagues³⁵ observed a group diagnosed with tobacco dependence but not with alcohol-use disorder. Of note, a second class of individuals who were alcohol involved but not diagnosed with tobacco dependence was identified; however, diagnoses with alcohol-use disorders declined over time, consistent with a “maturing out” effect that has been observed in young adulthood. Predictors that were common to both substances included a family history of

Table 7.1 Overview of the Literature on Conjoint Trajectories of Substance Use

Study	Sample	Developmental period	Number of waves	Measures	Number and characteristics of class	How is conjoint substance use characterized?
Jackson et al. 2000 ³⁵	N = 449 college student sample	Young adult (ages 18–24 years)	5	Tobacco dependence (TD) Alcohol-use disorder (AUD)	Nondiagnosers (60%) Chronic AUD (6%) Developmentally limited AUD (16%) Chronic TD (11%) Comorbid AUD and TD (7%)	Dual-trajectory model
White et al. 2000 ²⁷	N = 1,380 community sample	Adolescence/early adulthood (ages 15–28 years)	4	Smoking volume Alcohol volume (volume = frequency × quantity)	Smoking: Low (52% female/56% male) Moderate (36%/37%) Heavy (12%/7%) Alcohol: Low (18% female/17% male) Late/increase (27%/25%) Moderate (38%/35%) Heavy (17%/23%)	No explicit comparison but evidence for common predictors
Guo et al. 2002 ¹⁵⁰	N = 786 children in Seattle Social Development Project	Adolescence/early adulthood (ages 10–21 years)	5	Frequency of smoking Frequency of binge drinking Frequency of marijuana use Frequency of illicit drug use	Tobacco: Chronic smokers 1% Escalators 8% Late onsetters 11% Experimenters 7% Nonsmokers 73% Alcohol: Chronic bingers 3% Escalators 4% Late onsetters 23% Nonbingers 70% Marijuana: Early high 3% Escalators 4% Late onsetters 4% Nonusers 89% Illicit drug: Early onsetters 7% Late onsetters 4% Nonusers 89%	No explicit comparison but evidence for common outcomes

Study	Sample	Developmental period	Number of waves	Measures	Number and characteristics of class	How is conjoint substance use characterized?
Chassin et al. 2004 ¹⁵¹	N = 586 community sample	Adolescence/early adulthood (ages 13–23 years)	6	Alcohol volume (volume = frequency × quantity) Frequency of smoking Frequency of drinking	Growth mixture model: 3 classes (plus a priori abstainers, 11%); low (light drinking/rare drug use; 24%); moderate (moderate drinking/experimental drug use; 45%); heavy (heavy drinking/heavy drug use; 20%)	Dual-trajectory model
Chung et al. 2004 ¹⁵²	N = 110 outpatient treatment sample (aged 16–25 years)	Course over a single year posttreatment Compute monthly abstinence rates based on timeline follow-back technique	12	Number of consecutive abstinent days per month for drinking and other drug use	Alcohol: High abstinence (53%) Decreasing abstinence (10%) Increasing abstinence (16%) Low abstinence (21%) Other drug: High abstinence (59%) Decreasing abstinence (12%) Increasing abstinence (14%) Low abstinence (15%)	Cross-classification: $\chi^2(9, N = 110) = 80.74$, $p < .001$ ($\kappa = .49$)
Flory et al. 2004 ¹⁵³	N = 481 Project DARE	Adolescence/early adulthood (age 12 through age 19–21 years)	6	Frequency of drinking Frequency of marijuana use	Alcohol: Early onset (17% men/25% women) Late onset (64%/57%) Nonusers (19%/18%) Marijuana: Early onset (6% men/12% women) Late onset (56%/42%) Nonusers (39%/46%)	Cross-classification: $\chi^2(4, N = 236) = 78.82$, $p < .001$ (men; 61% on diagonal) $\chi^2(4, N = 234) = 69.37$, $p < .001$ (women; 50% on diagonal)
Jackson et al. 2005 ¹⁵⁴	N = 32,087 Monitoring the Future panel data	Late adolescence/early adulthood (ages 20–26 years)	4	Smoking quantity Frequency of binge drinking	Nondrinker/nonsmoker (56%) Chronic (6%) Chronic drinker (14%) Chronic smoker (8%) Moderate drinker/developmentally limited smoker (5%) Moderate drinker/late onset-smoker (5%) Moderate drinker/smoker (6%)	Dual-trajectory model

Table 7.1 Overview of the Literature on Conjoint Trajectories of Substance Use (continued)

Study	Sample	Developmental period	Number of waves	Measures	Number and characteristics of class	How is conjoint substance use characterized?
Orlando et al. 2005 ¹⁵⁵	N = 5,608 school-based substance program for substance abuse prevention	Adolescence/early adulthood (ages 13–23 years)	6	Frequency of smoking Frequency of drinking	A prior nonusing class (4%) Normative users (55%) Smoking quitters/drinking maintainers (6%) Steady increasers (13%) Early increasers (12%) Early, high (9%)	Dual-trajectory model
Tucker et al. 2005 ¹⁵⁶	N = 4,245 (smoking) N = 3,889 (drinking) N = 3,185 (marijuana) school-based program for substance abuse prevention	Adolescence/early adulthood (ages 13–23 years)	6	Frequency of smoking Frequency of binge drinking Frequency of marijuana use	Tobacco: Abstainers (28%) Persistent light use (55%) Stable high use (26%) Decreasers (9%) Steady increasers (14%) Early increasers (9%) Alcohol: Abstainers (32%) Persistent light use (54%) Early, high (22%) Steady increasers (23%) Increase/decrease (bingers/fling) (13%) Marijuana: Abstainers (45%) Persistent light use (53%) Stable occasional light users (17%) Early, high (5%) Steady increasers (25%)	Cross-classification: greatest overlap among abstainers

Study	Sample	Developmental period	Number of waves	Measures	Number and characteristics of class	How is conjoint substance use characterized?
Jackson et al. 2008 ¹⁵⁷	N = 32,087 Monitoring the Future panel data	Late adolescence/early adulthood (ages 20–26 years)	4	Smoking quantity Frequency of binge drinking Frequency of marijuana use	<p>Tobacco: Nonheavy smoker (69%) Chronic (12%) Developmentally limited (6%) Late onset (5%) Moderate (8%)</p> <p>Alcohol: Nonheavy drinker (64%) Chronic (12%) Developmentally limited (16%) Late onset (7%)</p> <p>Marijuana: Nonheavy user (81%) Chronic (7%) Developmentally limited (9%) Late onset (3%)</p>	<p>Cross-classification: Tobacco vs. alcohol: $\chi^2(12, N = 31,853) = 2,474.41, p < .001, \Phi = .28$, Cramer's $V = .16$</p> <p>Tobacco vs. marijuana: $\chi^2(6, N = 31,872) = 3,683.51, p < .001, \Phi = .34$, Cramer's $V = .20$</p> <p>Alcohol vs. marijuana: $\chi^2(9, N = 31,869) = 4,172.32, p < .001, \Phi = .36$, Cramer's $V = .21$</p>
Audrain-McGovern et al. Forthcoming	N = 998 high school students	Late adolescence (age 14–20 years)	6	Smoking categories (based on frequency and quantity) Frequency of marijuana use	<p>Regular users (11%) Late escalators (8%) Slow escalators (23%) Fast escalators (2%) Cigarettes only (21%) Abstainers (33%)</p>	Sequential process model

alcoholism and expectancies about the effects of alcohol (suggesting the possibility of common expectancies across substance). However, being male and exhibiting behavioral undercontrol was a predictor that was specific to alcohol-use disorders, and childhood stressors only predicted comorbid tobacco dependence and alcohol-use disorder.

Muthén¹⁵⁹ reanalyzed the same data by using a different analytic technique (general growth mixture modeling versus the use of latent class analysis). Muthén identified three classes of alcohol-use disorders and three classes of tobacco dependence and estimated joint probabilities between the classes. The results of these analyses corresponded to the findings in Jackson and colleagues³⁵: the five trajectory groups in Jackson and colleagues³⁵ were represented by the five most prevalent joint probabilities in Muthén.¹⁵⁹

Although White and colleagues¹²⁷ modeled the developmental course of both smoking and drinking over adolescence and young adulthood, they did not explicitly compare concordance across the two substances. Both smoking and drinking showed low, moderate, and heavy courses; in addition, for drinking, a later-onset course made up one-quarter of the sample. The authors found evidence for both common (parental warmth) and specific (parental smoking, for tobacco use; parental drinking, for alcohol use) predictors of smoking and drinking. In conclusion, these four studies show that tracking trajectories of multiple substances not only illustrates the pattern of concurrent substance use over adolescence and young adulthood but also can permit better understanding of mechanisms that are common versus unique to use of a given substance.

Tobacco and Marijuana Use

Using a sequential process model, Audrain-McGovern and colleagues¹⁵⁸ characterized conjoint trajectories of smoking and

marijuana use over adolescence and emerging adulthood. With the exception of a class characterized by smoking only, courses of cigarette and marijuana use tracked one another; these were marked by abstinence, regular use, or slow, fast, or late escalation. Of interest to this chapter, the regular smokers and the fast escalators tended to have greater marijuana use than did the other groups.

Tobacco, Alcohol, and Marijuana/Other Drugs

Several studies have extended the analysis of conjoint substance-use course by also considering marijuana or other drug use. Unlike the work focusing on only tobacco and alcohol use, these studies have each modeled course of each substance separately and then examined concordance between substances to ascertain the extent to which patterns of substance use change together.

Again using the Monitoring the Future panel data, Jackson and colleagues¹⁵⁷ examined smoking, (heavy) drinking, and marijuana use and identified similar classes across substance that included nonusers, chronic high users, later-onset users, and decreasing users; for smoking only, there was also a class of moderate users. Smoking, drinking, and marijuana use tracked each other over time, with concordance between trajectories of marijuana and tobacco use as high as the association between tobacco and alcohol use. Early users of alcohol and marijuana were most likely to smoke moderately or heavily, even for those whose drinking decreased over young adulthood, underscoring the highly addictive nature of smoking. Delinquency and alcohol expectancies were the strongest predictors of general comorbidity; gender, race, religiosity, and parent education emerged also as significant predictors. Delinquency and alcohol expectancies both accounted for configurations of comorbid chronic high use, although expectancies failed to explain

combinations of smoking and marijuana use, supporting some specificity of expectancies to alcohol use. That delinquent behavior accounts for combinations of comorbidity characterized by early onset and persistently high use corroborates research suggesting common vulnerability underlying substance use.

Building on their earlier work, Tucker and colleagues¹⁵⁶ compared trajectories of smoking, (heavy) drinking, and marijuana use over adolescence and emerging adulthood. The greatest overlap was among abstainers but also among those characterized by increasing or early high use. Adult psychosocial and behavioral functioning was associated with class membership similarly across substances. Nonusers were at lowest risk for adverse outcomes (e.g., stealing, violence), and those whose substance use increased steadily to very high use were at greatest risk. However, in contrast to smoking, those who began using marijuana early but declined over time were not distinguishable from those with steady increasing use.

Using indices of cigarette smoking, (heavy) drinking, marijuana use, and illicit drug use, Guo and colleagues¹⁵⁰ tracked each substance over early to late adolescence. Each substance showed a large nonusing class and groups with onset either early or at a later point. In addition, chronic users were observed for smoking, drinking, and marijuana use, and an additional class of experimenters was observed for smoking only. Although explicit comparisons between substances were not conducted, the extent to which associations between course and sexual risk-taking behaviors at 21 years of age were common versus unique to substance was examined. Chronic and later-onset alcohol and marijuana use, but not cigarette or hard drug use, were associated with risky sexual behavior, whereas early cigarette and alcohol use, but not early marijuana or hard drug use, increased risk,

suggesting greater specificity than might be expected from theories of general adolescent problem behavior.

Alcohol and Marijuana/Other Drugs

Although not directly relevant to this chapter, work examining trajectories of alcohol and marijuana/drug use provides additional evidence that longitudinal phenotypes of substance use are relatively common across substances. Chassin and colleagues¹⁵¹ demonstrated that trajectories of alcohol/drug use in adolescence and young adulthood tracked concurrent alcohol- and drug-use disorders such that those with heavy use were most likely to be diagnosed with a substance-use disorder. Likewise, Flory and colleagues¹⁵³ demonstrated substantial overlap among courses of alcohol and marijuana use, although a number of alcohol users were nonusers of marijuana. Etiological correlates and young adult outcomes were common to both substances, with little evidence of specificity. Finally, using retrospective reports of days abstinent in a clinical sample of adolescents and young adults, Chung and colleagues¹⁵² documented moderate concordance ($\kappa = .49$) between courses of alcohol and drug use in the year following treatment whereby change in alcohol use typically paralleled change in drug use, although there was evidence that some individuals abstained from one substance but not the other.

Review of Results

On the basis of findings from studies that jointly model course and comorbidity, several conclusions can be advanced. First, despite the diverse course shapes and different course prevalences that were identified by each study, it is reassuring that in each case, relatively high concordance was observed between corresponding

trajectories (e.g., chronic high smoking with chronic high drinking), as were common correlates of course across substance.

Second, both common and specific factors that underlie concurrent substance use were observed. As noted by Jackson and colleagues,¹⁵⁴ identifying risk factors that distinguish among courses of comorbidity can provide construct validity for the trajectories and can not only illuminate the nature of comorbidity but also can provide a better understanding of each substance. For example, one could compare

risk factors for courses characterized by heavy use of one substance and low use of the co-occurring substance. Jackson and colleagues¹⁵⁴ identified different patterns of association between risk factors and paths of co-occurring tobacco and alcohol use that suggested additive effects, synergistic effects, and masked (confounded) effects.

Third, it is apparent from this work that individuals who remit from alcohol and marijuana use frequently remain smokers. This may be, in part, because tobacco is so highly physically and psychologically

Why Might It Be Useful to Use Course as a Phenotype?

Developmental course might serve as a valuable phenotype for biometric models. Researchers have been using latent growth modeling^{a,b} to model developmental course by using genetically informative (twin) data. Although work conducted in 1986 by McArdle^c and Plomin^d introduced the idea of capturing the heritability of developmental change, 20 years passed before the heritability of latent variables reflecting level (intercept) and growth was demonstrated by applying latent growth models to the study of genetic influences.^{e,f} Carlson and Iacono^e suggested that intercept and slope factors may serve as developmental phenotypes that indicate the extent of genetic vulnerability for continuity or change in a given behavior. However, although this work is informative with regard to the heritability of initial level (at a given age) and change from that level over an extended observation period, these parameters do not capture individuals who are particularly “at risk” by virtue of membership in a developmental course that is marked by both high initial level and chronic continued use. A latent variable that characterizes membership in some developmental course could be a valuable phenotype in that it classifies individuals by their level of and change in substance use as well as the timing of onset or initiation. The integration of mixture models into genetic models is under way,^g although thus far this work considers only a single behavior (i.e., alcohol use). Determining the degree to which these phenotypes are substance specific represents a logical next step in the genetic study of addictive behavior.

^aCurran, P. J., and A. M. Hussong. 2003. The use of latent trajectory models in psychopathology research. *Journal of Abnormal Psychology* 112 (4): 526–44.

^bMuthén, B. 2001. Latent variable mixture modeling. In *New developments and techniques in structural equation modeling*, ed. G. A. Marcoulides and R. E. Schumacker, 1–33. Mahway, NJ: Lawrence Erlbaum.

^cMcArdle, J. J. 1986. Latent variable growth within behavior genetic models. *Behavior Genetics* 16 (1): 163–200.

^dPlomin, R. 1986. Multivariate analysis and development behavioral genetics: Developmental change as well as continuity. *Behavior Genetics* 16 (1): 25–43.

^eCarlson, S. R., and W. G. Iacono. 2006. Heritability of P300 amplitude development from adolescence to adulthood. *Psychophysiology* 43 (5): 470–80.

^fFinkel, D., C. A. Reynolds, J. J. McArdle, and N. L. Pedersen. 2005. The longitudinal relationship between processing speed and cognitive ability: Genetic and environmental influences. *Behavior Genetics* 35 (5): 535–49.

^gMuthén, B., T. Asparouhov, and I. Rebollo. 2006. Advances in behavioral genetics modeling using Mplus: Applications of factor mixture modeling to twin data. *Twin Research and Human Genetics* 9 (3): 313–24.

addictive; it also may be that once an individual has reached adulthood, alcohol and marijuana use are much less compatible with day-to-day adult responsibilities.

Finally, although several courses for tobacco and alcohol use were not associated with risk factors or adverse outcomes (e.g., escalating and decreasing courses), it appears that membership in any course indicating marijuana use increases risk of many negative correlates of substance-use behavior, suggesting some specificity to substances, at least with regard to those that are licit versus illicit.

Empirical Example of Modeling Co-Occurring Courses of Substance Use

In this section, an empirical example is presented of the modeling of conjoint use of multiple substances by using data from the Finn Twin16-25 study.¹⁶⁰ For simplification, only two substances are considered: cigarette smoking and alcohol consumption; models can be extended to consider more than two substances.^{150,156,157}

Because this is only an illustration of the methodological approach, some simplifying decisions and assumptions were made: (1) Analysis was limited to data from twin brothers so that gender moderation was not an issue. Finnish girls mature earlier and initiate drinking at earlier ages than do boys in matched birth cohorts,^{161,162} and environmental contributions to individual differences in pubertal development differ across genders.¹⁶³ Limiting the analysis to males attenuates the differential effects of pubertal maturation. (2) Trajectory analyses were conducted on the full sample of twins

as individuals without consideration of the twin design. As such, the standard errors of parameters are underestimated, and confidence intervals are narrower than if the sampling design were taken into account. However, the actual parameter estimates are not biased.* Furthermore, prior studies suggest that it is reasonable to generalize from twin to nontwin samples.^{164,165} (3) Finally, although analytic techniques permit missing data under the assumption that data are missing at random, missing data were not modeled to facilitate model convergence. Ascertainment of Finnish twins at the baseline of 16 years of age was essentially exhaustive and unbiased,¹⁶⁶ and individual response rates were $\geq 90\%$ through the third assessment at 18 years of age.¹⁶⁷ But compliance declined at the fourth wave of assessment and more so among adult male twins. Consequently, it is acknowledged that generalization to the general population is constrained in this regard.

Method

Participants and Procedure

Finn Twin16-25 is a population-based, longitudinal twin study that includes five twin birth cohorts obtained from the Finnish national population registry and consists of all twins born in Finland between the years 1975 and 1979,^{166,168} with both co-twins alive and resident in Finland at 16 years of age. Within 90 days of their 16th birthday, 3,065 twin pairs received mailed questionnaires. They were then followed up at the ages of 17 years, 18.5 years (age range 18–19 years), and 25 years (age range 23–27 years; response rate 83%); this final assessment generally corresponds to a period of maturing out/cessation of alcohol and tobacco use. Zygosity was

*Although it is possible to correct for dependence in Mplus by using the complex statement, the parameters do not change, and in fact, including this statement did not change the trajectory prevalence or structure.

determined from validated questionnaires completed by both co-twins and parents at baseline.¹⁶⁸ Data on smoking and drinking, across all four waves of assessment, were available for 1,132 male twins from brother-brother twin pairs of known zygosity; after deleting twins missing some data from their co-twins, 970 twins remained, forming 485 male twin pairs: 213 monozygotic and 272 dizygotic. This sample of twin brothers was used for all analyses.

Measures

Baseline questionnaires assessed frequency of alcohol use and frequency of smoking as well as other measures of substance use (including age at initiation, experimentation with cigarettes, and number of cigarettes smoked so far) and other health behaviors. The measures of drinking and smoking frequency were used in the analyses reported here.

Smoking

At 16 years of age, frequency of smoking was assessed with a single measure that asked, “Which of the following best describes your present smoking habits?” Response options included (1) I smoke once or more daily; (2) I smoke once or more a week, but not every day; (3) I smoke less often than once a week; (4) I am trying to or have quit smoking; and (5) I have never smoked. At the later ages, the set of five alternatives was expanded to six options (17 years of age) or seven options (ages 18 and 25 years) to better distinguish individual differences in density of smoking. To derive consistent measures over the four assessments, variables were recoded into the following four response options: (0) I have never smoked; (1) I smoke less than once a week or am trying to quit; (2) I smoke once or more a week but not daily; and (3) I smoke once or more daily. Items were rescored so that high scores indicate frequent smoking. Figure 7.1 (top) shows smoking prevalence over the four waves.

Alcohol Use

Frequency of drinking was assessed at all waves using a single measure asking how often the respondents use alcohol. Response options included (1) daily, (2) couple of times a week, (3) once a week, (4) a couple of times a month, (5) about once a month, (6) about once every two months, (7) 3–4 times a year, (8) once a year or less, and (9) I don’t drink any alcohol. For consistency with the smoking items, variables were recoded into four response options: (0) I do not use alcohol at all, (1) drink less than once a month, (2) drink at least once a month but less than weekly, and (3) drink at least once a week. Items were rescored so that high scores indicate frequent drinking. Figure 7.1 (bottom) shows the prevalence of drinking over the four waves.

Analytic Procedure

To identify trajectories, a mixture modeling procedure—general growth mixture modeling/models (GGMM)—was used.^{15,159,169,170} GGMM is a form of latent growth modeling, but it includes an unobserved categorical variable that models variability around the latent growth factors via discrete homogeneous classes of individuals (versus representing variability with a parameter, as in growth modeling). Basically, these models combine the continuous nature of a latent growth curve model with the categorical nature of group membership in a single estimation procedure. Rather than obtaining a trajectory of drinking for each individual in the study, as might be observed via latent growth modeling, multilevel modeling, or generalized estimating equations, GGMM groups individuals into meaningful “clusters” or “classes.”

Typical latent growth curve models assume that respondents come from the same population, with the same basic

Figure 7.1 Prevalence of Smoking (A) and Drinking (B) across the Four Study Waves

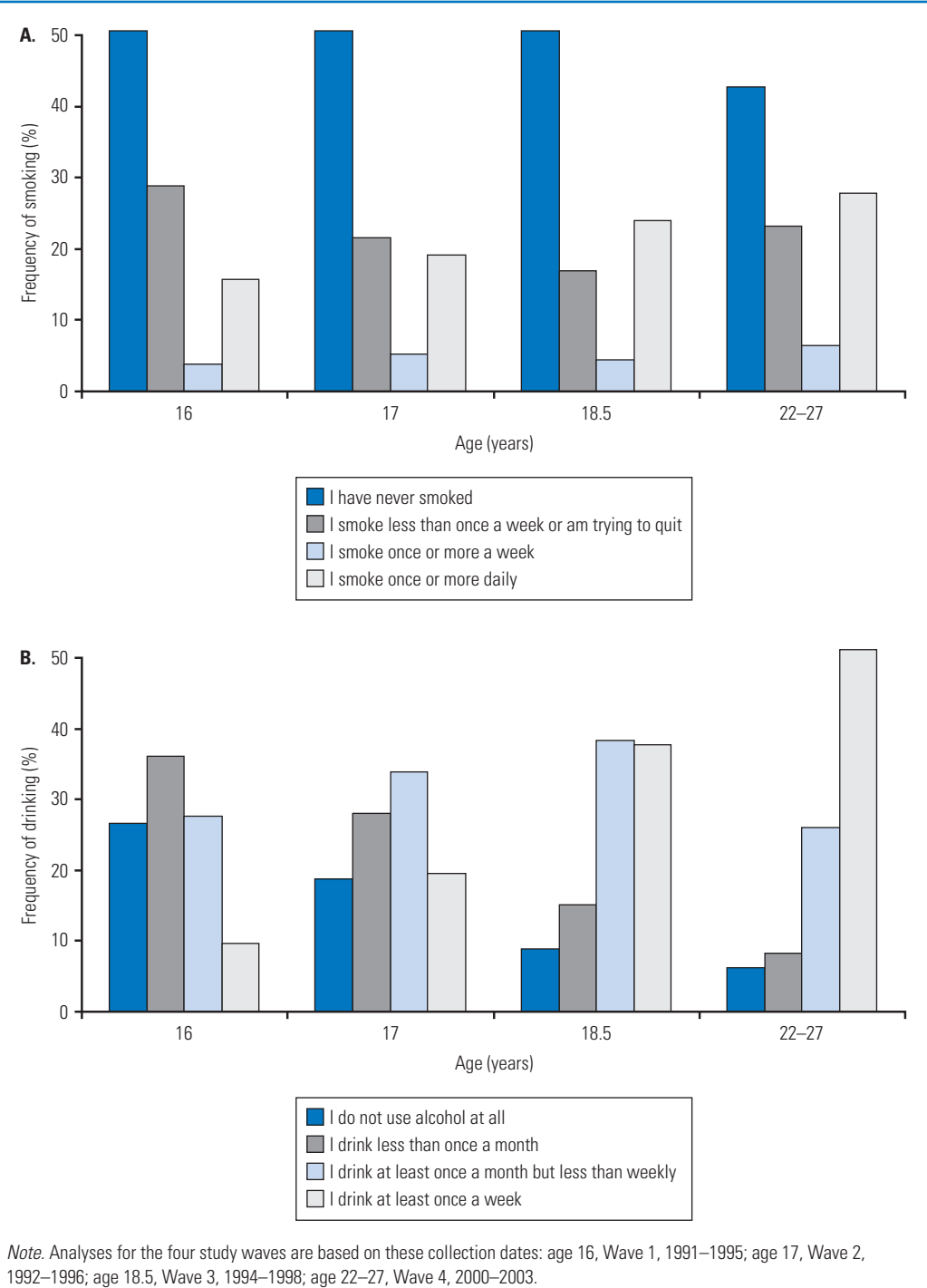

growth function with respect to starting point (intercept) and growth (slope; with individual variation represented by the intercept and slope factor variances). GGMMs, however, allow for different populations to have unique intercepts and slopes. In essence, GGMM estimates a unique latent growth curve (with individual variability) for each underlying population. This technique has some important advantages over other techniques used to derive developmental courses of substance use (e.g., cluster analysis, latent class analysis) in that it treats group membership as a latent (error free) variable (unlike cluster analysis) and accounts for the temporal ordering of prospective data (unlike traditional latent class analysis). Although GGMM is the model used here, other techniques can model change (e.g., regime switching¹⁷¹ and latent transition analysis).¹⁷² For example, in regime switching, individuals transition (or “switch”) among groups. For the purposes of this example, the more frequently applied trajectory-analysis technique of GGMM is used.

The GGMMs were based on a basic latent growth model. The base model included intercept and both linear and quadratic slopes. The intercept was centered at time 1 (by virtue of a zero loading on the slope factors at time 1). Linear and quadratic slope factor loadings were set according to the interval between assessments (roughly 0, 1, 2.5, and 8.8). For the sake of a simplified example, no within-class variability was permitted.* The smoking and drinking variables were treated as four-level ordinal variables. Models were estimated with automatically generated random start values with 100 initial-stage random sets of starting values and 10 final stage optimizations. All models were estimated using Mplus 4.10.¹⁷³

Two sets of analyses were conducted. The first was to model smoking and drinking independently. That is, a GGMM was estimated for smoking and, in a separate analysis, a GGMM was estimated for drinking. Then, the association between the trajectories of smoking and drinking was examined. In the second set of analyses, smoking and drinking were modeled simultaneously in a multivariate procedure. Figure 7.2 portrays the underlying GGMM for the two sets of analyses. The top panel shows two GGMMs for drinking and smoking; the bottom panel shows the multivariate procedure.

Results

First, associations between drinking and smoking at each of the assessments were examined. As table 7.2 indicates, smoking and drinking are highly intercorrelated, particularly during the adolescent years. In addition, smoking and drinking are highly associated across twins, with twin 1 smoking moderately associated with twin 2 drinking at the ages of 16, 17, and 18 years ($r = .37, .33, \text{ and } .27$, respectively) but less so at 25 years of age ($r = .06$; note that correlations for twin 1 drinking and twin 2 smoking were comparable). Not unexpectedly, the associations were stronger for monozygotic twins ($r = .42, .41, .36, \text{ and } .17$ at ages 16, 17, 18, and 25 years, respectively) than for dizygotic twins ($r = .34, .26, .20, \text{ and } -.04$, respectively).

Identification of Trajectories

As recommended by Muthén,¹⁷⁴ model fit was evaluated using a likelihood ratio test for relative improvement in fit—namely, the Vuong-Lo-Mendell-Rubin likelihood ratio (VLMR LR) test.^{175,176} An information criteria fit index was also considered (Bayesian

*Although it would have been preferable to estimate within-class variability, model convergence was greatly facilitated by constraining within-class variances to zero.

Figure 7.2 Underlying General Growth Mixture Model for Characterizing Trajectories of Smoking and Trajectories of Drinking (A) and for Characterizing Conjoint Trajectories of Smoking and Drinking (B)

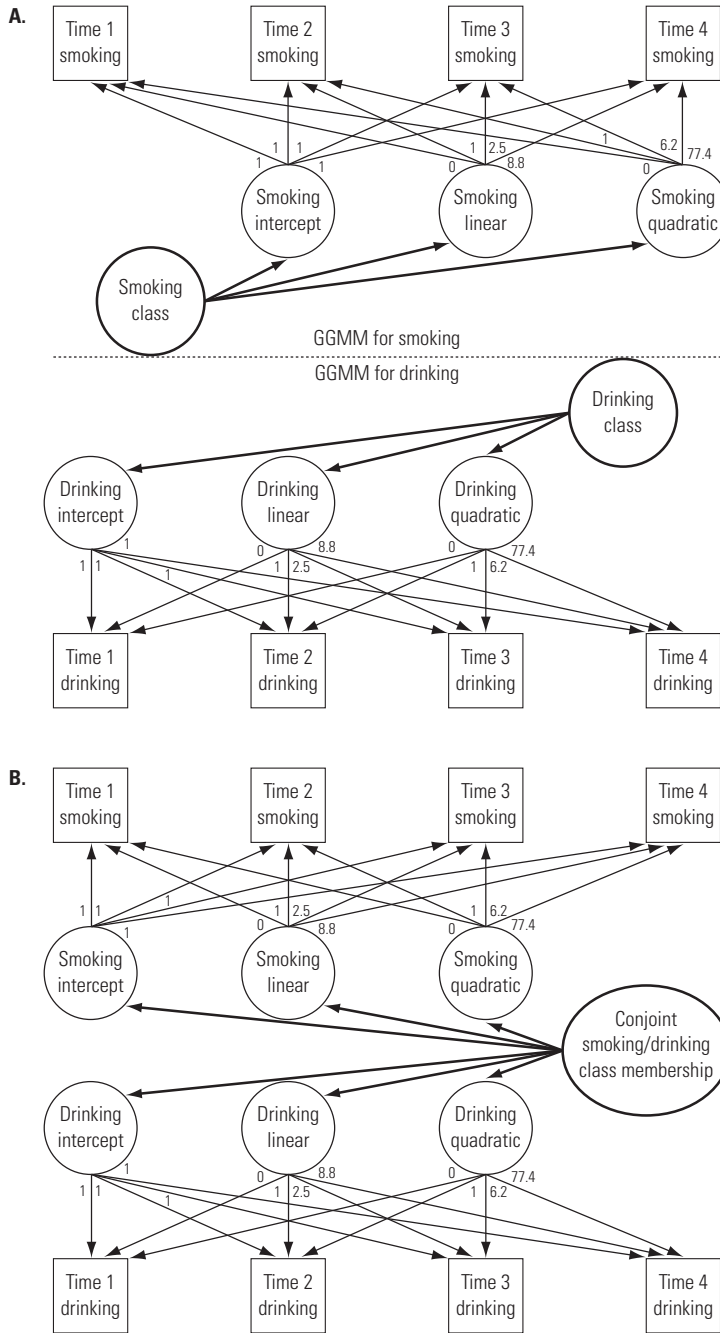

Note. GGMM = general growth mixture model/modeling. Factor loadings, set according to the interval between assessments, are shown for each growth factor. Correlations between intercept and slope factors were estimated but are not presented in the figure. For the dual-trajectory model, correlations were estimated between corresponding slope factors across substance.

Table 7.2 Correlations across Smoking and Drinking at Each of the Four Waves for the Full Sample

Behavior/age	Smoking				Drinking			
	Age 16	Age 17	Age 18	Age 25	Age 16	Age 17	Age 18	Age 25
Smoking–age 16	—							
Smoking–age 17	.80	—						
Smoking–age 18	.76	.82	—					
Smoking–age 25	.59	.64	.70	—				
Drinking–age 16	.46	.41	.38	.30	—			
Drinking–age 17	.39	.44	.39	.34	.69	—		
Drinking–age 18	.31	.34	.34	.32	.54	.66	—	
Drinking–age 25	.13	.15	.13	.20	.41	.46	.55	—

Information Criterion [BIC])¹⁷⁷ as well as class interpretability (the extent to which an additional class provided unique information) when determining number of classes.

Extracting Courses for Alcohol Use and for Tobacco Use

The first approach was to characterize course of smoking and course of drinking in two separate analyses. For each substance, one- through six-class models were tested (see table 7.3 for fit indices). For smoking, the VLMR LR test suggested that four classes were sufficient, although the Akaike Information Criterion (AIC) and the BIC supported a six-class model. The four-class solution was selected for its interpretability and parsimony; the fifth class divided the moderate class into two moderate classes that primarily differed on intercept; and the sixth class was characterized by a very sharp escalation, but only contained 1% of the sample. For drinking, the six-class model showed the best fit in terms of the AIC, BIC, and VLMR LR. However, the sixth class did not offer much additional information, essentially splitting the early-onset, chronic heavy-drinking group and the moderate adolescent/heavy adult group into three groups that primarily differed on intercept. As a result, the five-class model was selected.

For courses of smoking, group membership for each was characterized by the following trajectories: (1) nonsmokers and low-frequency smokers (50%); (2) stable moderate smokers (23%); (3) delayed-onset smokers (7%); and (4) early-onset, chronic heavy smokers (20%). Figure 7.3 (top) shows frequency of smoking as a function of class membership. For courses of drinking, group membership for each was characterized by the following trajectories: (1) nondrinkers and low-frequency drinkers (6%); (2) stable moderate drinkers (8%); (3) delayed-onset drinkers (10%); (4) moderate adolescent/heavy adult drinkers (47%), and (5) early-onset, chronic heavy drinkers (29%). Figure 7.3 (bottom) shows frequency of drinking as a function of class membership.

To evaluate concordance between courses of tobacco and alcohol use, a cross-tabulation of group membership for smoking and drinking was created (i.e., a 4 × 5 table) and measures of association were calculated. Given the lack of independence with twin pairs, the *p*-value is reported for the design-based χ^2 .¹⁷⁸ For this analysis, group membership was assigned using posterior probabilities—that is, assigning an individual to the class to which he or she was most likely to belong. As shown in table 7.4, smoking and drinking were associated: $\chi^2(12, N = 970) = 221.85$, $p < .001$; $\Phi = .48$; Cramer's $V = .28$.

Table 7.3 Fit Indices and Likelihood Ratio Tests for Relative Improvement in Fit for Smoking, Drinking, and Dual Smoking and Drinking

Number of classes	Test of model fit	Smoking	Drinking	Smoking and drinking
1	AIC	8973.74	9607.94	18581.69
	BIC	8998.13	9632.33	18630.46
	VLMR LR	N/A	N/A	N/A
	Entropy	N/A	N/A	N/A
2	AIC	7068.13	8661.23	16091.76
	BIC	7112.02	8705.13	16174.68
	VLMR LR	$p < .0001$	$p < .0001$	$p < .0001$
	Entropy	.92	.82	.91
3	AIC	6645.32	8251.50	15541.20
	BIC	6708.72	8314.91	15658.26
	VLMR LR	$p < .0001$	$p < .0001$	$p = .2986$
	Entropy	.88	.80	.90
4	AIC	6563.85	8141.28	15137.59
	BIC	6646.77	8224.19	15288.78
	VLMR LR	$p < .0001$	$p = .0062$	$p = .0008$
	Entropy	.87	.74	.88
5	AIC	6522.93	8095.42	14837.60
	BIC	6625.36	8197.84	15022.94
	VLMR LR	$p = .1355$	$p = .0089$	$p = .0003$
	Entropy	.82	.76	.88
6	AIC	6503.06	8054.69	14696.31
	BIC	6624.99	8176.62	14915.79
	VLMR LR	$p = .2774$	$p = .0011$	$p = .3274$
	Entropy	.84	.74	.85
7	AIC	—	—	14583.52
	BIC	—	—	14837.15
	VLMR LR	—	—	— ^a
	Entropy	—	—	.84
8	AIC	—	—	14505.21
	BIC	—	—	14792.97
	VLMR LR	—	—	— ^a
	Entropy	—	—	.83

Note. $N = 970$. AIC = Akaike Information Criterion; BIC = Bayesian Information Criterion; VLMR LR = Vuong-Lo-Mendell-Rubin likelihood ratio test for k versus $k+1$ classes; N/A = not applicable; — = model could not be estimated.

^aLikelihood ratio test would not converge properly.

To identify specific patterns of comorbidity that accounted for the concordance between courses of tobacco and alcohol use, a first-order configural frequency analysis technique was used.¹⁷⁹ Although there were 20 (4×5) different potential trajectories of smoking and drinking, some of these particular combinations of smoking and drinking were more likely to occur than chance (“types”) and some were less likely to occur than chance (“antitypes”). This was

done by testing observed versus expected cell frequencies in the smoking-drinking contingency table shown in table 7.4. Using Lehman’s approximation to the binomial probability (with Küchenhoff’s correction for continuity),¹⁷⁹ significant types and antitypes were identified on the basis of a cell χ^2 value 6.64, which indicates significance at $p < .01$ for a single degree of freedom. From these types and antitypes (denoted in table 7.4 by up and down arrows, respectively), several

7. Trajectories of Tobacco Use from Adolescence to Adulthood

Figure 7.3 Trajectories of Smoking (A) and Drinking (B)

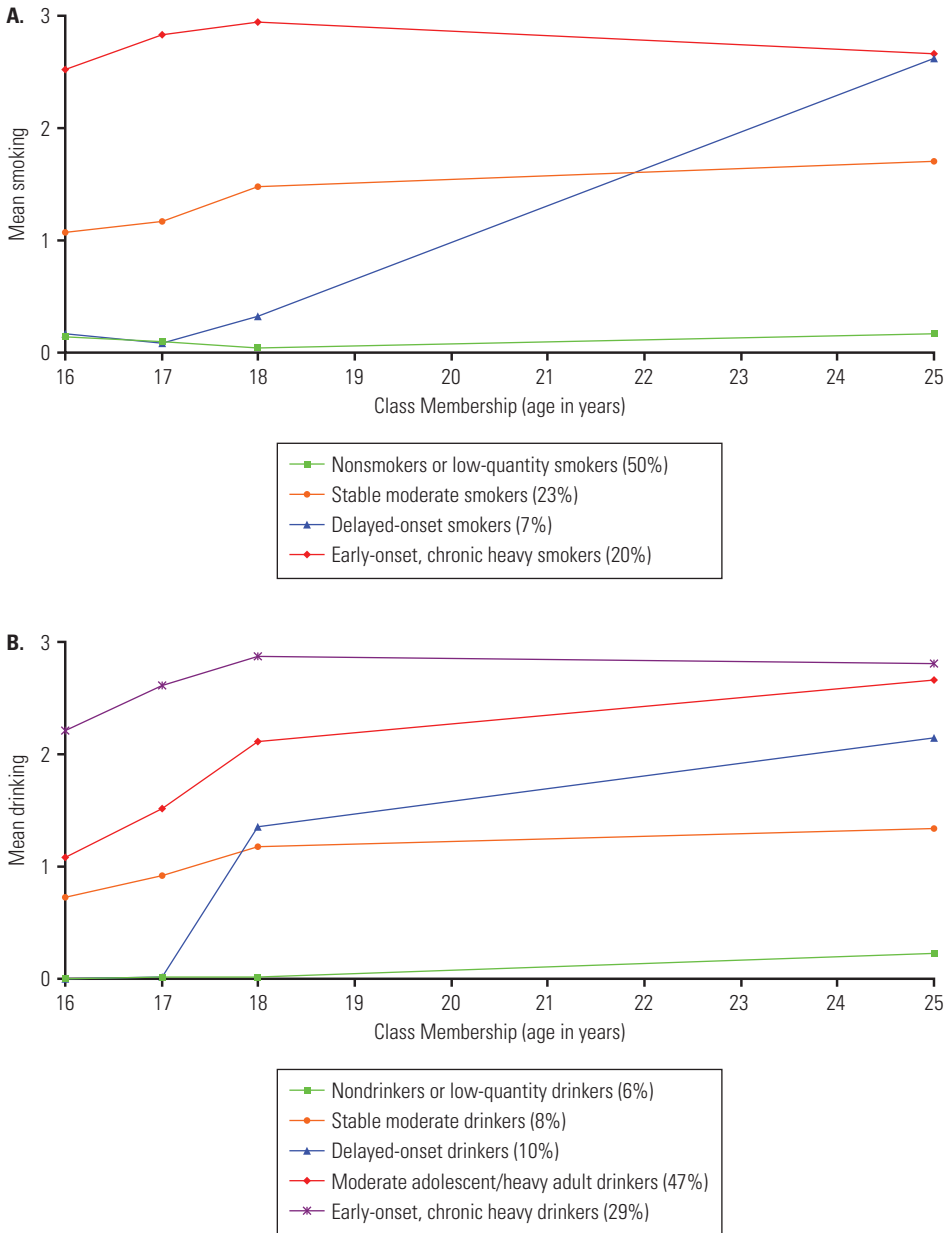

Note. In the top graph (A), the y-axis indicates (0) I have never smoked, (1) I smoke less than once a week or am trying to quit, (2) I smoke once or more a week but not daily, and (3) I smoke once or more daily. In the bottom graph (B), the y-axis indicates (0) I do not use alcohol at all, (1) I drink less than once a month, (2) I drink at least once a month but less than weekly, and (3) I drink at least once a week. Data for analyses were collected between 1991–2003.

Table 7.4 Cross-Tabulations of Frequency and Cell Proportions of Group Membership for Smoking and Drinking for the Full Sample

Drinking	Smoking								Marginals	
	Nonsmokers and low freq.		Stable moderate		Delayed onset		Early onset, chronic heavy			
	Freq.	%	Freq.	%	Freq.	%	Freq.	%	Freq.	%
Nondrinkers and low frequency	40	4.1	11	1.1	3	0.3	8	0.8	62	6.4
Stable moderate	64↑	6.6	8	0.8	3	0.3	5↓	0.5	80	8.2
Delayed onset	73↑	7.5	7↓	0.7	14↑	1.4	1↓	0.1	95	9.8
Moderate adolescent/heavy adult	248	25.6	105	10.8	34	3.5	65↓	6.7	452	46.6
Early onset, chronic high	58↓	6.0	95↑	9.8	12	1.2	116↑	12.0	281	29.0
Marginals	483	49.8	226	23.3	66	6.8	195	20.1	970	

Note. Freq. = frequency. $\chi^2(12, N = 970) = 221.85, p < .001; \Phi = .48$; Cramer's $V = .28$. Numbers with up arrows (↑) indicate values that are significantly greater ($p < .01$, based on a cell χ^2 value of 6.64 with 1 degree of freedom) than would be expected by chance ("types"). Numbers with down arrows (↓) indicate values that are significantly less ($p < .01$) than would be expected by chance ("antitypes").

conclusions can be drawn. Early-onset, chronic heavy smokers were most likely to be early-onset, chronic heavy drinkers and least likely to be moderate- or delayed-onset drinkers. Stable moderate smokers were also likely to be early-onset, chronic heavy drinkers. Those with a delayed onset in smoking also showed a delayed onset for drinking, suggesting that these patterns of use track one another. Finally, non/low smokers were most likely to be stable moderate drinkers or to show delayed onset of drinking.

Extracting Conjoint Courses of Tobacco and Alcohol Use

Next, courses of smoking and drinking were identified in a single multivariate analysis. One- through eight-class models were tested (see table 7.3 for fit indices). The eight-class model demonstrated the best fit on the basis of the AIC and BIC, but the eighth class was not substantively meaningful (partitioning a single group into two groups that differed only in level of frequency). As such, the seven-class model was selected; figure 7.4

presents the developmental courses for the conjoint trajectories of smoking and drinking. Group membership for each was characterized by the following trajectories: (1) non/low drinkers and smokers (5%); (2) non/low drinkers, stable moderate smokers (2%); (3) delayed-onset drinkers, non/low smokers (25%); (4) early, chronic high drinkers, non/low smokers (18%); (5) early, chronic high drinkers, stable moderate smokers (19%); (6) delayed-onset drinkers and smokers (11%); and (7) early, chronic high drinkers and smokers (19%).

Comparison of Approaches to Studying Conjoint Use

Two methods are presented to examine concurrent smoking and drinking: (1) modeling course of each substance separately and examining concordance between the substances, and (2) extracting a single factor of latent group membership from both smoking and drinking measurements. For the most part, similar conclusions could be reached from these two analyses. The three most prevalent

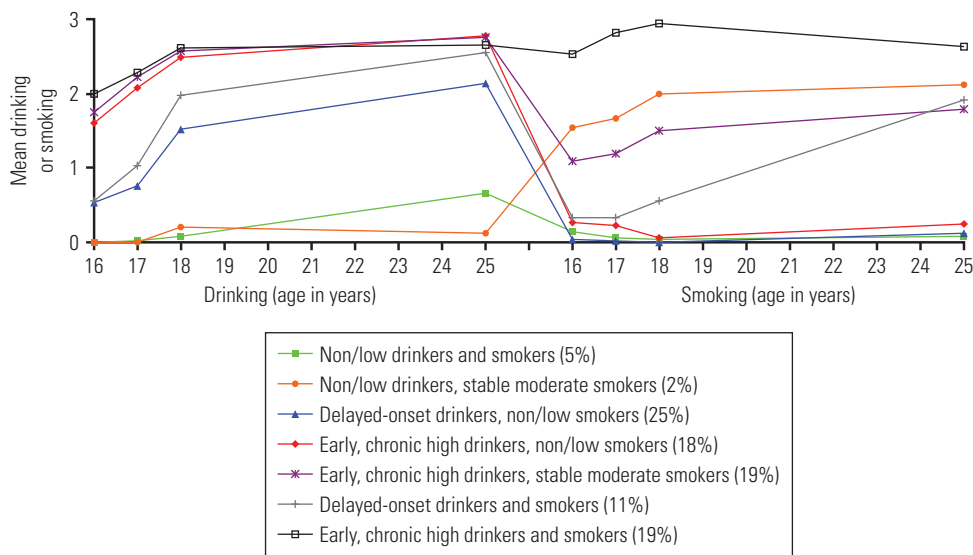
Figure 7.4 Trajectories of Conjoint Drinking (left side) and Smoking (right side)

Note. The y-axis for drinking indicates (0) I do not use alcohol at all, (1) I drink less than once a month, (2) I drink at least once a month but less than weekly, and (3) I drink at least once a week. The y-axis for smoking indicates (0) I have never smoked, (1) I smoke less than once a week or am trying to quit, (2) I smoke once or more a week but not daily, and (3) I smoke once or more daily. Data for analyses were collected between 1991–2003.

groups in the dual-trajectory model (delayed-onset drinkers, non/low smokers; early, chronic high drinkers, stable moderate smokers; and early, chronic high drinkers and smokers) were identified as types according to the contingency table (table 7.4). In addition, the delayed-onset drinker and smoker class, which was somewhat prevalent (11%), was identified as a type. The two smallest classes in the dual-trajectory model—the non/low drinkers and smokers and the non/low drinkers and stable moderate smokers—were not identified as types in the contingency table. The only discrepant finding was that of the early, chronic high drinker and non/low smoker group. Although this group was rather prevalent in the dual-trajectory model, it was actually an antitype in the contingency table. However, there was a significant type for the stable moderate drinking group and non/low smoking group. Given that the levels of drinking frequency of the early, chronic high drinkers and the stable moderate drinkers

had converged by 25 years of age, this finding is not so anomalous.

In sum, the two approaches showed consistency in identifying distinct phenotypes of smokers and drinkers that may be valuable for genetic study. However, clear differences exist in methodological approach, and it is faulty to assume that classes that “exist” in one approach will be mirrored in the other.

Trajectories as Informative Phenotypes

To establish the value of these trajectories as informative phenotypes for genetic study, the extent to which membership in the trajectories was concordant for twin 1 and twin 2 was considered, followed by an examination of agreement as a function of zygosity. Table 7.5 shows the concordance between twin 1 and twin 2 for the four smoking courses (top) and for

the five drinking courses (bottom) for the full sample (collapsed across zygosity). Concordance was high for smoking class membership: $\chi^2(9, N = 485) = 280.12$, $p < .001$; $\Phi = .76$; Cramer's $V = .44$; $\kappa = .45$ (95% confidence interval [CI], .39–.51). Concordance was equally high for drinking class membership: $\chi^2(16, N = 485) = 490.31$, $p < .001$; $\Phi = 1.01$; Cramer's $V = .50$; $\kappa = .46$ (95% CI, .40–.53). Not unexpectedly, twin pairs showed overlap for corresponding classes (i.e., significant types represented by the cells along the diagonal of table 7.5; several significant antitypes along the off-diagonal).

Next, cross-substance twin concordance was explored; that is, the associations between twin 1 smoking and twin 2 drinking and vice versa were examined (table 7.6). Developmental course of smoking in one twin and course of drinking in the other twin showed a moderate association: $\chi^2(12, N = 485) = 71.45$, $p < .001$; $\Phi = .38$; Cramer's $V = .22$ (for twin 1 smoking and twin 2 drinking; the converse association was nearly identical). Given the strength of the cross-twin agreement (table 7.5) for smoking ($\Phi = .76$; Cramer's $V = .44$) and for drinking ($\Phi = 1.01$; Cramer's $V = .50$), these cross-substance associations are notable.

Finally, the extent to which twin 1 membership in the conjoint smoking-drinking course was concordant with twin 2 membership was examined. Concordance for the dual trajectories was very good: $\chi^2(36, N = 485) = 719.81$, $p < .001$; $\Phi = 1.22$; Cramer's $V = .50$; $\kappa = .41$ (95% CI, .36–.47). Interestingly, when considering the likelihood-based parameters (Φ and Cramer's V), cross-twin agreement for the conjoint trajectories was higher than concordance for each substance modeled individually; the magnitude for the kappas was nearly identical.

Next, concordance within and between substances as a function of zygosity was

examined. For smoking, monozygotic twins showed stronger class membership agreement, $\chi^2(9, N = 213) = 190.36$, $p < .001$; $\Phi = .95$; Cramer's $V = .55$; $\kappa = .57$ (95% CI, .48–.66), than did dizygotic twins, $\chi^2(9, N = 272) = 109.49$, $p < .001$; $\Phi = .63$; Cramer's $V = .37$; $\kappa = .36$ (95% CI, .27–.44). The nonoverlapping confidence intervals on the kappa coefficients suggest that the stronger concordance for monozygotic twins was significant.

A similar pattern was observed for drinking: monozygotic twins showed higher concordance, $\chi^2(16, N = 213) = 341.81$, $p < .001$; $\Phi = 1.27$; Cramer's $V = .63$; $\kappa = .58$ (95% CI, .49–.67), than did dizygotic twins, $\chi^2(16, N = 272) = 185.83$, $p < .001$; $\Phi = 0.83$; Cramer's $V = .41$; $\kappa = .36$ (95% CI, .28–.45). Again, nonoverlapping confidence intervals on the kappa coefficients suggest significant differences in concordance for monozygotic versus dizygotic twins.

Finally, using the conjoint trajectories, cross-twin concordance was higher for monozygotic twins, $\chi^2(36, N = 213) = 463.73$, $p < .001$; $\Phi = 1.48$; Cramer's $V = .60$; $\kappa = .55$ (95% CI, .47–.63), than for dizygotic twins, $\chi^2(36, N = 272) = 298.29$, $p < .001$; $\Phi = 1.05$; Cramer's $V = .43$; $\kappa = .31$ (95% CI, .24–.38), again with evidence that the concordance was significantly higher among monozygotic twin pairs.

Summary of Empirical Example

In the example from Finn Twin16-25, the general techniques involved in characterizing developmental course of the use of two co-occurring substances is illustrated and preliminary evidence of genetic influences underlying conjoint substance use is presented. Four trajectories of smoking during adolescence and young adulthood are identified, including nonsmokers, stable moderate smokers (perhaps “chippers”),¹⁸⁰ and two groups that exhibited high smoking by 25 years of

Table 7.5 Cross-Tabulations of Frequency (Cell Proportion) of Group Membership for Twin 1 Versus Twin 2 (across Zygosity) for Smoking (top) and for Drinking (bottom)

	Twin 2 smoking													
	Nonsmokers and low frequency			Stable moderate			Delayed onset			Early onset, chronic heavy			Marginals	
	Frequency	%		Frequency	%		Frequency	%		Frequency	%		Frequency	%
Twin 1 smoking														
Nonsmokers or low frequency	181↑	37.3	32↓	6.6	11	2.3	10↑	2.1	234	48.2				
Stable moderate	32↓	6.6	57↑	11.8	4	0.8	20	4.1	113	23.3				
Delayed onset	21	4.3	3	0.6	11↑	2.3	4	0.8	39	8.0				
Early onset, chronic heavy	15↓	3.1	21	4.3	1	0.2	62↑	12.8	99	20.4				
Marginals	249	51.3	113	23.3	27	5.6	96	19.8	485					

	Twin 2 drinking											
	Nondrinkers and low frequency			Moderate adolescent/heavy adult			Early onset, chronic high			Marginals		
	Frequency	%		Frequency	%		Frequency	%		Frequency	%	
Twin 1 drinking												
Nondrinkers or low frequency	20↑	4.1	4	0.8	3	0.6	3↓	0.6	30	6.2		
Stable moderate	3	0.6	14↑	2.9	4	0.8	14	2.9	38	7.8		
Delayed onset	4	0.8	5	1.0	26↑	5.4	14	2.9	50	10.3		
Moderate adolescent, heavy adult	4↓	0.8	17	3.5	11	2.3	153↑	31.6	228	47.0		
Early onset, chronic high	1↓	0.2	2↓	0.4	1↓	0.2	40↓	8.2	139	28.7		
Marginals	32	6.6	42	8.7	45	9.3	224	46.2	485			

Note. For top: $\chi^2(9, N = 485) = 280.12, p < .001; \Phi = .76$; Cramer's $V = .44; \kappa = .45$ (95% confidence interval [CI], .39–.51) (across zygosity). For monozygotic twins (cross-tabulations not shown), $\chi^2(9, N = 213) = 190.36, p < .001; \Phi = .95$; Cramer's $V = .55; \kappa = .57$ (95% CI, .48–.66). For dizygotic twins (cross-tabulations not shown), $\chi^2(9, N = 272) = 109.49, p < .001; \Phi = .63$; Cramer's $V = .37; \kappa = .36$ (95% CI, .27–.44). For bottom: $\chi^2(16, N = 485) = 490.31, p < .001; \Phi = 1.01$; Cramer's $V = .50; \kappa = .46$ (95% CI, .40–.53) (across zygosity). For monozygotic twins (cross-tabulations not shown), $\chi^2(16, N = 213) = 341.81, p < .001; \Phi = 1.27$; Cramer's $V = .63; \kappa = .58$ (95% CI, .49–.67). For dizygotic twins (cross-tabulations not shown), $\chi^2(16, N = 272) = 185.83, p < .001; \Phi = 0.83$; Cramer's $V = .41; \kappa = .36$ (95% CI, .28–.45).

Numbers with up arrows (↑) indicate values that are significantly greater ($p < .01$, based on a cell χ^2 value of 6.64 with one degree of freedom) than would be expected by chance ("types"). Numbers with down arrows (↓) indicate values that are significantly less ($p < .01$) than would be expected by chance ("antitypes"). Not all numbers add to 100% because of rounding.

Table 7.6 Cross-Tabulations of Frequency (Cell Proportion) of Group Membership for Twin 1 Smoking by Twin 2 Drinking (top) and Twin 2 Smoking by Twin 1 Drinking (bottom)

	Twin 1 smoking										
	Nonsmokers and low frequency		Stable moderate		Delayed onset		Early onset, chronic heavy		Marginals		
	Frequency	%	Frequency	%	Frequency	%	Frequency	%	Frequency	%	
Twin 2 drinking											
Nondrinkers and low frequency	16	3.3	8	1.6	2	0.4	6	1.2	32	6.6	
Stable moderate	26	5.4	8	1.6	2	0.4	6	1.2	42	8.7	
Delayed onset	34†	7.0	5	1.0	6	1.2	0↓	0	45	9.3	
Moderate adolescent/heavy adult	118	24.3	56	11.6	21	4.3	29	6.0	224	46.2	
Early onset, chronic high	40↓	8.2	36	7.4	8	1.6	58†	12.0	142	29.3	
Marginals	234	48.2	113	23.3	39	8.0	99	20.4	485		

	Twin 2 smoking									
	Nonsmokers and low frequency		Stable moderate		Delayed onset		Early onset, chronic heavy		Marginals	
	Frequency	%	Frequency	%	Frequency	%	Frequency	%	Frequency	%
Twin 1 drinking										
Nondrinkers and low frequency	14	2.9	10	2.1	3	0.6	3	0.6	30	6.2
Stable moderate	27	5.6	5	1.0	2	0.4	4	0.8	38	7.8
Delayed onset	39†	8.0	4	0.8	3	0.6	4	0.8	50	10.3
Moderate adolescent/heavy adult	130	26.8	51	10.5	14	2.9	33	6.8	228	47.0
Early onset, chronic high	39↓	8.0	43	8.9	5	1.0	52†	10.7	139	28.7
Marginals	249	51.3	113	23.3	27	5.6	96	19.8	485	

Note. $\chi^2(12, N = 485) = 74.08, p < .001; \Phi = .39$; Cramer's $V = .23$ (top) and $\chi^2(12, N = 485) = 71.45, p < .001; \Phi = .38$; Cramer's $V = .22$ (bottom). For top (twin 1 smoking by twin 2 drinking): for monozygotic twins (tables not shown), $\chi^2(12, N = 213) = 34.63, p < .001; \Phi = .40$; Cramer's $V = .23$; for dizygotic twins, $\chi^2(12, N = 272) = 57.47, p < .001; \Phi = .46$; Cramer's $V = .27$. For bottom (twin 1 drinking by twin 2 smoking): for monozygotic twins (tables not shown), $\chi^2(12, N = 213) = 36.71, p < .001; \Phi = .42$; Cramer's $V = .24$; for dizygotic twins, $\chi^2(12, N = 272) = 49.58, p < .001; \Phi = .43$; Cramer's $V = .25$.

Numbers with up arrows (†) indicate values that are significantly greater ($p < .01$, based on a cell χ^2 value of 6.64 with one degree of freedom) than would be expected by chance ("types"). Numbers with down arrows (↓) indicate values that are significantly less ($p < .01$) than would be expected by chance ("antitypes"). Not all numbers add to 100% because of rounding.

age but whose smoking was distinguished during adolescence, with one group initiating use at a much earlier age than the other group. Five trajectories of drinking were characterized, including the same patterns of use as those identified for smoking as well as an additional one that reflected high use by 25 years of age but moderate use at study initiation. It was demonstrated that longitudinal phenotypes of smoking and drinking showed similar patterns of change, particularly for those with onset at an early age and those who exhibited delayed onset but still heavy use by young adulthood. In addition, smokers who began at an early age were also likely to initiate heavy drinking at some later point; this could be evidence for a directional relation between smoking and drinking, or perhaps it might be due to contextual variables that permitted the younger adolescent access or opportunity to smoke but not drink. Non/low smokers generally exhibited some drinking, consistent with norms in Finland for high-density drinking, often to intoxication.^{181,182}

In addition to examining the relation between developmental courses of two substances, conjoint courses were characterized represented by both smoking and drinking behaviors. Some groups were identified that might be expected on the basis of the results from the single-substance trajectories (i.e., early-onset, chronic high users of both substances; delayed-onset users of both substances; non/low smokers who drank with low frequency), as well as some additional groups that were discriminated on the basis of smoking and drinking (i.e., non/low drinking with stable moderate smoking; early-onset, chronic high drinkers who were non/low smokers or moderate smokers; delayed-onset drinkers who were non/low smokers).

For both approaches, the question was asked as to whether there was preliminary evidence for genetic influences underlying

course of substance use, as well as common influences underlying the courses of conjoint substance use. Concordance between twin pairs differed as a function of zygosity, with monozygotic twins showing greater concordance for smoking and for drinking than did dizygotic twins. Of importance, the conjoint trajectories revealed even greater concordance than the single-substance trajectories, underscoring the value of utilizing substance-use phenotypes that capture as much information as possible.

That greater concordance for trajectories of substance use among monozygotic twin brothers was found suggests genetic influences, but it must be emphasized that genetic effects suggested by these analyses may reflect gene-environment correlations, arising from genetically conditioned differences in susceptibility to environmental exposure rather than from independent genetic effects. It should also be emphasized that these analyses necessarily make the usual assumptions underlying twin comparisons, including the assumption that outcome-relevant environmental experience does not differ between monozygotic and dizygotic twin brothers. Substance use is influenced by siblings' shared experiences and their reciprocal interactions,¹⁸³ and greater similarities in smoking and drinking trajectories of monozygotic twin brothers may, in part, reflect their greater frequency of social contact and greater overlap in peer networks.¹⁸⁴ Social contact among adult Finnish twin brothers accounts for significant variance in their patterns of alcohol consumption, but modeling the effect of social contact does not markedly reduce estimates of genetic variance; instead, it reduces the variance otherwise attributed to unmeasured (and unshared) residual environmental sources.¹⁸³ Accordingly, the inference made here that genetic influences contribute to different trajectories of substance use appears to be an appropriate one.

This is the first study to consider the extent to which courses of substance use might be heritable and to offer evidence that pathways of substance use may be genetically influenced. Given that there is value in using longitudinal phenotypes such as these, it is important to consider how genetic research might use these phenotypes. Membership in a given developmental trajectory, captured by a single categorical latent variable, reflects age of onset and severity as well as change (slope) in use of a substance; moreover, membership in a trajectory characterized by concurrent use of two (or more) substances simultaneously provides information for multiple substances. Previously, research that sought to examine these constructs had to model four separate pieces of information. Although latent growth models do provide information regarding onset, severity, and course, they reflect “average” change and fail to capture homogeneous groups or subtypes. To explore the heritability of class membership, the variance components of the underlying variability can be modeled (e.g., with Cholesky decomposition models) by using a series of dummy codes that represent the nominal classes (or polychoric correlations if the classes lie on an underlying continuum). These analyses might build on work by Eaves and colleagues,^{185,186} which examined the extent to which patterns of pairwise concordance and discordance in latent class membership differed between monozygotic and dizygotic twin pairs. A quantifiable estimate of the genetic contribution to the risk of taking different pathways in development is an area for further development. In addition, certain groups might be selected as “extreme” groups that can be genotyped in a more efficient manner than genetic analyses that must consider the entire sample.

This study has demonstrated the utility of using a latent variable reflecting course characterizing use of multiple substances. However, researchers must use theory to

guide analyses with the goal of comparing subtypes that are of theoretical interest. For example, a researcher might select two courses of smoking that are characterized by similar age of onset but different slope or level of severity (or vice versa) and conduct comparisons between these courses. For concurrent use of substances, a researcher may wish to compare courses represented by a single substance with courses represented by multiple substances (e.g., a course characterized by high smoking and low drinking versus a course characterized by high smoking and high drinking). If the genetic influence underlying the latter is no stronger than the former, one might infer presence of a common underlying genetic influence.

The methodological issues that arise when characterizing course of multiple substances should be noted. First, the investigator should decide what analytic approach to take—that is, whether to simultaneously model multiple latent growth factors (e.g., one for each substance) in a single multivariate analysis or whether to derive courses for each substance separately and then model conjoint use by estimating concordance between each substance-based trajectory.¹⁸⁷ Each approach has advantages.

The first approach (i.e., the multivariate approach) explicitly models comorbidity and its change over time. It is also more parsimonious than the second approach. For example, if one considers four courses of smoking and five courses of drinking (as suggested in the preceding univariate analyses), there are 20 possible combinations of smoking and drinking. However, the analyses presented here suggest no more than seven dual trajectories. That is, using multiple univariate (one substance at a time) approaches to model comorbidity, the investigator can be modeling forms of comorbidity that are unlikely to exist in nature but are implied by bringing together univariate solutions.

However, the virtue of the univariate approach is that it provides estimates of trajectories that are specific to a target outcome (e.g., smoking only) and thus are not influenced by aspects of the comorbid behavior not directly relevant to the substances under consideration. For example, one might expect differing determinants of a comorbid course than of a single-substance course (e.g., availability of both substances; social norming of both smoking and drinking behavior). In addition, a common genetic influence is likely for multiple problem behaviors other than substance use.^{48,49} As a result, adequately specifying the phenotype underlying use of both substances becomes increasingly complex. Finally, this essentially univariate approach provides estimates of comorbidity (e.g., concordance) that are similar to more traditional cross-sectional approaches (e.g., a likelihood-based measure or a measure of agreement such as Cohen's kappa). It is noted that both approaches become more challenging when three or more substances are considered both illustratively and, especially in the multivariate case, computationally. It is reassuring, however, that the two approaches yielded similar findings in the empirical example.

In addition, the empirical example fails to resolve other aspects of substance involvement such as average and maximum quantity consumed and substance-use disorders and problems. In prior work,¹¹⁷ it was shown that classes based on different facets of drinking behavior can show similar course shapes (i.e., corresponding intercepts and slopes) but different course prevalences and low-to-moderate cross-class memberships (i.e., assignment to “similar-looking” classes on the basis of different input variables). As such, the present example is a simplification, and distinctions may be observed between different aspects of smoking behavior in terms of developmental course.

In a related way, trajectory shape and prevalence may differ as a function of the developmental period under consideration. In chapter 5, the authors characterize trajectories over a broader age span (ages 10–32 years) than in the present example (ages 16–25 years); the authors were able to extract five latent classes as well as identify three a priori groups. Many of the trajectories observed in that chapter correspond to this one, including an early-onset, persistent group; a moderate/explorer group; and a group of abstainers making up roughly one-half the sample. However, in contrast to the findings presented here, chapter 5 identifies two distinct delayed-onset groups. It is likely that the present delayed-onset group—those who began smoking at about 17 years of age—maps onto the two delayed-onset groups in chapter 5, with onset at ages 14 and 18 years, respectively. In addition, whereas smoking by 25 years of age was equally high for the early- and delayed-onset groups in the present example, in chapter 5 the delayed-onset groups failed to “catch up” to the early-onset, persistent group by 32 years of age. Finally, the present chapter did not identify a group of smokers who had quit; it is not unlikely that had the participants been followed for an additional decade or so, a corresponding quitter group would have been observed.

Another methodological consideration concerns modeling age of onset for simultaneous processes. There is an exciting class of models in which trajectory classes can be derived on the basis of growth mixtures, but initiation serves as the intercept (i.e., course is modeled separately from age).¹⁸⁸ However, there appear to be conceptual and estimation challenges extending such “initiation-based intercept models” to multiple substances; courses of multiple substances may show comparable trajectory structure but mismatched onsets.

In addition, when considering the association between two substances, it is important to consider the extent to which an association is due to a group of constant nonusers or abstainers. Prescott and Kendler⁸¹ raised the question of whether much of the genetic covariation between tobacco and alcohol use may be due to the large group of abstainers; they found that shared (genetic) variation between tobacco and alcohol use was much reduced when abstainers were removed. Tucker and colleagues¹⁵⁶ noted that the greatest overlap across substances was among abstainers. Interestingly, when excluding abstainers from the present analyses, virtually no reduction was observed in cross-twin association for the conjoint trajectories: $\chi^2(25, N = 485) = 618.88, p < .001; \Phi = 1.18$; Cramer's $V = .53$; $\kappa = .42$ (95% CI, .37–.48); this was true within zygosity as well.

An alternative approach to examining genetic influences on variability on course involves two-stage genetic models that distinguish between initiation and progression of use,^{189,190} integration of these models with the developmental approach might yield the most informative phenotypes. It seems likely that the two approaches (i.e., two-stage genetic models that independently estimate effects on initiation and effects on progression, conditional on initiation, and genetic models of growth mixtures or other types of trajectories) will yield different types of insights or phenomena. For example, the two-stage genetic models seem especially useful for identifying risk factors that are specific to various phases of substance-use careers.¹⁹¹ The growth mixture approach offers an opportunity to derive empirically based complex phenotypes that capture associated clinical features, course, and developmental references.

It is important to note that although course is an essential dimension for characterizing behavior or disorder, it is

not necessarily a “genetic” one. Although some degree of chronicity is almost certainly related to the degree of genetic risk, genetically identical individuals who are afflicted with the same largely genetic condition can show marked variation in course.¹⁹² As is true in all forms of genetic modeling, inclusion of more explicit measures of the environment—both fixed (e.g., early toxic exposure) or time varying (e.g., environments supportive or suppressive of substance use, various role occupancies)—can only serve to sharpen an assessment of the environment and better understand key characteristics such as course.

Finally, these analyses were based on a Finnish sample of twin brothers; generalizability to nontwins and other cultures with different genetic backgrounds, cultural influences surrounding tobacco and other drug use, and formal alcohol and tobacco prevention and control policies may not be straightforward. However, prior work^{160,193,194} shows that overall patterns of trajectories are quite similar in Finland to those studied elsewhere.

Summary

The goal of this chapter is to explore the extent to which developmental courses of substance use are nonspecific or whether there are developmental phenotypes that are unique to tobacco use. The review of the extant literature and the empirical example suggest that there is evidence for both of these notions. The identification of comparable overlapping developmental pathways for smoking and drinking supports the idea of an underlying general factor indicating common liability (perhaps genetic) to the use of multiple substances. Yet, identification of groups with divergent trajectories of multiple substances (e.g., moderate or chronic high drinking by nonsmokers; both abstinence and early-onset, chronic drinking by

moderate smokers) suggests substance-specific pathways. As the example in this chapter clearly shows, both common and specific developmental pathways can coexist. A worthwhile goal for future genetic research would be to examine the extent to which different combinations of course are genetically influenced. For example, one might expect, based on Prescott and Kendler⁸¹ and Tucker and colleagues¹⁵⁶ (although perhaps not from the example in the present chapter), that membership in the low-using/abstaining course for both groups would be highly genetically influenced and that membership in a course marked by low smoking and delayed-onset drinking might be more environmentally influenced. Clearly, the opportunities for identifying highly genetically influenced substance-use behaviors are considerable.

As summarized earlier, a body of research demonstrates evidence of shared genetic risk for use of different substances. However, much of this work relies on lifetime substance use or dependence. If one wishes to distinguish among syndromes that are chronic, episodic, developmentally limited, or reactive and transient, it is critical to prospectively characterize the course of substance use and problems. Although much work has described the developmental course of single substances over the period from adolescence to adulthood, researchers have now begun to simultaneously consider multiple substances. Studies that jointly consider comorbidity and course will permit researchers to determine the extent to which trajectories unique to a single substance versus those reflecting substance use more generally best identify longitudinal phenotypes for genetic study. If it can be shown that phenotypes represented by broader substance-use trajectories are equally or more heritable than single-substance trajectories, both phenotypic and genetic work can proceed more efficiently. Findings would also have implications for whether researchers should take a more

generic approach in the prevention and treatment of substance-use disorders. It is hoped that this chapter will inspire researchers to conduct work that reveals the optimal longitudinal phenotype for understanding genetic effects on substance use and substance-use disorders.

Conclusions

1. Studies examining the developmental course of multiple substances have shown relatively high concordance between identified trajectories despite diverse course shapes and different course prevalences.
2. Membership in a given developmental trajectory, which can be captured by a single categorical latent variable, represents age of onset and severity as well as change (slope) in use of a substance; moreover, membership in a trajectory characterized by concurrent use of two (or more) substances simultaneously provides information for multiple substances.
3. Developmental course might serve as a valuable phenotype for biometric models, and determining the degree to which a phenotype of developmental course is substance specific is valuable for the genetic study of addictive behavior.
4. Evidence using twin data indicates that courses of substance use are genetically influenced, with monozygotic twins showing greater concordance for smoking and for drinking than do dizygotic twins. The genetic contribution to the risk of taking different pathways in development represents an area for further study.
5. Conjoint trajectories of drinking and smoking reveal even greater concordance than do single-substance trajectories, suggesting greater heritability for courses extracted from several substances. This underscores the value of considering

substance use across multiple domains when constructing phenotypes for research and perhaps even for clinical use. However, extending the concept of the components of developmental substance-use phenotypes raises new questions such as, Which substances? What aspects of substance use or its consequences? Which periods of development? Thus, the findings show the value of extending the concept of substance-use phenotypes

but not necessarily optimal phenotypes that “carve nature at its joints.”

6. If resources are limited for genetic analyses, focusing on those with the most “extreme” phenotypes marked by both high initial level and chronic continued use may represent an efficient strategy for identifying genes associated with more problematic forms of substance use.

References

- Anthony, J. C., and F. Echeagaray-Wagner. 2000. Epidemiologic analysis of alcohol and tobacco use. *Alcohol Research & Health* 24 (4): 201–8.
- Bien, T. H., and R. Burge. 1990. Smoking and drinking: A review of the literature. *International Journal of the Addictions* 25 (12): 1429–54.
- Dawson, D. A. 2000. Drinking as a risk factor for sustained smoking. *Drug and Alcohol Dependence* 59 (3): 235–49.
- Istvan, J., and J. D. Matarazzo. 1984. Tobacco, alcohol, and caffeine use: A review of their interrelationships. *Psychological Bulletin* 95 (2): 301–26.
- Degenhardt, L., W. Hall, and M. Lynskey. 2001. Alcohol, cannabis and tobacco use among Australians: A comparison of their associations with other drug use and use disorders, affective and anxiety disorders, and psychosis. *Addiction* 96 (11): 1603–14.
- Earleywine, M., and M. D. Newcomb. 1997. Concurrent versus simultaneous polydrug use: Prevalence, correlates, discriminant validity, and prospective effects on health outcomes. *Experimental and Clinical Psychopharmacology* 5 (4): 353–64.
- Richter, K. P., H. Kaur, K. Resnicow, N. Nazir, M. C. Mosier, and J. S. Ahluwalia. 2004. Cigarette smoking among marijuana users in the United States. *Substance Abuse* 25 (2): 35–43.
- Aung, A. T., W. B. Pickworth, and E. T. Moolchan. 2004. History of marijuana use and tobacco smoking topography in tobacco-dependent adolescents. *Addictive Behaviors* 29 (4): 699–706.
- Ellickson, P. L., J. S. Tucker, and D. J. Klein. 2001. High-risk behaviors associated with early smoking: Results from a 5-year follow-up. *Journal of Adolescent Health* 28 (6): 465–73.
- Dee, T. S. 1999. The complementarity of teen smoking and drinking. *Journal of Health Economics* 18 (6): 769–93.
- Degenhardt, L., and W. Hall. 2001. The relationship between tobacco use, substance-use disorders and mental health: Results from the National Survey of Mental Health and Well-being. *Nicotine & Tobacco Research* 3 (3): 225–34.
- Duhig, A. M., D. A. Cavallo, S. A. McKee, T. P. George, and S. Krishnan-Sarin. 2005. Daily patterns of alcohol, cigarette, and marijuana use in adolescent smokers and nonsmokers. *Addictive Behaviors* 30 (2): 271–83.
- Everett, S. A., G. A. Giovino, C. W. Warren, L. Crossett, and L. Kann. 1998. Other substance use among high school students who use tobacco. *Journal of Adolescent Health* 23 (5): 289–96.
- Johnson, P. B., S. M. Boles, R. Vaughan, and H. D. Kleber. 2000. The co-occurrence of smoking and binge drinking in adolescence. *Addictive Behaviors* 25 (5): 779–83.
- Jones, S. E., J. Oeltmann, T. W. Wilson, N. D. Brener, and C. V. Hill. 2001. Binge drinking among undergraduate college students in the United States: Implications for other substance use. *Journal of American College Health* 50 (1): 33–38.
- Ritchey, P. N., G. S. Reid, and L. A. Hasse. 2001. The relative influence of smoking on drinking and drinking on smoking among high school students in a rural tobacco-growing county. *Journal of Adolescent Health* 29 (6): 386–94.
- Wetzels, J. J., S. P. Kremers, P. D. Vitoria, and H. de Vries. 2003. The alcohol-tobacco relationship: A prospective study among adolescents in six European countries. *Addiction* 98 (12): 1755–63.
- Chen, X., J. B. Unger, P. Palmer, M. D. Weiner, C. A. Johnson, M. M. Wong, and G. Austin. 2002. Prior cigarette smoking initiation predicting current alcohol use: Evidence for a gateway drug effect among California adolescents from eleven ethnic groups. *Addictive Behaviors* 27 (5): 799–817.
- Brook, D. W., J. S. Brook, C. Zhang, P. Cohen, and M. Whiteman. 2002. Drug use and the risk of major depressive disorder, alcohol dependence, and substance use disorders. *Archives of General Psychiatry* 59 (11): 1039–44.
- Jackson, K. M., K. J. Sher, M. L. Cooper, and P. K. Wood. 2002. Adolescent alcohol and tobacco use: Onset, persistence and trajectories of use across two samples. *Addiction* 97 (5): 517–31.
- Mohler-Kuo, M., J. E. Lee, and H. Wechsler. 2003. Trends in marijuana and other illicit drug use among college students: Results from 4 Harvard School of Public Health College Alcohol Study surveys: 1993–2001. *Journal of American College Health* 52 (1): 17–24.

22. Rigotti, N. A., J. E. Lee, and H. Wechsler. 2000. US college students' use of tobacco products: Results of a national survey. *JAMA: The Journal of the American Medical Association* 284 (6): 699–705.
23. Schorling, J. B., M. Gutgesell, P. Klas, D. Smith, and A. Keller. 1994. Tobacco, alcohol and other drug use among college students. *Journal of Substance Abuse* 6 (1): 105–15.
24. Weitzman, E. R., and Y. Y. Chen. 2005. The co-occurrence of smoking and drinking among young adults in college: National survey results from the United States. *Drug and Alcohol Dependence* 80 (3): 377–86.
25. Breslau, N. 1995. Psychiatric comorbidity of smoking and nicotine dependence. *Behavior Genetics* 25 (2): 95–101.
26. Day, N. E., and N. Munoz. 1982. Esophagus. In *Cancer epidemiology and prevention*, ed. D. Schottenfeld and J. F. Fraumeni Jr., 596–632. Philadelphia: Saunders.
27. Zambon, P., R. Talamini, C. La Vecchia, L. Dal Maso, E. Negri, S. Tognazzo, L. Simonato, and S. Franceschi. 2000. Smoking, type of alcoholic beverage and squamous-cell oesophageal cancer in northern Italy. *International Journal of Cancer* 86 (1): 144–49.
28. Flanders, W. D., and K. J. Rothman. 1982. Interaction of alcohol and tobacco in laryngeal cancer. *American Journal of Epidemiology* 115 (3): 371–79.
29. Pelucchi, C., S. Gallus, W. Garavello, C. Bosetti, and C. La Vecchia. 2006. Cancer risk associated with alcohol and tobacco use: Focus on upper aero-digestive tract and liver. *Alcohol Research & Health* 29 (3): 193–98.
30. Talamini, R., C. Bosetti, C. La Vecchia, L. Dal Maso, F. Levi, E. Bidoli, E. Negri, et al. 2002. Combined effect of tobacco and alcohol on laryngeal cancer risk: A case-control study. *Cancer Causes & Control* 13 (10): 957–64.
31. Blot, W. J., J. K. McLaughlin, D. M. Winn, D. F. Austin, R. S. Greenberg, S. Preston-Martin, L. Bernstein, J. B. Schoenberg, A. Stemhagen, and J. F. Fraumeni Jr. 1988. Smoking and drinking in relation to oral and pharyngeal cancer. *Cancer Research* 48 (11): 3282–87.
32. Hayes, R. B., E. Bravo-Otero, D. V. Kleinman, L. M. Brown, J. F. Fraumeni Jr., L. C. Harty, and D. M. Winn. 1999. Tobacco and alcohol use and oral cancer in Puerto Rico. *Cancer Causes & Control* 10 (1): 27–33.
33. Kerr, J. S., N. Sherwood, and I. Hindmarch. 1991. Separate and combined effects of the social drugs on psychomotor performance. *Psychopharmacology (Berl)* 104 (1): 113–19.
34. Madden, P. A., A. C. Heath, G. A. Starmer, J. B. Whitfield, and N. G. Martin. 1995. Alcohol sensitivity and smoking history in men and women. *Alcoholism, Clinical and Experimental Research* 19 (5): 1111–20.
35. Jackson, K. M., K. J. Sher, and P. K. Wood. 2000. Trajectories of concurrent substance use disorders: A developmental, typological approach to comorbidity. *Alcoholism, Clinical and Experimental Research* 24 (6): 902–13.
36. Kandel, D. B., ed. 2002. *Stages and pathways of drug involvement: Examining the gateway hypothesis*. Cambridge, UK: Cambridge Univ. Press.
37. Bailey, S. L. 1992. Adolescents' multisubstance use patterns: The role of heavy alcohol and cigarette use. *American Journal of Public Health* 82 (9): 1220–24.
38. Hanna, E. Z., and B. F. Grant. 1999. Parallels to early onset alcohol use in the relationship of early onset smoking with drug use and DSM-IV drug and depressive disorders: Findings from the National Longitudinal Epidemiologic Survey. *Alcoholism, Clinical and Experimental Research* 23 (3): 513–22.
39. Torabi, M. R., W. J. Bailey, and M. Majd-Jabbari. 1993. Cigarette smoking as a predictor of alcohol and other drug use by children and adolescents: Evidence of the "gateway drug effect." *Journal of School Health* 63 (7): 302–6.
40. Morral, A. R., D. F. McCaffrey, and S. M. Paddock. 2002. Reassessing the marijuana gateway effect. *Addiction* 97 (12): 1493–504.
41. Jessor, R., and S. L. Jessor. 1977. *Problem behavior and psychosocial development: A longitudinal study of youth*. New York: Academic Press.
42. Donovan, J. E., and R. Jessor. 1985. Structure of problem behavior in adolescence and young adulthood. *Journal of Consulting and Clinical Psychology* 53 (6): 890–904.
43. Donovan, J. E., R. Jessor, and F. M. Costa. 1988. Syndrome of problem behavior in adolescence: A replication. *Journal of Consulting and Clinical Psychology* 56 (5): 762–65.
44. Donovan, J. E., R. Jessor, and F. M. Costa. 1999. Adolescent problem drinking: Stability

- of psychosocial and behavioral correlates across a generation. *Journal of Studies on Alcohol* 60 (3): 352–61.
45. Farrell, A. D., S. J. Danish, and C. W. Howard. 1992. Relationship between drug use and other problem behaviors in urban adolescents. *Journal of Consulting and Clinical Psychology* 60 (5): 705–12.
 46. Turbin, M. S., R. Jessor, and F. M. Costa. 2000. Adolescent cigarette smoking: Health-related behavior or normative transgression? *Prevention Science* 1 (3): 115–24.
 47. Krueger, R. F., A. Caspi, T. E. Moffitt, and P. A. Silva. 1998. The structure and stability of common mental disorders (DSM-III-R): A longitudinal/epidemiological study. *Journal of Abnormal Psychology* 107 (2): 216–27.
 48. Krueger, R. F., K. E. Markon, C. J. Patrick, and W. G. Iacono. 2005. Externalizing psychopathology in adulthood: A dimensional-spectrum conceptualization and its implications for DSM-V. *Journal of Abnormal Psychology* 114 (4): 537–50.
 49. Krueger, R. F., B. M. Hicks, C. J. Patrick, S. R. Carlson, W. G. Iacono, and M. McGue. 2002. Etiologic connections among substance dependence, antisocial behavior, and personality: Modeling the externalizing spectrum. *Journal of Abnormal Psychology* 111 (3): 411–24.
 50. McGue, M., W. G. Iacono, and R. Krueger. 2006. The association of early adolescent problem behavior and adult psychopathology: A multivariate behavioral genetic perspective. *Behavior Genetics* 36 (4): 591–602.
 51. McGue, M., and W. G. Iacono. 2005. The association of early adolescent problem behavior with adult psychopathology. *American Journal of Psychiatry* 162 (6): 1118–24.
 52. Crawford, A. M., M. A. Pentz, C. P. Chou, C. Li, and J. H. Dwyer. 2003. Parallel developmental trajectories of sensation seeking and regular substance use in adolescents. *Psychology of Addictive Behaviors* 17 (3): 179–92.
 53. Elkins, I. J., S. M. King, M. McGue, and W. G. Iacono. 2006. Personality traits and the development of nicotine, alcohol, and illicit drug disorders: Prospective links from adolescence to young adulthood. *Journal of Abnormal Psychology* 115 (1): 26–39.
 54. Disney, E. R., I. J. Elkins, M. McGue, and W. G. Iacono. 1999. Effects of ADHD, conduct disorder, and gender on substance use and abuse in adolescence. *American Journal of Psychiatry* 156 (10): 1515–21.
 55. Molina, B. S., and W. E. Pelham Jr. 2003. Childhood predictors of adolescent substance use in a longitudinal study of children with ADHD. *Journal of Abnormal Psychology* 112 (3): 497–507.
 56. King, S. M., W. G. Iacono, and M. McGue. 2004. Childhood externalizing and internalizing psychopathology in the prediction of early substance use. *Addiction* 99 (12): 1548–59.
 57. Lynskey, M. T., D. M. Fergusson, and L. J. Horwood. 1998. The origins of the correlations between tobacco, alcohol, and cannabis use during adolescence. *Journal of Child Psychology and Psychiatry* 39 (7): 995–1005.
 58. Stein, J. A., M. D. Newcomb, and P. M. Bentler. 1987. An 8-year study of multiple influences on drug use and drug use consequences. *Journal of Personality and Social Psychology* 53 (6): 1094–105.
 59. McGee, L., and M. D. Newcomb. 1992. General deviance syndrome: Expanded hierarchical evaluations at four ages from early adolescence to adulthood. *Journal of Consulting and Clinical Psychology* 60 (5): 766–76.
 60. Vanyukov, M. M., R. E. Tarter, L. Kirisci, G. P. Kirillova, B. S. Maher, and D. B. Clark. 2003. Liability to substance use disorders: 1. Common mechanisms and manifestations. *Neuroscience and Biobehavioral Reviews* 27 (6): 507–15.
 61. Petraitis, J., B. R. Flay, and T. Q. Miller. 1995. Reviewing theories of adolescent substance use: Organizing pieces in the puzzle. *Psychological Bulletin* 117 (1): 67–86.
 62. Flay, B. R., and J. Petraitis. 1994. The theory of triadic influence: A new theory of health behavior with implications for preventive interventions. In *Advances in medical sociology, vol. IV: A reconsideration of models of health behavior change*, ed. G. S. Albrecht, 19–44. Greenwich, CT: JAI Press.
 63. Catalano, R. F., and J. D. Hawkins. 1996. The social development model: A theory of antisocial behavior. In *Delinquency and crime: Current theories*, ed. J. D. Hawkins, 149–97, xvii. New York: Cambridge Univ. Press.
 64. Hawkins, J. D., R. F. Catalano, and J. Y. Miller. 1992. Risk and protective factors for alcohol and other drug problems

- in adolescence and early adulthood: Implications for substance abuse prevention. *Psychological Bulletin* 112 (1): 64–105.
65. West, R. 2006. *Theory of addiction*. Malden, MA: Wiley-Blackwell.
 66. Gillmore, M. R., J. D. Hawkins, R. F. Catalano Jr., L. E. Day, M. Moore, and R. Abbott. 1991. Structure of problem behaviors in preadolescence. *Journal of Consulting and Clinical Psychology* 59 (4): 499–506.
 67. Guilamo-Ramos, V., H. A. Litardo, and J. Jaccard. 2005. Prevention programs for reducing adolescent problem behaviors: Implications of the co-occurrence of problem behaviors in adolescence. *Journal of Adolescent Health* 36 (1): 82–86.
 68. Willoughby, T., H. Chalmers, and M. A. Busseri. 2004. Where is the syndrome? Examining co-occurrence among multiple problem behaviors in adolescence. *Journal of Consulting and Clinical Psychology* 72 (6): 1022–37.
 69. White, H. R., and E. W. Labouvie. 1994. Generality versus specificity of problem behavior: Psychological and functional differences. *Journal of Drug Issues* 24 (1–2): 55–74.
 70. Flay, B. R., J. Petraitis, and F. B. Hu. 1995. Theory of triadic influence: Preliminary evidence related to alcohol and tobacco use. In *Alcohol and tobacco: From basic science to clinical practice* (Research monograph no. 30, NIH publication no. 95-3931), ed. J. B. Fertig and J. P. Allen, 37–57. Bethesda, MD: National Institute on Alcohol Abuse and Alcoholism.
 71. Welte, J. W., G. M. Barnes, and J. H. Hoffman. 2004. Gambling, substance use, and other problem behaviors among youth: A test of general deviance models. *Journal of Criminal Justice* 32 (4): 297–306.
 72. Zhang, L., J. W. Welte, and W. F. Wieczorek. 2002. Underlying common factors of adolescent problem behaviors. *Criminal Justice and Behavior* 29 (2): 161–82.
 73. Dembo, R., L. Williams, and J. Schmeidler. 1994. Psychosocial, alcohol/other drug use, and delinquency differences between urban Black and White male high risk youth. *International Journal of the Addictions* 29 (4): 461–83.
 74. Osgood, D. W., L. D. Johnston, P. M. O'Malley, and J. G. Bachman. 1988. The generality of deviance in late adolescence and early adulthood. *American Sociological Review* 53 (1): 81–93.
 75. Resnicow, K., D. Ross-Gaddy, and R. D. Vaughan. 1995. Structure of problem and positive behaviors in African American youths. *Journal of Consulting and Clinical Psychology* 63 (4): 594–603.
 76. White, H. R. 1992. Early problem behavior and later drug problems. *Journal of Research in Crime and Delinquency* 29 (4): 412–29.
 77. Zucker, R. A. 2006. The developmental behavior genetics of drug involvement: Overview and comments. *Behavior Genetics* 36 (4): 616–25.
 78. Carmelli, D., and G. E. Swan. 1995. Genetic and environmental influences on tobacco and alcohol consumption in World War II male veteran twins. In *Alcohol and tobacco: From basic science to clinical practice* (NIAAA research monograph no. 30), ed. J. B. Fertig and J. P. Allen, 89–106. Bethesda, MD: U.S. Department of Health and Human Services.
 79. Hettema, J. M., L. A. Corey, and K. S. Kendler. 1999. A multivariate genetic analysis of the use of tobacco, alcohol, and caffeine in a population based sample of male and female twins. *Drug and Alcohol Dependence* 57 (1): 69–78.
 80. Koopmans, J. R., L. J. van Doornen, and D. I. Boomsma. 1997. Association between alcohol use and smoking in adolescent and young adult twins: A bivariate genetic analysis. *Alcoholism, Clinical and Experimental Research* 21 (3): 537–46.
 81. Prescott, C. A., and K. S. Kendler. 1995. Genetic and environmental influences on alcohol and tobacco dependence among women. In *Alcohol and tobacco: From basic science to clinical practice* (NIAA research monograph no. 30, NIH publication no. 95-3931), ed. J. B. Fertig and J. P. Allen, 59–87. Washington, DC: National Institute on Alcohol Abuse and Alcoholism.
 82. Madden, P. A., A. C. Heath, and N. G. Martin. 1997. Smoking and intoxication after alcohol challenge in women and men: Genetic influences. *Alcoholism, Clinical and Experimental Research* 21 (9): 1732–41.
 83. Madden, P. A., K. K. Bucholz, N. G. Martin, and A. C. Heath. 2000. Smoking and the genetic contribution to alcohol-dependence risk. *Alcohol Research & Health* 24 (4): 209–14.
 84. Madden, P. A., and A. C. Heath. 2002. Shared genetic vulnerability in alcohol and cigarette use and dependence. *Alcoholism,*

- Clinical and Experimental Research* 26 (12): 1919–21.
85. True, W. R., H. Xian, J. F. Scherrer, P. A. Madden, K. K. Bucholz, A. C. Heath, S. A. Eisen, M. J. Lyons, J. Goldberg, and M. Tsuang. 1999. Common genetic vulnerability for nicotine and alcohol dependence in men. *Archives of General Psychiatry* 56 (7): 655–61.
 86. Volk, H. E., J. F. Scherrer, K. K. Bucholz, A. Todorov, A. C. Heath, T. Jacob, and W. R. True. 2007. Evidence for specificity of transmission of alcohol and nicotine dependence in an offspring of twins design. *Drug and Alcohol Dependence* 87 (2–3): 225–32.
 87. Maes, H. H., C. E. Woodard, L. Murrelle, J. M. Meyer, J. L. Silberg, J. K. Hewitt, M. Rutter, et al. 1999. Tobacco, alcohol and drug use in eight- to sixteen-year-old twins: The Virginia Twin Study of Adolescent Behavioral Development. *Journal of Studies on Alcohol* 60 (3): 293–305.
 88. Young, S. E., S. H. Rhee, M. C. Stallings, R. P. Corley, and J. K. Hewitt. 2006. Genetic and environmental vulnerabilities underlying adolescent substance use and problem use: General or specific? *Behavior Genetics* 36 (4): 603–15.
 89. Yoon, H. H., W. G. Iacono, S. M. Malone, and M. McGue. 2006. Using the brain P300 response to identify novel phenotypes reflecting genetic vulnerability for adolescent substance misuse. *Addictive Behaviors* 31 (6): 1067–87.
 90. Fu, Q., A. C. Heath, K. K. Bucholz, E. Nelson, J. Goldberg, M. J. Lyons, W. R. True, T. Jacob, M. T. Tsuang, and S. A. Eisen. 2002. Shared genetic risk of major depression, alcohol dependence, and marijuana dependence: Contribution of antisocial personality disorder in men. *Archives of General Psychiatry* 59 (12): 1125–32.
 91. Kendler, K. S., C. A. Prescott, J. Myers, and M. C. Neale. 2003. The structure of genetic and environmental risk factors for common psychiatric and substance use disorders in men and women. *Archives of General Psychiatry* 60 (9): 929–37.
 92. Pickens, R. W., D. S. Svikis, M. McGue, and M. C. LaBuda. 1995. Common genetic mechanisms in alcohol, drug, and mental disorder comorbidity. *Drug and Alcohol Dependence* 39 (2): 129–38.
 93. Prescott, C. A., P. A. Madden, and M. C. Stallings. 2006. Challenges in genetic studies of the etiology of substance use and substance use disorders: Introduction to the special issue. *Behavior Genetics* 36 (4): 473–82.
 94. Bierut, L. J., S. H. Dinwiddie, H. Begleiter, R. R. Crowe, V. Hesselbrock, J. I. Nurnberger Jr., B. Porjesz, M. A. Schuckit, and T. Reich. 1998. Familial transmission of substance dependence: Alcohol, marijuana, cocaine, and habitual smoking. A report from the Collaborative Study on the Genetics of Alcoholism. *Archives of General Psychiatry* 55 (11): 982–88.
 95. Bierut, L. J., M. A. Schuckit, V. Hesselbrock, and T. Reich. 2000. Co-occurring risk factors for alcohol dependence and habitual smoking. *Alcohol Research & Health* 24 (4): 233–41.
 96. Nurnberger, J. I. Jr., R. Wiegand, K. Bucholz, S. O'Connor, E. T. Meyer, T. Reich, J. Rice, et al. 2004. A family study of alcohol dependence: Coaggregation of multiple disorders in relatives of alcohol-dependent probands. *Archives of General Psychiatry* 61 (12): 1246–56.
 97. Botvin, G. J., E. Baker, L. Dusenbury, E. M. Botvin, and T. Diaz. 1995. Long-term follow-up results of a randomized drug abuse prevention trial in a white middle-class population. *JAMA: The Journal of the American Medical Association* 273 (14): 1106–12.
 98. Chou, C. P., S. Montgomery, M. A. Pentz, L. A. Rohrbach, C. A. Johnson, B. R. Flay, and D. P. MacKinnon. 1998. Effects of a community-based prevention program on decreasing drug use in high-risk adolescents. *American Journal of Public Health* 88 (6): 944–48.
 99. Ellickson, P. L., and R. M. Bell. 1990. Drug prevention in junior high: A multi-site longitudinal test. *Science* 247 (4948): 1299–305.
 100. Griffin, K. W., G. J. Botvin, T. R. Nichols, and M. M. Doyle. 2003. Effectiveness of a universal drug abuse prevention approach for youth at high risk for substance use initiation. *Preventive Medicine* 36 (1): 1–7.
 101. Pentz, M. A. 1998. Preventing drug abuse through the community: Multicomponent programs make the difference. In *Putting research to work for the community* (NIDA publication no. 98-4293), ed. A. Sloboda and W. V. Hansen, 73–86. Rockville, MD: U.S. Department of Health and Human Services, National Institute on Drug Abuse.

102. Pentz, M. A., J. H. Dwyer, D. P. MacKinnon, B. R. Flay, W. B. Hansen, E. Y. Wang, and C. A. Johnson. 1989. A multicommunity trial for primary prevention of adolescent drug abuse. Effects on drug use prevalence. *JAMA: The Journal of the American Medical Association* 261 (22): 3259–66.
103. Slater, M. D., K. J. Kelly, R. W. Edwards, P. J. Thurman, B. A. Plested, T. J. Keefe, F. R. Lawrence, and K. L. Henry. 2006. Combining in-school and community-based media efforts: Reducing marijuana and alcohol uptake among younger adolescents. *Health Education Research* 21 (1): 157–67.
104. Botvin, G. J., K. W. Griffin, T. Diaz, L. M. Scheier, C. Williams, and J. A. Epstein. 2000. Preventing illicit drug use in adolescents: Long-term follow-up data from a randomized control trial of a school population. *Addictive Behaviors* 25 (5): 769–74.
105. Brown, E. C., R. F. Catalano, C. B. Fleming, K. P. Haggerty, and R. D. Abbott. 2005. Adolescent substance use outcomes in the Raising Healthy Children project: A two-part latent growth curve analysis. *Journal of Consulting and Clinical Psychology* 73 (4): 699–710.
106. Johnston, L. D., P. M. O'Malley, J. G. Bachman, and J. E. Schulenberg. 2006. *Monitoring the Future: National survey results on drug use, 1975–2005. Vol. II: College students and adults ages 19–45* (NIH publication no. 06-5884). Bethesda, MD: U.S. Department of Health and Human Services, National Institutes of Health, National Institute on Drug Abuse. http://www.monitoringthefuture.org/pubs/monographs/vol2_2005.pdf.
107. Hopkins, D. P., P. A. Briss, C. J. Ricard, C. G. Husten, V. G. Carande-Kulis, J. E. Fielding, M. O. Alao, et al. 2001. Reviews of evidence regarding interventions to reduce tobacco use and exposure to environmental tobacco smoke. *American Journal of Preventive Medicine* 20 Suppl. 2: S16–S66.
108. Wagenaar, A. C., T. L. Toomey, and K. M. Lenk. 2005. Environmental influences on young adult drinking. *Alcohol Research & Health* 28 (4): 230–35.
109. Zucker, R. A. 1986. The four alcoholisms: A developmental account of the etiologic process. *Nebraska Symposium on Motivation* 34:27–83.
110. Zucker, R. A. 1995. Pathways to alcohol problems and alcoholism: A developmental account of the evidence for multiple alcoholisms and for contextual contributions to risk. In *The development of alcohol problems: Exploring the biopsychosocial matrix of risk* (NIAAA research monograph no. 26, NIH publication no. 94-3495), ed. R. A. Zucker, G. M. Boyd, and Howard J., 255–89. Rockville, MD: U.S. Department of Health and Human Services, National Institute on Alcohol Abuse and Alcoholism.
111. Zucker, R. A., H. E. Fitzgerald, and H. D. Moses. 1995. Emergence of alcohol problems and the several alcoholisms: A developmental perspective on etiologic theory and life course trajectory. In *Developmental psychopathology, vol. 2, risk, disorder, and adaptation*, ed. D. Cicchetti and D. J. Cohen, 677–711. Oxford: John Wiley & Sons.
112. Babor, T. F. 1996. The classification of alcoholics: Typology theories from the 19th century to the present. *Alcohol Health & Research World* 20 (1): 6–14.
113. Chassin, L., S. C. Pitts, and J. Prost. 2002. Binge drinking trajectories from adolescence to emerging adulthood in a high-risk sample: Predictors and substance abuse outcomes. *Journal of Consulting and Clinical Psychology* 70 (1): 67–78.
114. Colder, C. R., R. T. Campbell, E. Ruel, J. L. Richardson, and B. R. Flay. 2002. A finite mixture model of growth trajectories of adolescent alcohol use: Predictors and consequences. *Journal of Consulting and Clinical Psychology* 70 (4): 976–85.
115. Hill, K. G., H. R. White, I. J. Chung, J. D. Hawkins, and R. F. Catalano. 2000. Early adult outcomes of adolescent binge drinking: Person- and variable-centered analyses of binge drinking trajectories. *Alcoholism, Clinical and Experimental Research* 24 (6): 892–901.
116. Oesterle, S., K. G. Hill, J. D. Hawkins, J. Guo, R. F. Catalano, and R. D. Abbott. 2004. Adolescent heavy episodic drinking trajectories and health in young adulthood. *Journal of Studies on Alcohol* 65 (2): 204–12.
117. Jackson, K. M., and K. J. Sher. 2005. Similarities and differences of longitudinal phenotypes across alternate indices of alcohol involvement: A methodologic comparison of trajectory approaches. *Psychology of Addictive Behaviors* 19 (4): 339–51.
118. Schulenberg, J., K. N. Wadsworth, P. M. O'Malley, J. G. Bachman, and

- L. D. Johnston. 1996. Adolescent risk factors for binge drinking during the transition to young adulthood: Variable- and pattern-centered approaches to change. *Developmental Psychology* 32 (4): 659–74.
119. Schulenberg, J., P. M. O'Malley, J. G. Bachman, K. N. Wadsworth, and L. D. Johnston. 1996. Getting drunk and growing up: Trajectories of frequent binge drinking during the transition to young adulthood. *Journal of Studies on Alcohol* 57 (3): 289–304.
120. Tucker, J. S., M. Orlando, and P. L. Ellickson. 2003. Patterns and correlates of binge drinking trajectories from early adolescence to young adulthood. *Health Psychology* 22 (1): 79–87.
121. Windle, M., E. Y. Mun, and R. C. Windle. 2005. Adolescent-to-young adulthood heavy drinking trajectories and their prospective predictors. *Journal of Studies on Alcohol* 66 (3): 313–22.
122. Chung, T., S. A. Maisto, J. R. Cornelius, C. S. Martin, and K. M. Jackson. 2005. Joint trajectory analysis of treated adolescents' alcohol use and symptoms over 1 year. *Addictive Behaviors* 30 (9): 1690–701.
123. D'Amico, E. J., J. Metrik, D. M. McCarthy, M. Appelbaum, K. C. Frissell, and S. A. Brown. 2001. Progression into and out of binge drinking among high school students. *Psychology of Addictive Behaviors* 15 (4): 341–49.
124. Greenbaum, P. E., F. K. Del Boca, J. Darkes, C. P. Wang, and M. S. Goldman. 2005. Variation in the drinking trajectories of freshmen college students. *Journal of Consulting and Clinical Psychology* 73 (2): 229–38.
125. Muthén, B. O., and K. Shedden. 1999. Finite mixture modeling with mixture outcomes using the EM algorithm. *Biometrics* 55 (2): 463–69.
126. Casswell, S., M. Pledger, and S. Pratap. 2002. Trajectories of drinking from 18 to 26 years: Identification and prediction. *Addiction* 97 (11): 1427–37.
127. White, H. R., V. Johnson, and S. Buyske. 2000. Parental modeling and parenting behavior effects on offspring alcohol and cigarette use: A growth curve analysis. *Journal of Substance Abuse* 12 (3): 287–310.
128. Bennett, M. E., B. S. McCrady, V. Johnson, and R. J. Pandina. 1999. Problem drinking from young adulthood to adulthood: Patterns, predictors and outcomes. *Journal of Studies on Alcohol* 60 (5): 605–14.
129. Warner, L. A., H. R. White, and V. Johnson. 2007. Alcohol initiation experiences and family history of alcoholism as predictors of problem-drinking trajectories. *Journal of Studies on Alcohol and Drugs* 68 (1): 56–65.
130. Jacob, T., K. K. Bucholz, C. E. Sartor, D. N. Howell, and P. K. Wood. 2005. Drinking trajectories from adolescence to the mid-forties among alcohol dependent males. *Journal of Studies on Alcohol* 66 (6): 745–55.
131. Toumbourou, J. W., I. R. Williams, P. C. Snow, and V. M. White. 2003. Adolescent alcohol-use trajectories in the transition from high school. *Drug and Alcohol Review* 22 (2): 111–16.
132. Brown, T. L., K. Flory, D. R. Lynam, C. Leukefeld, and R. R. Clayton. 2004. Comparing the developmental trajectories of marijuana use of African American and Caucasian adolescents: Patterns, antecedents, and consequences. *Experimental and Clinical Psychopharmacology* 12 (1): 47–56.
133. Ellickson, P. L., S. C. Martino, and R. L. Collins. 2004. Marijuana use from adolescence to young adulthood: Multiple developmental trajectories and their associated outcomes. *Health Psychology* 23 (3): 299–307.
134. Kandel, D. B., and K. Chen. 2000. Types of marijuana users by longitudinal course. *Journal of Studies on Alcohol* 61 (3): 367–78.
135. Schulenberg, J. E., A. C. Merline, L. D. Johnston, P. M. O'Malley, J. G. Bachman, and V. B. Laetz. 2005. Trajectories of marijuana use during the transition to adulthood: The big picture based on national panel data. *Journal of Drug Issues* 35 (2): 255–279.
136. Windle, M., and M. Wiesner. 2004. Trajectories of marijuana use from adolescence to young adulthood: Predictors and outcomes. *Development and Psychopathology* 16 (4): 1007–27.
137. Wills, T. A., D. Vaccaro, G. McNamara, and A. E. Hirky. 1996. Escalated substance use: A longitudinal grouping analysis from early to middle adolescence. *Journal of Abnormal Psychology* 105 (2): 166–80.
138. Clark, D. B., B. L. Jones, D. S. Wood, and J. R. Cornelius. 2006. Substance use disorder trajectory classes: Diachronic integration of onset age, severity, and course. *Addictive Behaviors* 31 (6): 995–1009.

139. Labouvie, E., and H. R. White. 2002. Drug sequences, age of onset, and use trajectories as predictors of drug abuse/dependence in young adulthood. In *Stages and pathways of drug involvement: Examining the gateway hypothesis*, ed. D. B. Kandel, 19–41. New York: Cambridge Univ. Press.
140. White, H. R., R. J. Pandina, and P. H. Chen. 2002. Developmental trajectories of cigarette use from early adolescence into young adulthood. *Drug and Alcohol Dependence* 65 (2): 167–78.
141. Wills, T. A., J. A. Resko, M. G. Ainette, and D. Mendoza. 2004. Smoking onset in adolescence: A person-centered analysis with time-varying predictors. *Health Psychology* 23 (2): 158–67.
142. Brook, J. S., E. B. Balka, Y. Ning, and D. W. Brook. 2007. Trajectories of cigarette smoking among African Americans and Puerto Ricans from adolescence to young adulthood: Associations with dependence on alcohol and illegal drugs. *American Journal of Addictions* 16 (3): 195–201.
143. Juon, H. S., M. E. Ensminger, and K. D. Sydnor. 2002. A longitudinal study of developmental trajectories to young adult cigarette smoking. *Drug and Alcohol Dependence* 66 (3): 303–14.
144. Audrain-McGovern, J., D. Rodriguez, K. P. Tercyak, J. Cuevas, K. Rodgers, and F. Patterson. 2004. Identifying and characterizing adolescent smoking trajectories. *Cancer Epidemiology, Biomarkers & Prevention* 13 (12): 2023–34.
145. Orlando, M., J. S. Tucker, P. L. Ellickson, and D. J. Klein. 2004. Developmental trajectories of cigarette smoking and their correlates from early adolescence to young adulthood. *Journal of Consulting and Clinical Psychology* 72 (3): 400–410.
146. Tucker, J. S., P. L. Ellickson, M. Orlando, and D. J. Klein. 2006. Cigarette smoking from adolescence to young adulthood: Women's developmental trajectories and associates outcomes. *Women's Health Issues* 16 (1): 30–7.
147. Soldz, S., and X. Cui. 2002. Pathways through adolescent smoking: A 7-year longitudinal grouping analysis. *Health Psychology* 21 (5): 495–504.
148. Stanton, W. R., B. R. Flay, C. R. Colder, and P. Mehta. 2004. Identifying and predicting adolescent smokers' developmental trajectories. *Nicotine & Tobacco Research* 6 (5): 843–52.
149. Wiesner, M., K. Weichold, and R. K. Silbereisen. 2007. Trajectories of alcohol use among adolescent boys and girls: Identification, validation, and sociodemographic characteristics. *Psychology of Addictive Behaviors* 21 (1): 62–75.
150. Guo, J., I. J. Chung, K. G. Hill, J. D. Hawkins, R. F. Catalano, and R. D. Abbott. 2002. Developmental relationships between adolescent substance use and risky sexual behavior in young adulthood. *Journal of Adolescent Health* 31 (4): 354–62.
151. Chassin, L., D. B. Fora, and K. M. King. 2004. Trajectories of alcohol and drug use and dependence from adolescence to adulthood: The effects of familial alcoholism and personality. *Journal of Abnormal Psychology* 113 (4): 483–98.
152. Chung, T., S. A. Maisto, J. R. Cornelius, and C. S. Martin. 2004. Adolescents' alcohol and drug use trajectories in the year following treatment. *Journal of Studies on Alcohol* 65 (1): 105–14.
153. Flory, K., D. Lynam, R. Milich, C. Leukefeld, and R. Clayton. 2004. Early adolescent through young adult alcohol and marijuana use trajectories: Early predictors, young adult outcomes, and predictive utility. *Development and Psychopathology* 16 (1): 193–213.
154. Jackson, K. M., K. J. Sher, and J. E. Schulenberg. 2005. Conjoint developmental trajectories of young adult alcohol and tobacco use. *Journal of Abnormal Psychology* 114 (4): 612–26.
155. Orlando, M., J. S. Tucker, P. L. Ellickson, and D. J. Klein. 2005. Concurrent use of alcohol and cigarettes from adolescence to young adulthood: An examination of developmental trajectories and outcomes. *Substance Use and Misuse* 40 (8): 1051–69.
156. Tucker, J. S., P. L. Ellickson, M. Orlando, S. C. Martino, and D. J. Klein. 2005. Substance use trajectories from early adolescence to emerging adulthood: A comparison of smoking, binge drinking, and marijuana use. *Journal of Drug Issues* 35 (2): 307–32.
157. Jackson, K. M., K. J. Sher, and J. E. Schulenberg. 2008. Conjoint developmental trajectories of young adult substance use. *Alcoholism, Clinical and Experimental Research* 32 (5): 723–37.
158. Audrain-McGovern, J., D. Rodriguez, J. Cuevas, K. Rodgers, and K. P. Tercyak.

- Forthcoming. The co-occurrence of smoking and marijuana use from adolescence to young adulthood.
159. Muthén, B. O. 2001. Second-generation structural equation modeling with a combination of categorical and continuous latent variables: New opportunities for latent class/latent growth modeling. In *New methods for the analysis of change*, ed. L. M. Collins and A. Sayer, 291–322. Washington, DC: American Psychological Association.
 160. Pagan, J. L., R. J. Rose, R. J. Viken, L. Pulkkinen, J. Kaprio, and D. M. Dick. 2006. Genetic and environmental influences on stages of alcohol use across adolescence and into young adulthood. *Behavior Genetics* 36 (4): 483–97.
 161. Dick, D. M., R. J. Rose, L. Pulkkinen, and J. Kaprio. 2001. Measuring puberty and understanding its impact: A longitudinal study of adolescent twins. *Journal of Youth and Adolescence* 30 (4): 385–400.
 162. Rose, R. J., and D. M. Dick. 2004–2005. Gene-environment interplay in adolescent drinking behavior. *Alcohol Research & Health* 28 (4): 222–29.
 163. Mustanski, B. S., R. J. Viken, J. Kaprio, L. Pulkkinen, and R. J. Rose. 2004. Genetic and environmental influences on pubertal development: Longitudinal data from Finnish twins at ages 11 and 14. *Developmental Psychology* 40 (6): 1188–98.
 164. Kendler, K. S., M. McGuire, A. M. Gruenberg, A. O'Hare, M. Spellman, and D. Walsh. 1993. The Roscommon Family Study. I: Methods, diagnosis of probands, and risk of schizophrenia in relatives. *Archives of General Psychiatry* 50 (7): 527–40.
 165. Kendler, K. S. 2001. Twin studies of psychiatric illness: An update. *Archives of General Psychiatry* 58 (11): 1005–14.
 166. Rose, R. J., J. Kaprio, T. Winter, M. Koskenvuo, and R. J. Viken. 1999. Familial and socioregional environmental effects on abstinence from alcohol at age sixteen. *Journal of Studies on Alcohol Supplement* 13:63–74.
 167. Viken, R. J., J. Kaprio, and R. J. Rose. 2007. Personality at ages 16 and 17 and drinking problems at ages 18 and 25: Genetic analyses of data from Finn Twin16-25. *Twin Research and Human Genetics* 10 (1): 25–32.
 168. Kaprio, J., L. Pulkkinen, and R. J. Rose. 2002. Genetic and environmental factors in health-related behaviors: studies on Finnish twins and twin families. *Twin Research* 5 (5): 366–71.
 169. Muthén, B., and L. K. Muthén. 2000. Integrating person-centered and variable-centered analyses: Growth mixture modeling with latent trajectory classes. *Alcoholism, Clinical and Experimental Research* 24 (6): 882–91.
 170. Nagin, D. S. 1999. Analyzing developmental trajectories: A semiparametric, group-based approach. *Psychological Methods* 4 (2): 139–57.
 171. Dolan, C. V., V. D. Schmittmann, G. H. Lubke, and M. C. Neale. 2005. Regime switching in the latent growth curve mixture model. *Structural Equation Modeling* 12 (1): 94–119.
 172. Lanza, S. T., B. P. Flaherty, and L. M. Collins. 2003. Latent class and latent transition analysis. In *Handbook of psychology: Research methods in psychology, vol. 2*, ed. J. A. Schinka and W. F. Velicer. Hoboken, NJ: John Wiley & Sons.
 173. Muthén, L. K., and B. O. Muthén. 1998–2007. *Mplus User's Guide*. 4th ed. Los Angeles: Muthén & Muthén. www.StatModel.com.
 174. Muthén, B. O. 2004. Latent variable analysis: Growth mixture modeling and related techniques for longitudinal data. In *Handbook of quantitative methodology for the social sciences*, ed. D. Kaplan, 345–68. Newbury Park, CA: Sage Publications.
 175. Lo, Y., N. R. Mendell, and D. B. Rubin. 2001. Testing the number of components in a normal mixture. *Biometrika* 88 (3): 767–78.
 176. Muthén, B., C. H. Brown, K. Masyn, B. Jo, S. T. Khoo, C. C. Yang, C. P. Wang, S. G. Kellam, J. B. Carlin, and J. Liao. 2002. General growth mixture modeling for randomized preventive interventions. *Biostatistics* 3 (4): 459–75.
 177. Schwarz, G. 1978. Estimating the dimension of a model. *Annals of Statistics* 6 (2): 461–64.
 178. Rao, J. N. K., and A. J. Scott. 1984. On chi-squared tests for multiway contingency tables with proportions estimated from survey data. *Annals of Statistics* 12 (1): 46–60.
 179. von Eye, A. 2002. *Configural frequency analysis: Methods, models, and applications*. Mahwah, NJ: Erlbaum Associates.
 180. Shiffman, S. 1989. Tobacco “chippers”—individual differences in tobacco dependence. *Psychopharmacology (Berl)* 97 (4): 539–47.

181. Hibell, B., B. Andersson, T. Bjarnason, S. Ahlstrom, O. Balakierova, A. Kokkevi, and M. Morgan. 2004. *The ESPAD Report, 2003: Alcohol and other drug use among students in 35 European countries*. Stockholm, Sweden: Council for Information on Alcohol and Other Drugs/Pompidou Group at the Council of Europe. http://www.espad.org/documents/espac/ESPAD_reports/The_2003_ESPAD_report.pdf.
182. Simpura, J., and T. Karlsson, comp. 2001. *Trends in drinking patterns in fifteen European countries, 1950 to 2000: A collection of country reports*. Helsinki, Finland: STAKES. <http://www.stakes.fi/verkkojulkaisut/muut/ECAS.pdf>.
183. Rose, R. J., J. Kaprio, C. J. Williams, R. Viken, and K. Obremski. 1990. Social contact and sibling similarity: Facts, issues, and red herrings. *Behavior Genetics* 20 (6): 763–78.
184. Rose, R. J. 2002. How do adolescents select their friends? A behavior-genetic perspective. In *Paths to successful development: Personality in the life course*, ed. L. Pulkkinen and A. Caspi, 106–125. New York: Cambridge Univ. Press.
185. Eaves, L., J. Silberg, J. K. Jewitt, J. Meyer, M. Rutter, E. Simonoff, M. Neale, and A. Pickles. 1993. Genes, personality, and psychopathology: A latent class analysis of liability to symptoms of attention-deficit hyperactivity disorder in twins. In *Nature, nurture and psychology*, ed. R. Plomin and G. E. McClearn, 285–303. Washington, DC: American Psychological Association.
186. Eaves, L. J., J. L. Silberg, J. K. Hewitt, M. Rutter, J. M. Meyer, M. C. Neale, and A. Pickles. 1993. Analyzing twin resemblance in multisymptom data: Genetic applications of a latent class model for symptoms of conduct disorder in juvenile boys. *Behavior Genetics* 23 (1): 5–19.
187. Nagin, D. S., and R. E. Tremblay. 2005. What has been learned from group-based trajectory modeling? Examples from physical aggression and other problem behaviors. *Annals of the American Academy of Political and Social Science* 602: 82–117.
188. Karp, I., J. O’Loughlin, G. Paradis, J. Hanley, and J. DiFranza. 2005. Smoking trajectories of adolescent novice smokers in a longitudinal study of tobacco use. *Annals of Epidemiology* 15 (6): 445–52.
189. Boms, U., K. Silventoinen, P. A. Madden, A. C. Heath, and J. Kaprio. 2006. Genetic architecture of smoking behavior: A study of Finnish adult twins. *Twin Research and Human Genetics* 9 (1): 64–72.
190. Heath, A. C., N. G. Martin, M. T. Lynskey, A. A. Todorov, and P. A. Madden. 2002. Estimating two-stage models for genetic influences on alcohol, tobacco or drug use initiation and dependence vulnerability in twin and family data. *Twin Research* 5 (2): 113–24.
191. Sher, K. J. 2007. Road to alcohol dependence: A commentary on Sartor et al. (2007). *Addiction* 102 (2): 185–7, 189–90.
192. Rosenthal, D., ed. 1963. *The Genain quadruplets: A case study and theoretical analysis of heredity and environment in schizophrenia*. New York: Basic Books.
193. Pitkanen, T., A. L. Lyyra, and L. Pulkkinen. 2005. Age of onset of drinking and the use of alcohol in adulthood: A follow-up study from age 8–42 for females and males. *Addiction* 100 (5): 652–61.
194. Viken, R. J., J. Kaprio, M. Koskenvuo, and R. J. Rose. 1999. Longitudinal analyses of the determinants of drinking and of drinking to intoxication in adolescent twins. *Behavior Genetics* 29 (6): 455–61.

Endophenotypes

Endophenotypes serve as intermediary measures that have the potential to provide an indirect link between genes, smoking behaviors, and nicotine dependence. Endophenotypes may help serve as a basis for future studies to identify genetic liability markers for nicotine dependence. Research to establish the validity, heritability, and reliability of such measures is a promising area for further study.

The first chapter of this part examines the evidence base for several candidate endophenotypes for nicotine dependence risk at or before initial nicotine exposure, including approach, avoidance, and control-related variables, as well as measures of initial response to nicotine exposure. A subsequent chapter explores endophenotypes for nicotine dependence in chronic smokers; aspects include motivational, sensory, and cognitive measures as well as craving and impulse control.

8

Endophenotypes for Nicotine-Dependence Risk at or before Initial Nicotine Exposure

Janet Audrain-McGovern, Joel T. Nigg, and Kenneth A. Perkins

Characteristics present before or at the time of nicotine exposure may play a key role in identifying individuals at genetic risk for nicotine dependence. This chapter examines the evidence base for several candidate endophenotypes for nicotine-dependence risk at or before smoking and nicotine exposure, including the following:

- *Approach-related smoking risk variables based on psychological traits such as impulsivity, novelty seeking, and extraversion, using laboratory measures for aspects of reinforcement and reward*
- *Avoidance-related smoking risk variables based on psychological factors such as neuroticism, stress, depression, and anxiety, using laboratory measures including personality trait measures, peripheral nervous system (PNS) effects, and neuroendocrine response to cortisol*
- *Control-related smoking risk based on psychological variables such as attention deficit hyperactivity disorder (ADHD), conduct disorders, aggression, and hostility, using laboratory measures including response inhibition, event-related potential (ERP) P300 amplitude, attention, and alertness*
- *Measures of initial response to nicotine exposure, including reinforcement and reward measures of initial sensitivity to nicotine, as well as initial sensitivity to affective and mood responses to nicotine*

Although available evidence shows a link between many of these variables and smoking behavior, further research is needed to establish possible nicotine-dependence endophenotypes from a standpoint of predictive validity, biological plausibility, reliability, and heritability.

The analyses described herein were supported in part by National Institute of Health grants AA12217, CA096836, CA109250, DA05807, DA19478, and DA021032.

Introduction

This chapter examines potential endophenotypes for risk for (1) initiating and progressing in smoking and (2) responding to the initial nicotine exposure. First, it briefly surveys major within-person risk factors for smoking initiation and progression. It then assesses these from the perspective of potential endophenotypes via a conceptual model of neural circuits that may be relevant to smoking initiation and progression, particularly with regard to a general risk pathway. A general risk pathway indicates a vulnerability that may be shared between nicotine and other drugs; hence, some overlap can be expected in the domains of interest here with those being studied for other drugs such as alcohol. This approach is well justified in view of behavioral genetic evidence of shared genetic liability to the misuse of nicotine, alcohol, and other drugs,¹⁻³ although the degree of shared genetic factors may vary with age.⁴ However, some endophenotypes may be relatively more general and linked to initial attraction to many types of substances (e.g., reward dependence), and others may have greater specificity to trying nicotine (e.g., attentional dysfunction).

The second part of this chapter considers processes occurring in the early stages of nicotine exposure that may increase the likelihood of further exposure to nicotine and subsequent nicotine dependence; it looks at potential endophenotypes at that inflection point, shifting to a pharmacological response model and a more drug-specific pathway. A drug-specific model is justified at this inflection point by evidence that pharmacological response may influence selection of drug use over time. The final section of the chapter discusses the state of the research and offers recommendations for future investigation.

Endophenotypes

An explanatory gap between candidate genes and the presence of symptoms of nicotine dependence necessitates new approaches to identifying genetic liability markers. Smoking risk is an area of study overlapping with numerous complex disorders and traits with which it is correlated. Therefore, a useful strategy may be to identify valid and reliable intervening constructs to link candidate genes and nicotine dependence, as has been suggested for behavioral traits and disorders generally.⁵⁻⁸ The field holds relative consensus that genetic and environmental risk for substance use includes a general risk factor (not specific to one drug) and drug-specific factors.⁹ Intervening constructs need to be identified both at the general level (where they will be shared among several drugs) and at the nicotine-specific level.

These intervening constructs, referred to as *endophenotypes*, can be neurophysiological, biochemical, endocrinological, neuroanatomical, cognitive, behavioral, or neuropsychological, as long as the endophenotype ultimately enhances the genetic signal for the disorder's causal processes.¹⁰ Most behavioral measures, although providing useful clues, are usually considered less parsimonious than most cognitive or biological endophenotypes given the (presumed) extra steps needed to link them to genes or the proteins for which they code. Further, because genes influencing behavioral and addictive disorders are presumed to operate in the brain, and to be detectable by probes of brain activity (such as cognition), cognitive and physiological measures that can be validated in relation to neural systems are attractive candidates.

Consequently, a neural networks perspective is useful to analyze potential endophenotypes. Such a model can be

adopted to examine behavioral, cognitive, and physiological endophenotypes that may be related to smoking initiation discussed in the first half of this chapter. Nicotine is not a drug of universal exposure. Thus, factors that differentially influence initiation of use, including genetics, are critical. At the same time, once smoking has been initiated, the pharmacological response to the nicotine presumably becomes a key factor in an adolescent's subsequent smoking behavior and progression to nicotine dependence. Therefore, the second part of this chapter moves to a lower (more molecular) level of analysis and considers a pharmacological perspective on smoking progression in conjunction with trait measures.

Assuming an endophenotype can be validated, it can provide a potentially powerful tool for identifying individuals at genetic risk of initial nicotine use and of going on to nicotine dependence (becoming nicotine dependent and staying nicotine dependent), and it can also clarify phenotypic heterogeneity.¹¹ That is, complex traits such as smoking and nicotine dependence are probably due to numerous genes in several pathways, interacting with each other and the environment. Endophenotypes are intended to represent more defined and quantifiable measures that are thought to involve fewer genes and fewer interacting pathways, which ultimately result in the activation of a narrower set of neuronal circuits.¹¹ Because endophenotypes, when valid, are more proximal biologically to the putative genetic influences, they may be more sensitive measures for genetic studies of nicotine dependence.¹² No endophenotypes have been validated for smoking risk; this chapter examines candidate markers that may hold promise as potential endophenotypes.

Several criteria have been advanced to evaluate the validity of a putative

endophenotype.^{7,10,13} The criteria used to evaluate a potential endophenotype for nicotine dependence include (1) predictive validity; that is, it is related to a smoking phenotype of interest (initiation or progression); (2) biological plausibility; that is, it can be linked to specific neural pathways or actions, which can relate directly to candidate genes; (3) reliability; and (4) heritability. Bivariate heritability is not evaluated in this chapter because data are lacking on its relation to smoking initiation and progression. For more discussion of the criteria for an endophenotype, see Waldman and colleagues.^{13,14}

This chapter derives its concept of "endophenotype," which has been criticized as underspecified, from other studies. For example, Szatmari and colleagues¹⁵ suggest that responses that are often considered as potential endophenotypes can be conceptualized as one of three "subtypes," only two of which would be true endophenotypes: (1) component phenotype, (2) intermediate phenotype, and (3) covariate.¹⁵ Component phenotypes capture only one aspect of a multidimensional disorder of interest; they may or may not be a necessary part of the disorder, but they are not a sufficient determinant (i.e., alone they do not fully capture the disorder). Building on the logic of these authors, component phenotypes can be viewed as a portion of the disorder phenotype but not part of the causal chain to it. Intermediate phenotypes, by contrast, refer to a mechanism believed to be part of the causal chain to the disorder; this is the original meaning of "endophenotype" provided by Gottesman.¹⁰ An intermediate phenotype is expected to reflect a predisposition for the disorder in unaffected family members as well as in those already affected. The third subtype, covariates, are really not endophenotypes at all; they are factors related to the disorder of interest but not components of it and certainly not

causal. Part of the goal of research in this area is to determine into which of these subtype categories a candidate measure actually falls (usually it is unknown until investigated). Of most interest in this chapter are markers suspected to be the second type (intermediate phenotypes), although in fact some of these may turn out to be covariates. The reason for emphasizing intermediate phenotypes is that this chapter is focused on those at risk for nicotine dependence but not yet “affected” with the disorder. The next chapter, on putative endophenotypes for dependence after chronic exposure (i.e., in those already “affected”), focuses on component phenotypes.

Rationale for Investigating Nicotine-Dependence Risk Endophenotypes

Like most complex traits, smoking behavior is the result of genetic and environmental influences.¹⁶ Heritability studies of adolescent twins estimate that at least 33% of the variance in smoking initiation (ever smoking), more than 80% of the variance in smoking rate, and 44% of the variance in nicotine dependence may be attributable to genetic factors.^{1,17-19} Genetic factors may be more important in discriminating those adolescents who become nicotine dependent from those who simply initiate and do not progress beyond limited experimentation.^{18,20}

Evidence for smoking heritability has encouraged a growing number of studies examining the role of candidate genes involved in nicotine metabolism and drug reward in adolescent smoking and nicotine dependence. Most of the candidate gene studies have focused on genes directly related to nicotine’s biological action. For example, such studies indicate that genetic variation in enzymes responsible for nicotine metabolism (i.e., *CYP2A6*)

influences the likelihood of becoming nicotine dependent and the rate of progression in nicotine dependence among adolescents.^{21,22} However, these two studies differ in their findings, and it is not clear whether faster or slower nicotine metabolism confers risk for nicotine dependence. However, with regard to the nonspecific component of the risk path, studies have also linked polymorphisms in genes in the dopamine reward pathway to an increased likelihood of smoking progression,²³ greater smoking among male adolescents,²⁴ and a reduced likelihood of an adolescent being nicotine dependent.^{25,26}

Two genome-wide association studies have pointed to several novel genes that discriminated among adults who smoke regularly but did not become nicotine dependent and those who smoke regularly and became nicotine dependent.^{27,28} There appears to be some overlap between polymorphisms that distinguish individuals who became dependent on other substances from those who did not.²⁸ Likewise, a later candidate gene study found that the nicotinic receptor subunit gene *CHRNA5* distinguished between adults who smoke regularly but did not become nicotine dependent and those who smoke regularly and became nicotine dependent.²⁹ These findings have been replicated in five subsequent studies of adults.³⁰⁻³⁴ Studies also provide support for the importance of other nicotinic subunits identified in genome-wide association studies (e.g., *CHRNB3*).^{29,31,32} No studies were found that have prospectively evaluated the role of nicotine receptors in the emergence of nicotine dependence in adolescents.

Furthermore, a range of psychological and psychosocial moderators likely interplay with genetic vulnerability in regard to drug use, including smoking. For example, Dick and colleagues³⁵ reported that genetic effects on adolescent smoking were moderated by parenting behavior. The specific nature of

these interactive gene effects remains to be mapped with regard to the general and specific risk streams. However, initial clues are tantalizing. One study found that the dopamine receptor D2 (*DRD2*) gene interacts with other vulnerability factors, such as depression, to potentiate adolescent smoking progression.²³ In contrast, protective factors, such as team sport participation, appear to interact with genes in the dopamine reward pathway (i.e., *DRD2* and dopamine transporter *SLC6A3*) to prevent adolescent smoking progression.³⁶

Gene-by-gene interactions can also be considered. For example, genetic variation in the serotonin pathway (i.e., the short allele of the serotonin transporter *5-HTTLPR*) has been linked to increased smoking among adolescents.³⁷ However, a higher level of smoking was seen among girls who were homozygous for the long allele of *5-HTTLPR* and who lacked the dopamine receptor *DRD4*7-repeat* allele.³⁸ These two findings may reflect the moderating effects of one gene on another or possibly methodological differences between the studies.

Despite the recognition of these general outlines of the problem and these interesting initial genetic findings, it has proven difficult to identify candidate genes with replicable associations with adolescent smoking phenotypes; that is, several of the studies above disagree on the genotype that confers risk. As discussed in chapter 5, disparate findings may be partially explained by differences in study methodology and smoking phenotypes under investigation. At the same time, the methodological problems in identifying and measuring liability in those who have not yet initiated use are nontrivial.^{39,40} Endophenotypes in the context of prospective designs are a crucial tool in this regard.

Similar to most work in the field, the model discussed here assumes at least three inflection points leading to eventual

dependence, of which two (initiation and initial response) are covered in this chapter and one (persistence) is covered in chapter 9. It is assumed that genetic influences on these three inflection points are at least in part distinct. For one thing, it is likely that risks for initiation may fall partially into the general substance-use pathway and partially into a specific pathway involving attraction to nicotine, whereas a greater degree of drug-specific factors may be involved in initial response. However, initiation is an obvious prerequisite for progression and then dependence to emerge. In turn, numerous factors place an individual at risk for smoking initiation, progression to regular smoking, and nicotine dependence.⁴¹ Smoking obviously occurs in a psychosocial context in which nicotine availability is a necessary but not sufficient condition. Those psychosocial contexts are bypassed here so as to focus on avenues to understanding genetic predisposition to risk in the individual.

Candidate Neural Systems as Guides to Smoking and Nicotine-Dependence Risk Endophenotypes

In the temperament-based model, major circuits include the following: (1) A dopaminergic, appetitive, frontal-limbic circuit is related to approach behaviors, surgency, extraversion, novelty seeking, and impulsivity.⁴² It is well recognized that behaviors associated with these traits are related to drug-use risk generally,⁴³ so they are also relevant to smoking initiation risk. (2) A neural circuit anchored in amygdala and associated stress response circuitry is related to neuroticism, anxiety, stress response, fearfulness, and perhaps depression. These may include drug-specific as well as general risk characteristics inasmuch as nicotine may serve to relieve negative affect in a unique manner. (3) A frontal-thalamic-striatal circuit,

including dorsolateral prefrontal cortex and orbital prefrontal cortex, is related to effortful control, deliberative behavior, working memory, and neuropsychological executive functions. It is related to ADHD and inattention, and indirectly, to control of emotion. Additional neural and personality traits can be invoked to address hostility, as noted later.

Although this does not exhaust the neural mechanisms to be considered (in particular, those that are drug specific such as cholinergic systems in relation to nicotine use), they provide a starting point for organizing this list of behavioral and psychological markers that are likely to be part of a general risk pathway. They also provide a basis for bridging to more direct behavioral and cognitive probes of these same neural systems. What follows, therefore, outlines a multilevel-analysis perspective on key neural systems related to the behavioral markers above. In each case, an attempt is made to carry this out to the point of describing operational measures—that is, low-level experimental measures that can serve as endophenotypes for future studies.

Figure 8.1 outlines the basic conceptual framework as hypothetically linked to both behavioral and biological (i.e., central nervous system [CNS] and PNS) levels of analysis; potential linkages to other laboratory measures are noted here. This framework, presented in more detail in Nigg,⁴² draws on a handful of key formulations^{44–50} and is similar to a detailed presentation by Zuckerman.⁵¹ This perspective assumes a small set of reactive response systems and a regulatory/control system that comes under increasing volitional control with development. These systems underlie temperament and personality and are directly relevant to both psychopathology and self-control in children and adolescents. These systems are relevant to consideration of the general risk pathway;

the degree to which they carry drug-specific risks will remain speculative here.

The behavioral traits are assumed to reflect a set of partially discrete neurobiological systems anchored at the level of the CNS in frontal-limbic neural networks and stress response systems and, at the PNS level, with reactivity of sympathetic and parasympathetic systems. Whereas the distinction between temperament and personality is debated in the field, that issue is bypassed here to focus on the conceptual behavioral and neural systems. The behavioral traits are known to be relatively stable across similar incentive conditions and to reflect reliable individual differences across development,^{52,53} although these effects are modest in size over long periods of time and include periods of substantial change in personality.⁵⁴ Yet, importantly, early trait scores, mediated by later trait scores, can predict onset of substance use.^{55,56}

The hierarchical framework begins with reactivity of two basic incentive systems—approach and avoidance⁴²—which are related to reactivity of autonomic as well as neural systems.⁴⁴ These are bottom-up systems. The framework then proceeds to top-down control, the ability to effortfully regulate responses as well as emotion and attention. Finally, all of these mechanisms influence attention and are moderated by arousal level.

Note again that the domains portrayed in figure 8.1 are of general importance to behavioral regulation; they are implicated in key psychopathologies (especially ADHD, conduct disorder, and mood disorders) and substance-use disorders as well as in risk factors for nicotine dependence. In the second half of this chapter, the focus is shifted to nicotine-specific processes. Therefore, the discussion begins here by outlining a conceptual neural model that will allow an organization of potential

Figure 8.1 Hierarchical Structural Model and Hypothesized Physiological Concomitants

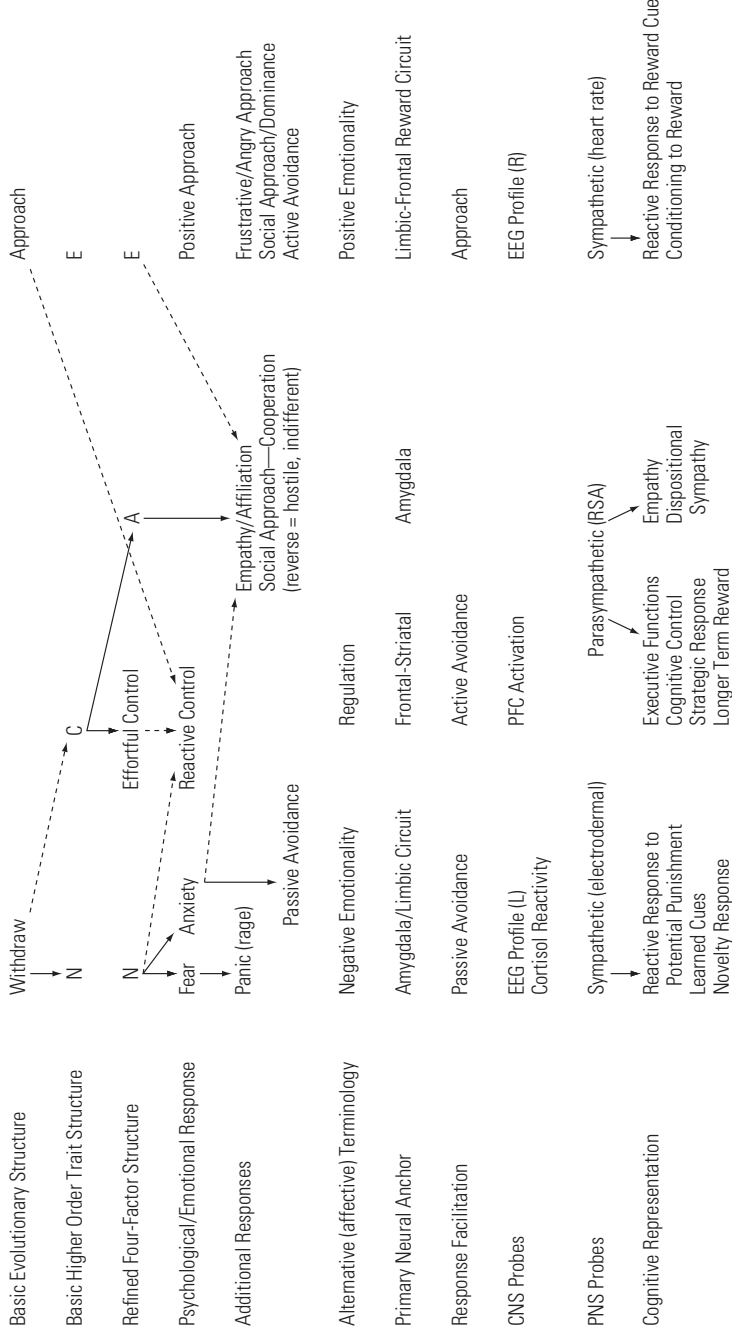

Note: Adapted from Nigg, J. T. 2006. Temperament and developmental psychopathology. *Journal of Child Psychology and Psychiatry* 47 (3–4): 395–422; adapted from Beauchaine, T. P. 2001. Vagal tone, development, and Gray's motivational theory: Toward an integrated model of autonomic nervous system functioning in psychopathology. *Development and Psychopathology* 13 (2): 183–214; Calkins, S. D., and N. A. Fox. 2002. Self-regulatory processes in early personality development: A multilevel approach to the study of childhood social withdrawal and aggression. *Development and Psychopathology* 14 (3): 477–98; Markon, K. E., R. F. Krueger, and D. Watson. 2005. Delineating the structure of normal and abnormal personality: An integrative hierarchical approach. *Journal of Personality and Social Psychology* 88 (1): 139–57; Shiner, R., and A. Caspi. 2003. Personality differences in childhood and adolescence: Measurement, development, and consequences. *Journal of Child Psychology and Psychiatry* 44 (1): 2–32. Openness, associated with E, is omitted for simplicity. N = neuroticism, negative affectivity, withdrawal responding; E = extraversion, approach responding; C = constraint; A = affiliation/agreeableness; CNS = central nervous system; EEG = electroencephalographic; L = left; PFC = prefrontal cortex; R = right; PNS = peripheral nervous system; RSA = respiratory sinus arrhythmia.

endophenotypes, particularly those that may be nonspecific before exposure, and an analysis of previously studied risk factors at lower neurobiological levels, thus suggesting additional endophenotypes for consideration. Figure 8.2 provides an illustration of the potential links between genes, neurotransmitter activity and receptor function, endophenotypes for nicotine-dependence risk at or before initial nicotine exposure, and subsequent nicotine dependence.

Smoking Initiation and Progression Risk: Examination of Key Candidate Psychological Domains

A large literature base has linked adolescent smoking initiation and progression to several pre-occurring social, psychological, and behavioral factors. The smoking risk variables that are reviewed below are not exhaustive but reflect those most likely to be linked to potential genetic endophenotypes. For example, although peer smoking has consistently been shown to influence the likelihood of adolescent smoking initiation and progression,⁵⁷⁻⁵⁹ the underpinnings of peer behavior influence may more likely be environmental rather than genetic. Of course, parental smoking is a significant predictor of smoking initiation and progression.^{58,60-63} Clearly, the effects of parental smoking on adolescent smoking may be genetic and environmental, or may reflect gene-environment correlations, in that an adolescent both (1) inherits genotypes conferring smoking risk and (2) is in an environment in which smoking is modeled. Thus, no attempt is made to address all vulnerability to smoking and subsequent nicotine dependence; rather,

the focus is on potential markers of the genetic component of vulnerability.

In reading the sections on smoking risk variables, the reader should keep in mind that these factors themselves are complex phenotypes. They are framed here through the lens of a neurobiological temperament model that allows a multilevel analysis of these surface-level endophenotypes, perhaps bringing them closer to gene action. Each section that follows, therefore, begins at a “high,” or abstract, level of analysis with behavioral traits. It then proceeds to what is known about lower level, more molecular (i.e., either construct pure or single factor) laboratory measures. The laboratory measures can be viewed here as being genetically simpler and more promising as endophenotypes than are the trait measures. However, whether this is always true about these measures remains an empirical question in nearly every case. The purpose here is to show the linkages across these levels of analysis to assist the field in conceptualizing endophenotypes as target measures. This is illustrated by analyzing the most-well-studied molecular measures and by suggesting logical, additional measures of the same systems that are essentially unstudied in relation to smoking vulnerability.

Approach-Related Risk Variables: High-Level Psychological Traits

The neural incentive system, labeled here as “approach,” is associated with psychological processes, such as willingness to approach possible incentive or reward/reinforcement, and with speed of reinforcement learning. It is related also to the personality traits of impulsivity and novelty seeking as well as extraversion^{64,65}—all of which are among the surface traits that have been linked to smoking risk. Extraversion, the most abstract of these traits, includes

Figure 8.2 Example of How Potential Endophenotypes Can Link Genes to Nicotine-Dependence Risk at or before Initial Nicotine Exposure

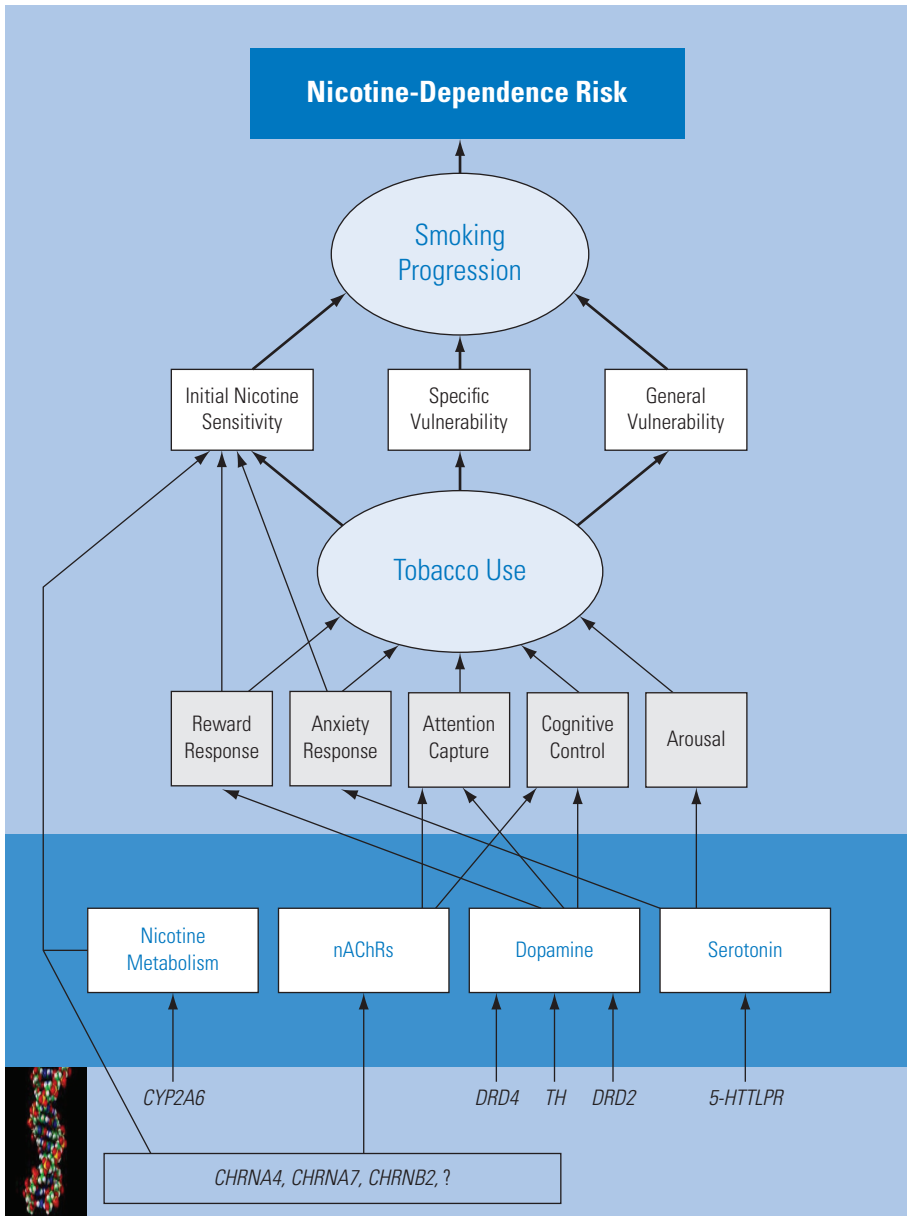

Note. Endophenotype areas are presented in gray squares. Specific and general vulnerability paths are recognized. Selected examples of genes (bottom row) that contribute to neurotransmitter activity and receptor function (dark blue bar) related to these endophenotype areas can be identified. This figure is illustrative only and does not reflect a consensus on the factors responsible for neurotransmitter function or for the endophenotype areas. nAChRs = nicotinic acetylcholine receptors.

several lower order constituent traits such as positive emotionality, sociability, and activity level.⁴⁹ An extensive literature documents both the reliability of individual differences in children and adolescents on these dimensions and the fact that they cohere in a superordinate factor at least by early childhood (for reviews see Calkins and Fox;⁴⁵ Putnam and colleagues;⁶⁶ Rothbart and Bates;⁴⁸ and Shiner and Caspi⁴⁹), although some developmental change may emerge with regard to the lower order traits contributing to extraversion.⁵² Disagreement remains as to the neurobiological core element of this supertrait (see Depue and Collins⁶⁷ and accompanying commentaries). However, to facilitate neurobiological and cross-species analysis of smoking risk endophenotypes, extraversion is conceptualized here as related at the level of the CNS to the appetitive, dopaminergic systems, including the nucleus accumbens and ascending frontal-limbic dopaminergic networks.^{42,64,65} At the level of the PNS, extraversion is related to sympathetic activation, with one index being heart rate acceleration following the application of effort or the appearance of incentive.^{44,68} These CNS and PNS measures then become operational candidate endophenotypes that may be closer to gene action than are surface traits such as extraversion or novelty seeking.

Impulsivity

Impulsivity is used here to mean the tendency to act without adequate preparation or thought or to act hastily in contexts that call for a slow, careful response. One common way to operationalize impulsivity is via delay discounting. “Delay discounting,” a concept found in behavior economic theory, among other literatures, describes the process in which the value of a reward is discounted as a function of delay to its delivery.⁶⁹ Like other impulsive subjects, smokers tend to discount the value of future

reinforcers more than do nonsmokers.^{70,71} Thus, impulsivity, seen as a tendency to choose reward immediacy over reward magnitude,^{70,72} is a risk factor for smoking. Delay discounting rates have been shown to correlate with impulsivity, age at first substance use, and substance use.^{72–75} Delay discounting affects the type of reinforcers that adolescents choose over time⁷⁶ and appears to involve two separate neural systems.⁷⁷ However, a key component of neural support for delay weighting involves ascending midbrain dopamine circuits. Thus, genes and measures tapping these circuits are likely to be of interest.

Novelty-Seeking Personality

Novelty seeking is characterized by a tendency to seek out new and exciting stimuli; engage in sensation-seeking, impulsive, and risk-taking behavior; and to be sensitive to reward.^{78–80} This personality dimension predicts tobacco use during adolescence^{81,82} and early onset of smoking in adolescent boys.⁸³ Indeed, a study of longitudinal smoking patterns from ages 14 to 18 years found that adolescents high in novelty seeking were about 15%–20% more likely to be members of a trajectory involving regular smoking than of a never-smoking trajectory.⁸⁴

Adolescents high in novelty seeking also tend to be more receptive to tobacco advertising, which, in turn, has been linked to smoking progression.^{85,86} The heightened receptivity to tobacco advertising among youth high in novelty seeking may be attributable to their greater need for stimulation and rewarding experiences. Structural equation models suggest that novelty seeking indirectly affects substance use through other variables that are more proximal to use.^{82,87} This might especially be the case for cigarette smoking.⁸⁸ Evidence also suggests that exposure to novelty activates the same neural structures that mediate the rewarding effects of substances

of abuse.⁸⁹ Thus, like impulsivity, individual variability in novelty-seeking and drug-seeking behaviors may be related to individual differences in the dopamine reward pathway.^{90,91}

Extraversion

Extraversion is characterized as an outgoing, sociable, energetic disposition. Data suggest that extraversion is associated with smoking initiation among adolescents⁹² as well as current smoking status.^{93–95} A later study found that higher levels of extraversion increased the odds of initiating smoking by about 40%.⁹² Extraversion appears to have direct and indirect effects on adolescent smoking progression.⁹⁶ Extraversion is a multidimensional trait that has several alternative formulations. However, one major psychobiological formulation is that it pertains to the approach system—that is, the same ascending dopamine circuitry involved in motivation and reinforcement response noted above.

Approach: Neural Analysis and Laboratory-Based Endophenotype Measures

The appetitive, or approach, system, involving the midbrain or mesolimbic dopamine circuitry (including the nucleus accumbens) is central here. Experimental probes typically involve examining differential response to (1) anticipated and (2) actual reward versus control or baseline responding. (“Reward” here refers to the reinforcing substance, or object of the goal-directed behavior, not to the hedonic response to smoking or nicotine discussed later in this chapter and in chapter 9.) Tasks of this nature can then be examined behaviorally (e.g., changes in reaction time), physiologically (in particular, changes in heart rate), and neurobiologically (in particular, changes in activation in nucleus accumbens via neuroimaging).^{97,98}

Nearly all of these types of tasks have been experimentally designed in a nonstandard manner across different laboratories, so their reliability and heritability are poorly assessed. However, what is known about key candidate measures is highlighted here.

Reinforcement Response

Reinforcement response is related to cognitive control in that (1) the two processes are mutually modulating and (2) ascending dopaminergic circuits are also important in reinforcement response. Relevant brain structures again include prefrontal cortex, as well as limbic-striatal structures, perhaps most notably the nucleus accumbens (which activates for potential reward [a signal reinforcer] as well as actual reward). Here, several angles on the reinforcement response system are considered. First, this system is responsible for learning associations that are meaningful. This learning (e.g., correlational learning or associative learning) is poorly studied in youth who go on to smoke. Second, the system is responsible for learning associations with predictors for reward (operant learning), and similarly, for extinguishing response to operant predictors that are no longer linked to the reward or reinforcer. Third, one can ask about the weight put on a potential reward (as opposed to an actual reward; here the interest is in the signal stimulus). A highly active ascending dopamine circuitry in the approach circuit is expected to place high value on signal of potential reward.⁹⁹ One can then ask about weighting of immediate, small reward versus later, larger reward, or delay discounting. Steep delay discounting is related to impulsive behavior and may be related to differences in this reinforcement system. This last perspective on reinforcement response is the only one that has been studied as of 2008 in relation to smoking onset, so it is focused on here via the following key tasks.

Reward Signaling and Discounting Tasks

Reward signaling in the brain involves several discrete elements⁹⁹ that will be useful to decompose in future studies of reward and smoking risk. The properties of nearly all tasks are still being worked out. However, several promising probes that could serve as endophenotypes for future research have emerged, such as the Iowa gambling task.¹⁰⁰ This task is the one most often used in substance-use research to assess reward weighting and is associated with alcohol and drug abuse.¹⁰¹ As of 2008, it has not yet been utilized to assess risk for smoking onset. In this task, the individual “plays” a series of cards from four decks. Each deck has a different reward-cost ratio. Impulsive individuals tend to choose big rewards even though they come with bigger losses (and a net loss in the end) instead of smaller rewards that lead to a net gain. The biological linkage to this task of brain regions for the ascending dopamine circuitry described previously is supported by lesion.¹⁰⁰ Another related paradigm is reward signaling. In this task, the youth sees a cue indicating that a reward of varying size will soon be received. The cue appears to activate the nucleus accumbens.⁹⁷ In one small study, failure of such activation was related to ADHD.⁹⁸ Reward signaling has promise but has not been studied genetically.

Reward-discounting tasks may be the most promising; these are used with either real or hypothetical rewards, with similar effects,¹⁰² and tasks using real rewards can be adapted for very young children.¹⁰³ Most well studied is a hypothetical reward-discounting task, which can be useful beginning as early as middle childhood. In this task, the youth makes a series of hypothetical choices indicating a preference for a larger amount of money later (e.g., \$100) and a smaller amount now (e.g., \$10), with the amounts stochastically varied to find that individual’s breakpoint of preferring to wait. This

task has the advantage of being directly transferable to animal studies, a major advantage for an endophenotype. As a result, linkages to reward circuitry in ventral and orbitofrontal cortex and ventral striatum/nucleus accumbens have been demonstrated in animal research¹⁰⁴ and in human neuroimaging studies.¹⁰⁵ Further, behavior on this task is related to ADHD,¹⁰⁶ which is one behavioral risk factor for smoking.

In fact, considering predictive validity, these types of measures are not well utilized with regard to risk of nicotine use initiation or, for that matter, much studied in relation to children. The majority of studies of delay discounting have involved adult populations or those who are already smoking (chapter 9), whereas most studies of reward cue response tasks have not looked at smoking outcomes in youth. However, current smokers tend to discount the value of future rewards compared to never smokers and those who do not smoke daily or regularly (e.g., chippers).^{102,107} It is, therefore, unclear if reward discounting reflects propensity to become addicted once exposed to cigarettes or reflects risk for onset.¹⁰² Further, the role of this variable in adolescent smoking has either been unclear or indirect.^{84,108} For example, one study found that delay discounting (based on a self-report measure) was indirectly related to smoking initiation and progression through variables more proximal to smoking.⁷⁶ Data related to adolescent smoking cessation indicated that adolescents unable to achieve abstinence discounted monetary rewards on a computerized discounting task more than did those adolescents who were abstinent from smoking.¹⁰⁹ Finally, laboratory studies of adult smokers (smoking ≥ 15 cigarettes daily) suggest that upon abstinence, regular smokers experience abstinence-associated deficits in incentive motivation.¹¹⁰ For example, compared to performance during an abstinence phase, smokers show increased responsiveness to monetary reward on the Card Arranging Reward

Responsivity Objective Test during a nicotine phase.¹¹⁰

With regard to heritability, these tasks are not well studied. One small twin study suggested that heritability of delay aversion in young children is quite low, on the order of .2 to .3,¹¹¹ suggesting that unless its genetic architecture is very simple, it will not be a useful endophenotype. However, it may be that either latent variables that resolve measurement unreliability will yield a stronger genetic signal in this domain or that delay discounting tasks will exhibit higher heritability.

Physiological Measures of Reward Response

In addition, this system can be measured either peripherally by heart rate acceleration to a possible reward or centrally by functional magnetic resonance imaging (fMRI) measures of nucleus accumbens activation to potential reward.⁹⁷ These measures have extensive validation literature, suggesting they tap the relevant reward circuitry,^{97,112} but virtually no heritability studies.

Avoidance-Related Risk Variables: High-Level Psychological Traits

Neuroticism

Neuroticism, a basic, higher-order personality trait, reflects a generalized tendency to experience negative affect, to have difficulty coping with stress, and to be nonresilient in the face of change. It has substantial heritability.^{113–115} High neuroticism has been shown to prospectively predict smoking behavior in adolescents and young adults.^{116–118} These studies of neuroticism and youth smoking acquisition appear to be consistent with a large body of adult research showing a positive association

between neuroticism and smoking.¹¹³ Later findings indicate a significant association between platelet monoamine oxidase (MAO) activity and neuroticism,⁶⁹ which are both associated with smoking behavior.¹¹⁹ About 10% of the genetic variation in neuroticism appears to be due to genes that also act on MAO. MAO activity has been shown to increase as a result of smoking and to decrease during periods of smoking cessation.^{120,121} Thus, genes related to MAO activity and their biological markers may be useful targets for genetic research on smoking risk.

Stress

Related, and often considered within the overall construct of neuroticism, are the subjective feelings of stress. There has been less research on the impact of subjective feelings of stress on adolescent smoking acquisition than on other psychological variables. The available research, however, suggests that stress is related to smoking initiation,^{116,122} smoking status,^{123–125} and a decreased likelihood of quitting¹²⁶ in adolescents. Yet, an important and often overlooked aspect of this link between stress and smoking is that it appears to act in only one direction. Controlled studies in adults confirm that acute stressful challenges, for example, reliably increase smoking behavior, but that an increase in smoking does not seem to subsequently relieve the subjective distress resulting from the challenges,¹²⁷ although such smoking clearly relieves distress due to tobacco abstinence.¹²⁸ It is not at all clear that stress relief explains the reliable increase in smoking due to all or even most stressors.

Depression

Depression is one of the most common psychiatric disorders in adolescence. It is characterized by depressed mood, anhedonia, vegetative symptoms, and impaired psychosocial functioning.

Subthreshold depression (depression that does not meet all criteria for the diagnoses of major depression) is also prevalent in youth; it is associated with psychosocial impairment and often precedes and follows a major depressive episode.^{129–135} Neuroticism is a major diathesis for depression.¹³⁶ Depression predicts smoking initiation,^{137,138} current smoking,^{139,140} and nicotine dependence in adolescents.¹⁴¹ About 32% of adolescent smokers have a lifetime history of major depression compared to 17% of nonsmokers.¹⁴² Major depression is associated with a 19% increase in the average daily smoking rate (cigarette intake) and a 75% increase in the odds of being nicotine dependent from mid-adolescence to young adulthood (16–21 years old).¹⁴³ Young adults (aged 21–30 years) with a history of major depression are three times more likely to progress to daily smoking compared to those without major depression¹⁴⁴ and over two times more likely to progress to nicotine dependence.¹⁴⁵

Some research suggests that the association between smoking and depression results from common factors (e.g., genetic or environmental factors) that are associated with both increased risks of depression and increased risks of smoking.^{146,147} Significant comorbidity between smoking and major depressive disorder was found before, but not after, adjustment for presence of other psychiatric disorders.^{142,148} Other studies of adolescents and adults suggest that control for factors common to smoking and depression was not adequate to explain their association.^{143,145,149,150} Alternatively, the association between smoking and depression may reflect a cause-and-effect relationship. The direction of the causal effect is controversial.^{58,138,140,142,144,151}

Thus, highlighting concerns with heterogeneity in risk pathways to smoking, some findings indicate subpopulations of adolescents who differ with respect to the relationship between smoking

and depression (i.e., smoking increases depression symptoms in some and decreases depression in others). Specifically, the study empirically identified three distinct depression trajectories from ages 14 to 18 years. Smoking was not associated with being in the low symptoms trajectory but was associated with acceleration in depressive symptoms for adolescents in the moderate symptoms trajectory and with a deceleration of depressive symptoms in the high symptoms trajectory.¹⁵² Thus, a subgroup may exist (those with higher symptoms) who “self-medicate” depressive symptoms with nicotine. A later section considers whether this is a direct effect or an indirect effect mediated by the improved attention provided by the nicotine.¹⁵³

Another study found that cigarette smoking had disproportionate reward value for depressed smokers.¹⁵⁴ It is possible that the heightened reinforcing value of smoking may mediate the relationship between depression and smoking behavior. The mesocorticolimbic dopamine reward pathway appears to be dysfunctional in individuals with major depression, such that they are more responsive to substances that activate these reward systems.^{155,156} Within a tripartite neurobiological model,^{157,158} depression is viewed as reflecting both an elevated neuroticism, which is a nonspecific marker of internalizing psychopathology, as well as a shortage of positive affect (underfunctioning of an approach system). Thus, a key question for smoking endophenotypes is whether smoking risk is associated with over- or underfunctioning of the incentive reward systems in the brain. Multiple genetic pathways are possible in this regard.

Anxiety

Like depression, anxiety disorders can range in degree from a full-scale disorder to subthreshold levels.¹⁵⁹ Anxiety tends to be linked to neuroticism and to negative affect.¹⁵⁷ The hallmark features of anxiety

disorders include uncontrollable worry, physical symptoms such as sweating palms and increased heart rate, and secondary features such as restlessness and difficulty concentrating.¹⁵⁹ Research suggests an association between cigarette smoking and/or nicotine dependence and anxiety disorders in young adults and adolescents.^{149,160–162} However, it appears that smoking may precede the onset of anxiety disorders.^{160,163} In fact, adolescents who smoked more than 20 cigarettes a day were 6.8 times, 5.5 times, and 15.9 times more likely to be diagnosed with agoraphobia, generalized anxiety disorder, and panic disorder, respectively.¹⁶³ Anxiety disorders during adolescence were not associated with cigarette smoking during young adulthood. In contrast, another study found that anxiety symptoms predicted smoking initiation in youth.¹³⁸ Chronic symptoms of anxiety during adolescence predicted progression to nicotine dependence during young adulthood.¹⁶⁴ In addition, adolescents and young adults with social fears have an increased risk of nicotine dependence.¹⁶⁵ Thus, the relationship between anxiety and smoking may depend on the degree of anxiety (clinical diagnosis versus subclinical symptomatology) as well as the type of anxiety disorder.

Alternatively, the relationship between smoking and specific anxiety disorders may not be best represented by a direct effect. Neuroticism predicts the co-occurrence of smoking and panic disorder¹⁶⁶ and moderates the effects of maximum smoking rate on lifetime history of panic disorder.¹⁶⁷ Indeed, it has been argued that mediator and moderator approaches that consider contextual factors may be more informative than direct-effect approaches for understanding the relationship between negative affective states, such as anxiety, and the smoking behavior developmental continuum.¹⁶⁸

Neurobiologically, anxiety, and its emotional cousin, fear, are related to activation of

the particular nuclei in the amygdala and associated neural structures that signal potential negative events.^{169,170} MAO plays a significant role in serotonin metabolism and transmission,^{171,172} which has been implicated in anxiety disorders.¹⁷³ Models that consider the links between MAO, serotonin, and smoking may advance understanding the relationship between anxiety and smoking behavior from a genetic perspective.

Avoidance: Neural Analysis and Laboratory-Based Endophenotype Measures

The avoidance dimension, as conceptualized here, is anchored by readiness of behavioral withdrawal-related behavior in potentially unrewarding or uncertain contexts, and with associated affective reactivity (i.e., fear, anxiety, and sadness). This dimension is related to emotions of anxiety and depression, as well as to the personality trait of neuroticism, which, as noted above, is another set of surface traits related to smoking risk. Neuroticism is the most abstract of these and has component factors such as negative affectivity and anxiety. As discussed in the previous section, neuroticism can be viewed at lower levels of analysis that may be closer to gene action. In this case, the reactivity of these avoidance responses is related at the level of the CNS to limbic-frontal neural circuitry and the amygdala. Depue and Lenzenweger¹⁷⁴ describe fear as an immediate threat response involving short-term activation in the central amygdala nucleus, whereas anxiety is a long-term activation to low-grade threat associated with activation in the bed nucleus of the stria terminalis in the extended amygdala. Thus, reactivity of a stress-response or danger-alarm system (hypothalamic-pituitary-adrenocortical [HPA]) axis and associated autonomic and hormonal effects, which at the CNS level includes the lateral hypothalamus, reticular formation, and other structures) is a key

feature. At the level of the PNS, reactivity of this set of response systems is hypothesized to emanate in sympathetic activation of autonomic systems, in particular electrodermal skin response to anticipated loss of reward.^{44,112} At the CNS level, as noted in table 8.1, electroencephalogram (EEG) measures appear to index relative degree of predisposition to approach and avoidance activation by characteristic lateralized asymmetries in EEG power.^{45,175–178} The fMRI data suggest that amygdala activation (associated with avoidance of potentially unpleasant events) and nucleus accumbens activation (related to approaching a potentially positive event) appear to be mutually inhibiting responses.¹⁷⁹ Examination of these types of physiological measures as potential endophenotypes may bring data closer to gene action and help identify risk mechanisms for smoking beyond the broad surface trait of neuroticism or its constituent elements of anxiety or negative mood. However, only a handful of such measures have been examined, as noted in table 8.1.

Neuroendocrine Response to Stress/Cortisol

In particular, neuroendocrine response in relation to danger and stress response systems, as potential reflection of avoidance-related responding,^{174,181,182} includes two biological systems (conceptually related respectively to psychological fear and anxiety, as distinguished in the previous paragraph). First, the sympathetic adrenomedullary system is thought to be a fast-acting system (including providing adrenalin for “emergency” or alarm response) that in day-to-day regulation of behavior may index excitement, vigilance, or alertness; however, another interpretation is that it indexes the negative affectivity “fear” response.¹⁷⁴ Second, the limbic HPA system is thought to be a slow-acting stress response system associated with arousability and negative emotions¹⁸¹—more specifically, anxiety.^{174,183}

Its activity (primarily, corticotrophin-releasing hormone) is most often indexed by peripheral cortisol levels. Set points or reactivity in these systems may underlie the observed personality correlates of smoking risk (e.g., smoking to alleviate fear or anxiety, or attentional bias toward drugs of opportunity to relieve internal emotional discomfort). Therefore, cortisol reactivity is a candidate endophenotype that may capture predispositions to smoking, albeit nonspecifically, at a lower level of analysis neurobiologically. However, its promise is somewhat unclear. Associations of cortisol measures with behavioral measures are decidedly mixed,¹⁷⁶ due in part to the need to interpret cortisol (and for that matter, other biological markers) in relation to behavioral context.^{44,182} Therefore, it may be useful to examine cortisol reactivity in relation to smoking cues or in relation to stressors that are contextually linked to smoking onset. Yet, the decline in cortisol soon after quitting is predictive of quitting success in chronic smokers, as noted in chapter 9, suggesting a very different process indexed by cortisol in that population.

Other Measures

Further measures could be considered. These include skin conductance response and heart rate to potential loss of reward, as well as other measures of avoidance learning.¹¹²

Control-Related Risk Variables: High-Level Psychological Traits

Attention Deficit Hyperactivity Disorder

ADHD is a developmental disorder characterized by age-inappropriate levels of hyperactivity and impulsivity and an inability to sustain directed attention.¹⁸⁴ Because of its very high heritability, early onset (generally much earlier than smoking initiation), and long-term stability of

Table 8.1 Extant Data on Potential Endophenotypes and Their Measurement

Neural system/function	Reliability	Heritability	Validity
Attentional capture			
Orienting and alerting tasks	Unknown	Unknown	NA
Flanker task	Moderate	Low	NA
Posterior activation on fMRI	Unknown	Unknown	NA
N1 ERP component	Moderate	Moderate	NA
P2 ERP component	Moderate	Moderate	NA
Arousal			
EEG slow-wave activity	High	High	NA
Reaction time	High	Moderate	NA
Signal detection	Moderate	Unknown	NA
Cognitive control/top-down attention			
Stroop interference task	Moderate to low	Poor	NA
Working memory tasks			
Digit span backwards	Moderate to high	Unknown	NA
N-back	Unknown	Unknown	NA
Spatial span back	Unknown	Unknown	NA
Response inhibition			
Stop-go task	High	Moderate	NA
Go/no-go task	Moderate	Moderate	NA
Antisaccade task	Moderate	Unknown	NA
Cardiac measures			
Vagal tone/RSA	High	Unknown	NA
CNS measures			
P300 amplitude	High	Mod to high	1
Executive functioning/planning			
Tower of London	Poor	Unknown	NA
Tower of Hanoi	Poor to mod		NA
Trait measures			
Personality constraint	High	Mod to high	NA
Effortful control	High	Moderate	NA
Approach-related and reward response markers			
Iowa gambling task	NA	NA	NA
Delay discounting task	High	Poor	1
Incentive response reaction time	NA	NA	NA
Cardiac measures			
Heart rate acceleration to possible reward	NA	NA	NA
CNS	NA	NA	NA
Nucleus accumbens activation	NA	NA	NA
Trait measures			
Extraversion	High	Mod to high	2
Positive affectivity	High	Moderate	NA
Anxiety response and avoidance-related measures			
Response cost measures			
PNS			
Skin conductance	Moderate	Poor ¹⁶⁰	NA
Heart rate to loss of reward	NA	NA	NA
CNS			
Lateralized EEG profile	NA	Mod to high	NA
Trait measures			
Neuroticism	High	Mod to high	2
Negative affectivity	High	Mod to high	NA

Note. For reliability, high = $\geq .7$, moderate = $.5-.7$, poor = $\leq .5$; for heritability, high = $.5-.7$, moderate = $.3-.5$, low = $\leq .3$. See text for biological plausibility and references. Predictive validity pertains only to smoking onset, not to other outcomes. In that respect, validity here is rated as follows: 1 = little supportive data; 2 = moderate amount of supportive data; 3 = well established. Heritability data are provided in the text; see corresponding sections in the text for review of literature and citations relevant to the conclusions stated in this table. NA = data are too sparse to enable any comment or studies are not available in this domain to insert a rating; fMRI = functional magnetic resonance imaging; ERP = event-related potential; EEG = electroencephalogram; mod = moderate; RSA = respiratory sinus arrhythmia; CNS = central nervous system; PNS = peripheral nervous system.

symptom levels (though not of diagnostic type),^{185,186} it has some advantages over later-onset disorders (such as anxiety and depression) in potentially predicting smoking onset.

The Diagnostic and Statistical Manual of Mental Disorders, fourth edition (*DSM-IV*)¹⁵⁹ identifies three subtypes of ADHD: predominantly inattentive, predominantly hyperactive and impulsive, and combined, although the appropriate etiological subtyping of ADHD and characterization of its own cognitive endophenotypes remain an active area of investigation.^{187,188} ADHD has been associated with an increased risk of adolescent smoking initiation and progression.^{189–196} Youth diagnosed with ADHD and youth with higher ADHD symptoms (although not a diagnosis) tend to start smoking earlier than those without either.^{192,193,197,198} ADHD history also predicts inability to quit among dependent smokers, as discussed in chapter 9.

It is unclear whether inattention or hyperactivity/impulsivity are equally predictive of smoking or whether one set of symptoms is more strongly associated with smoking than the other. This is important because some models suggest that symptoms of inattention may yield partially distinct temperamental and neural correlates (primarily related to cognitive control) versus hyperactivity/impulsivity (primarily related to reward response).¹⁸⁸ Adolescent and adult research supports an association between smoking and inattention, but not between smoking and hyperactivity.^{195,199} It has been speculated that those with ADHD may smoke to self-medicate their attentional deficits.²⁰⁰ In support of this notion, Molina and Pelham¹⁹³ found inattention rather than hyperactivity/impulsivity to be more predictive of subsequent smoking. However, retrospective reports of childhood ADHD symptoms among young adults suggests that hyperactivity/impulsivity is a stronger

predictor of regular smoking than are ADHD inattention symptoms.¹⁹⁷ Laboratory-based research has found that acute nicotine administration positively affects both cognitive and behavioral inhibition among nonsmoking adolescents with ADHD,²⁰¹ but both of these may be related to cognitive control and inattention symptoms.¹⁸⁷

However, many studies did not adequately control for conduct problems/conduct disorder. These antisocial behavior problems often overlap with ADHD and may identify the subgroup at greatest risk of smoking. The association between ADHD and adolescent substance use, including smoking, is often weakened or rendered insignificant when comorbid conduct disorder is considered,^{200,202–204} although not in all studies,^{153,203,205} especially when the independent effects of inattention are evaluated.²⁰³ Some data suggest that ADHD and conduct disorder may be associated with different substance-use characteristics, such as early onset and frequency of use.²⁰⁶

Neurobiologically, ADHD, and particularly the inattention component, is thought to be related to deficits in cognitive control that are instantiated in the prefrontal cortex, striatum, and cerebellum. These frontal-subcortical circuits are involved in working memory, cognitive control, and planning and execution of complex behaviors. Laboratory measures of these abilities are well associated with ADHD²⁰⁷ and, therefore, may be potential laboratory-based candidate endophenotypes for smoking onset. ADHD has been reliably associated with a handful of specific genes, including the dopamine transporter gene, dopamine *D4* receptor gene, and others,²⁰⁸ potentially providing further clues to the genetics of smoking initiation risk. An additional neurobiological aspect of ADHD is apparent association with low cortical arousal, as indicated by poor signal detection²⁰⁹ and excess slow-wave EEG.²¹⁰ Also consistent with arousal dysregulation as a risk phenotype, Wong and

colleagues²¹¹ found that sleep problems of three- to five-year-olds, as rated by mothers, predicted early drug-use onset, including smoking by 14 years of age, in adolescence. Whether smoking provides specific compensation and is uniquely related to the underaroused profile described above is unclear, but as noted, this is one possible way of understanding smoking attraction in these youth. Endophenotypes that tap an arousal system, particularly ascending noradrenergic circuits, may therefore be of use.

Conduct Disorder and Aggression/Hostility

Conduct disorder is defined as a persistent pattern of behavior in which age-appropriate societal norms are repeatedly violated.¹⁵⁹

Typical behaviors include aggression, deceit, stealing, damage to others property, cruelty, and general rule violations. Adolescents with conduct disorder are almost 13 times more likely to be current smokers than are adolescents without conduct disorder.²¹²

In fact, conduct disorder predicts earlier, regular (daily) adolescent cigarette smoking and has been shown to be a mechanism by which family risk factors affect adolescent smoking.¹⁸⁹ Externalizing disorders, such as conduct disorder, tend to have the highest associations with progression to daily smoking and nicotine dependence compared with other psychiatric disorders.¹⁹⁴ At the same time, they are clearly recognized as a general risk factor for drug use overall and are not specific to nicotine use.^{9,43,213}

A later study found that physical aggression increased the odds of smoking before 14 years of age by 16%. Thus, adolescents with earlier onset of smoking tend to be more physically aggressive than those who have not initiated smoking by this age.⁸⁵ It is possible that adolescents who have difficulty coping with anger and frustration use cigarettes as a coping method. Nicotine has been shown to have palliative effects on anger and to reduce the frequency of

anger reports in smokers with high levels of hostility.^{214,215} In fact, research that evaluated the metabolic effects of nicotine in the brain found that nicotine triggered dramatic changes in regions of the brain important in behavioral control in individuals rated as more aggressive or easier to anger.²¹⁶ This may be especially relevant for understanding adolescent smoking in that adolescents attempt to manage extremes in emotion before behavioral control centers in the brain have finished maturation.²¹⁷ Animal models indicate that aggressiveness may be partially due to fetal nicotine exposure; for example, rodents exposed to nicotine in utero had higher levels of aggressive behavior compared to those with no in utero nicotine exposure.

However, the developmental progression requires further elucidation. Most youth with conduct disorder had earlier oppositional defiant disorder,²¹⁸ and in turn, youth with oppositional defiant disorder tend to have irritable early temperament.²¹⁹ Irritable temperament may reflect perinatal risks, including prenatal exposure to nicotine,²²⁰ or genetic effects on regulation of negative affect/irritability. Likewise, ADHD is a risk factor for later development of conduct disorder.²¹⁹ It may be that these represent related routes of vulnerability, with smoking onset as a later outcome of these early risks. Identifying endophenotypes related to conduct disorder will therefore overlap with endophenotypes related to ADHD. Indeed, studies suggest that conduct disorder, ADHD, and substance use may be explained by a highly heritable latent phenotype of behavioral disinhibition.²²¹

Control: Neural Analysis and Laboratory-Based Endophenotype Measures

Previously, two superordinate dimensions were noted: (1) extraversion and (2) negative emotionality, or neuroticism.

The third superordinate dimension in personality structure is variously labeled as low constraint,²²² unsocialized sensation seeking,⁵¹ and low effortful control.^{48,223} Higher levels of constraint and effortful control are inversely related to ADHD (see Nigg¹⁸⁷ for a review) as well as to a lesser extent with aspects of conduct disorder and impulsive aggression. When dysfunctional, it is related to difficulty in regulating attention and may be related to ease with which attention can be captured by incentives or potential incentives in the environment (e.g., possibility of trying drugs or cigarettes). “Effortful control in young children,” as defined by Rothbart and colleagues (e.g., see Putnam and colleagues⁶⁶) includes elements of attentional control, low-intensity pleasure, and attentional shifting and focusing behaviors. Again, these surface behaviors can be analyzed at a neurobiological level that may suggest candidate endophenotypes.

The capacity for and tendency to exert effortful control is theorized to depend on anterior neural systems. These neural systems emphasize frontal-striatal neural loops that are dopaminergically modulated.²²⁴ This system can regulate the affective response systems. For example, human neuroimaging studies have now shown a role for top-down prefrontal modulation of subcortical regions.^{225,226} In other words, prefrontal activation is associated with reduced limbic activation. The importance of this is that it provides imaging evidence confirming the direct neural regulation of affective response by top-down effortful control. If weakness in the top-down control system is associated with smoking risk, future smokers would be expected to show weaker prefrontal activation on the types of challenge tasks used in these studies.

Cognitive control is a more formal term for effortful control. It refers to the ability to manage competing information and

deliberately direct attention in the service of task demands. It includes subsidiary abilities such as response suppression, working memory, and response selection. From this angle, numerous available laboratory measures can be identified that may be viable endophenotypes. These are extensively validated by neuroimaging data as activating the neural circuits of interest (described in sections below). These measures tend to involve circuitry modulated by dopamine and noradrenergic activity. In turn, acetylcholine neurons likely modulate these circuits.²²⁷ They, therefore, are relevant to nicotine maintenance as well as onset. The endophenotypic criteria (reliability, heritability, and predictive validity) are described and considered below for selected measures of cognitive control, identified by their having some data on association with smoking onset and/or maintenance. Again, if weak cognitive control is associated with vulnerability to smoking onset, adolescents who go on to smoke would be expected to have slower reaction times and more errors on executive function tasks than do adolescents who do not go on to smoke. Also, these cognitive-control abilities are important to academic success; if nicotine improves these abilities, then that improvement could add to nicotine’s reinforcing effects, as discussed in the next section. For example, it may be that nicotine acutely enhances cognitive control.²²⁷

Response Inhibition

Response inhibition is the ability to suppress a prepared response in a rapid-decision context. Several widely used tasks have been used to assess it. The go/no-go task is the most well known. The individual presses a key as rapidly as possible when the target appears (e.g., the letter “X” appears at variable intervals averaging once per second on the computer screen). On a minority of trials (25%), the “X” is colored red, or a different letter appears, meaning it is a

“no-go” trial. Another task is the antisaccade task in which individuals are to refrain from moving their eyes toward a target that suddenly appears in the periphery of their vision; that is, they must suppress the reflex to move toward that target and, instead, move their eyes in the opposite direction to get a correct response. Perhaps the most-well-validated measure of the ability to suppress a prepared response is the stop-go task.²²⁸ The individual faces a computer screen and on a series of trials decides as quickly as possible whether the letter that appears is an “x” or an “o.” On 25% of the trials, however, a tone sounds indicating that the response should be interrupted (stop trials). The timing of the warning tone is varied to enable estimation of how much warning the individual needs, interpreted as speed or efficiency of the stop process. Physiological data have demonstrated that response interruption on this task involves both central and peripheral mechanisms.²²⁸ Both lesion data and imaging data indicate that this ability involves a circuit in the brain that includes the right inferior frontal gyrus and the striatum.^{229,230} Brain recording data in primates indicate that specific neurons in these brain regions are active during response interruption.²³¹ The computerized measure has excellent reliability.²³²

Heritability of these individual measures has not been well established, although forthcoming data appear to place heritability of stop-go task stop-signal reaction time (SSRT) at $<.50$, the antisaccade task at about $.56$ (E. Willcutt, personal communication, January 2007), and the go/no-go task at $<.50$.²³³ However, it is notable that when a latent variable is constructed from these response inhibition measures, it appears to have more robust heritability, although this latent variable heritability has varied widely in two studies from $.48$ to $.99$.^{234–236} The promise of this function as an endophenotype appears to rely upon utilizing latent variables (an approach not yet attempted to evaluate risk for smoking

onset or persistence) or the hope that the less-heritable individual measures will be genetically simpler than the phenotypes to which they are indexed. No evidence on this last point has emerged. However, the brain circuitry involved is dopaminergically modulated and also appears to depend on acetylcholine receptors.²²⁷ Thus, examination of receptor genes for dopamine and acetylcholine may clarify the endophenotypic value of these measures.

Further, surprisingly few data are available regarding response suppression and risk for smoking onset. It is unclear whether stop-go task performance predicts smoking initiation or progression to regular smoking and nicotine dependence. One study found that the SSRT was significantly improved following nicotine administered via transdermal nicotine patch in nonsmoking adolescents diagnosed with ADHD.²⁰¹ Another study of healthy adult regular smokers did not find acute effects of nicotine on this inhibition measure.²³⁷ With respect to the go/no-go task, smokers tend to show more impulsivity on these measures than do nonsmokers.²³⁸

P300 Event-Related Potential

Several EEG/ERP measures may be worthwhile as endophenotypes. However, the aspect most studied in relation to smoking risk is the P300 wave. The P300 is an ERP component thought to be related to working memory and stimulus evaluation. As such, it probably indexes cortical activity. It is typically assessed by having an individual complete a computerized attention task or go/no-go task with unexpected events included in a minority of trials (sometimes called “oddball” trials). The individual has to evaluate this event and update working memory; this is thought to be indexed by differences in the peak amplitude (strength) and speed (latency) of the ERP response at 300 milliseconds. Initial data in adults indicate that the reliability of

this index is excellent ($>.80$), and heritability of the amplitude is moderate to high, in the range of .6 to .7;²³⁹⁻²⁴¹ heritability may be higher in males than in females,²⁴¹ whereas heritability of latency was unclear.²³⁹ Hence, the focus here is on the P300 amplitude.

P300 amplitude appears to have important linkages at the phenotypic level with smoking and related risk behaviors. In a community sample of 17-year-old males, reduced P300 amplitude was related to externalizing behavior (defined as the common factor underlying nicotine and other drug dependence, conduct disorder, and adult antisocial behavior).²⁴² A series of studies from the Minnesota Twin Family Study has shown that reduced P300 amplitude at 17 years of age predicted the subsequent development of substance-use disorders, including nicotine dependence.^{241,243}

The P300 may be related to persistence as well as to onset. Studies of adults found lower P300 amplitude in current smokers compared to never smokers, whereas former smokers did not differ significantly from never smokers.²⁴⁴ In addition, the amplitude has been shown to be reduced in nicotine-abstinent adults compared to nonsmokers but, after smoking, was equivalent to that of nonsmokers.²⁴⁵ Further clarification of the state or trait characteristics of this measure in relation to onset and persistence appears to be warranted.

Other Candidate Tasks

A wide range of other psychometrically reliable measures relevant to cognitive control are available and may warrant exploration. Their heritability data, however, varies. Key examples are as follows. First, measures of working memory tap cognitive control systems and are strongly related to risk for psychopathology.^{42,246} These include such measures as counting and sentence span (the child recalls and repeats ever larger lengths of items, sometimes

backwards or while doing a competing task), and N-back tasks (the child updates working memory with a new total every N-items, e.g., every three items). These tasks have excellent validity with regard to neural activation in dorsolateral prefrontal cortex,²⁴⁷ psychometric reliability, and theoretical coherence. Their individual heritability appears to be modest, in the range of .4.^{233-235,248} However, they may be influenced by a simpler genetic architecture involving the noradrenergic alpha-2A receptor gene²⁴⁹ and dopaminergic genes. These measures, however, have not been widely studied with regard to their phenotypic or genotypic association with smoking onset.

Second, measures of set shifting or task switching have become quite sophisticated in their ability to assess cognitive control.²⁵⁰ Simple neuropsychological measures such as the card sorting tasks, in which the individual must remember the working rule for sorting cards (e.g., by color, number, or shape) while problem solving errors, are of interest. These tasks have large validation literatures indicating that they entail activation of the dorsolateral prefrontal cortex.⁶³ Although heritabilities based on single measures are modest (in the range of .50),^{234,251} a composite latent variable of set shifting on card sort measures has heritability approaching .80.²³⁴

Third, direct neuroimaging measures of brain morphometry have been utilized very little in assessing smoking risk. However, because brain imaging measures show moderate associations with other risk phenotypes (such as ADHD), they may be worth pursuing. Further, substantial data show that a range of relevant morphometric measures have heritability exceeding .8^{252,253} or are highly familial,²⁵⁴ and that some directly relevant functional activation patterns are also quite heritable, including relevant activation in the anterior cingulate cortex during stimulus appraisal.²⁵⁵

For PNS concomitants of regulatory control, more consideration is warranted of the utility of parasympathetic response measures. For example, an extensive physiological literature suggests that heart-rate variability, and cardiac vagal tone in particular, is a potential index of regulatory processes.^{256–259} The parasympathetically mediated cardiac response reflected in vagal tone is operationalized as respiratory sinus arrhythmia (RSA) both at rest (high resting levels associated with greater response potential) or in response to an attentional challenge (stronger response to challenge associated with better regulation). RSA reactivity in this situation is viewed as a direct index of effortful control because reactivity of heart rate is directly suppressed by neocortical action during attention,⁴⁵ which, in turn, inhibits sympathetic influences to keep heart rate low (although findings vary somewhat with age). If weak regulatory control is associated with smoking risk, adolescents who go on to smoke would be expected to have weaker RSA response to attentional challenge compared with other adolescents.

Finally, important to note, though more elusive, is the concept of “executive functioning.” Its usage here refers to response suppression and working memory as elements of cognitive control; in this case, *executive function* means the complex, temporal organization of multiple steps (such as completing a recipe). It requires planning, which is assessed on tasks such as the Tower of London that require multistep operations. Planning involves working memory, but also reasoning and intelligence, as well as suppression of competing responses; thus, it is multicomponential. Although these types of planning tasks have been notoriously poor in reliability, some versions have become more reliable.²⁶⁰ However, they are for the most part unstudied with regard to heritability.

Attention and Alertness

Two related ideas are introduced here: attention and alertness. Attention is how people select information, from the nearly infinite amount of input available, for further processing. It is influenced in turn by two types of mechanisms. One type of mechanism is bottom-up and relatively automatic (for example, capture of attention by a sudden movement or sound, or involuntary attraction of attention to a frightening possibility). A second type of mechanism is top-down, effortful, and goal directed (for example, ignoring others talking to finish an important memo for a deadline). It may be that bottom-up, motivated processes cause attention to be easily captured by the possibility of nicotine (or other drugs) or make one susceptible to societal images or opportunities to use cigarettes. For example, attraction to novelty, wish to escape from anxiety, or other motives may “bias” attention toward drug-related information in the environment, and thus, influence initial substance experimentation. Important neural systems are the posterior-anterior cortical loops as well as neural loops from the limbic system to the prefrontal cortex.

Alertness (related to the older concept of arousal) modulates cognitive control. Alertness reaches its nadir in sleep and its zenith during episodes of panic. In day-to-day adaptation, alertness enables one to notice and mobilize a response to important information (bringing the system into readiness) and to maintain attention on an important issue (maintaining readiness).

For alertness or arousal, relevant neural structures include a right-lateralized network of neural structures that include the noradrenergic system originating in the locus coeruleus, the cholinergic system of the basal forebrain, the intralaminar thalamic nuclei, the right prefrontal cortex,²⁶¹ and possibly the ascending

reticular activating system (the latter is related to wakefulness). Probes of this system include simple reaction time on fast-react tasks, response variability, response time to unwarned left-visual field targets, EEG slow-wave activity, excess vigilance decrement, and signal detection efficiency.²⁰⁹ A continuous performance task (CPT) is one in which the individual must identify a rare target in a field of events (similar to a radar operator watching for an occasional missile amid many birds and friendly planes). One hypothesis, for example, would be that excess resting slow-wave activity on an EEG is a liability marker for increased risk of smoking. As shown in table 8.1, EEG theta rhythm (slow-wave activity) is the most advanced of these measures with regard to reliability and heritability data and the most recommended endophenotype for liability studies from this group. Early ERP components, such as the N1 and the P2, also may have promise here, although initial data indicate they are less reliable and heritable than the slow-wave indices. See chapter 9 for a discussion of research linking the EEG and the ERP, as well as CPT responses, to persistence of smoking. Relatedly, multiple measures of attentional control are available. Gardner and colleagues¹⁵³ used a cue-orienting task and found that attentional control was correlated with nicotine use.

Note that cholinergic (nicotinic) receptors are important in attentional function and modulation of dopaminergic activity. These receptors may be involved in smoking onset as preexisting vulnerabilities that contribute to attraction to nicotine via low arousal, energy, or attention. However, given a dearth of data on that point and the obvious relevance of cholinergic systems to response to initial exposure, those endophenotypes are discussed later in this chapter.

Affiliation and Hostility

As a final note, many personality models include an affiliation dimension.^{42,49,51,66,262}

This trait may be relevant in view of the data cited earlier on hostility and smoking onset. However, aside from direct trait measures of hostility, consideration of this trait does not introduce additional low-level experimental paradigms at the present time and is not considered in further detail here.

Smoking and Nicotine-Dependence Risk: Summary and Future Directions

Table 8.1 lists the major measures discussed and what is known about their relevant characteristics. The higher-order traits can be conceived as part of a hierarchical model rooted at the most abstract level in reactivity of basic approach and withdrawal neural systems in early life but that differentiates into additional meaningful lower-order behavioral response systems during childhood. Differentiated at a four-factor level, which is useful for a broad overview, these include (1) an *approach* system related to responses to potential reward; (2) a frontal-limbic *avoidance* system related to stress-response systems and sympathetic autonomic response; (3) a *control* system that is multicomponential and related to cognitive operations such as working memory and response inhibition; and (4) a closely related *affiliation/empathy* system, related to effortful control and also to the capacity for negative affect, leading to empathy and a desire for and tendency toward affiliation and cooperation (as opposed to social dominance or social interaction, which are reflected in the reward-based socializing influenced by reward/approach systems). The affiliation/empathy system may not emerge distinctly throughout childhood, but it may be notable in adolescence. It may be better thought of as personality than as temperament. However, further examination of this system (or trait) in younger children remains of interest. (For more discussion

of distinctions and similarities between temperament and personality, see Nigg.⁴²⁾

The higher-order trait domains all have some promise in relation to smoking risk. It may be that there are multiple routes to risk or that smoking risk is overdetermined biologically. However, these traits are best understood in relation to lower level neural systems, which, in turn, points to more molecular cognitive or physiological measures that can be examined as endophenotypes. The traits themselves will continue to be subjected to genetic investigation, but they are unlikely to be genetically simpler than smoking itself.

As outlined here, a range of context-sensitive physiological measures are candidates to tap these systems at a lower level of analysis than personality. However, as table 8.1 demonstrates, data on basic properties, such as heritability, familiarity, performance in unaffected relatives, or even reliability, remain limited for many of these candidate measures. Such basic work will be needed before their promise can be fully evaluated. On the other hand, some measures already have promising preliminary characteristics and may warrant more aggressive examination in relation to smoking risk.

Initial Nicotine Exposure Response: Conceptual Framework and Candidate Endophenotypes

This chapter addresses a general approach to the study of factors that increase vulnerability to nicotine dependence in adolescents in an effort to identify endophenotypes that may index this vulnerability. As discussed up to this point, most of these factors are likely to be present and, for the most part, measurable before

the onset of tobacco exposure. However, some factors predisposing to dependence in youth may be observable only in response to initial tobacco (or nicotine) exposure. Obviously, escalation to dependence is not possible in those who avoid ever being exposed to tobacco in the first place, even if they otherwise are at great vulnerability for dependence. Among those ever exposed, escalation to dependence is actually less common than no escalation,²⁶³ suggesting great variability in the consequences of initial nicotine exposure. Factors accounting for variability in the short-term consequences of initial nicotine exposure warrant examination as potential predictors of nicotine dependence. There appear to be unique as well as common behavioral and genetic factors that predict the risk of smoking initiation, response to initial nicotine exposure, and subsequent smoking progression.^{21,23,264,265} This section focuses specifically on the effects of initial exposure to nicotine that may lead to progression in smoking behavior and nicotine dependence. It departs somewhat from a model of neural networks and moves to a model at a lower level of analysis involving synaptic reactivity to nicotine. This model is more appropriate to what is known about the physiology of nicotine response. Ideally, future research will examine initial responsiveness to nicotine within the comprehensive framework presented in the first section of this chapter to build a more complete picture of vulnerability to nicotine-dependence risk in children that includes both general and specific streams of risk influence at the genetic level.

This discussion, therefore, begins by considering the sensitivity model. This is a theoretical model of vulnerability to dependence that provides the starting point for considering endophenotypes of initial nicotine exposure. An alternative, the exposure model, is also noted. In brief, these models predict that greater or lesser initial sensitivity, respectively, to drug

effects increases vulnerability to onset of dependence. Because sensitivity to the same responses is relevant to either model, the same literature can be used to evaluate both models. However, as detailed below, the sensitivity model may have greater support and is used as the framework for identifying potential initial nicotine exposure endophenotypes. Nevertheless, variability in initial sensitivity to nicotine effects—either greater or lesser—may in fact have no consistent association with subsequent risk of dependence. This research is being examined in this chapter because of substantial plausibility for the role of sensitivity in dependence risk, despite a lack of clear empirical support that greater initial sensitivity prospectively predicts risk. The evidence for a potential endophenotype is considered within the methodological constraints of the existing literature. This section closes with a discussion of the research needed to fill the gaps in knowledge about initial nicotine exposure and promising endophenotypes.

Theoretical Support for “Innate” Sensitivity to Nicotine as an Index to Dependence Vulnerability

Vulnerability to dependence may be associated with the magnitude of an individual’s initial sensitivity—upon first exposure—to the rewarding and reinforcing effects of smoking, and specifically, nicotine. Evaluating this potential mechanism of vulnerability requires assessment of acute responses to early exposures to smoking (or other methods of administering nicotine). For many reasons, including substantial practical and ethical issues, little research in humans has prospectively examined whether sensitivity to initial nicotine exposure is associated with greater risk of dependence. Yet, this notion has some theoretical support and is bolstered by animal research findings.

Theoretical support for this notion comes from the sensitivity model of dependence vulnerability.²⁶⁶ This model essentially states that individuals who have higher “innate” sensitivity to nicotine will experience greater positive (i.e., pleasurable), but perhaps also aversive, effects from initial experience with nicotine. Such individuals will quickly become tolerant to the aversive effects, allowing the relative enhancement of positive effects. These changes result in greater reinforcement from smoking, promoting escalation of use and the onset of dependence. Those with lower innate sensitivity will be less likely to continue experimenting with tobacco because of a lack of positive effects. “Innate” sensitivity is sensitivity to nicotine upon first exposure and is based on genetic and other constitutional factors. It can be assessed only during “early” experiences with nicotine. It cannot be directly measured after the escalation of smoking frequency beyond experimentation (e.g., daily smoking) because of the onset of chronic tolerance, which is reduced sensitivity to nicotine as a function of tobacco exposure history.²⁶⁷ Onset of chronic tolerance and other indices of adaptation to chronic nicotine may be rapid,²⁶⁸ leaving only a narrow window of tobacco exposure occurrences during which to assess “innate” sensitivity to nicotine. These methodological issues will be discussed further below.

The sensitivity model is derived largely from animal research,^{269,270} which shows that some rat strains are more sensitive than others to nicotine upon initial exposure, and these strains may show greater acquisition of nicotine reinforcement. Thus, greater initial sensitivity may directly promote processes of nicotine dependence in humans, especially adolescents, and individuals who are more sensitive to nicotine upon initial exposure may be at greater risk of smoking progression and subsequent nicotine dependence compared to those who are less sensitive to this initial exposure.

The Exposure Model: An Alternative View of Initial Response to Nicotine

In contrast to the sensitivity model of initial nicotine exposure, the exposure model proposes that reduced, not enhanced, initial sensitivity predicts greater risk of nicotine dependence. The rationale for this idea is that experiencing few *aversive* effects from smoking makes subsequent experimentation more likely, such that other effects of nicotine can begin to produce changes that lead to dependence. Also, such individuals from the very outset may take in larger drug amounts to counter their attenuated sensitivity. This greater consumption can accelerate the consequences of heavy drug exposure, including dependence and physiological pathology. The exposure model is derived mostly from the alcohol research literature, especially studies of alcohol responses in offspring of alcoholics compared to controls.^{a,b} Disparities between the sensitivity and exposure models may stem from the different substances involved, which may induce dependence either by unique and different processes, or by the different responses assessed.^{a,c} Supporting the latter possibility were findings from a study of women either with or without a paternal history of alcoholism who were given an acute dose of alcohol.^d Those with a positive paternal history exhibited less impairment due to alcohol on one performance task—digit-symbol substitution—consistent with the exposure model. Yet, they showed greater reward responses to alcohol (e.g., “liking,” “good drug effect”), consistent with the sensitivity model, as well as more impairment on a second performance task—digit recall. Other research also has found greater, rather than lesser, sensitivity to the intoxicating effects of alcohol (as well as barbiturates) in men with a positive family history of alcoholism.^e Thus, because the sensitivity model has somewhat more support in explaining the association of some responses to nicotine-dependence risk, potential endophenotypes are evaluated from the perspective of the sensitivity model.

^aEng, M. Y., M. A. Schuckit, and T. L. Smith. 2005. The level of response to alcohol in daughters of alcoholics and controls. *Drug and Alcohol Dependence* 79 (1): 83–93.

^bSchuckit, M. A., and T. L. Smith. 1996. An 8-year follow-up of 450 sons of alcoholic and control subjects. *Archives of General Psychiatry* 53 (3): 202–10.

^cPomerleau, C. S., O. F. Pomerleau, S. M. Snedecor, S. Gaulrapp, and S. L. Kardia. 2004. Heterogeneity in phenotypes based on smoking status in the Great Lakes Smoker Sibling Registry. *Addictive Behaviors* 29 (9): 1851–55.

^dEvans, S. M., and F. R. Levin. 2003. Response to alcohol in females with a paternal history of alcoholism. *Psychopharmacology (Berl)* 169 (1): 10–20.

^eMcCaul, M. E., J. S. Turkan, D. S. Svikis, and G. E. Bigelow. 1991. Alcohol and secobarbital effects as a function of familial alcoholism: Extended intoxication and increased withdrawal effects. *Alcoholism, Clinical and Experimental Research* 15 (1): 94–101.

Overview of Measures of Innate Sensitivity to Acute Effects of Nicotine

Selected animal studies and the limited human research exploring the notion that variation in innate, or “initial,” sensitivity to smoking or nicotine is associated with risk of nicotine dependence will be examined in this subsection. Endophenotypes that may tap initial sensitivity to nicotine will

be considered, with substantial attention paid to the practical problems in conducting such research. Owing to a lack of research, one aspect of this model of variability in initial nicotine sensitivity will not be examined, specifically that these individuals rapidly become tolerant to nicotine’s aversive effects, although the potential utility of studying this phenomenon will be discussed in the section “Discussion of Future Directions.” Also, unlike chapter 9, nonpharmacological effects of smoking,

such as conditioned responses to smoking cues (e.g., cue-induced craving), are not included here. The emergence of such conditioning requires extensive exposure to smoking, and the concern here is only with short-term or relatively immediate responses to “initial” (or early) exposure. Similarly, consequences of abstinence from smoking, notably onset of withdrawal symptoms, are not relevant here because these also arise only after extended exposure, as discussed elsewhere (chapters 3 and 9).

Measures of innate sensitivity to nicotine are subdivided here into two areas: (1) initial nicotine reinforcement and reward and (2) initial sensitivity to other effects of nicotine, mostly affective, behavioral, and cognitive performance measures that may help explain initial reinforcement and reward from nicotine use. Reinforcement is a central facet of the dependence process; the persistence of reinforcement from smoking is the hallmark of dependence once it is established. Reinforcement is necessary for smoking’s motivational effects to develop in a regular smoker and, thus, is proximal to processes of dependence. “Reward” is meant here to refer to the hedonic value (e.g., “liking”) of the drug as reported by the user and may reflect subjective responses to drug use that encourage the onset of drug reinforcement. Yet, *why* nicotine acquires motivational effects of being reinforcing and rewarding may also be important and may vary between individuals, perhaps because of genetic or constitutional factors. Other nicotine responses may help explain its reinforcing and rewarding influences and are therefore viewed as more distal to dependence processes. These responses include affective (mood) and physiological effects; behavioral effects related to attention (inattention, disinhibition), which may, in turn, help to regulate mood; and cognitive processing performance (e.g., alertness), which may have indirect effects on a sense of well-being. Note that this same organizational framework, involving two

broad areas of motivational effects and other smoking effects, is used in chapter 9 to evaluate potential endophenotypes of dependence in chronic smokers.

For the measures of nicotine reinforcement, reward, and mood effects, the information is sufficient to address, if not draw conclusions on, some or all of the criteria of a putative endophenotype for nicotine dependence (e.g., biological plausibility, predictive validity, heritability or a sufficiently broad distribution of responses to the measure in the population, and reliable measurement). These criteria are relevant to the utility of these measures in research on the genetic determinants of nicotine-dependence risk, and all need to be demonstrated to verify that the measure is a likely endophenotype. For example, some measures may have a strong rationale for relevance to dependence, and some evidence linking them to dependence, but no evidence on heritability or reliability. For others, heritability and reliability may be strong, but their link to dependence risk may be unknown. In either case, the missing information seriously limits the utility of the measure in genetic research on vulnerability to nicotine dependence. A subsequent discussion will point out the additional research needed to fill in these gaps and fully evaluate these measures as endophenotypes for vulnerability to nicotine dependence.

General Methodological Concerns with Innate Sensitivity Research

Several concerns that limit the interpretation of results of research in this area need to be kept in mind. First, what constitutes “initial” exposure is not necessarily clear. Ideally, “initial” should be only that exposure to tobacco occurring before the onset of chronic changes in sensitivity to nicotine due to extended

tobacco use. The most common changes are chronic tolerance, or reduction in sensitivity, and the onset of withdrawal in the absence of nicotine, which also can influence responses to nicotine, as discussed to a greater extent in chapter 9. How much exposure is needed to precipitate these changes is not known, but it may be very modest.^{268,271} It is probably fewer than 100 cigarettes, which is the standard cutoff of exposure that differentiates never smokers from ever smokers in epidemiological research.²⁷² How many fewer is uncertain. Much of the research on adolescents does not specify the amount of tobacco exposure that individuals have had. However, some research on initial sensitivity in young adults has limited such exposure to fewer than about a dozen lifetime uses of tobacco products.²⁷³

Second, the most rigorous method of assessing initial sensitivity is prospectively, such as by administering nicotine to naive subjects, ideally young adolescents, to simulate “initial exposure.” This is problematic, however, for obvious ethical reasons, so most of the research on adolescent responses to smoking is retrospective self-report. In some studies, the self-report of adolescent responses is assessed when these individuals have become adults, years after the initial smoking exposure, increasing the potential for poor or biased recall. Asking adolescents who recently initiated smoking to recall their responses to initial smoking just one year later does not appear to reduce the problem of decay in recall accuracy.²⁷⁴ Adolescents are also inconsistent in recall of a fact that should be much easier to remember, the age at which they initiated smoking,²⁷⁵ causing further concern about the reliability of retrospective data on smoking. Similarly, participants may recall responses to a particularly salient adolescent smoking experience but not “initial” exposure. A later study examining prospective nicotine effects as a function of

retrospective self-report of early smoking experiences in young adult nonsmokers suggests some validity for self-report of two similar effects—dizzy and buzzed—but less so for other effects.²⁷⁶

Third, differences in sensitivity to initial smoking exposure cannot be easily interpreted without control over the amount of nicotine exposure, or “dose.” However, the “dose” of this exposure is not controlled: some adolescents will self-administer significant amounts of nicotine from initial smoking, and others may not inhale sufficiently to obtain much nicotine upon first exposure. Variation in responses to nicotine due to *variation in self-dosing* has far different biological implications than does variation in responses to the same nicotine dose due to *variation in tissue sensitivity* to nicotine. Retrospective reports cannot distinguish between these potential causes of variability in apparent sensitivity. A similar concern is lack of control over the context of initial smoking exposure. Responses, and thus sensitivity, may vary as a function of situational factors (e.g., other drug use, social factors, mood), which are uncontrolled in initial smoking exposure of adolescents.

Fourth, a strategy used to get around the problems inherent in retrospective self-report could be to administer nicotine via novel methods (i.e., other than smoking, such as by nicotine gum, patch, or spray) to young adults with little or no prior tobacco exposure. This approach allows for controlled exposure to nicotine in young individuals who have not become tolerant, and would truly reflect initial sensitivity, without the abuse liability of smoking. One concern with this approach is whether responses to novel nicotine generalize to responses to initial tobacco smoking. A second concern is whether differences among individuals in nicotine sensitivity “track,” or persist unaltered, from youth to adulthood. If not, genetic

factors responsible for variability in initial sensitivity among adults may not relate to sensitivity among youth.

Finally, assessing initial sensitivity requires participants who are willing to be exposed to nicotine through self-selected experimentation with tobacco or self-selected exposure through research. It is not clear if results would generalize to individuals who choose to avoid any exposure to nicotine, even for research purposes. Thus, individual variability in sensitivity to nicotine responses may not generalize to all naive individuals at risk. (Note that “initial” exposure is not considered here to include in utero exposure to smoking or nicotine, and this influence on risk of nicotine dependence will not be examined.²⁷⁷)

Initial Sensitivity to Smoking or Nicotine: Reinforcement

Reinforcement

A drug is reinforcing if it is self-administered more than an inert comparison substance (e.g., placebo). Drug reinforcement is the sine qua non of dependence in that dependence on a substance cannot occur if the substance is not reinforcing. Thus, the magnitude of the reinforcing effects of nicotine upon initial exposure likely contributes to a greater probability and faster speed of becoming dependent. As discussed in more detail in chapter 9, reinforcement is believed to comprise several related concepts (e.g., drug seeking or drug-motivated behavior, drug preference, inability to abstain from drug use or persistence of use) that are assessed with different procedures. The amount and persistence of smoking self-administration are critical indices of nicotine dependence among those who have become established smokers, after chronic exposure to smoking. With initial exposure to nicotine, however,

these measures are not as applicable because intake is very limited in frequency, by definition. Most of these procedures are not included here because they are less relevant during initial exposure. (Similarly, the influence of nicotine on enhancing reinforcement from other reinforcers may not be very apparent with initial exposure to the drug and is also not discussed here, although it is addressed in chapter 9.) Possible measures of initial reinforcement outside the laboratory are shorter intervals between smoking exposures and the amount of cigarette consumption (e.g., nicotine or smoke intake) per exposure. However, objective measurement of these variables is difficult, necessitating self-report. An alternative laboratory-based procedure, nicotine choice, may be able to objectively index initial reinforcement from nicotine per se and will receive the most specific attention because of its promise as an endophenotype. Other potential endophenotype measures will also be noted.

Biological Plausibility of Reinforcement Measures

A number of species acquire robust nicotine self-administration that persists in the face of increased response requirements, and abstinence from nicotine in such animals leads to a syndrome of withdrawal signs.²⁷⁸ Although nicotine self-administration in nonhuman animals may not be completely homologous with tobacco, or even nicotine, self-administration in humans, the similarity of factors that influence this behavior in both groups is notable.²⁷⁸ In regard to initial sensitivity to nicotine reinforcement, Donny and colleagues²⁷⁹ found in rodents that more rapid acquisition of nicotine self-administration across days predicted a greater subsequent intensity of nicotine-motivated behavior (higher breakpoint on the progressive ratio test), a component of reinforcement related to dependence. The difference in self-administration was very small at the start of acquisition

(i.e., “initial exposure”) but grew over time. In examining neurobiological differences between the animals who rapidly, as compared to slowly, acquired nicotine self-administration, Donny and colleagues²⁷⁹ found that the former tended to be those with less density of nicotine receptors in the brain by the end of acquisition. Thus, certainly in animals and probably in humans,¹⁶¹ onset of nicotine reinforcement can occur very early after first exposure, and the subsequent escalation of use varies significantly. However, the findings by Donny and colleagues²⁷⁹ question whether the former directly causes the latter; that is, that differences upon initial exposure are robustly predictive of the rate of onset of dependence.

Other factors associated with the acquisition of nicotine self-administration in animals are also being examined. Differences in nicotine reinforcement between rodent strains are discussed extensively in chapter 9. In addition, rats bred for high alcohol consumption tend to show greater acquisition and persistence of nicotine self-administration, suggesting overlap in the factors producing vulnerability to alcohol and nicotine dependence.²⁸⁰ Greater locomotor response to novelty has been studied as an indicator of greater predisposition to self-administer stimulant drugs,²⁸¹ several studies have found an association between this response and greater acquisition of nicotine self-administration in rats²⁸² as well as in mice.²⁸³

Nicotine Choice

Description and Rationale of Measure.

The amount of smoking frequency upon initial exposure has high face validity as a measure of reinforcement in that the measure involves tobacco smoking behavior. However, this measure does not differentiate whether the frequency is due to the effects of nicotine per se or to effects of nonnicotine aspects of smoking. Although conditioned responses to smoking are essentially absent at initial exposure, as noted, various other

nonnicotine aspects of smoking can promote acute smoking frequency, such as social facilitation (e.g., peer approval). Dependence is driven mostly by the effects of nicotine, and genetic influences on smoking are believed to act primarily through these effects. Consequently, when it comes to endophenotypes of initial sensitivity, the reinforcing effects of nicotine per se may be more relevant than the reinforcing effects of tobacco smoking in general, although kinetics of the method of nicotine administration (particularly speed of uptake) could be critical.²⁸⁴

One objective measure of initial sensitivity to the reinforcing effects of nicotine in prospective laboratory-based research is a *choice* procedure, involving choice between substances containing either active nicotine or a placebo.^{285,286} Subjects are instructed to select a specific number of total “uses” (e.g., puffs or, with naive individuals, units of a novel nicotine-delivery method such as nasal spray or piece of gum) from between the two available substances. The greater the choice of active drug versus placebo, presumably the more the drug is reinforcing. A discussion of the pros and cons of this procedure can be found in Perkins.²⁸⁷ Thus, the choice procedure indexes the relative reinforcing effects of nicotine and not necessarily the absolute reinforcing effects. (The latter is shown only when nicotine is chosen more often than placebo, which is not common in nicotine-naive subjects.) So, if nicotine choice is greater in some subjects or under some conditions rather than others, the relative reinforcing effects of nicotine are greater in those subjects or conditions. Variations in the choice procedure, including those more appropriate for use in chronic smokers, are described in chapter 9.

Association with Nicotine Dependence.

Most research on nicotine choice has focused on smokers rather than nonsmokers, but observations of smokers suggest a link

between choice behavior and dependence. For example, among smokers, acute nicotine choice behavior in the laboratory is correlated with self-reported cigarettes per day²⁸⁵ and with difficulty quitting smoking,²⁸⁸ suggesting that choice has concurrent validity in indexing several aspects of tobacco dependence (chapter 9). Studies of initial sensitivity to nicotine reinforcement in young adult nonsmokers indicate that nicotine choice is not greater than placebo choice, whether administered by nasal spray²⁸⁵ or gum.²⁸⁹ However, of greater interest here is the fact that nonsmokers differ very widely in the degree to which they choose nicotine, and a minority of nonsmokers do choose nicotine more than a placebo. Greater choice of nicotine in nonsmokers (and, to a lesser extent, in smokers and former smokers) is associated with greater pleasurable responses (pleasant effects, vigor, arousal) and attenuated aversive responses (e.g., tension, fatigue, confusion) to nicotine.²⁸⁵ On the other hand, several individual-difference characteristics, including personality measures of impulsivity (response disinhibition, delay discounting), are not related to nicotine choice (via nasal spray) in nonsmokers, while other measures (novelty seeking, extraversion) may be inversely related to choice, particularly in women.²⁹⁰ These findings, which contrast with the discussion of predisposing factors in the first section of the chapter, may be specific to nicotine choice via nasal spray and require replication with tobacco smoking, if practical and ethical to do with naive subjects. However, associations of sensation seeking and other impulsivity measures with nicotine “reward” and with certain subjective mood responses to nicotine have been observed, as discussed below. In sum, while nicotine choice has been investigated in nonsmokers, and can provide an objective index of sensitivity to initial reinforcement, no research has prospectively determined that greater nicotine choice predicts greater vulnerability to dependence.

Heritability; Distribution of Responses in the Population. The full range of possible nicotine choice responses has been observed, from zero to 100%, in nonsmokers, when nasal spray is the delivery method. Dose is a key influence on this distribution, as choice of nicotine in nonsmokers is greater with lower doses, which produce less toxicity in naive individuals. When choice is between sprays delivering the equivalent of nicotine from about one-half puff on a cigarette, nicotine is chosen on about 25%–35% of all opportunities, and 15%–25% of adult nonsmokers choose nicotine over one-half the time.²⁹⁰ That even a minority of nonsmokers find nicotine via nasal spray reinforcing in an absolute sense is consistent with the notion of innate predisposition to dependence vulnerability. It is also consistent with other data showing that only a minority, about one-third, of those who ever try tobacco go on to become dependent.²⁶³ This one-third likely includes many of the naive individuals who find nicotine reinforcing at first exposure. Dose may also be critical for identifying individual differences in initial sensitivity to nicotine reinforcement in that nicotine choice is greater in men than in women when higher doses (2.5 micrograms per kilogram [$\mu\text{g}/\text{kg}$]) of nicotine spray are used,²⁹¹ but not when lower doses (1.25 $\mu\text{g}/\text{kg}$) are used.²⁹² Only one study has examined genetic influences on nicotine choice among nonsmokers, finding that those with an absence of the *DRD4**7-repeat allele chose nicotine by nasal spray more than those with presence of the *7-repeat allele; gene variants for *DRD2***TAQIA*, *DRD2***C957T* single nucleotide polymorphism (SNP) *SLC6A3*, serotonin transporter (*SLC6A4*), and mu opioid receptor (*OPRM1*) were not related to nicotine choice.²⁹³

Other Potential Endophenotypes of Initial Reinforcement

Smoking/Nicotine Use Frequency. Little research has examined smoking frequency upon initial exposure, although some

evidence suggests that greater frequency may predict vulnerability to dependence. One prospective follow-up study examined the risk of current smoking in high school as a function of amount of smoking exposure reported when participants were aged 8–10 years. Greater number of cigarettes smoked by that age was linearly associated with greater risk of current daily smoking.²⁹⁴ Yet, this effect may simply be due to younger age of first exposure in that those who smoked more cigarettes by 10 years of age likely smoked their first one earlier than did children who smoked fewer. In terms of potential endophenotypic measures of smoking frequency, a laboratory procedure that may reflect reinforcement as indexed by smoking frequency is simple ad lib use of either nicotine or placebo products in a controlled setting.²⁸⁹ The utility of this ad lib nicotine reinforcement measure as an endophenotype is limited: there are no known data on reliability or heritability in naive individuals, and some research suggests that ad lib use of nicotine via novel means is very limited in such individuals.²⁸⁹

Latency to Subsequent Nicotine Exposure.

Rather than greater frequency of self-administration upon initial exposure being important, it may be that faster escalation of smoking after initial exposure is a more relevant index of nicotine-dependence vulnerability,²⁹⁵ as suggested by the animal work by Donny and colleagues.²⁷⁹ For example, Hirschman and colleagues²⁹⁶ found that latency between the first and second cigarette was an important indicator for adolescents who rapidly progressed to subsequent smoking. In fact, early smoking experiences accounted for significant variance in the model for rapid acceleration, but not for adolescents who progressed slowly to a second cigarette. Other studies indicate that a shorter interval between the first and second cigarette is associated with a greater likelihood of daily smoking.²⁹⁷ Shorter transition times from initiation to regular use are thought to reflect drug reinforcement

and risk for dependence, including tobacco.²⁹⁸ In fact, Audrain-McGovern and colleagues²¹ found that adolescents who had a *CYP2A6* genotype associated with faster nicotine metabolism smoked a greater number of cigarettes and progressed to nicotine dependence at a faster rate (controlling for age of first smoking exposure) compared to adolescents who had a *CYP2A6* genotype associated with slower nicotine metabolism. Development of endophenotype measures of latency between self-administration experiences is challenging because of a variety of practical and ethical concerns. Latency between cigarettes may be very long in experimenting adolescents, so modeling this latency in laboratory procedures would seem impractical.

Age of Onset. As discussed previously, the younger the age of smoking initiation, the greater the probability of eventual nicotine dependence. Age of initial smoking exposure appears to increase subsequent dependence risk even if no further exposure occurs for several years,²⁹⁹ suggesting either an “incubation” effect of that initial exposure or that early exposure is a marker for other factors responsible for vulnerability. Basic animal research demonstrates that rodents are more sensitive to nicotine effects during adolescence than in adulthood, consistent with this notion.³⁰⁰ Thus, the earlier the initial exposure to nicotine, the greater the likely sensitivity to the drug, which may account for the increased risk of dependence. At first glance, this association would not seem to offer directions for developing an endophenotypic measure because it is based solely on the age of self-selection to smoking initiation. It is difficult to see how this could be captured in controlled research involving nicotine administration in a laboratory setting, but it may serve as a marker in prospective research predicting smoking progression and nicotine dependence. However, genetic influences may differ by age,⁴ and eventually, age of onset may be a clue to genetic effects.

To take advantage of this, investigations would have to disentangle the influence of age of onset on greater smoking frequency²⁹⁴ and on faster escalation of smoking.²⁹⁸ Research also would have to control for psychiatric comorbidity that partially may account for early onset.¹⁴³

Initial Sensitivity to Smoking or Nicotine: Reward

Description and Rationale of Reward Measures

Although reinforcement is in many respects the essence of dependence, other acute effects of smoking or nicotine may index processes relevant to the development of dependence and vulnerability to dependence. Drug reward is one such effect. *Reward* does not have as specific a definition as reinforcement but is often viewed as the hedonic value of a substance. In this context, *hedonic* means the subjective evaluation of the substance's incentive-motivating effects (see Everitt and Robbins³⁰¹ for a discussion of the distinctions among subjective responses, reward, and reinforcement). Rewarding effects of drugs are often seen as a primary cause for the initiation and maintenance of drug self-administration (reinforcement), although some theories question their importance after the onset of dependence.³⁰² Reward is different from subjective measures of mood, discussed later, which are commonly obtained in studies of drug effects. Mood measures are (typically) self-report ratings of the subjective mood state of the person. By contrast, reward is a subjective rating of the hedonic characteristics of the substance itself, albeit from the user's perspective, obtained immediately after using the substance. Thus, while mood effects of substance use may influence reward (and reinforcement), they are certainly not the same thing. As with reinforcement, reward can only be measured concomitant with actual substance

use, while the subjective mood state of the user can be assessed at any time, even in the absence of the subject ever using the substance. Typical measures relevant to reward in humans are ratings of "liking," "good effects," or "bad effects" of the substance completed on 7-point Likert or visual analog scales. The extreme-response options for each item may be anchored by "not at all" to "extremely." Little research has documented the reliability of such responses to initial nicotine intake, although research in adult smokers suggests good reliability, as noted in chapter 9.

Biological Plausibility of Reward Measures

Neurobiological changes associated with "liking" and other reward measures in humans have not been extensively studied, and there does not appear to be any such research in naive subjects (i.e., initial exposure). However, research assessing reward via retrospective self-report suggests that greater initial smoking reward is associated with greater risk of dependence. One study of several thousand adults found that 94% of those who reported having liked their early exposures to smoking progressed to smoking at least 100 cigarettes in their lifetime (the standard epidemiological definition of a lifetime smoker) compared to only 57% of those who reported no liking of their early exposures to smoking.³⁰³

Because animals cannot provide self-report ratings, there may be no directly homologous measure of reward in animals. However, two measures that may be used to model reward are the conditioned place preference (CPP) procedure and intracranial self-stimulation (ICSS) procedure. In the CPP procedure, animals are placed in distinctive environmental contexts (e.g., different sides of a partitioned box) after receiving injection of either drug or saline, with each paired to one of the contexts. After several pairings of each,

the animal is then tested for preference for one or the other context by the amount of time it spends in each when allowed to move freely between them. Greater time spent in the drug-paired side is believed to index preference for the drug (versus saline), while less time spent in the drug-paired side is believed to index aversion to the drug. The ICSS measures the intensity of electrical stimulation in the brain required to maintain behavior, similar to drug self-administration paradigms in animals. Drugs or other conditions that increase the intensity of stimulation necessary to maintain behavior appear to be aversive, whereas drugs or conditions that decrease this intensity appear to be pleasurable. Most drugs that produce dependence in humans, including nicotine, decrease the intensity of stimulation required to maintain responding. The CPP and the ICSS are discussed more extensively in chapter 9.

Association of Reward Measures with Nicotine Dependence

Very little research has examined factors associated with greater nicotine or smoking reward in humans upon initial exposure. However, greater pleasurable responses to initial nicotine spray (such as vigor and pleasant effects) were found to predict greater subsequent nicotine choice in nonsmokers.²⁸⁵ Also, smokers report greater “liking” in response to nicotine nasal spray, compared to nonsmokers, showing concurrent validity of reward with dependence.²⁷³ It is unclear if other research exists relating rewarding effects of initial nicotine or smoking exposure to dependence vulnerability.

Heritability; Distribution in the Population

The limited research on initial sensitivity to nicotine reward precludes much information on variability in this response.

However, in a study of individual differences in nicotine sensitivity in 131 young adult (aged 21–39 years) nonsmokers administered nicotine via nasal spray, reward ratings (want more, satisfying) were higher in men, but not in women, as a function of novelty seeking.²⁹³ Genetic variants related to dopamine function were largely unrelated to reward in nonsmokers, although *DRD2*395T* SNP (*TT* or *CT* versus *CC* genotype) and *DRD4* (presence of *7-repeat allele versus absence) were associated with stronger perception of nicotine effects from the spray.²⁹³ Other analyses showed greater responses on some reward ratings in those with two rather than one or no parents who were smokers and as a function of earlier experience with marijuana.²⁹² Existing levels of caffeine or alcohol use were unrelated to nicotine reward. These findings should be interpreted with caution; they were conducted with young adults who had self-selected to nonsmoking status, and results with a more heterogeneous sample including those at greater risk could show different results.

Initial Sensitivity to Other Responses to Nicotine

Other responses to initial nicotine exposure may also provide information about valid endophenotypes related to dependence risk, especially effects that relate to affective regulation. Other effects that could be relevant but have generally not been studied in naive users will be very briefly noted. These include behavioral effects related to attention and impulsivity as well as cognitive-processing performance after initial nicotine exposure. The same concerns about the limitations of research on initial exposure presented earlier apply to studies of sensitivity to these responses.

Affective/Mood Responses

Most of the research in this area of other responses to nicotine as potential endophenotypes focuses on self-reported

mood (affective) responses to smoking or nicotine. Yet, as discussed in chapter 9, mood is believed to comprise effects measurable across several response domains, including physiological, behavioral, and cognitive. Studies limited to self-report likely fail to adequately characterize mood and the endophenotypes of initial sensitivity to nicotine's mood effects.

Biological Plausibility

Some self-reported mood effects of smoking (“euphoria” and “elation,” which may be similar to “head rush or buzzed”) in smokers have been related to dopamine release in the striatum.³⁰⁴ Increases in dopamine in the striatum and ventral tegmentum are believed to be critical to nicotine reinforcement.³⁰⁵ This is consistent with effects in the approach system described earlier and would be expected to make rewards more salient and satisfying. This would also enhance attentional focus, leading to a potential cascade of reinforcing effects. It was also noted in the first part of this chapter that mood-related factors may bias attention toward drug-related relief and influence dependence onset. However, these effects may be even more powerful in maintaining smoking after the onset of dependence (chapter 9).

Plausibility also comes from clinical or retrospective reports of mood effects from initial smoking. In several studies, adults who were current smokers retrospectively reported having had greater pleasant sensations and “head rush” or “buzz” the first time they ever smoked compared to adults who were currently nonsmokers but had some smoking exposure.³⁰⁶ Adult smokers also tend to report having had equal or fewer unpleasant responses to their first cigarette, suggesting that greater pleasant effects are important and lesser (or greater) unpleasant effects are not as important. In one study, Pomerleau and colleagues³⁰⁷ reversed the direction of the comparison and examined current smoking

amounts in adults as a function of whether they reported retrospectively that they did or did not experience a “pleasurable rush or buzz” during their first cigarette. Those who said “yes” (i.e., they did experience rush or buzz during their first cigarette as an adolescent) currently smoked more cigarettes per day than those who said “no.” Interestingly, those who said “yes” also reported greater “pleasurable buzz” and “euphoric sensations” prospectively in response to acute administration with nicotine nasal spray, suggesting a continued greater sensitivity to one effect of nicotine even after the onset of tolerance due to chronic smoking.

Note that the association between pleasurable responses to early use and subsequent dependence may not be specific to smoking. Greater positive mood responses, but few or no negative responses, to early use of cannabis³⁰⁸ and cocaine³⁰⁹ have been associated with greater indices of dependence to these drugs. Thus, greater mood effects of early drug use may be broadly linked to vulnerability to drug dependence. This research and the studies of smoking responses should be viewed cautiously, given the biases inherent in retrospective recall of drug-use experiences.

Examined next will be research on sensitivity to initial mood effects of smoking assessed by retrospective clinical reports in adolescents varying in amount of current smoking. We will also discuss the few prospective laboratory-based studies of responses to smoking or nicotine in those believed to vary in risk of dependence.

Acute Self-Reported Mood Effects

Description of Self-Reported Mood

Measures. Self-reported mood is assessed with a number of validated measures. Common mood measures assessed in acute smoking or nicotine studies include the Positive and Negative Affect Schedule,³¹⁰ the Mood Form of Diener

and Emmons,³¹¹ and the Profile of Mood States.³¹² The measures and results from studies of acute mood effects of nicotine or smoking administration are presented in Kalman.³¹³ The reliability of these responses to nicotine is very high in both smokers and nonsmokers via nasal spray³¹⁴ and probably via other controlled methods of administration. Assessment of acute mood effects of smoking and nicotine in the laboratory, including the use of measures other than self-report, is discussed more extensively in chapter 9.

As noted above in outlining plausibility, some studies have related self-reported mood effects of initial smoking to risk of dependence by studying adult smokers recalling their experience upon smoking their first cigarette. Most of these studies were done by Pomerleau and colleagues with their self-report measure, the Early Smoking Experiences (ESE) scale.³¹⁵ The responses to smoking include nicotine-related effects of “pleasant sensations,” “unpleasant sensations,” “nausea,” “relaxation,” “dizziness,” and “pleasurable rush or buzz,” and two effects specific to smoke inhalation, “coughing,” and “difficulty inhaling.” Each is rated on a 4-point Likert scale from “none” to “intense,” with a fifth option of “don’t remember.” Unfortunately, test-retest reliability of recall of initial smoking experiences assessed in adolescents a year apart is quite low,²⁷⁴ despite the relative recency of those experiences. Research in adults suggests that the reliability of responses two years apart may be satisfactory if response options are dichotomized (i.e., yes/no, rather than a 4-point scale³¹⁶). However, the ESE may have limited validity, as just two (dizziness, pleasurable rush or buzz) of the six items retrospectively assessing pharmacological effects of smoking predicted prospectively assessed nicotine nasal spray effects on those same items in young adult nonsmokers,²⁷⁶ although comparing nicotine administration via the same method would provide a stronger test of validity.

Association with Dependence Risk. There appears to be no prospective research relating acute mood responses to nicotine in nonsmokers to indices of dependence risk. However, a number of studies of recall of recent smoking experiences in adolescents or young adults demonstrate some association between sensitivity to these mood effects and dependence. The potential advantage here over the retrospective studies in adults noted previously is that the recall of experience with initial smoking may be more reliable since less time has passed. In two studies of adolescents, recall of being “relaxed” in response to their first cigarette was strongly associated with subsequent onset of dependence, as defined by smoking at least monthly¹⁶¹ or weekly.²⁷⁴

In perhaps the most rigorous study of this kind in smoking, Hu and colleagues³¹⁷ reinterviewed 15,000 young adults (mean age of 22 years) who had been included in earlier national surveys of adolescent health. Retrospective reports of greater pleasant effects and dizziness (related to “head rush”) but lesser unpleasant effects from initial smoking increased the risk of progressing to daily smoking in those who had ever been exposed. Pleasant effects, but not dizziness or other unpleasant effects, were also associated with greater risk of transition to dependence among those who ever smoked daily. However, persistence of smoking (i.e., failure to quit) among those who were ever dependent was weakly related to lesser, not greater, pleasant and unpleasant effects from initial smoking. Thus, greater initial sensitivity to pleasant effects of smoking may influence the early progression to daily smoking and onset of dependence but is less important in explaining persistence of smoking once dependence is established. This observation perhaps further exemplifies the difference in factors promoting onset versus persistence of dependence, as represented in this chapter and chapter 9, respectively.

Several older cross-sectional studies compared reports from early smoking in adolescents with minimal lifetime exposure (just a few cigarettes) compared to those with greater exposure. Those adolescents who were currently smoking to a greater degree reported having experienced greater pleasurable effects (e.g., “feeling high”) and fewer aversive effects (e.g., “feeling sick”) at their initial exposure to smoking than did adolescents with little current smoking (see review in Eissenberg and Balster).³¹⁸ Similarly, among adolescents who smoked, reports of greater “relaxed,” “high,” and “dizziness” (similar to “rush or buzz”) and lower “cough” from first cigarette were associated with faster escalation of smoking, while other aversive effects had no association.^{296,319} Interestingly, similar findings were reported in a study of Chinese 10th graders, demonstrating cross-cultural consistency in the relationship between pleasurable responses to initial smoking and subsequent smoking escalation.³²⁰

One study tested whether pleasant or unpleasant initial smoking experience mediated the relationship between the *CYP2A6* genotype (genetic variation in nicotine metabolic inactivation) and nicotine dependence. *CYP2A6* did not have a significant effect on either pleasant or unpleasant initial smoking experience, negating the possibility of mediation.²¹ These initial smoking experiences may not account for the relationship between *CYP2A6* genetic variation and emergence of nicotine dependence, or the mediated relationship is more complex than modeled. Likewise, adolescents might not view the initial experience as positive or negative, and/or the initial experience may be modified by the presence of other smokers and other substances, such as alcohol or marijuana.³²¹ Consistent with these findings, O’Loughlin and colleagues²² did not find that initial smoking experiences mediated the effect between *CYP2A6* and the odds of becoming nicotine dependent. The role of initial

positive and negative smoking experiences in subsequent smoking warrants further attention. Methodological issues surrounding prospectively measuring initial reactions to nicotine and a lack of attention to the impact of contextual factors may be disguising important relationships. In addition, heterogeneity in the initial responses to nicotine may be hidden by evaluating the average response of the sample rather than accounting for interindividual variation. Some responses (e.g., “head rush,” “buzz”) may be more discriminatory than others (e.g., “dizziness”).³²²

Finally, some research has examined concurrent association between mood responses to nicotine and self-administration by using young adult nonsmokers to simulate adolescents experimenting with smoking. This approach ensures that responses to nicotine in subjects are “initial.” Nicotine is administered via novel means, such as nasal spray, patch, or gum. Using this approach, associations were found between pleasurable mood responses to nicotine via nasal spray and subsequent choice of nicotine in nonsmokers as well as in smokers,²⁸⁵ suggesting that these mood responses are related to nicotine’s reinforcing effects and, perhaps, risk of dependence.

Heritability; Population Distribution of Acute Self-Report Mood Response to Initial Smoking

A prospective study of young adult nonsmokers found greater aversive mood responses to nicotine via nasal spray, such as decreases in vigor and positive affect (but greater buzz) among those with the *DRD4**7-repeat allele compared to those without the *7-repeat allele.²⁹³ Other genes (*DRD2***TAQIA*, *DRD2***C957T*, serotonin transporter, dopamine transporter, *OPRM1*) were not clearly related to acute mood responses to nicotine. The neuronal nicotinic acetylcholine receptors

CHRNA2,³²³ *CHRNA3*³²⁴ and *CHRNA5*³⁴ have been related to several retrospective ratings of initial smoking responses in young adults (dizziness, buzz or rush, relaxed). Regarding impulsivity factors, aspects of the sensation-seeking personality, which is associated with risk of nicotine and other drug dependence (see earlier sections of this chapter), have been found to be related to greater sensitivity to subjective mood responses to nicotine via nasal spray in young adult never smokers.³²⁵ Specifically, Sensation Seeking Scale subscales of experience-seeking and disinhibition were associated with mostly pleasurable effects of nicotine (pleasant effects, head rush, vigor, and arousal), but also some aversive responses (tension, confusion). However, a subsequent, larger study related impulsivity and other factors associated with dependence risk to nicotine sensitivity in young adult nonsmokers²⁹⁰ and found only modest associations between one impulsivity factor—response disinhibition—and acute mood responses to nicotine (greater increases in anger and stimulated, blunted decrease in relaxation). History of other drug use and parental smoking history are unrelated to mood effects of nicotine via nasal spray.²⁹²

Mood effects of nicotine patch on nonsmoking adults appear to also vary as a function of “trait hostility,” another personality factor associated with greater risk of nicotine dependence in addition to its potential effects on onset, as noted earlier. Jamner and colleagues²¹⁵ found that nicotine, compared to placebo patch, prospectively decreased self-reported anger more among those high versus low in trait hostility. Notably, the same results were observed in smokers, suggesting that this association of trait hostility with anger reduction from nicotine does not moderate with chronic smoking exposure. High trait hostility was associated with high frequency of anger during placebo, suggesting that nicotine’s effects may be more pronounced in those with extreme baseline levels of response,

as has been found with other research on mood and behavioral responses to nicotine.³²⁶ Similar to this observation, animal research shows that nicotine attenuates startle response, a physiological measure associated with mood, to a greater degree in those with larger baseline startle magnitude.³²⁷

Physiological Indices of Affect

Description of Physiological Measures

of Affect. Mood is most commonly assessed via self-report measures, but some physiological responses related to affect include cardiovascular effects and startle response; several of these were outlined earlier and are listed in table 8.1. These same markers can be used to evaluate response to smoking as well as vulnerability to onset. Cardiac measures in this context (e.g., reward responsivity) are complicated by the fact that nicotine increases cardiovascular responses. However, it does not appear to modulate the effects of other influences on cardiovascular responses, such as acute environmental challenges.³²⁸ An alternative approach is to examine physiological startle—that is, the intensity of the eyeblink response to a sudden stimulus such as a sharp loud noise or electrical stimulation. The neurobiological significance of startle is discussed in chapter 9. Briefly, the magnitude of startle response is associated with the degree of negative affect reported by the person, and so, may index the negative affective limbic circuitry outlined earlier. Smoking and nicotine do not clearly alter startle response in dependent smokers or in nonsmokers,³²⁹ although some evidence indicates that nicotine attenuates startle in animals,³²⁷ as measured by whole-body startle response to the stimulus. However, nicotine influences the related measure of prepulse inhibition of startle, which is considered a measure of sensory processing rather than affect, and is discussed later. Regarding other physiological indices of affect, it has been noted earlier that electrodermal (skin conductance) and

electromyographic (muscle tension) measures are commonly obtained in studies of affective regulation, but few studies have examined responses to smoking or nicotine, and none (as far as is known) in nonsmokers administered nicotine.

Association with Dependence Risk.

There appears to be no evidence relating physiological indices of mood responses to nicotine to subsequent risk of nicotine dependence.

Heritability; Distribution of Responses in the Population. Research shows that startle response to low dose, but not moderate dose, nasal spray nicotine (i.e., curvilinear) was greater in those with the presence (versus absence) of the *DRD4*7*-repeat allele and in those with the *DRD2/ANKK1*CC* allele (versus **TC* or **TT* allele), but only among men and not women.²⁹³

Other Responses to Nicotine

No prospective studies have related onset of dependence to sensitivity to other responses to nicotine, likely for the same ethical and practical reasons noted above. Thus, this area will be only briefly noted. Effects of nicotine on these responses in chronic smokers are discussed in chapter 9. In addition, several of the variables listed below as important in the initial response to nicotine may also be considered factors that place an adolescent at risk for smoking initiation and subsequent progression. The description and rationale are outlined below for considering measures from various response domains as potential endophenotypes for risk of dependence.

Attention and Arousal. Smoking or nicotine typically helps prevent the deterioration in cognitive task performance over time in smokers, particularly when abstinent, but nonsmokers (i.e., testing of initial sensitivity to nicotine) have rarely been tested. However, in one interesting study,³³⁰ young adult nonsmokers were divided

into high- and low-baseline attention subgroups based on ADHD scales and given either a nicotine (7 milligrams [mg]) or placebo patch. Nicotine reduced errors of commission on the Conners' CPT in the low-baseline attention group, but impaired performance on another attention task, the Wisconsin Card Sorting Test, in the high-baseline attention subgroup. Thus, nicotine enhanced functioning only in those with weaker attentional control (and likely, lower arousal). As has been noted already, this characteristic is a risk factor for smoking onset; these data suggest it may be a risk factor that moderates a potential source of reinforcement from nicotine. This influence of nicotine as a function of baseline level of attention is consistent with results found in a few studies of mood, noted previously, and discussed elsewhere in greater detail.³²⁶

Electrophysiological Responses. As noted previously, startle response to a brief, loud tone assesses processes associated with affect. The degree to which startle is attenuated by a milder acoustic stimulus immediately preceding the tone is called prepulse inhibition (PPI) and indexes attention to sensory stimuli. Background on this measure is provided in detail in chapter 9. In one study of young adult nonsmokers administered low and moderate doses of nicotine via nasal spray,²⁹³ PPI tended to worsen (i.e., reduced inhibition of startle) in those with the *DRD2*C957T CT* (versus *TT* or *CC*) genotype (at the low dose only), with the absence of the *SLC6A3*9*-repeat allele, and with the *DRD2/ANKK1 CC* (versus *TT* or *CT*) genotype (at the moderate dose only). Other individual difference characteristics, such as other drug use history or parental smoking history, are unrelated to PPI response to nicotine spray in nonsmokers.²⁹²

Impulsivity Via Cognitive Control and Approach Measures. Acute effects of nicotine on impulsive behavior can be assessed via variations on the stop/go

task, which as noted earlier, is an index of the frontal-striatal output control circuit, or by delay discounting, which is likely an index of the approach circuitry described earlier. Research examining initial sensitivity to nicotine's effects on each (i.e., in nonsmokers) is limited, but a few studies support the notion that these effects may promote dependence. In one study, nonsmoking adolescents with ADHD had improved stop/go responding (less disinhibition) following transdermal nicotine (7 mg), relative to placebo.²⁰¹ Methylphenidate, the standard medication to treat ADHD symptoms, also improved stop/go responding.

Cognitive Control and Executive Functioning. Several studies have looked at nicotine effects on measures conceived as tapping the cognitive-control circuitry described earlier. Cognitive function measures used in nicotine research are described in more detail in chapter 9. In terms of nicotine's effects on cognitive functioning upon initial exposure (i.e., initial sensitivity), little research shows clear improvement in such functioning. Exceptions include improvements in simple psychomotor tasks such as finger-tapping speed, perhaps reflecting gains in cognitive control, alertness, or arousal.³³¹ Research is mixed in terms of the performance of nonsmokers on more complex tasks, such as choice-reaction time speed.³³¹ However, short-term memory recall has been shown to be improved in nonsmokers by 2 mg of nicotine gum,³³² a 5-mg patch,³³³ or a 1-mg injection.³³⁴ Yet, memory recognition and delayed recall are impaired by 4 mg of gum,³³⁵ perhaps suggesting a nonlinear dose effect of nicotine on memory in nonsmokers.

The Stroop interference task is a measure of rapid information processing and cognitive control in that a rapidly activated dominant response must be suppressed in preference to a slower-activated nondominant response, producing a "conflict."³³⁶ It involves

activation of the anterior cingulate cortex, which is involved in the cognitive-control loop.³³⁷ Nicotine (7-mg patch), but not methylphenidate, improved performance on the Stroop task by reducing this interference in adolescents with ADHD, who had poor baseline performance.²⁰¹ However, smoking did not affect Stroop interference in light-smoking adolescents without ADHD,³³⁸ suggesting that nicotine's effects may be more apparent as baseline performance worsens. This is consistent with findings noted previously with regard to the influence of baseline on the observed effects of nicotine.

Finally, the Sternberg memory task is another rapid information processing task that requires subjects to briefly memorize one or a string of five target letters and then respond as quickly as possible to a new series of letter pairs in a way that indicates whether the given letter pair did ("hits") or did not ("correct rejections") contain a target letter. The difference in reaction time in milliseconds between the one- and five-letter trials ("D-prime") on items requiring correct rejection (involving processing of all target letters) is the primary measure of memory scanning speed (information processing).³³⁹ Although some studies show no clear effects of nicotine via nasal spray on performance of this task in nonsmokers,^{290,340} complex dose-related associations between *DRD4* genotypes and performance have been reported in nonsmokers.²⁹³

Nicotine Responses Assessed by Neuroimaging. Perhaps the most intriguing potential endophenotypes for initial nicotine sensitivity are effects of the drug on neurobiological changes, such as those revealed in neuroimaging measures (e.g., brain metabolic changes via positron emission tomography [PET]; blood flow changes in brain regions via fMRI). As emphasized above, CNS probes of the major neural circuits involved in behavioral risk markers may be promising

as endophenotypes for risk of onset as well as for the reinforcing effects of nicotine exposure. These tactics may prove to be particularly important for evaluating nicotine's effects on the brain in adolescence.

As is increasingly recognized, adolescence is a period of dramatic and ongoing neural development, particularly in circuits involved in cognitive control (the top-down control circuits described earlier). These circuits mature via myelination and pruning into early adulthood, probably in experience-dependent fashion. Further, such maturation is certainly moderated by sex hormones that are a major factor in adolescent development. Thus, one crucial direction for endophenotypes of exposure response may entail looking at alterations in the trajectory of brain maturation in response to nicotine exposure. Other research on initial nicotine effects (i.e., in nonsmokers) suggests that greater brain metabolic responses via 2-fluoro-2-deoxy-D-glucose (or FDG) PET are seen as a function of the personality factor of hostility.²¹⁶ As in the naturalistic research by Jamner and colleagues,²¹⁵ noted previously, the influence of trait hostility on brain metabolism due to nicotine was observed in smokers as well as in nonsmokers.

Initial Nicotine Sensitivity Endophenotypes: Summary and Future Directions

Nicotine Reinforcement and Reward

Nicotine reinforcement is the key process involved in the onset of dependence. Assessment of reinforcement at initial nicotine exposure is difficult, owing to ethical and practical problems with exposing naive individuals, especially youth, to nicotine. Moreover, there is not much evidence that variability in the reinforcing effects of initial nicotine exposure predicts

vulnerability to dependence. One objective measure of initial nicotine reinforcement—choice of nicotine or placebo—shows some concurrent validity with dependence, but choice in naive subjects has not been related to dependence vulnerability. However, animal research suggests that differential nicotine reinforcement emerges relatively quickly across early exposures. Thus, the trajectory of escalation in reinforcement across early exposures, rather than reinforcement at initial exposure, may hold promise as an index of dependence vulnerability (chapter 5). Age of initial smoking exposure is a strong predictor of smoking escalation and persistence but may have limited utility as an endophenotype. Nicotine reward is readily measurable in naive subjects via self-report and has been related to some genetic factors and other individual difference characteristics, including novelty seeking. Retrospective research suggests that liking of initial smoking is associated with greater subsequent dependence. Further support for this link is needed. Animal research on CPP and ICSS provides some potential avenues for development of more objective measures related to nicotine reward in humans.

Mood Effects and Other Responses to Smoking

Retrospective studies show with some consistency that greater pleasurable responses to initial smoking experiences, especially feeling “relaxed,” are associated with greater subsequent risk of nicotine dependence, largely supporting the sensitivity model of dependence vulnerability. Aversive responses to initial smoking appear to be unrelated to dependence vulnerability. On the other hand, the few prospective studies of acute nicotine administration in nonsmokers do not show robust mood effects, particularly pleasurable effects. This inconsistency in findings could be due to either biases in

retrospective self-reports or to the different populations studied. The retrospective studies included those who became dependent smokers as well as those with less smoking history, while the prospective studies of initial sensitivity involve only those who remained nonsmokers. A third possibility is that the retrospective studies examine responses to smoking, while the prospective studies examine responses to novel methods of nicotine administration, which are often more aversive than is smoking.³⁴¹ These methodological difficulties need to be controlled to verify that initial sensitivity to mood effects of nicotine predicts dependence vulnerability. Regarding other measures of mood and other responses to nicotine, research is too limited to determine whether any of these may be related to dependence risk.

Assessment of all of these responses in adolescents and relating these prospectively to risk of nicotine dependence would appear to minimize most sources of bias. However, this approach raises considerable ethical concerns, especially in youth who have never previously been exposed to nicotine. An alternative that may be ethical is to prospectively assess responses to acute smoking or nicotine in adolescents who have already begun to smoke, although such exposure almost certainly would be well after their initial exposure. Longitudinal research surveying adolescents regarding their self-report responses to smoking in general is being conducted.³¹⁷ Intermittent assessment of such responses prospectively, in laboratory-controlled studies of acute smoking exposure, could reveal more reliable and objective changes in acute responses that predict subsequent escalation of smoking to dependence.³⁴² Yet, as previously noted, the progression to daily smoking is not necessarily gradual and can occur quickly,³⁴³ leaving only a very brief window of opportunity for assessment of these responses to early smoking exposure.

Discussion of Future Directions

Numerous potential measures have been discussed in this chapter that may relate to nicotine dependence risk at or before initial exposure to nicotine. This final section will review some of the key conceptual and methodological issues that may need to be considered in future work examining such measures to establish endophenotypes that may inform genetic research on nicotine dependence.

Conceptual Issues

This chapter began by outlining a multilevel-analysis perspective on key neural systems related to smoking initiation and progression risk and attempted to identify low-level experimental measures, which are presumably closer to gene action, that may serve as endophenotypes for future studies. Data on the criteria for determining the validity of a putative endophenotype, such as heritability, reliability, and predictive validity, are limited for many of these candidate measures. This groundwork will need to be laid before these endophenotypic measures can be fully evaluated. A few measures have promising preliminary characteristics and may warrant more aggressive examination in relation to smoking initiation and progression risk. For example, cognitive control is a biologically well-studied ability anchored in the striatum and orbital and dorsal regions of the prefrontal cortex. It can be indexed via component cognitive measures as well as ERP measures. The predictive validity for specific measures is promising (i.e., P300 amplitude). Its heritability needs more study, but particular configurations (e.g., latent variable measures of response inhibition or set shifting) and measures (e.g., the P300) have strong heritability and deserve particularly close attention. A key gap is the extent of the understanding of the phenotypic and bivariate genotypic

associations of these measures with smoking onset risk.

Somewhat surprisingly, important measures of approach-related processes, such as delay discounting, reward cue detection, and other indicators of functioning of neural systems in the nucleus accumbens, orbital prefrontal cortex, and related ascending mesolimbic dopaminergic systems are little investigated with regard to precursive risk for later cigarette-use onset. Although many of these measures are related to smoking, it remains unclear whether alterations in these functions are risk factors for smoking, risk factors for persistence, or the consequences of smoking. This is important because some potential factors are likely to be present and measurable before the onset of tobacco exposure, and other factors predisposing to dependence in youth may only be observable in response to initial nicotine exposure. Therefore, in the second part of this chapter, the discussion moved to a more molecular level of analysis and considered a pharmacological perspective. In doing so, the available literature was reviewed on the processes that occur in the early stages of nicotine exposure that may increase the likelihood of further exposure to nicotine and the progression to nicotine dependence. There is not much evidence to support the notion that the reinforcing effect of initial nicotine exposure predicts vulnerability to nicotine dependence. However, nicotine-choice paradigms and trajectory of escalation in reinforcement across early exposures both hold promise as an index of nicotine dependence vulnerability. In addition, initial findings on the link between nicotine reward and subsequent development of nicotine dependence suggests that more research of reward is warranted.

As this chapter focused on potential endophenotypes for (1) smoking initiation and progression to nicotine-dependence risk and (2) the response to that initial

nicotine exposure, it was assumed that genetic influences on these points are at least partially distinct. Although initiation is an obvious prerequisite for progression and then dependence to emerge, it is likely that risks for initiation substantially involve both the general substance-use pathway and a specific pathway involving nicotine, whereas drug-specific factors may predominate in the initial response to nicotine. It is important to note that numerous factors place an individual at risk for smoking initiation, progression to regular smoking, and to nicotine dependence.⁴¹ Thus, smoking occurs in a psychosocial context, of which nicotine availability is a necessary but not sufficient condition. In focusing on endophenotypes for genetic risk for nicotine dependence, it is acknowledged that environment plays a large role in who exposes themselves to nicotine via cigarette smoking and who continues irrespective of their initial smoking experience or their genetic susceptibility.

It is suggested here that both general and specific genetic risk factors have to be targeted via endophenotype studies. These genetic risk pathways are probably not completely independent of one another. Indeed, similar and unique neural circuitry may be involved in smoking initiation risk and in response to initial nicotine exposure. For example, reduction in reward may be particularly important as a reinforcer for initial nicotine exposure response, whereas breakdowns in cognitive control and attentional regulation may be crucial to smoking initiation and progression. Conversely, similar operations may be involved in both smoking initiation risk and initial nicotine exposure response. For instance, approach systems may contribute to an adolescent exploring nicotine use, and reactivity of that same system may contribute to reinforcing properties of nicotine upon exposure. As such, the discrete treatment of these nicotine-dependence phenotypes in this

chapter is heuristic. However, such analytic treatment may be necessary to identify mechanisms, and potential, unique genetic influences, at each inflection point.

It is important to note that the smoking initiation and progression risk variables have been framed through a neurobiological temperament model that permitted a multilevel analysis beginning with surface behavioral traits, and proceeding to lower-level laboratory measures as candidate endophenotypes, perhaps getting closer to gene action. Of course, whether or not something is “closer to the gene” is an empirical question. Some seemingly simple markers may in fact be genetically complex (e.g., it is not clear that “attention” as measured on a cognitive task is genetically simpler than nicotine dependence as measured in a structured interview). Here there is no claim to genetic simplicity for any of these candidates: each will require evaluation with respect to the criteria set forth to support the likelihood that a measure is an endophenotype. Likewise, temperament and personality variables, such as novelty seeking, may indeed be endophenotypes (mediators) that are genetically more complex than nicotine-dependence phenotypes. These trait variables also may serve as moderators as well as diathesis variables; their specific role will depend on the specified conceptual and statistical model. These types of conceptual issues are highlighted in chapter 3.

Under the premise of multiple pathways, a given endophenotype should capture a subset of the population (just as will a given genotype). Thus, a relative with little exposure to nicotine may appear similar to a nicotine dependent smoker on a putative endophenotype. That is, not all adolescents who have initiated smoking and progressed to nicotine dependence will have a particular endophenotype, and not all adolescents with an endophenotype will have initiated smoking and progressed to nicotine

dependence. Likewise, the evaluation of endophenotype-by-endophenotype interactions may (1) help to identify genetic signals across multiple pathways, which at a more surface level may reflect interactions of the biological and traitlike systems, or (2) aid in understanding why endophenotypes are present in adolescents who initiate smoking experimentation but do not progress to nicotine dependence.

The search for endophenotypes for nicotine-dependence risk at or before initial nicotine exposure will likely raise important issues with respect to smoking phenotypes, endophenotypes, and their distinction. If a smoking phenotype is weak, this may negatively affect statistical models designed to link genes to endophenotypes to phenotypes. An important question is whether phenotypic definition is improved by clarifying candidate endophenotypes. Effective endophenotypes may inform phenotype definition (e.g., smokers who have strong PET response to nicotine compared to those who do not) in the future. Likewise, the conceptual distinction between an endophenotype and a “refined phenotype” is murky. For example, rate of smoking escalation could be considered a phenotype as well as an index of an endophenotype (reinforcement) for nicotine exposure.

Methodological Issues

Methodological problems in identifying and measuring liability in those who have not yet initiated smoking are not trivial.^{39,40} Yet, measuring endophenotypes for nicotine-dependence risk in the context of prospective designs are crucial to establishing predictive validity as well as the utility of this approach. For example, prospective observational cohorts usually rely on a sufficiently large number of youth (general population or those at risk) measured repeatedly across time. A majority of the endophenotype measures are laboratory

based and possibly time variant. Thus, recruiting and retaining youth in studies involving the completion of laboratory-based tasks (endophenotype measures) on several occasions across time can be challenging. In addition, as noted in the second part of this chapter, there are methodological concerns with innate sensitivity research. For the retrospective studies, these include the definition of “initial” exposure, the reliance on retrospective reports of smoking experiences, and the unknown role differential nicotine dosing during initial exposure may play in determining differences in self-reported sensitivity to that exposure. For prospective studies, concerns include ethical dilemmas surrounding administering nicotine to naïve adolescents, generalizability of novel nicotine delivery methods to smoking, whether nicotine sensitivity is consistent from adolescence to young adulthood, and self-selection biases associated with the willingness to be exposed to nicotine through research.

Despite these methodological challenges, such studies could potentially offer comprehensive directional models that include surface characteristics, endophenotypes, and genes, which would provide support for one or more endophenotypes as mediator of the genetic effects on a nicotine-dependence phenotype. The endophenotype(s) should mediate the association between the candidate gene and the phenotype, indicating that the effects of a particular gene are expressed, fully or partially, through the endophenotype(s).¹³ These types of models have been proposed in studies investigating endophenotypes for the genes that underlie psychiatric disorders. As far as is known, only a few studies have evaluated these types of models with respect to nicotine-dependence risk phenotypes.^{21,24} More complex relationships may also be possible. For example, a gene may have a delayed effect on a phenotype, which is not evident until a particular developmental period (e.g., mid to late adolescence,

late adolescence to young adulthood). In addition, a suppressor effect may be present (e.g., genotype is positively related to the endophenotype and the phenotype, but the endophenotype is negatively related to the phenotype). In this situation, a simple assessment of the indirect effects to total effects may lead to the erroneous conclusion that the endophenotype does not account for the relationship between the genotype and the phenotype.^{344,345} In addition to mediation, the endophenotype should moderate association between the candidate gene and the phenotype, indicating that the effects of a particular gene are stronger in individuals with a phenotype who also show the endophenotype.¹³

With respect to analytic approaches, one must also consider the utility of using a latent variable as an endophenotype measure; that is, endophenotypes are latent (factors), rather than observed, and are comprised of several indicators (more than one endophenotype measure). This has been found to strengthen heritability coefficients,^{234,235} an important criterion for validating endophenotypes. However, it is unclear whether a composite measure renders the endophenotype more complex than the phenotype it is indexed to and is, therefore, less genetically simple. This approach has not yet been attempted to evaluate endophenotypes for smoking initiation, progression, and the initial response to nicotine.

Summary

This chapter has described potential endophenotypes for nicotine-dependence risk at or before initial nicotine exposure. The available literature points to several promising endophenotypes and highlights the limited research on the validity of putative endophenotypes. This research foundation will need to be built before the utility of the endophenotype approach can be

evaluated. While an endophenotype approach may help close the explanatory gap between candidate genes and the onset of nicotine dependence, it relies on conceptually and methodologically well-grounded research.³⁴⁶ A conceptual framework has, therefore, been emphasized that could guide future studies, including the selection of endophenotypes, and enable the integration of research on specific endophenotypes for nicotine-dependence risk and general substance-abuse endophenotypes.

Conclusions

1. Several higher-order psychological constructs can consolidate many smoking initiation and progression risk variables. These constructs, as well as sensitivity to initial nicotine exposure, can be related to observable neural, physiological, and behavioral measures that may, in turn, serve as potential candidate endophenotypes for genetic research on nicotine dependence.
2. Several laboratory measures exist that could be associated with the risk for smoking initiation and progression and subsequent nicotine dependence, but these associations have yet to be investigated. Findings are mixed for the reliability and heritability of these measures, and minimal evidence exists for their validity, representing an area for further study.
3. Measurement of sensitivity to initial nicotine exposure is subject to numerous methodological limitations, including ethical difficulties with empirical measurement in naive (e.g., previously unexposed to nicotine) subjects, a lack of consideration of smoking dose and context from retrospective self-reports, recall bias, and self-selection to early smoking experience. At the same time, preliminary findings indicate that measures of reward and mood effects surrounding initial exposure to smoking show promise as a potential basis for endophenotypes of a genetic predisposition to nicotine dependence.
4. The available evidence points to the plausibility of endophenotypes that link factors at or before initial nicotine exposure with the potential for nicotine dependence. These endophenotypes reflect approach, avoidance, and control-related traits as well as initial sensitivity and exposure measures in response to nicotine intake. Further research is needed to help identify endophenotypes that connect risk variables for nicotine dependence to genetic influences.

References

- Han, C., M. K. McGue, and W. G. Iacono. 1999. Lifetime tobacco, alcohol and other substance use in adolescent Minnesota twins: Univariate and multivariate behavioral genetic analyses. *Addiction* 94 (7): 981–93.
- Rhee, S. H., J. K. Hewitt, S. E. Young, R. P. Corley, T. J. Crowley, and M. C. Stallings. 2003. Genetic and environmental influences on substance initiation, use, and problem use in adolescents. *Archives of General Psychiatry* 60 (12): 1256–64.
- Young, S. E., S. H. Rhee, M. C. Stallings, R. P. Corley, and J. K. Hewitt. 2006. Genetic and environmental vulnerabilities underlying adolescent substance use and problem use: General or specific? *Behavior Genetics* 36 (4): 603–15.
- Koopmans, J. R., L. J. van Doornen, and D. I. Boomsma. 1997. Association between alcohol use and smoking in adolescent and young adult twins: A bivariate genetic analysis. *Alcoholism, Clinical and Experimental Research* 21 (3): 537–46.
- Berman, R. M., M. Narasimhan, H. L. Miller, A. Anand, A. Cappiello, D. A. Oren, G. R. Heninger, and D. S. Charney. 1999. Transient depressive relapse induced by catecholamine depletion: Potential phenotypic vulnerability marker? *Archives of General Psychiatry* 56 (5): 395–403.
- Chamberlain, S. R., A. D. Blackwell, N. A. Fineberg, T. W. Robbins, and B. J. Sahakian. 2005. The neuropsychology of obsessive compulsive disorder: The importance of failures in cognitive and behavioural inhibition as candidate endophenotypic markers. *Neuroscience and Biobehavioral Reviews* 29 (3): 399–419.
- Doyle, A. E., E. G. Willcutt, L. J. Seidman, J. Biederman, V. A. Chouinard, J. Silva, and S. V. Faraone. 2005. Attention-deficit/hyperactivity disorder endophenotypes. *Biological Psychiatry* 57 (11): 1324–35.
- Hasler, G., W. C. Drevets, T. D. Gould, I. I. Gottesman, and H. K. Manji. 2006. Toward constructing an endophenotype strategy for bipolar disorders. *Biological Psychiatry* 60 (2): 93–105.
- Zucker, R. A. 2006. The developmental behavior genetics of drug involvement: Overview and comments. *Behavior Genetics* 36 (4): 616–25.
- Gottesman, I. I., and T. D. Gould. 2003. The endophenotype concept in psychiatry: Etymology and strategic intentions. *American Journal of Psychiatry* 160 (4): 636–45.
- Gould, T. D., and I. I. Gottesman. 2006. Psychiatric endophenotypes and the development of valid animal models. *Genes, Brain, and Behavior* 5 (2): 113–19.
- Munafó, M. R., A. E. Shields, W. H. Berrettini, F. Patterson, and C. Lerman. 2005. Pharmacogenetics and nicotine addiction treatment. *Pharmacogenomics* 6 (3): 211–23.
- Waldman, I. D. 2005. Statistical approaches to complex phenotypes: Evaluating neuropsychological endophenotypes for attention-deficit/hyperactivity disorder. *Biological Psychiatry* 57 (11): 1347–56.
- Waldman, I. D., J. T. Nigg, I. R. Gizer, L. Park, M. D. Rappley, and K. Friderici. 2006. The adrenergic receptor alpha-2A gene (ADRA2A) and neuropsychological executive functions as putative endophenotypes for childhood ADHD. *Cognitive, Affective & Behavioral Neuroscience* 6 (1): 18–30.
- Szatmari, P., M. Maziade, L. Zwaigenbaum, C. Merette, M. A. Roy, R. Joobar, and R. Palmour. 2007. Informative phenotypes for genetic studies of psychiatric disorders. *American Journal of Medical Genetics Part B, Neuropsychiatric Genetics* 144B (5): 581–88.
- Hopfer, C. J., T. J. Crowley, and J. K. Hewitt. 2003. Review of twin and adoption studies of adolescent substance use. *Journal of the American Academy of Child & Adolescent Psychiatry* 42 (6): 710–19.
- Boomsma, D. I., J. R. Koopmans, L. J. Van Doornen, and J. F. Orlebeke. 1994. Genetic and social influences on starting to smoke: A study of Dutch adolescent twins and their parents. *Addiction* 89 (2): 219–26.
- Koopmans, J. R., W. S. Slutske, A. C. Heath, M. C. Neale, and D. I. Boomsma. 1999. The genetics of smoking initiation and quantity smoked in Dutch adolescent and young adult twins. *Behavior Genetics* 29 (6): 383–93.
- McGue, M., I. Elkins, and W. G. Iacono. 2000. Genetic and environmental influences on adolescent substance use and abuse. *American Journal of Medical Genetics* 96 (5): 671–77.
- Rende, R., C. Slomkowski, J. McCaffery, E. E. Lloyd-Richardson, and R. Niaura. 2005. A twin-sibling study of tobacco use in adolescence: Etiology of individual

- differences and extreme scores. *Nicotine & Tobacco Research* 7 (3): 413–19.
21. Audrain-McGovern, J., N. Al Koudsi, D. Rodriguez, E. P. Wileyto, P. G. Shields, and R. F. Tyndale. 2007. The role of CYP2A6 in the emergence of nicotine dependence in adolescents. *Pediatrics* 119 (1): e264–e274.
 22. O’Loughlin, J., G. Paradis, W. Kim, J. DiFranza, G. Meshefedian, E. McMillan-Davey, S. Wong, J. Hanley, and R. F. Tyndale. 2004. Genetically decreased CYP2A6 and the risk of tobacco dependence: A prospective study of novice smokers. *Tobacco Control* 13 (4): 422–28.
 23. Audrain-McGovern, J., C. Lerman, E. P. Wileyto, D. Rodriguez, and P. G. Shields. 2004. Interacting effects of genetic predisposition and depression on adolescent smoking progression. *American Journal of Psychiatry* 161 (7): 1224–30.
 24. Laucht, M., K. Becker, M. El-Faddagh, E. Hohm, and M. H. Schmidt. 2005. Association of the DRD4 exon III polymorphism with smoking in fifteen-year-olds: A mediating role for novelty seeking? *Journal of the American Academy of Child & Adolescent Psychiatry* 44 (5): 477–84.
 25. Anney, R. J., C. A. Olsson, M. Lotfi-Miri, G. C. Patton, and R. Williamson. 2004. Nicotine dependence in a prospective population-based study of adolescents: The protective role of a functional tyrosine hydroxylase polymorphism. *Pharmacogenetics* 14 (2): 73–81.
 26. Olsson, C., R. Anney, S. Forrest, G. Patton, C. Coffey, T. Cameron, A. Hassett, and R. Williamson. 2004. Association between dependent smoking and a polymorphism in the tyrosine hydroxylase gene in a prospective population-based study of adolescent health. *Behavior Genetics* 34 (1): 85–91.
 27. Bierut, L. J., P. A. Madden, N. Breslau, E. O. Johnson, D. Hatsukami, O. F. Pomerleau, G. E. Swan, et al. 2007. Novel genes identified in a high-density genome wide association study for nicotine dependence. *Human Molecular Genetics* 16 (1): 24–35.
 28. Uhl, G. R., Q. R. Liu, T. Drgon, C. Johnson, D. Walther, and J. E. Rose. 2007. Molecular genetics of nicotine dependence and abstinence: Whole genome association using 520,000 SNPs. *BMC Genetics* 8:10.
 29. Saccone, S. F., A. L. Hinrichs, N. L. Saccone, G. A. Chase, K. Konvicka, P. A. Madden, N. Breslau, et al. 2007. Cholinergic nicotinic receptor genes implicated in a nicotine dependence association study targeting 348 candidate genes with 3713 SNPs. *Human Molecular Genetics* 16 (1): 36–49.
 30. Amos, C. I., X. Wu, P. Broderick, I. P. Gorlov, J. Gu, T. Eisen, Q. Dong, et al. 2008. Genome-wide association scan of tag SNPs identifies a susceptibility locus for lung cancer at 15q25.1. *Nature Genetics* 40 (5): 616–22.
 31. Berrettini, W., X. Yuan, F. Tozzi, K. Song, C. Francks, H. Chilcoat, D. Waterworth, P. Muglia, and V. Mooser. 2008. Alpha-5/alpha-3 nicotinic receptor subunit alleles increase risk for heavy smoking. *Molecular Psychiatry* 13 (4): 368–73.
 32. Hung, R. J., J. D. McKay, V. Gaborieau, P. Boffetta, M. Hashibe, D. Zaridze, A. Mukeria, et al. 2008. A susceptibility locus for lung cancer maps to nicotinic acetylcholine receptor subunit genes on 15q25. *Nature* 452 (7187): 633–37.
 33. Thorgeirsson, T. E., F. Geller, P. Sulem, T. Rafnar, A. Wiste, K. P. Magnusson, A. Manolescu, et al. 2008. A variant associated with nicotine dependence, lung cancer and peripheral arterial disease. *Nature* 452 (7187): 638–42.
 34. Sherva, R., K. Wilhelmsen, C. S. Pomerleau, S. A. Chasse, J. P. Rice, S. M. Snedecor, L. J. Bierut, R. J. Neuman, and O. F. Pomerleau. 2008. Association of a single nucleotide polymorphism in neuronal acetylcholine receptor subunit alpha 5 (CHRNA5) with smoking status and with ‘pleasurable buzz’ during early experimentation with smoking. *Addiction* 103 (9): 1544–52.
 35. Dick, D. M., R. Viken, S. Purcell, J. Kaprio, L. Pulkkinen, and R. J. Rose. 2007. Parental monitoring moderates the importance of genetic and environmental influences on adolescent smoking. *Journal of Abnormal Psychology* 116 (1): 213–18.
 36. Audrain-McGovern, J., D. Rodriguez, E. P. Wileyto, K. H. Schmitz, and P. G. Shields. 2006. Effect of team sport participation on genetic predisposition to adolescent smoking progression. *Archives of General Psychiatry* 63 (4): 433–41.
 37. Gerra, G., L. Garofano, A. Zaimovic, G. Moi, B. Branchi, M. Bussandri, F. Brambilla, and C. Donnini. 2005. Association of the serotonin transporter promoter polymorphism with smoking behavior

- among adolescents. *American Journal of Medical Genetics Part B, Neuropsychiatric Genetics* 135 (1): 73–78.
38. Skowronek, M. H., M. Laucht, E. Hohm, K. Becker, and M. H. Schmidt. 2006. Interaction between the dopamine D4 receptor and the serotonin transporter promoter polymorphisms in alcohol and tobacco use among 15-year-olds. *Neurogenetics* 7 (4): 239–46.
 39. Neale, M. C., S. H. Aggen, H. H. Maes, T. S. Kubarych, and J. E. Schmitt. 2006. Methodological issues in the assessment of substance use phenotypes. *Addictive Behaviors* 31 (6): 1010–34.
 40. Neale, M. C., E. Harvey, H. H. Maes, P. F. Sullivan, and K. S. Kendler. 2006. Extensions to the modeling of initiation and progression: Applications to substance use and abuse. *Behavior Genetics* 36 (4): 507–24.
 41. Mayhew, K. P., B. R. Flay, and J. A. Mott. 2000. Stages in the development of adolescent smoking. *Drug and Alcohol Dependence* 59 Suppl. 1: S61–S81.
 42. Nigg, J. T. 2006. Temperament and developmental psychopathology. *Journal of Child Psychology and Psychiatry* 47 (3–4): 395–422.
 43. Zucker, R. A. 2006. Alcohol use and the alcohol use disorders: A developmental-biopsychosocial systems formulation covering the life course. In *Developmental psychopathology, vol. 3, risk, disorder, and adaptation*, 2nd ed., ed. D. Cicchetti and D. J. Cohen, 620–656. New York: John Wiley & Sons.
 44. Beauchaine, T. P. 2001. Vagal tone, development, and Gray's motivational theory: Toward an integrated model of autonomic nervous system functioning in psychopathology. *Development and Psychopathology* 13 (2): 183–214.
 45. Calkins, S. D., and N. A. Fox. 2002. Self-regulatory processes in early personality development: A multilevel approach to the study of childhood social withdrawal and aggression. *Development and Psychopathology* 14 (3): 477–98.
 46. Lahey, B. B., and I. D. Waldman. 2003. A developmental propensity model of the origins of conduct problems during childhood and adolescence. In *Causes of conduct disorder and juvenile delinquency*, ed. B. B. Lahey, T. E. Moffitt, and A. Caspi, 76–117. New York: Guilford Publications.
 47. Markon, K. E., R. F. Krueger, and D. Watson. 2005. Delineating the structure of normal and abnormal personality: An integrative hierarchical approach. *Journal of Personality and Social Psychology* 88 (1): 139–57.
 48. Rothbart, M. K., and J. E. Bates. 2006. Temperament. In *Handbook of Child Psychology: Social, emotional and personality development*, vol. 3, 6th ed., ed. W. Damon and N. Eisenberg, 105–76. New York: Wiley.
 49. Shiner, R., and A. Caspi. 2003. Personality differences in childhood and adolescence: Measurement, development, and consequences. *Journal of Child Psychology and Psychiatry* 44 (1): 2–32.
 50. Tackett, J. L., R. F. Krueger, W. G. Iacono, and M. McGue. 2005. Symptom-based subfactors of DSM-defined conduct disorder: Evidence for etiologic distinctions. *Journal of Abnormal Psychology* 114 (3): 483–87.
 51. Zuckerman, M. 2005. *Psychobiology of personality*, 2nd ed. New York: Cambridge Univ. Press.
 52. Caspi, A., B. W. Roberts, and R. L. Shiner. 2005. Personality development: Stability and change. *Annual Review of Psychology* 56:453–84.
 53. Hart, D., R. Atkins, and S. Fegley. 2003. Personality and development in childhood: A person-centered approach. *Monographs of the Society for Research in Child Development* 68 (1): 1–109.
 54. McCrae, R. R., P. T. Costa Jr., A. Terracciano, W. D. Parker, C. J. Mills, F. De Fruyt, and I. Mervielde. 2002. Personality trait development from age 12 to age 18: Longitudinal, cross-sectional, and cross-cultural analyses. *Journal of Personality and Social Psychology* 83 (6): 1456–68.
 55. Brook, J. S., M. Whiteman, P. Cohen, J. Shapiro, and E. Balka. 1995. Longitudinally predicting late adolescent and young adult drug use: Childhood and adolescent precursors. *Journal of the American Academy of Child & Adolescent Psychiatry* 34 (9): 1230–38.
 56. Wong, M. M., J. T. Nigg, R. A. Zucker, L. I. Puttler, H. E. Fitzgerald, J. M. Jester, J. M. Glass, and K. Adams. 2006. Behavioral control and resiliency in the onset of alcohol and illicit drug use: A prospective study from preschool to adolescence. *Child Development* 77 (4): 1016–33.

57. Audrain-McGovern, J., D. Rodriguez, K. P. Tercyak, G. Neuner, and H. B. Moss. 2006. The impact of self-control indices on peer smoking and adolescent smoking progression. *Journal of Pediatric Psychology* 31 (2): 139–51.
58. Choi, W. S., J. P. Pierce, E. A. Gilpin, A. J. Farkas, and C. C. Berry. 1997. Which adolescent experimenters progress to established smoking in the United States. *American Journal of Preventive Medicine* 13 (5): 385–91.
59. Kobus, K. 2003. Peers and adolescent smoking. *Addiction* 98 Suppl. 1: 37–55.
60. Chassin, L., C. C. Presson, J. S. Rose, and S. J. Sherman. 1996. The natural history of cigarette smoking from adolescence to adulthood: Demographic predictors of continuity and change. *Health Psychology* 15 (6): 478–84.
61. Conrad, K. M., B. R. Flay, and D. Hill. 1992. Why children start smoking cigarettes: Predictors of onset. *British Journal of Addiction* 87 (12): 1711–24.
62. Flay, B. R., F. B. Hu, O. Siddiqui, L. E. Day, D. Hedeker, J. Petraitis, J. Richardson, and S. Sussman. 1994. Differential influence of parental smoking and friends' smoking on adolescent initiation and escalation of smoking. *Journal of Health and Social Behavior* 35 (3): 248–65.
63. Wang, L., R. Kakigi, and M. Hoshiyama. 2001. Neural activities during Wisconsin Card Sorting Test—MEG observation. *Brain Research Cognitive Brain Research* 12 (1): 19–31.
64. Canli, T. 2004. Functional brain mapping of extraversion and neuroticism: Learning from individual differences in emotion processing. *Journal of Personality* 72 (6): 1105–32.
65. Munafó, M. R., B. Yalcin, S. A. Willis-Owen, and J. Flint. 2007. Association of the dopamine D4 receptor (*DRD4*) gene and approach-related personality traits: Meta-analysis and new data. *Biological Psychiatry* 63 (2): 197–206.
66. Putnam, S. P., L. K. Ellis, and M. K. Rothbart. 2001. The structure of temperament from infancy through adolescence. In *Advances in research on temperament*, ed. A. Elias and A. Angleitner, 165–82. Lengerich, Germany: Pabst Science.
67. Depue, R. A., and P. F. Collins. 1999. Neurobiology of the structure of personality: Dopamine, facilitation of incentive motivation, and extraversion. *Behavioral and Brain Sciences* 22 (3): 491–569.
68. Fowles, D. C. 1983. Motivational effects on heart rate and electrodermal activity: Implications for research on personality and psychopathology. *Journal of Research in Personality* 17:87–104.
69. Whitfield, J. B., D. Pang, K. K. Bucholz, P. A. Madden, A. C. Heath, D. J. Statham, and N. G. Martin. 2000. Monoamine oxidase: Associations with alcohol dependence, smoking and other measures of psychopathology. *Psychological Medicine* 30 (2): 443–54.
70. Bickel, W. K., A. L. Odum, and G. J. Madden. 1999. Impulsivity and cigarette smoking: Delay discounting in current, never, and ex-smokers. *Psychopharmacology (Berl)* 146 (4): 447–54.
71. Odum, A. L., G. J. Madden, and W. K. Bickel. 2002. Discounting of delayed health gains and losses by current, never- and ex-smokers of cigarettes. *Nicotine & Tobacco Research* 4 (3): 295–303.
72. Monterosso, J., and G. Ainslie. 1999. Beyond discounting: Possible experimental models of impulse control. *Psychopharmacology (Berl)* 146 (4): 339–47.
73. Kirby, K. N., N. M. Petry, and W. K. Bickel. 1999. Heroin addicts have higher discount rates for delayed rewards than non-drug-using controls. *Journal of Experimental Psychology General* 128 (1): 78–87.
74. Kollins, S. H. 2003. Comparing the abuse potential of methylphenidate versus other stimulants: A review of available evidence and relevance to the ADHD patient. *Journal of Clinical Psychiatry* 64 Suppl 11: 14–18.
75. Petry, N. M. 2002. Discounting of delayed rewards in substance abusers: Relationship to antisocial personality disorder. *Psychopharmacology (Berl)* 162 (4): 425–32.
76. Audrain-McGovern, J., D. Rodriguez, K. P. Tercyak, L. H. Epstein, P. Goldman, and E. P. Wileyto. 2004. Applying a behavioral economic framework to understanding adolescent smoking. *Psychology of Addictive Behaviors* 18 (1): 64–73.
77. McClure, S. M., D. I. Laibson, G. Loewenstein, and J. D. Cohen. 2004. Separate neural systems value immediate and delayed monetary rewards. *Science* 306 (5695): 503–7.
78. Cloninger, C. R. 1987. A systematic method for clinical description and classification of

- personality variants. A proposal. *Archives of General Psychiatry* 44 (6): 573–88.
79. Cloninger, C. R., D. M. Svrakic, and T. R. Przybeck. 1993. A psychobiological model of temperament and character. *Archives of General Psychiatry* 50 (12): 975–90.
80. Stallings, M. C., J. K. Hewitt, C. R. Cloninger, A. C. Heath, and L. J. Eaves. 1996. Genetic and environmental structure of the Tridimensional Personality Questionnaire: Three or four temperament dimensions? *Journal of Personality and Social Psychology* 70 (1): 127–40.
81. Wills, T. A., D. Vaccaro, and G. McNamara. 1994. Novelty seeking, risk taking, and related constructs as predictors of adolescent substance use: An application of Cloninger's theory. *Journal of Substance Abuse* 6 (1): 1–20.
82. Wills, T. A., M. Windle, and S. D. Cleary. 1998. Temperament and novelty seeking in adolescent substance use: Convergence of dimensions of temperament with constructs from Cloninger's theory. *Journal of Personality and Social Psychology* 74 (2): 387–406.
83. Masse, L. C., and R. E. Tremblay. 1997. Behavior of boys in kindergarten and the onset of substance use during adolescence. *Archives of General Psychiatry* 54 (1): 62–8.
84. Audrain-McGovern, J., D. Rodriguez, K. P. Tercyak, J. Cuevas, K. Rodgers, and F. Patterson. 2004. Identifying and characterizing adolescent smoking trajectories. *Cancer Epidemiology, Biomarkers & Prevention* 13 (12): 2023–34.
85. Audrain-McGovern, J., D. Rodriguez, V. Patel, M. S. Faith, K. Rodgers, and J. Cuevas. 2006. How do psychological factors influence adolescent smoking progression? The evidence for indirect effects through tobacco advertising receptivity. *Pediatrics* 117 (4): 1216–25.
86. Audrain-McGovern, J., K. P. Tercyak, A. E. Shields, A. Bush, C. F. Espinel, and C. Lerman. 2003. Which adolescents are most receptive to tobacco industry marketing? Implications for counter-advertising campaigns. *Health Communication* 15 (4): 499–513.
87. Wills, T. A., J. M. Sandy, and O. Shinar. 1999. Cloninger's constructs related to substance use level and problems in late adolescence: A mediational model based on self-control and coping motives. *Experimental and Clinical Psychopharmacology* 7 (2): 122–34.
88. Crawford, A. M., M. A. Pentz, C. P. Chou, C. Li, and J. H. Dwyer. 2003. Parallel developmental trajectories of sensation seeking and regular substance use in adolescents. *Psychology of Addictive Behaviors* 17 (3): 179–92.
89. Bardo, M. T., R. L. Donohew, and N. G. Harrington. 1996. Psychobiology of novelty seeking and drug seeking behavior. *Behavioural Brain Research* 77 (1–2): 23–43.
90. Benjamin, J., L. Li, C. Patterson, B. D. Greenberg, D. L. Murphy, and D. H. Hamer. 1996. Population and familial association between the D4 dopamine receptor gene and measures of novelty seeking. *Nature Genetics* 12 (1): 81–84.
91. Ebstein, R. P., O. Novick, R. Umansky, B. Priel, Y. Osher, D. Blaine, E. R. Bennett, L. Nemanov, M. Katz, and R. H. Belmaker. 1996. Dopamine D4 receptor (D4DR) exon III polymorphism associated with the human personality trait of novelty seeking. *Nature Genetics* 12 (1): 78–80.
92. Harakeh, Z., R. H. Scholte, H. de Vries, and R. C. Engels. 2006. Association between personality and adolescent smoking. *Addictive Behaviors* 31 (2): 232–45.
93. Stein, J. A., M. D. Newcomb, and P. M. Bentler. 1996. Initiation and maintenance of tobacco smoking: Changing personality correlates in adolescence and young adulthood. *Journal of Applied Social Psychology* 26 (2): 160–87.
94. White, V., D. Hill, and J. Hopper. 1996. The outgoing, the rebellious and the anxious: Are adolescent personality dimensions related to the uptake of smoking. *Psychology and Health* 12 (1): 73–85.
95. Wijatkowski, S., D. G. Forgays, K. Wrzesniewski, and T. Gorski. 1990. Smoking behavior and personality characteristics in Polish adolescents. *International Journal of Addiction* 25 (4): 363–73.
96. Wilkinson, D., and C. Abraham. 2004. Constructing an integrated model of the antecedents of adolescent smoking. *British Journal of Health Psychology* 9 (Pt 3): 315–33.
97. Knutson, B., C. M. Adams, G. W. Fong, and D. Hommer. 2001. Anticipation of increasing monetary reward selectively recruits nucleus accumbens. *Journal of Neuroscience* 21 (16): RC159.

98. Scheres, A., M. P. Milham, B. Knutson, and F. X. Castellanos. 2007. Ventral striatal hypo-responsiveness during reward anticipation in attention-deficit/hyperactivity disorder. *Biological Psychiatry* 61 (5): 720–4.
99. Schultz, W. 2000. Multiple reward signals in the brain. *Nature Reviews Neuroscience* 1 (3): 199–207.
100. Bechara, A., D. Tranel, and H. Damasio. 2000. Characterization of the decision-making deficit of patients with ventromedial prefrontal cortex lesions. *Brain* 123 (Pt 11): 2189–202.
101. Bechara, A., S. Dolan, N. Denburg, A. Hindes, S. W. Anderson, and P. E. Nathan. 2001. Decision-making deficits, linked to a dysfunctional ventromedial prefrontal cortex, revealed in alcohol and stimulant abusers. *Neuropsychologia* 39 (4): 376–89.
102. Heyman, G. M., and S. P. Gibb. 2006. Delay discounting in college cigarette chippers. *Behavioural Pharmacology* 17 (8): 669–79.
103. Sonuga-Barke, E. J. 2002. Interval length and time-use by children with AD/HD: A comparison of four models. *Journal of Abnormal and Child Psychology* 30 (3): 257–64.
104. Roesch, M. R., D. J. Calu, K. A. Burke, and G. Schoenbaum. 2007. Should I stay or should I go: Transformation of time-discounted rewards in orbitofrontal cortex and associated brain circuits. *Annals of the New York Academy of Sciences* 1104: 21–34.
105. Hariri, A. R., S. M. Brown, D. E. Williamson, J. D. Flory, H. de Wit, and S. B. Manuck. 2006. Preference for immediate over delayed rewards is associated with magnitude of ventral striatal activity. *Journal of Neuroscience* 26 (51): 13213–7.
106. Barkley, R. A. 2001. The executive functions and self-regulation: An evolutionary neuropsychological perspective. *Neuropsychology Reviews* 11 (1): 1–29.
107. Baker, F., M. W. Johnson, and W. K. Bickel. 2003. Delay discounting in current and never-before cigarette smokers: Similarities and differences across commodity, sign, and magnitude. *Journal of Abnormal Psychology* 112 (3): 382–92.
108. Reynolds, B., K. Karraker, K. Horn, and J. B. Richards. 2003. Delay and probability discounting as related to different stages of adolescent smoking and non-smoking. *Behavioral Processes* 64 (3): 333–44.
109. Krishnan-Sarin, S., B. Reynolds, A. M. Duhig, A. Smith, T. Liss, A. McFetridge, D. A. Cavallo, K. M. Carroll, and M. N. Potenza. 2007. Behavioral impulsivity predicts treatment outcome in a smoking cessation program for adolescent smokers. *Drug and Alcohol Dependence* 88 (1): 79–82.
110. Dawkins, L., J. H. Powell, R. West, J. Powell, and A. Pickering. 2006. A double-blind placebo controlled experimental study of nicotine: I—effects on incentive motivation. *Psychopharmacology (Berl)* 189 (3): 355–67.
111. Kuntsi, J., P. Andreou, J. Ma, N. A. Borger, and J. J. van der Meere. 2005. Testing assumptions for endophenotype studies in ADHD: Reliability and validity of tasks in a general population sample. *BMC Psychiatry* 5:40.
112. Fowles, D. C. 1980. The three arousal model: Implications of Gray's two-factor learning theory for heart rate, electrodermal activity, and psychopathy. *Psychophysiology* 17 (2): 87–104.
113. Gilbert, D. G., and B. O. Gilbert. 1995. Personality, psychopathology, and nicotine response as mediators of the genetics of smoking. *Behavior Genetics* 25 (2): 133–47.
114. Pedersen, N. L., R. Plomin, G. E. McClearn, and L. Friberg. 1988. Neuroticism, extraversion, and related traits in adult twins reared apart and reared together. *Journal of Personality and Social Psychology* 55 (6): 950–7.
115. Tambs, K., J. M. Sundet, L. Eaves, M. H. Solaas, and K. Berg. 1991. Pedigree analysis of Eysenck Personality Questionnaire (EPQ) scores in monozygotic (MZ) twin families. *Behavior Genetics* 21 (4): 369–82.
116. Byrne, D. G., A. E. Byrne, and M. I. Reinhart. 1995. Personality, stress and the decision to commence cigarette smoking in adolescence. *Journal of Psychosomatic Research* 39 (1): 53–62.
117. Cherry, N., and K. Kiernan. 1976. Personality scores and smoking behaviour: A longitudinal study. *British Journal of Preventive and Social Medicine* 30 (2): 123–31.
118. Sieber, M. F., and J. Angst. 1990. Alcohol, tobacco and cannabis: 12-year longitudinal associations with antecedent social context and personality. *Drug and Alcohol Dependence* 25 (3): 281–92.
119. Kirk, K. M., J. B. Whitfield, D. Pang, A. C. Heath, and N. G. Martin. 2001. Genetic

- covariation of neuroticism with monoamine oxidase activity and smoking. *American Journal of Medical Genetics* 105 (8): 700–6.
120. van Amsterdam, J., R. Talhout, W. Vleeming, and A. Opperhuizen. 2006. Contribution of monoamine oxidase (MAO) inhibition to tobacco and alcohol addiction. *Life Sciences* 79 (21): 1969–73.
 121. Rose, J. E., F. M. Behm, C. Ramsey, and J. C. Ritchie Jr. 2001. Platelet monoamine oxidase, smoking cessation, and tobacco withdrawal symptoms. *Nicotine & Tobacco Research* 3 (4): 383–90.
 122. Dugan, S., B. Lloyd, and K. Lucas. 1999. Stress and coping as determinants of adolescent smoking behavior. *Journal of Applied Social Psychology* 29 (4): 870–88.
 123. Byrne, D. G., and J. Mazanov. 2001. Self-esteem, stress and cigarette smoking in adolescents. *Stress and Health* 17 (2): 105–10.
 124. Koval, J. J., L. L. Pederson, C. A. Mills, G. A. McGrady, and S. C. Carvajal. 2000. Models of the relationship of stress, depression, and other psychosocial factors to smoking behavior: A comparison of a cohort of students in grades 6 and 8. *Preventive Medicine* 30 (6): 463–77.
 125. Siqueira, L., M. Diab, C. Bodian, and L. Rolnitzky. 2000. Adolescents becoming smokers: The roles of stress and coping methods. *Journal of Adolescent Health* 27 (6): 399–408.
 126. Sussman, S., C. W. Dent, H. Severson, D. Burton, and B. R. Flay. 1998. Self-initiated quitting among adolescent smokers. *Preventive Medicine* 27 (5 Pt 3): A19–A28.
 127. Conklin, C. A., and K. A. Perkins. 2005. Subjective and reinforcing effects of smoking during negative mood induction. *Journal of Abnormal Psychology* 114 (1): 153–64.
 128. Baker, T. B., T. H. Brandon, and L. Chassin. 2004. Motivational influences on cigarette smoking. *Annual Review of Psychology* 55:463–91.
 129. Angst, J., K. R. Merikangas, and M. Preisig. 1997. Subthreshold syndromes of depression and anxiety in the community. *Journal of Clinical Psychiatry* 58 Suppl. 8: 6–10.
 130. Fergusson, D. M., L. J. Horwood, E. M. Ridder, and A. L. Beautrais. 2005. Subthreshold depression in adolescence and mental health outcomes in adulthood. *Archives of General Psychiatry* 62 (1): 66–72.
 131. Gotlib, I. H., P. M. Lewinsohn, and J. R. Seeley. 1995. Symptoms versus a diagnosis of depression: Differences in psychosocial functioning. *Journal of Consulting and Clinical Psychology* 63 (1): 90–100.
 132. Hays, R. D., K. B. Wells, C. D. Sherbourne, W. Rogers, and K. Spritzer. 1995. Functioning and well-being outcomes of patients with depression compared with chronic general medical illnesses. *Archives of General Psychiatry* 52 (1): 11–9.
 133. Horwath, E., J. Johnson, G. L. Klerman, and M. M. Weissman. 1992. Depressive symptoms as relative and attributable risk factors for first-onset major depression. *Archives of General Psychiatry* 49 (10): 817–23.
 134. Judd, L. L., and H. S. Akiskal. 2000. Delineating the longitudinal structure of depressive illness: Beyond clinical subtypes and duration thresholds. *Pharmacopsychiatry* 33 (1): 3–7.
 135. Lewinsohn, P. M., S. A. Shankman, J. M. Gau, and D. N. Klein. 2004. The prevalence and co-morbidity of subthreshold psychiatric conditions. *Psychological Medicine* 34 (4): 613–22.
 136. Kendler, K. S., M. Gatz, C. O. Gardner, and N. L. Pedersen. 2006. Personality and major depression: A Swedish longitudinal, population-based twin study. *Archives of General Psychiatry* 63 (10): 1113–20.
 137. Escobedo, L. G., D. G. Kirch, and R. F. Anda. 1996. Depression and smoking initiation among US Latinos. *Addiction* 91 (1): 113–19.
 138. Patton, G. C., J. B. Carlin, C. Coffey, R. Wolfe, M. Hibbert, and G. Bowes. 1998. Depression, anxiety, and smoking initiation: A prospective study over 3 years. *American Journal of Public Health* 88 (10): 1518–22.
 139. Covey, L. S., and D. Tam. 1990. Depressive mood, the single-parent home, and adolescent cigarette smoking. *American Journal of Public Health* 80 (11): 1330–33.
 140. Goodman, E., and J. Capitman. 2000. Depressive symptoms and cigarette smoking among teens. *Pediatrics* 106 (4): 748–55.
 141. Fergusson, D. M., M. T. Lynskey, and L. J. Horwood. 1996. Comorbidity between depressive disorders and nicotine dependence in a cohort of 16-year-olds. *Archives of General Psychiatry* 53 (11): 1043–7.
 142. Brown, D. R., J. B. Croft, R. F. Anda, D. H. Barrett, and L. G. Escobedo. 1996.

- Evaluation of smoking on the physical activity and depressive symptoms relationship. *Medicine and Science in Sports and Exercise* 28 (2): 233–40.
143. Fergusson, D. M., R. D. Goodwin, and L. J. Horwood. 2003. Major depression and cigarette smoking: Results of a 21-year longitudinal study. *Psychological Medicine* 33 (8): 1357–367.
 144. Breslau, N., E. L. Peterson, L. R. Schultz, H. D. Chilcoat, and P. Andreski. 1998. Major depression and stages of smoking. A longitudinal investigation. *Archives of General Psychiatry* 55 (2): 161–66.
 145. Breslau, N., N. Fenn, and E. L. Peterson. 1993. Early smoking initiation and nicotine dependence in a cohort of young adults. *Drug and Alcohol Dependence* 33 (2): 129–37.
 146. Dierker, L. C., S. Avenevoli, M. Stolar, and K. R. Merikangas. 2002. Smoking and depression: An examination of mechanisms of comorbidity. *American Journal of Psychiatry* 159 (6): 947–53.
 147. Kendler, K. S., M. C. Neale, C. J. MacLean, A. C. Heath, L. J. Eaves, and R. C. Kessler. 1993. Smoking and major depression. A causal analysis. *Archives of General Psychiatry* 50 (1): 36–43.
 148. Albers, A. B., and L. Biener. 2002. The role of smoking and rebelliousness in the development of depressive symptoms among a cohort of Massachusetts adolescents. *Preventive Medicine* 34 (6): 625–31.
 149. Breslau, N., M. Kilbey, and P. Andreski. 1991. Nicotine dependence, major depression, and anxiety in young adults. *Archives of General Psychiatry* 48 (12): 1069–74.
 150. Martini, S., F. A. Wagner, and J. C. Anthony. 2002. The association of tobacco smoking and depression in adolescence: Evidence from the United States. *Substance Use and Misuse* 37 (14): 1853–67.
 151. Windle, M., and R. C. Windle. 2001. Depressive symptoms and cigarette smoking among middle adolescents: Prospective associations and intrapersonal and interpersonal influences. *Journal of Consulting and Clinical Psychology* 69 (2): 215–26.
 152. Rodriguez, D., H. B. Moss, and J. Audrain-McGovern. 2005. Developmental heterogeneity in adolescent depressive symptoms: Associations with smoking behavior. *Psychosomatic Medicine* 67 (2): 200–10.
 153. Gardner, T. W., T. J. Dishion, and M. I. Posner. 2006. Attention and adolescent tobacco use: A potential self-regulatory dynamic underlying nicotine addiction. *Addictive Behaviors* 31 (3): 531–6.
 154. Spring, B., S. Pagoto, D. McChargue, D. Hedeker, and J. Werth. 2003. Altered reward value of carbohydrate snacks for female smokers withdrawn from nicotine. *Pharmacology, Biochemistry, and Behavior* 76 (2): 351–60.
 155. Cardenas, L., L. K. Tremblay, C. A. Naranjo, N. Herrmann, M. Zack, and U. E. Busto. 2002. Brain reward system activity in major depression and comorbid nicotine dependence. *Journal of Pharmacology and Experimental Therapeutics* 302 (3): 1265–71.
 156. Tremblay, L. K., C. A. Naranjo, L. Cardenas, N. Herrmann, and U. E. Busto. 2002. Probing brain reward system function in major depressive disorder: Altered response to dextroamphetamine. *Archives of General Psychiatry* 59 (5): 409–16.
 157. Clark, L. A., and D. Watson. 1991. Tripartite model of anxiety and depression: Psychometric evidence and taxonomic implications. *Journal of Abnormal Psychology* 100 (3): 316–36.
 158. Watson, D., W. Gamez, and L. J. Simms. 2005. Basic dimensions of temperament and their relation to anxiety and depression: A symptom-based perspective. *Journal of Research in Personality* 39 (1): 46–66.
 159. American Psychiatric Association. 1994. *Diagnostic and statistical manual of mental disorders: DSM-IV*. 4th ed. Washington, DC: American Psychiatric Association.
 160. Breslau, N., and D. F. Klein. 1999. Smoking and panic attacks: An epidemiologic investigation. *Archives of General Psychiatry* 56 (12): 1141–47.
 161. DiFranza, J. R., J. A. Savageau, N. A. Rigotti, J. K. Ockene, A. D. McNeill, M. Coleman, and C. Wood. 2004. Trait anxiety and nicotine dependence in adolescents: A report from the DANDY study. *Addictive Behaviors* 29 (5): 911–19.
 162. Johnston, L. D., P. M. O'Malley, and J. G. Bachman. 2000. *Monitoring the Future: National survey results on drug use, 1975–1999. Vol. 1: Secondary school students* (NIH publication no. 00-4802). Bethesda, MD: U.S. Department of Health and Human Services, National Institutes of Health, National Institute on Drug Abuse.

163. Johnson, J. G., P. Cohen, D. S. Pine, D. F. Klein, S. Kasen, and J. S. Brook. 2000. Association between cigarette smoking and anxiety disorders during adolescence and early adulthood. *JAMA: The Journal of the American Medical Association* 284 (18): 2348–51.
164. Patton, G. C., C. Coffey, J. B. Carlin, S. M. Sawyer, and M. Wakefield. 2006. Teen smokers reach their mid twenties. *Journal of Adolescent Health* 39 (2): 214–20.
165. Sonntag, H., H. U. Wittchen, M. Hofler, R. C. Kessler, and M. B. Stein. 2000. Are social fears and DSM-IV social anxiety disorder associated with smoking and nicotine dependence in adolescents and young adults? *European Psychiatry* 15 (1): 67–74.
166. Goodwin, R., and S. P. Hamilton. 2002. Cigarette smoking and panic: The role of neuroticism. *American Journal of Psychiatry* 159 (7): 1208–13.
167. Zvolensky, M. J., M. O. Bonn-Miller, M. T. Feldner, E. Leen-Feldner, A. C. McLeish, and K. Gregor. 2006. Anxiety sensitivity: Concurrent associations with negative affect smoking motives and abstinence self-confidence among young adult smokers. *Addictive Behaviors* 31 (3): 429–39.
168. Kassel, J. D., L. R. Stroud, and C. A. Paronis. 2003. Smoking, stress, and negative affect: Correlation, causation, and context across stages of smoking. *Psychological Bulletin* 129 (2): 270–304.
169. Cooney, R. E., L. Y. Atlas, J. Joormann, F. Eugene, and I. H. Gotlib. 2006. Amygdala activation in the processing of neutral faces in social anxiety disorder: Is neutral really neutral? *Psychiatry Research* 148 (1): 55–59.
170. Stein, M. B., A. N. Simmons, J. S. Feinstein, and M. P. Paulus. 2007. Increased amygdala and insula activation during emotion processing in anxiety-prone subjects. *American Journal of Psychiatry* 164 (2): 318–27.
171. Chen, K., and J. C. Shih. 1998. Monoamine oxidase A and B: Structure, function, and behavior. *Advances in Pharmacology* 42: 292–96.
172. Lenders, J. W., H. G. Brunner, D. L. Murphy, and G. Eisenhofer. 1998. Genetic deficiencies of monoamine oxidase enzymes: A key to understanding the function of the enzymes in humans. *Advances in Pharmacology* 42: 297–301.
173. Lesch, K. P., D. Bengel, A. Heils, S. Z. Sabol, B. D. Greenberg, S. Petri, J. Benjamin, C. R. Muller, D. H. Hamer, and D. L. Murphy. 1996. Association of anxiety-related traits with a polymorphism in the serotonin transporter gene regulatory region. *Science* 274 (5292): 1527–31.
174. Depue, R. A., and M. F. Lenzenweger. 2004. A neurobehavioral model of personality disturbance. In *Major theories of personality disorder*, 2nd ed., ed. M. F. Lenzenweger and J. F. Clarkin, 391–453. New York: Guilford.
175. Davidson, R. J., J. R. Marshall, A. J. Tomarken, and J. B. Henriques. 2000. While a phobic waits: Regional brain electrical and autonomic activity in social phobics during anticipation of public speaking. *Biological Psychiatry* 47 (2): 85–95.
176. Fox, N. A., H. A. Henderson, P. J. Marshall, K. E. Nichols, and M. M. Ghera. 2005. Behavioral inhibition: Linking biology and behavior within a developmental framework. *Annual Review of Psychology* 56: 235–62.
177. Henderson, H. A., N. A. Fox, and K. H. Rubin. 2001. Temperamental contributions to social behavior: The moderating roles of frontal EEG asymmetry and gender. *Journal of the American Academy of Child Adolescent Psychiatry* 40 (1): 68–74.
178. Shankman, S. A., C. E. Tenke, G. E. Bruder, C. E. Durbin, E. P. Hayden, and D. N. Klein. 2005. Low positive emotionality in young children: Association with EEG asymmetry. *Development and Psychopathology* 17 (1): 85–98.
179. Hare, T. A., N. Tottenham, M. C. Davidson, G. H. Glover, and B. J. Casey. 2005. Contributions of amygdala and striatal activity in emotion regulation. *Biological Psychiatry* 57 (6): 624–32.
180. Hettema, J. M., P. Annas, M. C. Neale, K. S. Kendler, and M. Fredrikson. 2003. A twin study of the genetics of fear conditioning. *Archives of General Psychiatry* 60 (7): 702–8.
181. Gunnar, M. R. 1994. Psychoendocrine studies of temperament and stress in early childhood: Expanding current models. In *Temperament: Individual differences at the interface of biology and behavior*, ed. J. E. Bates and T. D. Wachs, 175–98. Washington, DC: American Psychological Association.
182. Gunnar, M. R. 2003. Integrating neuroscience and psychological approaches in the study of early experiences. *Annals of*

- the New York Academy of Sciences* 1008: 238–47.
183. McBurnett, K., B. B. Lahey, P. J. Frick, C. Risch, R. Loeber, E. L. Hart, M. A. Christ, and K. S. Hanson. 1991. Anxiety, inhibition, and conduct disorder in children: 2. Relation to salivary cortisol. *Journal of the American Academy of Child & Adolescent Psychiatry* 30 (2): 192–96.
 184. Barkley, R. A. 2003. Issues in the diagnosis of attention-deficit/hyperactivity disorder in children. *Brain Development* 25 (2): 77–83.
 185. Fergusson, D. M., and L. J. Horwood. 1993. The structure, stability and correlations of the trait components of conduct disorder, attention deficit and anxiety/withdrawal reports. *Journal of Child Psychology and Psychiatry* 34 (5): 749–66.
 186. Lahey, B. B., W. E. Pelham, J. Loney, S. S. Lee, and E. Willcutt. 2005. Instability of the DSM-IV subtypes of ADHD from preschool through elementary school. *Archives of General Psychiatry* 62 (8): 896–902.
 187. Nigg, J. T. 2006. *What causes ADHD? Toward a multi-path model for understanding what goes wrong and why*. New York: Guilford Press.
 188. Nigg, J. T., S. P. Hinshaw, and C. Huang-Pollack. 2006. Disorders of attention and impulse regulation. In *Developmental psychopathology, vol. 3, risk, disorder, and adaptation*, 2nd ed., ed. D. Cicchetti and D. Cohen, 358–403. New York: Wiley.
 189. Clark, D. B., and J. Cornelius. 2004. Childhood psychopathology and adolescent cigarette smoking: A prospective survival analysis in children at high risk for substance use disorders. *Addictive Behaviors* 29 (4): 837–41.
 190. Galera, C., E. Fombonne, J. F. Chastang, and M. Bouvard. 2005. Childhood hyperactivity-inattention symptoms and smoking in adolescence. *Drug and Alcohol Dependence* 78 (1): 101–8.
 191. Kimm, S. Y., N. W. Glynn, A. M. Kriska, B. A. Barton, S. S. Kronsberg, S. R. Daniels, P. B. Crawford, Z. I. Sabry, and K. Liu. 2002. Decline in physical activity in black girls and white girls during adolescence. *New England Journal of Medicine* 347 (10): 709–15.
 192. Milberger, S., J. Biederman, S. V. Faraone, L. Chen, and J. Jones. 1997. ADHD is associated with early initiation of cigarette smoking in children and adolescents. *Journal of the American Academy of Child & Adolescent Psychiatry* 36 (1): 37–44.
 193. Molina, B. S., and W. E. Pelham Jr. 2003. Childhood predictors of adolescent substance use in a longitudinal study of children with ADHD. *Journal of Abnormal Psychology* 112 (3): 497–507.
 194. Rohde, P., C. W. Kahler, P. M. Lewinsohn, and R. A. Brown. 2004. Psychiatric disorders, familial factors, and cigarette smoking: II. Associations with progression to daily smoking. *Nicotine & Tobacco Research* 6 (1): 119–32.
 195. Tercyak, K. P., C. Lerman, and J. Audrain. 2002. Association of attention-deficit/hyperactivity disorder symptoms with levels of cigarette smoking in a community sample of adolescents. *Journal of the American Academy of Child Adolescent Psychiatry* 41 (7): 799–805.
 196. Whalen, C. K., L. D. Jamner, B. Henker, R. J. Delfino, and J. M. Lozano. 2002. The ADHD spectrum and everyday life: Experience sampling of adolescent moods, activities, smoking, and drinking. *Child Development* 73 (1): 209–27.
 197. Kollins, S. H., F. J. McClernon, and B. F. Fuemmeler. 2005. Association between smoking and attention-deficit/hyperactivity disorder symptoms in a population-based sample of young adults. *Archives of General Psychiatry* 62 (10): 1142–7.
 198. Lambert, N. M., and C. S. Hartsough. 1998. Prospective study of tobacco smoking and substance dependencies among samples of ADHD and non-ADHD participants. *Journal of Learning Disabilities* 31 (6): 533–44.
 199. Lerman, C., J. Audrain, K. Tercyak, L. W. Hawk Jr., A. Bush, S. Crystal-Mansour, C. Rose, R. Niaura, and L. H. Epstein. 2001. Attention-deficit hyperactivity disorder (ADHD) symptoms and smoking patterns among participants in a smoking-cessation program. *Nicotine & Tobacco Research* 3 (4): 353–59.
 200. Flory, K., and D. R. Lynam. 2003. The relation between attention deficit hyperactivity disorder and substance abuse: What role does conduct disorder play? *Clinical Child and Family Psychology Review* 6 (1): 1–16.
 201. Potter, A. S., and P. A. Newhouse. 2004. Effects of acute nicotine administration on behavioral inhibition in adolescents with attention-deficit/hyperactivity disorder. *Psychopharmacology (Berl)* 176 (2): 182–94.
 202. Barkley, R. A., M. Fischer, C. S. Edelbrock, and L. Smallish. 1990. The adolescent

- outcome of hyperactive children diagnosed by research criteria: I. An 8-year prospective follow-up study. *Journal of the American Academy of Child Adolescent Psychiatry* 29 (4): 546–57.
203. Burke, J. D., R. Loeber, and B. B. Lahey. 2001. Which aspects of ADHD are associated with tobacco use in early adolescence? *Journal of Child Psychology and Psychiatry* 42 (4): 493–502.
204. Lynskey, M. T., and D. M. Fergusson. 1995. Childhood conduct problems, attention deficit behaviors, and adolescent alcohol, tobacco, and illicit drug use. *Journal of Abnormal and Child Psychology* 23 (3): 281–302.
205. Disney, E. R., I. J. Elkins, M. McGue, and W. G. Iacono. 1999. Effects of ADHD, conduct disorder, and gender on substance use and abuse in adolescence. *American Journal of Psychiatry* 156 (10): 1515–21.
206. Abrantes, A. M., D. R. Strong, S. E. Ramsey, P. M. Lewinsohn, and R. A. Brown. 2005. Substance use disorder characteristics and externalizing problems among inpatient adolescent smokers. *Journal of Psychoactive Drugs* 37 (4): 391–99.
207. Willcutt, E. G., B. F. Pennington, R. K. Olson, N. Chhabildas, and J. Hulslander. 2005. Neuropsychological analyses of comorbidity between reading disability and attention deficit hyperactivity disorder: In search of the common deficit. *Developmental Neuropsychology* 27 (1): 35–78.
208. Faraone, S. V., R. H. Perlis, A. E. Doyle, J. W. Smoller, J. J. Goralnick, M. A. Holmgren, and P. Sklar. 2005. Molecular genetics of attention-deficit/hyperactivity disorder. *Biological Psychiatry* 57 (11): 1313–23.
209. Losier, B. J., P. J. McGrath, and R. M. Klein. 1996. Error patterns on the continuous performance test in non-medicated and medicated samples of children with and without ADHD: A meta-analytic review. *Journal of Child Psychology and Psychiatry* 37 (8): 971–87.
210. Clarke, A. R., R. J. Barry, R. McCarthy, M. Selikowitz, D. C. Clarke, and R. J. Croft. 2003. Effects of stimulant medications on children with attention-deficit/hyperactivity disorder and excessive beta activity in their EEG. *Clinical Neurophysiology* 114 (9): 1729–37.
211. Wong, M. M., K. J. Brower, and R. A. Zucker. 2009. Childhood sleep problems, early onset of substance use and behavioral problems in adolescence. *Sleep Medicine*.
212. Upadhyaya, H. P., K. T. Brady, M. Wharton, and J. Liao. 2003. Psychiatric disorders and cigarette smoking among child and adolescent psychiatry inpatients. *American Journal on Addictions* 12 (2): 144–52.
213. Krueger, R. F., B. M. Hicks, C. J. Patrick, S. R. Carlson, W. G. Iacono, and M. McGue. 2002. Etiologic connections among substance dependence, antisocial behavior, and personality: Modeling the externalizing spectrum. *Journal of Abnormal Psychology* 111 (3): 411–24.
214. Delfino, R. J., L. D. Jamner, and C. K. Whalen. 2001. Temporal analysis of the relationship of smoking behavior and urges to mood states in men versus women. *Nicotine & Tobacco Research* 3 (3): 235–48.
215. Jamner, L. D., D. Shapiro, and M. E. Jarvik. 1999. Nicotine reduces the frequency of anger reports in smokers and nonsmokers with high but not low hostility: An ambulatory study. *Experimental and Clinical Psychopharmacology* 7 (4): 454–63.
216. Fallon, J. H., D. B. Keator, J. Mbogori, J. Turner, and S. G. Potkin. 2004. Hostility differentiates the brain metabolic effects of nicotine. *Brain research. Cognitive brain research* 18 (2): 142–8.
217. Spear, L. P. 2000. The adolescent brain and age-related behavioral manifestations. *Neuroscience and Biobehavioral Reviews* 24 (4): 417–63.
218. Loeber, R., J. D. Burke, B. B. Lahey, A. Winters, and M. Zera. 2000. Oppositional defiant and conduct disorder: A review of the past 10 years, part I. *Journal of the American Academy of Child Adolescent Psychiatry* 39 (12): 1468–84.
219. Lahey, B. B., S. H. Goodman, I. D. Waldman, H. Bird, G. Canino, P. Jensen, D. Regier, P. J. Leaf, R. Gordon, and B. Applegate. 1999. Relation of age of onset to the type and severity of child and adolescent conduct problems. *Journal of Abnormal and Child Psychology* 27 (4): 247–60.
220. Nigg, J. T., and N. Breslau. 2007. Prenatal smoking exposure, low birth weight, and disruptive behavior disorders. *Journal of the American Academy of Child Adolescent Psychiatry* 46 (3): 362–9.
221. Young, S. E., M. C. Stallings, R. P. Corley, K. S. Krauter, and J. K. Hewitt. 2000. Genetic and environmental influences on

- behavioral disinhibition. *American Journal of Medical Genetics* 96 (5): 684–95.
222. Depue, R. A., and M. R. Spont. 1986. Conceptualizing a serotonin trait: A behavioral dimension of constraint. *Annals of the New York Academy of Sciences* 487: 47–62.
223. Eisenberg, N., A. Sadovsky, T. L. Spinrad, R. A. Fabes, S. H. Losoya, C. Valiente, M. Reiser, A. Cumberland, and S. A. Shepard. 2005. The relations of problem behavior status to children's negative emotionality, effortful control, and impulsivity: Concurrent relations and prediction of change. *Developmental Psychology* 41 (1): 193–211.
224. Nigg, J. T., and B. J. Casey. 2005. An integrative theory of attention-deficit/hyperactivity disorder based on the cognitive and affective neurosciences. *Development and Psychopathology* 17 (3): 785–806.
225. Hariri, A. R., V. S. Mattay, A. Tessitore, F. Fera, and D. R. Weinberger. 2003. Neocortical modulation of the amygdala response to fearful stimuli. *Biological Psychiatry* 53 (6): 494–501.
226. Ochsner, K. N., R. D. Ray, J. C. Cooper, E. R. Robertson, S. Chopra, J. D. Gabrieli, and J. J. Gross. 2004. For better or for worse: Neural systems supporting the cognitive down- and up-regulation of negative emotion. *NeuroImage* 23 (2): 483–99.
227. Potter, A. S., P. A. Newhouse, and D. J. Bucci. 2006. Central nicotinic cholinergic systems: A role in the cognitive dysfunction in attention-deficit/hyperactivity disorder? *Behavioural Brain Research* 175 (2): 201–11.
228. Logan, B. K., P. N. Friel, and G. A. Case. 1994. Analysis of sertraline (Zoloft) and its major metabolite in postmortem specimens by gas and liquid chromatography. *Journal of Analytical Toxicology* 18 (3): 139–42.
229. Aron, A. R., S. Monsell, B. J. Sahakian, and T. W. Robbins. 2004. A componential analysis of task-switching deficits associated with lesions of left and right frontal cortex. *Brain* 127 (Pt 7): 1561–73.
230. Aron, A. R., and R. A. Poldrack. 2006. Cortical and subcortical contributions to stop signal response inhibition: Role of the subthalamic nucleus. *Journal of Neuroscience* 26 (9): 2424–33.
231. Hanes, D. P., W. F. Patterson 2nd, and J. D. Schall. 1998. Role of frontal eye fields in countermanding saccades: Visual, movement, and fixation activity. *Journal of Neurophysiology* 79 (2): 817–34.
232. Friedman, N. P., and A. Miyake. 2004. The relations among inhibition and interference control functions: A latent-variable analysis. *Journal of Experimental Psychology General* 133 (1): 101–35.
233. Kuntsi, J., H. Rogers, G. Swinard, N. Borger, J. van der Meere, F. Rijdsdijk, and P. Asherson. 2006. Reaction time, inhibition, working memory and 'delay aversion' performance: Genetic influences and their interpretation. *Psychological Medicine* 36 (11): 1613–24.
234. Friedman, D., and Y. M. Cycowicz. 2006. Repetition priming of possible and impossible objects from ERP and behavioral perspectives. *Psychophysiology* 43 (6): 569–78.
235. Willcutt, E. G., N. Chhabildas, L. C. Bidwell, and B. F. Pennington. Forthcoming. A twin study of the validity of the executive function theory of ADHD.
236. Friedman, N. P., A. Miyake, S. E. Young, J. C. Defries, R. P. Corley, and J. K. Hewitt. 2008. Individual differences in executive functions are almost entirely genetic in origin. *Journal of Experimental Psychology General* 137 (2): 201–25.
237. Bekker, E. M., K. B. Bocker, F. Van Hunsel, M. C. van den Berg, and J. L. Kenemans. 2005. Acute effects of nicotine on attention and response inhibition. *Pharmacology, Biochemistry, and Behavior* 82 (3): 539–48.
238. Mitchell, S. H. 2004. Measuring impulsivity and modeling its association with cigarette smoking. *Behavioral and Cognitive Neuroscience Reviews* 3 (4): 261–75.
239. Hall, M. H., K. Schulze, F. Rijdsdijk, M. Picchioni, U. Ettinger, E. Bramon, R. Freedman, R. M. Murray, and P. Sham. 2006. Heritability and reliability of P300, P50 and duration mismatch negativity. *Behavior Genetics* 36 (6): 845–57.
240. van Beijsterveldt, C. E., and G. C. van Baal. 2002. Twin and family studies of the human electroencephalogram: A Review and a meta-analysis. *Biological Psychology* 61 (1–2): 111–38.
241. Yoon, H. H., W. G. Iacono, S. M. Malone, and M. McGue. 2006. Using the brain P300 response to identify novel phenotypes reflecting genetic vulnerability for adolescent substance misuse. *Addictive Behaviors* 31 (6): 1067–87.
242. Patrick, C. J., E. M. Bernat, S. M. Malone, W. G. Iacono, R. F. Krueger, and M. McGue. 2006. P300 amplitude as an indicator of externalizing in adolescent males. *Psychophysiology* 43 (1): 84–92.

243. Iacono, W. G., S. M. Malone, and M. McGue. 2003. Substance use disorders, externalizing psychopathology, and P300 event-related potential amplitude. *International Journal of Psychophysiology* 48 (2): 147–78.
244. Anokhin, A. P., A. B. Vedeniapin, E. J. Sirevaag, L. O. Bauer, S. J. O'Connor, S. Kuperman, B. Porjesz, et al. 2000. The P300 brain potential is reduced in smokers. *Psychopharmacology (Berl)* 149 (4): 409–13.
245. Domino, E. F., and T. Kishimoto. 2002. Tobacco smoking increases gating of irrelevant and enhances attention to relevant tones. *Nicotine & Tobacco Research* 4 (1): 71–7.
246. Barkley, R. A. 1997. Behavioral inhibition, sustained attention, and executive functions: Constructing a unifying theory of ADHD. *Psychological Bulletin* 121 (1): 65–94.
247. Kane, M. J., M. K. Bleckley, A. R. Conway, and R. W. Engle. 2001. A controlled-attention view of working-memory capacity. *Journal of Experimental Psychology General* 130 (2): 169–83.
248. Willcutt, E. G. Forthcoming. ADHD. In *Pediatric neuropsychology: Research, theory, and practice*, ed. K. O. Yeats, D. Ris, D. Taylor, and B. F. Pennington. New York: Guilford Press.
249. Arnsten, A. F. 2001. Modulation of prefrontal cortical-striatal circuits: Relevance to therapeutic treatments for Tourette syndrome and attention-deficit hyperactivity disorder. *Advances in Neurology* 85: 333–41.
250. Altmann, E. M. 2004. Advance preparation in task switching: What work is being done? *Psychological Science* 15 (9): 616–22.
251. Campana, A., F. Macciardi, O. Gambini, and S. Scarone. 1996. The Wisconsin Card Sorting Test (WCST) performance in normal subjects: A twin study. *Neuropsychobiology* 34 (1): 14–17.
252. Giedd, J. N., J. E. Schmitt, and M. C. Neale. 2007. Structural brain magnetic resonance imaging of pediatric twins. *Human Brain Mapping* 28 (6): 474–81.
253. Peper, J. S., R. M. Brouwer, D. I. Boomsma, R. S. Kahn, and H. E. Hulshoff Pol. 2007. Genetic influences on human brain structure: A review of brain imaging studies in twins. *Human Brain Mapping* 28 (6): 464–73.
254. Casey, B. J., J. N. Epstein, J. Buhle, C. Liston, M. C. Davidson, S. T. Tonev, J. Spicer, et al. 2007. Frontostriatal connectivity and its role in cognitive control in parent-child dyads with ADHD. *American Journal of Psychiatry* 164 (11): 1729–36.
255. Matthews, S. C., A. N. Simmons, I. Strigo, K. Jang, M. B. Stein, and M. P. Paulus. 2007. Heritability of anterior cingulate response to conflict: An fMRI study in female twins. *NeuroImage* 38 (1): 223–7.
256. Calkins, S. D. 1997. Cardiac vagal tone indices of temperamental reactivity and behavioral regulation in young children. *Developmental Psychobiology* 31 (2): 125–35.
257. Calkins, S. D., and S. P. Keane. 2004. Cardiac vagal regulation across the preschool period: Stability, continuity, and implications for childhood adjustment. *Developmental Psychobiology* 45 (3): 101–12.
258. Porges, S. W., J. A. Doussard-Roosevelt, A. L. Portales, and S. I. Greenspan. 1996. Infant regulation of the vagal “brake” predicts child behavior problems: A psychobiological model of social behavior. *Developmental Psychobiology* 29 (8): 697–712.
259. Suess, P. E., S. W. Porges, and D. J. Plude. 1994. Cardiac vagal tone and sustained attention in school-age children. *Psychophysiology* 31 (1): 17–22.
260. Delis, D. C., E. Kaplan, and J. H. Kramer. 2001. *Delis-Kaplan executive function system*. San Antonio, TX: Psychological Corporation.
261. Posner, M. I., and S. E. Petersen. 1990. The attention system of the human brain. *Annual Review of Neuroscience* 13:25–42.
262. Cumberland-Li, A., N. Eisenberg, and M. Reiser. 2004. Relations of young children’s agreeableness and resiliency to effortful control and impulsivity. *Social Development* 13 (2): 191–212.
263. Anthony, J. C., L. A. Warner, and R. C. Kessler. 1994. Comparative epidemiology of dependence on tobacco, alcohol, controlled substances, and inhalants: Basic findings from the National Comorbidity Survey. *Experimental and Clinical Psychopharmacology* 2 (3): 244–68.
264. Robinson, L. A., D. M. Murray, C. M. Alfano, S. M. Zbikowski, J. L. Blitstein, and R. C. Klesges. 2006. Ethnic differences in predictors of adolescent smoking onset and escalation: A longitudinal study from 7th to 12th grade. *Nicotine & Tobacco Research* 8 (2): 297–307.

265. Sullivan, P. F., Y. Jiang, M. C. Neale, K. S. Kendler, and R. E. Straub. 2001. Association of the tryptophan hydroxylase gene with smoking initiation but not progression to nicotine dependence. *American Journal of Medical Genetics* 105 (5): 479–84.
266. Pomerleau, O. F. 1995. Individual differences in sensitivity to nicotine: Implications for genetic research on nicotine dependence. *Behavior Genetics* 25 (2): 161–77.
267. Perkins, K. A. 2002. Chronic tolerance to nicotine in humans and its relationship to tobacco dependence. *Nicotine & Tobacco Research* 4 (4): 405–22.
268. DiFranza, J. R., J. A. Savageau, N. A. Rigotti, K. Fletcher, J. K. Ockene, A. D. McNeill, M. Coleman, and C. Wood. 2002. Development of symptoms of tobacco dependence in youths: 30 month follow up data from the DANDY study. *Tobacco Control* 11 (3): 228–35.
269. Marks, M. J., J. A. Stitzel, and A. C. Collins. 1989. Genetic influences on nicotine responses. *Pharmacology, Biochemistry, and Behavior* 33 (3): 667–78.
270. Schechter, M. D., S. M. Meehan, and J. B. Schechter. 1995. Genetic selection for nicotine activity in mice correlates with conditioned place preference. *European Journal of Pharmacology* 279 (1): 59–64.
271. Gervais, A., J. O'Loughlin, G. Meshefedjian, C. Bancej, and M. Tremblay. 2006. Milestones in the natural course of onset of cigarette use among adolescents. *Canadian Medical Association Journal* 175 (3): 255–61.
272. Giovino, G. A. 2002. Epidemiology of tobacco use in the United States. *Oncogene* 21 (48): 7326–340.
273. Perkins, K. A., D. Gerlach, M. Broge, J. E. Grobe, M. Sanders, C. Fonte, J. Vender, C. Cherry, and A. Wilson. 2001. Dissociation of nicotine tolerance from tobacco dependence in humans. *Journal of Pharmacology and Experimental Therapeutics* 296 (3): 849–56.
274. Riedel, B. W., J. L. Blitstein, L. A. Robinson, D. M. Murray, and R. C. Klesges. 2003. The reliability and predictive value of adolescents' reports of initial reactions to smoking. *Nicotine & Tobacco Research* 5 (4): 553–59.
275. Stanton, W. R., and P. A. Silva. 1993. Consistency in children's recall of age of initiating smoking. *International Journal of Epidemiology* 22 (6): 1064–9.
276. Perkins, K. A., C. Lerman, S. Coddington, and J. L. Karelitz. 2008. Association of retrospective early smoking experiences with prospective sensitivity to nicotine via nasal spray in nonsmokers. *Nicotine & Tobacco Research* 10 (8): 1335–45.
277. Buka, S. L., E. D. Shenassa, and R. Niaura. 2003. Elevated risk of tobacco dependence among offspring of mothers who smoked during pregnancy: A 30-year prospective study. *American Journal of Psychiatry* 160 (11): 1978–84.
278. Le Foll, B., and S. R. Goldberg. 2006. Nicotine as a typical drug of abuse in experimental animals and humans. *Psychopharmacology (Berl)* 184 (3–4): 367–81.
279. Donny, E. C., S. T. Lanza, R. L. Balster, L. M. Collins, A. Caggiola, and P. P. Rowell. 2004. Using growth models to relate acquisition of nicotine self-administration to break point and nicotinic receptor binding. *Drug and Alcohol Dependence* 75 (1): 23–35.
280. Le, A. D., Z. Li, D. Funk, M. Shram, T. K. Li, and Y. Shaham. 2006. Increased vulnerability to nicotine self-administration and relapse in alcohol-naïve offspring of rats selectively bred for high alcohol intake. *Journal of Neuroscience* 26 (6): 1872–9.
281. Pierre, P. J., and P. Vezina. 1997. Predisposition to self-administer amphetamine: The contribution of response to novelty and prior exposure to the drug. *Psychopharmacology (Berl)* 129 (3): 277–84.
282. Suto, N., J. D. Austin, and P. Vezina. 2001. Locomotor response to novelty predicts a rat's propensity to self-administer nicotine. *Psychopharmacology (Berl)* 158 (2): 175–80.
283. Abreu-Villaca, Y., F. E. Queiroz-Gomes, A. P. Dal Monte, C. C. Filgueiras, and A. C. Manhaes. 2006. Individual differences in novelty-seeking behavior but not in anxiety response to a new environment can predict nicotine consumption in adolescent C57BL/6 mice. *Behavioural Brain Research* 167 (1): 175–82.
284. Henningfield, J. E., and R. M. Keenan. 1993. Nicotine delivery kinetics and abuse liability. *Journal of Consulting and Clinical Psychology* 61 (5): 743–50.
285. Perkins, K. A., D. Gerlach, M. Broge, C. Fonte, and A. Wilson. 2001. Reinforcing effects of nicotine as a function of smoking status. *Experimental and Clinical Psychopharmacology* 9 (3): 243–50.

286. Perkins, K. A., J. E. Grobe, D. Weiss, C. Fonte, and A. Caggiula. 1996. Nicotine preference in smokers as a function of smoking abstinence. *Pharmacology, Biochemistry, and Behavior* 55 (2): 257–63.
287. Perkins, K. A. 2004. Response to Dar and Frenk (2004), “Do smokers self-administer pure nicotine? A review of the evidence.” *Psychopharmacology (Berl)* 175 (2): 256–8.
288. Perkins, K. A., M. Broge, D. Gerlach, M. Sanders, J. E. Grobe, C. Cherry, and A. S. Wilson. 2002. Acute nicotine reinforcement, but not chronic tolerance, predicts withdrawal and relapse after quitting smoking. *Health Psychology* 21 (4): 332–39.
289. Hughes, J. R., G. L. Rose, and P. W. Callas. 2000. Do former smokers respond to nicotine differently from never smokers? A pilot study. *Nicotine & Tobacco Research* 2 (3): 255–62.
290. Perkins, K. A., C. Lerman, S. B. Coddington, C. Jetton, J. L. Karelitz, J. A. Scott, and A. S. Wilson. 2008. Initial nicotine sensitivity in humans as a function of impulsivity. *Psychopharmacology (Berl)* 200 (4): 529–44.
291. Perkins, K. A., M. Sanders, D. D’Amico, and A. Wilson. 1997. Nicotine discrimination and self-administration in humans as a function of smoking status. *Psychopharmacology (Berl)* 131 (4): 361–70.
292. Perkins, K. A., S. B. Coddington, J. L. Karelitz, C. Jetton, J. A. Scott, A. S. Wilson, and C. Lerman. 2009. Variability in initial nicotine sensitivity due to sex, history of other drug use, and parental smoking. *Drug and Alcohol Dependence* 99 (1–3): 47–57.
293. Perkins, K. A., C. Lerman, S. Coddington, C. Jetton, J. L. Karelitz, A. Wilson, J. R. Jennings, R. Ferrell, A. W. Bergen, and N. L. Benowitz. 2008. Gene and gene by sex associations with initial sensitivity to nicotine in nonsmokers. *Behavioural Pharmacology* 19 (5–6): 630–40.
294. Jackson, C., and D. Dickinson. 2004. Cigarette consumption during childhood and persistence of smoking through adolescence. *Archives of Pediatrics & Adolescent Medicine* 158 (11): 1050–56.
295. Karp, I., J. O’Loughlin, G. Paradis, J. Hanley, and J. DiFranza. 2005. Smoking trajectories of adolescent novice smokers in a longitudinal study of tobacco use. *Annals of Epidemiology* 15 (6): 445–52.
296. Hirschman, R. S., H. Leventhal, and K. Glynn. 1984. The development of smoking behavior: Conceptualization and supportive cross-sectional survey data. *Journal of Applied Social Psychology* 14 (3): 184–206.
297. DiFranza, J. R., J. A. Savageau, K. Fletcher, J. K. Ockene, N. A. Rigotti, A. D. McNeill, M. Coleman, and C. Wood. 2004. Recollections and repercussions of the first inhaled cigarette. *Addictive Behaviors* 29 (2): 261–72.
298. Ridenour, T. A., S. T. Lanza, E. C. Donny, and D. B. Clark. 2006. Different lengths of times for progressions in adolescent substance involvement. *Addictive Behaviors* 31 (6): 962–83.
299. Fidler, J. A., J. Wardle, N. H. Brodersen, M. J. Jarvis, and R. West. 2006. Vulnerability to smoking after trying a single cigarette can lie dormant for three years or more. *Tobacco Control* 15 (3): 205–09.
300. Slotkin, T. A. 2002. Nicotine and the adolescent brain: Insights from an animal model. *Neurotoxicology and Teratology* 24 (3): 369–84.
301. Everitt, B. J., and T. W. Robbins. 2005. Neural systems of reinforcement for drug addiction: From actions to habits to compulsion. *Nature Neuroscience* 8 (11): 1481–89.
302. Robinson, T. E., and K. C. Berridge. 2003. Addiction. *Annual Review of Psychology* 54: 25–53.
303. O’Connor, R. J., L. T. Kozlowski, D. J. Vandenberg, A. A. Strasser, M. D. Grant, and G. P. Vogler. 2005. An examination of early smoking experiences and smoking status in a national cross-sectional sample. *Addiction* 100 (9): 1352–57.
304. Barrett, S. P., I. Boileau, J. Okker, R. O. Pihl, and A. Dagher. 2004. The hedonic response to cigarette smoking is proportional to dopamine release in the human striatum as measured by positron emission tomography and [¹¹C]raclopride. *Synapse* 54 (2): 65–71.
305. Brody, A. L. 2006. Functional brain imaging of tobacco use and dependence. *Journal of Psychiatric Research* 40 (5): 404–18.
306. Pomerleau, C. S., O. F. Pomerleau, S. M. Snedecor, S. Gaulrapp, and S. L. Kardia. 2004. Heterogeneity in phenotypes based on smoking status in the Great Lakes Smoker Sibling Registry. *Addictive Behaviors* 29 (9): 1851–55.
307. Pomerleau, O. F., C. S. Pomerleau, A. M. Mehninger, S. M. Snedecor, and O. G. Cameron. 2005. Validation of

- retrospective reports of early experiences with smoking. *Addictive Behaviors* 30 (3): 607–11.
308. Fergusson, D. M., L. J. Horwood, M. T. Lynskey, and P. A. Madden. 2003. Early reactions to cannabis predict later dependence. *Archives of General Psychiatry* 60 (10): 1033–39.
309. Lambert, N. M., M. McLeod, and S. Schenk. 2006. Subjective responses to initial experience with cocaine: An exploration of the incentive-sensitization theory of drug abuse. *Addiction* 101 (5): 713–25.
310. Watson, D., L. A. Clark, and A. Tellegen. 1988. Development and validation of brief measures of positive and negative affect: The PANAS scales. *Journal of Personality and Social Psychology* 54 (6): 1063–70.
311. Diener, E., and R. A. Emmons. 1984. The independence of positive and negative affect. *Journal of Personality and Social Psychology* 47 (5): 1105–17.
312. McNair, D. M., M. Lorr, and L. F. Droppleman. 1992. *POMS manual: Profile of mood states*. San Diego: Educational and Industrial Testing Service.
313. Kalman, D. 2002. The subjective effects of nicotine: Methodological issues, a review of experimental studies, and recommendations for future research. *Nicotine & Tobacco Research* 4 (1): 25–70.
314. Perkins, K. A., C. Jetton, A. Stolinski, C. Fonte, and C. A. Conklin. 2003. The consistency of acute responses to nicotine in humans. *Nicotine & Tobacco Research* 5 (6): 877–84.
315. Pomerleau, O. F., C. S. Pomerleau, and R. J. Namemek. 1998. Early experiences with tobacco among women smokers, ex-smokers, and never-smokers. *Addiction* 93 (4): 595–9.
316. Brigham, J., C. N. Lessov-Schlaggar, H. S. Javitz, M. McElroy, R. Krasnow, and G. E. Swan. 2008. Reliability of adult retrospective recall of lifetime tobacco use. *Nicotine & Tobacco Research* 10 (2): 287–99.
317. Hu, M. C., M. Davies, and D. B. Kandel. 2006. Epidemiology and correlates of daily smoking and nicotine dependence among young adults in the United States. *American Journal of Public Health* 96 (2): 299–308.
318. Eissenberg, T., and R. L. Balster. 2000. Initial tobacco use episodes in children and adolescents: Current knowledge, future directions. *Drug and Alcohol Dependence* 59 Suppl. 1: S41–S60.
319. Blitstein, J. L., L. A. Robinson, D. M. Murray, R. C. Klesges, and S. M. Zbikowski. 2003. Rapid progression to regular cigarette smoking among nonsmoking adolescents: Interactions with gender and ethnicity. *Preventive Medicine* 36 (4): 455–63.
320. Chen, X., A. Stacy, H. Zheng, J. Shan, D. Spruijt-Metz, J. Unger, J. Gong, et al. 2003. Sensations from initial exposure to nicotine predicting adolescent smoking in China: A potential measure of vulnerability to nicotine. *Nicotine & Tobacco Research* 5 (4): 455–63.
321. Friedman, L. S., E. Lichtenstein, and A. Biglan. 1985. Smoking onset among teens: An empirical analysis of initial situations. *Addictive Behaviors* 10 (1): 1–13.
322. Rodriguez, D., and J. Audrain-McGovern. 2004. Team sport participation and smoking: Analysis with general growth mixture modeling. *Journal of Pediatric Psychology* 29 (4): 299–308.
323. Ehringer, M. A., H. V. Clegg, A. C. Collins, R. P. Corley, T. Crowley, J. K. Hewitt, C. J. Hopfer, et al. 2007. Association of the neuronal nicotinic receptor beta2 subunit gene (CHRNA2) with subjective responses to alcohol and nicotine. *American Journal of Medical Genetics Part B, Neuropsychiatric Genetics* 144B (5): 596–604.
324. Zeiger, J. S., B. C. Haberstick, I. Schlapfer, A. C. Collins, R. P. Corley, T. J. Crowley, J. K. Hewitt, et al. 2008. The neuronal nicotinic receptor subunit genes (CHRNA6 and CHRNA3) are associated with subjective responses to tobacco. *Human Molecular Genetics* 17 (5): 724–34.
325. Perkins, K. A., D. Gerlach, M. Broge, J. E. Grobe, and A. Wilson. 2000. Greater sensitivity to subjective effects of nicotine in nonsmokers high in sensation seeking. *Experimental and Clinical Psychopharmacology* 8 (4): 462–71.
326. Perkins, K. A. 1999. Baseline-dependency of nicotine effects: A review. *Behavioural Pharmacology* 10 (6–7): 597–615.
327. Acri, J. B., D. E. Morse, E. J. Popke, and N. E. Grunberg. 1994. Nicotine increases sensory gating measured as inhibition of the acoustic startle reflex in rats. *Psychopharmacology (Berl)* 114 (2): 369–74.
328. Perkins, K. A., L. H. Epstein, R. L. Stiller, J. E. Sexton, B. L. Marks, and R. G. Jacob. 1990. Cardiovascular effects of nicotine during physical activity and following meal consumption. *Clinical and Experimental*

- Pharmacology and Physiology* 17 (5): 327–34.
329. Kumari, V., P. A. Cotter, S. A. Checkley, and J. A. Gray. 1997. Effect of acute subcutaneous nicotine on prepulse inhibition of the acoustic startle reflex in healthy male non-smokers. *Psychopharmacology (Berl)* 132 (4): 389–95.
330. Poltavski, D. V., and T. Petros. 2006. Effects of transdermal nicotine on attention in adult non-smokers with and without attentional deficits. *Physiology & Behavior* 87 (3): 614–24.
331. Heishman, S. J., R. C. Taylor, and J. E. Henningfield. 1994. Nicotine and smoking: A review of effects on human performance. *Experimental and Clinical Psychopharmacology* 2 (4): 345–95.
332. Phillips, S., and P. Fox. 1998. An investigation into the effects of nicotine gum on short-term memory. *Psychopharmacology (Berl)* 140 (4): 429–33.
333. Min, S. K., I. W. Moon, R. W. Ko, and H. S. Shin. 2001. Effects of transdermal nicotine on attention and memory in healthy elderly non-smokers. *Psychopharmacology (Berl)* 159 (1): 83–8.
334. Kumari, V., J. A. Gray, D. H. ffytche, M. T. Mitterschiffthaler, M. Das, E. Zachariah, G. N. Vythelingum, S. C. Williams, A. Simmons, and T. Sharma. 2003. Cognitive effects of nicotine in humans: An fMRI study. *NeuroImage* 19 (3): 1002–13.
335. Dunne, M. P., D. Macdonald, and L. R. Hartley. 1986. The effects of nicotine upon memory and problem solving performance. *Physiology & Behavior* 37 (6): 849–54.
336. MacLeod, C. M. 1991. Half a century of research on the Stroop effect: An integrative review. *Psychological Bulletin* 109 (2): 163–203.
337. Cabeza, R., J. Mangels, L. Nyberg, R. Habib, S. Houle, A. R. McIntosh, and E. Tulving. 1997. Brain regions differentially involved in remembering what and when: A PET study. *Neuron* 19 (4): 863–70.
338. Zack, M., L. Belsito, R. Scher, T. Eissenberg, and W. A. Corrigall. 2001. Effects of abstinence and smoking on information processing in adolescent smokers. *Psychopharmacology (Berl)* 153 (2): 249–57.
339. Schneider, W., and R. M. Shiffrin. 1977. Controlled and automatic human information processing. I: Detection, search, and attention. *Psychological Review* 84 (1): 1–66.
340. Grobe, J. E., K. A. Perkins, J. Goettler-Good, and A. Wilson. 1998. Importance of environmental distractors in the effects of nicotine on short-term memory. *Experimental and Clinical Psychopharmacology* 6 (2): 209–16.
341. Schuh, K. J., L. M. Schuh, J. E. Henningfield, and M. L. Stitzer. 1997. Nicotine nasal spray and vapor inhaler: Abuse liability assessment. *Psychopharmacology (Berl)* 130 (4): 352–61.
342. Kassel, J. D., D. P. Evatt, J. E. Greenstein, M. C. Wardle, M. C. Yates, and J. C. Veilleux. 2007. The acute effects of nicotine on positive and negative affect in adolescent smokers. *Journal of Abnormal Psychology* 116 (3): 543–53.
343. Wellman, R. J., J. R. DiFranza, J. A. Savageau, and G. F. Dussault. 2004. Short term patterns of early smoking acquisition. *Tobacco Control* 13 (3): 251–57.
344. Collins, L. M., J. J. Graham, and B. P. Flaherty. 1998. An alternative framework for defining mediation. *Multivariate Behavioral Research* 33 (2): 295–312.
345. Shrout, P. E., and N. Bolger. 2002. Mediation in experimental and nonexperimental studies: New procedures and recommendations. *Psychological Methods* 7 (4): 422–45.
346. Flint, J., and M. R. Munafó. 2007. The endophenotype concept in psychiatric genetics. *Psychological Medicine* 37 (2): 163–80.

9

Nicotine-Dependence Endophenotypes in Chronic Smokers

Caryn Lerman, Kenneth A. Perkins, and Thomas J. Gould

A key area in understanding the biology of smoking behavior is the search for measures of smoking persistence, which, in turn, may help predict the likelihood of successful cessation among long-term users of tobacco. This chapter explores the existing evidence base for purported endophenotypes for nicotine dependence in chronic smokers and discusses measures in the following key areas:

- *Motivational measures, including reinforcement, as measured by self-administration of nicotine, and reward (i.e., the subjective evaluation of the hedonic effects of smoking)*
- *Sensory measures, including resting electroencephalogram (EEG) activity, event-related potentials (ERPs), and the prepulse inhibition (PPI) of startle response*
- *Measures of cognitive function, including attention and vigilance as well as working memory*
- *Measures of abstinence-induced and cue-induced craving*
- *Affective regulation and impulse control*

Each of these measures is examined from a standpoint of biological plausibility, objective measurement criteria, genetic influences, and association with nicotine dependence. Available research shows a relationship between motivational measures and dependence, as well as evidence of heritability and genetic associations for many sensory, cognitive, affective, and behavioral measures. Further research is indicated to establish the potential viability of measures such as these as endophenotypes for nicotine dependence.

The analyses described herein were supported in part by National Institutes of Health grants AA015515, CA/DA084718, DA017489, DA05807, and DA19478. The authors would like to thank Dr. Riju Ray for his assistance with the literature review.

Introduction

This chapter examines purported endophenotypes relevant to smoking persistence—that is, phenotypes that can be measured objectively in chronic smokers and that predict continued smoking versus cessation. Nicotine dependence requires chronic nicotine exposure, which produces neuroadaptive changes that promote continued smoking. First, a brief overview is provided of the evidence for specific genetic influences on nicotine dependence, a prerequisite in the search for valid endophenotypes. Then, two overarching areas of potential endophenotypes are covered: (1) measures of smoking’s “motivational effects” that directly reflect smoking persistence: smoking reinforcement (i.e., self-administration) and reward; and (2) measures of smoking’s other effects, and of responses to abstinence, on sensory processing, cognitive, affective, and behavioral (especially impulsivity) functions that may help explain smoking’s motivational influences. This latter section includes acute craving, or urge to smoke, because craving measures encompass each of these response dimensions. Also discussed are the potential endophenotype measures of smoking (and nicotine) effects in nondeprived smokers, abstinence-induced effects in nicotine-deprived smokers, and smoking’s reversal of these abstinence effects. As noted in chapter 8, endophenotypes can be conceptualized as one of three “subtypes”: (1) component phenotype, (2) intermediate phenotype, and (3) covariate.¹ While chapter 8 focused on intermediate phenotypes, or mechanisms believed to be part of the causal chain in the disorder, this chapter will emphasize component phenotypes, which capture one aspect of the multidimensional disorder phenotype but are not necessarily part of the causal chain. The focus here differs from that of the previous chapter; the population of interest in this chapter comprises those already dependent on nicotine (i.e., already “affected”). Therefore,

the potential endophenotypes to be discussed will be responses to nicotine or smoking, and other measures, that are believed to reflect the critical dimensions of the nicotine-dependence phenotype.

It is assumed that the motivational effects of smoking, the first area, are more proximal to persistence of smoking behavior, or dependence, virtually by definition, as they are usually indexed by measures capturing smoking- or nicotine-seeking behavior or its direct hedonic effects (reward). It is also assumed that the other effects of smoking and abstinence, the second area, are more distal to smoking persistence, again virtually by definition, as they are not indexed by measures of smoking-seeking behavior or direct hedonic effects but rather by responses on other dimensions that may or may not relate to smoking behavior. Thus, endophenotypes related to dependence may be identified as proximal or distal to smoking persistence. While this organization does not assume one area is more important than the other, it does presume that all factors promoting dependence in chronic smokers act by increasing smoking’s motivational effects. Consequently, this view also assumes a general pathway to smoking persistence; that is, various acute effects of smoking and abstinence serve to foster greater smoking reinforcement and reward, directly promoting smoking persistence (dependence).

For the first area, drug-motivated behavior is the centerpiece of any drug dependence. The existing criteria for diagnosing drug dependence in psychiatry emphasize persistence of drug use (i.e., self-administration) despite adverse consequences for the user.² Meeting all criteria that reflect persistence of smoking behavior is sufficient for a diagnosis of dependence, while meeting all criteria other than those reflecting persistence of smoking (namely, withdrawal) would not. Identification of potential endophenotypes

reflecting reinforcement may be relatively straightforward, as reinforcement is usually indexed by drug self-administration, a discrete behavior that can be measured acutely in the laboratory. Thus, individual differences in smoking or nicotine reinforcement in chronic smokers can be assessed objectively in a number of ways. These include measures of cigarette consumption or brief laboratory evaluations of self-administration of nicotine administered by novel means (e.g., gum, nasal spray). Within the area of motivational mechanisms, smoking or nicotine's "rewarding" (or hedonic) effects are included; these are direct evaluations of the smoking experience that may help explain reinforcement. Identification of endophenotypes of smoking reward may be more complicated because reward in humans is typically measured with self-report questionnaires. However, basic research with nonhuman animals suggests the possibility of more objective measures that reflect drug reward. This research will be discussed in terms of its potential applicability to identifying endophenotypes of smoking or nicotine reward in humans.

For the second broad area—that is, nicotine or abstinence effects—acute and chronic nicotine exposure produces physiological, cognitive, affective, and behavioral responses in both animals and humans. Chronic exposure, the focus of this chapter, can lead to deficits in these functions following smoking abstinence, reflecting the onset of withdrawal. Nicotine delivered acutely, via smoking or other delivery systems, may enhance function and often reverses abstinence-induced deficits. These effects of nicotine may, in turn, prompt smoking or nicotine-seeking behavior to enhance function and/or to ameliorate withdrawal symptoms. Thus, nicotine or abstinence effects can help explain smoking's motivational effects. Craving is included in this section because it purportedly contains elements of each response domain

covered here, including physiological, cognitive, affective, and behavioral aspects. Note that craving is separated here into two types: abstinence induced and cue induced. Although craving, especially abstinence induced, is typically measured via self-report, it may also be captured by objective measures being explored in human studies of cue-induced craving. In terms of endophenotype measures, relatively few of the objective measures of deficits or enhancements due to nicotine have been clearly related to dependence. This chapter will review existing measures, identify gaps in knowledge related to the viability of these measures as endophenotypes, and discuss future directions for identifying and validating nicotine-dependence endophenotypes in chronic smokers.

Finally, several formal self-report dependence measures have been developed to capture putative dimensions of dependence, and some have been related to ability to quit smoking, or smoking persistence, with varying predictive validity. These measures, such as the Fagerström Test for Nicotine Dependence (FTND),³ the Wisconsin Inventory of Smoking Dependence Motives,⁴ and the Nicotine Dependence Syndrome Scale,⁵ generally assess smoking patterns, smoking effects, and the consequences of abstinence as part of clinical research aimed at predicting quitting success. Such responses could reflect facets of the measures of interest here, specifically smoking persistence and reinforcement or reward (i.e., motivational effects), as well as effects experienced during smoking abstinence and sensitivity to acute nicotine effects on various responses (i.e., nicotine or abstinence effects). However, these self-report dependence measures will not be examined in this chapter. Instead, the goal of this chapter is to identify objective laboratory procedures that may reliably capture facets of smoking reinforcement or reward, effects of abstinence, and acute responses to smoking that relate to dependence. The description

Smoking Persistence Versus Smoking Onset: An Area for Endophenotype Research

Many of the processes involved in the onset of smoking are likely to be different from those involved in smoking persistence. Chapter 8 explores potential phenotypes and endophenotypes for nicotine dependence at or before nicotine exposure. The areas investigated include some measures similar to those in this chapter, such as nicotine reinforcement (self-administration) and reward, as well as other potential endophenotype areas such as latency and age of onset. This chapter focuses on purported endophenotypes relevant to smoking persistence—that is, phenotypes that can be measured objectively in chronic smokers and that predict continued smoking versus cessation, with inability to quit being the primary index of dependence in chronic smokers. These, in turn, have the potential to help understand the biology of tobacco use among a population at greatest risk for tobacco-related health problems.

of these self-report dependence measures and their relationship to dependence are comprehensively discussed in chapter 3 and described elsewhere.⁵

Rationale for Investigating Endophenotypes of Chronic Nicotine Exposure

Genetic Influences on Nicotine Dependence

Nicotine dependence, which underlies persistent smoking, is a complex trait, influenced by genetic and environmental factors. Twin studies indicate that approximately 60%–70% of the variance in nicotine dependence and smoking persistence is due to genetic influences.^{6,7} Further, at least 50% of the variance in successful quitting, given a quit attempt, is due to heritable factors.⁸ Nicotine dependence has a strong genetic association with alcohol dependence,⁹ and linkage studies have pointed to loci common to alcohol and nicotine-dependence susceptibility.¹⁰ Common genetic influences are also thought to contribute to nicotine

dependence, personality traits, and psychiatric conditions, such as attention deficit hyperactivity disorder (ADHD),¹¹ depression,¹² and schizophrenia;¹³ however, interactions of biological and environmental factors clearly play a role.¹⁴

Given consistent evidence for the heritability of nicotine dependence, attention has shifted to investigations of specific genetic influences. Genetic variation in enzymes (e.g., *CYP2A6*) that metabolize nicotine to its inactive forms (cotinine and 3-hydroxycotinine) influence peripheral levels of nicotine and smoking behaviors.¹⁵ Smokers who are genetically faster metabolizers of nicotine smoke more cigarettes per day, are more dependent on nicotine, and are more likely to relapse following transdermal nicotine replacement therapy (NRT) than are smokers who are slower metabolizers (e.g., carriers of *2, *4, *9A, and *12A alleles).^{16,17} Thus, measures of nicotine metabolism are important endophenotype measures.

Candidate genes in neurobiological pathways mediating drug reward have been extensively studied for associations with nicotine dependence. Nicotine binds to neuronal nicotinic acetylcholine receptors (nAChRs) expressed on dopamine and γ -aminobutyric acid (GABA) neurons in the ventral tegmental area (VTA), resulting in

increased dopamine release in the nucleus accumbens.^{14,18} Despite the importance of nAChRs in nicotine dependence, particularly the $\alpha 4\beta 2$ subtypes,¹⁹ data on the functional relevance of genetic polymorphisms are limited, with the possible exception of data on two functional variants in *CHRNA4*.²⁰ A few SNPs in *CHRNA4* have been examined for associations with nicotine dependence, but findings were not significant.²¹ However, a more comprehensive analysis of *CHRNA4* suggests that variation in *CHRNA4* is associated with smoking cessation.²²

In addition, there is growing evidence for association of *CHRNA4* haplotypes with nicotine dependence.^{23,24} Other work shows that haplotypes at the *CHRNA5-A3-B4* locus are associated with nicotine-dependence severity as indexed by the FTND among smokers who began smoking daily by 16 years of age, but not among those who began smoking after 16 years of age.²⁵ The age dependence of these findings highlight the notion, discussed in chapters 5–8, that influences on dependence susceptibility, including genetics, can vary by age.

Given the central role of dopamine signaling in the reinforcing and rewarding effects of nicotine, alcohol, and other addictive drugs,^{26–28} many initial studies focused on the common **TAQIA* polymorphism in a neighboring gene, *ANKKI*.²⁹ With respect to smoking behavior, some association studies have reported a higher prevalence of the low-activity *DRD2*TAQI AI* allele among smokers compared to nonsmokers,^{30,31} while other findings have been negative.³² Mixed results have also been reported for associations of a variable number tandem repeat (VNTR) polymorphism in the 3' end of the dopamine transporter (*SLC6A3*) gene with smoking behavior.^{33–35}

More robust findings have been observed for polymorphisms in *DRD2* with documented functional effects—for example, variants that alter transcription or translation. For instance, the promoter variant

DRD2-1A1C INS/DEL, associated with transcriptional efficiency, has been associated with response to pharmacotherapy for smoking cessation.³⁶ The reduced activity **7-repeat* allele of the *DRD4* gene VNTR has been associated with smoking persistence.^{37,38} The high-activity (**VAL*) allele of the *COMT* gene, associated with more rapid degradation of dopamine, has been associated with smoking persistence in a retrospective case-control study and in a prospective smoking cessation study.³⁹

Nicotine also increases levels of endogenous opioids that bind to mu opioid receptors on GABA interneurons in the VTA.²⁸ Consistent with neurobiological evidence, the mu opioid receptor (*OPRM1*) *ASN40ASP* functional variant has been associated with response to NRT; however, the direction of association in different populations has not been consistent.^{40,41} A study comparing smokers with high versus low levels of nicotine dependence did not find associations with this *OPRM1* variant; however, haplotype analysis suggests that other variants, which may be in linkage disequilibrium with the *ASN40ASP* polymorphism, are linked with this smoking phenotype.⁴² Finally, despite effects of nicotine on serotonin neurotransmission, there is no strong evidence linking smoking behavior or smoking cessation with genes in the serotonin pathway.^{43,44} Thus, it has proven difficult to identify candidate genes with robust, replicable associations with nicotine dependence and smoking persistence.

In addition to the candidate gene approach used in the studies above, specific genetic influences on nicotine dependence are being identified through linkage analysis and genome-wide association studies.^{45–48} Similar analyses have been performed to predict successful smoking cessation.⁴⁹ In contrast to the hypothesis-driven approach based on neurobiology described above, genome-wide studies have the potential to identify novel susceptibility loci that may not be

considered as a priori candidate genes. As with the candidate gene studies, findings from these approaches require independent validation. In addition, pharmacological challenge studies (e.g., dopamine depletion, agonist or antagonist compounds) may help to elucidate novel neurobiological pathways that influence endophenotypes of relevance to nicotine dependence.

The Case for Endophenotypes

As described in the introduction to chapter 8, one promising approach to elucidate the genetic basis of nicotine dependence is to study the underlying motivational, affective, and neurocognitive processes that underlie this complex phenotype.^{50,51} These intermediate measures of nicotine dependence, referred to as “endophenotypes,” are thought to be more proximal biologically to their genetic antecedents than are the complex behavioral phenotypes described above and, therefore, may provide a stronger genetic signal;⁵¹ however, this point is the subject of some debate.⁵² In the context of nicotine dependence, the optimal endophenotype measures would have a biologically plausible link to nicotine dependence and would be reliable, heritable, and valid (i.e., predictive of nicotine dependence, such as predicting smoking persistence versus abstinence after a quit attempt). Although many candidate endophenotype measures have *potential* utility in genetic studies of nicotine dependence, few meet all of these criteria.

Figure 9.1 illustrates the potential links between genes, neurochemical processes, and behavioral and physiological responses. Selected examples of genes coding for proteins involved in the biosynthesis, transport (e.g., *5-HTTLPR*), and metabolism (e.g., *COMT*) of neurotransmitters (e.g., serotonin, dopamine), and those coding for receptors (e.g., *DRD2*, *OPRM1*) are depicted in the shaded area. Also illustrated

are genes that code for nicotine-metabolizing enzymes (e.g., *CYP2A6*) and nAChRs that have been implicated in nicotine dependence (e.g., *CHRNA4*, *CHRNA7*, *CHRN2*). These neurochemical processes, in turn, influence the specific nicotine effects (e.g., effects on affect and cognition) or abstinence effects in chronic smokers that help explain smoking’s motivational effects. These processes may also directly affect those motivational effects. Measures of smoking’s various motivational effects (first area) and nicotine or abstinence effects (second area) are viewed here as potential endophenotypes of dependence. They differ primarily in their proximity to dependence, with the motivational effects more proximal, and nicotine or abstinence effects less proximal, to dependence.

In the sections below, evidence is described regarding the potential utility of different endophenotype measures associated with chronic exposure to nicotine and reflecting either of the two broad areas: smoking’s motivational effects or the acute effects of nicotine or abstinence that may promote those motivational effects. For each endophenotype construct, evidence is reviewed pertinent to the previously noted four criteria in the evaluation of the utility of each as endophenotypes: (1) biological plausibility—that is clinical evidence (typically involving self-report) linking a response area to dependence, as well as the neurobiological basis for specific nicotine effects, including findings from animal models, and preclinical evidence suggesting genetic influences on those effects; (2) reliability—standardized, objective measurement of the construct in humans; (3) heritability—evidence for genetic influences in humans from heritability, linkage, and candidate gene studies; and (4) predictive validity—evidence supporting a relationship of the measure to nicotine dependence in chronic smokers (i.e., smoking persistence). As will become readily apparent, evidence for the association of most endophenotype measures to nicotine

Figure 9.1 Example of How Potential Endophenotypes Can Link Genes to Nicotine-Dependence Risk

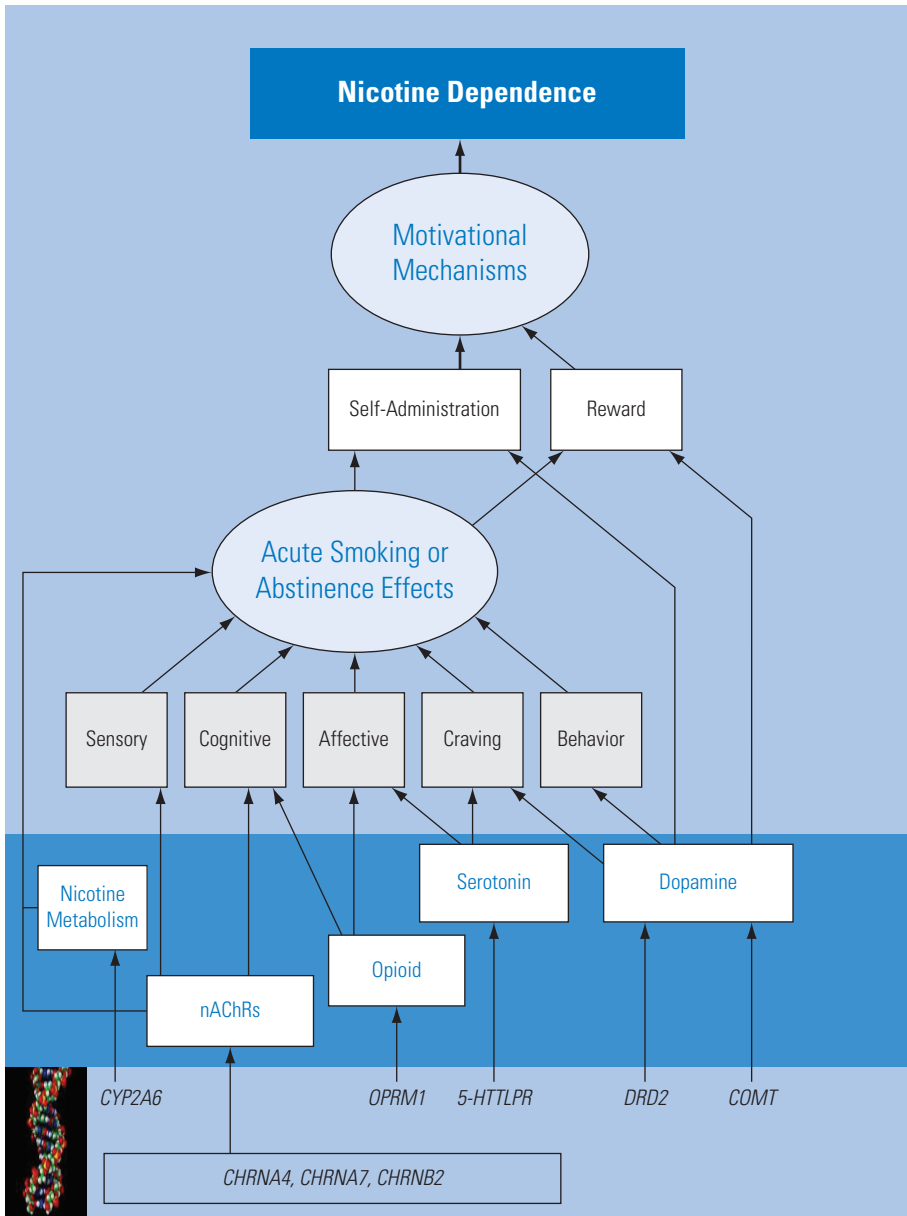

Note. Endophenotype areas are presented in gray squares, divided into motivational mechanisms and acute smoking or abstinence effects, the two broad areas outlined in the chapter. Selected examples of genes (bottom row) that contribute to neurotransmitter activity and receptor function (dark blue bar) related to these endophenotype areas can be identified. This figure is illustrative only and does not reflect a consensus on the factors responsible for neurotransmitter function or for the endophenotype areas.

dependence, the fourth criterion, is limited. Therefore, studies are included that are suggestive of an association, such as those documenting differences between smokers and nonsmokers, in addition to studies relating the endophenotype to validated dependence measures and to abstinence outcomes. For each endophenotype measure, the limitations as well as gaps in knowledge that may be addressed in future research are discussed. Also, since most research has focused on cigarette smoking, rather than on other forms of tobacco use, the focus will be on this aspect of nicotine dependence.

Motivational Mechanisms

Reinforcement

The concept of drug reinforcement is defined by the degree to which the drug is self-administered, or in other words, the degree to which it increases the probability of a behavior that leads to administration of that drug (such as pressing a lever or inhaling on a lit cigarette).⁵³ Such behavior is readily assessed in animal models, as well as in humans.

Biological Plausibility

Preclinical Research

Although diverse factors influence drug reinforcement, one common factor across all drugs of abuse is that they activate the mesolimbic dopaminergic system.^{54–56} Dopaminergic neurons in the VTA of the midbrain send efferent projections to areas involved in drug-motivated behavior (and reward) such as the nucleus accumbens, amygdala, and the prefrontal cortex.^{57–59} Nicotine stimulates the release of dopamine in the nucleus accumbens via effects at nAChRs in the VTA.^{60–63} However, it is not only activation of the nucleus

accumbens that mediates reinforcement but also the pattern of activation. Drug-related stimuli shift the firing of dopamine neurons from tonic or single-spike activity to a phasic pattern of activation.⁶⁴ Nicotine, via desensitization of $\alpha 4\beta 2$ nAChRs, shifts dopamine release in the nucleus accumbens to a phasic pattern of release.^{65,66} Thus, the reinforcing properties of nicotine may be related to the ability of nicotine to increase the phasic pattern of VTA activation and dopamine release.

Two routes of administration commonly used in animal research to assess the reinforcing effects of nicotine are intravenous (IV) nicotine self-administration and oral nicotine self-administration. The behavioral and pharmacological features of each approach are briefly reviewed next, with an emphasis on genetic analyses of reinforcement findings in preclinical models.

Intravenous Self-Administration

Multiple studies have demonstrated that rodents will self-administer IV nicotine.^{67–76} The most common procedure, developed by Corrigall and Coen,⁶⁸ was adapted from earlier methods of self-administration of other drugs in rodent models. In this IV self-administration procedure, rodents are presented with two levers in a test apparatus. Animals in the experimental group access an active lever, which results in jugular vein administration of nicotine, and an “inactive” lever that has no programmed consequences. The inactive lever is a control condition used to determine whether study procedures nonspecifically increase behavior (i.e., increase both active and inactive lever pressing via changes in general locomotor behavior) or specifically increase nicotine reinforcement behavior (i.e., active lever pressing only). For animals in the control group, the active lever delivers saline, while the inactive lever has no consequences; as expected, control animals emit low

levels of pressing on either lever. The rate of lever pressing is then compared between groups; a higher rate of pressing the active lever that delivers nicotine indicates that nicotine is reinforcing lever pressing.^{68,69,77} Importantly, responding for nicotine can be greatly enhanced by the stimuli associated with nicotine infusions, such that these stimuli (commonly called “cues”) become secondary reinforcers and able to support (i.e., reinforce) responding independent of nicotine availability.⁷⁸ Examples of such cues include tones and brief onset or offset of animal chamber lights. Other variations on this self-administration procedure have been used, such as by varying the particular behavior contingent on drug administration (e.g., a nose-poke response instead of lever pressing), but the basic study designs are essentially the same.

Evidence suggests that the reinforcing properties of IV nicotine self-administration result from nicotine-mediated activation of the mesolimbic dopamine system. First, rats will self-administer nicotine into the posterior VTA;⁷⁹ this demonstrates that nicotine effects in the VTA are sufficient to support nicotine self-administration. Second, disruption of dopaminergic processes in the VTA decreases IV nicotine self-administration. For example, the D1 antagonist SCH23390 and the D2 antagonist spiperone both decrease nicotine self-administration.⁸⁰ Furthermore, 6-hydroxydopamine (6-OHDA) lesions of the nucleus accumbens reduce dopamine levels in the nucleus accumbens by 92.9% and disrupt IV nicotine self-administration.⁸¹

Many different nAChRs exist in the human,¹⁹ but only a few appear to be potentially important for understanding nicotine dependence. In particular, the $\alpha 4\beta 2$ nAChRs are thought to mediate the reinforcing properties of nicotine. Dihydro-beta-erythroidine (DH β E), an nAChR antagonist with high affinity for the $\alpha 4\beta 2$ nAChRs, decreases nicotine self-administration,⁸²

and direct VTA infusion of DH β E decreases IV nicotine self-administration.⁸³ Self-administration of nicotine, but not cocaine (showing selectivity), is decreased in $\beta 2$ knockout mice compared to wild-type mice.^{84,85} These studies not only suggest the involvement of VTA dopamine processes in nicotine dependence but also suggest involvement of the $\alpha 4\beta 2$ nAChRs.

Comparison of IV nicotine self-administration across strains of rats suggests that natural genetic variance may influence IV nicotine self-administration. In a study comparing choice of IV nicotine self-administration across Sprague-Dawley rats, Long-Evans rats, Fischer 344 (F344) rats, and Lewis rats that were either preexposed to nicotine or saline for seven days before self-administration, Sprague-Dawley rats showed high levels of IV nicotine self-administration for all three doses tested (0.015, 0.03, and 0.06 milligrams per kilogram [mg/kg]/infusion) regardless of preexposure condition.⁸⁶ Long-Evans rats also self-administered nicotine; however, this was limited to rats in the saline preexposure condition and to higher doses of nicotine. Neither F344 nor Lewis rats reliably self-administered nicotine. Clearly, genetic differences in nicotine self-administration (and thus, reinforcement) exist.

Rats selectively bred for high versus low alcohol preference demonstrate a genetic influence on nicotine self-administration as well, suggesting a common genetic influence. Alcohol-preferring rats have twice the intake of IV nicotine as nonpreferring rats.⁸⁷ Mice bred for increased sensitivity for the sedative effects of alcohol are more sensitive to the effects of nicotine on thermoregulation and locomotor activity.^{88,89} In addition, mice bred for high sensitivity to the sedative effects of alcohol develop greater tolerance to nicotine than do mice bred for low sensitivity.⁹⁰ These findings in rodent models are consistent with the notion of individual differences

in vulnerability to comorbid alcohol and nicotine dependence in humans.⁹¹

Oral Self-Administration

In addition to IV self-administration, rodents will also self-administer nicotine orally.^{92–96} IV administration, used in rat models, is difficult to achieve with mice for a variety of practical reasons. Thus, oral self-administration is the common method for studying drug reinforcement in mice, although it is also used with rats. As a result, differences in results between IV and oral methods may often be due to species differences, although the kinetics of nicotine intake between these methods (rapid with IV, slow with oral) can also account for different results.⁹⁷

Multiple methods have been used successfully for oral self-administration. One is a 24-hour, free-access approach in which animals are individually housed in cages with two bottles—one bottle containing water and the other nicotine—and consumption is compared between bottles.⁹³ The restricted access method is a variant of the two-bottle-choice method. Animals are maintained on water restriction except for a given period (e.g., 2 hours/day) during which they have access to two tubes, one filled with water and the other filled with a nicotine solution.⁹² Another approach is to use an operant oral self-administration procedure; animals are water restricted except in the operant trials during which a response on one lever delivers a nicotine solution and a response on the other lever delivers water.⁹⁴ Finally, some studies have combined a sucrose solution with both the vehicle and nicotine in an effort to increase palatability, with the difference between nicotine and vehicle solutions indexing the reinforcing effects of nicotine.⁹⁶

Although methods may vary, oral self-administration of nicotine has been used to demonstrate genetic influences on nicotine intake in mice. Strain surveys

of inbred mice demonstrate that genetic variance contributes to differences in oral nicotine self-administration. C57BL/6 mice show a higher preference for oral nicotine than do DBA/2 mice in a two-bottle-choice paradigm;⁹⁸ the C57BL/6 mice also show greater preference for ethanol and amphetamine, and the DBA/2 show greater preference for aspartame. In an extensive strain survey of oral nicotine consumption using the two-bottle-choice test, the C57BL/6 strain consumed the most nicotine, followed in order of descending consumption by DBA/2 > BUB > A ≥ C3H ≥ ST/b mice.⁹⁹ Another strain survey compared oral nicotine self-administration in the following strains of mice: A/JxNMRI cross, C57BL/6, C3H/J, DBA/2, NMRI, ST/bJ; as in a study by Robinson and colleagues,⁹⁹ the C57BL/6 mice consumed the most nicotine and the ST/bJ mice consumed the least.¹⁰⁰ Strain survey results provide important information to guide the appropriate selection of experimental subjects on the basis of the research question and also provide important information for future genetic analysis.

Work from Collins's laboratory identified a single nucleotide polymorphism in the gene that codes for the $\alpha 4$ nAChR subunit, *CHRNA4*, that results in either alanine or threonine at position 529 on the $\alpha 4$ protein.¹⁰¹ This polymorphism alters $\alpha 4$ nAChR function and sensitivity to the behavioral effects of nicotine.^{101–103} To test whether the *CHRNA4* polymorphism alters nicotine preference, choice of nicotine consumption was compared across 14 strains of mice that differed in expression of the *A529* versus *T529* variant.¹⁰⁴ Strains with the *A529* variant of *CHRNA4* had significantly lower levels of nicotine consumption. Consistent with human data,^{20,23,24} these results demonstrate that an altered sequence of *CHRNA4* influences nicotine intake and, thus, could influence development and persistence of nicotine dependence.

Using data indicating that C57BL/6 mice show high levels of nicotine consumption and ST/b mice show low levels of nicotine consumption, a study investigated if alterations in expression of *Cyp2a5*—the homologue of the human gene *CYP2A6*, which codes for an enzyme involved in the metabolism of nicotine—were related to oral nicotine self-administration in mice.¹⁰⁵ F2 mice from a C57BL/6 and ST/b cross were segregated into high- and low-nicotine consumers, and levels of *Cyp2a5* protein were analyzed.¹⁰⁵ In male F2 mice, the high nicotine consumption was associated with higher levels of *Cyp2a5* protein and faster nicotine metabolism. This corresponds well with what is seen in smokers: smokers with a null *CYP2A6* allele smoke less and smokers with a duplicate copy of *CYP2A6* smoke more than do homozygous wild-type smokers.¹⁰⁶

The preclinical studies described above provide strong evidence for a biological basis of nicotine reinforcement—one key criterion for an endophenotype. In addition, evidence for strain differences in nicotine reinforcement paradigms supports the search for specific candidate genes and pathways that may underlie nicotine reinforcement measures in humans. Studies documenting effects of genetic and pharmacological manipulation on nicotine reinforcement in animal models point to specific candidate genes that can be tested for association in human studies.

Reinforcement-Enhancing Effects of Nicotine

Before proceeding to the overview of human research on nicotine reinforcement, it is important to note that nicotine may have a second reinforcing function, aside from the direct (primary) reinforcing effects noted above. As noted previously, stimuli accompanying nicotine infusions can become secondary reinforcers through their association with nicotine (i.e., cues). However, animal studies show that nicotine can enhance the reinforcing value of other

reinforcers *not* associated with nicotine intake. In this work, primarily conducted by Caggiula and colleagues (e.g., Chaudhri, et al. 2006¹⁰⁷), nicotine has been shown to enhance responding for reinforcement from stimuli, such as a light offset (darker environments are preferred by rodents), that are available independent of the responses for nicotine. In other words, in addition to the stimuli associated with nicotine infusion becoming secondary reinforcers that enhance responding for nicotine,⁷⁸ nicotine can enhance responding for other reinforcing stimuli, showing a dual reinforcing function. Nicotine's "reinforcement-enhancing" effects differ from the secondary reinforcing effects of cues in that the latter develop through associative processes requiring a contingency between the cues and nicotine administered in rapid fashion, while the former are nonassociative and can occur regardless of nicotine delivery speed.¹⁰⁷ Later work suggests that the reinforcing-enhancement effects of nicotine may occur in humans;¹⁰⁸ inadequate study of this phenomenon in humans, however, does not allow for extensive discussion of the potential for measures of the reinforcement-enhancing effects of nicotine as endophenotypes. However, this influence warrants greater attention in the broader field to help explain why smoking appears to acutely increase consumption of other reinforcers, such as alcohol.¹⁰⁹ It also may contribute crucially to understanding why smoking is so difficult to quit. Quitting smoking would remove not only the direct reinforcing effects from smoking, as is commonly the sole focus, but also these reinforcement-enhancing effects. This would lead to a lessening of reinforcement from many other reinforcers, causing greater deprivation than might be expected based on the observed direct reinforcing effects of nicotine.

Human Clinical Research

Additional evidence for biological plausibility of reinforcement measures as potential

endophenotypes comes from research linking clinical (self-report) measures of the amount and persistence of smoking reinforcement with the outcome of a subsequent quit attempt. Poorer outcome of a quit attempt is typically determined by faster time to relapse (i.e., shorter duration of abstinence), and secondarily, by more severe withdrawal. These results support the notion that objective (i.e. non-self-report) measures of smoking amount and persistence may be candidate endophenotypes.

The amount, or *frequency*, of cigarette consumption typically is assessed simply by self-report of number of cigarettes per day during “maintenance,” or when not attempting to cut down or quit. Greater number of cigarettes per day has been related to poorer outcome of a quit attempt (i.e., greater dependence) in that amount of smoking is often related to greater severity of withdrawal and to shorter time to relapse after a quit attempt.¹¹⁰ Measures of smoking *persistence* are also relevant, such as time to first cigarette of the day after waking; longer times are related to lower levels of dependence. While smoking frequency and persistence are not interchangeable (i.e., measure the same thing), they are also not independent in that greater amount of smoking is associated with faster time to first cigarette and shorter duration of prior quit attempts.¹¹¹ In any case, across various types of clinical trials or among self-quitters, a greater number of cigarettes per day (frequency) and faster time to first cigarette of the day (greater persistence) before quitting are associated with poorer cessation outcome—notably, shorter duration of abstinence and greater severity of withdrawal symptoms.^{112–114} Note that self-reported number of cigarettes per day and time to first cigarette are two items from the FTND self-report dependence measure³ that are most predictive of cessation outcome; together, they are sometimes used as the Heaviness of Smoking Index dependence measure.³ Those high on this index are less

able to quit, even for 24 hours, compared to those low on this index.¹¹⁵

After starting a quit attempt, any smoking at all (a lapse) strongly predicts eventual relapse, further illustrating the importance of smoking persistence (inability to refrain from smoking) as an index of dependence. This effect is very pronounced if the smoking occurs on the quit day itself (very strong smoking persistence),¹¹⁶ but remains strong even if it occurs after weeks of maintaining abstinence, whether with or without cessation medication.^{113,117,118} Smoking persistence appears to be a stable characteristic in that the faster a smoker resumes smoking (relapses) during a prior quit attempt, the greater the chances of relapsing during a subsequent quit attempt.¹¹³ Those who have never tried to quit at all (no prior demonstration of ability to refrain from smoking) also are typically less successful when they try to quit.

As suggested, smoking frequency can predict persistence during a given quit attempt in that those who smoked more cigarettes per day before quitting are more likely to lapse on the quit day or soon after quitting.¹¹⁷ Some studies have shown that after having quit, the amount (i.e., frequency) of smoking during the first lapse predicts faster occurrence of the second lapse and perhaps risk of full-blown relapse.¹¹⁹ In sum, whether before or after the quit attempt, self-report measures of frequency and persistence of smoking predict poorer outcome of a quit attempt, a key index of dependence.

Description of Potential Endophenotype Measures of Nicotine or Smoking Reinforcement

“Reinforcement” is a broad concept that is characterized by several dimensions and cannot be captured by a single measure,^{53,120} as evidenced by the separate consideration above of smoking frequency versus

persistence. Various short-term objective measures of reinforcement, and what they purport to assess, are outlined here. Some capture smoking frequency (e.g., ad lib self-administration), while others may reflect smoking persistence (e.g., progressive ratio). One approach, behavioral economics, may be able to model both. “Drug choice” is a separate concept that is not generally captured by dependence criteria of smoking frequency or persistence but that has been shown to relate to dependence in laboratory studies. Drug choice (i.e., nicotine preference) is the degree to which drug-containing substances are preferred over otherwise equivalent nondrug substances (e.g., placebo cigarettes). All of these procedures are derived from research on nicotine and other drugs of dependence with nonhuman animals. The biggest limitation of these measures of reinforcement is uncertain generalizability to smoking behavior in the natural environment.

Ad Libitum (ad lib) Drug Self-Administration

In the natural environment, nicotine delivery is usually accomplished with a fairly simple response—that is, puffing on a cigarette once it is lit (although more extensive behavior may be required to obtain the cigarettes). Thus, observation of smoking behavior, or ad lib self-administration, over a specific period of time may have the strongest face validity as an objective measure of reinforcement. A variation, adopted from animal research (described above), involves requiring the subject to make one response (e.g., pressing a computer key) that is reinforced by one unit of drug (e.g., a puff). This procedure assesses smoking intensity, amount (or rate) of consumption, or simple drug-taking behavior,⁵³ similar to the self-reported number of cigarettes per day.

Smoking consumption in the laboratory can be assessed by simply counting the number of cigarettes or individual puffs (usually from videotapes of the subjects). Consumption can also be measured indirectly by biochemical

indices of recent smoking exposure, such as blood nicotine level or expired-air carbon monoxide boost from before to after the session.¹²¹ The reliability of behavioral observation of smoke puffs is very high because it is a rather discrete behavior.¹²² The test-retest reliability of measures of ad lib smoking also tends to be high. In unpublished analyses, the authors of this chapter examined the correlation of puffs taken during a brief ad lib smoking period on each of two days in 54 smokers who had abstained overnight. The number of puffs correlated 0.67 ($p < .001$) between sessions, although latency to first puff, a measure of persistence, was not significantly correlated between sessions (0.18). This difference in reliability suggests that smoking persistence (as measured by latency to first puff) may be less reliable, and also, that persistence and frequency (as measured by total puffs) may capture different aspects of smoking reinforcement. Use of smoking topography devices, particularly the Clinical Research Support System,¹²³ can also provide an objective assessment of intake by quantifying puff volume, puff duration, interpuff interval, and puff velocity.¹²⁴ Amount of consumption of nicotine per se can also be assessed by providing smokers with novel nicotine delivery methods, such as nicotine spray or intravenous infusion, and perhaps gum.^{122,125,126}

A variation on this procedure is to require more than one response per drug unit received, such as providing one drug unit for every 5 or 10 responses, as commonly done in animal research (e.g., fixed ratio or variable ratio, reinforcement schedules; see also subsections on “Behavioral Economics” and “Progressive Ratio Measures” below). The greater the response requirement, the more drug-motivated behavior generated, up to a point. (Another variation that requires large amounts of responding and that exploits the important motivating effects of drug cues is the second-order schedule, which is not discussed here in detail, given its

rarity in human studies.) Beyond a certain point, the amount of responding required for a unit of drug becomes so great that self-administration is discouraged; this is essentially a means to assess persistence. This “breakpoint” is the key measure in the progressive ratio procedure, as discussed later, and is an important index of the reinforcing value of the drug.

While amount of ad lib smoking in a laboratory session appears to have face validity, relatively little effort has been made to show that those who smoke more under such conditions also smoke more outside the laboratory on a day-to-day basis. A more specific limitation of this approach is that drug satiation can occur quickly in even a brief laboratory session, thereby resulting in little subsequent drug-motivated behavior. Low rates of such behavior complicate the interpretation of comparisons between individuals in intensity of self-administration. This problem is reduced by use of schedules requiring multiple responses per reinforcement, noted previously. A third limitation is that because cigarettes contain much more than just nicotine (most substance abuse involves more than one component), self-administration of cigarettes does not necessarily index the reinforcing effects of nicotine per se (see “Nicotine Choice” below). Use of these procedures with novel nicotine delivery methods can determine nicotine reinforcement.

Nicotine Choice

The nicotine choice procedure more specifically addresses the degree to which the drug nicotine is reinforcing.¹²⁷ This procedure compares self-administration of one substance that contains a drug with another that is identical except for containing no drug (i.e., a placebo) and is analogous to use of active versus inactive lever pressing in animal studies, described previously. Here, the absolute levels of self-administration, or intensity, are not of primary interest, but rather, the difference in self-administration

between drug and placebo. Greater self-administration of the former versus the latter indicates that the drug itself is reinforcing. This procedure essentially assesses preference between two alternatives, one containing a drug and the other not, and it controls for virtually all nonpharmacological aspects of substance use (e.g., responses to conditioned cues), isolating the pharmacological effects. When choice is compared between conditions or groups, differences reflect the relative reinforcing value of nicotine (*relative* means greater choice in one condition or group versus the other, even if neither or both choose nicotine more than placebo). When the two substances are made available ad lib, this is often called a *concurrent choice procedure*.¹²²

Because subjects may vary markedly in overall drug self-administration frequency, comparisons of drug choice may be difficult between subjects. One common way to reduce this problem is to standardize the procedure by requiring a fixed number of choices (forced choice), spaced apart to avoid satiation, and determine whether the drug is chosen more often than the placebo.^{127,128} This approach is described in chapter 8; it is perhaps the only self-administration procedure that can be used with naive individuals with no prior experience with the drug. Other variations on choice can involve different drug doses (e.g., high-versus low-nicotine cigarette) or substances differing on other characteristics of interest (e.g., nicotine by nasal spray versus gum).

A limitation of this measure is that interpretation of results can be unclear. Choice of drug versus placebo is a function of the specific procedures—namely, the dose per drug use and the number of choices provided. Because drugs often have toxic or satiating effects, drug choice will be less as dose per administration and number of choices increase. Thus, whether or not the drug is chosen more than the placebo is specific to the procedures used, and

choosing the drug less than the placebo does not necessarily mean that the drug is not reinforcing. It is the relative difference in choice between conditions or individuals that is the important measure.

Behavioral Economics

Drug use in the natural environment can require more than a single simple response and may require engaging in extensive behavior (e.g., having to go outside to smoke at work, walking through snow to a store that sells cigarettes). Behavioral economics is one standard approach to determining how different response requirements for a drug affect intake. See Bickel and colleagues^{129,130} and Perkins and colleagues¹³¹ for a more thorough discussion of this approach. Typically, the number of responses (price) required per drug unit is manipulated, so that consumption of drug (demand) across increasing prices can be determined, forming a price-demand curve. Across low to moderate prices, consumption is usually maximal and unchanged, producing a curve that is flat in that responding can easily increase to meet the increasing behavioral prices of smoking. Demand is said to be inelastic, or unchanging, with respect to price, and responses here may reflect the individual's typical smoking frequency. At higher prices, however, responding continues to increase up to a point to meet increasing price, but responding eventually slows and consumption decreases (i.e., becomes elastic), indicating a limit to the price that a given individual will pay for the drug.

The higher this maximum behavioral price a subject will pay, the higher the maximum reinforcing value of the substance (similar to the breakpoint in the progressive ratio procedure), which may also reflect smoking persistence. Such an approach can comprehensively characterize differences in drug reinforcement due to various acute (e.g., medication) or chronic (e.g., individual differences in dependence) factors.¹³¹

For example, the price-demand curve may decrease across all prices (i.e., in parallel fashion), indicating an overall reduction in *frequency* of drug use and a drop in the reinforcing value of the drug. Alternatively, the price-demand curve may shift to the left, indicating that the demand for the drug is unaffected at most prices, but decreases only at high prices, such that the maximum price is smaller. This shift would suggest a selective drop in the maximum reinforcing value of the drug, but not an overall drop in the drug's reinforcing value, since responding does not change at lower prices. This outcome also indicates a decrease in the *persistence* of drug use. An important variation of this procedure involves examining changes in the price-demand curve as a function of the availability of alternative reinforcers, since drug use often involves choosing between the drug versus some alternative, such as money (e.g., buying cigarettes is a choice of cigarettes over money). Comparing the influence of various alternative reinforcers is a central focus of the behavioral economics approach because the price-demand curve can shift to the left if an attractive alternative is present.

This approach has some limitations. Obtaining the data to construct price-demand curves can be time-consuming in that a separate session may be needed to determine consumption at each given price, unless actual consumption is kept low to prevent satiation. (Otherwise, reduction in consumption caused by satiation will confound assessment of the reinforcing effects of smoking under conditions presented later in the session). Whether greater responding of the type required in laboratory sessions (e.g., pressing a computer key) corresponds to greater responses to obtain the drug in the natural environment is not known.

Progressive Ratio Measures

A key aspect of dependence is the persistence of drug use despite its costs. As described

above, persistence is commonly and directly assessed by determining the maximum amount of responses the individual will engage in for one unit of the drug. Formal behavioral economics approaches can have practical limitations, as noted, such as requiring multiple sessions to determine price-demand curves, with a single price, or reinforcement schedule, per session. The progressive ratio (PR) procedure provides a way to assess maximum price, or persistence, more efficiently, although it cannot also assess frequency, as can behavioral economics. In the PR procedure, the number of responses required per reinforcement (e.g., one puff) increases *within* the session, after each earned reinforcer, until the point at which responding for the drug is not maintained. The response requirement at that point, termed the “breakpoint,” is believed to index persistence of drug use, or incentive motivation.⁵³ The increase in response requirement is usually rapid (e.g., 30%–50% higher than prior requirement) to limit actual drug intake so that drug satiation does not interfere with assessment of maximum price (persistence). The breakpoint for smoke puffs is significantly associated with the maximum price paid for smoking (number of responses for one drug unit) in a behavioral economics paradigm,¹³² consistent with the notion that both reflect smoking persistence. Moreover, PR breakpoint is not related to choice measures, consistent with the notion that they tap different facets of reinforcement.¹³²

PR procedures have some limitations. First, the breakpoint, or highest completed reinforcement schedule, is a nonparametric measure, rather than a continuous measure, since only specific schedules of reinforcement are set. Thus, the number of these schedules completed, or reinforcers earned, is the dependent measure of interest. Because satiation must be avoided to allow a true measure of the breakpoint, the number of earned reinforcers must be small. One consequence of this procedure

is that statistical power can be limited in comparisons of breakpoints between individuals or conditions. Secondly, as in behavioral economics, whether greater responding of the type required in laboratory sessions corresponds to greater drug-seeking responses in the natural environment is not known.

Genetic Influences on Measures of Smoking Reinforcement in Humans

Although there is ample evidence supporting the heritability of nicotine dependence as assessed by self-report measures (chapter 2), no studies were found that parse out the relative contribution of genetic influences to laboratory-based measures of nicotine or smoking reinforcement. Despite this critical gap in the literature, evidence for rodent strain differences in nicotine self-administration and results of transgenic mouse studies (described above) provide a strong biological rationale for investigating the role of specific genetic factors in objective behavioral measures of smoking reinforcement. As far as known, only two studies have examined this question in humans.

As discussed above, individuals with low- or null-activity genetic variants of the nicotine-metabolizing enzyme CYP2A6 tend to smoke fewer cigarettes per day by both self-report and biochemical measures.¹⁷ To extend this assessment to objective laboratory-based measures of consumption, Strasser and colleagues¹³³ compared smoking topography indices in normal versus genetically slow nicotine metabolizers on the basis of the CYP2A6 genotype. Smokers carrying reduced- or null-activity CYP2A6 alleles (slow metabolizers) had significantly lower puff velocities than did normal metabolizers, controlling for gender and cigarette nicotine level. However, as discussed below, the relationship of smoking topography to nicotine dependence has not been thoroughly investigated.

A second study examined genetic associations with the relative reinforcing value of nicotine, as measured by a nicotine cigarette choice paradigm.¹³⁴ This analysis focused on the role of the functional *OPRM1* gene *A118G* variant and is based on preclinical evidence that nicotine reward is, in part, mediated by mu opioid receptors¹³⁵ and on clinical data supporting an association of this variant with smoking cessation.⁴⁰ In this double-blind, cross-over study, 60 smokers (30 with the *OPRM1* wild-type *AA* genotype and 30 with at least one reduced-activity **G* allele) participated in the nicotine cigarette choice paradigm following either four days of the mu opioid antagonist naltrexone or a placebo (order of study medication counterbalanced with a five- to seven-day washout period). This paradigm provided a choice between puffs of a denicotinized cigarette and a 0.6-mg nicotine cigarette over a three-hour period. The results revealed a significant *OPRM1* genotype by gender interaction. Among females, those with a reduced activity *OPRM1* **G* allele self-administered only 50% of puffs from the nicotine cigarette (and the other 50% from the denicotinized cigarette), compared to smokers with the *AA* genotype who took about 75% of puffs from the nicotine cigarette. Males, regardless of genotype, took about 75% of puffs from the nicotine cigarette. Secondary exploratory analyses from this study suggest that effects of *OPRM1* may be modified by genetic variation in the intracellular-signaling cyclic adenosine monophosphate–response element binding protein CREB1,¹³⁶ an effect consistent with preclinical research.¹³⁵

A later study examined genetic factors associated with the increase in ad lib smoking due to negative versus positive mood, as well as moderating influences of actual or expected nicotine content of cigarettes.¹³⁷ The increase in ad lib smoking amount due to negative mood was associated with *DRD2* **C957T* (*CC* > *TT* or *CT*), *SLC6A3* (presence of **9*-repeat > absence

of **9*-repeat), and among those given a nicotine cigarette, *DRD4* (presence of **7*-repeat > absence of **7*-repeat) and *DRD2/ANKKI* **TAQIA* (*TT* or *CT* > *CC*). Although no genetic studies were found using behavioral economics measures in smokers, there are data to support the role of specific polymorphisms in the relative reinforcing value of alcohol.¹³⁸

Relation of Smoking Reinforcement Measures to Dependence

Ad Lib Smoking

The relationship of ad lib smoking measures to nicotine dependence has been explored in very few studies. One way of approaching this is to determine whether ad lib smoking is sensitive to nicotine deprivation. For example, Perkins and colleagues¹³⁹ administered a placebo or 15 or 30 micrograms (μg)/kg nicotine by nasal spray every 30 minutes for 2.5 hours in smokers who had abstained overnight and found a dose-dependent decrease in ad lib puffs, cigarettes, and carbon monoxide boost from baseline. However, ad lib smoking may not be sensitive to slower methods of nicotine delivery, such as the nicotine patch.¹⁴⁰ Other procedural factors can moderate the sensitivity of this measure to pretreatment manipulations and medication.¹⁴¹ In a more direct association with dependence, one study found that pretreatment assessment of a very specific smoking topography measure of ad lib smoking—that is, typical size of puffs—predicts smoking cessation outcome in an NRT trial.¹²⁴ It is likely that the shorter the ad lib smoking period in a laboratory session, the weaker the expected link between smoking during that period and indices of dependence, given the restricted duration of smoking being sampled.

Nicotine Choice

Choice procedures have been used in a growing number of studies relating nicotine choice to some indices of dependence or to other manipulations of interest. Greater

choice of nicotine over placebo spray has been found in dependent smokers versus nonsmokers or former smokers, whether by nasal spray¹²⁸ or gum.¹⁴² However, questions about the relation of choice to dependence remain, as dependent and nondependent smokers did not differ in nicotine choice in one study.¹²⁸ Increasing the dose of the nicotine choice or extending the duration of the session may make this procedure more sensitive to differences in reinforcement between dependent and nondependent smokers. Nicotine choice (via gum) is greater in alcoholic smokers than in nonalcoholic smokers, who also differ in other indices of dependence, such as difficulty in quitting.¹⁴³ In addition, those who self-administer more nicotine than a placebo spray in a concurrent choice procedure also self-report smoking more cigarettes per day and tend to take more puffs from their preferred brand during a laboratory assessment of ad lib smoking.¹²²

These results suggest that greater nicotine versus placebo spray choice in this laboratory procedure is associated with a generally greater frequency of smoking intake in the natural environment. Overnight abstinence from smoking in dependent smokers increases choice of nicotine over placebo, whether by cigarette or nasal spray.¹²⁷ This influence of brief abstinence has also been shown when subjects were freely able to adjust nicotine intake independent of puff number via a smoke mixing device drawing smoke from nicotine versus denicotinized cigarettes.¹⁴⁴ Most important, choice of nicotine over placebo nasal spray in a forced choice procedure assessed before a quit attempt predicts greater severity of withdrawal in the week after quitting and faster time to relapse.¹⁴⁵ Thus, greater choice of nicotine versus placebo substances in this laboratory procedure has been associated with various indices of dependence and may serve as a promising endophenotype of dependence after chronic smoking exposure.

Behavioral Economics

Overnight abstinence increases responding for smoking versus the alternative of money,^{122,146,147} indicating greater frequency of smoking due to abstinence. Availability of nicotine gum may modestly attenuate responding for smoking,¹³⁰ further showing that nicotine deprivation can increase measures of smoking reinforcement via behavioral economics procedures. However, as far as known, neither the overall demand for smoking (frequency) nor the maximum price smokers will pay for smoking (persistence) before a quit attempt has been related to the outcome of that subsequent quit attempt.

PR Measures

As with prior procedures, overnight abstinence increases responding on a PR for smoke puffs.¹⁴⁸ The amount of responding on a PR for smoke puffs is greater for nicotine versus placebo cigarettes under some but not all conditions and in most but not all smokers.¹⁴⁸ For example, PR responses were greater for nicotine versus denicotinized cigarettes when the two were concurrently available, but much less so when they were available independently in different sessions, particularly in women.^{149,150} Yet, pretreatment with nicotine spray or patch only slightly and nonsignificantly reduces the breakpoint of responding for smoke puffs in smokers not trying to quit.¹⁵¹ Failure of nicotine pretreatment to alter the breakpoint for smoking is not unique to PR assessment; it has been seen with ad lib smoking and other reinforcement measures.^{139,141}

Smoking Reward

The definition of *reward* and its distinction from reinforcement and mood effects of smoking are discussed in the last part of chapter 8 (“Initial Nicotine Sensitivity Endophenotypes: Summary and Future Directions” section). In humans, reward reflects the hedonic value of a substance,

or the subjective evaluation of the substance's incentive motivating effects.⁵³ Its measurement, as with reinforcement, requires consumption of a substance, while most other self-report measures obtained in drug research (e.g., mood, craving) do not. Below, preclinical evidence is discussed supporting the biological plausibility of a genetic basis for nicotine reward, followed by discussion of measurement, genetic influences, and relation to dependence in human populations. Because there does not appear to be an "objective," non-self-report measure of smoking reward in humans, the utility of self-reported reward in predicting dependence will be examined.

Biological Plausibility

Preclinical Research

In contrast to the self-report measures of reward in humans, measures thought to reflect drug reward in animals are behavioral and, thus, potentially "objective," by necessity. The most widely used assessment of drug reward in animals is the conditioned place preference (CPP) paradigm. In CPP, drug administration is paired with a novel environment, and vehicle administration is paired with a second novel environment in a place-conditioning chamber. The time spent in the environment previously paired with a drug is used as a measure of the rewarding properties of the drug (i.e., it is assumed that spending more time in the environment associated with experiencing the effects of the drug indicates that the environment has acquired positive effects through its association with the drug). Rodents develop CPP for nicotine.^{135,152-157}

Another measure believed to index reward is intracranial self-stimulation (ICSS). Rats can be readily trained to self-administer electrical stimulation of the lateral hypothalamus or medial forebrain bundle. It is believed that this stimulation is self-administered because it activates the underlying neural circuit involved

in reward.¹⁵⁸ Drugs that are reinforcing generally lower the current sufficient to sustain ICSS (i.e., the threshold current), indicating that lower thresholds reflect pleasure states. By contrast, withdrawal from these drugs after chronic exposure often raises the ICSS threshold, which is believed to reflect aversive states.¹⁵⁸ In rats trained to ICSS, systemic administration of nicotine decreased the threshold current for ICSS by approximately 20%, indicating that nicotine results in pleasure states and so is rewarding,¹⁵⁹ while abstinence from nicotine has been shown to raise the ICSS threshold.¹⁶⁰

A review of studies using CPP and ICSS suggests that ICSS and CPP may have different neurobiological substrates. Work by Panagis and colleagues¹⁵⁹ and Kenny and Markou¹⁶⁰ suggest that the effects of nicotine on ICSS involve both low-affinity (e.g., $\alpha 7$ nAChRs) and high-affinity (e.g., $\alpha 4\beta 2$) nAChR subunits. In contrast, Walters and colleagues¹⁶¹ found that low-affinity $\alpha 7$ nAChRs were not necessary for nicotine CPP, but $\beta 2$ subunits were critically involved in this behavior. It is possible, however, that $\alpha 7$ nAChRs may modulate the effects of $\beta 2$ -containing nAChRs on ICSS. In support, Mamedi-Engvall and colleagues¹⁶² found that $\beta 2$ -containing nAChRs in the VTA mediated changes in the resting state of VTA dopaminergic cells from inactive to active, suggesting a critical role of $\beta 2$ -containing nAChRs in dopamine release. The $\alpha 7$ nAChRs also modulated the active state of the dopamine neurons, but the $\alpha 7$ nAChRs were only effective after activation of $\beta 2$ -containing nAChRs. In other words, the rewarding effects of nicotine could be expressed independently of $\alpha 7$ nAChRs but, depending upon conditions, $\alpha 7$ nAChRs could also be involved in changing nicotine-stimulated dopamine release related to reward. Thus, CPP and ICSS may measure different aspects of the rewarding effects of nicotine because different nAChR subtypes appear to be involved.

Genetic approaches such as strain surveys have been useful in identifying (1) natural genetic variance that contributes to differences in CPP, (2) receptors involved in CPP, and (3) how polymorphisms in genes encoding those receptors could alter nicotine intake. In a study comparing nicotine CPP in C57BL/6 versus DBA/2 mice, C57BL/6 mice but not DBA/2 mice developed CPP.¹⁵⁴ These results match those of oral nicotine self-administration that reported higher levels of self-administration in the C57BL/6 mice compared to DBA/2 mice.^{98–100}

Knockout models provide further evidence for genetic influences on nicotine reward. In one study, infusion cannula were implanted into the VTA of wild-type and $\beta 2$ nAChR subunit knockout mice before training on a task that combined place conditioning and self-administration.¹⁶³ Mice were trained to associate one arm of a Y-maze with VTA infusion of nicotine. The wild-type but not $\beta 2$ knockout mice showed greater preference for nicotine as measured by an increase in time spent in the arm of the maze associated with nicotine infusions. In addition, systemic administration of nicotine increased dopamine levels in the nucleus accumbens in wild-type but not $\beta 2$ knockout mice, providing a neurochemical mechanism for these genetic effects on reward. Further support for $\alpha 4\beta 2$ nAChR involvement in nicotine reward comes from a study that investigated CPP in mice with a single point mutation that results in an increase in sensitivity of $\alpha 4$ -containing nAChRs. The $\alpha 4$ mutant mice showed dramatically increased sensitivity for the development of CPP; wild-type mice developed CPP with a dose of 500 $\mu\text{g}/\text{kg}$, while the $\alpha 4$ mutant mice developed CPP with a 10 $\mu\text{g}/\text{kg}$ dose of nicotine.¹⁶⁴ Not only does this study strongly suggest that $\alpha 4\beta 2$ nAChRs are involved in the rewarding properties of nicotine but also demonstrates how a polymorphism of the gene coding for the $\alpha 4$ nAChR subunit could alter the threshold for developing nicotine dependence.

Polymorphisms in genes related to other neurotransmitter systems may also contribute to nicotine intake. For example, adenosine_{2A} (A_{2A}) knockout mice did not develop nicotine CPP nor have increased extracellular levels of dopamine in the nucleus accumbens after nicotine treatment. In addition, cannabinoid (CB1) receptor knockout mice did not develop CPP for nicotine.¹⁶⁵ However, in another study, CB1 knockout mice and wild-type mice showed similar levels of IV nicotine self-administration,¹⁶⁶ suggesting that CPP (i.e., reward) and IV self-administration (i.e., reinforcement) may be mediated by different cellular and genetic processes. As suggested in the introduction to this chapter, these data support the notion that reward and reinforcement are different constructs from a biological and behavioral perspective.

Opioid receptors may also mediate the rewarding properties of nicotine. In preproenkephalin knockout mice, no CPP was seen compared to wild-type mice.¹⁶⁷ In addition, mu opioid knockout mice have deficits in nicotine CPP.¹⁶⁸ Furthermore, nicotine CPP is absent in CREB^{oA} mice, consistent with new human data associating CREB1 and the human *OPRM1* receptor gene with individual variation in nicotine reward.^{134,136}

Genetic vulnerability to the effects of nicotine on locomotion may also predict genetic susceptibility to the rewarding properties of nicotine. Two lines of mice were generated from a heterogeneous stock: in one line, nicotine depressed locomotor activity; in the other, nicotine increased locomotor activity. The two lines were tested for nicotine CPP; the line in which nicotine depressed locomotor activity showed less CPP than the line in which nicotine increased locomotor activity.¹⁶⁹ These results suggest that genetic influences that mediate the psychostimulant properties of nicotine also mediate the rewarding properties of nicotine.

Studies in rats also demonstrate the involvement of genetics in the rewarding properties of nicotine as measured by CPP. F344 rats and Lewis rats were compared for development of CPP for nicotine.¹⁷⁰ After five trials, the Lewis rats showed CPP, but the F344 rats did not. When training was extended to 10 trials, Lewis rats still showed CPP for nicotine, but the F344 rats showed conditioned place aversion. Similar results were found in another study: Lewis rats showed CPP, but F344 rats did not.¹⁷¹ It is interesting to note that for IV nicotine self-administration, neither F344 rats nor Lewis rats self-administered nicotine.⁸⁶ The difference in results could be due to methodological differences or further demonstration that reward, as measured by CPP, and reinforcement, as measured by IV self-administration, are largely independent facets of nicotine's motivational effects and are mediated by different genetic substrates.

Description of the Measurement of Nicotine Reward in Humans

Objective measures of reward in humans that could potentially serve as endophenotypes similar to CPP and ICSS in animals have not been identified, leaving only self-report measures for evaluation. Typical measures relevant to reward in humans are self-report ratings of “liking,” “satisfying,” “good effects,” or “bad effects” that are completed following consumption of the substance. Items reflecting reward are included in several self-report measures, including the Cigarette Evaluation Scale of Rose and colleagues,¹⁷² which perhaps is the most widely used measure of hedonic and sensory effects of smoking. Items include asking how much did the subjects “like” the puffs they just took and how “satisfying” they were, along with other questions not pertaining to reward, such as how high in nicotine or similar to their own brand the puffs were (items that do not directly reflect the cigarette's hedonic value). Because of limited data on reliability of these measures,

the authors of this chapter examined test-retest consistency of ratings of “liking” and “satisfying” of puffs in a study of 54 smokers who smoked the same brand of cigarettes on two days, each following overnight abstinence (unpublished data). Subjects took four puffs in controlled fashion before one set of ratings and then smoked the cigarette ad lib for 14 minutes before a second set of ratings. The ratings of “liking” and “satisfying” of the four controlled puffs correlated .58 and .59, respectively (both $p < .001$), between sessions, while the same ratings of the cigarettes after ad lib smoking correlated .55 and .50, respectively (both $p < .001$), between sessions. Thus, these reward ratings are highly reliable.

Genetic Influences on Measures of Nicotine Reward in Humans

No investigations were found of the heritability of the self-reported rewarding or other hedonic effects of smoking, and only limited data on specific genetic associations with this outcome were identified. For example, in the study of nicotine choice by *OPRM1* genotype described above,¹³⁴ participants also completed the Cigarette Evaluation Scale and Sensory Questionnaire¹⁷² following initial exposure to the two research cigarettes: 0.05-mg (denicotinized cigarette) and .6-mg nicotine cigarette. The difference in ratings of the two cigarettes served as a measure of the rewarding effects of nicotine per se, and not simply of smoking, and was examined by the *OPRM1* genotype. Consistent with the finding of a reduced nicotine choice among smokers carrying the *OPRM1* low-activity *G allele, noted earlier, these smokers reported significantly smaller differences in ratings of satisfaction (and “strength”) between the nicotine and denicotinized cigarettes. In a study described earlier,¹³⁷ which examined increased smoking behavior and reward due to negative mood, the increase in smoking reward (“liking”) was associated

with *DRD2/ANKKI*TAQIA* (*TT* or *CT* > *CC*) and *OPRM1* (*AA* > *AG* or *GG*).

Association of Nicotine Reward Measures with Dependence

Smoking reward in humans is a focus of acute laboratory-based manipulations, such as medication pretreatment, but generally has not been studied prospectively in cessation trials. An exception is a study by Shiffman and colleagues¹¹⁹ in which greater hedonic rating (“pleasantness” of cigarette and “satisfying” averaged together) of the cigarette smoked during the first lapse after quitting predicted greater speed of a second lapse and eventual relapse. Yet, nicotine versus placebo patch did not reduce the hedonic rating of the lapse cigarettes, even though the nicotine patch slowed progression from first to second lapse. Another study suggested that higher ratings of the positive effects of nicotine nasal spray at pretreatment predicted subsequent abstinence in a nasal spray open label trial.¹⁷³ However, in a cross-sectional comparison, ratings of nicotine spray reward did not differentiate dependent and nondependent smokers.¹⁷⁴ Thus, some data support the association of smoking reward before quitting with success of a subsequent quit attempt (i.e., dependence).

Acute Smoking or Abstinence Effects on Cognitive, Affective, and Physiological Function

Although research clearly shows that smoking in general, and nicotine in particular, is reinforcing, and that this reinforcing effect is key to dependence, *why* smoking is reinforcing remains uncertain. A variety of the effects of smoking or its

abstinence may contribute to the motivation to self-administer nicotine in chronic smokers. For example, smoking may be motivated either by the desire to enhance cognitive functioning and performance or to relieve negative mood. Examples of this include nicotine’s effects on sensory processing, cognitive function (i.e., attention and working memory), affective regulation, and impulse control. However, as a consequence of chronic smoking and neural adaptations, abstinence from nicotine can also produce decrements in these domains. Subsequently, smoking relieves these symptoms very reliably, resulting in negative reinforcement of smoking behavior (i.e., smoking-elicited relief from aversive effects of nicotine abstinence increases the probability of future smoking when experiencing abstinence effects). Thus, these responses in chronic smokers are not simply the acute effects of smoking or nicotine but rather their effects in reversing the deficits in function resulting from smoking abstinence. (For simplicity, “smoking” and “nicotine” are used largely interchangeably here unless a study specifically examined only one.)

Therefore, an important issue in interpreting all research on nicotine’s effects on functioning in chronic smokers is to determine whether the effects reflect a reversal of abstinence-induced deficits in function or whether direct pharmacological changes are unrelated to the abstinence state of the subject (i.e., do not depend on abstinence-induced deficits in function). Practically speaking, this issue depends on whether the prenicotine baseline condition for a chronic smoker is (1) brief abstinence from smoking (e.g., overnight), or (2) no abstinence.¹⁷⁵ Requiring brief abstinence from smoking prevents the influence of acute tolerance to nicotine from distorting responses to subsequent smoking or nicotine administration.¹⁷⁶ However, such abstinence can also lead to mild withdrawal symptoms, including the deficits in function noted above. In this case, measures

following acute nicotine administration may reflect a reversal of these withdrawal-related deficits rather than direct effects of nicotine. This interpretation is supported by the general absence of many effects of nicotine in drug-naïve individuals who do not experience withdrawal (i.e., nonsmokers) and the attenuated effect of nicotine in smokers who are not abstinent at baseline (and not in withdrawal).¹⁷⁷

Neither procedure—brief abstinence or no abstinence from smoking before the administration of nicotine or smoking—is necessarily superior to the other; the choice of procedure depends on the goal of the research. However, the baseline state of the smoker must be considered in interpreting results of nicotine effects.¹⁷⁸ Related to this issue is research on nicotine's effects in smokers who exhibit deficits in function from causes other than tobacco abstinence. As will be noted, nicotine can reverse many of these deficits as well as those due to ADHD symptoms, fatigue, or disease such as Alzheimer's, even when no effects are seen in smokers without these conditions. Therefore, the subject sample and session procedures need to be taken into consideration when interpreting nicotine's effects on function.

The following types of potential endophenotype measures will be considered in this section, both from the perspective of measuring nicotine effects (in a nondeprived state) as well as effects of nicotine deprivation: (1) sensory processing, (2) cognitive function, (3) craving, (4) affective regulation, and (5) behavioral regulation (impulse control). As explained, craving is included as a separate subarea because it is believed to comprise several of these functions, particularly cognitive and affective regulation, and has historically been a key concept in understanding dependence.¹⁷⁹ As in the above sections, a review is given for each measure of what is known concerning the biological

plausibility, measurement, evidence for heritability and specific genetic associations, and relationship to nicotine dependence.

Electrophysiological Measures

Resting EEG Activity

Electrical brain waves (EEG signals) can be measured to monitor changes in the brain's activity by using electrodes placed on multiple scalp locations. The spectrum of EEG activity is summarized in terms of the peak amplitude or power (area under the curve) or frequency (rate of oscillation), and is categorized into four broad frequency bands. From fastest to slowest, these include beta (13–25 hertz [Hz]), alpha (8–12.5 Hz), theta (4–7.5), and delta (1.5–3.5). The power and frequency of these EEG oscillations reflect generalized neural activity in the cerebral cortex. This activity, in turn, reflects overall level of arousal and information processing. The arousal-enhancing effects of psychostimulant drugs, including nicotine, are believed to be important to explaining their abuse liability. Therefore, nicotine's effects on EEG activation provide a potential endophenotype for dependence; however, the links of such measures to dependence are not known.

Biological Plausibility

Preclinical Research. The effects of acute and chronic nicotine treatment on cortical EEG activity have been assessed in Wistar rats.¹⁸⁰ Acute doses of 0.3, 0.9, and 2.7 mg/kg nicotine tartrate decreased high-voltage spindles. The effect was blocked by the nAChR antagonist mecamylamine, and when administered alone, mecamylamine increased high-voltage spindles. To test if tolerance would develop for the effects of nicotine on EEG activity, rats were chronically treated with three daily injections of 0.9 mg/kg nicotine tartrate for 10 days. No tolerance was seen for the effects of 0.9 or 2.7 mg/kg nicotine tartrate on EEG activity. In nucleus-basalis-lesioned

rats, nicotine did not alter EEG activity. The authors conclude that both acute and chronic nicotine treatment desynchronizes EEG activity. Thus, the effects of nicotine on EEG activity appear to be dependent on nucleus basalis function.

Human Clinical Research. In humans, nicotine causes EEG activation, as evidenced by increases in alpha and beta frequency and decreases in theta and delta power, providing a neural correlate of nicotine's arousing effects.¹⁸¹ Abstinence from nicotine in chronic smokers produces decreases in alpha and beta frequency and increases slow wave activity; however, there is significant variability in the pattern and time course of such effects.^{182–185} The slowing of EEG activation during nicotine abstinence in chronic smokers is associated with decrements in performance on neurocognitive tasks.¹⁸³

The effects of tobacco abstinence on resting EEG can be prevented by nicotine replacement with nicotine gum or transdermal nicotine.^{183,184} Smoking a cigarette after a brief abstinence period can reverse the decremental effects of nicotine abstinence on resting EEG¹⁸² as does nicotine administration.¹⁸⁶ Further, nicotine abstinence effects on resting EEG can be mimicked by mecamylamine, an antagonist of brain nicotine receptors.¹⁸⁷ Mecamylamine pretreatment also blocks EEG effects of nicotine, suggesting that EEG neural correlates of nicotine abstinence effects are mediated by nicotinic cholinergic receptors.¹⁸⁷ The central role of nicotine, rather than tobacco more generally, is supported by the failure of denicotinized cigarettes to produce the same changes in EEG activity as nicotine cigarettes; however, nonnicotine factors may also alter EEGs.¹⁸⁸

Description of Measurement of Resting EEG

EEGs are measured by using electrodes placed on multiple scalp locations. The

assessment, analysis, and interpretation of EEG data are quite complex and beyond the scope of this chapter. Readers interested in designing EEG experiments are referred to an excellent introduction to EEG methods and measurement by Luck.¹⁸⁹

Genetic Influences on Resting EEG in Humans

Measures of resting EEG are highly stable over long periods of time,^{190,191} suggesting that this trait is heritable. For absolute EEG power (across the EEG spectrum), heritability estimates from twin studies range from 55% to 90% in child twin pairs¹⁹² and from 70% to 90% in adults.¹⁹³ Among a sample of 760 young adults from the Dutch twin registry, heritability estimates for the different EEG power bands were beta (.79), alpha (.90), theta (.85) and delta (.62); among middle-aged adults, estimates were similar: beta (.75), alpha (.85), theta (.75) and delta (.53).¹⁹⁴ In a review of 10 twin studies measuring alpha power, the average heritability was reported to be 79%.¹⁹⁵ The relatively lower estimates for heritability of delta wave activity suggest that environmental influences may play a more important role.

Although data from twin studies support the premise that resting, or background, EEG measures have a strong genetic basis, no studies were found of the heritability of chronic nicotine effects on EEG measures. Despite the strong evidence for the heritability of resting EEG measures, the literature on candidate gene associations is also scant. Only one genetic study was found of resting EEG components in smokers. Gilbert and colleagues followed 67 female smokers during 31 days of abstinence.¹⁹⁶ Individuals carrying the minor (**AI*) allele for the *DRD2*TAQIA* polymorphism, associated with decreased D2 receptor availability,¹⁹⁷ showed significantly greater EEG slowing during a high-stress task. Similar effects were found among subjects with higher levels of nicotine dependence. This study provides the first

evidence for a genetic association with EEG measures and also suggests a link of this endophenotype with nicotine dependence.

A series of studies has been conducted in a large sample of members of families with dense histories of alcoholism.¹⁹⁸ These studies may be relevant, given the high rate of comorbidity between alcohol and nicotine dependence.⁹¹ Alcohol-dependent males had significantly higher beta and theta EEG power compared to controls.^{199,200} Genetic marker alleles across the genome were examined in these subjects, and evidence for linkage for the beta power endophenotype was found on a region on chromosome 4 that harbors the *GABA_A* receptor gene.¹⁹⁸ Another investigation found a genetic association of resting EEG with a substitution polymorphism in exon 7 of the *GABA_B* receptor gene, but only in normal subjects, and not in alcoholics.²⁰¹

Association of Resting EEG with Dependence

No published studies were found that relate resting EEG measures to quitting success. The study described above by Gilbert and colleagues¹⁹⁶ reported a correlation between Fagerström tolerance scores and EEG slowing at day three of nicotine abstinence; however, the relationship of these changes to quitting success is unknown. To determine the potential utility of resting EEG as an endophenotype, this critical gap in knowledge must be addressed.

Event-Related Potentials

General Description of ERP and Measurement

ERPs are positive and negative EEG voltage deflections in response to specific stimuli, including visual, auditory, or somatosensory.¹⁸⁹ These positive- and negative-voltage fluctuations in the amplitude of electrical activity are labeled according to their direction (P for positive, N for negative) and time (or latency) following presentation of a discrete

stimulus. ERPs are also categorized as either exogenous or endogenous. Exogenous ERPs are early deflections linked to the features of the stimulus, such as intensity of the visual or auditory stimulus. For example, the P50 ERP is an exogenous ERP observed as a positive increase in amplitude occurring at about 50 milliseconds (ms) following stimulus presentation. Exogenous ERPs, such as P50, are thought to reflect initial sensory registration. By contrast, endogenous ERPs have a longer latency, following stimulus onset, and reflect stimulus processing and evaluation. For example, the P300 ERP occurs in response to an infrequent presentation of an irrelevant stimulus, typically measured during a target detection task.

Common ERP measures include P50, N100, N200, and P300 as well as contingent negative variation and mismatch negativity. P50 and P300 have been studied most frequently in tobacco research and will be the focus here (for an in-depth review on nicotine effects on ERPs, see Pritchard and colleagues²⁰²).

P50 ERP

Biological Plausibility

Preclinical Research. In the mouse model, the P50 ERP is measured with a paired click paradigm but has a shorter latency (20 ms). In rodents, it is therefore referred to as the P20-N40 wave. DBA/2 mice have a deficit in auditory gating of the P20-N40 wave, and nicotine reverses this deficit.^{203,204} Acute nicotine also increases the amplitude of the P20 wave and decreases the amplitude of the N40 wave in C57BL/6J mice and DBA/2Hsd mice.²⁰⁵

There is evidence from rodent models for $\alpha 7$ nAChR involvement in P20-N40 amplitude and P20-N20 gating.²⁰⁶ Nine strains of inbred mice were analyzed for α -bungarotoxin binding (a ligand for $\alpha 7$ nAChR) and P20-N40 gating. A significant correlation was observed

between hippocampal α -bungarotoxin binding and the P20-N40 response to the first auditory stimulus and the ratio of response to the first and second stimulus (i.e., the gating response). Nicotine has been shown to increase P20 and reduce N40 amplitude. These effects are sensitive to manipulation of dopamine.²⁰⁷ Mecamylamine attenuates nicotine effects on P20, but not on N40, suggesting a different role for nAChRs in these response waves.²⁰⁸

Human Clinical Research. Much of what is known about the P50 has come from research in the area of schizophrenia that focuses on a common P50 sensory gating deficit. Some studies suggest that schizophrenic patients exhibit a reduced ability to inhibit, or complete failure to inhibit, a brain response to the second of two auditory stimuli (see below).^{209,210} Smoking prevalence rates are as high as 80% among individuals with schizophrenia, significantly higher than in the general population.²¹¹ It has been posited that these elevated smoking rates are partly due to a normalizing effect of nicotine on the P50 response.^{212,213} Therefore, the literature on genetic associations with the P50 response in schizophrenia, discussed below, may help to elucidate the possible use of this measure as an endophenotype of nicotine dependence.

Description of Measurement of P50 ERP in Humans

As mentioned above, the P50 ERP is a positive EEG voltage deflection that occurs about 50 ms after presentation of an auditory or visual stimulus, and it reflects initial sensory registration. Much of this research in humans focuses on the P50 sensory gating deficit. This is typically measured in a paired-stimulus paradigm in which two stimuli (usually a sound or a “click”) are presented about 5 ms apart. The ratio of response to the second stimulus versus the first stimulus is averaged over a large number of trials in this paradigm. In normal subjects, there is an average reduction in the response to

the second stimulus, reflecting an adaptive sensory gating or filtering mechanism.

Genetic Influences on the P50 ERP in Humans

Existing evidence suggests that the P50 ERP has a substantial genetic component. In healthy twins, heritability estimates for the P50 sensory gating response range from .44 to .68 for this measure.^{195,214,215} Given the evidence for genetic influences, it is not surprising that the measure is fairly stable over time; interclass correlations of .66–.77 have been reported for P50 suppression, when measured on two separate occasions.²¹⁶ Interestingly, there is not strong evidence for significant shared genetic influences with the P300, suggesting different neurobiological mechanisms for P50 and P300.

Work on the specific genetic basis of the P50 ERP has focused on the P50 suppression deficit seen in schizophrenics. Consistent with evidence for the central role of the $\alpha 7$ nAChR cited above, a genome-wide analysis found evidence for significant linkage of the P50 auditory to a region in chromosome 15 that includes the $\alpha 7$ nicotinic receptor gene *CHRNA7*.²¹⁷ Subsequently, Leonard and colleagues identified polymorphisms in the promoter region of *CHRNA7* with reduced transcriptional activity in reporter gene assay.²¹⁸ In this study, schizophrenic patients exhibited less P50 inhibition than did controls, and a functional *CHRNA7* polymorphism was associated with this measure.²¹⁸ Although schizophrenia has been linked to this region and associated with *CHRNA7*,²¹⁸ another group was unable to replicate the associations of the promoter variants with the P50 gating deficit.²¹⁹

Association of P50 ERP with Nicotine Dependence

No published studies were found of the relationship of the P50 ERP or P50 suppression with level of nicotine dependence or quitting success.

P300 ERP

Biological Plausibility

There has been little attention to effects of nicotine on the P300 in animal models. In one study, prenatal nicotine exposure in rats predicted a reduced auditory P300 ERP in the adult offspring relative to controls.²²⁰

In humans, differences between smokers and nonsmokers in the P300 ERP have been documented in a few studies.^{221,222} Both current and former smokers show reduced P300 amplitude that correlates with hypoactivation in the anterior cingulate and frontal cortical regions.²²³ The presence of the deficit in former smokers suggests that this may be a predisposing factor rather than a consequence of nicotine exposure. However, it is also possible that both current and former smokers have neuroadaptive changes due to chronic nicotine exposure that are not reversed following long-term cessation.

Of greater relevance to withdrawal-related phenotypes are studies examining effects of tobacco abstinence on the P300 ERP. Brief abstinence from tobacco increases P300 latency and decreases P300 amplitude, effects that are reversed by smoking.¹⁸¹ In one study of smokers abstaining for nine hours, smoking two cigarettes reduced P300 amplitude.²²⁴ However, another study found that 12-hour abstinence had no effects on P300 amplitude but did increase P300 latency.²²⁵ Although the results of investigations of effects of nicotine and of tobacco abstinence on P300 are not entirely consistent, there is some evidence suggesting that P300 deficits may predispose to smoking, are intensified by abstinence in chronic smokers, and are reversed by smoking following brief abstinence.

Description of Measurement of P300 ERPs in Humans

As mentioned above, the P300 is an endogenous, positive EEG deflection at

about 300 ms following a stimulus. Unlike the P50 ERP, which is a purely sensory response, the P300 is sensitive to differences in stimulus parameters. It is typically measured in a visual or auditory oddball paradigm in response to an infrequent (i.e., “oddball”) stimulus occurring in the context of common target and nontarget stimuli in a target-detection task. Generally speaking, the more unexpected and infrequent the oddball stimulus, the stronger is the ERP response. The P300 is measured across a large number of trials and reported in terms of both average peak amplitude and average latency from the stimulus, with the former reflecting the amount of cognitive resources required for stimulus processing and evaluation and the latter reflecting the time required for such processing.²⁰²

Genetic Influences on the P300

In general, P300 amplitude and latency appear to be stable and heritable traits. Test-retest correlations of .66–.67 are reported for assessments performed on two separate occasions.²¹⁴ In adolescents, test-retest correlations are also high.²²⁶ The strongest evidence for the heritability of the P300 ERP is presented in a meta-analysis of five twin studies, reporting a “meta-heritability” of 60% (95% confidence interval [CI], 54%–65%) for P300 amplitude and 51% (95% CI, 43%–58%) for P300 latency.¹⁹⁵ In individual twin studies, heritability estimates for P300 amplitude and latency range from .41 to .78.^{214,227,228} Although P300 amplitude and latency share genetic variance (i.e., one-half of the variance in these measures is due to common genetic influences), there is no evidence for significant shared genetic influences for the P300 and P50 ERP, suggesting different neurobiological mechanisms.²¹⁶ No studies were identified of genetic influences on effects of nicotine or tobacco abstinence on the P300; however, given consistent evidence that the trait itself is heritable, genetic variation in nicotine effects would be expected.

Genetic association studies of P300 focusing on effects of nicotine or smoking are rare. However, there is growing evidence for specific genetic influences on the P300 in the general population and in populations in which smoking rates are high. For example, using genome-wide linkage analysis in the Collaborative Study on the Genetics of Alcoholism, Porjesz and colleagues¹⁹⁸ found evidence for linkage of P300 (measured in a visual task) to regions on chromosomes 2, 5, 6, and 3.

Evidence for genetic linkage supports the pursuit of specific genes that may underlie deficits in P300 that may have relevance to nicotine dependence. Given the importance of dopamine signaling in schizophrenia, polymorphisms in genes in the dopamine pathway have been examined for associations with P300, although with mixed results. The *DRD2*TAQ1 A1* variant, associated with smoking risk in some studies, has also been linked with prolonged P3 latency in the sons of active and recovering alcoholics.²²⁹ A nonsynonymous (*SER9GLY*) variant in the dopamine receptor D3 gene (*DRD3*) previously associated with schizophrenia has been related to reduced P300 amplitudes in the left parietal area.²³⁰ The reduced activity *7-repeat allele of a common dopamine receptor D4 VNTR polymorphism has been linked with P300 response to novel stimuli; the results, however, were modified by a measure of dopaminergic tone (i.e., the eyeblink response).²³¹ Although these studies have not focused specifically on nicotine effects, both the *DRD2*TAQ1 A1* and the *DRD4*7*-repeat allele have been associated with smoking status in some studies,^{31,38} and *DRD3* activity mediates, in part, nicotine self-administration in rodent models.²³²

As discussed further below with respect to neurocognitive deficits, the *COMT* gene is an excellent candidate gene for measures involving sensory processing and neurocognitive function. The COMT enzyme inactivates dopamine, with important effects

in the prefrontal cortex where dopamine transporter (reuptake) levels are low.²³³ Among schizophrenics, carriers of the low-activity **MET* allele (increased dopamine) show smaller frontal P300 amplitudes, an effect interpreted as reflecting less “noise” in the prefrontal cortex.²³⁴ During a task of behavioral inhibition mediated by the frontal cortex (i.e., go/no-go) *COMT*MET* allele carriers show an anteriorization of the P300 response during the no-go target, which the authors suggest may alter ability to inhibit responses.²³⁵ However, other studies have found no association of *COMT* genetic variation with P300 amplitude or latency.²³⁶ No studies were found examining the role of genetic factors on nicotine effects on the P300.

Association of P300 ERP with Nicotine Dependence

As with the P50 ERP, no published studies were found of the relationship of the P300 ERP with level of nicotine dependence or quitting success.

The PPI of Startle Response

The PPI of the acoustic startle reflex is another task thought to measure the ability to filter sensory information or sensory gate.^{237,238} Although the basic construct involving inhibition or “gating” of response to a second stimulus is similar to the P50 ERP, this measure is based on an eyeblink reflexive response, rather than on electrophysiological measurement (discussed below).

Biological Plausibility

The effects of acute nicotine on PPI across strains of mice and rats are highly variable, supporting genetic influences. In one study, acute nicotine administration enhanced PPI in C57BL/6 mice.²³⁹ In a strain survey of the effects of nicotine on PPI in 129S6, BALB/cByJ, C57BL/6J, DBA/2, and NMR1 mice, nicotine enhanced PPI only in NMR1 mice.²⁴⁰ Another study

found no enhancement of PPI with nicotine in DBA/2J, C3H/HeJ, C57BL/6, or 129T2/SvEmsJ mice.²⁴¹ The different effects of nicotine on PPI may be due to different doses of nicotine used and to strain differences. The study by Spielow and Markou²⁴¹ found genetic differences in the ability of nicotine to reverse phencyclidine (PCP) disruption of PPI; nicotine reversed PCP-associated deficits in PPI in DBA/2J and C3H/HeJ mice but not in C57BL/6 or 129T2/SvEmsJ mice. In Sprague-Dawley rats,^{242,243} nicotine enhanced PPI, but in Wistar rats, nicotine had no effect on PPI.²⁴⁴ In a study that compared the effects of nicotine on PPI between Sprague-Dawley rats and BALB/c mice, nicotine disrupted PPI in the Sprague-Dawley rats but enhanced PPI in the BALB/c mice.²⁴⁵ In $\alpha 7$ nAChR subunit knockout mice, no deficits in PPI were found.²⁴⁶ However, PPI was disrupted in $\beta 3$ nAChR knockout mice, suggesting that $\beta 3$ -containing nAChRs are involved in PPI.²⁴⁷

With respect to preclinical studies of nicotine withdrawal effects on PPI, DBA/2 mice withdrawn from nicotine showed decreased PPI for the 8-decibel (dB) and 12-dB prepulses but not for the 4-dB prepulse.²⁴⁸ A follow-up study from the same laboratory compared the effects of nicotine withdrawal on PPI in DBA/2 mice and C57BL/6 mice and found no withdrawal-associated PPI deficits.²⁴⁹ The different results across studies could be related to the different doses used or could suggest that the effects of nicotine withdrawal on PPI are mild. In support of the latter, no nicotine withdrawal deficits were seen in PPI in Long-Evans rats, Sprague-Dawley rats, and Wistar rats.^{237,250}

In humans, acute smoking of a cigarette has been shown to increase PPI (i.e., reverse the attenuation due to abstinence) very acutely within minutes after smoking.^{251,252} Demonstration that a subcutaneous injection of nicotine (6 or 12 $\mu\text{g}/\text{kg}$) also increased PPI confirmed that nicotine

per se increases PPI.²⁵³ In contrast, PPI is attenuated (i.e., less inhibition of startle or sensory gating) by overnight abstinence in dependent smokers.²⁵² Thus, while there has been less attention to nicotine's effects on PPI, as compared with EEG measures, these data suggest that PPI could be a plausible endophenotype.

Description of PPI Measurement in Humans

PPI is typically measured within a classic startle paradigm that assesses reflexive muscle contractions by using electromyographic, or EMG, recording of the orbicularis oculi muscles (eyeblink response) following presentation of a sudden intense stimulus (visual, auditory, or tactile). The startle reflex itself is thought to relate to mood or affect and is discussed later in this chapter as a potential endophenotype of affect regulation. PPI of the startle response reflects the extent to which a preceding weaker stimulus suppresses or attenuates the sensorimotor reflex response to the subsequent intense stimulus. This response occurs in animals and humans, although there is substantial individual variability.²⁵⁴ Various adaptations of this paradigm have used pictorial representations of smoking cues or affective stimuli; however, using smoking cues as the prestimulus does not appear to modulate the acoustic startle response.²⁵⁵

Genetic Influences on Prepulse Inhibition of Startle

Although there is evidence for high retest reliability for PPI measures, suggesting that this is a stable trait measure,^{256,257} only one study has examined the heritability of PPI. In this study of 170 female twins aged 18–28 years, it was estimated that roughly 50% of the genetic variability in PPI is due to genetic influences, some of which are shared with absolute startle response.²⁵⁸ However, a follow-up study of affective modulation of startle provided no evidence for significant heritability.²⁵⁹ At the writing of this chapter, no studies

were identified relating specific genetic variants to PPI.

Association of PPI with Nicotine Dependence

Of these EEG measures, only PPI has been studied in relation to cessation outcome or other indices of nicotine dependence. In the study by Kumari and colleagues²⁵² described above, PPI was attenuated (i.e., less inhibition of startle or sensory gating) by overnight abstinence to a greater degree in more dependent smokers, based on their score on the Fagerström Tolerance Questionnaire. This suggests that attenuation in PPI due to overnight abstinence relates cross-sectionally to degree of current dependence on one self-report measure of dependence.

Cognitive Function

Attention and Vigilance

Biological Plausibility

Nicotine's effects on attention have been the focus of several studies in rodents. The five-choice serial reaction time task (5CSRTT) is one of the best studied of these models. In the 5CSRTT, rodents must attend to an array of five apertures for presentation of a brief light stimulus and respond with a nose poke in the illuminated aperture for food reinforcement. The 5CSRTT allows for assessment of multiple behavioral measures that include the percentage of correct responses (i.e., accuracy), percentage of omissions (i.e., the failure to respond to the stimulus), response latency, latency to collect the reinforcement, and premature responding (i.e., nose pokes during the intertrial interval); for a review, see Kumari and colleagues.²⁶⁰

Several studies have used the 5CSRTT to study nicotine effects on attentional processes. Acute nicotine enhances attention in the 5CSRTT, increases reaction time on correct responses, and increases accuracy.^{261–263} Surprisingly few animal

studies have examined the effects of nicotine withdrawal on attentional processes. In one study, hooded Lister rats were tested for the effects of withdrawal from 3.16 mg/kg/day of nicotine on the 5CSRTT.²⁶⁴ Increased omissions were seen after both spontaneous withdrawal and precipitated withdrawal with the high-affinity nAChR antagonist DH β E; the α 7 nAChR antagonist methyllycaconitine did not precipitate withdrawal. Thus, nicotine withdrawal was associated with an increased failure to respond to the stimuli. This deficit in attention to the stimuli involves high-affinity nAChRs such as the α 4 β 2 nAChR.

An alternate paradigm for assessing nicotine's cognitive effects in rodents is fear conditioning (in which a neutral stimulus is paired with an aversive stimulus, and then freezing to the neutral stimulus is measured). In one study,²⁶⁵ C57BL/6 mice were treated with nicotine for 12 days and then withdrawn from nicotine; 24 hours later, mice were conditioned. Nicotine withdrawal disrupted contextual fear conditioning, a hippocampus-dependent version of fear conditioning,^{266,267} but not cued fear conditioning, a hippocampus-independent version of fear conditioning.^{266,267} The selectivity of the withdrawal deficits suggests that nicotine withdrawal affects specific types of learning and does not affect processes common to both types of learning. It is possible that relapse occurs in smokers after withdrawal from nicotine as an attempt to ameliorate learning-related deficits. In support, the withdrawal deficit in contextual fear conditioning in mice was reversed by treatment with acute nicotine.²⁶⁵

Animal studies examining the genetic basis of nicotine effects on attention are limited, but the effects of nicotine on five-choice serial reaction time (5CSRT) have been shown to be strain dependent in rats. Nicotine improved choice accuracy in Sprague-Dawley rats but not in hooded

Lister rats.²⁶⁸ Another study demonstrated that nicotine enhanced 5CSRT in C57BL/6 mice.²⁶⁹ In this study, drug-naïve $\alpha 7$ nAChR subunit knockout mice showed deficits in 5CSRT, compared to wild-type mice. Thus, $\alpha 7$ nAChR may be involved in some attention processes.

In humans, several converging lines of evidence have linked self-reported inattention symptoms to smoking behavior. Individuals with a clinical diagnosis of ADHD have higher rates of smoking initiation and persistence. Further, smokers with a history of ADHD (current or childhood) are more likely than those without a history of ADHD to experience nicotine withdrawal symptoms, including irritability and problems with concentration.²⁷⁰ Inattention symptoms are also associated with self-reported reasons for smoking (e.g., smoking for stimulation) and nicotine dependence in the general population of smokers.²⁷¹ Impulsivity symptoms are also associated with smoking prevalence in young adults.²⁷² Most critically, smokers without a diagnosis of ADHD who reported increases in subclinical ADHD symptoms during the first week of abstinence were significantly more likely to relapse than were smokers who did not report increases in inattention symptoms.²⁷³ Improvements in attention and performance due to nicotine have also been reported in studies of nonsmokers without ADHD²⁷⁴ and smokers and nonsmokers with ADHD.²⁷⁵

Description of Measures of Attention and Vigilance in Humans

Measures of attention tap the ability to focus and sustain attention on relevant stimuli. The most commonly used measure of visual attention is the continuous performance task (CPT). In this computerized task, participants are presented with a visual target for 50 ms (e.g., an “X”) and nontarget stimuli (e.g., an “O”) in rapid succession. They are instructed to make a rapid response (e.g., press a button) only when a target

stimulus is presented. A variation on the basic CPT (CPT-identical pairs [IP]) is to instruct participants to make a response when they see an identical pair of targets (e.g., two digits or letters) presented in succession.²⁷⁶ CPT-IP has been advocated for use in adults, as the basic CPT may not be sensitive enough to capture inattention symptoms in the general population.^{277,278} The CPT has been shown to discriminate between those with and without ADHD among children and adults^{279–281} and to be sensitive to the effects of ADHD medications.²⁸² As described above, the CPT is sensitive to the effects of nicotine abstinence²⁸² and nicotine administration.²⁷⁵

Other measures of visual attention that are sensitive to nicotine effects include the Rapid Visual Information Processing (RVIP) task²⁸³ and the letter cancellation task.²⁸⁴ Regular smokers observed over 24 hours of abstinence performed more poorly on this cancellation task, with reduced rates of target detection and increased response times as duration of abstinence increased, demonstrating withdrawal-induced deficits. Finally, auditory attention can be measured with the Digit Span test of the Wechsler Adult Intelligence Test-Revised, which is sensitive to medication effects,²⁸⁵ but not well studied with respect to nicotine effects. In general, most studies show that smoking, or nicotine delivery by other methods in abstinent smokers, produces only modest improvements in simple reaction time performance, finger-tapping speed over short periods (e.g., less than one minute), or other simple psychomotor tasks.¹⁷⁷

Genetic Influences on Attention and Vigilance

Although no studies were found that examined the heritability of nicotine-related effects on measures of attention and vigilance, existing data support the heritability of baseline task performance.²⁸⁶ For the CPT, heritability estimates of 39% and 49% have been reported for verbal

and spatial attention, respectively.²⁷⁶ For the digit symbol substitution test, heritability estimates of 67% have been reported.²⁸⁷ By using a simple reaction time task in a sample of 213 twins, the heritability of attentional/motor performance was estimated to be 64%. Other studies have focused on the heritability of performance within families with schizophrenia. For example, using a registry of families with schizophrenia in Finland, Tuulio-Henriksson and colleagues,²⁸⁸ reported heritabilities of .09 and .20 for visual and auditory attention, respectively. Thus, while there is general support for the heritability of performance of tasks assessing attention, the genetic contributions appear to vary by both measure and population.

Associations of candidate genes in the dopamine pathway with attention-vigilance measures have also been reported; however, the results have not been consistent. In the single study of genetic associations with nicotine effects on attention, Gilbert and colleagues found that smokers carrying the “high-risk” **AI* allele of the **TAQI* polymorphism in the *DRD2* gene exhibited greater improvements in RVIP task performance following nicotine administration.²⁸⁹ Several studies have examined the *VAL/MET* polymorphism in the *COMT* gene described above. Consistent with the premise that dopamine levels in prefrontal cortex facilitate attention, the low-activity **MET* allele has been associated with better performance on the CPT;^{290,291} however, another study found no association between CPT performance and the *COMT* genotype.²⁹² Performance on the CPT has also been associated with a common repeat polymorphism in the dopamine transporter gene among children with ADHD; however, the direction of association is inconsistent across studies.^{293,294} One study provides evidence for an association of a repeat polymorphism in the dopamine receptor D5 gene *DRD5* with CPT performance in children with

ADHD and their parents.²⁹⁵ Visuospatial attention has also been associated with a polymorphism in the $\alpha 4$ nicotinic receptor gene *CHRNA4*, providing further support for attention-related endophenotypes of nicotine dependence.²⁹⁶ Thus, although only one study examined the role of specific genetic factors in nicotine effects on attention,²⁸⁹ the genetic associations identified for task performance (independent of nicotine) are consistent with those found for smoking status and smoking cessation.

Relation of Attention and Vigilance Measures to Dependence

Several of the measures described above are sensitive to effects of nicotine deprivation in dependent smokers.^{297,298} In addition, smokers with higher scores on the FTND exhibit increased neural activation in regions related to visuospatial attention (e.g., anterior cingulate cortex) while viewing smoking and neutral pictures,²⁹⁹ suggesting that nicotine dependence may moderate attentional task performance.

Two small studies assessed relationships of CPT to quitting success. In one study of adolescent smokers, commission errors on the CPT predicted relapse;³⁰⁰ however, commission errors may be more reflective of impulse control deficits than attention-vigilance (see section below on “Impulse Control”). In a study of schizophrenic smokers, baseline CPT performance did not predict quitting in a smoking treatment program.³⁰¹

Working Memory

Biological Plausibility

Nicotine’s effects on learning are a plausible mechanism for its positive and negative reinforcing effects.³⁰² For example, learned associations of nicotine delivery with smoking-related stimuli may promote drug craving. Likewise, the ability of nicotine to reverse cognitive deficits could contribute to relapse if abstinent smokers attempt

to ameliorate the withdrawal deficits by resuming smoking.

This premise has received substantial support in rodent models of nicotine's effects on learning. Specifically, nicotine enhances hippocampus-dependent contextual fear conditioning,^{265,303–306} it does not enhance the hippocampus-independent association between the auditory conditioned stimulus (CS) and the foot shock unconditioned stimulus (US),^{305,306} even when the difficulty of the task is increased.³⁰⁷ Acute nicotine has also repeatedly been shown to enhance working memory, as measured in the 8-arm radial maze (for a review see Levin and Simon³⁰⁸) and as measured in trace fear conditioning.^{307,309} Nicotine also improves learning in paradigms such as passive avoidance,^{310–312} active avoidance,^{313,314} the Morris water maze,^{315,316} and a visual discrimination task.³¹⁷

With respect to the genetic underpinnings of nicotine's effects on learning, the earliest studies focused on strain surveys of inbred mice. In work by Bovet and colleagues,³¹⁸ nicotine produced the most active avoidance in C3H/He mice followed by CBA mice, C57BL/6 mice, AHe mice, Swiss mice, BALB/c mice, and then DBA/2 mice. In the remaining strains, nicotine disrupted learning, with the greatest deficit seen in C57BR/cd mice followed by C57BL/10 mice, and then A/J mice. In a visual discrimination task in which mice learned to exit a chamber through the correct door to avoid a shock, nicotine enhancement of learning varied across inbred strains of mice.³¹⁹ In A/J, C3H/He, and DBA/2J mice, nicotine enhanced visual discrimination (C3H/He \geq DBA/2J \geq A/J), but in the BALB/c strain, nicotine disrupted performance. In a comparison of the effects of nicotine on consolidation of a Y-water-maze task, nicotine improved consolidation in C57BL/6 mice but disrupted consolidation in DBA/2 mice.³²⁰ Thus, comparisons across inbred strains of mice show clear influences of

genetics on the acute effects of nicotine on learning and also suggest that these effects may be task specific.

Targeted mutations and selective breeding studies also support the influence of genetic factors in the effects of nicotine on cognition. No deficits in either passive avoidance or fear conditioning were seen in $\beta 2$ nAChR subunit knockout mice;^{321,322} nicotine, however, failed to enhance passive avoidance and contextual fear conditioning in the $\beta 2$ knockout mice.^{322,323} In contrast to the $\beta 2$ knockout mice, nicotine enhanced contextual fear conditioning in $\alpha 7$, $\beta 3$, and $\beta 4$ nAChR subunit knockout mice.³²³

Studies with nAChR knockout mice also suggest that the $\beta 2$ nAChR subunit is involved in the effects of nicotine on working memory. Working memory is defined as the processes by which information is maintained for access while performing complex cognitive tasks. One measure of working memory is trace fear conditioning in which the CS and the US are separated by a trace period during which no stimulus is presented; therefore, a representation of the CS must be maintained during the trace period for a CS-US association to be learned.^{324–326} Both $\beta 2$ and $\alpha 7$ nAChR subunit mice develop trace fear conditioning, but in the $\beta 2$ knockout mice, nicotine does not enhance conditioning.³⁰⁹ Together, these results suggest that genetic alterations of the $\beta 2$ subunit gene alter the effects of nicotine on multiple types of learning.

The human data on nicotine's effects on working memory are less clear. There is evidence for enhancement of working memory following acute nicotine delivery in nonsmokers.²⁶⁰ However, nicotine gum does not improve working memory in nonsmokers.³²⁷ The nicotine patch (six hours) enhances working memory only in a subgroup of individuals characterized as "highly attentive."³²⁸ In chronic smokers,

acute nicotine delivered via nasal spray appears to have no effect on verbal working memory, but may have small effects on spatial working memory.³²⁹

Nicotine deprivation in chronic smokers appears to produce decrements on working memory tests. Adolescent smokers deprived of nicotine for 24 hours exhibit significant decrements in performance on an auditory working memory task, compared to performance in a nondeprived state.³³⁰ More than 13 hours of nicotine deprivation also results in longer response latency and poorer performance on an N-back task in adult smokers, compared to performance when nondeprived.³³¹ Similarly, Foulds and colleagues³³² found that subcutaneous nicotine injections (0.3 and 0.6 mg) in abstinent smokers produce faster reaction time on some working memory tasks (e.g., the RVIP), but decreased accuracy on others (e.g., digit recall), compared to saline injections. Abstinent smokers tended to show stronger improvements in RVIP performance due to nicotine than did a comparison group of nonsmokers, again supporting the notion that much of the performance-improving effects of nicotine may reflect reversal of deficits due to withdrawal.

In using the Sternberg memory task, one study found that nasal spray nicotine improves performance of smokers but only under conditions of auditory distraction, which caused decrements in performance at baseline, and not under normal nondistracted conditions.³³³ Thus, effects of nicotine were seen only when the ability to perform the task was impaired because of an environmental condition (distraction), similar to other findings showing nicotine effects when performance is impaired by withdrawal. Nicotine had no effect on performance in nonsmokers, showing that chronic smoking exposure is necessary for nicotine to have any apparent beneficial effect.

Description of Working Memory Tasks in Humans

Some of these tasks are described in detail in chapter 8. Others used primarily with chronic smokers are described here.

N-Back Task. The N-back task, a measure of working memory, is being applied increasingly in human work on nicotine dependence.^{331,334} In this task, participants are asked to look at flashing letters (or geometric figures) on a computer screen, one at a time, and to press the space bar according to four principles or rules: 0-back, 1-back, 2-back, and 3-back. During 0-back, the participant must press the space bar whenever the target stimulus (e.g., letter “X”) appears on the screen. During 1-back, the participant must press the space bar whenever the target stimulus is the same as the previous stimulus (i.e., the stimulus 1-back). A similar rule is followed for 2-back and 3-back, with increasing memory load from 1-back to 3-back. The primary outcomes include the percentage correct and reaction time to correct responses.

Wisconsin Card Sorting Test. The Wisconsin Card Sorting Test (WCST) is a widely used measure of prefrontal cognitive function that is sensitive to a subject’s ability to generate hypotheses, establish response sets, and fluently shift sets.³³⁵ Subjects are required to sort stimulus cards on the basis of perceptual attributes (color, form, number). The only feedback provided by the administrator is whether each response is correct or incorrect. The sorting rule is changed after 10 consecutive correct responses. Testing is discontinued when the subject has learned two iterations of the three sorting rules or has reached 128 trials. The primary outcomes include number of categories achieved, number of trials, number of errors, and percentage and number of perseveration errors.

Sternberg Memory Task. Although not as widely used in nicotine research as

the N-back and the WCST, the Sternberg memory task is a test of verbal memory that requires subjects to memorize a string of letters during a brief (e.g., 10 seconds) period and then to recognize these letters as they are presented individually (in a set that includes letters not part of the original set). Transdermal nicotine has been shown to reverse deficits on this task produced by haloperidol administration.³³⁶ Yet, at least two studies show no clear effects of nicotine via nasal spray on performance of this task in nonsmokers,^{333,337} suggesting that effects of nicotine on such performance may depend on prenicotine level of impairment in performance.

Genetic Influences on Working Memory

Genetic contributions to components of working memory have been explored in a couple of twin studies. For example, in a study of 236 healthy twin pairs, the heritability of working memory was found to range from 43% to 49% for verbal and spatial memory storage (with minimal difference for verbal vs. spatial).³³⁸ Among healthy twins, working memory task performance ranged from 35% to 50%.³³⁹ The degree of heritability of nicotine or abstinence effects on working memory is unknown.

The most widely studied genetic variant in studies of working memory is the *COMT VAL/MET* polymorphism, related to dopamine levels in the frontal cortex, a critical brain region for executive function. In studies of healthy children, adults, patients with schizophrenia, and their relatives, the high-activity **VAL* allele of *COMT* (lower brain dopamine levels) has been associated with poorer performance on working memory tasks (e.g., WCST, N-back).^{290,292,340,341} Interestingly, a few of these studies assessed working memory concurrent with functional magnetic resonance imaging (fMRI). In addition to poorer task performance, several studies show increased activation in regions

of interest (e.g., dorsolateral prefrontal cortex, anterior cingulate), suggesting “less efficient processing” capacity in the **VAL* allele carriers.^{233,290,340,342,343} Studies have explored associations of the functional brain-derived neurotrophic factor (BDNF) *VAL66/MET* polymorphism with working memory performance. One study reported no association in healthy adolescents,³⁴⁴ two studies reported a positive association between the **VAL* allele and performance in psychiatric patients,^{345,346} and another study reported abnormal neural activation in the hippocampus during N-back task performance in healthy adults with the BDNF **MET* allele.³⁴⁷

Only one study was found that examined the relationship of a specific genetic polymorphism with nicotine effects on working memory performance in smokers. In this study,³⁴⁸ 36 adults (22 smokers) completed the N-back task during two fMRI sessions (one with nicotine patch, the other with placebo patch). Individuals with the **T* allele for the functional *DRD2 C957T* polymorphism had worse performance following nicotine administration than those with the **C* allele, a finding attributed by the authors to excess dopaminergic stimulation by nicotine in **T* allele carriers.³⁴⁸ Consistent with other evidence described above, nicotine enhancement of performance may be more difficult to demonstrate; therefore, genetic studies of nicotine abstinence effects on working memory performance may be more informative. Another study found complex, dose-related associations between *DRD4* genotypes and acute nicotine effects on performance of the Sternberg memory task among nonsmokers,³³⁷ as noted in chapter 8.

Relation of Working Memory Measures with Dependence

Only one study was identified relating performance on a working memory task to nicotine-dependence measures or

quitting success. In this small study of schizophrenics, deficits in a visuospatial working memory task predicted a greater likelihood of relapse.³⁰¹

Craving

Craving has long been viewed as a key element of drug dependence in general,¹⁷⁹ and craving for cigarettes is a hallmark of nicotine withdrawal, along with negative mood.² Craving to smoke is thought to be sensitive to at least two broad influences: (1) recent abstinence from smoking (withdrawal) and (2) the presence of discriminative stimuli for smoking (cues). Both types of craving tap the urge to smoke, but the specific underlying mechanisms are undoubtedly different. Notably, the evidence linking each of these types of craving to dependence differs substantially. Thus, these different types of craving appear to reflect very different processes, justifying their clear distinction. The following sections distinguish between these types of craving in evaluating their potential as endophenotypes. However, the description of craving measures other than self-report will emphasize cue-induced craving; these measures are less common in studies of abstinence-induced craving.

Biological Plausibility

Abstinence-Induced Craving

Dependence is marked in part by persistent drug use despite the adverse consequences, sometimes indicated by an inability to abstain. Craving, or a desire to use the drug, that emerges as a result of abstinence is one index of difficulty remaining abstinent, as greater craving is often viewed as a precipitant of relapse (failure to abstain).¹¹⁴ Craving is very reliably increased by duration of smoking abstinence, up to a few days when it tends to peak, and nicotine treatment reliably decreases this craving.³⁴⁹ Although drug use is not always

directly predicted by self-reported craving, particularly in smokers not trying to quit,³⁵⁰ to some extent the biological plausibility for abstinence-induced craving being an endophenotype rests on its high face validity or the reasoning that greater self-reported desire to use the drug reflects the intention to do so.

Cue-Induced Craving

Because abstinence-induced craving has high face validity and has been shown to predict success of a quit attempt (see below), research has investigated the notion that very acute increases in craving elicited by smoking cues may also have predictive validity or, at least, are otherwise important to understanding nicotine dependence. The notion that much of smoking behavior is conditioned to environmental stimuli—that is, cues—has strong support in the literature. Environmental stimuli clearly become conditioned to nicotine and other drug intake in animal models, such that drug self-administration can come under the control of drug-associated cues, regardless of the presence of the drug itself.⁷⁸ Because smokers strongly respond to smoking cues with increases in self-reported craving, and those with very little smoking exposure history (e.g., nonsmokers) do not,³⁵¹ chronic exposure to smoking must condition these craving responses to cues. As further evidence of cue-induced craving, smokers have greater craving responses to environments generally associated with smoking, such as bars, but not to environments where smoking is discouraged, such as churches or theaters. Moreover, smokers respond with even more craving to environments in which they personally tend to smoke (e.g., the interior of their car or in their favorite bar) compared to environments unfamiliar to them but where other smokers tend to smoke (e.g., someone else's car or an unfamiliar bar³⁵²). No other explanation is plausible other than that these environments have come

to elicit craving because of their past association with smoking behavior by the smoker—that is, cue-induced craving. Thus, it would seem very plausible that those who report greater desire to smoke in response to smoking-associated stimuli, or representations of those stimuli (e.g., pictures), should be less likely to refrain from smoking when they confront those stimuli in their environments after quitting (and thus are more nicotine dependent).

Evidence supporting a biological basis for cue-induced craving is found in human neuroimaging research.³⁵³ Experiments using fMRI and positron emission tomography (PET) have explored differences in regional brain activation during presentation of smoking and neutral cues, presented in pictorial or video format. Brain regions most commonly activated during smoking cue presentation include those important in incentive motivation, reward signal processing, and goal-directed behavior (e.g., orbitofrontal cortex, dorsolateral prefrontal cortex, anterior cingulate).^{354–357} Subjective craving during cue exposure correlates with a subset of these regions, although results are not consistent across all studies. Discrepancy in findings across neuroimaging studies of cue-induced smoking craving may be attributable to individual and contextual factors that moderate these responses.³⁵⁸ For example, increased activation is reported when individuals are told they can smoke immediately following the session.³⁵⁹ Differences in racial background may also be important.³⁵⁷ Of importance for the endophenotype criteria used in this chapter, brain activation in response to smoking cues has also been associated significantly with scores on the FTND,²⁹⁹ as well as with specific genetic polymorphisms in the dopamine reward pathway.³⁶⁰ These factors should be considered in laboratory assessment of cue-induced craving as an endophenotype.

Description of Craving Measures and Procedures

Measures of Craving

Craving is typically viewed as the desire or urge to smoke,³⁶¹ although others have argued that craving should be reserved for extreme urges to use a drug.³⁶² Craving is often synonymous with the self-reported desire to smoke, but craving as a clinical phenomenon is believed to have affective, cognitive, and behavioral dimensions,³⁶³ which can be assessed “objectively,” thus offering the potential for being endophenotypes of dependence. Although abstinence-induced craving has been assessed primarily with self-report, measures aiming to capture these other dimensions have been used in studies of abstinence-induced and cue-induced craving and will be discussed below.

Self-Report Measures. Craving, whether due to abstinence or cue exposure, is typically assessed via a number of self-report measures, ranging from single items asking how strong is the desire or urge to smoke (e.g., on Likert or 0–100 visual-analog scales ranging from none to extremely)¹³⁹ to multi-item validated scales, the most popular of which is the Questionnaire on Smoking Urges (QSU).³⁶¹ Notably, the QSU has two factors: the first taps anticipation of pleasurable effects (thought to reflect positive reinforcement from smoking), and the second taps anticipation of relief from aversive mood effects of abstinence (reflecting negative reinforcement). The factors have high reliability (>.90). The QSU has briefer 10-item³⁶⁴ and 4-item³⁶³ versions, although the 4-item version generates a single score. The authors of this chapter assessed the test-retest reliability of this 4-item version of the QSU in 54 smokers who abstained overnight on each of two days; the correlation between days was 0.76, ($p < .001$), showing strong reliability (unpublished data). Moreover, the decrease in this measure of craving following

ad lib smoking was also significantly correlated between days, $r = .48, p < .001$. Other measures of craving include the craving subscale of the Shiffman-Jarvik Withdrawal Scale³⁶⁵ and the Tobacco Craving Questionnaire.³⁶⁶ Self-reported craving in response to auditory vignettes about smoking (i.e., imagery) appears to be stable and reliable.³⁶⁷ To determine abstinence-induced craving, craving is typically measured during ad lib smoking, prior to quitting, and then intermittently over hours or days after abstaining. Similarly, cue-induced craving is usually assessed during a neutral baseline condition and then intermittently over seconds, or at most minutes, following presentation of cues.

Measures of craving other than self-report have been commonly used to assess cue-induced craving, although they should be equally applicable to assessing abstinence-induced craving. Such “objective” measures of craving may have promise as endophenotypes and include psychophysiological, cognitive, and behavioral responses, described below.

Psychophysiological Measures of Craving. Since both tobacco abstinence and drug-related cues involve attentional, affective, and motivational processes, psychophysiological measures reflecting these processes may be potential endophenotypes for craving. These measures include heart rate (HR), electrodermal activity (sweat gland activity in the skin), and skin temperature. HR has been examined as both phasic decreases (rapid changes over a few seconds), which tend to reflect acute attentional processes, and tonic increases (changes over a few minutes), which tend to reflect motivational or affective processes. In a meta-analysis of cue reactivity craving studies, Carter and Tiffany³⁶³ calculated the following effect sizes for these responses to smoking cues: 0.21 for tonic HR, 0.44 for electrodermal activity, and -0.07 for skin temperature,

with the first two being clearly significant. By contrast, these authors reported a very large effect size of 1.18 for self-reported craving in response to cues. (Comparable effect-size values were found for responses to cues for other drugs, except HR response to opiate cues, which was not significant.) Thus, the sensitivity of psychophysiological measures to cues remains a question for research on individual differences in these responses to cues.

Cognitive Measures (attentional bias).

A subsequent approach examined the magnitude of attentional bias toward smoking-related stimuli (e.g., words) in a variation on the Stroop interference task. In this procedure, which has been used with other drugs of abuse,³⁶⁸ subjects are shown words related to smoking (e.g., tobacco, smoking, ashtray, puff, urge) or not related (i.e., control condition), with each word presented in a different color. The task is to respond quickly with the color of the word (i.e., information-processing reaction time). Reaction time slows when smoking-related words are presented, indicating increased allocation of attention to those words.

Procedures to Elicit Cue-Induced Craving

The procedures used to elicit craving in response to cues are almost as diverse as the dependent measures of craving. The most common approaches include presentation of

1. In vivo smoking cues, such as a lit cigarette (and including having the subject lighting and holding it) or the sight of the subject's preferred brand.³⁵¹
2. Photos of smoking-related stimuli, such as people smoking or a lit cigarette in an ashtray.³⁵²
3. Imagery-evoking thoughts of smoking, such as by auditory presentation of vignettes describing a common situation in which a strong desire to smoke occurs (e.g., work stress).¹⁷⁹

Even newer approaches include use of virtual reality techniques to present visual smoking cues.³⁶⁹ A variation on these approaches is to personalize them, such as by using photos of pictorial stimuli from the smoker's actual environment that are associated with his or her smoking, rather than the typical use of generic smoking-related photos. Research has demonstrated that pictorial stimuli of environments where smoking often occurs, but without any explicit smoking-related stimuli (e.g., a bar, but with no ashtrays or cigarettes), can increase self-reported craving.³⁵²

Each of these approaches elicits reliable increases in self-reported craving, although in vivo cues may be most robust. Yet, simply the presence of cues is insufficient to elicit craving. For example, cigarette availability is a clear moderator of craving response to cues, as craving increases much less in response to cues when subjects know that smoking is not possible compared to when they are told that smoking is possible.³⁷⁰ Expecting to be able to smoke also influences the magnitude of fMRI responses in the prefrontal cortex to smoking cues.³⁵⁸ Thus, the prospect of being able to act on cravings to smoke may be necessary for cues to induce motivational effects.

Genetic Influences on Craving

There are no published heritability or family-based studies that elucidate the overall contribution of genetic inheritance to abstinence-induced or cue-induced craving. However, three studies examined associations of genes in the dopamine reward pathway with different measures of cue-elicited cravings. Consistent with neuroimaging evidence for increased activation in the dopamine reward pathway, Hutchison and colleagues³⁷¹ reported that smokers carrying the *7-repeat allele for the *DRD4* gene reported increased craving in response to in vivo smoking cues compared

to those homozygous for the shorter-repeat alleles. Similar results were seen in a neuroimaging study by McClernon and colleagues³⁷² in that those with the *7-repeat allele showed greater activation of right superior frontal gyrus and right insula in response to pictorial smoking cues versus control cues, relative to those without the *7-repeat allele. The *DRD2* gene *A1 allele and dopamine transporter (*SLC6A3*) *9-repeat allele have also been associated with stronger smoking cue-induced craving in a laboratory paradigm.³⁷³ In a PET study, smokers carrying the *DRD4* *7-repeat allele and *SLC6A3* *9-repeat allele showed increased dopamine binding following cigarette smoking; however, smoking-related cues were not explicitly manipulated in this experiment.³⁶⁰ Finally, the serotonin transporter gene *5-HTT* has also been associated with craving as measured by the Stroop task measure of attentional bias among smokers, but not among nonsmokers.³⁷⁴ While preliminary, these data suggest that genes in the dopamine reward pathway, and possibly the serotonin affective regulation pathway, may be important in cue-induced craving.

Association of Craving with Dependence

Abstinence-Induced Craving

Abstinence-induced craving assessed in the days after quitting often, though not always, predicts the outcome of that quit attempt.^{375,376} Abstinence-induced craving is also attenuated by most forms of NRT,^{349,377} bupropion,³⁷⁸ and varenicline,³⁷⁹ although it is not clear that this is the primary mechanism for the efficacy of these FDA-approved cessation medications.

Cue-Induced Craving

Despite some plausibility, available evidence shows no clear demonstration that greater self-reported craving response to smoking cues relates to dependence, as determined by persistence of smoking in a clinical

trial,³⁸⁰ although dependent smokers have greater craving responses to cues than do nondependent smokers (i.e., chippers) in cross-sectional studies.³⁸¹ Moreover, despite the observation that NRT alleviates abstinence-induced craving, self-reported cue-induced craving has not been clearly shown to be influenced by NRT^{382,383} or any other effective cessation medication, including varenicline.³⁸⁴ One study found attenuated craving during a cue reactivity procedure due to active nicotine versus placebo gum, but only in a subset of subjects who were particularly responsive to the cue. All subjects had abstained from smoking for several days, and the effect of the gum was not observed until more than 15 minutes after exposure to the cue, suggesting that nicotine gum attenuated abstinence-induced craving and not cue-induced craving.³⁸⁵ Yet, a rapid rise in urge to smoke during abstinence often precedes a lapse episode (i.e., smoking of at least one cigarette), even weeks after quitting.¹¹⁴ Because this rapid rise cannot be attributable solely to the time course of abstinence, it is conceivable that acute increases in craving in response to other types of environmental challenges (e.g., alcohol or work stress) may predict clinical outcome, even if responses to smoking cues per se do not.

In sum, no prospective study has clearly shown that the magnitude of self-reported craving response to cues prior to quitting predicts outcome of a subsequent quit attempt.³⁸⁰ The only possible exception, out of five, is a study in which reactivity to holding an unlit cigarette prior to quitting predicted time to first lapse and 1-week abstinence in smokers who subsequently quit while using the nicotine patch.³⁸⁶ However, reactivity did not predict lapse or relapse in smokers who quit while using placebo patch and did not predict outcome in the sample as a whole. The fact that cue reactivity did not predict outcome in those treated with placebo or in the entire sample supports null results in the other studies

attempting to link self-reported cue-induced craving to dependence.³⁸⁰ A few studies have related psychophysiological responses to cues and clinical outcome, but these findings are not robust and generally have not been replicated. Regarding heart rate, studies have shown that later relapse risk is related to larger increase in HR response to cues,³⁵¹ larger decrease in HR response,³⁸⁷ or is unrelated to HR response to cues.³⁸⁰ Several studies examining electrodermal response to cues failed to show any relationship to relapse risk.³⁸⁰

However, a study published in 2007 reported that neural activation during viewing of smoking cues versus control cues was attenuated in the amygdala following an extinction-based smoking treatment; yet, reduction of cue-induced activation of the thalamus predicted smoking cessation success.³⁸⁸ Therefore, cessation may be predicted by greater attenuation of neural activation to smoking cues over the early course of treatment. Similar research on cocaine supports the potential validity of this approach, as will be discussed in the “Conclusions” section. Additional studies of this type are clearly needed to confirm the reliability of these findings.

The predictive validity of a cognitively based cue reactivity measure—that is, attentional bias—may be more promising in that several studies by Waters and colleagues³⁸⁹ have related the magnitude of this response slowing (or attentional bias) to dependence. Notably, the authors³⁸⁹ showed that greater attentional bias predicts greater risk of lapsing in the first week after quitting, and that a high-dose (35 mg) NRT patch reduces such bias. Waters and Feyerabend³⁹⁰ also showed that attentional bias is greater after overnight abstinence versus no abstinence and predicts shorter time to first cigarette in the morning, a measure strongly related to cessation outcome, as noted earlier. However, attentional bias was unrelated cross-sectionally to other

measures of dependence or smoking intensity, including FTND, cigarettes per day, and cotinine levels.³⁸⁹

In terms of behavioral responses to cues, as far as known, no research has examined the degree to which greater smoking behavior in response to cues prospectively predicts outcome of a quit attempt. Likewise, no cross-sectional comparison was found of cue-elicited smoking response between groups varying in level of dependence.

Affective Regulation

In addition to the reinforcing effects of nicotine and the ability of nicotine to alter cognitive processes and craving, the effects of nicotine on emotional states may also contribute to nicotine dependence. It has been proposed that in some cases, drug abuse may reflect attempts at self-medication for mental illness.¹⁴ Evidence for this includes the higher prevalence of smoking among those with major depression or schizophrenia; these are conditions with symptoms known to be ameliorated in part by nicotine. However, because the majority of smokers do not suffer from these disorders, a more relevant area of research for understanding basic processes in nicotine dependence is the link between negative affect after abstinence and subsequent smoking. A hallmark of the tobacco withdrawal that usually occurs in most smokers in the first few weeks after quitting is negative affect—that is aversive mood symptoms such as dysphoria, fatigue, sadness, or anxiety.^{175,391,392} Relapse during the first few weeks of abstinence is often seen as a means to relieve these symptoms by resuming smoking, which very reliably eliminates negative affect due to withdrawal. Some clinical research indicates that negative affect in the days or weeks after quitting not only is predictive of cessation outcome (i.e., one measure of dependence severity) but also essentially accounts for all the clinically predictive

value of total withdrawal severity itself. In other words, when the negative affect symptoms of withdrawal are removed from consideration, the severity of the remaining symptoms of withdrawal generally do not predict cessation outcome.⁴ Negative affect after quitting may predict cessation outcome better than do common measures of current smoking intensity, such as cigarettes per day.^{393,394}

Discussed below is the general biological plausibility of measures of affective regulation as candidates for endophenotypes of nicotine dependence, including the substantial evidence in animal models for genetic control of affective regulation measures. Subsequently, various objective affect responses are described that have been examined in smoking and nicotine research as well as the limited data on the heritability of measures of affective regulation. A large number of measures have been used to assess affective regulation. For ease of reading, their description will be accompanied by the evidence linking responses on the particular measure to dependence rather than presenting that text in a separate subsection.

Biological Plausibility

Preclinical Research

Animal studies provide a means for further understanding the complex relationships between nicotine exposure and affect. Nicotine has both anxiolytic and anxiogenic effects, effects that are dependent on many factors including the test of anxiety used,³⁹⁵ dietary intake,³⁹⁶ and the dose of nicotine.^{397–399} For example, in the black/white box test of anxiety, BKW mice treated with nicotine spend more time in the brightly illuminated white side of the box, thus reflecting reduced levels of anxiety-related behavior.⁴⁰⁰ In CD-1 mice, nicotine increases time spent in the open arms of the elevated plus maze, which is another indicator of decreased anxiety.⁴⁰¹

Nicotine also increases the acoustic startle reflex, a measure of affective reactivity.^{242,402} In addition, nicotine infused directly into the raphe nucleus decreases anxiety, as measured by increased social interaction, in hooded Lister rats.⁴⁰³ However, opposite (i.e., anxiogenic) effects of nicotine have also been observed in rats and mice.^{404–406} In addition, systemic administration of nicotine decreases time spent in the open arms of the elevated plus maze, but direct infusion of nicotine into the dorsal hippocampus increased time spent in the open arms in hooded Lister rats, suggesting that the hippocampus may not mediate the anxiogenic properties of nicotine but may be involved in the anxiolytic properties of nicotine in hooded Lister rats.⁴⁰⁷ Finally, in both mice and rats, nicotinic agonists have been shown to have properties similar to antidepressants.^{408–411}

Genetic variability also contributes to the effects of nicotine on affect in rodent models. For example, nicotine can increase, decrease, or produce no effect on startle depending on the strain of mouse used.^{412,413} In a strain survey of open-field activity in BALB, C57, C3H, and DBA mice, nicotine decreased open-field activity in the BALB, C57, and DBA strains but increased activity in the C3H strain.⁴¹²

Genetically modified mice have been extremely useful for understanding both the genetic factors that influence the effects of nicotine on anxiety and for understanding nAChR subtype involvement in the effects of nicotine on anxiety. For example, $\alpha 4$ knockout mice spend significantly less time in the open arms of the elevated plus maze (reflecting increased anxiety) compared to wild-type controls.⁴¹⁴ Interestingly, mice with a leucine to serine point mutation that results in hypersensitive $\alpha 4$ nAChRs also show decreased time in the open arms of the elevated plus maze.⁴¹⁵ The results of these two studies suggest that $\alpha 4$ -containing nAChRs may

mediate anxiety such that overactivation or underactivation of these receptors may increase anxiety. Furthermore, in mice with a single point mutation that results in increased sensitivity of $\alpha 4$ -containing nAChRs, the dose-response curve for nicotine disruption of the startle reflex was shifted to the left.⁴¹⁶ In $\beta 2$ knockout mice, nicotine had no effect on startle, but nicotine did disrupt startle in wild-type littermates. These results suggest that genetic factors contribute to the effects of nicotine on startle and that the $\alpha 4\beta 2$ nAChR may mediate these effects. In $\alpha 5$ nAChR subunit knockout mice, no change in open-field activity is seen, compared to wild-type mice.⁴¹⁷ $\beta 3$ knockout mice show more activity in the illuminated open-field arena compared to wild-type mice.²⁴⁷ Because high illumination is anxiogenic in mice, this increase in activity could be due to changes in locomotor activity, changes in anxiety, or an interaction between the effects of nicotine on anxiety and locomotor activity in the $\beta 3$ knockout mice. These genetic studies illustrate the complexity of both the genetic underpinnings and the phenotype assessments.

Human Clinical Research

Clinical research demonstrates that self-reported negative affect is associated with persistence of smoking, supporting the notion that objective measures of negative affect and its change due to abstinence and smoking in chronic smokers may be relevant endophenotypes of dependence. As noted, smoking is much more common among those with a history of major depression. Much other research shows an association between negative affect and smoking. For example, in a study of 202 smokers, nearly one-half of the sample scored in the depressed range and were more likely to report smoking motivated by a desire to reduce negative affect.⁴¹⁸ Similarly, greater depressed mood and anger after quitting smoking predicts risk of relapse.^{376,419} However, the momentary level of negative

affect after quitting may be less important than the pattern or trajectory of negative affect over time.³⁹¹ A rapid rise in negative affect in a period of hours predicts greater risk of lapsing, but a gradual increase in negative affect in a period of days does not.⁴²⁰ Moreover, although any lapse increases risk of relapse, as noted in the prior section of this chapter, lapses triggered by negative affect due to “stressful” events are more strongly predictive of relapse than are lapses triggered by activities such as eating or drinking alcohol.¹¹⁴ Thus, the predictive value of lapses is not uniform but depends on their context, and the presence of negative affect in the lapse context can be more interruptive of efforts to maintain abstinence.

Less evidence links smoking to anxiety, one component of negative affect. In a study that examined the relationship between anxiety sensitivity and drug use, smoking was positively correlated with scores on an index of anxiety sensitivity.⁴²¹ In the National Comorbidity Study, current smoking rates were significantly higher among individuals reporting anxiety-related disorders in the past month, including social phobia, agoraphobia, panic disorder, or generalized anxiety disorder, compared to respondents with no mental illness.⁴²² Of greater relevance to the focus of this chapter, rates of self-reported quitting success (i.e., being a former smoker) was also significantly lower in most of these groups, relative to the general population.⁴²²

A few studies have examined the affective responses to nicotine or smoking in abstinent smokers, hypothesizing that greater acute self-reported mood response to drug intake would characterize withdrawal relief and could relate to dependence. In two studies, greater reinforcement (i.e., self-administration) from nicotine spray, either in ad lib or choice procedures (see subsection above on “Reinforcement”), was predicted by greater pleasurable mood

effects (reflecting stimulation) from nicotine among briefly abstinent smokers not currently trying to quit permanently.^{122,127} Somewhat similarly, Rose and colleagues⁴²³ found that self-report of smoking for stimulation reasons predicted relapse in young adult smokers, as did greater cigarettes per day. Although this self-report of smoking “motives” does not prospectively assess acute mood responses to smoking, it does presumably reflect the general mood response of smokers to smoking, although biases with such self-report measures are considerable.⁴²⁴ Nonetheless, these data provide a plausible rationale for investigating objective measures of anxiety as potential endophenotypes for nicotine dependence.

Genetic Influences on Measures of Affect in Humans

Although twin studies have documented the role of genetic factors and gene-environment interactions in mood disorders (e.g., anxiety disorder, major depression),^{425–427} as well as in anxiety-related personality traits,^{428,429} the heritability of nicotine or smoking effects on anxiety symptoms is not known. However, a study of a large cohort of twins documented heritability estimates of about 25%–50% for self-reported nicotine withdrawal symptoms that are affective in nature.⁴³⁰ In addition, candidate genes in the dopamine pathway,^{431,432} serotonin pathway,^{433,434} and opioid pathway⁴⁰ have been associated with withdrawal-related affect or moderation of the effects of self-reported affect on smoking behavior. This evidence from self-report measures suggests that laboratory-based measures of affect in chronic smokers may provide useful endophenotypes in future research.

One such laboratory measure, the acoustic startle response, has been shown to exhibit high test-retest reliability in schizophrenic patients and controls, suggesting a trait

component.²⁵⁷ In a study of 170 female twins aged 18–28 years, the heritability of acoustic startle was estimated to be roughly 70%.²⁵⁸ There is also evidence for shared genetic variance with the PPI measure of sensory gating described above.²⁵⁸ No papers were found examining specific genetic variants in relation to the startle response in humans or genetic studies of nicotine effects on the startle response or other objective measures of affect.

Genetic analyses incorporated into functional neuroimaging investigations of affective responses have generated interesting results, however. For example, two studies using fMRI to assess neural responses during presentation of emotional images found increased activation in the amygdala of subjects who carry the short allele of the functional serotonin transporter promoter polymorphism (*5-HTTLPR*) compared with those with the long allele.^{435,436} These effects were equally significant in males and females;⁴³⁵ however, effects of smoking status were not examined. Neural activation in response to unpleasant visual stimuli has also been related to the presence of the low-activity **MET* allele for *COMT* (in contrast to the protective effects of the **MET* allele for neurocognitive performance).⁴³⁷ Similarly, individuals who are homozygous for the *COMT *MET* allele exhibit increased activation in the ventrolateral prefrontal cortex during presentation of faces expressing negative emotions.⁴³⁸ Thus, genes in both the dopamine and serotonin pathways may contribute to neural activity and emotional reactivity, but the role of nicotine in these effects is unknown.

Description of Measures of Affectivity and Association with Dependence

Self-Reported Affect

As with craving, affect (or mood) is usually assessed with self-report measures. Several valid multi-item scales are available,

such as the Positive and Negative Affect Schedule,⁴³⁹ the Mood Scale of Diener and Emmons,⁴⁴⁰ or the Profile of Mood States.⁴⁴¹ These measures were not designed for studies of smoking or even acute drug use but have been shown to be somewhat sensitive to brief drug exposure. Some studies use more specific single items to assess particular moods (e.g., visual-analog scales, from 0 to 100, corresponding to “not at all” to “extremely,” for “stimulated” or “head rush/buzzed”¹⁷⁴). For example, the most widely used self-report withdrawal scale, the Minnesota Nicotine Withdrawal Scale,⁴⁴² is a series of individual symptom items that can be scored individually or combined into a single withdrawal score. Abstinence-induced increases in negative affect are very reliable and peak within a few days after quitting, although some quitters can experience prolonged and/or episodic increases in negative affect.^{391,392} In terms of smoking’s acute effects on mood, smoking, and nicotine in particular, dose-dependently increase responses on measures of arousal, vigor, and head rush, which are typically viewed as pleasurable, but also increase tension and jitteriness, which are usually considered aversive.^{443,444} However, as noted in the introduction to this section, these effects are seen primarily in abstinent smokers and are minimal in nonabstinent (i.e., nondeprived) smokers,⁴⁴³ suggesting that these effects may in fact reflect withdrawal relief rather than the direct pharmacological effects of nicotine. Moreover, few pleasurable effects of nicotine are seen in nonsmokers, although they do report aversive effects of nicotine, such as increases in fatigue, along with those adverse effects seen in smokers. In fact, while “head rush” response is associated with greater nicotine reinforcement (i.e., self-administration) in smokers, that same response is inversely associated with nicotine reinforcement in nonsmokers.¹²⁸ Thus, the same mood response may be pleasurable in smokers but aversive in nonsmokers.

Persistent smoking is strongly related to the degree to which negative affect (as assessed by several of these measures) increases after quitting, and sometimes in anticipation of quitting (i.e., in the days leading up to the quit day), as each increases the likelihood of relapse and speeds its occurrence.^{4,391,445} Thus, abstinence-induced increases in self-reported negative affect are very clearly related to dependence level in chronic smokers. As far as known, no research shows that the magnitude of acute changes in these measures in response to smoking or nicotine predicts persistence of smoking, and some research shows no association. In one prospective study, sensitivity to nicotine's effects on about 12 mood measures or items before a quit attempt were examined for ability to predict withdrawal severity and time to relapse after quitting, and none was significant.¹⁴⁵ A measure of nicotine choice, however, predicted both, showing that the failure of mood responses to predict clinical outcome was not due to inadequate power. In any case, while the degree of self-reported negative affect in the days after quitting strongly predicts smoking persistence, no available research has shown any association between acute mood responses to nicotine or smoking before quitting and subsequent outcome of a quit attempt.

Also, as with craving, negative affect has physiological, cognitive, and behavioral dimensions that cannot be captured by self-report measures, and measures in each of these domains may be potential candidates for endophenotypes of negative affect during tobacco withdrawal. This section integrates a description of the measure with the available data on the relationship to nicotine dependence.

Physiological Responses to Abstinence

Responses to abstinence include physiological changes including decreases in heart rate and in cortisol, a "stress" neurohormone that rises in a period of

minutes following an affective challenge. The magnitude of decline in heart rate is not clearly associated with cessation outcome, but a few studies have related the decline in cortisol to outcome. Al'Absi and colleagues^{419,446} found that the larger the drop in cortisol in the first day or two after quitting, the faster will be the time to relapse. Similarly, Ussher and colleagues⁴⁴⁷ found that decline in cortisol on the first day of quitting was marginally related to relapse at six weeks in smokers treated with a 15-mg nicotine patch. However, they also showed that the smaller the absolute level of cortisol on the day after quitting, the higher is the self-reported craving and withdrawal, suggesting a link between low cortisol and the aversive symptoms of abstinence. This association was significant even after controlling for number of cigarettes per day before quitting. Moreover, a drop in the *ratio* of another steroid hormone, dehydroepiandrosterone (DHEA), to cortisol during the first week of quitting predicted relapse by the end of the second week.⁴⁴⁸ A decrease in this DHEA to cortisol ratio also predicted the increase in withdrawal and the symptom of depression among women, but not in men. Both DHEA and cortisol are released in response to activation of the hypothalamic-pituitary-adrenal axis, which is often associated with stress or negative affect. Thus, greater decline in cortisol or in the DHEA to cortisol ratio in the first days after quitting appears to be a reliable predictor of quitting success and warrants further study. Few other neurohormones have been examined as indices of dependence, but cross-sectional comparisons have been made between hormone levels and current dependence. For example, allopregnanolone and pregnenolone levels were directly correlated with cotinine levels, an index of amount of recent smoking.⁴⁴⁹

Startle Response

A psychophysiological response that is related to affectivity is the startle response.

This response is the magnitude of eyeblink response to a sharp stimulus, usually a brief loud noise, but also can be an electrical pulse; it is thought to reflect a defensive response to threat that may be mediated by the brain's limbic system (i.e., amygdala).⁴⁵⁰ Recall that the PPI of the startle response was discussed previously as a measure of sensory processing. However, the startle reflex itself is related to affect. Research in emotion has shown clearly that negative mood induction increases, and positive mood induction decreases, the magnitude of the startle response.⁴⁵¹ Thus, greater affectivity should be evidenced by larger startle responses. However, a few studies have found no difference in startle magnitude between nondeprived smokers, briefly deprived smokers, and nonsmokers, either during baseline (i.e., in the absence of mood induction)⁴⁵² or in response to negative mood induction.⁴⁵³ Moreover, in within-subjects comparisons, neither overnight abstinence⁴⁵⁴ nor acute smoking, has consistent effects on acoustic startle response.⁴⁵⁵ Notably, however, one study found that smokers who were able to quit for 24 hours had larger startle response before quitting, and quitting decreased startle response 24 hours later.⁴⁵⁶ Startle magnitude was not significantly correlated with scores on the Fagerström Tolerance Questionnaire. This result is contrary to the notion that greater affectivity as indexed by startle response is associated with greater dependence, in that greater startle response before quitting should predict lower, not greater, ability to quit. Similarly, the decline in startle response 24 hours after quitting is the opposite of what would be expected in light of the commonly observed increase in negative affect after quitting.

Distress Tolerance

Individual differences in ability to tolerate distress or to persist with frustrating tasks may put smokers at greater risk for relapse during a quit attempt. For example, Brandon and colleagues⁴⁵⁷ have shown

that lack of persistence with a challenging psychomotor task—that is, mirror tracing (tracing a pattern when seeing its reverse image in a mirror)—before quitting prospectively predicts greater risk of relapse 12 months after quitting. In a similar line of research by Brown and colleagues, responses on a self-report measure of distress tolerance were found to predict early smoking relapse.⁴⁵⁸ The authors made the point that *how* one reacts to distress, rather than severity of withdrawal per se, may be key to relating withdrawal to risk of relapse. Thus, rather than absolute severity of negative affect during withdrawal being the only important factor, it may be the smoker's cognitive appraisal of that negative affect that interacts to predict relapse.

Psychophysiological Response to Acute Stressors

Another approach to studying affective regulation during tobacco abstinence is to test psychophysiological responses to acute stressors (i.e., negative affect in response to contrived challenges rather than to smoking abstinence). Acute stress increases smoking behavior in smokers and increases relapse after a quit attempt.⁴⁵⁹ One notion is that abstinence removes an important method of coping with acute stress—that is, cigarette smoking—which may aid ability to cope via behavioral (e.g., perceived control) or pharmacological (direct actions of nicotine) mechanisms.^{4,459} Acute stress can mimic some of the symptoms of withdrawal, particularly negative affect. Thus, loss of ability to cope with stress may also reflect loss of ability to cope with the symptoms of withdrawal and could relate to the distress-tolerance characteristic noted above.

Psychophysiological responses to stressors may also relate to level of distress, given that systolic blood pressure response to the stressful tasks of mental arithmetic and speech preparation (having to quickly prepare a public speech) predicted faster relapse in women smokers. Male smokers

did not show this association, although greater postural hypotension (drop in systolic blood pressure after standing) predicted faster relapse in men.⁴⁶⁰ Complicating this picture further, another study found that attenuated, not larger, adrenocorticotrophic hormones, cortisol, and diastolic blood pressure responses to mental arithmetic and speech preparation predict faster relapse at four weeks.⁴¹⁹ Thus, psychophysiological responses to stressors are not consistently related to cessation outcome. Yet, as would be expected from the prior discussion of self-report measures of affect, those who relapsed had greater self-reported negative mood and withdrawal at baseline, as well as greater self-reported craving response to the stressor. Notably, these predictors of relapse remained significant after controlling for smoking history characteristics.

In summary, an increase in self-reported negative affect, and perhaps drops in cortisol and DHEA to cortisol ratio responses to abstinence, have been shown to predict faster relapse to smoking after quitting (i.e., smoking persistence). Few other measures of affective regulation have been shown to have consistent associations with cessation.

Impulse Control

Behavioral impulsivity is an important potential area of endophenotype measures for at least two reasons: (1) personality characteristics associated with impulsivity increase risk of becoming dependent on a number of drugs, including tobacco (as discussed in detail in chapter 8), and (2) difficulty concentrating, which can be related to impulsivity, is a reliable symptom of tobacco withdrawal that is clearly relieved by both smoking and nicotine alone (i.e., NRT). In the smoking literature, substantial research has been conducted in both of these areas, but relatively little of it has focused on relating outcome of a

cessation attempt to individual differences in the personality characteristic of impulsivity or in withdrawal symptoms related to impulsivity.

Biological Plausibility

Preclinical Research

Much less research has examined effects of chronic nicotine and nicotine withdrawal on impulse control in rodent models. In one study by Dallery and Locey,⁴⁶¹ rats were trained on a delayed reinforcement paradigm in which they could choose either an immediate reward of a single food pellet or a larger reinforcement of three pellets that had a variable delay. The choice of the smaller, immediate reward over the larger, delayed reward is considered an impulsive choice (parallel to the delay discounting measure discussed below). Chronic nicotine, but not acute nicotine, increased impulsive choice in this study, with persisting effects for 30 days after termination of chronic nicotine treatment. These findings suggest that chronic nicotine alters neural function, resulting in a long-lasting increase in impulsivity.

Although less is known about strain differences in nicotine effects on impulsive behavior in rodents, a few studies suggest that nicotine's effects on impulsivity may be mediated by nAChRs. For example, spontaneously hypertensive rats, a rat strain often used as a model for ADHD, have decreased nAChRs in cortical and subcortical brain regions compared to Wistar-Kyoto rats; however, chronic nicotine produces nAChR upregulation only in the Wistar-Kyoto rats.⁴⁶² Agonist compounds selective for $\alpha 4\beta 2$ nAChRs reduce spontaneous alteration behaviors in a Y-maze task in SHR,⁴⁶³ and DH β E, a competitive $\alpha 4\beta 2$ antagonist, blocks nicotine's effects on impulsive responding.⁴⁶⁴ Much less is known about genetic modulation of nicotine effect on impulsivity than on other endophenotypes examined

in this chapter. However, the Dallery and Locey⁴⁶¹ study described above suggests that effects of chronic nicotine in smokers could maintain dependence and facilitate relapse during abstinence attempts as smokers may favor the immediate gratification of the cigarette over the delayed goals associated with remaining abstinent.

Human Clinical Research

The role of impulsivity in the onset of smoking is discussed at length in chapter 8. Here, the focus is on a smaller set of studies on the role of impulsivity in chronic smokers. As described in the “Attention and Vigilance” subsection above, adult smokers with current or childhood ADHD have more severe nicotine withdrawal after quitting, compared to smokers without any ADHD history.²⁷⁰ In the general population of smokers, the greater the increase in hyperactive/impulsivity symptoms after quitting, the greater the probability of relapse.²⁷³ Moreover, among smokers with a history of major depression, those with higher scores on the Barratt Impulsivity Scale, a common self-report measure, relapse more quickly.⁴⁶⁵ Among smokers not trying to quit, those higher in impulsivity on the Barratt Impulsivity Scale report greater relief of negative affect from a nicotine versus denicotinized cigarette during a laboratory mood-induction procedure.⁴⁶⁶ Such smokers also anticipate greater expectations for positive and negative reinforcing effects of smoking.⁴⁶⁷ This finding is in contrast to findings from an earlier study of treatment-seeking smokers in which self-reported hyperactivity symptoms did not correlate with smoking motives.²⁷¹

Description of Impulsivity Measures

In addition to the common self-report measures of impulsive personality characteristics, several “objective” measures of impulsivity and behavioral inhibition may serve as potential endophenotypes of dependence.

Delay Discounting

Delay discounting measures the tendency to choose smaller, immediate rewards over larger, delayed rewards and is believed to reflect impatience and a desire for immediate gratification. Drug dependence is often viewed as choosing an immediate reward, drug use, over larger, delayed rewards—namely, the long-term gains in health outlook by abstaining from drug use. (Long-term gains in choosing abstinence among illicit drug users include increased employability, improved family relations, reduced legal problems). Delay discounting has been used in a variety of studies of drug dependence in both humans and nonhuman animals.⁴⁶⁸ In this task, participants are given repeated choice options between a large monetary option, to be made available to the participant after different durations of delay, such as in one day, one week, one month, six months, and a year, versus different amounts of lesser, immediate rewards.⁴⁶⁹ The smallest amount of immediate reward the participants select in preference to the larger, delayed reward at each duration of delay reflects the degree to which they discount the value of the delayed reward. Plotting these choices leads to a temporal discounting function for each individual, which can be averaged for subgroups. The sharper the decrease in the function (i.e., the smaller the current reward chosen over the delayed reward), the greater the discounting and, presumably, the more impulsive the subject. Performing this task involves sorting (choosing) actual cards containing the different money and delay choices,⁴⁶⁹ but the task is easily presented by computer presentation of the choices and having subjects choose via computer key. This task is also commonly done with hypothetical choices, rather than actual choices. Some research suggests that findings are similar regardless of whether actual or hypothetical choices are offered,⁴⁷⁰ but other studies suggest that actual choices may be more sensitive.⁴⁷¹ A variation on this task involves probability discounting,

or greater discounting of smaller, more certain rewards in favor of larger, less certain rewards.⁴⁷²

Go/No-Go Task

The go/no-go task requires a subject to make a motor response according to a conditional rule (e.g., in response to a target stimulus) and to inhibit a motor response according to a similar rule.^{473–475} For example, a downward-pointing triangle may be used as a target stimulus and an upward-pointing triangle as the nontarget stimulus. Although this task is conceptually similar to the CPT described above, the rate and reaction time for commission errors (i.e., responses made to the nontarget or no-go stimulus) provides a measure of behavioral inhibition.

Stroop Task

The Stroop task measures the ability to inhibit a prepotent response to a stimulus and, therefore, provides an objective measure of response inhibition of relevance to impulsivity traits. In this task, subjects view a series of words printed in color (e.g., either green or red) and are instructed to identify the color of the ink used. In some cases, the word color and the ink color match (e.g., the word *red* written in red ink; congruent word), and in other cases, the word and color are incongruent (e.g., the word *green* written in red ink). The classic Stroop effect is the difference in reaction time for naming colors for incongruent versus congruent words. This task has been adapted as a measure of attentional bias, as noted previously.³⁶⁸

Genetic Influences on Impulsivity Task Responses in Humans

A few studies have examined the heritability of laboratory-based measures of impulsivity. Using the standard Stroop task as a measure of resistance to interference in 290 twins, Stins and colleagues⁴⁷⁶ reported a heritability of 50% for the Stroop effect (i.e., reaction-time difference). For the

go/no-go task, among 400 twin pairs, heritability for mean reaction time (across fast and slow tasks) was 60%, and the heritability of commission error rates was 18% for the slow condition and 38% for the fast condition.⁴⁷⁷ Groot and colleagues⁴⁷⁸ studied 237 healthy twin pairs and found differences in heritability estimates by gender. For example, the commission rate heritability on the go/no-go task was 36% among females and 53% among males. In a combined assessment of performance on the go/no-go task and ERPs, Anokhin and colleagues⁴⁷⁹ showed that about 60% of the variance in electrophysiological responses during the task was attributable to genetic influences. The go/no-go task also exhibits high heritability in extended pedigrees with schizophrenia.⁴⁸⁰

Associations of specific candidate gene variants with laboratory measures of impulsivity have been examined in a few studies. Cornish and colleagues⁴⁸¹ studied 58 boys scoring above the 90th percentile on ADHD diagnostic symptoms and 58 scoring below this cutoff. Children homozygous for the *10-repeat allele of the dopamine transporter gene had poorer performance on a response inhibition task, independent of ADHD symptoms. Three studies have examined genetic associations with performance on the go/no-go task. Among 133 children with ADHD, those carrying the *7-repeat allele of the *DRD4* gene had greater impulsivity, faster reaction time, and reduced accuracy, compared to those with the shorter-repeat variants.⁴⁸² There is also evidence that delay discounting is associated with an interaction between the *DRD2 TAQ1* *A1 allele and the *DRD4* VNTR (*7-repeat) allele.⁴⁸³

Two genes involved in the metabolism of dopamine have been associated with laboratory measures of impulsivity. In one study, a monoamine oxidase A gene polymorphism was linked with performance on the go/no-go task.⁴⁸⁴ In two other studies,

the *COMT VAL/MET* genotype described above was associated with performance on the Stroop task,^{235,485} with an interaction between the *DRD2 TAQIA* variant and *COMT* variants in the earlier study.⁴⁸⁵

Emerging evidence also supports an association of genetic polymorphisms in the serotonin pathway with endophenotype measures of impulsivity. For example, a study in 2006 showed a relationship between the number of commission errors on the go/no-go task and the *A-1438A allele of the serotonin receptor 2A gene *5-HT2A*.⁴⁸⁶ Of particular relevance to endophenotypes for nicotine dependence, one study suggests that a performance on a modified “smoking stimuli” Stroop task in smokers is associated with the promoter polymorphism in the serotonin transporter gene;³⁷⁴ however, this modified Stroop task may be measuring attentional bias to smoking cues rather than response inhibition per se. These data are preliminary but suggest that genetic variation in the dopamine and serotonin pathways may play a role in impulsive behavior as assessed by objective laboratory measures.

Association of Impulsivity Task Responses and Nicotine Dependence

Current smokers often, but not always, show greater delay discounting than never smokers or even former smokers,^{469,472,487,488} and cigarettes per day are correlated with degree of delay discounting,⁴⁸⁹ suggesting a linear relationship between amount of smoking intake and impulsivity. However, although greater delay discounting was associated with greater smoking frequency in one laboratory study, nicotine versus placebo patch did not influence delay discounting.⁴⁹⁰ The specific procedures used may moderate the findings in laboratory studies of delay discounting. For example, in one study, brief abstinence increased delay discounting of both cigarettes and money when they were actually available,

but no delay discounting was seen when the choices were hypothetical.⁴⁷¹ Also, because lower education is associated with greater delay discounting,⁴⁹¹ education needs to be controlled in comparisons between groups. Despite common findings of greater delay discounting in smokers versus nonsmokers, there appears to be no reliable difference in probability discounting.^{472,489}

Less is known about the relationship of objective laboratory measures of impulsivity with nicotine dependence or smoking cessation outcome. In one study of adolescent smokers, those with higher scores on the delay discounting measure were more likely to relapse.³⁰⁰ However, in a study of schizophrenics seeking treatment for smoking, the Stroop task did not predict smoking cessation success.³⁰¹

Discussion and Recommendations for Future Research

This final section reviews findings on the potential for the measures discussed here as endophenotypes for dependence in chronic smokers and outlines future directions for this research. Each putative endophenotype will be addressed within its broad area in the following subsections on “Motivational Effect Endophenotypes” and “Acute Smoking or Abstinence Effect Endophenotypes.” The findings are summarized in tables 9.1 and 9.2, respectively.

Motivational Effect Endophenotypes

Measures of the motivational effects of nicotine would be expected to offer greater promise as endophenotypes early in this research effort, as they are more proximal to dependence, as indicated in figure 9.1. As noted, the frequency and persistence of drug reinforcement is a central feature

Table 9.1 Putative Endophenotypes for Nicotine Dependence: Motivational Mechanisms and Nicotine or Abstinence Effects

Measure	Biological plausibility	Standard, objective, and reliable	Evidence of genetic influence	Linked to dependence
Reinforcement				
Ad lib self-administered	++	+	±	+
Nicotine choice	+	+	+	+
Behavioral economics	+	+	0	0
Progressive ratio	+	+	0	0
Reward				
Self-report of hedonic effects	+	+	0	±

Note. ++ = strong confirmatory evidence; + = some confirmatory evidence; ± = little or equivocal evidence; 0 = no available evidence.

Table 9.2 Putative Endophenotypes for Nicotine Dependence: Acute Smoking or Abstinence Effects

Measure	Biological plausibility	Standard, objective, and reliable	Evidence of genetic influence	Linked to dependence
Physiological				
Resting EEG	±	+	+ ^a	0
ERP	±	+	+ ^a	0
PPI	+	+	+ ^a	0
Cognitive function				
Attention	±	+	+ ^a	0
Working memory	±	+	+ ^a	0
Craving				
Abstinence-induced				
Self-reported urge	++	++	0	+
Cue-induced				
Self-reported urge	++	++	±	±
Psychophysiological	±	+	0	–
Cognitive/attentional bias	±	+	±	+
Affective regulation ^b				
Abstinence-induced				
Self-reported negative affect	++	+	0	++
Physiological	±	+	+ ^a	+
Startle	±	+	+ ^a	0
Distress tolerance	+	±	0	+
Stress/physiological	+	+	0	±
Impulse control				
Delay discounting	+	+	0	0
Go/no go	±	+	+ ^a	0

Note. EEG = electroencephalogram; ERP = event-related potentials; PPI = prepulse inhibition; ++ = strong confirmatory evidence; + = some confirmatory evidence; ± = little or equivocal evidence; 0 = no available evidence; – = some contrary evidence.

^aEvidence regarding the measure in general, no evidence for effect of abstinence or acute smoking.

^bVirtually no evidence of acute effects of smoking on affective regulation was associated with dependence. Consequently, those measures are not included here; only measures during smoking abstinence are included.

of dependence and, therefore, acute laboratory measures of the frequency and persistence of reinforcement do not require extensive assumptions about the link between these measures and dependence. Measures of ad lib smoking or nicotine self-administration and nicotine choice procedures generally show some of the expected relationships between responses and simple manipulations of smoking abstinence. These measures are also fairly objective and reliable, and there is some evidence for associations with candidate genes; however, the heritability of nicotine self-administration measures is unknown.

The behavioral economic and PR self-administration procedures have received less scrutiny, particularly with regard to genetic influences. However, these are conceptually similar to self-administration measures and are comparably objective and reliable; thus, they may have similar strengths and characteristics, such as being heritable. However, aside from the choice procedure, few of these measures have been related prospectively to dependence by predicting outcomes of a quit attempt, ultimately the key clinical utility of this research.

In terms of future directions for reinforcement measures, use of the PR is common in animal genetic models and for medication screening, and it warrants more attention in human studies. To enhance the sensitivity of this approach, methodological studies to determine the optimal duration of prior abstinence, timing of drug administration, rate of escalation of the PR schedule, and session length would be valuable.

Another procedure that could be adapted to assess individual differences in some aspects of relapse proneness (i.e., dependence as indexed by smoking persistence) is the “programmed lapse” procedure.⁴⁹² In this procedure, smokers are required to abstain for a few days and then instructed to either

smoke a few cigarettes to simulate a lapse or to not smoke (control condition). All are instructed to then continue to maintain abstinence, and the measure of interest is duration of abstinence after the simulated “lapse” point. This procedure is sometimes viewed as comparable to the “reinstatement” procedure widely used in animal research as an analog to relapse,⁴⁹³ although there are substantial limitations of reinstatement as a model for human drug relapse.⁴⁹⁴ In any case, some aspects of the programmed lapse procedure could be used to assess each of the phases of smoking relapse in humans: (1) time to first lapse could be examined by instructing subjects to abstain and then prospectively assessing the time to first cigarette,⁴⁹⁵ (2) time interval between first and second lapse is essentially what is already determined by the existing programmed lapse procedure,⁴⁹² and (3) time to relapse would simply require more extended follow-up to determine when the criteria for relapse (e.g., seven consecutive days of any smoking)⁴⁹⁶ are met. For each of these measures, subjects who are able to abstain for longer periods presumably should be those able to quit for longer periods in an actual quit attempt, but this would need to be verified. A more practical measure of persistence of abstinence may be to simply see if the smoker is able to quit for 24 hours, which differentiates high- and low-dependent smokers making an actual quit attempt¹¹⁵ or not trying to quit permanently.⁴⁹⁷ However, this approach results in a dichotomous measure (able versus unable to abstain), which may be insensitive for use in other research relating the measure to other factors.

The other measure within this broad area, smoking or nicotine “reward,” has less evidence supporting its use as an endophenotype, as it is not yet measured in humans in an “objective” way. However, these measures, generally obtained in humans via self-report of “liking” or “satisfaction,” are easy to assess and are

reliable. The magnitude of smoking or nicotine “reward” has strong biological plausibility, and there are objective measures in animals that are thought to reflect reward (e.g., CPP and ICSS). Thus, these measures hold promise as potential endophenotypes for dependence in human smokers, if human equivalent measurement procedures can be found. Although there are obvious impediments to developing brain stimulation measures of reward threshold, it seems plausible that human models of CPP could be developed and validated. However, such complex measures may not add significantly to the armamentarium of human laboratory models; perhaps more attention should be devoted to assessing genetic associations with self-report measures of nicotine reward within the context of other laboratory paradigms.

A key issue that pertains to research on all of the measures discussed in this chapter, not just self-administration and reward measures, is the failure of virtually all laboratory studies of these measures to assess them in smokers preparing to quit. The motivational effects of smoking and nicotine are clearly different in smokers preparing to quit than they are in smokers with no interest in quitting.¹⁴¹ There is reason to think that the effects of brief abstinence and the acute effects of smoking or nicotine on cognitive, affective, and other functioning may vary depending on whether the subjects are smokers preparing to quit or are not interested in quitting permanently. If so, use of non-treatment-seeking smokers (i.e., those not trying to quit) in this research may contribute to the failure of many of these measures to show sensitivity to dependence. Use of such smokers is not surprising; these procedures were adopted from animal research, which, perhaps necessarily, has focused only on the acquisition and maintenance of drug self-administration. Animal studies have not been used effectively to model “voluntary” abstinence from drug use, as in human

quit smoking attempts,⁴⁹⁴ and none of the procedures directly assesses ability to *maintain abstinence*, a critical index of dependence. Thus, differences in quitting motivation between laboratory research participants and smokers in clinical studies may impede the development and validation of brief laboratory-based behavioral procedures that may serve as endophenotypes.¹⁴¹

Acute Smoking or Abstinence Effect Endophenotypes

The cognitive, affective, and behavioral impulsivity measures discussed in this section have at least some biological plausibility and preclinical data to support nicotine effects. Further, many of these constructs can be assessed in a very objective and reliable manner. Some, notably the measures of sensory processing, attention and vigilance, working memory, and impulsivity have clear evidence of heritability. However, this evidence pertains to responses on these measures in general rather than to acute responses on these measures to smoking or abstinence.

Since acute smoking or abstinence effects on these measures are thought to be more distal to nicotine dependence (figure 9.1), these measures require a greater leap from the underlying mechanisms responsible for these effects and processes to nicotine dependence. Consistent with this assumption, virtually none of the measures in this broad area have been directly associated with dependence in chronic smokers, especially as predictors of smoking persistence during a quit attempt, the gold-standard index of dependence in smokers adopted in this chapter. Yet, virtually no evidence links any of these objective measures with persistent smoking in chronic smokers, with the exception of abstinence-induced self-reported craving and negative affect and perhaps hormonal responses to abstinence (cortisol or related measures). It is important to note that lack of research

attention, rather than disconfirmatory findings, characterize the research in this broad area.

Other objective measures with preliminary support for a relationship to dependence are the attentional bias measure of cue-induced craving³⁸⁹ and the affective regulation measure of “distress tolerance,”^{457,458} which are not strictly acute responses to smoking or to abstinence but are more traitlike. These measures deserve further attention with respect to heritability of smoking and abstinence effects as well as associations of candidate genes. Evidence that alcohol priming can alter attentional bias to smoking cues suggests a “state” component as well.⁴⁹⁸ Such cross-substance paradigms may provide interesting endophenotypes for genetic studies as well.

Cue-induced craving has substantial biological plausibility on the basis of preclinical and neuroimaging studies. However, thus far, cue-induced craving has virtually no validity as an index of dependence as determined by cessation outcome.³⁸⁰ Furthermore, NRT has no effect on cue-induced craving, whether in smokers wanting or not wanting to quit permanently.^{382,383,386} In contrast, NRT robustly reduces abstinence-induced craving, even acutely in those not trying to quit,³⁷⁷ and reduces risk of relapse.³⁴⁹ Yet, olanzapine, an antipsychotic medication not known or proposed to be efficacious for smoking cessation, nevertheless attenuates cue-elicited craving to smoke in healthy smokers.⁴⁹⁹ Thus, there appears to be no clear link between the magnitude of cue-induced craving or influences on this type of craving and indices of dependence in adult smokers.

Some of the difficulty with “reactivity” research could be lack of generalizability between the cues used (i.e., the independent variables) and the stimuli that elicits craving and lapses in the smoker’s natural environment. Research has demonstrated that photos of personalized contexts for

smoking (e.g., one’s favorite bar) can elicit as robust an increase in self-reported craving as more typical cues, such as photos of lit cigarettes,³⁵² and stronger craving than generic photos of the same contexts (e.g., a typical bar). Such research may also benefit by using other types of stimuli that reflect situations tied to smoking lapses but do not directly involve smoking, such as familiar stressors faced by the smoker. For example, in a study of cocaine abuse patients, Sinha and colleagues⁵⁰⁰ found that self-reported craving for cocaine in response to a personalized stress-related imagery script, but not to a personalized cocaine-related script, predicted faster relapse to cocaine use. Thus, greater generalizability in reactivity may result from use of personalized cue stimuli or stimuli that otherwise are more representative of the common relapse situations in a smoker’s environment, and reactivity to such cues may be more predictive of relapse after quitting.

Alternatively, the problem with the lack of predictive validity of cue reactivity in the available studies may stem from the responses assessed—that is, the dependent variables—rather than, or in addition to, the independent variables used. The vast majority of studies assess self-reported craving, although some also assess psychophysiological responses.³⁸⁰ Perhaps broadening the reactivity responses may reveal some that are more strongly tied to relapse, as suggested in the small preliminary study by McClernon and colleagues³⁸⁸ noted previously. For example, in addition to showing that self-reported craving in response to stress imagery, but not to cocaine imagery, predicted cocaine relapse, the study noted above by Sinha and colleagues⁵⁰⁰ also found that greater corticotrophin and cortisol responses to the stress imagery predicted higher amounts of cocaine used per lapse occasion during the follow-up period, although these responses were not related to time to relapse. Somewhat similarly, it was found that fMRI

measurement of brain activation in response to cocaine-related videotapes predicted subsequent relapse in cocaine patients, but self-reported craving in response to the videotapes did not.⁵⁰¹ However, given that attenuated physiological responses, including cortisol, to acute lab-based stressors were shown to predict smoking relapse,⁴¹⁹ it is not clear that heightened responding to stimuli should necessarily be of more interest than blunted response.

Consistent with the notion that cue reactivity research may need to reconsider its dependent measures, such studies may benefit from assessing smoking behavioral responses to such cues.³⁸⁰ Because prospective research relating any laboratory measure to cessation outcome can be difficult, one intermediate step may be to determine that cues robustly elicit increases in measures of smoking reinforcement, which may be more likely to relate to dependence than do other craving measures. Animal and human evidence shows that cues can have as much, and often more, influence on drug-taking behavior as the drug nicotine itself.⁷⁸ Research from the cocaine field indicates that human laboratory self-administration models are better predictors of the clinical efficacy of medications than are results using self-reported craving as the primary dependent measure.⁵⁰² Thus, variability in the degree to which smoking behavior, rather than self-reported craving, is altered by cues could provide a more fruitful direction for cue reactivity research aimed at identifying factors responsible for dependence.

Assessing the influence of cues on reinforcement can be assessed with most of the acute procedures presented above in the “Motivational Effect Endophenotypes” section. For example, the presence of a lit cigarette cue increases responding for cigarette puffs under the highest response requirements (i.e., price) in a variation on the behavioral economics procedure.¹⁴⁷ Also,

rather than simply presenting a pictorial or in vivo cue for the smoker’s observation, as in standard cue reactivity research,³⁶³ research should increase the cue salience by providing virtually the entire smoking experience as a cue via denicotinized (placebo) cigarettes. Here, the smoker experiences not only the sight and smell of the cigarette, but also much of the taste and sensory effects of inhaling smoke, but with no nicotine intake. The availability of credible placebo cigarettes has resulted in an increase in their use in a number of areas of smoking research.^{137,149} The magnitude of responses to such smoking, which can be viewed as conditioned responses to smoking cues, may be related cross-sectionally to dependence, as suggested.⁵⁰³

Summary

This chapter describes a series of objective laboratory-based measures of motivational mechanisms and acute smoking or abstinence effects as potential endophenotypes for nicotine dependence. Although the motivational measures—in particular, ad libitum self-administration and nicotine choice—have been related to dependence, data on heritability and genetic associations are lacking. The converse is true for measures of acute smoking or nicotine abstinence effects. Sensory, cognitive, affective, and behavioral measures in this area appear to be heritable, and specific genetic associations have been identified; however, this research has not examined genetic influences in the context of nicotine effects, and no data are available to judge the relationship to nicotine dependence. As shown in tables 9.1 and 9.2, there is great potential for research to provide evidence for or against the criteria important for endophenotype measures of nicotine dependence. Although the utility of endophenotypes in genetics research is still a topic of some debate,⁵² this debate can only be resolved through rigorous future research.

Conclusions

1. Nicotine dependence in chronic smokers is characterized by persistent smoking behavior despite knowledge of its harm (e.g., an inability to sustain a quit attempt). Reinforcement measures such as nicotine choice have been related to nicotine dependence, although further research is needed on the relationship between dependence and ad libitum drug self-administration, behavioral economics, and progressive ratio measures. Genetic studies in reinforcement measures in mice indicate a potential for studying the heritability and genetic influence for these behaviors in humans.
2. Limited evidence exists regarding the relation between self-reported measures of reward and nicotine dependence in humans, while animal studies show a potential link between the reward-related measure of conditioned place preference and nicotine dependence.
3. Evidence of heritability and genetic influence has been established for measures of sensory processing, such as resting electroencephalogram activity, event-related potentials, and the prepulse inhibition of startle response, as well as cognitive measures such as attention and working memory. Further research is indicated to investigate the relationship of such measures to nicotine dependence in humans.
4. Self-report measures of abstinence-induced craving have been related to the success of cessation efforts (i.e., dependence), while neither self-report nor psychophysiological measures of cue-induced craving have been reliably shown to relate to nicotine dependence. The relationship of these measures with genetic factors remains an area for further investigation.
5. Self-reported levels of negative affect following smoking cessation have been strongly related to smoking persistence. Persistence has also been associated with abstinence-induced changes in physiological measures such as cortisol and the dehydroepiandrosterone to cortisol ratio. Other measures of affect have not been shown conclusively to relate to measures of nicotine dependence.
6. Impulsivity and cognitive control measures such as delay discounting, the go/no-go task, and the Stroop interference task have not been shown conclusively to relate to nicotine dependence, while the go/no-go task has shown some evidence of heritability and relation to genetic factors.
7. Overall, the available evidence supports the possibility of endophenotypes for nicotine dependence in chronic smokers on the basis of motivational factors and, to a lesser extent, sensory, cognitive, affective, and behavioral measures. Further research is indicated to help establish a consistent pattern of heritability, genetic influence, and association with nicotine dependence for measures in each of these areas.

References

- Szatmari, P., M. Maziade, L. Zwaigenbaum, C. Merette, M. A. Roy, R. Joober, and R. Palmour. 2007. Informative phenotypes for genetic studies of psychiatric disorders. *American Journal of Medical Genetics Part B, Neuropsychiatric Genetics* 144B (5): 581–88.
- American Psychiatric Association. 1994. *Diagnostic and statistical manual of mental disorders: DSM-IV*. 4th ed. Washington, DC: American Psychiatric Association.
- Heatherton, T. F., L. T. Kozlowski, R. C. Frecker, and K. O. Fagerström. 1991. The Fagerström Test for Nicotine Dependence: A revision of the Fagerström Tolerance Questionnaire. *British Journal of Addiction* 86 (9): 1119–27.
- Baker, T. B., M. E. Piper, D. E. McCarthy, M. R. Majeskie, and M. C. Fiore. 2004. Addiction motivation reformulated: An affective processing model of negative reinforcement. *Psychological Review* 111 (1): 33–51.
- Piper, M. E., D. E. McCarthy, and T. B. Baker. 2006. Assessing tobacco dependence: A guide to measure evaluation and selection. *Nicotine & Tobacco Research* 8 (3): 339–51.
- Li, M. D. 2006. The genetics of nicotine dependence. *Current Psychiatry Reports* 8 (2): 158–64.
- Sullivan, P. F., and K. S. Kendler. 1999. The genetic epidemiology of smoking. *Nicotine & Tobacco Research* 1 Suppl. 2: S51–S57, S69–S70.
- Xian, H., J. F. Scherrer, P. A. Madden, M. J. Lyons, M. Tsuang, W. R. True, and S. A. Eisen. 2003. The heritability of failed smoking cessation and nicotine withdrawal in twins who smoked and attempted to quit. *Nicotine & Tobacco Research* 5 (2): 245–54.
- True, W. R., H. Xian, J. F. Scherrer, P. A. Madden, K. K. Bucholz, A. C. Heath, S. A. Eisen, M. J. Lyons, J. Goldberg, and M. Tsuang. 1999. Common genetic vulnerability for nicotine and alcohol dependence in men. *Archives of General Psychiatry* 56 (7): 655–61.
- Bergen, A. W., J. F. Korczak, K. A. Weissbecker, and A. M. Goldstein. 1999. A genome-wide search for loci contributing to smoking and alcoholism. *Genetic Epidemiology* 17 Suppl. 1: S55–S60.
- Pomerleau, C. S. 1997. Co-factors for smoking and evolutionary psychobiology. *Addiction* 92 (4): 397–408.
- Kendler, K. S., M. C. Neale, C. J. MacLean, A. C. Heath, L. J. Eaves, and R. C. Kessler. 1993. Smoking and major depression. A causal analysis. *Archives of General Psychiatry* 50 (1): 36–43.
- Lyons, M. J., J. L. Bar, W. S. Kremen, R. Toomey, S. A. Eisen, J. Goldberg, S. V. Faraone, and M. Tsuang. 2002. Nicotine and familial vulnerability to schizophrenia: A discordant twin study. *Journal of Abnormal Psychology* 111 (4): 687–93.
- Dani, J. A., and R. A. Harris. 2005. Nicotine addiction and comorbidity with alcohol abuse and mental illness. *Nature Neuroscience* 8 (11): 1465–70.
- Malaiyandi, V., E. M. Sellers, and R. F. Tyndale. 2005. Implications of CYP2A6 genetic variation for smoking behaviors and nicotine dependence. *Clinical Pharmacology and Therapeutics* 77 (3): 145–58.
- Lerman, C., R. Tyndale, F. Patterson, E. P. Wileyto, P. G. Shields, A. Pinto, and N. Benowitz. 2006. Nicotine metabolite ratio predicts efficacy of transdermal nicotine for smoking cessation. *Clinical Pharmacology and Therapeutics* 79 (6): 600–608.
- Malaiyandi, V., C. Lerman, N. L. Benowitz, C. Jepson, F. Patterson, and R. F. Tyndale. 2006. Impact of CYP2A6 genotype on pretreatment smoking behaviour and nicotine levels from and usage of nicotine replacement therapy. *Molecular Psychiatry* 11 (4): 400–409.
- Lavolette, S. R., and D. van der Kooy. 2004. The neurobiology of nicotine addiction: Bridging the gap from molecules to behaviour. *Nature Reviews Neuroscience* 5 (1): 55–65.
- Lukas, R. J. 2007. Pharmacological effects of nicotine and nicotinic receptor subtype pharmacological profiles. In *Medication treatments for nicotine dependence*, ed. T. P. George, 3–22. Boca Raton, FL: CRC Press.
- Hutchison, K. E., D. L. Allen, F. M. Filbey, C. Jepson, C. Lerman, N. L. Benowitz, J. Stitzel, A. Bryan, J. McGeary, and H. M. Haughey. 2007. CHRNA4 and tobacco dependence: From gene regulation to treatment outcome. *Archives of General Psychiatry* 64 (9): 1078–86.
- Lueders, K. K., S. Hu, L. McHugh, M. V. Myakishev, L. A. Sirota, and

- D. H. Hamer. 2002. Genetic and functional analysis of single nucleotide polymorphisms in the beta2-neuronal nicotinic acetylcholine receptor gene (CHRN2). *Nicotine & Tobacco Research* 4 (1): 115–25.
22. Conti, D.V., Lee, W., Li, D., Liu, J., Van Den Berg, B., Thomas, P.D., et al. 2008. Nicotinic acetylcholine receptor $\beta 2$ subunit gene implicated in a systems-based candidate gene study of smoking cessation. *Human Molecular Genetics* 17: 2834–2848.
23. Feng, Y., T. Niu, H. Xing, X. Xu, C. Chen, S. Peng, L. Wang, N. Laird, and X. Xu. 2004. A common haplotype of the nicotine acetylcholine receptor alpha 4 subunit gene is associated with vulnerability to nicotine addiction in men. *American Journal of Human Genetics* 75 (1): 112–21.
24. Li, M. D., J. Beuten, J. Z. Ma, T. J. Payne, X. Y. Lou, V. Garcia, A. S. Duenes, K. M. Crews, and R. C. Elston. 2005. Ethnic- and gender-specific association of the nicotinic acetylcholine receptor alpha4 subunit gene (CHRNA4) with nicotine dependence. *Human Molecular Genetics* 14 (9): 1211–19.
25. Weiss, R. B., T. B. Baker, D. S. Cannon, A. von Niederhausern, D. M. Dunn, N. Matsunami, N. A. Singh, et al. 2008. A candidate gene approach identifies the CHRNA5-A3-B4 region as a risk factor for age-dependent nicotine addiction. *PLoS Genetics* 4 (7): e1000125.
26. Heinz, A., D. Goldman, J. Gallinat, G. Schumann, and I. Puls. 2004. Pharmacogenetic insights to monoaminergic dysfunction in alcohol dependence. *Psychopharmacology (Berl)* 174 (4): 561–70.
27. Koob, G. F., and M. Le Moal. 1997. Drug abuse: Hedonic homeostatic dysregulation. *Science* 278 (5335): 52–58.
28. Nestler, E. J. 2005. Is there a common molecular pathway for addiction? *Nature Neuroscience* 8 (11): 1445–49.
29. Neville, M. J., E. C. Johnstone, and R. T. Walton. 2004. Identification and characterization of ANKK1: A novel kinase gene closely linked to DRD2 on chromosome band 11q23.1. *Human Mutation* 23 (6): 540–45.
30. Comings, D. E., L. Ferry, S. Bradshaw-Robinson, R. Burchette, C. Chiu, and D. Muhleman. 1996. The dopamine D2 receptor (DRD2) gene: A genetic risk factor in smoking. *Pharmacogenetics* 6 (1): 73–79.
31. Spitz, M. R., H. Shi, F. Yang, K. S. Hudmon, H. Jiang, R. M. Chamberlain, C. I. Amos, et al. 1998. Case-control study of the D2 dopamine receptor gene and smoking status in lung cancer patients. *Journal of the National Cancer Institute* 90 (5): 358–63.
32. Bierut, L. J., J. P. Rice, H. J. Edenberg, A. Goate, T. Foroud, C. R. Cloninger, H. Begleiter, et al. 2000. Family-based study of the association of the dopamine D2 receptor gene (DRD2) with habitual smoking. *American Journal of Medical Genetics* 90 (4): 299–302.
33. Lerman, C., N. E. Caporaso, J. Audrain, D. Main, E. D. Bowman, B. Lockshin, N. R. Boyd, and P. G. Shields. 1999. Evidence suggesting the role of specific genetic factors in cigarette smoking. *Health Psychology* 18 (1): 14–20.
34. Sabol, S. Z., M. L. Nelson, C. Fisher, L. Gunzerath, C. L. Brody, S. Hu, L. A. Sirota, et al. 1999. A genetic association for cigarette smoking behavior. *Health Psychology* 18 (1): 7–13.
35. Vandenberg, D. J., C. J. Bennett, M. D. Grant, A. A. Strasser, R. O'Connor, R. L. Stauffer, G. P. Vogler, and L. T. Kozlowski. 2002. Smoking status and the human dopamine transporter variable number of tandem repeats (VNTR) polymorphism: Failure to replicate and finding that never-smokers may be different. *Nicotine & Tobacco Research* 4 (3): 333–40.
36. Lerman, C., C. J. Jepsen, E. P. Wileyto, L. H. Epstein, M. Rukstalis, F. Patterson, V. Kaufmann, et al. 2006. Role of functional genetic variation in the dopamine D2 receptor (DRD2) in response to bupropion and nicotine replacement therapy for tobacco dependence: Results of two randomized clinical trials. *Neuropsychopharmacology* 31 (1): 231–42.
37. David, S. P., M. R. Munafó, M. F. Murphy, M. Proctor, R. T. Walton, and E. C. Johnstone. 2007. Genetic variation in the dopamine D4 receptor (DRD4) gene and smoking cessation: Follow-up of a randomised clinical trial of transdermal nicotine patch. *Pharmacogenomics Journal* 8 (2): 122–28.
38. Shields, P. G., C. Lerman, J. Audrain, E. D. Bowman, D. Main, N. R. Boyd, and N. E. Caporaso. 1998. Dopamine D4 receptors and the risk of cigarette smoking in African-Americans and Caucasians. *Cancer Epidemiology, Biomarkers & Prevention* 7 (6): 453–58.

39. Colilla, S., C. Lerman, P. G. Shields, C. Jepson, M. Rukstalis, J. Berlin, A. DeMichele, G. Bunin, B. L. Strom, and T. R. Rebbeck. 2005. Association of catechol-O-methyltransferase with smoking cessation in two independent studies of women. *Pharmacogenetics and Genomics* 15 (6): 393–98.
40. Lerman, C., E. P. Wileyto, F. Patterson, M. Rukstalis, J. Audrain-McGovern, S. Restine, P. G. Shields, et al. 2004. The functional mu opioid receptor (OPRM1) Asn40Asp variant predicts short-term response to nicotine replacement therapy in a clinical trial. *Pharmacogenomics Journal* 4 (3): 184–92.
41. Munafó, M. R., K. M. Elliot, M. F. Murphy, R. T. Walton, and E. C. Johnstone. 2007. Association of the mu-opioid receptor gene with smoking cessation. *Pharmacogenomics Journal* 7 (5): 356–61.
42. Zhang, L., K. S. Kendler, and X. Chen. 2006. The mu-opioid receptor gene and smoking initiation and nicotine dependence. *Behavioral and Brain Functions* 2:28.
43. Lerman, C., P. G. Shields, J. Audrain, D. Main, B. Cobb, N. R. Boyd, and N. Caporaso. 1998. The role of the serotonin transporter gene in cigarette smoking. *Cancer Epidemiology, Biomarkers & Prevention* 7 (3): 253–55.
44. Munafó, M. R., E. C. Johnstone, E. P. Wileyto, P. G. Shields, K. M. Elliot, and C. Lerman. 2006. Lack of association of 5-HTTLPR genotype with smoking cessation in a nicotine replacement therapy randomized trial. *Cancer Epidemiology, Biomarkers & Prevention* 15 (2): 398–400.
45. Bierut, L. J., P. A. Madden, N. Breslau, E. O. Johnson, D. Hatsukami, O. F. Pomerleau, G. E. Swan, et al. 2007. Novel genes identified in a high-density genome wide association study for nicotine dependence. *Human Molecular Genetics* 16 (1): 24–35.
46. Gelernter, J., C. Panhuysen, R. Weiss, K. Brady, J. Poling, M. Krauthammer, L. Farrer, and H. R. Kranzler. 2007. Genomewide linkage scan for nicotine dependence: Identification of a chromosome 5 risk locus. *Biological Psychiatry* 61 (1): 119–26.
47. Li, M. D., D. Sun, X. Y. Lou, J. Beuten, T. J. Payne, and J. Z. Ma. 2007. Linkage and association studies in African- and Caucasian-American populations demonstrate that SHC3 is a novel susceptibility locus for nicotine dependence. *Molecular Psychiatry* 12 (5): 462–73.
48. Swan, G. E., H. Hops, K. C. Wilhelmson, C. N. Lessov-Schlaggar, L. S. Cheng, K. S. Hudmon, C. I. Amos, et al. 2006. A genome-wide screen for nicotine dependence susceptibility loci. *American Journal of Medical Genetics Part B, Neuropsychiatric Genetics* 141 (4): 354–60.
49. Uhl, G. R., Q. R. Liu, T. Drgon, C. Johnson, D. Walther, and J. E. Rose. 2007. Molecular genetics of nicotine dependence and abstinence: Whole genome association using 520,000 SNPs. *BMC Genetics* 8:10.
50. Lerman, C., and G. E. Swan. 2002. Non-replication of genetic association studies: Is DAT all, folks? *Nicotine & Tobacco Research* 4 (3): 247–9.
51. Munafó, M. R., A. E. Shields, W. H. Berrettini, F. Patterson, and C. Lerman. 2005. Pharmacogenetics and nicotine addiction treatment. *Pharmacogenomics* 6 (3): 211–23.
52. Flint, J., and M. R. Munafó. 2007. The endophenotype concept in psychiatric genetics. *Psychological Medicine* 37 (2): 163–80.
53. Everitt, B. J., and T. W. Robbins. 2005. Neural systems of reinforcement for drug addiction: From actions to habits to compulsion. *Nature Neuroscience* 8 (11): 1481–89.
54. Di Chiara, G., V. Bassareo, S. Fenu, M. A. De Luca, L. Spina, C. Cadoni, E. Acquas, E. Carboni, V. Valentini, and D. Lecca. 2004. Dopamine and drug addiction: The nucleus accumbens shell connection. *Neuropharmacology* 47 Suppl. 1: 227–41.
55. Hyman, S. E., R. C. Malenka, and E. J. Nestler. 2006. Neural mechanisms of addiction: The role of reward-related learning and memory. *Annual Review of Neuroscience* 29:565–98.
56. Koob, G. F., and M. Le Moal. 2001. Drug addiction, dysregulation of reward, and allostasis. *Neuropsychopharmacology* 24 (2): 97–129.
57. Kalivas, P. W., and N. D. Volkow. 2005. The neural basis of addiction: A pathology of motivation and choice. *American Journal of Psychiatry* 162 (8): 1403–13.
58. Koob, G. F. 2003. Neuroadaptive mechanisms of addiction: Studies on

- the extended amygdala. *European Neuropsychopharmacology* 13 (6): 442–52.
59. Wise, R. A. 2004. Dopamine, learning and motivation. *Nature Reviews Neuroscience* 5 (6): 483–94.
60. Blaha, C. D., L. F. Allen, S. Das, W. L. Inglis, M. P. Latimer, S. R. Vincent, and P. Winn. 1996. Modulation of dopamine efflux in the nucleus accumbens after cholinergic stimulation of the ventral tegmental area in intact, pedunculopontine tegmental nucleus-lesioned, and laterodorsal tegmental nucleus-lesioned rats. *Journal of Neuroscience* 16 (2): 714–22.
61. Fisher, J. L., V. I. Pidoplichko, and J. A. Dani. 1998. Nicotine modifies the activity of ventral tegmental area dopaminergic neurons and hippocampal GABAergic neurons. *Journal of Physiology, Paris* 92 (3–4): 209–13.
62. Nisell, M., G. G. Nomikos, and T. H. Svensson. 1994. Systemic nicotine-induced dopamine release in the rat nucleus accumbens is regulated by nicotinic receptors in the ventral tegmental area. *Synapse* 16 (1): 36–44.
63. Rahman, S., J. Zhang, and W. A. Corrigall. 2003. Effects of acute and chronic nicotine on somatodendritic dopamine release of the rat ventral tegmental area: In vivo microdialysis study. *Neuroscience Letters* 348 (2): 61–64.
64. Schultz, W. 2002. Getting formal with dopamine and reward. *Neuron* 36 (2): 241–63.
65. Rice, M. E., and S. J. Cragg. 2004. Nicotine amplifies reward-related dopamine signals in striatum. *Nature Neuroscience* 7 (6): 583–84.
66. Zhang, H., and D. Sulzer. 2004. Frequency-dependent modulation of dopamine release by nicotine. *Nature Neuroscience* 7 (6): 581–82.
67. Chiamulera, C., C. Borgo, S. Falchetto, E. Valerio, and M. Tessari. 1996. Nicotine reinstatement of nicotine self-administration after long-term extinction. *Psychopharmacology (Berl)* 127 (2): 102–7.
68. Corrigall, W. A., and K. M. Coen. 1989. Nicotine maintains robust self-administration in rats on a limited-access schedule. *Psychopharmacology (Berl)* 99 (4): 473–78.
69. Cox, B. M., A. Goldstein, and W. T. Nelson. 1984. Nicotine self-administration in rats. *British Journal of Pharmacology* 83 (1): 49–55.
70. Donny, E. C., A. R. Caggiula, S. Knopf, and C. Brown. 1995. Nicotine self-administration in rats. *Psychopharmacology (Berl)* 122 (4): 390–94.
71. Donny, E. C., A. R. Caggiula, M. M. Mielke, K. S. Jacobs, C. Rose, and A. F. Sved. 1998. Acquisition of nicotine self-administration in rats: The effects of dose, feeding schedule, and drug contingency. *Psychopharmacology (Berl)* 136 (1): 83–90.
72. Liu, X., A. R. Caggiula, S. K. Yee, H. Nobuta, R. E. Poland, and R. N. Pechnick. 2006. Reinstatement of nicotine-seeking behavior by drug-associated stimuli after extinction in rats. *Psychopharmacology (Berl)* 184 (3–4): 417–25.
73. Martellotta, M. C., A. Kuzmin, E. Zvartau, G. Cossu, G. L. Gessa, and W. Fratta. 1995. Isradipine inhibits nicotine intravenous self-administration in drug-naive mice. *Pharmacology, Biochemistry, and Behavior* 52 (2): 271–74.
74. Shaham, Y., L. K. Adamson, S. Grocki, and W. A. Corrigall. 1997. Reinstatement and spontaneous recovery of nicotine seeking in rats. *Psychopharmacology (Berl)* 130 (4): 396–403.
75. Stolerman, I. P., C. Naylor, G. I. Elmer, and S. R. Goldberg. 1999. Discrimination and self-administration of nicotine by inbred strains of mice. *Psychopharmacology (Berl)* 141 (3): 297–306.
76. Valentine, J. D., J. S. Hokanson, S. G. Matta, and B. M. Sharp. 1997. Self-administration in rats allowed unlimited access to nicotine. *Psychopharmacology (Berl)* 133 (3): 300–4.
77. Clark, M. S. 1969. Self-administered nicotine solutions preferred to placebo by the rat. *British Journal of Pharmacology* 35 (2): 367P.
78. Caggiula, A. R., E. C. Donny, A. R. White, N. Chaudhri, S. Booth, M. A. Gharib, A. Hoffman, K. A. Perkins, and A. F. Sved. 2001. Cue dependency of nicotine self-administration and smoking. *Pharmacology, Biochemistry, and Behavior* 70 (4): 515–30.
79. Ikemoto, S., M. Qin, and Z. H. Liu. 2006. Primary reinforcing effects of nicotine are triggered from multiple regions both inside and outside the ventral tegmental area. *Journal of Neuroscience* 26 (3): 723–30.
80. Corrigall, W. A., and K. M. Coen. 1991. Selective dopamine antagonists

- reduce nicotine self-administration. *Psychopharmacology (Berl)* 104 (2): 171–76.
81. Corrigan, W. A., K. B. Franklin, K. M. Coen, and P. B. Clarke. 1992. The mesolimbic dopaminergic system is implicated in the reinforcing effects of nicotine. *Psychopharmacology (Berl)* 107 (2–3): 285–89.
 82. Grottick, A. J., G. Trube, W. A. Corrigan, J. Huwyler, P. Malherbe, R. Wyler, and G. A. Higgins. 2000. Evidence that nicotinic alpha(7) receptors are not involved in the hyperlocomotor and rewarding effects of nicotine. *Journal of Pharmacology and Experimental Therapeutics* 294 (3): 1112–9.
 83. Corrigan, W. A., K. M. Coen, and K. L. Adamson. 1994. Self-administered nicotine activates the mesolimbic dopamine system through the ventral tegmental area. *Brain Research* 653 (1–2): 278–84.
 84. Epping-Jordan, M. P., M. R. Picciotto, J. P. Changeux, and E. M. Pich. 1999. Assessment of nicotinic acetylcholine receptor subunit contributions to nicotine self-administration in mutant mice. *Psychopharmacology (Berl)* 147 (1): 25–26.
 85. Picciotto, M. R., M. Zoli, R. Rimondini, C. Lena, L. M. Marubio, E. M. Pich, K. Fuxe, and J. P. Changeux. 1998. Acetylcholine receptors containing the beta2 subunit are involved in the reinforcing properties of nicotine. *Nature* 391 (6663): 173–77.
 86. Shoaib, M., C. W. Schindler, and S. R. Goldberg. 1997. Nicotine self-administration in rats: Strain and nicotine pre-exposure effects on acquisition. *Psychopharmacology (Berl)* 129 (1): 35–43.
 87. Le, A. D., Z. Li, D. Funk, M. Shram, T. K. Li, and Y. Shaham. 2006. Increased vulnerability to nicotine self-administration and relapse in alcohol-naïve offspring of rats selectively bred for high alcohol intake. *Journal of Neuroscience* 26 (6): 1872–9.
 88. de Fiebre, C. M., and A. C. Collins. 1993. A comparison of the development of tolerance to ethanol and cross-tolerance to nicotine after chronic ethanol treatment in long- and short-sleep mice. *Journal of Pharmacology and Experimental Therapeutics* 266 (3): 1398–406.
 89. De Fiebre, C. M., L. J. Medhurst, and A. C. Collins. 1987. Nicotine response and nicotinic receptors in long-sleep and short-sleep mice. *Alcohol* 4 (6): 493–501.
 90. de Fiebre, C. M., M. J. Marks, and A. C. Collins. 1990. Ethanol-nicotine interactions in long-sleep and short-sleep mice. *Alcohol* 7 (3): 249–57.
 91. Meyerhoff, D. J., Y. Tizabi, J. K. Staley, T. C. Durazzo, J. M. Glass, and S. J. Nixon. 2006. Smoking comorbidity in alcoholism: Neurobiological and neurocognitive consequence. *Alcoholism, Clinical and Experimental Research* 30 (2): 253–64.
 92. Adriani, W., S. Macri, R. Pacifici, and G. Laviola. 2002. Restricted daily access to water and voluntary nicotine oral consumption in mice: Methodological issues and individual differences. *Behavioural Brain Research* 134 (1–2): 21–30.
 93. Flynn, F. W., M. Webster, and C. Ksir. 1989. Chronic voluntary nicotine drinking enhances nicotine palatability in rats. *Behavioral Neuroscience* 103 (2): 356–64.
 94. Glick, S. D., K. E. Visker, and I. M. Maisonneuve. 1996. An oral self-administration model of nicotine preference in rats: Effects of mecamylamine. *Psychopharmacology (Berl)* 128 (4): 426–31.
 95. Lang, W. J., A. A. Latiff, A. McQueen, and G. Singer. 1977. Self administration of nicotine with and without a food delivery schedule. *Pharmacology, Biochemistry, and Behavior* 7 (1): 65–70.
 96. Smith, A., and D. C. Roberts. 1995. Oral self-administration of sweetened nicotine solutions by rats. *Psychopharmacology (Berl)* 120 (3): 341–46.
 97. Matta, S. G., D. J. Balfour, N. L. Benowitz, R. T. Boyd, J. J. Buccafusco, A. R. Caggiula, C. R. Craig, et al. 2007. Guidelines on nicotine dose selection for in vivo research. *Psychopharmacology (Berl)* 190 (3): 269–319.
 98. Meliska, C. J., A. Bartke, G. McGlacken, and R. A. Jensen. 1995. Ethanol, nicotine, amphetamine, and aspartame consumption and preferences in C57BL/6 and DBA/2 mice. *Pharmacology, Biochemistry, and Behavior* 50 (4): 619–26.
 99. Robinson, S. F., M. J. Marks, and A. C. Collins. 1996. Inbred mouse strains vary in oral self-selection of nicotine. *Psychopharmacology (Berl)* 124 (4): 332–39.
 100. Aschhoff, S., K.-C. Schroff, D. B. Wildenauer, and E. Richter. 2000. Nicotine consumption of several mouse strains using a two bottle choice paradigm. *Journal of Experimental Animal Science* 40 (4): 171–77.

101. Stitzel, J. A., M. Jimenez, M. J. Marks, T. Tritto, and A. C. Collins. 2000. Potential role of the alpha4 and alpha6 nicotinic receptor subunits in regulating nicotine-induced seizures. *Journal of Pharmacology and Experimental Therapeutics* 293 (1): 67–74.
102. Dobelis, P., M. J. Marks, P. Whiteaker, S. A. Balogh, A. C. Collins, and J. A. Stitzel. 2002. A polymorphism in the mouse neuronal alpha4 nicotinic receptor subunit results in an alteration in receptor function. *Molecular Pharmacology* 62 (2): 334–42.
103. Tritto, T., R. J. Marley, D. Bastidas, J. A. Stitzel, and A. C. Collins. 2001. Potential regulation of nicotine and ethanol actions by alpha4-containing nicotinic receptors. *Alcohol* 24 (2): 69–78.
104. Butt, C. M., N. M. King, S. R. Hutton, A. C. Collins, and J. A. Stitzel. 2005. Modulation of nicotine but not ethanol preference by the mouse *Chrna4* A529T polymorphism. *Behavioral Neuroscience* 119 (1): 26–37.
105. Siu, E. C., D. B. Wildenauer, and R. F. Tyndale. 2006. Nicotine self-administration in mice is associated with rates of nicotine inactivation by CYP2A5. *Psychopharmacology (Berl)* 184 (3–4): 401–8.
106. Rao, Y., E. Hoffmann, M. Zia, L. Bodin, M. Zeman, E. M. Sellers, and R. F. Tyndale. 2000. Duplications and defects in the CYP2A6 gene: Identification, genotyping, and in vivo effects on smoking. *Molecular Pharmacology* 58 (4): 747–55.
107. Chaudhri, N., A. R. Caggiula, E. C. Donny, M. I. Palmatier, X. Liu, and A. F. Sved. 2006. Complex interactions between nicotine and nonpharmacological stimuli reveal multiple roles for nicotine in reinforcement. *Psychopharmacology (Berl)* 184 (3–4): 353–66.
108. Barr, R. S., D. A. Pizzagalli, M. A. Culhane, D. C. Goff, and A. E. Evins. 2008. A single dose of nicotine enhances reward responsiveness in nonsmokers: Implications for development of dependence. *Biological Psychiatry* 63 (11): 1061–65.
109. Perkins, K. A., C. Fonte, and J. E. Grobe. 2000. Sex differences in the acute effects of cigarette smoking on the reinforcing value of alcohol. *Behavioral Pharmacology* 11 (1): 63–70.
110. Killen, J. D., S. P. Fortmann, M. J. Telch, and B. Newman. 1988. Are heavy smokers different from light smokers? A comparison after 48 hours without cigarettes. *JAMA: The Journal of the American Medical Association* 260 (11): 1581–85.
111. Owen, N., P. Kent, M. Wakefield, and L. Roberts. 1995. Low-rate smokers. *Preventive Medicine* 24 (1): 80–84.
112. Hymowitz, N., K. M. Cummings, A. Hyland, W. R. Lynn, T. F. Pechacek, and T. D. Hartwell. 1997. Predictors of smoking cessation in a cohort of adult smokers followed for five years. *Tobacco Control* 6 Suppl. 2: S57–S62.
113. Ockene, J. K., K. M. Emmons, R. J. Mermelstein, K. A. Perkins, D. S. Bonollo, C. C. Voorhees, and J. F. Hollis. 2000. Relapse and maintenance issues for smoking cessation. *Health Psychology* 19 Suppl. 1: 17–31.
114. Shiffman, S., M. Hickcox, J. A. Paty, M. Gnys, J. D. Kassel, and T. J. Richards. 1996. Progression from a smoking lapse to relapse: Prediction from abstinence violation effects, nicotine dependence, and lapse characteristics. *Journal of Consulting and Clinical Psychology* 64 (5): 993–1002.
115. Garvey, A. J., T. Kinnunen, B. L. Nordstrom, C. H. Utman, K. Doherty, B. Rosner, and P. S. Vokonas. 2000. Effects of nicotine gum dose by level of nicotine dependence. *Nicotine & Tobacco Research* 2 (1): 53–63.
116. Westman, E. C., F. M. Behm, D. L. Simel, and J. E. Rose. 1997. Smoking behavior on the first day of a quit attempt predicts long-term abstinence. *Archives of Internal Medicine* 157 (3): 335–40.
117. Kenford, S. L., M. C. Fiore, D. E. Jorenby, S. S. Smith, D. Wetter, and T. B. Baker. 1994. Predicting smoking cessation. Who will quit with and without the nicotine patch. *JAMA: The Journal of the American Medical Association* 271 (8): 589–94.
118. Perkins, K. A., M. D. Marcus, M. D. Levine, D. D'Amico, A. Miller, M. Broge, J. Ashcom, and S. Shiffman. 2001. Cognitive-behavioral therapy to reduce weight concerns improves smoking cessation outcome in weight-concerned women. *Journal of Consulting and Clinical Psychology* 69 (4): 604–13.
119. Shiffman, S., S. G. Ferguson, and C. J. Gwaltney. 2006. Immediate hedonic response to smoking lapses: Relationship to smoking relapse, and effects of nicotine replacement therapy. *Psychopharmacology (Berl)* 184 (3–4): 608–18.

120. O'Brien, C. P., and E. L. Gardner. 2005. Critical assessment of how to study addiction and its treatment: Human and non-human animal models. *Pharmacology & Therapeutics* 108 (1): 18–58.
121. Lee, E. M., J. L. Malson, A. J. Waters, E. T. Moolchan, and W. B. Pickworth. 2003. Smoking topography: Reliability and validity in dependent smokers. *Nicotine & Tobacco Research* 5 (5): 673–79.
122. Perkins, K. A., J. E. Grobe, A. Caggiula, A. S. Wilson, and R. L. Stiller. 1997. Acute reinforcing effects of low-dose nicotine nasal spray in humans. *Pharmacology, Biochemistry, and Behavior* 56 (2): 235–41.
123. Plowshare Technologies. 2008. Clinical research support system. <http://www.plowshare.com> (accessed December 22, 2008).
124. Strasser, A. A., W. B. Pickworth, F. Patterson, and C. Lerman. 2004. Smoking topography predicts abstinence following treatment with nicotine replacement therapy. *Cancer Epidemiology, Biomarkers & Prevention* 13 (11 Pt. 1): 1800–1804.
125. Harvey, D. M., S. Yasar, S. J. Heishman, L. V. Panlilio, J. E. Henningfield, and S. R. Goldberg. 2004. Nicotine serves as an effective reinforcer of intravenous drug-taking behavior in human cigarette smokers. *Psychopharmacology (Berl)* 175 (2): 134–42.
126. Hughes, J. R., R. W. Pickens, W. Spring, and R. M. Keenan. 1985. Instructions control whether nicotine will serve as a reinforcer. *Journal of Pharmacology and Experimental Therapeutics* 235 (1): 106–12.
127. Perkins, K. A., J. E. Grobe, D. Weiss, C. Fonte, and A. Caggiula. 1996. Nicotine preference in smokers as a function of smoking abstinence. *Pharmacology, Biochemistry, and Behavior* 55 (2): 257–63.
128. Perkins, K. A., D. Gerlach, M. Broge, C. Fonte, and A. Wilson. 2001. Reinforcing effects of nicotine as a function of smoking status. *Experimental and Clinical Psychopharmacology* 9 (3): 243–50.
129. Bickel, W. K., R. J. DeGrandpre, and S. T. Higgins. 1995. The behavioral economics of concurrent drug reinforcers: A review and reanalysis of drug self-administration research. *Psychopharmacology (Berl)* 118 (3): 250–59.
130. Johnson, M. W., and W. K. Bickel. 2003. The behavioral economics of cigarette smoking: The concurrent presence of a substitute and an independent reinforcer. *Behavioural Pharmacology* 14 (2): 137–44.
131. Perkins, K. A., M. Hickox, and J. E. Grobe. 2000. Behavioral economics of smoking. In *Reframing health behavior change with behavioral economics*, ed. W. Bickel and R. Vuchinich, 296–92. Mahwah, NJ: Lawrence Erlbaum.
132. Bickel, W. K., and G. J. Madden. 1999. A comparison of measures of relative reinforcing efficacy and behavioral economics: Cigarettes and money in smokers. *Behavioural Pharmacology* 10 (6–7): 627–37.
133. Strasser, A. A., V. Malaiyandi, E. Hoffmann, R. F. Tyndale, and C. Lerman. 2007. An association of CYP2A6 genotype and smoking topography. *Nicotine & Tobacco Research* 9 (4): 511–18.
134. Ray, R., C. Jepson, F. Patterson, A. Strasser, M. Rukstalis, K. Perkins, K. G. Lynch, S. O'Malley, W. H. Berrettini, and C. Lerman. 2006. Association of OPRM1 A118G variant with the relative reinforcing value of nicotine. *Psychopharmacology (Berl)* 188 (3): 355–63.
135. Walters, C. L., J. N. Cleck, Y. C. Kuo, and J. A. Blendy. 2005. Mu-opioid receptor and CREB activation are required for nicotine reward. *Neuron* 46 (6): 933–43.
136. Ray, R., C. Jepson, P. Wileyto, F. Patterson, A. A. Strasser, M. Rukstalis, K. Perkins, J. Blendy, and C. Lerman. 2007. CREB1 haplotypes and the relative reinforcing value of nicotine. *Molecular Psychiatry* 12 (7): 615–17.
137. Perkins, K. A., C. Lerman, A. M. Grottenthaler, M. M. Ciccocioppo, M. Milanak, C. A. Conklin, A. W. Bergen, and N. L. Benowitz. 2008. Dopamine and opioid gene variants are associated with increased smoking reward and reinforcement owing to negative mood. *Behavioural Pharmacology* 19 (5–6): 641–49.
138. Mackillop, J., D. P. Menges, J. E. McGeary, and S. A. Lisman. 2007. Effects of craving and DRD4 VNTR genotype on the relative value of alcohol: An initial human laboratory study. *Behavioral and Brain Functions* 3:11.
139. Perkins, K. A., J. E. Grobe, R. L. Stiller, C. Fonte, and J. E. Goettler. 1992. Nasal spray nicotine replacement suppresses cigarette smoking desire and behavior. *Clinical Pharmacology and Therapeutics* 52 (6): 627–34.

140. Benowitz, N. L., S. Zevin, and P. Jacob 3rd. 1998. Suppression of nicotine intake during ad libitum cigarette smoking by high-dose transdermal nicotine. *Journal of Pharmacology and Experimental Therapeutics* 287 (3): 958–62.
141. Perkins, K. A., M. Stitzer, and C. Lerman. 2006. Medication screening for smoking cessation: A proposal for new methodologies. *Psychopharmacology (Berl)* 184 (3–4): 628–36.
142. Hughes, J. R., G. L. Rose, and P. W. Callas. 2000. Do former smokers respond to nicotine differently from never smokers? A pilot study. *Nicotine & Tobacco Research* 2 (3): 255–62.
143. Hughes, J. R., G. L. Rose, and P. W. Callas. 2000. Nicotine is more reinforcing in smokers with a past history of alcoholism than in smokers without this history. *Alcoholism, Clinical and Experimental Research* 24 (11): 1633–38.
144. Rose, J. E., M. E. Jarvik, and S. Ananda. 1984. Nicotine preference increases after cigarette deprivation. *Pharmacology, Biochemistry, and Behavior* 20 (1): 55–8.
145. Perkins, K. A., M. Broge, D. Gerlach, M. Sanders, J. E. Grobe, C. Cherry, and A. S. Wilson. 2002. Acute nicotine reinforcement, but not chronic tolerance, predicts withdrawal and relapse after quitting smoking. *Health Psychology* 21 (4): 332–39.
146. Madden, G. J., and W. K. Bickel. 1999. Abstinence and price effects on demand for cigarettes: A behavioral-economic analysis. *Addiction* 94 (4): 577–88.
147. Perkins, K. A., L. H. Epstein, J. Grobe, and C. Fonte. 1994. Tobacco abstinence, smoking cues, and the reinforcing value of smoking. *Pharmacology, Biochemistry, and Behavior* 47 (1): 107–12.
148. Rusted, J. M., A. Mackee, R. Williams, and P. Willner. 1998. Deprivation state but not nicotine content of the cigarette affects responding by smokers on a progressive ratio task. *Psychopharmacology (Berl)* 140 (4): 411–17.
149. Perkins, K. A., L. Jacobs, M. Sanders, and A. R. Caggiula. 2002. Sex differences in the subjective and reinforcing effects of cigarette nicotine dose. *Psychopharmacology (Berl)* 163 (2): 194–201.
150. Shahan, T. A., W. K. Bickel, G. J. Madden, and G. J. Badger. 1999. Comparing the reinforcing efficacy of nicotine containing and de-nicotinized cigarettes: A behavioral economic analysis. *Psychopharmacology (Berl)* 147 (2): 210–16.
151. Perkins, K. A., L. Jacobs, L. Clark, C. A. Conklin, M. Sayette, and A. Wilson. 2004. Instructions about nicotine dose influence acute responses to nasal spray. *Nicotine & Tobacco Research* 6 (6): 1051–60.
152. Fudala, P. J., and E. T. Iwamoto. 1986. Further studies on nicotine-induced conditioned place preference in the rat. *Pharmacology, Biochemistry, and Behavior* 25 (5): 1041–49.
153. Fudala, P. J., K. W. Teoh, and E. T. Iwamoto. 1985. Pharmacologic characterization of nicotine-induced conditioned place preference. *Pharmacology, Biochemistry, and Behavior* 22 (2): 237–41.
154. Grabus, S. D., B. R. Martin, S. E. Brown, and M. I. Damaj. 2006. Nicotine place preference in the mouse: Influences of prior handling, dose and strain and attenuation by nicotinic receptor antagonists. *Psychopharmacology (Berl)* 184 (3–4): 456–63.
155. Le Foll, B., and S. R. Goldberg. 2005. Nicotine induces conditioned place preferences over a large range of doses in rats. *Psychopharmacology (Berl)* 178 (4): 481–92.
156. Risinger, F. O., and R. A. Oakes. 1995. Nicotine-induced conditioned place preference and conditioned place aversion in mice. *Pharmacology, Biochemistry, and Behavior* 51 (2–3): 457–61.
157. Shoaib, M., I. P. Stolerman, and R. C. Kumar. 1994. Nicotine-induced place preferences following prior nicotine exposure in rats. *Psychopharmacology (Berl)* 113 (3–4): 445–52.
158. Kenny, P. J. 2007. Brain reward systems and compulsive drug use. *Trends in Pharmacological Sciences* 28 (3): 135–41.
159. Panagis, G., A. Kastellakis, C. Spyraiki, and G. Nomikos. 2000. Effects of methyllycaconitine (MLA), an alpha 7 nicotinic receptor antagonist, on nicotine- and cocaine-induced potentiation of brain stimulation reward. *Psychopharmacology (Berl)* 149 (4): 388–96.
160. Kenny, P. J., and A. Markou. 2005. Conditioned nicotine withdrawal profoundly decreases the activity of brain reward systems. *Journal of Neuroscience* 25 (26): 6208–12.

161. Walters, C. L., S. Brown, J. P. Changeux, B. Martin, and M. I. Damaj. 2006. The beta2 but not alpha7 subunit of the nicotinic acetylcholine receptor is required for nicotine-conditioned place preference in mice. *Psychopharmacology (Berl)* 184 (3–4): 339–44.
162. Mameli-Engvall, M., A. Evrard, S. Pons, U. Maskos, T. H. Svensson, J. P. Changeux, and P. Faure. 2006. Hierarchical control of dopamine neuron-firing patterns by nicotinic receptors. *Neuron* 50 (6): 911–21.
163. Maskos, U., B. E. Molles, S. Pons, M. Besson, B. P. Guiard, J. P. Guilloux, A. Evrard, et al. 2005. Nicotine reinforcement and cognition restored by targeted expression of nicotinic receptors. *Nature* 436 (7047): 103–7.
164. Tapper, A. R., S. L. McKinney, R. Nashmi, J. Schwarz, P. Deshpande, C. Labarca, P. Whiteaker, M. J. Marks, A. C. Collins, and H. A. Lester. 2004. Nicotine activation of alpha4* receptors: Sufficient for reward, tolerance, and sensitization. *Science* 306 (5698): 1029–32.
165. Castane, A., E. Valjent, C. Ledent, M. Parmentier, R. Maldonado, and O. Valverde. 2002. Lack of CB1 cannabinoid receptors modifies nicotine behavioural responses, but not nicotine abstinence. *Neuropharmacology* 43 (5): 857–67.
166. Cossu, G., C. Ledent, L. Fattore, A. Imperato, G. A. Bohme, M. Parmentier, and W. Fratta. 2001. Cannabinoid CB1 receptor knockout mice fail to self-administer morphine but not other drugs of abuse. *Behavioural Brain Research* 118 (1): 61–65.
167. Berrendero, F., V. Mendizabal, P. Robledo, L. Galeote, A. Bilkei-Gorzo, A. Zimmer, and R. Maldonado. 2005. Nicotine-induced antinociception, rewarding effects, and physical dependence are decreased in mice lacking the preproenkephalin gene. *Journal of Neuroscience* 25 (5): 1103–12.
168. Berrendero, F., B. L. Kieffer, and R. Maldonado. 2002. Attenuation of nicotine-induced antinociception, rewarding effects, and dependence in mu-opioid receptor knock-out mice. *Journal of Neuroscience* 22 (24): 10935–40.
169. Schechter, M. D., S. M. Meehan, and J. B. Schechter. 1995. Genetic selection for nicotine activity in mice correlates with conditioned place preference. *European Journal of Pharmacology* 279 (1): 59–64.
170. Horan, B., M. Smith, E. L. Gardner, M. Lepore, and C. R. Ashby Jr. 1997. (-)-Nicotine produces conditioned place preference in Lewis, but not Fischer 344 rats. *Synapse* 26 (1): 93–94.
171. Philibin, S. D., R. E. Vann, S. A. Varvel, H. E. Covington 3rd, J. A. Rosecrans, J. R. James, and S. E. Robinson. 2005. Differential behavioral responses to nicotine in Lewis and Fischer-344 rats. *Pharmacology, Biochemistry, and Behavior* 80 (1): 87–92.
172. Rose, J. E., E. C. Westman, F. M. Behm, M. P. Johnson, and J. S. Goldberg. 1999. Blockade of smoking satisfaction using the peripheral nicotinic antagonist trimethaphan. *Pharmacology, Biochemistry, and Behavior* 62 (1): 165–72.
173. Kaufmann, V., C. Jepson, M. Rukstalis, K. Perkins, J. Audrain-McGovern, and C. Lerman. 2004. Subjective effects of an initial dose of nicotine nasal spray predict treatment outcome. *Psychopharmacology (Berl)* 172 (3): 271–76.
174. Perkins, K. A., D. Gerlach, M. Broge, J. E. Grobe, M. Sanders, C. Fonte, J. Vender, C. Cherry, and A. Wilson. 2001. Dissociation of nicotine tolerance from tobacco dependence in humans. *Journal of Pharmacology and Experimental Therapeutics* 296 (3): 849–56.
175. Hughes, J. R. 2007. Measurement of the effects of abstinence from tobacco: A qualitative review. *Psychology of Addictive Behaviors* 21 (2): 127–37.
176. Perkins, K. A. 2002. Chronic tolerance to nicotine in humans and its relationship to tobacco dependence. *Nicotine & Tobacco Research* 4 (4): 405–22.
177. Heishman, S. J., R. C. Taylor, and J. E. Henningfield. 1994. Nicotine and smoking: A review of effects on human performance. *Experimental and Clinical Psychopharmacology* 2 (4): 345–95.
178. Perkins, K. A. 1999. Baseline-dependency of nicotine effects: A review. *Behavioural Pharmacology* 10 (6–7): 597–615.
179. Tiffany, S. T., and D. J. Drobes. 1990. Imagery and smoking urges: The manipulation of affective content. *Addictive Behaviors* 15 (6): 531–39.
180. Riekkinen, P. Jr., M. Riekkinen, and J. Sirvio. 1993. Effects of nicotine on neocortical electrical activity in rats. *Journal of Pharmacology and Experimental Therapeutics* 267 (2): 776–84.
181. Domino, E. F. 2003. Effects of tobacco smoking on electroencephalographic,

- auditory evoked and event related potentials. *Brain and Cognition* 53 (1): 66–74.
182. Herning, R. I., R. T. Jones, and J. Bachman. 1983. EEG changes during tobacco withdrawal. *Psychophysiology* 20 (5): 507–12.
183. Pickworth, W. B., R. V. Fant, M. F. Butschky, and J. E. Henningfield. 1996. Effects of transdermal nicotine delivery on measures of acute nicotine withdrawal. *Journal of Pharmacology and Experimental Therapeutics* 279 (2): 450–56.
184. Pickworth, W. B., R. I. Herning, and J. E. Henningfield. 1989. Spontaneous EEG changes during tobacco abstinence and nicotine substitution in human volunteers. *Journal of Pharmacology and Experimental Therapeutics* 251 (3): 976–82.
185. Teneggi, V., L. Squassante, S. Milleri, A. Polo, P. Lanteri, L. Ziviani, and A. Bye. 2004. EEG power spectra and auditory P300 during free smoking and enforced smoking abstinence. *Pharmacology, Biochemistry, and Behavior* 77 (1): 103–9.
186. Pickworth, W. B., R. I. Herning, and J. E. Henningfield. 1986. Electroencephalographic effects of nicotine chewing gum in humans. *Pharmacology, Biochemistry, and Behavior* 25 (4): 879–82.
187. Pickworth, W. B., R. V. Fant, M. F. Butschky, and J. E. Henningfield. 1997. Effects of mecamylamine on spontaneous EEG and performance in smokers and non-smokers. *Pharmacology, Biochemistry, and Behavior* 56 (2): 181–87.
188. Pickworth, W. B., E. D. O'Hare, R. V. Fant, and E. T. Moolchan. 2003. EEG effects of conventional and denicotinized cigarettes in a spaced smoking paradigm. *Brain and Cognition* 53 (1): 75–81.
189. Luck, S. J. 2005. *An introduction to the event-related potential technique*. Cambridge, MA: MIT Press.
190. Pollock, V. E., L. S. Schneider, and S. A. Lyness. 1991. Reliability of topographic quantitative EEG amplitude in healthy late-middle-aged and elderly subjects. *Electroencephalography and Clinical Neurophysiology* 79 (1): 20–26.
191. Salinsky, M. C., B. S. Oken, and L. Morehead. 1991. Test-retest reliability in EEG frequency analysis. *Electroencephalography and Clinical Neurophysiology* 79 (5): 382–92.
192. Van Baal, G. C., E. J. De Geus, and D. I. Boomsma. 1996. Genetic architecture of EEG power spectra in early life. *Electroencephalography and Clinical Neurophysiology* 98 (6): 502–14.
193. van Beijsterveldt, C. E., P. C. Molenaar, E. J. de Geus, and D. I. Boomsma. 1996. Heritability of human brain functioning as assessed by electroencephalography. *American Journal of Human Genetics* 58 (3): 562–73.
194. Smit, D. J., D. Posthuma, D. I. Boomsma, and E. J. Geus. 2005. Heritability of background EEG across the power spectrum. *Psychophysiology* 42 (6): 691–97.
195. van Beijsterveldt, C. E., and G. C. van Baal. 2002. Twin and family studies of the human electroencephalogram: A review and a meta-analysis. *Biological Psychology* 61 (1–2): 111–38.
196. Gilbert, D., J. McClernon, N. Rabinovich, C. Sugai, L. Plath, G. Asgaard, Y. Zuo, J. Huggenvik, and N. Botros. 2004. Effects of quitting smoking on EEG activation and attention last for more than 31 days and are more severe with stress, dependence, DRD2 A1 allele, and depressive traits. *Nicotine & Tobacco Research* 6 (2): 249–67.
197. Thompson, J., N. Thomas, A. Singleton, M. Piggott, S. Lloyd, E. K. Perry, C. M. Morris, R. H. Perry, I. N. Ferrier, and J. A. Court. 1997. D2 dopamine receptor gene (DRD2) Taq1 A polymorphism: Reduced dopamine D2 receptor binding in the human striatum associated with the A1 allele. *Pharmacogenetics* 7 (6): 479–84.
198. Porjesz, B., H. Begleiter, K. Wang, L. Almasy, D. B. Chorlian, A. T. Stimus, S. Kuperman, et al. 2002. Linkage and linkage disequilibrium mapping of ERP and EEG phenotypes. *Biological Psychology* 61 (1–2): 229–48.
199. Rangaswamy, M., B. Porjesz, D. B. Chorlian, K. Choi, K. A. Jones, K. Wang, J. Rohrbaugh, et al. 2003. Theta power in the EEG of alcoholics. *Alcoholism, Clinical and Experimental Research* 27 (4): 607–15.
200. Rangaswamy, M., B. Porjesz, D. B. Chorlian, K. Wang, K. A. Jones, L. O. Bauer, J. Rohrbaugh, et al. 2002. Beta power in the EEG of alcoholics. *Biological Psychiatry* 52 (8): 831–42.
201. Winterer, G., R. Mählberg, M. N. Smolka, J. Samochowiec, M. Ziller, H. P. Rommelspacher, W. M. Herrmann, L. G. Schmidt, and T. Sander. 2003. Association analysis of exonic variants of the GABA(B)-receptor gene and alpha

- electroencephalogram voltage in normal subjects and alcohol-dependent patients. *Behavior Genetics* 33 (1): 7–15.
202. Pritchard, W., E. Sokhadze, and M. Houlihan. 2004. Effects of nicotine and smoking on event-related potentials: A review. *Nicotine & Tobacco Research* 6 (6): 961–84.
203. Radek, R. J., H. M. Miner, N. A. Bratcher, M. W. Decker, M. Gopalakrishnan, and R. S. Bitner. 2006. Alpha4beta2 nicotinic receptor stimulation contributes to the effects of nicotine in the DBA/2 mouse model of sensory gating. *Psychopharmacology (Berl)* 187 (1): 47–55.
204. Stevens, K. E., and K. D. Wear. 1997. Normalizing effects of nicotine and a novel nicotinic agonist on hippocampal auditory gating in two animal models. *Pharmacology, Biochemistry, and Behavior* 57 (4): 869–74.
205. Metzger, K. L., C. R. Maxwell, Y. Liang, and S. J. Siegel. 2007. Effects of nicotine vary across two auditory evoked potentials in the mouse. *Biological Psychiatry* 61 (1): 23–30.
206. Stevens, K. E., R. Freedman, A. C. Collins, M. Hall, S. Leonard, M. J. Marks, and G. M. Rose. 1996. Genetic correlation of inhibitory gating of hippocampal auditory evoked response and alpha-bungarotoxin-binding nicotinic cholinergic receptors in inbred mouse strains. *Neuropsychopharmacology* 15 (2): 152–62.
207. Siegel, S. J., C. R. Maxwell, S. Majumdar, D. F. Trief, C. Lerman, R. E. Gur, S. J. Kanes, and Y. Liang. 2005. Monoamine reuptake inhibition and nicotine receptor antagonism reduce amplitude and gating of auditory evoked potentials. *Neuroscience* 133 (3): 729–38.
208. Phillips, J. M., R. S. Ehrlichman, and S. J. Siegel. 2007. Mecamylamine blocks nicotine-induced enhancement of the P20 auditory event-related potential and evoked gamma. *Neuroscience* 144 (4): 1314–23.
209. Adler, L. E., E. Pachtman, R. D. Franks, M. Pecevic, M. C. Waldo, and R. Freedman. 1982. Neurophysiological evidence for a defect in neuronal mechanisms involved in sensory gating in schizophrenia. *Biological Psychiatry* 17 (6): 639–54.
210. Freedman, R., L. E. Adler, M. C. Waldo, E. Pachtman, and R. D. Franks. 1983. Neurophysiological evidence for a defect in inhibitory pathways in schizophrenia: Comparison of medicated and drug-free patients. *Biological Psychiatry* 18 (5): 537–51.
211. Lohr, J. B., and K. Flynn. 1992. Smoking and schizophrenia. *Schizophrenia Research* 8 (2): 93–102.
212. Freedman, R., L. E. Adler, P. Bickford, W. Byerley, H. Coon, C. M. Cullum, J. M. Griffith, et al. 1994. Schizophrenia and nicotinic receptors. *Harvard Review of Psychiatry* 2 (4): 179–92.
213. Kumari, V., and P. Postma. 2005. Nicotine use in schizophrenia: The self medication hypotheses. *Neuroscience and Biobehavioral Reviews* 29 (6): 1021–34.
214. Hall, M. H., K. Schulze, F. Rijdsdijk, M. Picchioni, U. Ettinger, E. Bramon, R. Freedman, R. M. Murray, and P. Sham. 2006. Heritability and reliability of P300, P50 and duration mismatch negativity. *Behavior Genetics* 36 (6): 845–57.
215. Young, D. A., M. Waldo, J. H. Rutledge 3rd, and R. Freedman. 1996. Heritability of inhibitory gating of the P50 auditory-evoked potential in monozygotic and dizygotic twins. *Neuropsychobiology* 33 (3): 113–17.
216. Hall, M. H., K. Schulze, E. Bramon, R. M. Murray, P. Sham, and F. Rijdsdijk. 2006. Genetic overlap between P300, P50, and duration mismatch negativity. *American Journal of Medical Genetics Part B, Neuropsychiatric Genetics* 141 (4): 336–43.
217. Freedman, R., H. Coon, M. Myles-Worsley, A. Orr-Urtreger, A. Olincy, A. Davis, M. Polymeropoulos, et al. 1997. Linkage of a neurophysiological deficit in schizophrenia to a chromosome 15 locus. *Proceedings of the National Academy of Sciences of the United States of America* 94 (2): 587–92.
218. Leonard, S., J. Gault, J. Hopkins, J. Logel, R. Vianzon, M. Short, C. Drebing, et al. 2002. Association of promoter variants in the alpha7 nicotinic acetylcholine receptor subunit gene with an inhibitory deficit found in schizophrenia. *Archives of General Psychiatry* 59 (12): 1085–96.
219. Houy, E., G. Raux, F. Thibaut, A. Belmont, C. Demily, G. Allio, S. Haouzir, et al. 2004. The promoter -194 C polymorphism of the nicotinic alpha 7 receptor gene has a protective effect against the P50 sensory gating deficit. *Molecular Psychiatry* 9 (3): 320–22.
220. Slawewski, C. J., J. D. Thomas, E. P. Riley, and C. L. Ehlers. 2000. Neonatal nicotine exposure alters hippocampal EEG and event-related potentials (ERPs) in rats.

- Pharmacology, Biochemistry, and Behavior* 65 (4): 711–18.
221. Anokhin, A. P., A. B. Vedeniapin, E. J. Sirevaag, L. O. Bauer, S. J. O'Connor, S. Kuperman, B. Porjesz, et al. 2000. The P300 brain potential is reduced in smokers. *Psychopharmacology (Berl)* 149 (4): 409–13.
222. Polich, J., and C. J. Ochoa. 2004. Alcoholism risk, tobacco smoking, and P300 event-related potential. *Clinical Neurophysiology* 115 (6): 1374–83.
223. Neuhaus, A. H., S. Koehler, C. Opgen-Rhein, C. Urbanek, E. Hahn, and M. Dettling. 2007. Selective anterior cingulate cortex deficit during conflict solution in schizophrenia: An event-related potential study. *Journal of Psychiatric Research* 41 (8): 635–44.
224. Ilan, A. B., and J. Polich. 2001. Tobacco smoking and event-related brain potentials in a Stroop task. *International Journal of Psychophysiology* 40 (2): 109–18.
225. McDonough, B. E., and C. A. Warren. 2001. Effects of 12-h tobacco deprivation on event-related potentials elicited by visual smoking cues. *Psychopharmacology (Berl)* 154 (3): 282–91.
226. Segalowitz, S. J., and K. L. Barnes. 1993. The reliability of ERP components in the auditory oddball paradigm. *Psychophysiology* 30 (5): 451–59.
227. Katsanis, J., W. G. Iacono, M. K. McGue, and S. R. Carlson. 1997. P300 event-related potential heritability in monozygotic and dizygotic twins. *Psychophysiology* 34 (1): 47–58.
228. van Beijsterveldt, C. E., P. C. Molenaar, E. J. de Geus, and D. I. Boomsma. 1998. Individual differences in P300 amplitude: A genetic study in adolescent twins. *Biological Psychology* 47 (2): 97–120.
229. Noble, E. P., S. M. Berman, T. Z. Ozkaragoz, and T. Ritchie. 1994. Prolonged P300 latency in children with the D2 dopamine receptor A1 allele. *American Journal of Human Genetics* 54 (4): 658–68.
230. Mulert, C., G. Juckel, I. Giegling, O. Pogarell, G. Leicht, S. Karch, P. Mavrogiorgou, H. J. Moller, U. Hegerl, and D. Rujescu. 2006. A Ser9Gly polymorphism in the dopamine D3 receptor gene (DRD3) and event-related P300 potentials. *Neuropsychopharmacology* 31 (6): 1335–44.
231. Strobel, A., S. Debener, K. Anacker, J. Muller, K. P. Lesch, and B. Brocke. 2004. Dopamine D4 receptor exon III genotype influence on the auditory evoked novelty P3. *Neuroreport* 15 (15): 2411–15.
232. Le Foll, B., S. R. Goldberg, and P. Sokoloff. 2007. Dopamine D3 receptor ligands for the treatment of tobacco dependence. *Expert Opinion on Investigational Drugs* 16 (1): 45–57.
233. Meyer-Lindenberg, A., P. D. Kohn, B. Kolachana, S. Kippenhan, A. McInerney-Leo, R. Nussbaum, D. R. Weinberger, and K. F. Berman. 2005. Midbrain dopamine and prefrontal function in humans: Interaction and modulation by COMT genotype. *Nature Neuroscience* 8 (5): 594–96.
234. Gallinat, J., M. Bajbouj, T. Sander, P. Schlattmann, K. Xu, E. F. Ferro, D. Goldman, and G. Winterer. 2003. Association of the G1947A COMT (Val(108/158)Met) gene polymorphism with prefrontal P300 during information processing. *Biological Psychiatry* 54 (1): 40–48.
235. Ehrlis, A. C., A. Reif, M. J. Herrmann, K. P. Lesch, and A. J. Fallgatter. 2007. Impact of catechol-O-methyltransferase on prefrontal brain functioning in schizophrenia spectrum disorders. *Neuropsychopharmacology* 32 (1): 162–70.
236. Bramon, E., E. Dempster, S. Frangou, C. McDonald, P. Schoenberg, J. H. MacCabe, M. Walshe, P. Sham, D. Collier, and R. M. Murray. 2006. Is there an association between the COMT gene and P300 endophenotypes? *European Psychiatry* 21 (1): 70–73.
237. Acri, J. B., K. J. Brown, M. I. Saah, and N. E. Grunberg. 1995. Strain and age differences in acoustic startle responses and effects of nicotine in rats. *Pharmacology, Biochemistry, and Behavior* 50 (2): 191–98.
238. Swerdlow, N. R., and M. A. Geyer. 1998. Using an animal model of deficient sensorimotor gating to study the pathophysiology and new treatments of schizophrenia. *Schizophrenia Bulletin* 24 (2): 285–301.
239. Gould, T. J., M. Rukstalis, and M. C. Lewis. 2005. Atomoxetine and nicotine enhance prepulse inhibition of acoustic startle in C57BL/6 mice. *Neuroscience Letters* 377 (2): 85–90.
240. Andreasen, J. T., K. K. Andersen, E. O. Nielsen, L. Mathiasen, and N. R. Mirza. 2006. Nicotine and clozapine selectively reverse a PCP-induced deficit of PPI in

- BALB/cByJ but not NMRI mice: Comparison with risperidone. *Behavioural Brain Research* 167 (1): 118–27.
241. Spielewoy, C., and A. Markou. 2004. Strain-specificity in nicotine attenuation of phencyclidine-induced disruption of prepulse inhibition in mice: Relevance to smoking in schizophrenia patients. *Behavior Genetics* 34 (3): 343–54.
242. Acri, J. B., D. E. Morse, E. J. Popke, and N. E. Grunberg. 1994. Nicotine increases sensory gating measured as inhibition of the acoustic startle reflex in rats. *Psychopharmacology (Berl)* 114 (2): 369–74.
243. Curzon, P., D. J. Kim, and M. W. Decker. 1994. Effect of nicotine, lobeline, and mecamylamine on sensory gating in the rat. *Pharmacology, Biochemistry, and Behavior* 49 (4): 877–82.
244. Suemaru, K., K. Yasuda, K. Umeda, H. Araki, K. Shibata, T. Choshi, S. Hibino, and Y. Gomita. 2004. Nicotine blocks apomorphine-induced disruption of prepulse inhibition of the acoustic startle in rats: Possible involvement of central nicotinic $\alpha 7$ receptors. *British Journal of Pharmacology* 142 (5): 843–50.
245. Schreiber, R., M. Dalmus, and J. De Vry. 2002. Effects of $\alpha 4/\beta 2$ - and $\alpha 7$ -nicotine acetylcholine receptor agonists on prepulse inhibition of the acoustic startle response in rats and mice. *Psychopharmacology (Berl)* 159 (3): 248–57.
246. Paylor, R., M. Nguyen, J. N. Crawley, J. Patrick, A. Beaudet, and A. Orr-Urtreger. 1998. $\alpha 7$ nicotinic receptor subunits are not necessary for hippocampal-dependent learning or sensorimotor gating: A behavioral characterization of $\alpha 7$ -deficient mice. *Learning & Memory* 5 (4–5): 302–16.
247. Cui, C., T. K. Booker, R. S. Allen, S. R. Grady, P. Whiteaker, M. J. Marks, O. Salminen, et al. 2003. The $\beta 3$ nicotinic receptor subunit: A component of α -conotoxin MII-binding nicotinic acetylcholine receptors that modulate dopamine release and related behaviors. *Journal of Neuroscience* 23 (35): 11045–53.
248. Semenova, S., A. Bespalov, and A. Markou. 2003. Decreased prepulse inhibition during nicotine withdrawal in DBA/2J mice is reversed by nicotine self-administration. *European Journal of Pharmacology* 472 (1–2): 99–110.
249. Jonkman, S., B. Henry, S. Semenova, and A. Markou. 2005. Mild anxiogenic effects of nicotine withdrawal in mice. *European Journal of Pharmacology* 516 (1): 40–45.
250. Faraday, M. M., M. A. Rahman, P. M. Scheufele, and N. E. Grunberg. 1998. Nicotine administration impairs sensory gating in Long-Evans rats. *Pharmacology, Biochemistry, and Behavior* 61 (3): 281–89.
251. Duncan, E., S. Madonick, S. Chakravorty, A. Parwani, S. Szilagyi, T. Efferen, S. Gonzenbach, B. Angrist, and J. Rotrosen. 2001. Effects of smoking on acoustic startle and prepulse inhibition in humans. *Psychopharmacology (Berl)* 156 (2–3): 266–72.
252. Kumari, V., S. A. Checkley, and J. A. Gray. 1996. Effect of cigarette smoking on prepulse inhibition of the acoustic startle reflex in healthy male smokers. *Psychopharmacology (Berl)* 128 (1): 54–60.
253. Kumari, V., P. A. Cotter, S. A. Checkley, and J. A. Gray. 1997. Effect of acute subcutaneous nicotine on prepulse inhibition of the acoustic startle reflex in healthy male non-smokers. *Psychopharmacology (Berl)* 132 (4): 389–95.
254. Braff, D. L., M. A. Geyer, and N. R. Swerdlow. 2001. Human studies of prepulse inhibition of startle: Normal subjects, patient groups, and pharmacological studies. *Psychopharmacology (Berl)* 156 (2–3): 234–58.
255. Orain-Pelissolo, S., C. Grillon, F. Perez-Diaz, and R. Jouvent. 2004. Lack of startle modulation by smoking cues in smokers. *Psychopharmacology (Berl)* 173 (1–2): 160–66.
256. Cadenhead, K. S., B. S. Carasso, N. R. Swerdlow, M. A. Geyer, and D. L. Braff. 1999. Prepulse inhibition and habituation of the startle response are stable neurobiological measures in a normal male population. *Biological Psychiatry* 45 (3): 360–64.
257. Ludewig, K., M. A. Geyer, M. Etzensberger, and F. X. Vollenweider. 2002. Stability of the acoustic startle reflex, prepulse inhibition, and habituation in schizophrenia. *Schizophrenia Research* 55 (1–2): 129–37.
258. Anokhin, A. P., A. C. Heath, E. Myers, A. Ralano, and S. Wood. 2003. Genetic influences on prepulse inhibition of startle reflex in humans. *Neuroscience Letters* 353 (1): 45–48.

259. Anokhin, A. P., S. Golosheykin, and A. C. Heath. 2007. Genetic and environmental influences on emotion-modulated startle reflex: A twin study. *Psychophysiology* 44 (1): 106–12.
260. Kumari, V., J. A. Gray, D. H. ffytche, M. T. Mitterschiffthaler, M. Das, E. Zachariah, G. N. Vythelingum, S. C. Williams, A. Simmons, and T. Sharma. 2003. Cognitive effects of nicotine in humans: An fMRI study. *NeuroImage* 19 (3): 1002–13.
261. Bizarro, L., and I. P. Stolerman. 2003. Attentional effects of nicotine and amphetamine in rats at different levels of motivation. *Psychopharmacology (Berl)* 170 (3): 271–77.
262. Hahn, B., M. Shoaib, and I. P. Stolerman. 2002. Nicotine-induced enhancement of attention in the five-choice serial reaction time task: The influence of task demands. *Psychopharmacology (Berl)* 162 (2): 129–37.
263. Mirza, N. R., and I. P. Stolerman. 1998. Nicotine enhances sustained attention in the rat under specific task conditions. *Psychopharmacology (Berl)* 138 (3–4): 266–74.
264. Shoaib, M., and L. Bizarro. 2005. Deficits in a sustained attention task following nicotine withdrawal in rats. *Psychopharmacology (Berl)* 178 (2–3): 211–22.
265. Davis, J. A., J. R. James, S. J. Siegel, and T. J. Gould. 2005. Withdrawal from chronic nicotine administration impairs contextual fear conditioning in C57BL/6 mice. *Journal of Neuroscience* 25 (38): 8708–713.
266. Logue, S. F., R. Paylor, and J. M. Wehner. 1997. Hippocampal lesions cause learning deficits in inbred mice in the Morris water maze and conditioned-fear task. *Behavioral Neuroscience* 111 (1): 104–13.
267. Phillips, R. G., and J. E. LeDoux. 1992. Differential contribution of amygdala and hippocampus to cued and contextual fear conditioning. *Behavioral Neuroscience* 106 (2): 274–85.
268. Mirza, N. R., and J. L. Bright. 2001. Nicotine-induced enhancements in the five-choice serial reaction time task in rats are strain-dependent. *Psychopharmacology (Berl)* 154 (1): 8–12.
269. Young, J. W., K. Finlayson, C. Spratt, H. M. Marston, N. Crawford, J. S. Kelly, and J. Sharkey. 2004. Nicotine improves sustained attention in mice: Evidence for involvement of the alpha7 nicotinic acetylcholine receptor. *Neuropsychopharmacology* 29 (5): 891–900.
270. Pomerleau, C. S., K. K. Downey, S. M. Snedecor, A. M. Mehringer, J. L. Marks, and O. F. Pomerleau. 2003. Smoking patterns and abstinence effects in smokers with no ADHD, childhood ADHD, and adult ADHD symptomatology. *Addictive Behaviors* 28 (6): 1149–57.
271. Lerman, C., J. Audrain, K. Tercyak, L. W. Hawk Jr., A. Bush, S. Crystal-Mansour, C. Rose, R. Niaura, and L. H. Epstein. 2001. Attention-deficit hyperactivity disorder (ADHD) symptoms and smoking patterns among participants in a smoking-cessation program. *Nicotine & Tobacco Research* 3 (4): 353–59.
272. Kollins, S. H., F. J. McClernon, and B. F. Fuemmeler. 2005. Association between smoking and attention-deficit/hyperactivity disorder symptoms in a population-based sample of young adults. *Archives of General Psychiatry* 62 (10): 1142–7.
273. Rukstalis, M., C. Jepson, F. Patterson, and C. Lerman. 2005. Increases in hyperactive–impulsive symptoms predict relapse among smokers in nicotine replacement therapy. *Journal of Substance Abuse Treatment* 28 (4): 297–304.
274. Levin, E. D., C. K. Conners, D. Silva, S. C. Hinton, W. H. Meck, J. March, and J. E. Rose. 1998. Transdermal nicotine effects on attention. *Psychopharmacology (Berl)* 140 (2): 135–41.
275. Levin, E. D., C. K. Conners, E. Sparrow, S. C. Hinton, D. Erhardt, W. H. Meck, J. E. Rose, and J. March. 1996. Nicotine effects on adults with attention-deficit/hyperactivity disorder. *Psychopharmacology (Berl)* 123 (1): 55–63.
276. Cornblatt, B. A., N. J. Risch, G. Faris, D. Friedman, and L. Erlenmeyer-Kimling. 1988. The continuous performance test, identical pairs version (CPT-IP): I. New findings about sustained attention in normal families. *Psychiatry Research* 26 (2): 223–38.
277. Riccio, C. A., and C. R. Reynolds. 2001. Continuous performance tests are sensitive to ADHD in adults but lack specificity. A review and critique for differential diagnosis. *Annals of the New York Academy of Sciences* 931: 113–39.
278. Riccio, C. A., J. J. Waldrop, C. R. Reynolds, and P. Lowe. 2001. Effects of stimulants on

- the continuous performance test (CPT): Implications for CPT use and interpretation. *Journal of Neuropsychiatry and Clinical Neurosciences* 13 (3): 326–35.
279. Seifert, J., P. Scheuerpflug, K. E. Zillessen, A. Fallgatter, and A. Warnke. 2003. Electrophysiological investigation of the effectiveness of methylphenidate in children with and without ADHD. *Journal of Neural Transmission* 110 (7): 821–29.
280. Tinius, T. P. 2003. The integrated visual and auditory continuous performance test as a neuropsychological measure. *Archives of Clinical Neuropsychology* 18 (5): 439–54.
281. Walker, A. J., E. A. Shores, J. N. Trollor, T. Lee, and P. S. Sachdev. 2000. Neuropsychological functioning of adults with attention deficit hyperactivity disorder. *Journal of Clinical and Experimental Neuropsychology* 22 (1): 115–24.
282. Pritchard, W. S., J. H. Robinson, and T. D. Guy. 1992. Enhancement of continuous performance task reaction time by smoking in non-deprived smokers. *Psychopharmacology (Berl)* 108 (4): 437–42.
283. Edwards, J. A., K. Wesnes, D. M. Warburton, and A. Gale. 1985. Evidence of more rapid stimulus evaluation following cigarette smoking. *Addictive Behaviors* 10 (2): 113–26.
284. Williams, D. G. 1980. Effects of cigarette smoking on immediate memory and performance in different kinds of smoker. *British Journal of Psychology* 71 (1): 83–90.
285. Thompson, P. J., S. A. Baxendale, J. S. Duncan, and J. W. Sander. 2000. Effects of topiramate on cognitive function. *Journal of Neurology, Neurosurgery, and Psychiatry* 69 (5): 636–41.
286. Bates, J. A., and A. K. Malhotra. 2002. Genetic factors and neurocognitive traits. *CNS Spectrums* 7 (4): 274–80, 283–84.
287. Swan, G. E., D. Carmelli, T. Reed, G. A. Harshfield, R. R. Fabsitz, and P. J. Eslinger. 1990. Heritability of cognitive performance in aging twins. The National Heart, Lung, and Blood Institute Twin Study. *Archives of Neurology* 47 (3): 259–62.
288. Tuulio-Henriksson, A., J. Haukka, T. Partonen, T. Varilo, T. Paunio, J. Ekelund, T. D. Cannon, J. M. Meyer, and J. Lonnqvist. 2002. Heritability and number of quantitative trait loci of neurocognitive functions in families with schizophrenia. *American Journal of Medical Genetics* 114 (5): 483–90.
289. Gilbert, D. G., A. Izetelny, R. Radtke, J. Hammersley, N. E. Rabinovich, T. R. Jameson, and J. I. Huggenvik. 2005. Dopamine receptor (DRD2) genotype-dependent effects of nicotine on attention and distraction during rapid visual information processing. *Nicotine & Tobacco Research* 7 (3): 361–79.
290. Diaz-Asper, C. M., D. R. Weinberger, and T. E. Goldberg. 2006. Catechol-O-methyltransferase polymorphisms and some implications for cognitive therapeutics. *NeuroRx* 3 (1): 97–105.
291. Stefanis, N. C., J. van Os, D. Avramopoulos, N. Smyrnis, I. Evdokimidis, and C. N. Stefanis. 2005. Effect of COMT Val158Met polymorphism on the continuous performance test, identical pairs version: Tuning rather than improving performance. *American Journal of Psychiatry* 162 (9): 1752–54.
292. Goldberg, T. E., M. F. Egan, T. Gscheidle, R. Coppola, T. Weickert, B. S. Kolachana, D. Goldman, and D. R. Weinberger. 2003. Executive subprocesses in working memory: relationship to catechol-O-methyltransferase Val158Met genotype and schizophrenia. *Archives of General Psychiatry* 60 (9): 889–96.
293. Barkley, R. A., K. M. Smith, M. Fischer, and B. Navia. 2006. An examination of the behavioral and neuropsychological correlates of three ADHD candidate gene polymorphisms (DRD4 7+, DBH TaqI A2, and DAT1 40 bp VNTR) in hyperactive and normal children followed to adulthood. *American Journal of Medical Genetics Part B, Neuropsychiatric Genetics* 141 (5): 487–98.
294. Loo, S. K., E. Specter, A. Smolen, C. Hopfer, P. D. Teale, and M. L. Reite. 2003. Functional effects of the DAT1 polymorphism on EEG measures in ADHD. *Journal of the American Academy of Child & Adolescent Psychiatry* 42 (8): 986–93.
295. Manor, I., M. Corbex, J. Eisenberg, I. Gritsenko, R. Bachner-Melman, S. Tyano, and R. P. Ebstein. 2004. Association of the dopamine D5 receptor with attention deficit hyperactivity disorder (ADHD) and scores on a continuous performance test (TOVA). *American Journal of Medical Genetics Part B, Neuropsychiatric Genetics* 127 (1): 73–77.
296. Parasuraman, R., P. M. Greenwood, R. Kumar, and J. Fossella. 2005. Beyond heritability: Neurotransmitter genes

- differentially modulate visuospatial attention and working memory. *Psychological Science* 16 (3): 200–207.
297. Dawkins, L., J. H. Powell, R. West, J. Powell, and A. Pickering. 2007. A double-blind placebo-controlled experimental study of nicotine: II—Effects on response inhibition and executive functioning. *Psychopharmacology (Berl)* 190 (4): 457–67.
298. Sacco, K. A., A. Termine, A. Seyal, M. M. Dudas, J. C. Vessicchio, S. Krishnan-Sarin, P. I. Jatlow, B. E. Wexler, and T. P. George. 2005. Effects of cigarette smoking on spatial working memory and attentional deficits in schizophrenia: Involvement of nicotinic receptor mechanisms. *Archives of General Psychiatry* 62 (6): 649–59.
299. Smolka, M. N., M. Buhler, S. Klein, U. Zimmermann, K. Mann, A. Heinz, and D. F. Braus. 2006. Severity of nicotine dependence modulates cue-induced brain activity in regions involved in motor preparation and imagery. *Psychopharmacology (Berl)* 184 (3–4): 577–88.
300. Krishnan-Sarin, S., B. Reynolds, A. M. Duhig, A. Smith, T. Liss, A. McFetridge, D. A. Cavallo, K. M. Carroll, and M. N. Potenza. 2007. Behavioral impulsivity predicts treatment outcome in a smoking cessation program for adolescent smokers. *Drug and Alcohol Dependence* 88 (1): 79–82.
301. Dolan, S. L., K. A. Sacco, A. Termine, A. A. Seyal, M. M. Dudas, J. C. Vessicchio, B. E. Wexler, and T. P. George. 2004. Neuropsychological deficits are associated with smoking cessation treatment failure in patients with schizophrenia. *Schizophrenia Research* 70 (2–3): 263–375.
302. Gould, T. J. 2006. Nicotine and hippocampus-dependent learning: Implications for addiction. *Molecular Neurobiology* 34 (2): 93–107.
303. Gould, T. J. 2003. Nicotine produces a within-subject enhancement of contextual fear conditioning in C57BL/6 mice independent of sex. *Integrative Physiological and Behavioural Science* 38 (2): 124–32.
304. Gould, T. J., and J. A. Lommock. 2003. Nicotine enhances contextual fear conditioning and ameliorates ethanol-induced deficits in contextual fear conditioning. *Behavioral Neuroscience* 117 (6): 1276–82.
305. Gould, T. J., and J. Stephen Higgins. 2003. Nicotine enhances contextual fear conditioning in C57BL/6J mice at 1 and 7 days post-training. *Neurobiology of Learning and Memory* 80 (2): 147–57.
306. Gould, T. J., and J. M. Wehner. 1999. Nicotine enhancement of contextual fear conditioning. *Behavioural Brain Research* 102 (1–2): 31–3.
307. Gould, T. J., O. Feiro, and D. Moore. 2004. Nicotine enhances trace cued fear conditioning but not delay cued fear conditioning in C57BL/6 mice. *Behavioural Brain Research* 155 (1): 167–73.
308. Levin, E. D., and B. B. Simon. 1998. Nicotinic acetylcholine involvement in cognitive function in animals. *Psychopharmacology (Berl)* 138 (3–4): 217–30.
309. Davis, J. A., and T. J. Gould. 2007. beta2 subunit-containing nicotinic receptors mediate the enhancing effect of nicotine on trace cued fear conditioning in C57BL/6 mice. *Psychopharmacology (Berl)* 190 (3): 343–52.
310. Nordberg, A., and C. Bergh. 1985. Effect of nicotine on passive avoidance behaviour and motoric activity in mice. *Acta Pharmacologica et Toxicologica (Copenhagen)* 56 (4): 337–41.
311. Uzum, G., A. S. Diler, N. Bahcekapili, M. Tasyurekli, and Y. Z. Ziyilan. 2004. Nicotine improves learning and memory in rats: Morphological evidence for acetylcholine involvement. *International Journal of Neuroscience* 114 (9): 1163–79.
312. Zarrindast, M. R., M. Sadegh, and B. Shafaghi. 1996. Effects of nicotine on memory retrieval in mice. *European Journal of Pharmacology* 295 (1): 1–6.
313. Sansone, M., M. Battaglia, and C. Castellano. 1994. Effect of caffeine and nicotine on avoidance learning in mice: Lack of interaction. *Journal of Pharmacy and Pharmacology* 46 (9): 765–7.
314. Yilmaz, O., L. Kanit, B. E. Okur, and S. Pogun. 1997. Effects of nicotine on active avoidance learning in rats: Sex differences. *Behavioural Pharmacology* 8 (2–3): 253–60.
315. Bernal, M. C., P. Vicens, M. C. Carrasco, and R. Redolat. 1999. Effects of nicotine on spatial learning in C57BL mice. *Behavioural Pharmacology* 10 (3): 333–36.

316. Socci, D. J., P. R. Sanberg, and G. W. Arendash. 1995. Nicotine enhances Morris water maze performance of young and aged rats. *Neurobiology of Aging* 16 (5): 857–60.
317. Bovet-Nitti, F. 1966. Facilitation of simultaneous visual discrimination by nicotine in the rat. *Psychopharmacologia* 10 (1): 59–66.
318. Bovet, D., F. Bovet-Nitti, and A. Oliverio. 1966. Short and long term memory in two inbred strains of mice. *Life Sciences* 5 (5): 415–20.
319. Bovet-Nitti, F. 1969. Facilitation of simultaneous visual discrimination by nicotine in four “inbred” strains of mice. *Psychopharmacologia* 14 (3): 193–99.
320. Castellano, C. 1976. Effects of nicotine on discrimination learning, consolidation and learned behaviour in two inbred strains of mice. *Psychopharmacology (Berl)* 48 (1): 37–43.
321. Caldarone, B. J., C. H. Duman, and M. R. Picciotto. 2000. Fear conditioning and latent inhibition in mice lacking the high affinity subclass of nicotinic acetylcholine receptors in the brain. *Neuropharmacology* 39 (13): 2779–84.
322. Picciotto, M. R., M. Zoli, C. Lena, A. Bessis, Y. Lallemand, N. Le Novere, P. Vincent, E. M. Pich, P. Brulet, and J. P. Changeux. 1995. Abnormal avoidance learning in mice lacking functional high-affinity nicotine receptor in the brain. *Nature* 374 (6517): 65–67.
323. Wehner, J. M., J. J. Keller, A. B. Keller, M. R. Picciotto, R. Paylor, T. K. Booker, A. Beaudet, S. F. Heinemann, and S. A. Balogh. 2004. Role of neuronal nicotinic receptors in the effects of nicotine and ethanol on contextual fear conditioning. *Neuroscience* 129 (1): 11–24.
324. McEchron, M. D., H. Bouwmeester, W. Tseng, C. Weiss, and J. F. Disterhoft. 1998. Hippocampectomy disrupts auditory trace fear conditioning and contextual fear conditioning in the rat. *Hippocampus* 8 (6): 638–46.
325. McEchron, M. D., W. Tseng, and J. F. Disterhoft. 2000. Neurotoxic lesions of the dorsal hippocampus disrupt auditory-cued trace heart rate (fear) conditioning in rabbits. *Hippocampus* 10 (6): 739–51.
326. Quinn, J. J., S. S. Oommen, G. E. Morrison, and M. S. Fanselow. 2002. Post-training excitotoxic lesions of the dorsal hippocampus attenuate forward trace, backward trace, and delay fear conditioning in a temporally specific manner. *Hippocampus* 12 (4): 495–504.
327. Kleykamp, B. A., J. M. Jennings, M. D. Blank, and T. Eissenberg. 2005. The effects of nicotine on attention and working memory in never-smokers. *Psychology of Addictive Behaviors* 19 (4): 433–38.
328. Poltavski, D. V., and T. Petros. 2006. Effects of transdermal nicotine on attention in adult non-smokers with and without attentional deficits. *Physiology & Behavior* 87 (3): 614–24.
329. Smith, R. C., J. Warner-Cohen, M. Matute, E. Butler, E. Kelly, S. Vaidhyathanaswamy, and A. Khan. 2006. Effects of nicotine nasal spray on cognitive function in schizophrenia. *Neuropsychopharmacology* 31 (3): 637–43.
330. Jacobsen, L. K., J. H. Krystal, W. E. Mencl, M. Westerveld, S. J. Frost, and K. R. Pugh. 2005. Effects of smoking and smoking abstinence on cognition in adolescent tobacco smokers. *Biological Psychiatry* 57 (1): 56–66.
331. Mendrek, A., J. Monterosso, S. L. Simon, M. Jarvik, A. Brody, R. Olmstead, C. P. Dornier, M. S. Cohen, M. Ernst, and E. D. London. 2006. Working memory in cigarette smokers: Comparison to non-smokers and effects of abstinence. *Addictive Behaviors* 31 (5): 833–44.
332. Foulds, J., J. Stapleton, J. Swettenham, N. Bell, K. McSorley, and M. A. Russell. 1996. Cognitive performance effects of subcutaneous nicotine in smokers and never-smokers. *Psychopharmacology (Berl)* 127 (1): 31–38.
333. Grobe, J. E., K. A. Perkins, J. Goettler-Good, and A. Wilson. 1998. Importance of environmental distractors in the effects of nicotine on short-term memory. *Experimental and Clinical Psychopharmacology* 6 (2): 209–16.
334. Xu, J., A. Mendrek, M. S. Cohen, J. Monterosso, P. Rodriguez, S. L. Simon, A. Brody, et al. 2005. Brain activity in cigarette smokers performing a working memory task: Effect of smoking abstinence. *Biological Psychiatry* 58 (2): 143–50.
335. Heaton, R. K., G. Chelune, J. L. Talley, G. G. Kay, and G. Curtiss. 1993. *Wisconsin Card Sorting Test Manual*, rev. and exp. Odessa, FL: Psychological Assessment Resources.

336. Levin, E. D., W. Wilson, J. E. Rose, and J. McEvoy. 1996. Nicotine-haloperidol interactions and cognitive performance in schizophrenics. *Neuropsychopharmacology* 15 (5): 429–36.
337. Perkins, K. A., C. Lerman, S. B. Coddington, C. Jetton, J. L. Karelitz, J. A. Scott, and A. S. Wilson. 2008. Initial nicotine sensitivity in humans as a function of impulsivity. *Psychopharmacology (Berl)* 200 (4): 529–44.
338. Ando, J., Y. Ono, and M. J. Wright. 2001. Genetic structure of spatial and verbal working memory. *Behavior Genetics* 31 (6): 615–24.
339. Wright, M., E. De Geus, J. Ando, M. Luciano, D. Posthuma, Y. Ono, N. Hansell, et al. 2001. Genetics of cognition: Outline of a collaborative twin study. *Twin Research* 4 (1): 48–56.
340. Egan, M. F., T. E. Goldberg, B. S. Kolachana, J. H. Callicott, C. M. Mazzanti, R. E. Straub, D. Goldman, and D. R. Weinberger. 2001. Effect of COMT Val108/158 Met genotype on frontal lobe function and risk for schizophrenia. *Proceedings of the National Academy of Sciences of the United States of America* 98 (12): 6917–22.
341. Malhotra, A. K., L. J. Kestler, C. Mazzanti, J. A. Bates, T. Goldberg, and D. Goldman. 2002. A functional polymorphism in the COMT gene and performance on a test of prefrontal cognition. *American Journal of Psychiatry* 159 (4): 652–54.
342. Bertolino, A., V. Rubino, F. Sambataro, G. Blasi, V. Latorre, L. Fazio, G. Caforio, et al. 2006. Prefrontal-hippocampal coupling during memory processing is modulated by COMT val158met genotype. *Biological Psychiatry* 60 (11): 1250–58.
343. Ho, B. C., T. H. Wassink, D. S. O’Leary, V. C. Sheffield, and N. C. Andreasen. 2005. Catechol-O-methyl transferase Val158Met gene polymorphism in schizophrenia: Working memory, frontal lobe MRI morphology and frontal cerebral blood flow. *Molecular Psychiatry* 10 (3): 229, 287–98.
344. Hansell, N. K., M. R. James, D. L. Duffy, A. J. Birley, M. Luciano, G. M. Geffen, M. J. Wright, G. W. Montgomery, and N. G. Martin. 2007. Effect of the BDNF VI66M polymorphism on working memory in healthy adolescents. *Genes, Brain, and Behavior* 6 (3): 260–68.
345. Rybakowski, J. K., A. Borkowska, P. M. Czerski, M. Skibinska, and J. Hauser. 2003. Polymorphism of the brain-derived neurotrophic factor gene and performance on a cognitive prefrontal test in bipolar patients. *Bipolar Disorders* 5 (6): 468–72.
346. Rybakowski, J. K., A. Borkowska, M. Skibinska, A. Szczepankiewicz, P. Kapelski, A. Leszczynska-Rodziewicz, P. M. Czerski, and J. Hauser. 2006. Prefrontal cognition in schizophrenia and bipolar illness in relation to Val66Met polymorphism of the brain-derived neurotrophic factor gene. *Psychiatry and Clinical Neurosciences* 60 (1): 70–76.
347. Egan, M. F., M. Kojima, J. H. Callicott, T. E. Goldberg, B. S. Kolachana, A. Bertolino, E. Zaitsev, et al. 2003. The BDNF val66met polymorphism affects activity-dependent secretion of BDNF and human memory and hippocampal function. *Cell* 112 (2): 257–69.
348. Jacobsen, L. K., K. R. Pugh, W. E. Mencl, and J. Gelernter. 2006. C957T polymorphism of the dopamine D2 receptor gene modulates the effect of nicotine on working memory performance and cortical processing efficiency. *Psychopharmacology (Berl)* 188 (4): 530–40.
349. West, R., and S. Shiffman. 2001. Effect of oral nicotine dosing forms on cigarette withdrawal symptoms and craving: A systematic review. *Psychopharmacology (Berl)* 155 (2): 115–22.
350. Tiffany, S. T. 1990. A cognitive model of drug urges and drug-use behavior: Role of automatic and nonautomatic processes. *Psychological Review* 97 (2): 147–68.
351. Abrams, D. B., P. M. Monti, K. B. Carey, R. P. Pinto, and S. I. Jacobus. 1988. Reactivity to smoking cues and relapse: Two studies of discriminant validity. *Behavior Research and Therapy* 26 (3): 225–33.
352. Conklin, C. A. 2006. Environments as cues to smoke: Implications for human extinction-based research and treatment. *Experimental and Clinical Psychopharmacology* 14 (1): 12–19.
353. Wilson, S. J., M. A. Sayette, and J. A. Fiez. 2004. Prefrontal responses to drug cues: A neurocognitive analysis. *Nature Neuroscience* 7 (3): 211–14.
354. Brody, A. L., M. A. Mandelkern, E. D. London, A. R. Childress, G. S. Lee, R. G. Bota, M. L. Ho, et al. 2002. Brain metabolic changes during cigarette craving. *Archives of General Psychiatry* 59 (12): 1162–72.

355. David, S. P., M. R. Munafó, H. Johansen-Berg, S. M. Smith, R. D. Rogers, P. M. Matthews, and R. T. Walton. 2005. Ventral striatum/nucleus accumbens activation to smoking-related pictorial cues in smokers and nonsmokers: A functional magnetic resonance imaging study. *Biological Psychiatry* 58 (6): 488–94.
356. Due, D. L., S. A. Huettel, W. G. Hall, and D. C. Rubin. 2002. Activation in mesolimbic and visuospatial neural circuits elicited by smoking cues: Evidence from functional magnetic resonance imaging. *American Journal of Psychiatry* 159 (6): 954–60.
357. Okuyemi, K. S., J. N. Powell, C. R. Savage, S. B. Hall, N. Nollen, L. M. Holsen, F. J. McClernon, and J. S. Ahluwalia. 2006. Enhanced cue-elicited brain activation in African American compared with Caucasian smokers: An fMRI study. *Addiction Biology* 11 (1): 97–106.
358. Wilson, S. J., M. A. Sayette, M. R. Delgado, and J. A. Fiez. 2005. Instructed smoking expectancy modulates cue-elicited neural activity: A preliminary study. *Nicotine & Tobacco Research* 7 (4): 637–45.
359. McBride, D., S. P. Barrett, J. T. Kelly, A. Aw, and A. Dagher. 2006. Effects of expectancy and abstinence on the neural response to smoking cues in cigarette smokers: An fMRI study. *Neuropsychopharmacology* 31 (12): 2728–38.
360. Brody, A. L., M. A. Mandelkern, R. E. Olmstead, D. Scheibal, E. Hahn, S. Shiraga, E. Zamora-Paja, et al. 2006. Gene variants of brain dopamine pathways and smoking-induced dopamine release in the ventral caudate/nucleus accumbens. *Archives of General Psychiatry* 63 (7): 808–16.
361. Tiffany, S. T., and D. J. Drobes. 1991. The development and initial validation of a questionnaire on smoking urges. *British Journal of Addiction* 86 (11): 1467–76.
362. Kozlowski, L. T., and D. A. Wilkinson. 1987. Use and misuse of the concept of craving by alcohol, tobacco, and drug researchers. *British Journal of Addiction* 82 (1): 31–45.
363. Carter, B. L., and S. T. Tiffany. 1999. Meta-analysis of cue-reactivity in addiction research. *Addiction* 94 (3): 327–40.
364. Cox, L. S., S. T. Tiffany, and A. G. Christen. 2001. Evaluation of the brief questionnaire of smoking urges (QSU-brief) in laboratory and clinical settings. *Nicotine & Tobacco Research* 3 (1): 7–16.
365. Shiffman, S. M., and M. E. Jarvik. 1976. Smoking withdrawal symptoms in two weeks of abstinence. *Psychopharmacology (Berl)* 50 (1): 35–39.
366. Heishman, S. J., E. G. Singleton, and E. T. Moolchan. 2003. Tobacco Craving Questionnaire: Reliability and validity of a new multifactorial instrument. *Nicotine & Tobacco Research* 5 (5): 645–54.
367. Heishman, S. J., S. Saha, and E. G. Singleton. 2004. Imagery-induced tobacco craving: Duration and lack of assessment reactivity bias. *Psychology of Addictive Behaviors* 18 (3): 284–88.
368. Cox, W. M., J. S. Fadardi, and E. M. Pothos. 2006. The addiction-Stroop test: Theoretical considerations and procedural recommendations. *Psychological Bulletin* 132 (3): 443–76.
369. Lee, J. H., Y. Lim, B. K. Wiederhold, and S. J. Graham. 2005. A functional magnetic resonance imaging (fMRI) study of cue-induced smoking craving in virtual environments. *Applied Psychophysiology and Biofeedback* 30 (3): 195–204.
370. Wertz, J. M., and M. A. Sayette. 2001. A review of the effects of perceived drug use opportunity of self-reported urge. *Experimental and Clinical Psychopharmacology* 9 (1): 3–13.
371. Hutchison, K. E., H. LaChance, R. Niaura, A. Bryan, and A. Smolen. 2002. The DRD4 VNTR polymorphism influences reactivity to smoking cues. *Journal of Abnormal Psychology* 111 (1): 134–43.
372. McClernon, F. J., K. E. Hutchison, J. E. Rose, and R. V. Kozink. 2007. DRD4 VNTR polymorphism is associated with transient fMRI-BOLD responses to smoking cues. *Psychopharmacology (Berl)* 194 (4): 433–41.
373. Erblich, J., C. Lerman, D. W. Self, G. A. Diaz, and D. H. Bovbjerg. 2005. Effects of dopamine D2 receptor (DRD2) and transporter (SLC6A3) polymorphisms on smoking cue-induced cigarette craving among African-American smokers. *Molecular Psychiatry* 10 (4): 407–14.
374. Munafó, M. R., E. C. Johnstone, and B. Mackintosh. 2005. Association of serotonin transporter genotype with selective processing of smoking-related stimuli in current smokers and ex-smokers. *Nicotine & Tobacco Research* 7 (5): 773–78.
375. Killen, J. D., and S. P. Fortmann. 1997. Craving is associated with smoking

- relapse: Findings from three prospective studies. *Experimental and Clinical Psychopharmacology* 5 (2): 137–42.
376. Swan, G. E., M. M. Ward, and L. M. Jack. 1996. Abstinence effects as predictors of 28-day relapse in smokers. *Addictive Behaviors* 21 (4): 481–90.
377. Evans, S. E., M. Blank, C. Sams, M. F. Weaver, and T. Eissenberg. 2006. Transdermal nicotine-induced tobacco abstinence symptom suppression: Nicotine dose and smokers' gender. *Experimental and Clinical Psychopharmacology* 14 (2): 121–35.
378. Swan, G. E., T. McAfee, S. J. Curry, L. M. Jack, H. Javitz, S. Dacey, and K. Bergman. 2003. Effectiveness of bupropion sustained release for smoking cessation in a health care setting: A randomized trial. *Archives of Internal Medicine* 163 (19): 2337–44.
379. Gonzales, D., S. I. Rennard, M. Nides, and C. Oncken. 2006. Varenicline, an 4b2 nicotinic acetylcholine receptor partial agonist, vs sustained-release bupropion and placebo for smoking cessation. *JAMA: The Journal of the American Medical Association* 296 (1): 47–55.
380. Perkins, K.A. In press. Does smoking cue-induced craving tell us anything important about nicotine dependence? *Addiction*.
381. Sayette, M. A., J. M. Wertz, C. S. Martin, J. F. Cohn, M. A. Perrott, and J. Hobel. 2003. Effects of smoking opportunity on cue-elicited urge: A facial coding analysis. *Experimental and Clinical Psychopharmacology* 11 (3): 218–27.
382. Morissette, S. B., T. P. Palfai, S. B. Gulliver, D. A. Spiegel, and D. H. Barlow. 2005. Effects of transdermal nicotine during imaginal exposure to anxiety and smoking cues in college smokers. *Psychology of Addictive Behaviors* 19 (2): 192–98.
383. Tiffany, S. T., L. S. Cox, and C. A. Elash. 2000. Effects of transdermal nicotine patches on abstinence-induced and cue-elicited craving in cigarette smokers. *Journal of Consulting and Clinical Psychology* 68 (2): 233–40.
384. Niaura, R., B. Hitsman, W. G. Shadel, D. M. Britt, and L. H. Price. 2007. Effect of varenicline on cue-provoked cigarette craving and acute nicotine withdrawal. Paper presented at 2007 annual meeting of the Society for Research on Nicotine and Tobacco.
385. Shiffman, S., W. G. Shadel, R. Niaura, M. A. Khayrallah, D. E. Jorenby, C. F. Ryan, and C. L. Ferguson. 2003. Efficacy of acute administration of nicotine gum in relief of cue-provoked cigarette craving. *Psychopharmacology (Berl)* 166 (4): 343–50.
386. Waters, A. J., S. Shiffman, M. A. Sayette, J. A. Paty, C. J. Gwaltney, and M. H. Balabanis. 2004. Cue-provoked craving and nicotine replacement therapy in smoking cessation. *Journal of Consulting and Clinical Psychology* 72 (6): 1136–43.
387. Niaura, R., D. Abrams, B. Demuth, R. Pinto, and P. Monti. 1989. Responses to smoking-related stimuli and early relapse to smoking. *Addictive Behaviors* 14 (4): 419–28.
388. McClernon, F. J., F. B. Hiott, J. Liu, A. N. Salley, F. M. Behm, and J. E. Rose. 2007. Selectively reduced responses to smoking cues in amygdala following extinction-based smoking cessation: Results of a preliminary functional magnetic resonance imaging study. *Addiction Biology* 12 (3–4): 503–12.
389. Waters, A. J., S. Shiffman, M. A. Sayette, J. A. Paty, C. J. Gwaltney, and M. H. Balabanis. 2003. Attentional bias predicts outcome in smoking cessation. *Health Psychology* 22 (4): 378–87.
390. Waters, A. J., and C. Feyerabend. 2000. Determinants and effects of attentional bias in smokers. *Psychology of Addictive Behaviors* 14 (2): 111–20.
391. Piasecki, T. M., D. E. Jorenby, S. S. Smith, M. C. Fiore, and T. B. Baker. 2003. Smoking withdrawal dynamics: II. Improved tests of withdrawal-relapse relations. *Journal of Abnormal Psychology* 112 (1): 14–27.
392. Piasecki, T. M., S. L. Kenford, S. S. Smith, M. C. Fiore, and T. B. Baker. 1997. Listening to nicotine: Negative affect and the smoking withdrawal conundrum. *Psychological Science* 8 (3): 184–89.
393. Kenford, S. L., S. S. Smith, D. W. Wetter, D. E. Jorenby, M. C. Fiore, and T. B. Baker. 2002. Predicting relapse back to smoking: Contrasting affective and physical models of dependence. *Journal of Consulting and Clinical Psychology* 70 (1): 216–27.
394. Lerman, C., D. Roth, V. Kaufmann, J. Audrain, L. Hawk, A. Liu, R. Niaura, and L. Epstein. 2002. Mediating mechanisms for the impact of bupropion in smoking cessation treatment. *Drug and Alcohol Dependence* 67 (2): 219–23.

395. File, S. E., S. Cheeta, and P. J. Kenny. 2000. Neurobiological mechanisms by which nicotine mediates different types of anxiety. *European Journal of Pharmacology* 393 (1–3): 231–36.
396. Genn, R. F., S. Tucci, J. E. Edwards, and S. E. File. 2003. Dietary restriction and nicotine can reduce anxiety in female rats. *Neuropsychopharmacology* 28 (7): 1257–63.
397. Balerio, G. N., E. Aso, and R. Maldonado. 2005. Involvement of the opioid system in the effects induced by nicotine on anxiety-like behaviour in mice. *Psychopharmacology (Berl)* 181 (2): 260–69.
398. Balerio, G. N., E. Aso, and R. Maldonado. 2006. Role of the cannabinoid system in the effects induced by nicotine on anxiety-like behaviour in mice. *Psychopharmacology (Berl)* 184 (3–4): 504–13.
399. Tucci, S., R. F. Genn, E. Marco, and S. E. File. 2003. Do different mechanisms underlie two anxiogenic effects of systemic nicotine? *Behavioural Pharmacology* 14 (4): 323–29.
400. Costall, B., M. E. Kelly, R. J. Naylor, and E. S. Onaivi. 1989. The actions of nicotine and cocaine in a mouse model of anxiety. *Pharmacology, Biochemistry, and Behavior* 33 (1): 197–203.
401. Brioni, J. D., A. B. O'Neill, D. J. Kim, and M. W. Decker. 1993. Nicotinic receptor agonists exhibit anxiolytic-like effects on the elevated plus-maze test. *European Journal of Pharmacology* 238 (1): 1–8.
402. Lewis, M. C., and T. J. Gould. 2003. Nicotine and ethanol enhancements of acoustic startle reflex are mediated in part by dopamine in C57BL/6J mice. *Pharmacology, Biochemistry, and Behavior* 76 (1): 179–86.
403. Cheeta, S., S. Tucci, and S. E. File. 2001. Antagonism of the anxiolytic effect of nicotine in the dorsal raphe nucleus by dihydro-beta-erythroidine. *Pharmacology, Biochemistry, and Behavior* 70 (4): 491–96.
404. Biala, G., and B. Budzynska. 2006. Effects of acute and chronic nicotine on elevated plus maze in mice: Involvement of calcium channels. *Life Sciences* 79 (1): 81–88.
405. Carrasco, M. C., P. Vicens, J. Vidal, and R. Redolat. 2006. Effects of co-administration of bupropion and nicotinic agonists on the elevated plus-maze test in mice. *Progress in Neuro-Psychopharmacology & Biological Psychiatry* 30 (3): 455–62.
406. Zarrindast, M. R., H. Homayoun, A. Babaie, A. Etminani, and B. Gharib. 2000. Involvement of adrenergic and cholinergic systems in nicotine-induced anxiogenesis in mice. *European Journal of Pharmacology* 407 (1–2): 145–58.
407. Ouagazzal, A. M., P. J. Kenny, and S. E. File. 1999. Modulation of behaviour on trials 1 and 2 in the elevated plus-maze test of anxiety after systemic and hippocampal administration of nicotine. *Psychopharmacology (Berl)* 144 (1): 54–60.
408. Ferguson, S. M., J. D. Brodtkin, G. K. Lloyd, and F. Menzaghi. 2000. Antidepressant-like effects of the subtype-selective nicotinic acetylcholine receptor agonist, SIB-1508Y, in the learned helplessness rat model of depression. *Psychopharmacology (Berl)* 152 (3): 295–303.
409. Semba, J., C. Matakai, S. Yamada, M. Nankai, and M. Toru. 1998. Antidepressantlike effects of chronic nicotine on learned helplessness paradigm in rats. *Biological Psychiatry* 43 (5): 389–91.
410. Suemaru, K., K. Yasuda, R. Cui, B. Li, K. Umeda, M. Amano, H. Mitsuhashi, et al. 2006. Antidepressant-like action of nicotine in forced swimming test and brain serotonin in mice. *Physiology & Behavior* 88 (4–5): 545–49.
411. Vazquez-Palacios, G., H. Bonilla-Jaime, and J. Velazquez-Moctezuma. 2004. Antidepressant-like effects of the acute and chronic administration of nicotine in the rat forced swimming test and its interaction with fluoxetine [correction of flouoxetine]. *Pharmacology, Biochemistry, and Behavior* 78 (1): 165–69.
412. Marks, M. J., J. B. Burch, and A. C. Collins. 1983. Genetics of nicotine response in four inbred strains of mice. *Journal of Pharmacology and Experimental Therapeutics* 226 (1): 291–302.
413. Marks, M. J., J. A. Stitzel, and A. C. Collins. 1989. Genetic influences on nicotine responses. *Pharmacology, Biochemistry, and Behavior* 33 (3): 667–78.
414. Ross, S. A., J. Y. Wong, J. J. Clifford, A. Kinsella, J. S. Massalas, M. K. Horne, I. E. Scheffer, et al. 2000. Phenotypic characterization of an alpha 4 neuronal nicotinic acetylcholine receptor subunit knock-out mouse. *Journal of Neuroscience* 20 (17): 6431–41.
415. Labarca, C., J. Schwarz, P. Deshpande, S. Schwarz, M. W. Nowak, C. Fonck,

- R. Nashmi, et al. 2001. Point mutant mice with hypersensitive alpha 4 nicotinic receptors show dopaminergic deficits and increased anxiety. *Proceedings of the National Academy of Sciences of the United States of America* 98 (5): 2786–91.
416. Owens, J. C., S. A. Balogh, T. D. McClure-Begley, C. M. Butt, C. Labarca, H. A. Lester, M. R. Picciotto, J. M. Wehner, and A. C. Collins. 2003. Alpha 4 beta 2* nicotinic acetylcholine receptors modulate the effects of ethanol and nicotine on the acoustic startle response. *Alcoholism, Clinical and Experimental Research* 27 (12): 1867–75.
417. Salas, R., A. Orr-Urtreger, R. S. Broide, A. Beaudet, R. Paylor, and M. De Biasi. 2003. The nicotinic acetylcholine receptor subunit alpha 5 mediates short-term effects of nicotine in vivo. *Molecular Pharmacology* 63 (5): 1059–66.
418. Lerman, C., J. Audrain, C. T. Orleans, R. Boyd, K. Gold, D. Main, and N. Caporaso. 1996. Investigation of mechanisms linking depressed mood to nicotine dependence. *Addictive Behaviors* 21 (1): 9–19.
419. al'Absi, M., D. Hatsukami, and G. L. Davis. 2005. Attenuated adrenocorticotropic responses to psychological stress are associated with early smoking relapse. *Psychopharmacology (Berl)* 181 (1): 107–17.
420. Shiffman, S., and A. J. Waters. 2004. Negative affect and smoking lapses: A prospective analysis. *Journal of Consulting and Clinical Psychology* 72 (2): 192–201.
421. Stewart, S. H., J. Karp, R. O. Pihl, and R. A. Peterson. 1997. Anxiety sensitivity and self-reported reasons for drug use. *Journal of Substance Abuse* 9:223–40.
422. Lasser, K., J. W. Boyd, S. Woolhandler, D. U. Himmelstein, D. McCormick, and D. H. Bor. 2000. Smoking and mental illness: A population-based prevalence study. *JAMA: The Journal of the American Medical Association* 284 (20): 2606–10.
423. Rose, J. S., L. Chassin, C. C. Presson, and S. J. Sherman. 1996. Prospective predictors of quit attempts and smoking cessation in young adults. *Health Psychology* 15 (4): 261–68.
424. Shiffman, S., M. Hufford, M. Hickcox, J. A. Paty, M. Gnys, and J. D. Kassel. 1997. Remember that? A comparison of real-time versus retrospective recall of smoking lapses. *Journal of Consulting and Clinical Psychology* 65 (2): 292–300.
425. Kendler, K. S. 2001. Twin studies of psychiatric illness: An update. *Archives of General Psychiatry* 58 (11): 1005–14.
426. Middeldorp, C. M., D. C. Cath, R. Van Dyck, and D. I. Boomsma. 2005. The co-morbidity of anxiety and depression in the perspective of genetic epidemiology. A review of twin and family studies. *Psychological Medicine* 35 (5): 611–24.
427. Van Den Bogaert, A., J. Del-Favero, and C. Van Broeckhoven. 2006. Major affective disorders and schizophrenia: A common molecular signature? *Human Mutation* 27 (9): 833–53.
428. Carey, G., and D. L. DiLalla. 1994. Personality and psychopathology: Genetic perspectives. *Journal of Abnormal Psychology* 103 (1): 32–43.
429. Ebstein, R. P., A. H. Zohar, J. Benjamin, and R. H. Belmaker. 2002. An update on molecular genetic studies of human personality traits. *Applied Bioinformatics* 1 (2): 57–68.
430. Pergadia, M. L., A. C. Heath, N. G. Martin, and P. A. Madden. 2006. Genetic analyses of DSM-IV nicotine withdrawal in adult twins. *Psychological Medicine* 36 (7): 963–72.
431. Cinciripini, P., D. Wetter, G. Tomlinson, J. Tsoh, C. De Moor, L. Cinciripini, and J. Minna. 2004. The effects of the DRD2 polymorphism on smoking cessation and negative affect: Evidence for a pharmacogenetic effect on mood. *Nicotine & Tobacco Research* 6 (2): 229–39.
432. Lerman, C., N. Caporaso, D. Main, J. Audrain, N. R. Boyd, E. D. Bowman, and P. G. Shields. 1998. Depression and self-medication with nicotine: The modifying influence of the dopamine D4 receptor gene. *Health Psychology* 17 (1): 56–62.
433. Hu, S., C. L. Brody, C. Fisher, L. Gunzerath, M. L. Nelson, S. Z. Sabol, L. A. Sirota, et al. 2000. Interaction between the serotonin transporter gene and neuroticism in cigarette smoking behavior. *Molecular Psychiatry* 5 (2): 181–88.
434. Lerman, C., N. E. Caporaso, J. Audrain, D. Main, N. R. Boyd, and P. G. Shields. 2000. Interacting effects of the serotonin transporter gene and neuroticism in smoking practices and nicotine dependence. *Molecular Psychiatry* 5 (2): 189–92.
435. Hariri, A. R., E. M. Drabant, K. E. Munoz, B. S. Kolachana, V. S. Mattay, M. F. Egan, and D. R. Weinberger. 2005. A susceptibility gene for affective disorders and the response

- of the human amygdala. *Archives of General Psychiatry* 62 (2): 146–52.
436. Heinz, A., D. F. Braus, M. N. Smolka, J. Wrase, I. Puls, D. Hermann, S. Klein, et al. 2005. Amygdala-prefrontal coupling depends on a genetic variation of the serotonin transporter. *Nature Neuroscience* 8 (1): 20–21.
437. Smolka, M. N., G. Schumann, J. Wrase, S. M. Grusser, H. Flor, K. Mann, D. F. Braus, D. Goldman, C. Buchel, and A. Heinz. 2005. Catechol-O-methyltransferase val158met genotype affects processing of emotional stimuli in the amygdala and prefrontal cortex. *Journal of Neuroscience* 25 (4): 836–42.
438. Drabant, E. M., A. R. Hariri, A. Meyer-Lindenberg, K. E. Munoz, V. S. Mattay, B. S. Kolachana, M. F. Egan, and D. R. Weinberger. 2006. Catechol O-methyltransferase val158met genotype and neural mechanisms related to affective arousal and regulation. *Archives of General Psychiatry* 63 (12): 1396–406.
439. Watson, D., L. A. Clark, and A. Tellegen. 1988. Development and validation of brief measures of positive and negative affect: The PANAS scales. *Journal of Personality and Social Psychology* 54 (6): 1063–70.
440. Diener, E., and R. A. Emmons. 1984. The independence of positive and negative affect. *Journal of Personality and Social Psychology* 47 (5): 1105–17.
441. McNair, D. M., M. Lorr, and L. F. Droppleman. 1992. *POMS manual: Profile of mood states*. San Diego: Educational and Industrial Testing Service.
442. Hughes, J. R., and D. Hatsukami. 1986. Signs and symptoms of tobacco withdrawal. *Archives of General Psychiatry* 43 (3): 289–94.
443. Kalman, D. 2002. The subjective effects of nicotine: Methodological issues, a review of experimental studies, and recommendations for future research. *Nicotine & Tobacco Research* 4 (1): 25–70.
444. Kalman, D., and S. S. Smith. 2005. Does nicotine do what we think it does? A meta-analytic review of the subjective effects of nicotine in nasal spray and intravenous studies with smokers and nonsmokers. *Nicotine & Tobacco Research* 7 (3): 317–33.
445. McCarthy, D. E., T. M. Piasecki, M. C. Fiore, and T. B. Baker. 2006. Life before and after quitting smoking: An electronic diary study. *Journal of Abnormal Psychology* 115 (3): 454–66.
446. al'Absi, M., D. Hatsukami, G. L. Davis, and L. E. Wittmers. 2004. Prospective examination of effects of smoking abstinence on cortisol and withdrawal symptoms as predictors of early smoking relapse. *Drug and Alcohol Dependence* 73 (3): 267–78.
447. Ussher, M., R. West, P. Evans, A. Steptoe, A. McEwen, A. Clow, and F. Hucklebridge. 2006. Reduction in cortisol after smoking cessation among users of nicotine patches. *Psychosomatic Medicine* 68 (2): 299–306.
448. Rasmusson, A. M., R. Wu, P. Paliwal, G. M. Anderson, and S. Krishnan-Sarin. 2006. A decrease in the plasma DHEA to cortisol ratio during smoking abstinence may predict relapse: A preliminary study. *Psychopharmacology (Berl)* 186 (3): 473–80.
449. Marx, C. E., W. T. Trost, L. Shampine, F. M. Behm, L. A. Giordano, M. W. Massing, and J. E. Rose. 2006. Neuroactive steroids, negative affect, and nicotine dependence severity in male smokers. *Psychopharmacology (Berl)* 186 (3): 462–72.
450. Hamm, A. O., and A. I. Weike. 2005. The neuropsychology of fear learning and fear regulation. *International Journal of Psychophysiology* 57 (1): 5–14.
451. Filion, D. L., M. E. Dawson, and A. M. Schell. 1998. The psychological significance of human startle eyeblink modification: A review. *Biological Psychology* 47 (1): 1–43.
452. Mueller, V., R. F. Mucha, and P. Pauli. 1998. Dependence on smoking and the acoustic startle response in healthy smokers. *Pharmacology, Biochemistry, and Behavior* 59 (4): 1031–38.
453. Piper, M. E., and J. J. Curtin. 2006. Tobacco withdrawal and negative affect: An analysis of initial emotional response intensity and voluntary emotion regulation. *Journal of Abnormal Psychology* 115 (1): 96–102.
454. Geier, A., R. F. Mucha, and P. Pauli. 2000. Appetitive nature of drug cues confirmed with physiological measures in a model using pictures of smoking. *Psychopharmacology (Berl)* 150 (3): 283–91.
455. Hutchison, K. E., R. Niaura, and R. Swift. 2000. The effects of smoking high nicotine cigarettes on prepulse inhibition, startle latency, and subjective responses. *Psychopharmacology (Berl)* 150 (3): 244–52.
456. Postma, P., V. Kumari, T. Sharma, M. Hines, and J. A. Gray. 2001. Startle response during smoking and 24 h after withdrawal predicts successful smoking cessation.

- Psychopharmacology (Berl)* 156 (2–3): 360–67.
457. Brandon, T. H., T. A. Herzog, L. M. Juliano, J. E. Irvin, A. B. Lazez, and V. N. Simmons. 2003. Pretreatment task persistence predicts smoking cessation outcome. *Journal of Abnormal Psychology* 112 (3): 448–56.
458. Brown, R. A., C. W. Lejuez, C. W. Kahler, and D. R. Strong. 2002. Distress tolerance and duration of past smoking cessation attempts. *Journal of Abnormal Psychology* 111 (1): 180–85.
459. Kassel, J. D., L. R. Stroud, and C. A. Paronis. 2003. Smoking, stress, and negative affect: Correlation, causation, and context across stages of smoking. *Psychological Bulletin* 129 (2): 270–304.
460. Swan, G. E., M. M. Ward, L. M. Jack, and H. S. Javitz. 1993. Cardiovascular reactivity as a predictor of relapse in male and female smokers. *Health Psychology* 12 (6): 451–58.
461. Dallery, J., and M. L. Locey. 2005. Effects of acute and chronic nicotine on impulsive choice in rats. *Behavioural Pharmacology* 16 (1): 15–23.
462. Hohnadel, E. J., C. M. Hernandez, D. A. Gearhart, and A. V. Terry Jr. 2005. Effect of repeated nicotine exposure on high-affinity nicotinic acetylcholine receptor density in spontaneously hypertensive rats. *Neuroscience Letters* 382 (1–2): 158–63.
463. Ueno, K., H. Togashi, M. Matsumoto, S. Ohashi, H. Saito, and M. Yoshioka. 2002. Alpha4beta2 nicotinic acetylcholine receptor activation ameliorates impairment of spontaneous alternation behavior in stroke-prone spontaneously hypertensive rats, an animal model of attention deficit hyperactivity disorder. *Journal of Pharmacology and Experimental Therapeutics* 302 (1): 95–100.
464. Blondel, A., D. J. Sanger, and P. C. Moser. 2000. Characterisation of the effects of nicotine in the five-choice serial reaction time task in rats: Antagonist studies. *Psychopharmacology (Berl)* 149 (3): 293–305.
465. Doran, N., B. Spring, D. McChargue, M. Pergadia, and M. Richmond. 2004. Impulsivity and smoking relapse. *Nicotine & Tobacco Research* 6 (4): 641–47.
466. Doran, N., D. McChargue, B. Spring, J. VanderVeen, J. W. Cook, and M. Richmond. 2006. Effect of nicotine on negative affect among more impulsive smokers. *Experimental and Clinical Psychopharmacology* 14 (3): 287–95.
467. Doran, N., D. McChargue, and L. Cohen. 2007. Impulsivity and the reinforcing value of cigarette smoking. *Addictive Behaviors* 32 (1): 90–98.
468. de Wit, H., and J. B. Richards. 2004. Dual determinants of drug use in humans: Reward and impulsivity. *Nebraska Symposium on Motivation* 50:19–55.
469. Bickel, W. K., A. L. Odum, and G. J. Madden. 1999. Impulsivity and cigarette smoking: Delay discounting in current, never, and ex-smokers. *Psychopharmacology (Berl)* 146 (4): 447–54.
470. Johnson, M. W., and W. K. Bickel. 2002. Within-subject comparison of real and hypothetical money rewards in delay discounting. *Journal of the Experimental Analysis of Behavior* 77 (2): 129–46.
471. Field, M., M. Santarcangelo, H. Sumnall, A. Goudie, and J. Cole. 2006. Delay discounting and the behavioural economics of cigarette purchases in smokers: The effects of nicotine deprivation. *Psychopharmacology (Berl)* 186 (2): 255–63.
472. Mitchell, S. H. 1999. Measures of impulsivity in cigarette smokers and non-smokers. *Psychopharmacology (Berl)* 146 (4): 455–64.
473. Jodo, E., and Y. Kayama. 1992. Relation of a negative ERP component to response inhibition in a go/no-go task. *Electroencephalography and Clinical Neurophysiology* 82 (6): 477–82.
474. Pfefferbaum, A., J. M. Ford, B. J. Weller, and B. S. Kopell. 1985. ERPs to response production and inhibition. *Electroencephalography and Clinical Neurophysiology* 60 (5): 423–34.
475. Roberts, L. E., H. Rau, W. Lutzenberger, and N. Birbaumer. 1994. Mapping P300 waves onto inhibition: go/no-go discrimination. *Electroencephalography and Clinical Neurophysiology* 92 (1): 44–55.
476. Stins, J. F., G. C. van Baal, T. J. Polderman, F. C. Verhulst, and D. I. Boomsma. 2004. Heritability of Stroop and flanker performance in 12-year old children. *BMC Neuroscience* 5 (1): 49.
477. Kuntsi, J., H. Rogers, G. Swinard, N. Borger, J. van der Meere, F. Rijdsdijk, and P. Asherson. 2006. Reaction time, inhibition, working memory and ‘delay aversion’ performance: genetic influences and their interpretation. *Psychological Medicine* 36 (11): 1613–24.

478. Groot, A. S., L. M. de Sonnevile, J. F. Stins, and D. I. Boomsma. 2004. Familial influences on sustained attention and inhibition in preschoolers. *Journal of Child Psychology and Psychiatry* 45 (2): 306–14.
479. Anokhin, A. P., A. C. Heath, and E. Myers. 2004. Genetics, prefrontal cortex, and cognitive control: A twin study of event-related brain potentials in a response inhibition task. *Neuroscience Letters* 368 (3): 314–18.
480. Sanders, R. D., Y. H. Joo, L. Almasy, J. Wood, M. S. Keshavan, M. F. Pogue-Geile, R. C. Gur, R. E. Gur, and V. L. Nimgaonkar. 2006. Are neurologic examination abnormalities heritable? A preliminary study. *Schizophrenia Research* 86 (1–3): 172–80.
481. Cornish, K. M., T. Manly, R. Savage, J. Swanson, D. Morisano, N. Butler, C. Grant, G. Cross, L. Bentley, and C. P. Hollis. 2005. Association of the dopamine transporter (DAT1) 10/10-repeat genotype with ADHD symptoms and response inhibition in a general population sample. *Molecular Psychiatry* 10 (7): 686–98.
482. Langley, K., L. Marshall, M. van den Bree, H. Thomas, M. Owen, M. O'Donovan, and A. Thapar. 2004. Association of the dopamine D4 receptor gene 7-repeat allele with neuropsychological test performance of children with ADHD. *American Journal of Psychiatry* 161 (1): 133–38.
483. Eisenberg, D. T., J. Mackillop, M. Modi, J. Beauchemin, D. Dang, S. A. Lisman, J. K. Lum, and D. S. Wilson. 2007. Examining impulsivity as an endophenotype using a behavioral approach: A DRD2 TaqI A and DRD4 48-bp VNTR association study. *Behavioral and Brain Functions* 3:2.
484. Passamonti, L., F. Fera, A. Magariello, A. Cerasa, M. C. Gioia, M. Muglia, G. Nicoletti, O. Gallo, L. Provinciali, and A. Quattrone. 2006. Monoamine oxidase-a genetic variations influence brain activity associated with inhibitory control: New insight into the neural correlates of impulsivity. *Biological Psychiatry* 59 (4): 334–40.
485. Reuter, M., K. Peters, K. Schroeter, W. Koebke, D. Lenardon, B. Bloch, and J. Hennig. 2005. The influence of the dopaminergic system on cognitive functioning: A molecular genetic approach. *Behavioural Brain Research* 164 (1): 93–99.
486. Nomura, M., and Y. Nomura. 2006. Psychological, neuroimaging, and biochemical studies on functional association between impulsive behavior and the 5-HT2A receptor gene polymorphism in humans. *Annals of the New York Academy of Sciences* 1086:134–43.
487. Baker, F., M. W. Johnson, and W. K. Bickel. 2003. Delay discounting in current and never-before cigarette smokers: Similarities and differences across commodity, sign, and magnitude. *Journal of Abnormal Psychology* 112 (3): 382–92.
488. Odum, A. L., G. J. Madden, and W. K. Bickel. 2002. Discounting of delayed health gains and losses by current, never- and ex-smokers of cigarettes. *Nicotine & Tobacco Research* 4 (3): 295–303.
489. Ohmura, Y., T. Takahashi, and N. Kitamura. 2005. Discounting delayed and probabilistic monetary gains and losses by smokers of cigarettes. *Psychopharmacology (Berl)* 182 (4): 508–15.
490. Dallery, J., and B. R. Raiff. 2007. Delay discounting predicts cigarette smoking in a laboratory model of abstinence reinforcement. *Psychopharmacology (Berl)* 190 (4): 485–96.
491. Jaroni, J. L., S. M. Wright, C. Lerman, and L. H. Epstein. 2004. Relationship between education and delay discounting in smokers. *Addictive Behaviors* 29 (6): 1171–75.
492. Juliano, L. M., E. C. Donny, E. J. Houtsmuller, and M. L. Stitzer. 2006. Experimental evidence for a causal relationship between smoking lapse and relapse. *Journal of Abnormal Psychology* 115 (1): 166–73.
493. Epstein, D. H., and K. L. Preston. 2003. The reinstatement model and relapse prevention: A clinical perspective. *Psychopharmacology (Berl)* 168 (1–2): 31–41.
494. Katz, J. L., and S. T. Higgins. 2003. The validity of the reinstatement model of craving and relapse to drug use. *Psychopharmacology (Berl)* 168 (1–2): 21–30.
495. McKee, S. A., S. Krishnan-Sarin, J. Shi, T. Mase, and S. S. O'Malley. 2006. Modeling the effect of alcohol on smoking lapse behavior. *Psychopharmacology (Berl)* 189 (2): 201–10.
496. Hughes, J. R., J. P. Keely, R. S. Niaura, D. J. Ossip-Klein, R. L. Richmond, and G. E. Swan. 2003. Measures of abstinence in clinical trials: Issues and recommendations. *Nicotine & Tobacco Research* 5 (1): 13–25.

497. Lamb, R. J., A. R. Morral, K. C. Kirby, M. Y. Iguchi, and G. Galbicka. 2004. Shaping smoking cessation using percentile schedules. *Drug and Alcohol Dependence* 76 (3): 247–59.
498. Field, M., K. Mogg, and B. P. Bradley. 2005. Alcohol increases cognitive biases for smoking cues in smokers. *Psychopharmacology (Berl)* 180 (1): 63–72.
499. Hutchison, K. E., M. C. Rutter, R. Niaura, R. M. Swift, W. B. Pickworth, and L. Sobik. 2004. Olanzapine attenuates cue-elicited craving for tobacco. *Psychopharmacology (Berl)* 175 (4): 407–13.
500. Sinha, R., M. Garcia, P. Paliwal, M. J. Kreek, and B. J. Rounsaville. 2006. Stress-induced cocaine craving and hypothalamic-pituitary-adrenal responses are predictive of cocaine relapse outcomes. *Archives of General Psychiatry* 63 (3): 324–31.
501. Kosten, T. R., B. E. Scanley, K. A. Tucker, A. Oliveto, C. Prince, R. Sinha, M. N. Potenza, P. Skudlarski, and B. E. Wexler. 2006. Cue-induced brain activity changes and relapse in cocaine-dependent patients. *Neuropsychopharmacology* 31 (3): 644–50.
502. Haney, M., and R. Spealman. 2008. Controversies in translational research: Drug self-administration. *Psychopharmacology (Berl)* 199 (3): 403–19.
503. Brauer, L. H., F. M. Behm, J. D. Lane, E. C. Westman, C. Perkins, and J. E. Rose. 2001. Individual differences in smoking reward from de-nicotinized cigarettes. *Nicotine & Tobacco Research* 3 (2): 101–9.

Epidemiological and Methodological Considerations

The first chapter of this part of the monograph explores the usefulness of epidemiologically defined phenotypes of tobacco use for genetic studies. Three analyses are presented that demonstrate the correlation between specific transition points along the smoking cessation trajectory with other self-reported measures of smoking and related behaviors. Subsequent chapters discuss a potential etiological architecture for genetic and environmental influences on smoking phenotypes as well as an ontological approach for hierarchical modeling of joint actions of genes.

10

Epidemiological Analysis of Variation in Phenotypic Definitions: A Proof of Concept Using an Example of a Cessation Phenotype

Kay Wanke and Erik Augustson

Traditional behavioral genetic studies based on phenotypes of observed smoking behavior often lack specificity and are subject to classification bias. This chapter explores the use of an epidemiological approach for modeling smoking phenotypes, based on transitions along the smoking trajectory and prior exposure, which may yield more accurate phenotype definitions for future genetic studies.

Three studies are presented that examine improved phenotypes in relation to numerous variables for smoking behavior and comorbid conditions:

- *An analysis of male Finnish smokers from the Alpha-Tocopherol, Beta-Carotene Cancer Prevention Study (ATBC), examining the behavior of sustained quitters, relapsers, and never quitters relative to several baseline variables involving smoking history, behavioral/psychological symptoms, and alcohol use*
- *Cross-sectional data from the Tobacco Use Supplement to the U.S. Census Bureau's Current Population Survey (TUS-CPS), comparing sustained quitters, relapsers, smokers with no quitting history, and sustained quitters on measures of smoking behavior and nicotine dependence*
- *Data from the Third National Health and Nutrition Examination Survey (NHANES III) data set, comparing smoking subgroups on the basis of consumption levels and quit attempts with independent variables involving alcohol use, insomnia, and depression*

The results of these analyses demonstrated substantial variations in measured variables between these more tightly controlled phenotypes. Results such as these lend support to the idea of creating more specific, epidemiologically based phenotypes of tobacco use, which, in turn, may correlate more closely with genetic variations.

Introduction

The overall goal of this chapter is to demonstrate the utility of epidemiological approaches for defining phenotypes by narrowing the inclusion criteria, and thereby, it is hoped, reducing misclassification bias. Specifically, a series of analyses explore if changes in phenotype definition affect key indicators of the smoking behavior of interest. The analyses presented here use sustained cessation as an exemplar behavior. This chapter contributes to the discussion of various approaches to defining phenotypes, which is a crucial element of the questions this monograph addresses. The analyses in this chapter will provide an example of how epidemiology can play an active role in understanding smoking behavior and the impact of genetic factors.

A long-standing and solid literature supports the role of genetic factors in smoking behavior,¹⁻⁴ and subsequent linkage studies continue to provide highly suggestive findings.⁵⁻⁸ A review by Munafó and colleagues⁹ found that despite this foundation, overall behavioral genetic studies of smoking have produced only a limited body of consistent results. In part, this likely reflects the multiple influences associated with smoking, including the potential additive effects of a large number of genes. However, this lack of solid findings regarding the impact of specific genes is also indicative of a number of methodological limitations within the field of behavioral genetic studies of tobacco use.⁹ Among the various identified obstacles to progress in the field is the key observation that smoking phenotypes have typically been poorly defined with respect to important behaviors and exposures, leading to a high likelihood of classification bias.⁹ Of particular concern is the inclusion of individuals who have been either only minimally exposed or unexposed to nicotine.¹⁰ The potential importance is highlighted by findings from

studies that have attempted to remediate this methodological problem by using more restrictive phenotypes.¹¹⁻¹⁴ In doing so, it appears that convergent results are beginning to be demonstrated.

Although studies of genetic factors of smoking behavior are a prominent area of research in which phenotypic definitions are crucial, this same fundamental problem exists in purely behavioral and epidemiological studies as well. Some studies have used strategies similar to that presented here to address this issue.¹⁵⁻¹⁷

Given the historic limitations in the field and the potential advances indicated by attempts to remediate the issues associated with defining phenotypes, a delineated method for doing so may be beneficial to consider. To address the underlying methodological limitations of many approaches to defining phenotypes, a specific strategy is proposed. It is suggested that phenotypes be defined with two features: (1) behavior identified by transitions along the smoking trajectory and (2) adequate exposure to a precursor of the behavior of interest. The rationale for using each of these is discussed below.

Transitions along the Smoking Trajectory

Smoking, like many behaviors, can be conceptualized as occurring along a trajectory, beginning with experimentation, and moving on to initiation, regular use, dependence, and then attempted cessation with success or relapse (figure 10.1). Common points of clinical concern (e.g., initiation, dependence) are labeled on the trajectory. Figure 10.1 shows examples of how various stages along the smoking trajectory represent choice points at which one could define a phenotype based on smoking behavior (e.g., lifetime smoked <100 cigarettes versus ≥100 cigarettes). Hypothesized potential underlying genetic influences are also linked to areas along

Smoking Phenotypes: The Perils of Casting Too Broad a Net

Traditionally, phenotypes for many behavioral genetic studies have been based on broad classifications of behavior such as never versus ever smokers, current versus former smokers, or current smokers versus nonsmokers, which includes both former and never smokers. Although these types of phenotypes have strong face validity, there are a number of serious drawbacks, including the potential for biasing of results due to misclassification. One of the most significant problems with these phenotypes is that they are uninformative regarding exposure to the behavior of interest and, indeed, lack specificity regarding what that behavior may be for the analysis.^a Research by Saccone and colleagues^b found changes in their results when unexposed individuals were removed from analyses of a smoking phenotype based on sib-pairs. Although changes in sample size may have affected the findings, the potential impact of including minimally and unexposed individuals in behavioral genetic studies of substance abuse represents a serious methodological issue in need of further investigation.^a Given this, perhaps it should not come as a surprise that these traditional phenotypes have been problematic in behavioral genetic studies. As noted elsewhere in this chapter, the potential effect of poorly defined phenotypes is demonstrated by studies that have used phenotypes more specifically defined by a particular smoking behavior.^{c,d,e,f}

^aSaccone, N. L., E. L. Goode, and A. W. Bergen. 2003. Genetic analysis workshop 13: Summary of analyses of alcohol and cigarette use phenotypes in the Framingham Heart Study. *Genetic Epidemiology* 25 Suppl. 1: S90–S97.

^bSaccone, N. L., R. J. Neuman, S. F. Saccone, and J. P. Rice. 2003. Genetic analysis of maximum cigarette-use phenotypes. *BMC Genetics* 4 Suppl. 1: S105.

^cBierut, L. J., P. A. Madden, N. Breslau, E. O. Johnson, D. Hatsukami, O. F. Pomerleau, G. E. Swan, et al. 2007. Novel genes identified in a high-density genome wide association study for nicotine dependence. *Human Molecular Genetics* 16 (1): 24–35.

^dSaccone, S. F., A. L. Hinrichs, N. L. Saccone, G. A. Chase, K. Konvicka, P. A. Madden, N. Breslau, et al. 2007. Cholinergic nicotinic receptor genes implicated in a nicotine dependence association study targeting 348 candidate genes with 3713 SNPs. *Human Molecular Genetics* 16 (1): 36–49.

^eSaccone, S. F., M. L. Pergadia, A. Loukola, U. Broms, G. W. Montgomery, J. C. Wang, A. Agrawal, et al. 2007. Genetic linkage to chromosome 22q12 for a heavy-smoking quantitative trait in two independent samples. *American Journal of Human Genetics* 80 (5): 856–66.

^fUhl, G. R., Q. R. Liu, T. Drgon, C. Johnson, D. Walther, and J. E. Rose. 2007. Molecular genetics of nicotine dependence and abstinence: Whole genome association using 520,000 SNPs. *BMC Genetics* 8:10.

the trajectory. As shown in figure 10.1, a number of factors are likely to be more or less associated with behavior at a specific point on the trajectory and with transition to the next stage. Therefore, it is crucial that researchers identify the specific point they are studying and link this point to a specific behavior of interest. For example, given this trajectory of behavior, one might be interested in factors, including potential underlying genetic factors, specifically associated with the question of why some people progress beyond initiation to dependence and others do not. As such,

multiple phenotypes of interest are defined by transitions along the trajectory within the broad category of smoking.

Considering specific points along the smoking trajectory suggests that inconsistent findings within the tobacco behavioral genetic literature could be, in part, accounted for by differences in which behavior was studied. If the impact of a genetic trait on smoking varies depending on the specific behavioral point on the trajectory, then a given polymorphism associated with the genetic influence may

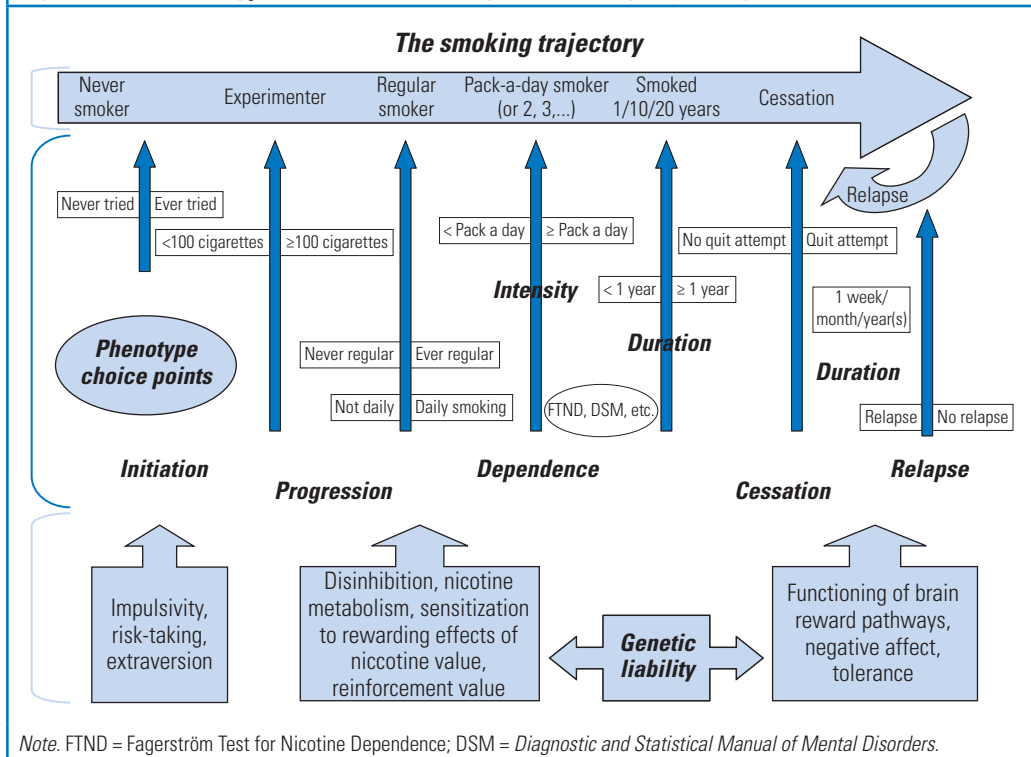
Figure 10.1 Phenotype Choice Points along the Smoking Trajectory

or may not be associated with “smoking.” For example, if nicotine metabolism were associated with nicotine dependence, but not with risk of relapse, then polymorphisms associated with nicotine metabolism would be positively associated with smoking only in studies in which nicotine dependence was the basis of the phenotype.

Defining phenotypes based on choice points along the trajectory also suggests that by considering the mechanism by which a gene was believed to influence smoking behavior, one could hypothesize a priori its potential as a candidate gene for that specific behavior along the smoking behavior trajectory. For example, Lerman and colleagues¹⁸ reported the results of a trial investigating the role of the *OPRM1***N40D* variant on cessation. They found that smokers with the variant allele were significantly more likely to be abstinent at the end of the trial and to

report fewer symptoms of mood disturbance and less weight gain postcessation. These results suggest that at least some functions of the *OPRM1* gene as it relates to smoking behavior are potentially implicated specifically in the maintenance of smoking abstinence.

Consideration of Adequate Exposure

The second feature used by this approach to define phenotypes is to ensure that adequate exposure occurred. Lack of exposure has been identified as a potentially significant methodological challenge that may be particularly important in studies of smoking behavior.¹⁰ For the purposes of phenotype definition, it is suggested that adequate exposure in all individuals used in a study can be accounted for by including only those who have had exposure to a

Figure 10.2 Example of Phenotypic Comparison for Drug Response Using the Proposed Approach

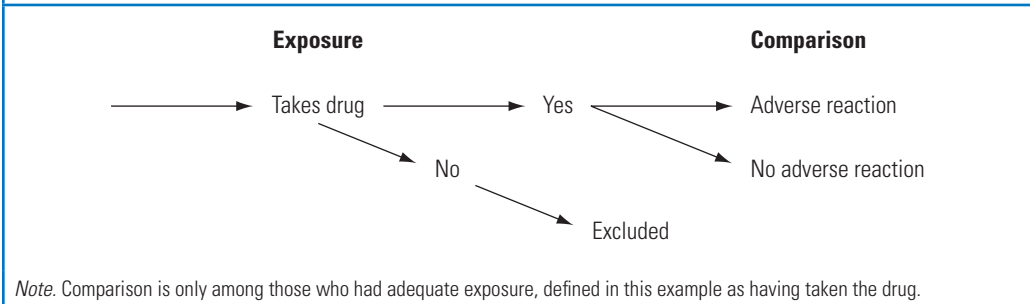
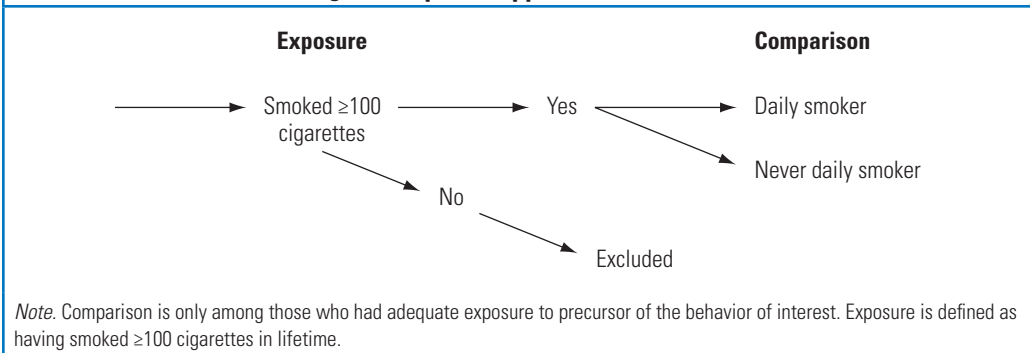

Figure 10.3 Example of Phenotypic Comparison for Progression to Daily Smoking (Behavior of Interest) Using the Proposed Approach



precursor of the behavior of interest along the smoking trajectory. Conversely, all individuals who have not passed through the previous stage on the trajectory must be excluded. A hypothetical example from pharmacology highlights the importance of appropriate exposure. If the goal of the study were to identify features of individuals at risk of adverse reactions to a medication, one would administer the medication to all of the participants and then compare the study measures among those who did versus those who did not have an adverse reaction. Any individual not taking the drug would be uninformative regarding possible adverse reactions (figure 10.2)

This point is relevant to behavioral genetic studies of smoking behavior. For example, in attempting to understand factors associated with progression

from experimentation to daily smoking, individuals who had never experimented with cigarettes would be uninformative. That is, their risk to progress to regular use would be unknown because they had never been exposed.¹⁰ So the appropriate analysis would compare individuals who progressed to regular smoking versus those who did not, but only among those individuals who had experimented with cigarettes based on a specific “exposure”—for example, had smoked ≥ 100 cigarettes in their lives (figure 10.3). However, a common phenotype previously used in such studies is current smokers versus nonsmokers;⁹ the latter includes individuals who have experimented, but did not progress, and individuals who were never smokers. Similarly, in attempting to identify factors associated with relapse versus successful cessation, one would include only smokers who had made a quit

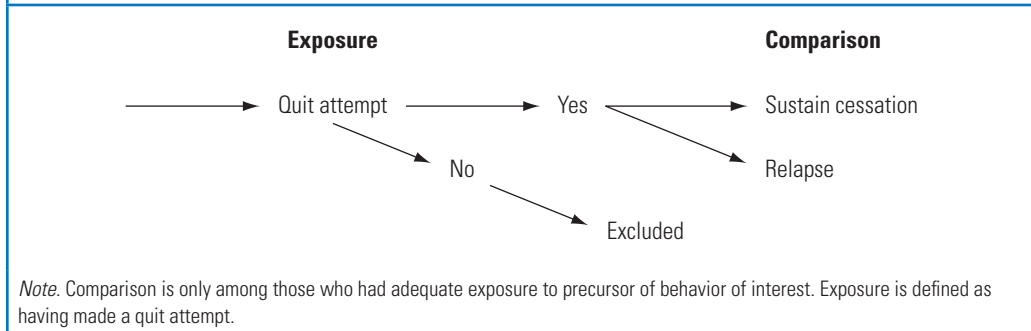
Figure 10.4 Example of Phenotypic Comparison for Sustained Smoking Cessation (Behavior of Interest) Using the Proposed Approach

attempt as only these individuals would be informative (figure 10.4). However, the classic comparison is often between former smokers and current smokers,⁹ which includes smokers who have never tried to quit.

The Proposed Approach

Strategy and Considerations

Given the above, the approach presented here proposes that phenotypes be formulated in the following way. First, a behavior of interest associated with a specific stage of the smoking continuum must be defined. Second, the comparison group must consist of individuals who have had adequate exposure to the behavior of the previous stage along the continuum. The remainder of this chapter focuses on an example using sustained smoking cessation as the phenotype of interest. Smoking cessation is defined by two separate behaviors: initiation of a quit attempt and sustaining that quit attempt.¹⁹ This then represents a choice point that can be used to define inclusion in the phenotype analysis. The behavior of interest in the example used here is sustaining cessation. Adequate exposure to a precursor of the behavior of

interest is defined by having made a quit attempt. Thus, this phenotype is based on a comparison of individuals who do and do not maintain cessation only among smokers who have made a quit attempt (figure 10.4).

As an additional consideration, given that epidemiology is fundamentally based on tracking behaviors associated with the distribution of public health outcomes, this approach focuses on observable behavior. (For additional examples and further discussion of behavioral taxonomies, see Gifford and Humphreys,²⁰ Gifford and colleagues,²¹ Silva,²² and Follette;^{23,24} also see other articles in the December 1996 special issue of the *Journal of Consulting and Clinical Psychology*.) In the case of behavioral genetics, phenotypes function as a means to define categories of people who have certain features and behaviors. This is distinct from identifying why people have those features. The distinction is important in that it is inappropriate to include elements in the definition of a phenotype that address underlying causal differences between groups (see further discussion in Silva²² and Skinner²⁵). The underlying causes of why groups differ on the outcome of interest—in this case, genetic influences—are what the comparisons of phenotypes hope to elucidate. So, it becomes a circular argument to include them in the definition of the phenotype itself. Hypothesized underlying

causal mechanisms are appropriate for defining endophenotypes (see other chapters in this volume), which serve to bridge the phenotype-gene causal associations.

Testing the Approach

The fundamental assumption behind the argument for using more tightly defined phenotypes is that the detection of genetic influences on key smoking behaviors will be substantially improved; that is, reducing classification bias improves the ability to detect associations. Although this logic seems sound, it is an empirical question, and analyses are needed to justify that this approach truly does improve the ability to find replicable associations. Ultimately, the test of this question will need to be carried out using genotyping of various phenotypes within a single data set. However, this methodology is resource intensive, and the “proof of concept” analyses performed in this chapter are a necessary starting point.

Simply stated, the basic research question is, does it matter if “improved” phenotypes are used or not? For the purposes of this chapter, evidence of “improvement” is demonstrated when, as the phenotype changes, factors associated with the behavior of interest change in an a priori, potentially clinically meaningful direction. The rationale is that changes in factors associated with the phenotype are indicative of changes in the underlying endophenotype and genes associated with the behavior. In the examples presented in this chapter, “improved” definitions are detected by finding changes in characteristics predictive of smoking cessation that vary as the definition of the comparison groups changes. The characteristics chosen to serve as independent variables for the analyses presented in this chapter have been previously associated or may be associated with ability to sustain smoking cessation: (1) markers of nicotine dependence^{26–30} and (2) the presence of comorbid conditions

including heavy alcohol use,^{31,32} anxiety/depression,^{33–36} and insomnia.^{37,38}

Epidemiology offers a potentially powerful set of methodological tools for addressing the importance of phenotypic definition. Various phenotypes can be defined on the basis of clearly observable behaviors, and analyses can be performed to assess how key indicators and outcomes change as the phenotypic definitions change. In addition, there are multiple, large-scale data sets based on a variety of samples that have measures of smoking across the behavioral continuum along with a wide array of potential covariates. This allows for considering a number of comparison phenotypes within a data set as well as potentially confirming the findings across data sets.

To test this approach, a series of analyses across multiple data sets are presented comparing different definitions of smoking cessation (table 10.1). Multiple data sets were analyzed for a variety of reasons. First, by applying the strategy to a number of different data sets, a basic replication of the validity of the approach was performed. Second, each of these data sets had varying methodological strengths and weaknesses; considering the impact of phenotypic variation across the data sets provided broader coverage across the methodologies of the surveys. Next, although all of these data sets assessed smoking behavior, no large-scale data sets exist that were designed to focus on smoking behavior. As such, none of the smoking assessments are comprehensive. Analyzing multiple data sets allowed for covering some of the gaps present in any single survey. Each survey also assessed different aspects of sustained cessation and independent variables of potential interest. Again, performing an analysis across the data sets allowed for broader coverage of variables associated with nicotine dependence and comorbid conditions, as well as definitions of cessation. Lastly, because of methodological differences in each data set, it was possible

Table 10.1 A Comparison of the Data Sets and Variables Used in the Analyses Presented in This Chapter

	ATBC	TUS-CPS	NHANES III
Year collected	1985–1993	2003	1988–1994
Sample size per group	~1,380	1,500	Varies
Groups			
Sustained quitters	X	X	X
Current smokers		X	X
Relapsers	X	X	X
Never quitters	X	X	
Independent variables			
Age at smoking onset	X	X	X
Years smoked	X	X	X
Cigarettes per day	X	X	X
Pack-years	X		
Inhale when smoking	X		
Nicotine dependence		X	
Time to first cigarette		X	
Alcohol use/history	X		X
Anxiety	X		
Depression	X		X
Insomnia	X		X
Problems concentrating	X		

Note. ATBC = Alpha Tocopherol, Beta-Carotene Cancer Prevention Study; TUS-CPS = Tobacco Use Supplement to the U.S. Census Bureau's Current Population Survey; NHANES III = Third National Health and Nutrition Examination Survey; Pack-years = the number of years of smoking multiplied by the number of packs of cigarettes smoked per day.

to vary the specific analyses that were performed to broaden the test of this general strategy for defining phenotypes.

Method

General Analytic Approach

The primary objective of these analyses was to perform a proof of concept of the approach to defining phenotypes laid out in this chapter. This was done by comparing the results of between-group analyses with smoking phenotype as the dependent variable and measures of nicotine dependence and comorbid conditions as the independent variable. Individuals who had

successfully sustained cessation were the primary phenotype. With the use of classic contingency table analysis, comparisons were performed between those who had sustained cessation and either (1) phenotypes defined by more traditional approaches or (2) extreme examples of phenotypes that would not meet the inclusion criteria proposed here (i.e., individuals who had never made a quit attempt). The analyses were then repeated using the proposed strategy of “improved” phenotypic definition to assess how the results change. In general, results presented are based on χ^2 and t -test univariate analyses by using data from the ATBC, the TUS-CPS, and NHANES III (table 10.1). Each of these data sets and analyses is discussed separately below.

ATBC Analyses

Data Source

The first set of analyses presented in this chapter was performed by using a sample drawn from the ATBC.³⁹ Between 1985 and 1993, this longitudinal, population-based chemoprevention trial enrolled 29,133 Finnish male current smokers between the ages of 50 and 69 years into a randomized primary prevention trial to assess whether alpha-tocopherol or beta-carotene would reduce cancer incidence. At baseline, all individuals in the ATBC study smoked at least five cigarettes per day and were generally in good health. Median age at entry into the study was 57 years, the median number of cigarettes smoked per day (CPD) was 20, and the reported median years of smoking was 36. Exclusion criteria for the ATBC included a history of cancer, significant cardiac diagnoses, cirrhosis, chronic alcoholism, and significant psychiatric diagnoses. Diagnosis of lung cancer during the trial was an additional exclusion for the analyses because of its impact on smoking cessation^{40,41} and high mortality.

Within the ATBC, extensive medical history data based on participant self-report and medical examination were collected at baseline, and participants were followed for five to eight years with three scheduled follow-up visits per year (i.e., every four months). At each follow-up, participants were queried about health and smoking status since their last visit.

Phenotype Comparisons

All individuals in the ATBC were established heavy smokers, so the focus of analyses within this data set was on how the results might vary between phenotypic definitions that did and did not consider the issue of adequate exposure. Three groups were defined: sustained quitters, relapsers,

and never quitters. Sustained quitters and relapsers were exposed to the key behavior of having made at least one quit attempt during the trial.¹⁵ Sustained quitters were defined as men who reported not smoking at all for at least 10 consecutive follow-up visits, equal to 40 months or more of abstinence. Relapsers were men who reported that they made a quit attempt but sustained it for no more than one consecutive interval and had a confirmed relapse. Of the original ATBC sample, approximately 30% of the participants made a quit attempt during the trial. Of these, 1,379 men met the definition of a sustained quitter and 1,388 met the definition of a relapser. They were therefore included in this analysis. An additional group of 1,380 men who did not make a quit attempt during the trial were randomly selected to serve as the never quitter comparison group.

Comparison of the never quitters to sustained quitters served as the phenotype approach that did not address the issue of exposure to precursors of the behavior of interest, allowing for exploration of the potential impact of misclassification of previous quit history. A more tightly defined phenotypic comparison was made of relapsers versus sustained quitters. In addition, relapsers were compared to never quitters to assess if differences among current smokers based on quit history were present.

Independent Variables

The analysis presented here is based solely on the relationship of baseline variables to sustained cessation. Variables included in this analysis were those associated with smoking history, behavioral/psychological symptoms, and alcohol use. Smoking history included age of smoking onset, years smoked, cigarettes per day, pack-years,* and frequency of inhaling while smoking. Behavioral and psychological

symptoms reported as having occurred during the last four months included anxiety, depression, problems concentrating, and insomnia. Alcohol consumption was converted to mean grams per day on the basis of reported average number of drinks consumed daily during the last year.

Analysis

For each comparison, unadjusted analyses were performed on the basis of a classical contingency table analysis conducted using SAS 8.2.⁴² Reported *p*-values are based on either χ^2 for categorical variables or *t*-test for continuous variables.

ATBC Results

The results of the analyses of the ATBC comparisons are presented in table 10.2. Compared with sustained quitters, never quitters demonstrated heavier smoking histories, more current cigarettes per day, and were more likely to always inhale when smoking. Never quitters also reported more symptoms of coexisting comorbid conditions in that they drank more alcohol per day and were more likely to endorse experiencing depressed mood, problems concentrating, and insomnia during the last four months.

A similar general pattern was noted for sustained quitters compared to relapsers. Relapsers reported higher CPD, more pack-years, and being more likely to always inhale. Relapsers also reported drinking more alcohol per day and being more likely to endorse symptoms of anxiety, depression, and insomnia. However, closer examination of the data revealed that, although the general pattern of responding was similar, the differences between sustained quitters and the other two groups were more extreme for never quitters than for relapsers.

Further evidence of this pattern was demonstrated in the analysis of differences between relapsers and never quitters. Significant differences between relapsers and never quitters were found for all markers of nicotine dependence, as well as mean alcohol use per day, with never quitters always being more extreme. No significant difference between relapsers and never quitters was noted for any of the mood symptoms.

ATBC Discussion

These results suggest that sustained quitters, relapsers, and never quitters are distinct

Table 10.2 Results from the Analysis of the ATBC Study Data

	Never quitters <i>n</i> = 1,380	Relapsers <i>n</i> = 1,388	Sustained quitters <i>n</i> = 1,379
Age at smoking onset (mean)	19.1 ^{†††}	20.0	20.3
Years smoking (mean)	36.7 ^{†††}	33.9	33.4
Cigarettes per day (mean)	21.7 ^{†††}	19.1 ^{†††}	17.2
Pack-years (mean)	40.1 ^{†††}	33.0 ^{†††}	29.2
Always inhale (% yes)	55.3% ^{††††}	50.2% ^{††}	44.2%
Alcohol (mean grams/day)	19.6 ^{††}	17.0 ^{†††}	12.5
Feelings of anxiety (% yes)	22.4%	23.7% [†]	19.9%
Feelings of depression (% yes)	15.1% [†]	15.0% [†]	11.2%
Problems concentrating (% yes)	12.5% [†]	11.4%	9.3%
Insomnia (% yes)	20.1% ^{†††}	19.7% ^{†††}	13.6%

Note. Comparison group vs. sustained quitters: [†]*p* ≤ 0.01; ^{††}*p* ≤ 0.001; ^{†††}*p* ≤ 0.0001. Relapsers vs. never quitters: [†]*p* ≤ 0.01.

phenotypic categories in that markers of nicotine and alcohol dependence varied across the groups. At first, it was suspected that men from this sample with no quit history—that is, never quitters—had an “unknown” liability to relapse and, therefore, hypothetically would fall in the middle of the continuum of “relapse liability,” with relapsers and sustained quitters anchoring the ends of this continuum. This assumed that never quitters were ultimately made up of individuals who would become sustained quitters or relapsers should they make a quit attempt. That never quitters were more extreme than relapsers on markers of dependence suggests that they may in fact have greater liability to relapse and that not making a quit attempt during the eight years of the ATBC trial may be related to their dependence. Knowledge of quit history before entering the trial might help to further understand this possibility, but the ATBC did not collect this information, so prior experience with quitting is unknown.

Both relapsers and never quitters differed from sustained quitters on symptoms of mood disruption, but not from each other on this cluster of symptoms. Although there are a variety of potential interpretations, it is interesting to note that these symptoms are similar to those often experienced during withdrawal from nicotine.⁴³ It may be that the higher frequency of the symptoms at baseline has important implications for whether an individual will attempt to quit smoking and the subsequent risk for relapse.

The ATBC data set has a number of features that contribute to its usefulness in this series of analysis. The trial has a large sample such that appropriate power was available for the analyses. The sample was followed for an extended period with excellent follow-up rates. This allowed for considering sustained cessation across a time frame much longer than is typically assessed. In addition, the ATBC was not

a smoking cessation trial, so it affords an opportunity to observe self-initiated cessation attempts and sustaining those attempts. The study also assessed a variety of variables of potential interest, allowing for analyses of comorbid conditions.

The ATBC data set has limitations in regard to the question of appropriate strategies to define phenotypes. Common across all data sets used in this study and cessation research in general, having made a quit attempt during the trial was based solely on self-report. Research suggests that individuals typically are truthful about smoking behavior in contexts in which no negative consequences are associated with smoking status. As the above-mentioned lack of data on prior cessation experience highlights, the ATBC was fundamentally a trial testing a nutritional cancer prevention intervention. As such, although all participants were established heavy smokers, available smoking variables are limited. The variable used to define cessation attempts is somewhat imprecise, especially in terms of accurate length of cessation in fewer than four-month intervals. No data are available regarding what resources may have been used during a reported quit attempt. This could clearly affect cessation success, although nicotine replacement therapy and other pharmacological interventions known to affect cessation success were not widely available or used during the time frame of the ATBC study. In addition, because of the lack of data regarding quit attempts before entering the trial, misclassification of quit history (the fundamental prior exposure variable) is still possible despite the long follow-up period during the trial. Given that all participants were heavy smokers, a limited range of smoking behaviors can be compared for the purposes of considering various phenotypes and the impact of varying definitions. Given some of these limitations, an effort was made to confirm the usefulness of this approach in two additional data sets: TUS-CPS and NHANES III.

TUS-CPS Analyses

Data Source

In a fashion similar to that performed in the ATBC, cross-sectional data from the 2003 TUS-CPS⁴⁴ were used in a second analysis investigating how varying phenotypic definitions may affect the results. The CPS, administered by the U.S. Census Bureau, uses a multistage probability sample design to produce reliable national and state estimates on labor force characteristics among the U.S. civilian noninstitutionalized population aged 15 years and older. Every three years since the 1980s, the National Cancer Institute and the Centers for Disease Control and Prevention sponsor the TUS to be conducted in conjunction with the CPS. The TUS collects data on tobacco use and related attitudes and practices among those who completed the CPS. In 2003, the TUS collected detailed data on smoking, former smoking, and quitting behaviors from approximately 250,000 respondents in the months of February, June, and November. Details of the sampling methods for the TUS-CPS are reported elsewhere.⁴⁵

Phenotype Comparisons

To mimic the above analyses using ATBC data and typical behavioral genetic studies focusing on specific homogeneous populations, a similar set of samples was selected, limited to white males. The sample size also was limited to 1,500 per group to approximate that used in the ATBC analysis and to reflect the sample size of the parameters that might be seen in a behavioral genetics study. In this case, four groups were defined to be used in the comparison: all current smokers (current), established daily smokers with and without a history of making a quit attempt (relapsers and no quit, respectively), and sustained quitters. Relapsers, no quit, and sustained quitters all had histories of being daily

smokers for at least five years, and sustained quitters reported having sustained cessation for one to five years. The current smoking group included respondents who indicated that they smoked “every day” or “some days.”

The analyses of current versus sustained quitters and no quit versus sustained quitters represented comparisons in which exposure to the precursor of the behavior of interest (having made a quit attempt) was not part of the phenotype definition. As in the analysis of the ATBC data, analysis of relapsers versus sustained quitters was the more tightly defined comparison. For each group, 1,500 white males were randomly selected, again to create a similar set of subsamples to that used for the ATBC analyses and behavioral genetic studies.

Independent Variables

The TUS-CPS includes questions associated with a variety of issues associated with smoking behavior and tobacco control. For this analysis, measures were used of number of CPD, age of onset of regular smoking, years smoked, time to first cigarette in the morning, and items from the Shiffman Nicotine Dependence Syndrome Scale (NDSS). In addition to CPD and age of onset for regular smoking, time to first cigarette was used as an indicator of nicotine dependence. Evidence from factor analysis strongly supports the use of this item as an overall marker for nicotine dependence,^{46–50} and it has previously been used in population-based surveys as an indicator of nicotine dependence.⁵¹ An abbreviated version of the NDSS^{52,53} is also available on the 2003 TUS-CPS and is asked of all current smokers and former smokers who have quit within five years. The TUS includes NDSS questions about difficulty delaying smoking, willingness to go out in a storm to get cigarettes, experiencing craving, and willingness to go outside to smoke even if it interferes with an activity. TUS scores these items on a two-point scale (1 = yes, 2 = no),

and the items were summed to provide a total with lower scores indicating less nicotine dependence.

Statistics

The analysis was conducted using SAS 8.2⁴² and SUDAAN 8.0.1.⁵⁴ SUDAAN was used to account for the complex sample design and the weights of the respondents. Standard contingency table analysis and univariate techniques were used in this analysis. All variables presented from this analysis are continuous, and reported *p*-values are based on *t*-tests by using corrected standard errors derived from the SUDAAN PROC DESCRIPT procedure.

TUS-CPS Results

Results from this analysis are presented in table 10.3. Results from the less restrictive phenotypes are presented first. Compared to current smokers, sustained quitters demonstrated earlier age of onset, higher levels of CPD, longer smoking histories, and higher levels of nicotine dependence as assessed by the NDSS items. Time to first cigarette was not significantly different between current and sustained quitters. In contrast, sustained quitters had longer time to first cigarette, lower level of CPD, and a later age of onset compared to no quit smokers. Sustained quitters continued

to have a lower score on the NDSS items, indicating more frequent symptoms associated with nicotine dependence. Total years smoked was not significantly different between the two groups.

Analysis of relapsers versus sustained quitters, the more restrictive phenotype comparison, showed no significant difference between the groups on age of onset, CPD, and years smoked. Time to first cigarette was significantly different between relapsers and sustained quitters, with relapsers reporting a shorter mean interval to first cigarette. As with the other comparisons, sustained quitters had significantly lower scores on the NDSS items.

TUS-CPS Discussion

Findings from this analysis also point to the importance of tightly defined phenotypes in that the pattern of results varies depending on the comparison group. Use of the traditional comparison of all current smokers versus those who had sustained cessation for at least a year suggested possible higher levels of nicotine dependence as assessed by age of onset, CPD, years smoked, and total score on NDSS items. However, analysis of smokers who had progressed to established daily smoking but had not had exposure to the

Table 10.3 Results from the Analysis of TUS-CPS Data

	Current	No quit	Relapser	Sustained quitters
Age of onset	17.4*	16.4**	16.9	17.1
Cigarettes per day	19.9***	23.4**	20.9	21.2
Years smoked	23.2*	26.0	25.7	25.2
Minutes to first cigarette ^a	48.6	37.8**	43.5*	53.6
Nicotine dependence ^b	5.7***	5.6***	5.5***	5.1

Note. A randomly selected sample of 1,500 for each group was used in these analyses. All reported data are for mean response to variable. Comparison group versus sustained quitters: **p* ≤ 0.01; ***p* ≤ 0.001; ****p* ≤ 0.0001.

^aTime to first cigarette in the morning in minutes.

^bTotal score of abbreviated Nicotine Dependence Syndrome Scale items. Lower scale is indicative of higher level of nicotine dependence.

pre-behavior of interest (a quit attempt) suggested a reverse pattern, with later age of onset, fewer CPD, and longer interval to first cigarette, for the sustained quitters. Although there appeared to be a trend of an increase of markers of nicotine dependence among smokers from sustained quitters versus relapsers versus no quit smokers, in this sample no substantial evidence was found of differences between relapsers and sustained quitters except in time to first cigarette and score on the abbreviated NDSS.

The abbreviated NDSS is unique to the TUS among the data sets discussed in this chapter. Inconsistent with the general pattern of responses from the other variables used as markers for nicotine dependence, sustained quitters demonstrated more dependence than any of the other three groups. The reasons for this are unclear. One possibility is that the various groups of current smokers were asked about their current experience, while former smokers were asked to recall their previous experience of nicotine-dependence symptoms. Given that the sample of former smokers used in the analysis consisted of individuals who had quit at least one year ago, and up to five years ago, it may be that recall bias played a role in these discrepant results. It may also be that this finding is unique to the samples selected and not reflective of the overall national sample at large.

The TUS-CPS is useful for the proof of concept of the analytic approach being explored in this chapter in that it has a large sample size, includes a wide range of smokers in the sample, and contains a number of items specifically related to smoking behavior, including lifetime history of having made a quit attempt. However, given the cross-sectional nature of the data and the structure of the questions associated with smoking cessation, the survey is of limited use for tracking and understanding

cessation in detail. For example, no data are available regarding the details of quit history, such as the time frame of having made an attempt, unless it occurred within the last year, nor is information available on what cessation methods have been used across the person's quit history. Also, items from the NDSS are only asked of former smokers if they attempted to quit within the last five years. As with all the data sets used in this chapter, smoking status and quit history were based solely on self-report. In addition, the absence of questions related to potentially important comorbid conditions such as alcohol use and psychiatric symptoms represents an important gap in the types of questions that can be addressed by this survey.

A final analysis of this approach for defining phenotypes was performed by using the NHANES III data set. This nationally representative data set includes questions relevant to comorbid conditions and so can serve as a potential replication of some of the key findings associated with these behaviors found in the ATBC and TUS-CPS analyses. As an additional "proof of concept" in this analysis, the impact of changing comparisons was explored within a more traditional psychological/epidemiological study in which the selected sample was not based on gender or race/ethnicity, but rather, on groups selected from the population-based, nationally representative sample as a whole.

NHANES III Analyses

Data Source

This sample was selected from NHANES III, conducted from 1988 to 1994 on a cross-sectional representative sample of the U.S. civilian noninstitutionalized population aged two months and older living in households. Only individuals over the age of 18 years were included in the present analysis. Detailed descriptions of the

sample design and operation of the survey have been published elsewhere.⁵⁵ For this study, smoking information was obtained from the Household Adult Questionnaire administered in participants' homes.

Phenotype Comparisons

Three phenotypes were defined for the purposes of these analyses on the basis of increasingly restrictive inclusion criteria to reflect progression from regular use to cessation and relapse: all current daily smokers (daily, $n = 4,990$), current daily smokers who reported having made a quit attempt that lasted for at least one year (relapsers, $n = 1,157$), and former smokers who had been abstinent for longer than one year (sustained quitters, $n = 4,463$). The definitions were nonmutually exclusive, and daily smokers included all individuals who also qualified as relapsers. Of importance, the NHANES III only asked about quit attempts that lasted at least one year. Therefore, former smokers had to have sustained cessation for one year or longer to be included in the analyses, and the sample of relapsers included only individuals who had sustained cessation for at least one year before returning to daily smoking. For this analysis, daily smokers versus sustained quitters served as the comparisons of less restrictive phenotypes, while relapsers versus sustained quitters represented the more tightly defined phenotype.

Independent Variables

Similar to the previous analyses, available variables were selected associated with nicotine dependence and comorbid conditions believed to affect sustained cessation. Smoking variables included in the analysis were age of smoking onset, years smoked, and cigarettes per day. NHANES III also provides information about a wide range of health and behavioral symptoms. For this analysis, current mean drinks per day, history of heavy drinking (5+ drinks

per day), symptoms of insomnia, and lifetime diagnosis of major depression were included. Diagnosis of major depression was obtained from the Diagnostic Interview Schedule (DIS) administered as part of the NHANES III examination. Methodological constraints of the NHANES were such that only adults under the age of 40 years received the DIS, so reported results for lifetime history of major depression are limited to only the age range of 18–39 years.

Statistics

The analysis was conducted using SAS 8.2⁴² and SUDAAN 8.0.1.⁵⁴ SUDAAN was used to account for the complex sample design and the weights of the respondents. Standard contingency table analysis and univariate techniques were used in this analysis based on SUDAAN procedures. Preliminary analyses revealed large differences in current age among the three groups (data not shown). To address this, age adjustment was performed for all comparisons.

NHANES III Results

The results for the comparisons from NHANES III are presented in table 10.4. The general pattern was similar between daily smokers and relapsers when compared to sustained quitters with almost all comparisons being statistically significant. In considering the pattern of responses, some differences were noted. Relapsers reported higher cigarette consumption and were more likely to have histories of major depression and sleep disturbance. Relapsers had a slightly earlier age of regular smoking onset. Daily smokers reported higher mean daily alcohol consumptions and were slightly more likely to report a history of drinking five or more drinks per day.

NHANES III Discussion

Although the results of this analysis were not as clear, the potential usefulness of the

Table 10.4 Results from the Analysis of NHANES III Data

	Current smokers	Relapsers ^a	Sustained quitters ^b
Age onset (mean)	17.0***	16.9*	17.2
Years smoked (mean)	21.0***	20.0***	20.7
CPD (mean)	24.1***	27.7**	21.8
ETOH drinks per day (mean) ^c	4.4***	3.7**	2.7
HX 5+ ETOH drinks per day (% yes)	22.0***	20.6**	16.2
HX depression (% yes) ^d	11.6*	14.0*	7.6
HX insomnia (% yes) ^d	30.1	34.4*	25.2

Note. Data from all analyses are adjusted for age of participant. CPD = cigarettes smoked per day; ETOH = alcohol; HX = history. Comparison group versus sustained quitters: * $p \leq 0.05$; ** $p \leq 0.005$; *** $p \leq 0.0005$.

^aRelapsers were defined as current daily smokers who reported having a history of being abstinent for at least one year.

^bSustained quitters were former smokers who had been abstinent for at least one year.

^cOnly asked of individuals who reported alcohol use.

^dAge-restricted question.

more restrictive phenotype comparison appears generally supported. In general, similar patterns of statistical significance were seen among the two comparisons. However, the levels of significance are affected by the sizable sample size variations, and so it is difficult to interpret the meaningfulness of the statistical significance. Consideration of variation in patterns of responses suggests that there were differences between the two phenotypic approaches.

Although fewer markers than desirable of nicotine dependence were available in this data set, NHANES does provide indications of potential alcohol abuse/dependence and psychiatric comorbidity. Relapsers began smoking at an earlier age and smoked more cigarettes per day. They were more likely to be diagnosed with a history of major depression on the basis of report of symptoms and to report sleep disturbance. However, symptoms associated with alcohol abuse were more likely to be reported among the all daily smoker group. Thus, there appears to be an increase in markers of dependence and comorbidity as the comparison moves along the smoking trajectory and becomes increasingly restrictive, moving from all daily smokers

to smokers who relapsed despite having maintained abstinence for a year or longer. This suggests that (1) the role of nicotine and alcohol dependence potentially increases as one moves along the smoking trajectory and (2) analyses based on phenotypic definitions that do not consider progression along the smoking continuum are more likely to experience misclassification and thereby less likely to detect effects of potentially important genetic influences.

The distinctions between the phenotypes in the NHANES analysis may have been affected by a number of methodological issues. First, the analyses on this data set were not limited to only white men. It was not possible to explore any impact of this difference because of sample size limitations in the data set. A larger issue that likely had a significant impact is the restricted nature of the available cessation question. In NHANES III, the cessation question only asks about quit attempts that lasted at least one year, so no data are available on the much more typical quit attempt followed by relapse within a few weeks.⁵⁶ This suggests that a large number of individuals included in the daily smoker phenotype would have qualified as relapsers had more refined data been available. In addition, as individuals

who have maintained cessation for a year or more may be more similar to sustained quitters than individuals who relapse more quickly, differences between individuals who relapse versus those who sustain cessation may have been masked in the analysis of this data set.

Strengths of this data set include that NHANES is a large-scale, nationally representative sample, and the smokers included in the sample are more diverse than those seen in the ATBC sample of older, heavy smoking, Finnish men. NHANES also collects data on a number of potentially important comorbid conditions and provides a clinical diagnosis of major depression, rather than mere endorsement of symptoms, giving NHANES some advantages over both the TUS-CPS and the ATBC.

As noted above, a significant limitation of the NHANES data set is that cessation is only assessed if it lasts a year or longer. In addition, individuals may be in the process of sustaining cessation but have not reached the one-year mark, and so are dropped from the analysis. Next, the constraints of the NHANES methodology are such that not all individuals are asked all questions; in particular, this affects the depression data included in this sample. This may represent a significant issue in that the clinical structured interview for diagnosing major depression was not administered to individuals older than 39 years of age. Given that many individuals do not successfully quit smoking until they are in their 40s, the relation between depression and the behavior of interest (sustaining cessation) may be misrepresented. As with the ATBC, NHANES is not a smoking-specific survey, and the smoking questions are limited in scope. Lastly, the information provided in NHANES is self-reported and cross-sectional. However, despite these limitations, a number of findings consistent with those seen from the ATBC and TUS-CPS data sets emerged.

Summary

This chapter has presented an approach for refining phenotype definitions in the hopes of reducing “noise” associated with misclassification that subsequently reduces researchers’ ability to detect small but important genetic influences on smoking behavior. The strategy employed by this approach is based on two features. First, an observable behavior of interest that identifies a specific point along the smoking continuum must be chosen. Then, the comparison group must be defined such that it also has exposure to the precursor of the behavior of interest, excluding all individuals who have not progressed to that point on the smoking continuum. In the case of the example presented here, sustained smoking cessation was the behavior of interest, and the comparison group comprised smokers who had made a quit attempt but subsequently relapsed. In multiple data sets, the results of analyses of the improved phenotype were contrasted to classic, more broadly defined phenotypes and to phenotypes that lacked the key behavioral exposure.

This series of analyses has only considered a few of the possible comparisons that could have been used to validate the proof of concept for this approach. The goal of the current analyses was to demonstrate that even a small difference in definition could affect the subsequent results and the likelihood that associations between behavior and genes would be detected. As such, it was not the intent to fully explore this issue in each data set, although a number of interesting issues regarding the association of various markers of dependence and comorbidity were suggested.

Although it is argued that the phenotypes represent an improvement over those typically used in a number of studies, it may be that even more refined phenotypes are

needed to truly advance the field of genetics of smoking behavior. For example, some work has indicated that consideration of average CPD is insufficient to differentiate smokers.^{13,57–59} The results of a study by Saccone and colleagues¹³ on the genetic linkage of heavy smoking and chromosome 22q12 suggest that even more precise phenotypes may be needed. They found that use of maximum cigarettes smoked in 24 hours was a more useful indicator of nicotine dependence and a possible important marker of genetic variation among smokers.

In considering the data from across the three data sets, there were consistent limitations that may influence the findings. First, typical of epidemiological surveys, all data used were self-report. Although self-report of smoking status and quit history is consistently used in the literature and considered to be largely reliable in the context of most surveys, the findings would be strengthened if confirmation of smoking status was available.

Next, only limited information was available regarding the details of current and previous smoking behavior. This is a challenge across the available data sets that address smoking. Specific to this project on sustained cessation and relapse, no information was available on methods used to quit smoking. The techniques used to quit smoking could clearly have an impact on cessation success. If methods used varied significantly between sustained quitters and relapsers, the potential influence of the factors on which these analyses focused—that is, markers of nicotine dependence and comorbidity—would be misstated in the findings. This would affect efforts to identify the role of specific underlying genetics polymorphisms. However, the impact of this lack of available data is likely mitigated by the observation that two of the data sets (ATBC, NHANES) were collected during time frames when pharmacological cessation interventions were not widely in use.

Lastly, although the ATBC data set was available for longitudinal analysis, the ATBC is not primarily a project of tobacco use and has a restricted range of smoking behaviors and ages of participants. Longitudinal data from a study that focuses on smoking behavior would be extremely valuable, providing detailed information on smoking as it varies across time.

Despite the limitations of each data set and the varying methodology across the data sets, it was consistently found that changing the comparison groups (e.g., phenotypic definition) affected the nature of the results when considering potential markers of nicotine dependence and factors known to affect cessation. This indicates both that use of classic phenotypes can lead to misclassification errors and that the approach proposed based on trajectory and exposure has merit. Ultimately, the approach presented in this chapter needs to be tested within an analysis that includes genotyping to fully assess its value. Studies using more tightly defined phenotypes are demonstrating more convergent findings in support of the role of specific genes and smoking behavior.^{11–14} A more complete test of the approach presented here would examine if varying the phenotypes affected the genetic findings. However, the findings presented here support this approach and lend credence to its adoption.

Conclusions

1. More tightly defined phenotypes of smoking behavior that are based on transitions along the smoking trajectory and adequate prior exposure have the potential to reduce the classification bias and lack of specificity inherent in broader existing phenotypes such as current smoking status. These improved phenotypes, in turn, may lead to closer correlations between smoking behavior and genetic variables in future studies.

2. Studies involving both longitudinal and cross-sectional population data show measurable differences among improved phenotypes, including sustained quitters, relapsers, and never quitters, in key markers such as smoking history, other indices of nicotine dependence, and comorbid conditions such as psychological symptoms and alcohol use.
3. Refined nicotine-dependence phenotypes based on longitudinal characterizations of smoking patterns show promise for further testing in genetic studies in support of potential phenotype-gene causal associations for nicotine dependence. Research indicates the potential need for further refinement of such phenotypes.

References

1. Lessov, C. N., N. G. Martin, D. J. Statham, A. A. Todorov, W. S. Slutske, K. K. Bucholz, A. C. Heath, and P. A. Madden. 2004. Defining nicotine dependence for genetic research: Evidence from Australian twins. *Psychological Medicine* 34 (5): 865–79.
2. Li, M. D., R. Cheng, J. Z. Ma, and G. E. Swan. 2003. A meta-analysis of estimated genetic and environmental effects on smoking behavior in male and female adult twins. *Addiction* 98 (1): 23–31.
3. Madden, P. A., A. C. Heath, N. L. Pedersen, J. Kaprio, M. J. Koskenvuo, and N. G. Martin. 1999. The genetics of smoking persistence in men and women: A multicultural study. *Behavior Genetics* 29 (6): 423–31.
4. True, W. R., A. C. Heath, J. F. Scherrer, B. Waterman, J. Goldberg, N. Lin, S. A. Eisen, M. J. Lyons, and M. T. Tsuang. 1997. Genetic and environmental contributions to smoking. *Addiction* 92 (10): 1277–87.
5. Bergen, A. W., J. F. Korczak, K. A. Weissbecker, and A. M. Goldstein. 1999. A genome-wide search for loci contributing to smoking and alcoholism. *Genetic Epidemiology* 17 Suppl. 1: S55–S60.
6. Gelernter, J., C. Panhuysen, R. Weiss, K. Brady, J. Poling, M. Krauthammer, L. Farrer, and H. R. Kranzler. 2007. Genomewide linkage scan for nicotine dependence: Identification of a chromosome 5 risk locus. *Biological Psychiatry* 61 (1): 119–26.
7. Straub, R. E., P. F. Sullivan, Y. Ma, M. V. Myakishev, C. Harris-Kerr, B. Wormley, B. Kadambi, et al. 1999. Susceptibility genes for nicotine dependence: A genome scan and followup in an independent sample suggest that regions on chromosomes 2, 4, 10, 16, 17 and 18 merit further study. *Molecular Psychiatry* 4 (2): 129–44.
8. Swan, G. E., H. Hops, K. C. Wilhelmson, C. N. Lessov-Schlaggar, L. S. Cheng, K. S. Hudmon, C. I. Amos, et al. 2006. A genome-wide screen for nicotine dependence susceptibility loci. *American Journal of Medical Genetics Part B, Neuropsychiatric Genetics* 141 (4): 354–60.
9. Munafó, M. R., T. G. Clark, E. C. Johnstone, M. F. G. Murphy, and R. T. Walton. 2004. The genetic basis for smoking behavior: A systematic review and meta-analysis. *Nicotine & Tobacco Research* 6 (4): 583–98.
10. Saccone, N. L., E. L. Goode, and A. W. Bergen. 2003. Genetic analysis workshop 13: Summary of analyses of alcohol and cigarette use phenotypes in the Framingham Heart Study. *Genetic Epidemiology* 25 Suppl. 1: S90–S97.
11. Bierut, L. J., P. A. Madden, N. Breslau, E. O. Johnson, D. Hatsukami, O. F. Pomerleau, G. E. Swan, et al. 2007. Novel genes identified in a high-density genome wide association study for nicotine dependence. *Human Molecular Genetics* 16 (1): 24–35.
12. Saccone, S. F., A. L. Hinrichs, N. L. Saccone, G. A. Chase, K. Konvicka, P. A. Madden, N. Breslau, et al. 2007. Cholinergic nicotinic receptor genes implicated in a nicotine dependence association study targeting 348 candidate genes with 3713 SNPs. *Human Molecular Genetics* 16 (1): 36–49.
13. Saccone, S. F., M. L. Pergadia, A. Loukola, U. Broms, G. W. Montgomery, J. C. Wang, A. Agrawal, et al. 2007. Genetic linkage to chromosome 22q12 for a heavy-smoking quantitative trait in two independent samples. *American Journal of Human Genetics* 80 (5): 856–66.
14. Uhl, G. R., Q. R. Liu, T. Drgon, C. Johnson, D. Walther, and J. E. Rose. 2007. Molecular genetics of nicotine dependence and abstinence: Whole genome association using 520,000 SNPs. *BMC Genetics* 8: 10.
15. Augustson, E. M., K. L. Wanke, S. Rogers, A. W. Bergen, N. Chatterjee, K. Synder, D. Albanes, P. R. Taylor, and N. E. Caporaso. 2008. Predictors of sustained smoking cessation: A prospective analysis of chronic smokers from the Alpha-Tocopherol Beta-Carotene Cancer Prevention Study. *American Journal of Public Health* 98 (3): 549–55.
16. Augustson, E. M., and S. E. Marcus. 2004. Use of the Current Population Survey to characterize sub-populations of continued smokers: A national perspective on the “hardcore” smoker phenomenon. *Nicotine & Tobacco Research* 6 (4): 621–29.
17. Emery, S., E. A. Gilpin, C. Ake, A. J. Farkas, and J. P. Pierce. 2000. Characterizing and identifying “hard-core” smokers: Implications for further reducing smoking prevalence. *American Journal of Public Health* 90 (3): 387–94.
18. Lerman, C., E. P. Wileyto, F. Patterson, M. Rukstalis, J. Audrain-McGovern, S. Restine, P. G. Shields, et al. 2004. The functional mu opioid receptor (OPRM1)

- Asn40Asp variant predicts short-term response to nicotine replacement therapy in a clinical trial. *Pharmacogenomics Journal* 4 (3): 184–92.
19. Zhu, S.-H. 2006. Increasing cessation in the population: Quit attempts vs. successful quit attempts. Paper presented at the 13th World Conference on Tobacco OR Health, Washington, DC. <http://2006confex.com/uicc/wctoh/techprogram/P227.HTM>.
 20. Gifford, E., and K. Humphreys. 2007. The psychological science of addiction. *Addiction* 102 (3): 352–61.
 21. Gifford, E. V., J. B. Ritsher, J. D. McKellar, and R. H. Moos. 2006. Acceptance and relationship context: a model of substance use disorder treatment outcome. *Addiction* 101 (8): 1167–77.
 22. Silva, F. 1993. *Psychometric foundations and behavioral assessment*. Newbury Park, CA: Sage.
 23. Follette, W. C. 1997. A behavior analytic conceptualization of personality disorders: a response to Clark, Livesley, and Morey. *Journal of Personality Disorders* 11 (3): 232–41.
 24. Follette, W. C. 1996. Introduction to the special section on the development of theoretically coherent alternatives to the DSM system. *Journal of Consulting and Clinical Psychology* 64 (6): 1117–1119.
 25. Skinner, B. F. 1938. *The behavior of organisms: An experimental analysis*. Englewood Cliffs, NJ: Prentice Hall.
 26. Hymowitz, N., K. M. Cummings, A. Hyland, W. R. Lynn, T. F. Pechacek, and T. D. Hartwell. 1997. Predictors of smoking cessation in a cohort of adult smokers followed for five years. *Tobacco Control* 6 Suppl. 2: S57–S62.
 27. Coombs, R. B., S. Li, and L. T. Kozlowski. 1992. Age interacts with heaviness of smoking in predicting success in cessation of smoking. *American Journal of Epidemiology* 135 (3): 240–46.
 28. Shiffman, S., M. Hickcox, J. A. Paty, M. Gnys, J. D. Kassel, and T. J. Richards. 1996. Progression from a smoking lapse to relapse: Prediction from abstinence violation effects, nicotine dependence, and lapse characteristics. *Journal of Consulting and Clinical Psychology* 64 (5): 993–1002.
 29. Hyland, A., Q. Li, J. E. Bauer, G. A. Giovino, C. Steger, and K. M. Cummings. 2004. Predictors of cessation in a cohort of current and former smokers followed over 13 years. *Nicotine & Tobacco Research* 6 Suppl. 3: S363–S369.
 30. Nordstrom, B. L., T. Kinnunen, C. H. Utman, E. A. Krall, P. S. Vokonas, and A. J. Garvey. 2000. Predictors of continued smoking over 25 years of follow-up in the Normative Aging Study. *American Journal of Public Health* 90 (3): 404–6.
 31. Hays, J. T., D. R. Schroeder, K. P. Offord, I. T. Croghan, C. A. Patten, R. D. Hurt, D. E. Jorenby, and M. C. Fiore. 1999. Response to nicotine dependence treatment in smokers with current and past alcohol problems. *Annals of Behavioral Medicine* 21 (3): 244–50.
 32. Kalman, D., D. Tirsch, W. Penk, and H. Denison. 2002. An investigation of predictors of nicotine abstinence in a smoking cessation treatment study of smokers with a past history of alcohol dependence. *Psychology of Addictive Behaviors* 16 (4): 346–49.
 33. Hitsman, B., B. Borrelli, D. E. McChargue, B. Spring, and R. Niaura. 2003. History of depression and smoking cessation outcome: A meta-analysis. *Journal of Consulting and Clinical Psychology* 71 (4): 657–63.
 34. Black, D. W., M. Zimmerman, and W. H. Coryell. 1999. Cigarette smoking and psychiatric disorder in a community sample. *Annals of Clinical Psychiatry* 11 (3): 129–36.
 35. Lasser, K., J. W. Boyd, S. Woolhandler, D. U. Himmelstein, D. McCormick, and D. H. Bor. 2000. Smoking and mental illness: A population-based prevalence study. *JAMA: The Journal of the American Medical Association* 284 (20): 2606–10.
 36. Breslau, N., S. P. Novak, and R. C. Kessler. 2004. Psychiatric disorders and stages of smoking. *Biological Psychiatry* 55 (1): 69–76.
 37. Colrain, I. M., J. Trinder, and G. E. Swan. 2004. The impact of smoking cessation on objective and subjective markers of sleep: Review, synthesis, and recommendations. *Nicotine & Tobacco Research* 6 (6): 913–25.
 38. Smith, M. T., M. I. Huang, and R. Manber. 2005. Cognitive behavior therapy for chronic insomnia occurring within the context of medical and psychiatric disorders. *Clinical Psychology Review* 25 (5): 559–92.
 39. *Annals of Epidemiology*. 1994. The Alpha-Tocopherol, Beta-Carotene Lung Cancer Prevention Study: Design, methods, participant characteristics, and compliance. *Annals of Epidemiology* 4 (1): 1–10.

40. Gritz, E. R., R. Nisenbaum, R. E. Elashoff, and E. C. Holmes. 1991. Smoking behavior following diagnosis in patients with stage I non-small cell lung cancer. *Cancer Causes & Control* 2 (2): 105–12.
41. Cox, L. S., C. A. Patten, J. O. Ebbert, A. A. Drews, G. A. Croghan, M. M. Clark, T. D. Wolter, P. A. Decker, and R. D. Hurt. 2002. Tobacco use outcomes among patients with lung cancer treated for nicotine dependence. *Journal of Clinical Oncology* 20 (16): 3461–69.
42. SAS. 2007. SAS products & solutions: Statistical analysis. <http://www.sas.com/technologies/analytics/statistics/stat/index.html> (accessed December 19, 2008).
43. American Psychiatric Association. 2000. *Diagnostic and Statistical Manual of Mental Disorders: DSM-IV-TR*. 4th ed., text rev. Arlington, VA: American Psychiatric Publishing.
44. National Cancer Institute. 2007. What is the TUS-CPS? <http://riskfactor.cancer.gov/studies/tus-cps> (accessed December 19, 2008).
45. National Cancer Institute. 2007. Where can I get the TUS data, documentation, & questionnaires? <http://www.riskfactor.cancer.gov/studies/tus-cps/info.html> (accessed December 19, 2008).
46. Nonnemaker, J. M., and G. Homsí. 2007. Measurement properties of the Fagerström Test for Nicotine Dependence adapted for use in an adolescent sample. *Addictive Behaviors* 32 (1): 181–86.
47. Richardson, C. G., and P. A. Ratner. 2005. A confirmatory factor analysis of the Fagerström Test for Nicotine Dependence. *Addictive Behaviors* 30 (4): 697–709.
48. Haddock, C. K., H. Lando, R. C. Klesges, G. W. Talcott, and E. A. Renaud. 1999. A study of the psychometric and predictive properties of the Fagerström Test for Nicotine Dependence in a population of young smokers. *Nicotine & Tobacco Research* 1 (1): 59–66.
49. Radzius, A., J. J. Gallo, D. H. Epstein, D. A. Gorelick, J. L. Cadet, G. E. Uhl, and E. T. Moolchan. 2003. A factor analysis of the Fagerström Test for Nicotine Dependence (FTND). *Nicotine & Tobacco Research* 5 (2): 255–40.
50. Etter, J. F., T. V. Duc, and T. V. Perneger. 1999. Validity of the Fagerström Test for Nicotine Dependence and of the Heaviness of Smoking Index among relatively light smokers. *Addiction* 94 (2): 269–81.
51. Hyland, A., S. Garten, G. A. Giovino, and K. M. Cummings. 2002. Mentholated cigarettes and smoking cessation: Findings from COMMIT. Community Intervention Trial for Smoking Cessation. *Tobacco Control* 11 (2): 135–39.
52. Shiffman, S., and M. A. Sayette. 2005. Validation of the Nicotine Dependence Syndrome Scale (NDSS): A criterion-group design contrasting chippers and regular smokers. *Drug and Alcohol Dependence* 79 (1): 45–52.
53. Shiffman, S., A. Waters, and M. Hickcox. 2004. The Nicotine Dependence Syndrome Scale: A multidimensional measure of nicotine dependence. *Nicotine & Tobacco Research* 6 (2): 327–48.
54. RTI International. 2007. About SUDAAN. <http://www.rti.org/sudaan/page.cfm?nav=901>.
55. National Center for Health Statistics. 1994. Plan and operation of the Third National Health and Nutrition Examination Survey, 1988–94. Series 1: Programs and collection procedures. *Vital and Health Statistics* 32:1–407.
56. Hughes, J. R., J. Keely, and S. Naud. 2004. Shape of the relapse curve and long-term abstinence among untreated smokers. *Addiction* 99 (1): 29–38.
57. Bergen, A. W., X. R. Yang, Y. Bai, M. B. Beerman, A. M. Goldstein, and L. R. Goldin. 2003. Genomic regions linked to alcohol consumption in the Framingham Heart Study. *BMC Genetics* 4 Suppl. 1: S101.
58. Goode, E. L., M. D. Badzioch, H. Kim, F. Gagnon, L. S. Rozek, K. L. Edwards, and G. P. Jarvik. 2003. Multiple genome-wide analyses of smoking behavior in the Framingham Heart Study. *BMC Genetics* 4 Suppl. 1: S102.
59. Saccone, N. L., R. J. Neuman, S. F. Saccone, and J. P. Rice. 2003. Genetic analysis of maximum cigarette-use phenotypes. *BMC Genetics* 4 Suppl. 1: S105.

Incorporating Social Context into Genetic Studies of Nicotine Dependence

Richard Rende, David V. Conti, Stephen E. Gilman, and Cheryl Slomkowski

Tobacco use takes place within a social context that has been shown to interact with genetic factors to influence the definition and measurements of phenotypes and endophenotypes for nicotine dependence. This chapter examines available research and future trends related to social context factors that could inform subsequent genetic studies of smoking, including

- *Macrocontextual factors ranging from distal measures such as culture and socioregional factors to more proximal measures such as detailed data on socioeconomic status*
- *Microcontextual factors such as smoking in specific interpersonal relationships, including findings from the Nonshared Environment in Adolescent Development Project studying twins and siblings*
- *Integrated proximal indicators of both macro- and microcontext such as ecological momentary assessment*

Available evidence indicates that social context can have a clear impact on the heritability of smoking and many of its component traits. There is a growing case for such gene-environment interplay to become part of a broader matrix of etiological architectures employed in future genetic research on nicotine dependence.

Introduction

This chapter focuses on *why* the incorporation of social contextual influences could represent a core strategy for genetic studies of nicotine dependence—a complex phenotype that arises within socially defined (and in some cases socially controlled) contexts¹—and *how* newer methodologies can be used to gain better traction on social contextual influences. The emphasis is on “social contextual” rather than “environmental” influences because the environment in the behavioral genetic paradigm includes any factor that is not, strictly speaking, heritable (and thus may include an extraordinary range of potential etiological contributors including biological influences). The working approach to social context taken in this chapter is simply to consider a small range of factors, typically thought of as part of the social environment, that represent putative influences on the developmental pathways to nicotine dependence and that have been, or could easily be, considered in either behavioral or molecular genetic research. The focus is on specific examples of social contextual factors that have received some attention in genetic designs to illustrate the conceptual grounding that guides such work, as well as provide examples of specific methodologies that are used to intensively measure these constructs. The broader point to be taken from these examples, however, is that social context matters, and that the full range of potent social influences should be taken seriously in genetic research on nicotine dependence by using the appropriate methodologies to bring these factors into genetically driven research.

As discussed in chapter 3, multiple levels of phenotypes contribute to and compose the construct of nicotine dependence. Similarly, a multitude of factors make up the social context, from the macro level (e.g., sociopolitical) down to the micro

level (including psychosocial influences such as interpersonal relationships). This chapter focuses on selected examples of such macro and micro social factors of particular relevance to smoking phenotypes; the goal is to illustrate both concepts and methods rather than provide an exhaustive review.

Some behavioral genetic studies of tobacco use have used the phrase *genetic architecture* when describing the pattern of heritable influences that may be observed via genetically informative designs such as the twin paradigm.² This construct appeals because the expression of genetic systems is assumed to contribute to the structural foundations of complex phenotypes, such as the range of behaviors that involve use of tobacco. The descriptive statistic heritability typically is offered as a proxy for the overall strength of genetic contribution to a phenotype, and in this approach, is used to give some guidance to the phenotypes that most strongly reflect underlying genetic effects.³ Thus, “genetic architecture” has been used to describe the underlying heritability of one (univariate) or multiple (multivariate) indices of smoking, such as age at initiation, amount smoked, and smoking cessation attempts.²

This chapter broadens the concept by focusing on “etiological architecture” to serve as a reminder of a number of principles that have long been acknowledged in behavioral genetics.³ The typical components of behavioral genetic models (heritability, common or shared environment, nonshared or unique or individual-specific environment) are estimates of the mix of etiological influences on phenotypic moving targets that reflect a host of factors, including the population studied (embedding both geographical and temporal characteristics), the definition as well as measurement of the phenotype, and the extent to which environmental influences have been measured and modeled. In this sense, “etiological

architecture” refers to the dynamic mix of genetic and nongenetic influences on phenotypes captured in particular periods and within specific social contexts. This point emphasizes that the understanding of genetic foundations of behavior undoubtedly can (and will) change as methods for measuring phenotypes, genotypes, *and* nongenetic (or “environmental”) influences are refined. The “architecture” of smoking behaviors is not a firm foundation but rather a pliable blueprint of how to evaluate the role of genetic and nongenetic influences on particularly defined phenotypes—defined not just in terms of psychometrics but also as expressions of measurable behavior, in particular, historical, geographical, and social contexts. As a result, a primary goal of both quantitative and newer molecular methodologies is not only to get the phenotypic targets as well defined and measured as possible to move closer to “true” indicators and sequelae of gene expression but also to understand how gene expression operates in conjunction with, and in response to, a range of nongenetic influences.

The focus on social contextual influences in genetic studies certainly reverberates and builds upon the interest in gene-environment interplay in behavioral science,⁴⁻⁶ and specifically as applied to drug use,¹ which is the focus of chapter 3. The idea of bridges between genetic effects on phenotypes and environmental influences has been a theme in behavioral genetics for decades. This theme has taken on new momentum with the application of a number of novel methodologies and strategies, including an emphasis on both “measured genes” (molecular genetic markers such as candidate gene polymorphisms) and “measured environments” (inclusion of environmental variables in genetic analyses) as well as expansions of behavioral genetic paradigms, as shown in studies by Moffitt and colleagues.⁴⁻⁶ These papers make very explicit the utility of directly

incorporating environmental measures into genetic studies, the theoretical models that capture a variety of means by which genes and environment come together in producing clinically meaningful phenotypes, and the design strategies for achieving appropriate opportunities to examine the joint effects and interplay between genes and environment. Given this, the advances (as evidenced in the series of papers cited above, along with chapters 3 and 4) were chosen as a platform to consider how social contextual influences have been, and may be, incorporated into genetic studies of nicotine dependence. In particular, this chapter focuses on areas that have some empirical basis in terms of incorporating social context into genetically informative designs of tobacco use; it then considers newer methodologies that may provide even greater traction in future studies.

Why Incorporate the Social Context?

Most behavioral genetic studies have generated parameter estimates of genetic and environmental influences by using the fundamental quantitative genetic model, which does not incorporate actual (or “measured”) aspects of the environment.³ Why is it important to consider this? A first key issue is that the “unmeasured” genetic and nongenetic effects generated in the traditional model are assumed to be *additive* in nature and are calculated as such. There is, thus, typically limited (or no) opportunity to detect statistical evidence for gene-environment interplay without utilizing alternative genetic designs (such as the Children-of-Twins design, or COT) in that the two primary forms of gene-environment interplay—gene-environment interaction and gene-environment correlation—are embedded within the additive genetic component and contribute to the overall estimation of heritability. Second, without the inclusion

The Classic Quantitative Genetic Model and Smoking Behaviors

In framing the potential utility of incorporating the social context in genetic studies of smoking, it is necessary to briefly consider the core work in behavioral genetic studies. As discussed in chapter 6, a number of genetically informative studies have examined a range of smoking phenotypes. Indeed, since a landmark paper by Carmelli and colleagues^a provided evidence for the heritability of smoking by using the classic twin method, a number of twin studies have focused on varying levels of smoking intensity, including smoking initiation (e.g., ever puff versus never puff) and smoking frequency during adolescence^{b,c,d,e,f,g,h,i,j,k,l} as well as smoking persistence/regular smoking and nicotine dependence.^{m,n,o,p,q,r}

As discussed in reviews by Sullivan and Kendler^s and Li and colleagues,^t the relative mix of genetic and environmental factors appears to be different for different levels of smoking intensity. Li and colleagues^t have determined, using meta-analysis, that smoking initiation is influenced significantly both by genetic factors (with heritability estimates of 0.37 ± 0.04 for males and 0.55 ± 0.04 for females) and by shared environmental (nongenetic influences that operate to produce similarity in family members) factors (0.49 ± 0.04 for males and 0.24 ± 0.06 for females). Li and colleagues^t also provide evidence of substantial heritability of smoking persistence (0.59 ± 0.02 for males and 0.46 ± 0.12 for females), with shared environmental influences being more prominent for females (0.28 ± 0.08) than for males (0.08 ± 0.04). Sullivan and Kendler^s reached somewhat similar conclusions, suggesting substantial heritability of smoking initiation (approximately 0.60), along with significant shared environmental influences (approximately 0.20), with genetic factors being primarily responsible (heritability of approximately 0.70) for the transition to nicotine dependence and with less impact observed from shared environmental influences. Both continuities and discontinuities in the genetic effects on smoking initiation and progression to higher levels of smoking intensity are being evaluated with quantitative approaches such as those discussed in chapter 6.

^aCarmelli, D., and G. E. Swan. 1995. Genetic and environmental influences on tobacco and alcohol consumption in World War II male veteran twins. In *Alcohol and Tobacco: From Basic Science to Clinical Practice* (NIAAA Research Monograph No. 30), ed. J. B. Fertig and J. P. Allen, 89–106. Bethesda, MD: U.S. Department of Health and Human Services.

^bBoomsma, D. I., J. R. Koopmans, L. J. Van Doornen, and J. F. Orlebeke. 1994. Genetic and social influences on starting to smoke: A study of Dutch adolescent twins and their parents. *Addiction* 89 (2): 219–26.

^cHan, C., M. K. McGue, and W. G. Iacono. 1999. Lifetime tobacco, alcohol and other substance use in adolescent Minnesota twins: Univariate and multivariate behavioral genetic analyses. *Addiction* 94 (7): 981–93.

^dKoopmans, J., A. Heath, M. Neale, and D. Boomsma. 1997. The genetics of initiation and quantity of alcohol and tobacco use. In *The genetics of health-related behavior*, ed. J. R. Koopmans, 90–108. Amsterdam: Print Partners Ipskamp.

^eKoopmans, J. R., W. S. Slutske, A. C. Heath, M. C. Neale, and D. I. Boomsma. 1999. The genetics of smoking initiation and quantity smoked in Dutch adolescent and young adult twins. *Behavioral Genetics* 29 (6): 383–93.

^fMaes, H. H., M. C. Neale, N. G. Martin, A. C. Heath, and L. J. Eaves. 1999. Religious attendance and frequency of alcohol use: Same genes or same environments: A bivariate extended twin kinship model. *Twin Research* 2 (2): 169–79.

^gMcGue, M., I. Elkins, and W. G. Iacono. 2000. Genetic and environmental influences on adolescent substance use and abuse. *American Journal of Medical Genetics* 96 (5): 671–77.

^hRende, R., C. Slomkowski, J. McCaffery, E. Lloyd-Richardson, and R. Niaura. 2005. A twin-sibling study of tobacco use in adolescence: Etiology of individual differences and extreme scores. *Nicotine and Tobacco Research* 7 (3): 413–19.

ⁱRhee, S. H., J. K. Hewitt, S. E. Young, R. P. Corley, T. J. Crowley, and M. C. Stallings. 2003. Genetic and environmental influences on substance initiation, use, and problem use in adolescents. *Archives of General Psychiatry* 60 (12): 1256–64.

- [‡]Slomkowski, C., R. Rende, S. Novak, E. Lloyd-Richardson, and R. Niaura. 2005. Sibling effects on smoking in adolescence: Evidence for social influence from a genetically informative design. *Addiction* 100 (4): 430–38.
- [‡]Stallings, M. C., J. K. Hewitt, T. Beresford, A. C. Heath, and L. J. Eaves. 1999. A twin study of drinking and smoking onset and latencies from first use to regular use. *Behavior Genetics* 29 (6): 409–421.
- [‡]White, V. M., J. L. Hopper, A. J. Wearing, and D. J. Hill. 2003. The role of genes in tobacco smoking during adolescence and young adulthood: A multivariate behaviour genetic investigation. *Addiction* 98 (8): 1087–1100.
- [‡]Heath, A. C., N. G. Martin, M. T. Lynskey, A. A. Todorov, and P. A. Madden. 2002. Estimating two-stage models for genetic influences on alcohol, tobacco or drug use initiation and dependence vulnerability in twin and family data. *Twin Research* 5 (2): 113–24.
- [‡]Kendler, K. S., M. C. Neale, P. Sullivan, L. A. Corey, C. O. Gardner, and C. A. Prescott. 1999. A population-based twin study in women of smoking initiation and nicotine dependence. *Psychological Medicine* 29 (2): 299–308.
- [‡]Madden, P. A., A. C. Heath, N. L. Pedersen, J. Kaprio, M. J. Koskenvuo, and N. G. Martin. 1999. The genetics of smoking persistence in men and women: A multicultural study. *Behavior Genetics* 29 (6): 423–31.
- [‡]Madden, P. A., N. L. Pedersen, J. Kaprio, M. J. Koskenvuo, and N. G. Martin. 2004. The epidemiology and genetics of smoking initiation and persistence: Crosscultural comparisons of twin study results. *Twin Research* 7 (1): 82–97.
- [‡]Maes, H. H., P. F. Sullivan, C. M. Bulik, M. C. Neale, C. A. Prescott, L. J. Eaves, and K. S. Kendler. 2004. A twin study of genetic and environmental influences on tobacco initiation, regular tobacco use and nicotine dependence. *Psychological Medicine* 34 (7): 1251–61.
- [‡]Vink, J. M., G. Willemsen, and D. I. Boomsma. 2005. Heritability of smoking initiation and nicotine dependence. *Behavior Genetics* 35 (4): 397–406.
- [‡]Sullivan, P. F., and K. S. Kendler. 1999. The genetic epidemiology of smoking. *Nicotine & Tobacco Research* 1 Suppl. 2: S51–S57, S69–S70.
- [‡]Li, M. D., R. Cheng, J. Z. Ma, and G. E. Swan. 2003. A meta-analysis of estimated genetic and environmental effects on smoking behavior in male and female adult twins. *Addiction* 98 (1): 23–31.

of specific nongenetic/environmental variables, no information is gleaned on how the effect sizes of the descriptive statistics generated in the quantitative genetic model (heritability, shared environment, nonshared environment) may change under varying environmental conditions.

These considerations are important for any clinical phenotype but take on added importance for substance-use behaviors, including smoking, which are defined in part by availability of and exposure to the substances in the environment. Merikangas and Avenevoli⁷ have described how the traditional genetic epidemiology triangle, which focuses on host susceptibility, environmental factors, and exposure to a disease-causing agent, is particularly well suited to the study of substance use. In this model, exposure to the source of nicotine (e.g., a cigarette) would be the primary agent

that is a necessary condition for development of nicotine dependence, and both exposure to the agent and reaction to the agent would reflect joint influences of host factors as well as environmental factors. In this regard, environmental factors including cultural forces (such as norms against women smoking), protobacco promotional activities, antitobacco activities (e.g., smoke-free environments), and proximal interpersonal influences (e.g., influences of parents, siblings, and friends) need to be integrated into the genetic epidemiology triangle to understand how they directly shape the expression of host/genetic susceptibility to nicotine dependence. These joint effects thus imply complex layers of potentially connected factors, as described by Eaves⁸ and quoted by Lessov and colleagues:

To the degree that drug-use behavior is heritable, inherited liability toward drug

use or misuse increases the risk for drug-use behavior but it does not lead to or cause drug use. The expression of genetic liability (i.e., substance use and misuse) depends on environmental conditions. For example, exposure of the organism to a drug is necessary. Exposure, in turn depends on other environmental factors such as drug access and availability, which is related to neighborhood, home, and peer group environment, to name a few. People mistakenly think that “Everything is genetic,” ignoring that while an individual does not have control over their *[sic]* genetic makeup, an individual is in constant dynamic interaction with their *[sic]* environment; and it is that interaction that contains powerful information about the probability of drug use and misuse.^{1(p1519)}

These perspectives from genetic epidemiology overtly posit that interaction between (potentially nested) levels of host, environment, and agent variables underlie substance use and, in particular, progression to problematic levels of use (such as nicotine dependence). Within this framework, both measurement of environmental factors and inclusion of these factors in the analytic models would be necessary for a complete understanding of the genetic effects on nicotine dependence. The traditional quantitative genetic model, with emphasis on additive genetic and environmental effects, along with no attention to measured sources of environmental influence, does not provide an optimal opportunity to delve into the purported interplay between agent, host, and environment. Rutter and colleagues⁶ have provided a comprehensive review of the multiple models of gene-environment interplay, and these models provide a platform for considering alternatives to the additive genetic model. Of particular relevance are major classes of gene-environment interplay, reviewed by Rutter and colleagues⁶ (see also Shanahan and Hoffer⁹), which include

(1) variations in genetic influence according to environmental circumstances; (2) gene-environment correlations; and (3) gene-environment interactions.

Behavioral Genetic Studies of Smoking That Incorporate Social Context

Although the behavioral genetic literature has primarily relied upon the application of biometrical models to data on cigarette use, examples from newer studies incorporate social contextual measures. These studies provide empirical foundations for the speculations offered above, and this section reviews pertinent studies. For heuristic purposes, both “macrocontextual” indicators of social context—constructs of influence that range from broad cultural expectations to more localized geographic effects—as well as “microcontextual” influences¹⁰ that reside closer to individual-level factors, such as interpersonal relationships, will be used. In particular, specific social contextual variables that have been studied by using the behavioral genetic paradigm will be referenced. All the studies to be reviewed rely on modeling types of gene-environment interaction by using extensions of the fundamental biometrical model of quantitative genetics via the inclusion of a specified, measured environmental factor that can be tested as a moderator of the latent genetic effect (as well as the latent, shared environmental effect). The rationale for this approach, along with some of the methods that may be used, is discussed in Turkheimer and colleagues¹¹ and Purcell and Koenen;¹² see also Kendler and colleagues¹³ and Timberlake and colleagues¹⁴ for inclusion of moderators in biometrical models of smoking. The key propositions tested, using the nomenclature from Rutter and colleagues,⁶ are the following:

- Are there environmental factors that reduce the impact of genetic influences?
- Are there environmental contexts that, in contrast, especially accentuate genetic influences?

Macrocontextual Factors as Moderators of the Etiological Architecture of Smoking

It is well documented, and beyond the scope of this chapter, that population levels of cigarette use have been heavily influenced by many dynamic social factors that have changed over the decades, including tobacco control and prevention initiatives.¹⁵ The focus here is on the extent to which *behavioral genetic studies* have incorporated such macrocontextual factors into the biometrical modeling approach. Two points should be noted. First, these studies provide examples of the utility of incorporating macrocontextual factors into genetically informative studies of tobacco use and nicotine dependence. Second, these studies also highlight how limited this research has been, given the wide range of macrocontextual factors that *could* be incorporated into quantitative genetic paradigms. Thus, the studies reviewed below demonstrate how the expression of genetic liability to smoking may be shaped by the larger social culture (e.g., how the effects of genes change over time in concert with social changes or vary within populations that vary on macrosocial indices) and highlight approaches that can be used in future studies to integrate potent macrosocial influences.

Effects of Culture and Cohorts

One concrete and dramatic example comes from investigations into the etiological architecture of cigarette smoking in China. Lessov-Schlaggar and colleagues¹⁶ reported that within a sample of 1,010 adult Chinese twins, 58% of the male twins were

smokers, but over 99% of female twins were nonsmokers. Whereas the etiological architecture of smoking in male twins was similar to that reported in studies from other cultures, there were no individual differences in female smoking to model. An examination of changes in heritability based on cohort effects from the population-based Swedish Twin Registry expands this theme.¹⁷ Rates of regular tobacco use in women born before 1925 were low and found to be environmental in origin; in contrast, as smoking rates increased in women born after 1925, heritability estimates increased. This finding serves as a reminder that the macrocontext can have overwhelming impact on the choice or ability to use cigarettes that can fundamentally nullify or promote net genetic effects, and it reinforces the suggestion that the etiological architecture of smoking *must* be defined by reference to the social context in which it is observed.

Less dramatic, but nonetheless important, examples from behavioral genetic studies of smoking have attempted to account for differences across either cultures or birth cohorts. In 1993, Heath and colleagues¹⁸ demonstrated that the decline in smoking in more recent birth cohorts did not affect the estimates of genetic and environmental influence on smoking initiation. They did find, however, differences in the heritability and shared environmental estimates in Australian versus U.S. samples. A subsequent study suggested that cultural background may influence the magnitude of shared environmental effects on lifetime smoking but that estimates of both genetic and environmental effects on smoking persistence were unaffected by culture.¹⁹

Socioregional Influences

The few twin studies mentioned above have provided tests of a particular type of gene-environment interaction by using distal environmental measures^{4,5} and latent

genetic factors inferred by the comparison of monozygotic and dizygotic twins. Although some of the results reflect profound social contextual effects (e.g., cultural discouragement of smoking in females in China), the studies examining cross-cultural differences introduce the possibility of examining more subtle differences that may exist within cultures that would not be detected without overt measurement of possible sources of environmental influence. Surprisingly, no behavioral genetic studies of smoking have used this strategy. The potential utility of this approach is illustrated by research on adolescent alcohol use in Finland. Rose and colleagues²⁰ made the important observation that regional residency (urban versus rural) significantly moderated genetic effects on drinking patterns, including longitudinal change in drinking observed over a 30-month period. Specifically, genetic effects were larger within the sample of adolescents who resided in urban areas, and shared environmental factors were larger for the subsample living in rural areas.

Two important points are raised by the work of Rose and colleagues.²⁰ First, it demonstrates that socioregional variations can be detected and modeled within the behavioral genetic paradigm and that such social contextual factors can have a large influence on the etiological architecture of substance use. Second, these authors took the important step of incorporating more specific measures of socioregional influences into their analyses—namely, the relative proportion of young adults in a regional area, the frequency of migration in and out of a region, and the relative amount of money spent on alcohol in an area.²¹ When these more specific social contextual measures were introduced into the biometrical models, clear evidence of gene-environment interaction was found. Both a higher proportion of young adults and higher migration levels were associated with stronger genetic effects on drinking

patterns in adolescents, whereas lower levels of young adults and migration yielded greater shared environmental influences.

As discussed by Dick and colleagues,²¹ variation in these social structures can either promote genetically influenced individual differences in drinking (via more opportunities with peers and less stable social structure) or mask genetic differences (as the strength of shared environment increases with more stability and less opportunity for peer influence). The more general point of this work, as noted by the authors, is that they moved from the more distal index of residential residence (urban versus rural) to potential proximal indicators of social context that may reside closer to actual mechanisms of influence. This important theme of translating distal environmental measures into more proximal indicators^{4,5} will be revisited in the following section on newer methodologies for examining social context—and certainly carries forward the theme of attending to multiple levels of assessment of both smoking-related phenotypes (chapter 3) and environments.

Microcontextual Factors as Moderators of the Etiological Architecture of Smoking

As noted above, social contextual factors may be conceptualized as operating at multiple levels, with the final important pathway being a proximal end point reflected at the individual level. As these microcontextual features that are more individually based are considered, the primary focus is on interpersonal influences, which have received attention in some behavioral genetic papers. Interest in interpersonal dynamics came about, in part, because of concern that contact between twins could violate the equal environments assumption (EEA) (if the level of contact was greater for monozygotic as compared to dizygotic twins). That is, as the twin

method attributes greater similarity (or concordance) of monozygotic versus dizygotic pairs to differences in genetic relatedness (and hence heritability), uncontrolled nongenetic factors that promote differences based on zygosity may artificially inflate heritability estimates. For example, Kendler and Gardner²² found that the heritability of smoking initiation was reduced by about 10% after controlling for the higher degree of social contact in monozygotic pairs as compared to dizygotic pairs. Kendler and colleagues²³ also reported that their data were consistent with modest influences of social contact between twins (and the violation of the EEA) on nicotine dependence. Later evidence suggests that the socialization effects that differ between monozygotic and dizygotic twins may influence smoking initiation to a much larger degree than does smoking persistence.^{19,24} These effects may also differ based on gender. Hamilton and colleagues²⁵ found strong moderation via social contact of both shared environment (which increased) and heritability (which decreased) in female, but not male, twin pairs.

The implications of these studies go beyond the extent to which heritability estimates may, or may not, be biased by violations of the EEA. Of more substantive interest is the extent to which interpersonal dynamics may influence smoking behavior as a form of social influence, which may operate both as a main effect (i.e., independent of genetic relatedness) as well as in combination with genetic factors. As discussed earlier, the robust shared environmental effects found for smoking initiation suggest potential socialization effects that could derive in part from peers and siblings.²⁶ Vink and colleagues²⁷ approached this issue using a twin-family design. They examined the extent to which current smoking behavior was associated with the smoking behavior of peers and siblings (along with parents and spouses). Using a cross-sectional design, they found strong evidence of both peer and

sibling effects on smoking in adolescence; these effects were not seen for smoking in adulthood. Rather, in adulthood, the most important relational predictor of smoking was zygosity of co-twin smoking (such that having a monozygotic twin who smoked conveyed the most prediction of current smoking status). They concluded that social effects may be most evident in adolescence, but lessen in importance in adulthood, when genetic factors become a stronger influence on the likelihood of smoking. Taking this a step further, there is also evidence that exposure to smoking by parents and peers in adolescence and early adulthood, when accounted for in the traditional biometrical model, substantially *reduces* the impact of genes on smoking behavior, leading to the suggestion that environmental factors provide the strongest influence on smoking during these developmental periods.²⁸

Subsequent expansions of this focus on interpersonal influences have focused on direct sibling effects by utilizing more differentiated measures of the sibling relationship as well as extension of the twin paradigm to include siblings of varying genetic relatedness (full, half, and unrelated siblings) via the genetically informative subsample of the National Longitudinal Study of Adolescent Health (Add Health).^{29,30} A first finding²⁹ is that monozygotic twins have elevated levels of time spent together (social contact) as well as mutual friendships as compared with all other sibling types. However, the interpretation of this finding is not straightforward. Levels of social contact and mutual friendships did not follow a dose-response association with zygosity once the effect of monozygotic twins was considered. Thus, it may be that monozygotic twins, compared with all other sibling types, have much more commonality in their time spent with each other as well as with friends.

That said, the inflated monozygotic concordance for time together and mutual

friendships did not alter the estimates of heritability of smoking frequency (measured as number of days smoked over the last 30 days). Rather, time spent together and mutual friendships both significantly moderated the shared environmental component.²⁹ These two variables were also analyzed along with amount of sibling affection to create a construct of sibling connectedness, which also moderates the shared environment effect but not the estimate of heritability.³⁰ The finding that twins and siblings form connections with mutual friends, and that these social groupings represent social rather than genetic influences on smoking, highlights the importance of considering broader effects of larger social networks as a potent influence on smoking patterns.^{31,32}

Summary

Overall, the studies reviewed in this section provide a good starting point for considering how social contextual factors may be integrated into genetically informative designs. These studies provide solid empirical evidence that the estimation and interpretation of the descriptive statistic of heritability can vary when referenced according to important macro- and microcontextual factors and represent a good starting point for a more realistic genetic epidemiological model of smoking.

Proximal Measures of the Social Context

It has been suggested that moving from distal indicators of the social environment to more proximal measures will be important for improving the resolution of models of gene-environment interplay.⁴⁻⁶ Building on this suggestion, the realization of adequate tests of these models will depend in part on careful and forward-looking assessment of candidate social contextual factors (as one class of environmental factors in models of

gene-environment interplay). It is becoming recognized that accurate measurement of the environment is as critical to the success of any foray into gene-environment interplay as is quality control of genotyping.⁶ Despite this recognition, there has been a tremendous disparity in the attention and resources given to “molecular” assessment of the environment in genetic studies as compared with the effort devoted to dissection of the genome,⁵ despite the strong evidence on the potent effects of a number of social contextual factors. These include social networks as well as the overarching social and cultural environment, which includes pro- and antitobacco factors.^{31,32}

Dissemination of the multiple levels and corresponding constructs of social context that could bear upon smoking and nicotine dependence would require a separate monograph devoted to that purpose. In lieu of that, this section will build on the candidate social contextual factors reviewed in the prior section by illustrating newer methodologies that attempt to capture proximal social contextual influences that could be integrated relatively easily into most genetically informative designs.

In general, behavioral genetic studies are very well positioned to incorporate both macro- and microcontextual measures, and two particular features can be exploited. First, nearly all ongoing behavioral genetic studies rely on large, population-based samples. As such, they would provide ideal vehicles for introducing specific indicators of macrocontextual features that may affect the role that genes play in pathways to nicotine dependence. Second, behavioral genetic designs are by definition family based. This provides enormous opportunities to expand the focus on microcontextual influences that either operate as family process or impinge on family members such as twins and siblings (e.g., peer groups). Although the range of both macro- and microcontextual factors that could be included in genetic

studies is wide-reaching, the focus here is on *illustrative examples* using specific constructs that have been linked with smoking, can be folded with relative ease into ongoing genetically informative designs, and, perhaps most important, can be pursued with measurement strategies that attempt to move from the distal to the more proximal level.

Socioeconomic Status: Moving from Distal to Proximal Influence

The few behavioral genetic studies of smoking or substance use that have attended to macrocontextual factors suggest that more detailed quantification of the social environment is warranted. This section illustrates the potential for genetic studies of smoking by highlighting one (of many) prominent aspects of the social environment with strong relevance for smoking in both adolescents and adults: socioeconomic status (SES). A number of studies provide good examples of links between SES and smoking in a wide range of populations. SES effects on smoking are not limited to adolescent smoking and continue into early adulthood.³³ Indeed, the effects of SES have been observed at all stages of smoking—from initiation in adolescence through progression to regular smoking and smoking persistence in adulthood—as linked by continuities between childhood (parental) SES and adult (individual) SES.^{34,35} In addition, changes in educational attainment in young adulthood alter the trajectories of smoking. For example, although adolescent smoking strongly predicts smoking in adulthood, an improvement in SES (moving to a higher SES level in adulthood as compared to childhood SES) reduces the likelihood of progressing to persistent smoking in adulthood.³⁶ Although SES effects may operate through multiple levels of influence, including linkages with parental smoking and parental behavior, direct links between parental education level and offspring adult

smoking have been found after controlling for these factors.³⁷

It is worth noting that at this point incorporation of SES—even measured as a distal environmental construct—into behavioral genetic designs would be a step forward for the field. The modeling approach that has been used in prior behavioral genetic studies to test for cohort and cultural variations in the etiological architecture of smoking would be well-suited to test for evidence of gene-environment interplay with SES as a measured contextual variable. For example, SES has been shown to moderate the heritability of IQ³⁸ and cognitive aptitude;³⁹ in both cases, shared environmental influences are pronounced in impoverished families but genetic effects predominate in affluent families. Given the wealth of studies linking both childhood and adulthood SES to all stages of smoking, the dearth of behavioral genetic studies that have explored SES as a potential moderator of the etiological architecture could easily be rectified, especially given that there are solid conceptual models that provide a rationale for examining such effects.⁶

Nuanced Approaches to Capture Proximal SES Effects

Consistent with the theme of this section, there are nuances to the measurement of SES that would be instructive for genetically informative studies. For example, Unger and colleagues⁴⁰ have shown that two features of SES—an objective SES index (based on a composite measure of family and neighborhood SES) and available pocket money—are associated with an increased risk of smoking in a sample of 8th-grade adolescents. This study is interesting in that attention was given to both a more proximal indicator in the adolescents (their own available spending money) as well as a specific effect of neighborhood SES (as determined by matching zip codes to U.S. Census data). Both of these steps reflect

progress in moving toward more proximal indicators of the macroenvironment in that there are multiple levels of proximal influence that operate at both the individual level and the neighborhood or area level (again, see chapter 3 for a similar perspective on measurement of phenotypes). Diez Roux and colleagues⁴¹ used more detailed information available from census data, including census tracts (subdivisions of a county), as well as smaller components (or blocks), to measure a number of area characteristics. Such measurement of socioeconomic disadvantage was highly predictive of smoking in young adulthood in their study, and as suggested in this paper, individual- and area-level indicators of SES may capture unique aspects of socioeconomic effects. Also, evidence shows that area-defined economic deprivation is predictive of the likelihood of quitting smoking.⁴² These studies provide important examples of obtaining more precision on macrosocial factors, and clearly a variety of other variables—such as cigarette prices and presence of smoking restrictions—that are geographically linked deserve consideration in future studies.

Proximal Indicators of Area Effects on Smoking

The studies above highlight the early steps that are being taken to break down the distal factor of SES into a number of components, with the net result being more specific indicators of the macrocontext that may likely alter the mix of genetic and nongenetic influences on smoking during both adolescence and adulthood. The overriding implication for genetic studies of tobacco use and nicotine dependence is that there are not only crucial macrocontextual influences that shape patterns of smoking (and undoubtedly intersect with genetic susceptibility) but also *specific methodologies* that permit more precise assessment of these factors at a proximal level. A number of emerging constructs

and measurement techniques could be relevant as predictors of smoking, including a focus on area crime rates,⁴³ neighborhood disorder,⁴⁴ price of cigarettes, and presence of a smoke-free law. One illustrative example is the density of tobacco retail outlets as a specific area risk factor linked with cigarette smoking, especially in youths. A paper by Novak and colleagues⁴⁵ illustrates the conceptual basis as well as a highly detailed methodology as applied in the Project on Human Development in Chicago Neighborhoods. In this study, trained raters videotaped, while driving, each side of streets that corresponded to selected census tracts. Codes were developed to identify retail locations licensed to sell tobacco and captured empirically as density of retail outlets. Two findings of the study are especially relevant: (1) retail tobacco outlets were overrepresented in socially and economically disadvantaged neighborhoods (suggesting a more proximal level of risk for smoking via area SES), and (2) youths who resided in the high-density areas were at increased risk for smoking, especially after controlling for confounding variables.

It is unlikely that large-scale behavioral or molecular genetic studies would invest the resources to physically code diverse geographic areas for density of retail tobacco outlets. The advancement in methodologies such as geographic information systems (GISs) provides a cost-effective approach for capturing such specific social contextual factors with relevance for smoking. Croner and colleagues provide an informative and readable description of the methods and utility of GISs, which they describe as computer-based programs “supporting the collection, storage, retrieval and statistical manipulation of spatially-referenced observations and events.”^{46(p1961)} Fundamentally, any study that collects street address data on participants has the capacity to extract information from sources such as census data (as discussed above in studies of area effects on smoking), as well

as geocode or address match to spatial data (i.e., map coordinates), and utilize any number of indicators for features of interest from relevant databases.

To demonstrate the utility of this approach, this chapter briefly describes portions of ongoing work at the Brown University Transdisciplinary Tobacco Use Research Center (Brown TTURC) as applied to the third (adolescent) generation of its three-generation family study of nicotine dependence. The study was successful in using GISs to match density of tobacco retail outlets that correspond to the locations of participants. The geocoding process required three types of files: TIGER/Line, census block groups, and address tables. *TIGER/Line* is the term given to files containing the layout of U.S. streets, and *census block groups* is the term given to the files containing the layout of the U.S. Census block groups, which, at the time of these analyses, were the smallest geographic unit of measurement of the U.S. Census. Lastly, tables containing physical addresses of participants and cigarette retailers were needed that contained U.S. street addresses and zip codes. The addresses of cigarette retailers for Rhode Island and Massachusetts (the two primary states of residence for participating families) were obtained electronically from the Rhode Island Division of Taxation and the Massachusetts Disclosure Office. Figures 11.1 and 11.2 present the located cigarette vendors within each state as spatial points on a map of the state.

A number of variables can be generated from these data, including counts of cigarette vendors per census block group per state and the density of cigarette vendors within specified distances of each participant. For example, one measure can be created to index if there is any outlet in the given area, and another can be based on the proportion of block faces with a given outlet. Physical distance and traveling time to the closest

Figure 11.1 Located Cigarette Vendors in Rhode Island

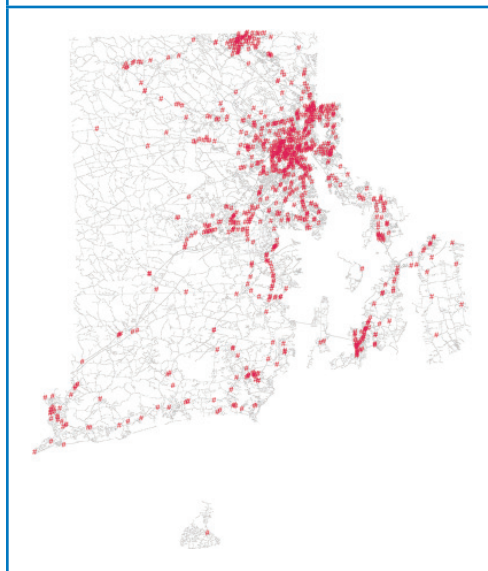

and the second-closest tobacco and alcohol stores can also be calculated by using network analysis in GISs.

Implications for Incorporating Proximal Indicators of the Macroenvironment in Genetically Informative Studies

Four basic points can be extracted from these examples of methods that can be used to move to a more precise and “molecular” level of understanding the macrocontext within genetically informative studies. First, genetic and family-based studies provide an excellent platform for applying relatively new methodologies such as GISs, as well as many other approaches now used to generate sophisticated indices of macrocontextual influences with empirically demonstrated relevance for smoking. Second, integrating these approaches into genetically informative designs will be most effectively accomplished via a transdisciplinary framework,¹ which facilitates collaboration across a number

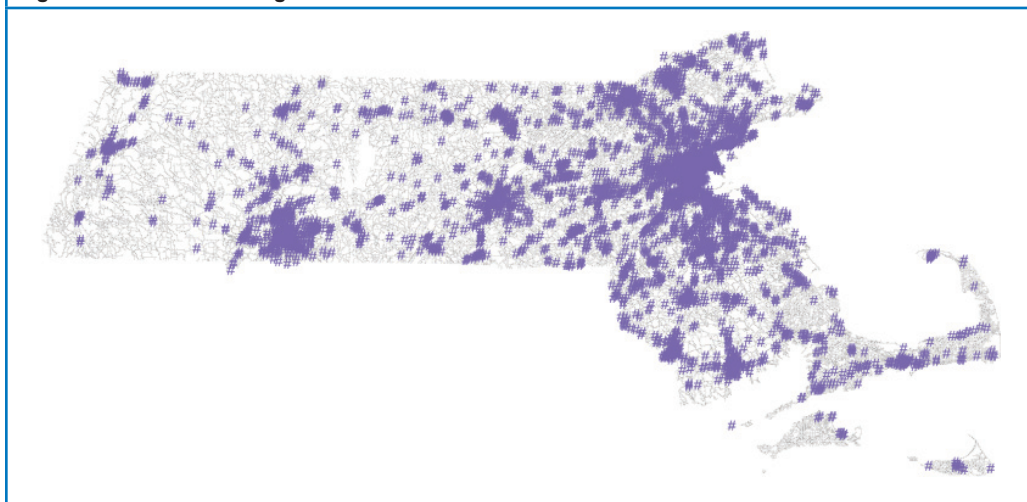
Figure 11.2 Located Cigarette Vendors in Massachusetts

of disciplines. Third, these proximal constructs that can emerge from methods such as GISs can be as easily integrated into quantitative genetic models as any distal measure, such as SES as traditionally represented, and would provide needed data on the extent to which expression of genetic liability to multiple indices of smoking (initiation, persistence, dependence) is modified by macrocontextual factors. Finally, proximal indicators of the macrocontext could also serve as putative environmental components in a variety of models of gene-environment interplay (e.g., gene-environment interaction and correlation)^{5,6} when combined with measurement of candidate gene markers with relevance to nicotine dependence.

Quantifying the Microsocial Context: Moving Toward Proximal Measures of Interpersonal Influences on Smoking

As was the case for the macrocontext, a multitude of microcontextual factors could impinge on likelihood of smoking across developmental stages. Building upon

the behavioral genetic studies reviewed earlier that incorporated interpersonal influences into estimates of the etiological architecture of smoking, this section focuses on methods that attempt to yield more proximal indicators of potential underlying social processes. This focus not only reflects an important theme in the behavioral genetics of smoking, but also provides a logical extension of genetically informative designs, given the inherent attention to dyadic relationships (e.g., twins and siblings; parents and offspring).

Interpersonal Relationships as a Context for Smoking

Independently of the behavioral genetic literature, tremendous attention has been given to interpersonal relationships as social contexts for the development of multiple forms of substance use,⁴⁷ including smoking.^{10,48,49} Indeed, some perspectives emphasize the critical importance of social networks as an influence on smoking,³² which have been conceptualized as being comparable to an “infectious disease” model⁵⁰ or “social contagion.”²⁹ Particular focus has been placed on three types of relationships as

the most salient for smoking: parents, peers, and siblings. There is a long history of studying parental smoking as a predictor of offspring smoking.⁵¹ A number of studies have provided further evidence of linkages between parental smoking and a number of smoking outcomes in adolescence and adulthood. Parental smoking increases the likelihood of experimentation in childhood and adolescence⁵² and regular smoking in early adulthood,⁵³ smoking parents who provide a smoke-free home for their children may confer particular protection against smoking initiation.⁵⁴ Adolescent offspring of mothers who smoke regularly and/or are nicotine dependent are more likely to initiate smoking and to progress to nicotine dependence.⁵⁵ Parental smoking, including paternal smoking, also predicts an earlier age of onset of tobacco use.⁵⁶ A number of studies also suggest that parental smoking cessation is associated with a decreased risk of smoking in adolescent offspring.^{57–60} These studies all go to the broader point that social networks (and the resultant proximal effects of social influence) may have a profound effect on patterns of smoking.^{31,32}

A similarly large historical literature exists for peer influences on adolescent cigarette smoking, whereas less attention has been given to siblings. Reviews by Hoffman and colleagues and Kobus describe multiple theories of peer influences and provide a comprehensive longitudinal model.^{49,61} Hoffman and colleagues⁶¹ provide a good discussion on the core concepts of peer influence (as a putative causative factor) and peer selection as they pertain to smoking.⁶² The impact of sibling smoking has begun to receive more attention, especially given the strength of the association between siblings,^{29,51} and the overviews of the models of sibling influence provided by Slomkowski and colleagues.³⁰ Subsequent studies have confirmed the strong predictive value of friend and sibling influences on adolescent smoking.^{63–65}

Proximal Indicators of Interpersonal Influence

The extensive data on interpersonal relationships as a social context for the development of smoking suggests that incorporation of social processes into genetic models would be profitable and perhaps necessary and is consonant with an emphasis in the literature on the effects of social networks and influences on smoking.^{31,32} As stated earlier, the behavioral genetic literature consistently points to shared environmental effects on smoking in adolescence; one source of influence could be joint social relationships and direct influence of smoking behavior within intimate relationships. As reviewed earlier, some progress has been made in behavioral genetic studies suggesting that, as a structural variable, both having friends who smoke and having a parent who smokes moderate the shared environmental effect on adolescent smoking. Furthermore, prior studies^{29,30} that focused on specific dimensions of the sibling relationship as moderators of shared environment have inched toward more specific indicators of social process. However, little attention has been paid to translating the typically measured distal factors of having a relationship with someone who smokes into more proximal measures of social influence that can be studied within the gene-environment interplay framework. This section illustrates an approach for incorporating proximal indicators of interpersonal influence into genetically informative designs. Although the focus here is on interpersonal dynamics, the broader point is the need to appropriately consider and measure a host of powerful social contextual factors into genetic studies, including influences such as exposure to cigarette advertising and smoking in movies,⁶⁶ which may operate via social networks such as peers.⁶⁷

Two rationales based on the empirical work available support the relevance for

genetic models of nicotine dependence. First, the consistent isolation of sources of shared environment in studies of adolescent smoking, some of which may be embedded in interpersonal dynamics,²⁶ could identify candidate “environmental” factors to study jointly with both latent genetic indicators as well as candidate gene markers for propensity for nicotine dependence within the gene-environment interaction framework.^{4,5} Second, given evidence that components of family and peer relationships may reflect genetic as well as social influences,⁶⁸ it would be informative to explore the possibility of gene-environment correlation as one source of the net genetic effect on smoking and nicotine dependence. In addition to filling in the black box of heritability, such work could contribute to identifying multiple sources of genetic influence on smoking. For example, Agrawal and colleagues⁵³ suggest that correction for a host of risk factors, including parental smoking and features of the parent-child relationship and home environment, yields a reduction in the overall heritability of regular smoking in young adulthood that nonetheless remains significant. They draw two important conclusions from these results: (1) the reduction in heritability may signal that part of the overall parental effect reflects genetic effects, and (2) the residual heritability of young adult regular smoking may represent more “phenotype-specific” genetic effects.

Proximal Indicators of Social Influence: Methods for Studying Real-Time Interaction

The most traction will be made in developing gene-environment models focusing on social context relationships by using specialized methodologies capable of capturing more proximal indicators of interpersonal processes that are linked with risk for smoking and progression of smoking.⁴⁷ A number of processes could be studied. For example, selected parental behaviors

could be measured and inserted into behavioral and molecular genetic studies, including parental beliefs and behaviors pertaining to smoking,⁶⁹ parenting style and smoking-specific parenting practices,⁷⁰ and antismoking socialization.⁷¹ Another example with respect to peers would be social network analysis, which, as described by Hoffman and colleagues,⁶¹ can be used in longitudinal studies to tease apart peer influence and peer selection. Other interesting methods include using speech samples to extract relationship narratives as an indicator of mother-child family process⁷² and sibling-expressed emotion.⁷³

Similar to the strategy of focusing in some detail on GIS methods in the prior section, this section will provide an illustrative example that has been used especially in studies of both peers and siblings: the use of microsocial coding of real-time social interaction as captured by using semistructured, videotaped paradigms. One paradigm that elicits and records relationship dynamics is to observe microsocial interaction as it unfolds in real time.⁷⁴ Typically, semistructured discussion tasks are constructed and videotaped without an observer present. Dishion and colleagues have pioneered this work with particular reference to microsocial processes that convey risk for antisocial behavior and substance use,^{75,76} and similar work has been done with siblings.⁷⁷

Real-Time Social Interaction in a Genetically Informative Design

Two features of this methodology warrant expansion in terms of immediate relevance to the etiological architecture of smoking as it changes from adolescence to adulthood. First, the genetically informative Nonshared Environment in Adolescent Development (NEAD) Project, which uses monozygotic and dizygotic twins along with full, half, and unrelated sibling pairs, has provided a wealth of data on the

genetic and environmental determinants of sibling behavior in adolescence via the combined use of videotaped interaction and multirater reports.⁷⁸ A key finding is that a number of indices of sibling relationship dynamics are shaped by shared environmental, rather than genetic, factors as determined by biometrical model fitting. Given the accumulating evidence, reviewed earlier, that shared environmental factors influence adolescent smoking and that sibling interaction may moderate, in part, the shared environmental effect, the elucidation of specific interpersonal processes derived from microsocial data would provide a strong candidate for this form of proximal environmental influence on smoking. As discussed in the examples for macrocontextual factors, such empirically validated indicators of environmental influence would serve well in gene-environment interaction models of adolescent smoking that are optimally tested by using proximal measured environmental pathogens.^{4,5}

A second theme from the NEAD Project is that shared environmental influences provide the most robust linkage across different types of relationships, including covariation between mother-adolescent and sibling relationships as well as longitudinal associations between adolescent antisocial behavior and young adult relationships with romantic partners.⁷⁸ These findings are included for consideration as part of the thesis that the interpersonal dynamics that may underlie both peer and sibling influences on smoking in adolescence may represent enduring relationship styles that carry into adulthood and into other relationships, including relationships with romantic partners. These patterns may be especially relevant given the notable evidence for assortative mating for a number of stages of cigarette smoking that include regular smoking and nicotine dependence.^{79,80} Although assortative mating may primarily reflect selection rather than interpersonal

influence per se, it is worth considering the possibility that the continual construction of intimate relationships may be influential in maintaining lifestyle choices across developmental periods that promote harmful behaviors.⁸¹ It is worth reiterating at this point that current contact between adult twins is associated with twin resemblance of nicotine dependence.²³ The proposed utility of microcontextual measures of proximal, interpersonal influences may not only be useful as a piece of the etiological architecture of adolescent smoking but also could be expanded to include adult relationships as a putative source of environmental reinforcement for smoking; this could, in principle, interact with emerging genetic propensity for nicotine dependence. The application of these methods would provide the most sensitive tests for the role of interpersonal influences in models of nicotine dependence that posit the possibility of gene-environment interplay.

Ecological Momentary Assessment

A final, newer methodology available to the smoking field is ecological momentary assessment (EMA). Indeed, the rationale for EMA is now well recognized in the smoking literature and has been well explicated.^{82,83} The “ecological” aspect refers to the use of technologies—for example, personal digital assistants (PDAs) and cellular phones—that allow respondents to report their behaviors in real time and in real-life settings. The corresponding “momentary assessment” of the methodology is the emphasis on acquiring instantaneous self-reports to minimize the recall bias and memory distortion typically introduced by more retrospective accounts.

EMA Studies of Smoking

A number of published studies have used EMA to assess smoking behavior in

adolescents and adults. EMA has been used to examine differential smoking patterns in adult heavy smokers and chippers.⁸⁴ Some of these studies have assessed antecedents of cigarette smoking in adults, especially a variety of affective states,^{85,86} as well as prospective indicators of smoking lapses,⁸⁷⁻⁸⁹ which have implications for knowledge about the smoking relapse process.⁹⁰ EMA methods have been used successfully with adolescents as well; these methods have shown links between tobacco use and both high levels of anxiety⁹¹ and symptoms of attention deficit hyperactivity disorder.⁹²

The interest here in bringing attention to the EMA methodology is twofold: it holds great promise for merging the microcontext, such as interpersonal interactions, with internal states and cognitions, and it permits a simultaneous level of measurement of macrocontextual features. The essence of the approach is being able to repeatedly prompt participants in “real-time” and “real-life” contexts with questions concerning how they are feeling, what they are doing, who they are with, and where they are. For example, Shapiro and colleagues⁹³ reported that adult smoking was associated with particular activities and locations such as work breaks, being in a car, and outdoors, reflecting the increasing restrictions on where smoking can take place. Chandra and colleagues⁹⁴ have found that environmental restrictions seem to affect the smoking patterns of some individuals more than others.

The interesting studies reviewed above begin to highlight the potential for using EMA to assess, in an integrated and ecologically sensitive manner, actual smoking behaviors along with concurrent information on affective and cognitive states, interpersonal contexts, and broader macrocontexts (and although not reviewed here, it is also possible to record physiological data as well by using ambulatory recording methods) within genetically informative samples. The intensive, repeated intervals that can be

used during the day and across days permits a complex stream of potential antecedents, correlates, and consequences of smoking which, when crossed with a genetically informative design, will yield a potentially overwhelming overlay of proximal variables at multiple levels of analysis. Sophisticated data analytic tools have been (and continue to be) developed to work with such “intensive longitudinal data.”⁹⁵

Illustration of EMA in a Family-Based Design

To demonstrate the feasibility of collecting EMA data in a family-based design, this section contains a brief overview of methods and some illustrative data derived from the ongoing Sibling Partners Study. This study focused on 60 adolescent sibling pairs drawn from the New England Family Study who have participated in the three-generation family study of nicotine dependence by the Brown TTURC. The sibling pairs were recorded in real time, using programmed PDAs, with a variable interval between their prompts to minimize subject reactivity while permitting logical overlap in the chronology of their responses. They were prompted on a variable schedule every 30 to 45 minutes, starting with the time they typically woke and ending with the time they typically went to sleep (these times were determined for each projected day of recording during an intake interview conducted the night before data collection began). Participants were also allowed to indicate times during the day when they structurally could not respond to the prompts (e.g., sports practice) and were also instructed not to respond to the PDA if that behavior could be harmful (e.g., while driving). Because this was a family-based design with participants from multiple states, data were recorded during school hours. Participants were asked to provide daily responses to the PDA for six consecutive days; the same protocol was used both 6 months and 12 months after the baseline assessment.

This study illustrates a few aspects of the methodology that may be useful for future genetically informative designs (such as twin studies). First, the compliance rate (at each wave and across waves) was excellent. Nearly all subjects responded to over 80% of the PDA prompts (producing on average more than 100 data points across the six days of recording at each wave). Second, table 11.1 provides examples of some of the PDA diary items along with response choices to demonstrate how social context, mood, interpersonal dynamics, and smoking behaviors can be assessed (it takes approximately 60 seconds for a participant to respond to all 47 prompts).

Third, preliminary descriptive data are presented to show how smoking behavior, recorded every 30 to 45 minutes, varies according to two levels of social context as represented by two diary items: “Location” (Where Am I Now?) and “Whom” (Right Now, I Am With). Graphs (see figure 11.3) show the percentage of diary responses to each “Cigarettes” prompt (Since Last Beep # of Cigarettes Smoked) aggregated over the six-day recording period across all individuals; note that these data are presented descriptively, without application of the statistical models suitable to these data, to simply show the potential utility of EMA.

For these purposes, the responses were dichotomized, and the figures show the percentage of epochs in which any cigarette smoking was endorsed (as opposed to “none at all”) as a function of both “Location” and “Whom.” The number of epochs with a positive endorsement of any smoking was higher when with the sibling partner as compared with when alone, with other family members, or with other family members plus the sibling partner. There are also suggestions that “Location” plays a role; for example, smoking percentages with a sibling increase when at a shopping mall but decrease at this location when with other family members (with or without the sibling partner). Again,

these percentages demonstrate how multiple levels of both micro- and macrocontext can be combined using EMA. To illustrate this further, figure 11.4 summarizes the pattern of endorsed smoking epochs over the six-day period for a concordant pair of siblings who are often concordant at real points in time. For each data point represented, information on where they were, whom they were with, their moods, and dynamics of their interactions with each other are included.

Potential Contribution of EMA to Genetically Informative Designs

In summary, newer methodologies such as EMA offer untapped potential for genetically informative designs from the perspective of exploring gene-environment interplay because of the unique opportunities to gather simultaneous, ecologically valid, proximal indicators of social context. Application to twin studies (and similar genetic designs) would allow a new class of questions to be asked on the degree to which smoking behavior varies as a function of both genetic similarity and social context. Furthermore, EMA methods could be used to examine or validate differential smoking patterns in individuals as a function of both candidate gene markers and proximal indicators of social context. Finally, given the perspective that smoking phenotypes will involve multiple levels (chapter 3), the simultaneous assessment of smoking behavior along with both micro- and macrocontextual information could eventually yield novel phenotypes for genetic studies that are defined, in part, by the context in which they arise.

Future Directions

The findings presented in this chapter have two key implications. First, it is possible that overall population estimates of the heritability of smoking could reflect an aggregation of very different etiological

Table 11.1 Sibling Partners Diary Prompts

Location	Where am I now? Home Friend's School or work Store or mall Event Car-bus Outdoors Somewhere else
Whom	Right now, I am with: Sib-partner Other family Both Neither
Activity 1	What am I doing now (primary activity)? Getting ready Homework Computer TV or music Hanging out w/ friends More choices
Activity 2	What am I doing now (primary activity)? Exercise/sports Errands/chores Hanging out Talking/phone Videos or games Other activity Go back
Activity_with 1	I am doing this: Alone With someone
Activity_with 2	Who am I doing this with? (check all) Sib-partner Other siblings Mother Father Other adults Friends/others
Activity_with 3	Who (else) is nearby? (check all) No one Parents Other siblings Friend(s) Other adult(s)
Irritated	How irritated/angry am I feeling now? Not at all Just a little Pretty much Very much
Relaxed	How relaxed am I feeling now? Not at all Just a little Pretty much Very much

Table 11.1 Sibling Partners Diary Prompts (*continued*)

Focused	How focused am I feeling now? Not at all Just a little Pretty much Very much
Worried	How worried am I feeling now? Not at all Just a little Pretty much Very much
Sib_with	Been w/ your sib-partner in the last 45 minutes? Yes No
Sib_quality	Quality of my interaction w/ sib-partner was (check all): Special Pleasant Neutral Uncomfortable Confrontational No interaction in last 45 min
Sib_annoyed	In the last 45 min I'm a bit annoyed at my sib-partner My sib-partner is a bit annoyed at me Both are true Neither is true
Sib_talked	In the last 45 min my sib-partner & I talked Not at all Just a little Pretty much Very much
Sib_feel_good	While together he/she made me feel good about myself? Not at all Just a little Pretty much Very much
Sib_argued	While together we argued/fought Not at all Just a little Pretty much Very much
Sib_mischief	What we did together might be considered mischievous Not at all Just a little Pretty much Very much
Urge_smoke	In the last 45 min my urge to smoke: Not at all Just a little Pretty much Very much
Cigarettes	Since last beep # of cigarettes smoked: A few puffs 1 to 2 3 to 5 More than 5 None at all

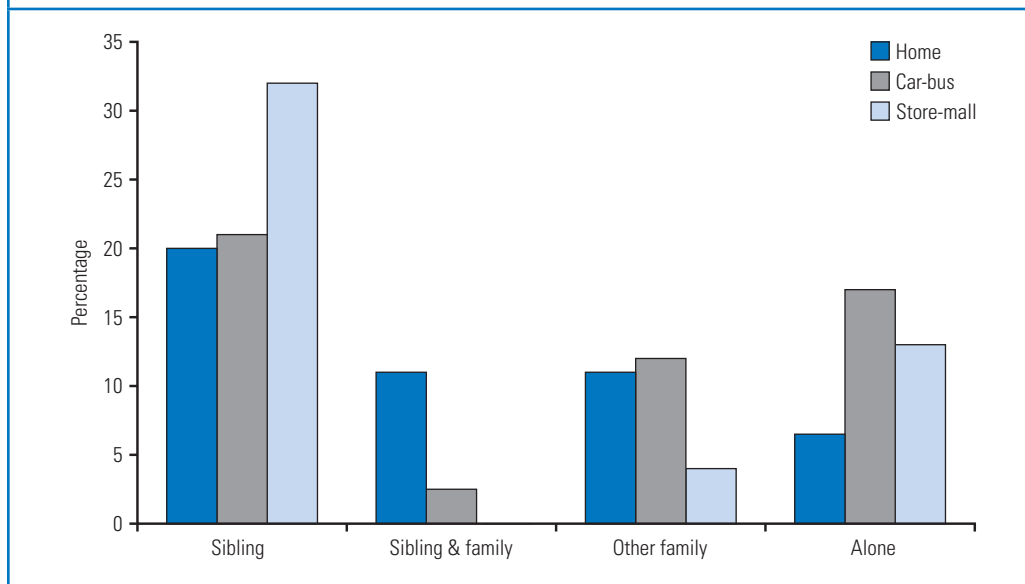
Figure 11.3 Percentage of Diary Responses Endorsing Cigarette Use Stratified by Social Contexts

architectures that vary on the basis of measurable social contextual factors. Thus, there may be etiological heterogeneity in the mix of genes and environments that can only be captured by incorporating candidate social contextual measures in genetically informative designs. *Insight into the mechanisms underlying such etiological heterogeneity will not be achieved without considering a broad number of both macro- and microsocial factors.* Although this chapter focused on highly selected social contextual factors to illustrate a number of concepts and methods of relevance to genetically informative designs, the analogy can be made that a “whole-environment” scan would carry as much importance as a whole-genome analysis in the eventual construction of satisfactory mechanistic etiological models of nicotine dependence. Second, evaluating sources of etiological heterogeneity may help in understanding the mechanisms by which endophenotypes (chapter 8) become salient for smoking behaviors under specific environmental conditions and not others. That is, crossing advanced measurement of

both endophenotypes and social contexts may illuminate core environmental factors that dwarf individual-level propensities as well as highlight especially prominent endophenotypes that convey risk under particular environmental conditions.

It is reasonable to assume that a multitude of genetic strategies eventually will yield replicable findings supporting multiple genes with direct relevance to nicotine dependence, such as the 2007 report from Bierut and colleagues.⁹⁶ It also is reasonable to postulate some direct pathways between candidate genes and propensity to develop nicotine dependence that may be somewhat impervious to the social environment, once exposure to nicotine takes place. However, it is becoming increasingly untenable to ignore social contextual factors without sacrificing a broader and more comprehensive understanding of the etiological architecture of complex phenotypes such as nicotine dependence. Furthermore, taking the perspective that nicotine dependence is an end point of

Figure 11.4 Pattern of Endorsed Smoking Epochs over a Six-Day Period for a Concordant Sibling Pair

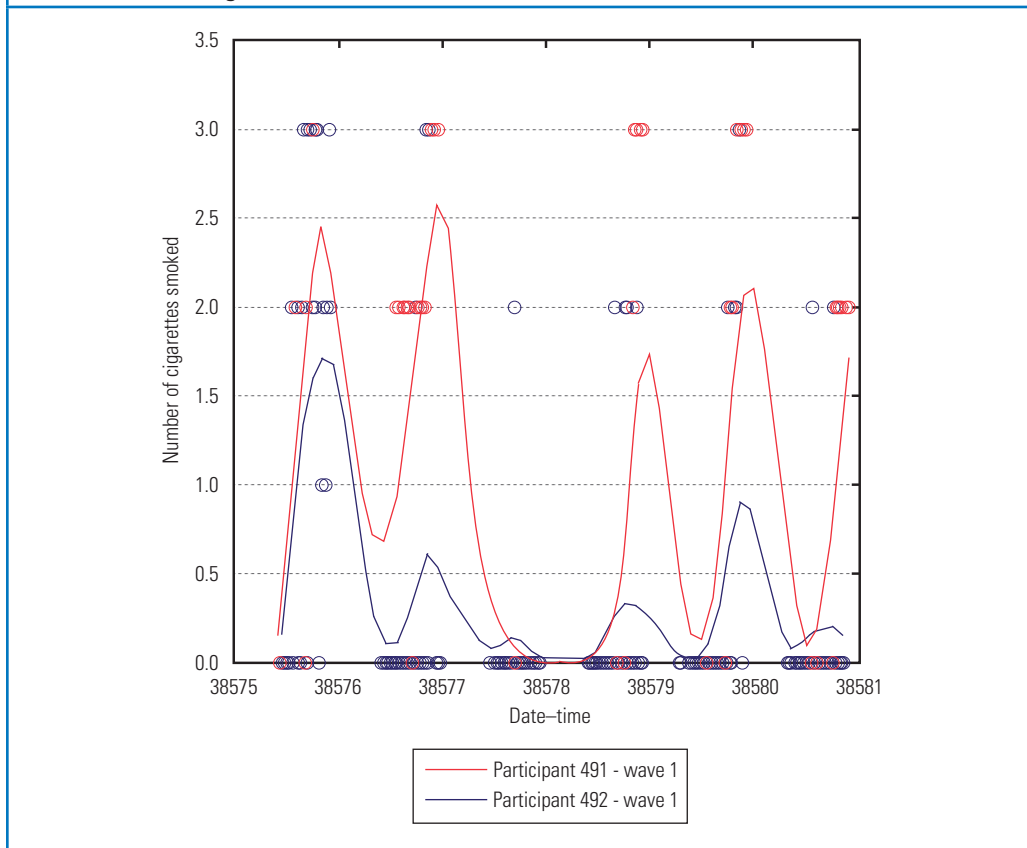

complex behavioral and physiological pathways that stretch across multiple periods of the life course reinforces the notion that empirically supported environmental influences on earlier stages of smoking play, at a minimum, an indirect role in shaping the expression of genetic susceptibility.

If the field is to take seriously the proposition that gene-environment interplay will play a key role in eventually understanding the mechanisms by which genes contribute to smoking behavior and nicotine dependence,¹ a dedicated effort will be needed not only to incorporate environmental measures with more regularity and vigor but also to invest the time, resources, and collaborative expertise necessary to provide the best

available data on the environment.^{4,5} It is worth noting here the Genes, Environment and Health Initiative of the National Institutes of Health,⁹⁷ which includes a component to develop novel and precise measures of exposure to disease-causing agents in the environment.

Summary

The key yield from behavioral genetic studies of smoking that have included attention to the social context is that they demonstrate how the heritability of complex phenotypes can fluctuate, depending on varying social factors. Genetic pathways to nicotine dependence are not activated if social

conditions dampen the likelihood of smoking initiation (as is the case for females in China) as would be predicted by application of the genetic epidemiological triangle to smoking. Certain socioregional characteristics can either diminish the impact of heritable influences on substance use or make genetic differences across individuals salient (as is the case for adolescents in Finland). Some of the predictive power attributed to genes in quantitative genetic models may be explained away by microsial influences such as having peers, parents, and siblings who smoke (as is the case for adolescents in the Netherlands). These studies provide empirical evidence that the extent to which genetic differences between individuals affect the likelihood of smoking depends in part on multiple levels of the social context, reinforcing that genetic effects for complex phenotypes are not deterministic, but rather probabilistic, and best defined via reference to the social environments in which they arise.

This chapter has provided a highly selective overview of relatively new methods for assessing “molecular” aspects of social context at both a macro and micro level. These methods were chosen to illustrate approaches that make conceptual sense in typical behavioral genetic or epidemiological designs and that can fold into these designs with relative ease, given both the types of samples studied and the size of such samples. Although there are costs involved in the application of these methods, these need to be weighed against the likelihood of their necessity in building more comprehensive and realistic models of genetic effects on smoking.

Conclusions

1. Social context influences on developmental pathways to nicotine dependence reflect gene-environment interplay that comprises the elements of a traditional epidemiological framework including a host (e.g., smokers and genetic endowment), environmental factors (social network), and an agent (e.g., tobacco).
2. Macrocontextual factors such as culture, socioregional variables, and socioeconomic status can modify or even nullify genetic influences on nicotine dependence. For example, a twin study revealed a prevalence rate for smoking of less than 1% in Chinese women, reflecting an inhibitory cultural influence. Family or neighborhood socioeconomic status and density of tobacco sales outlets are examples of specific contextual factors that appear to influence smoking risk among adolescents.
3. Microcontextual approaches have revealed factors such as exposure to parental, sibling, and peer smoking that may moderate genetic influence on behavioral smoking measures. The genetically informative Nonshared Environment in Adolescent Development Project, which comprised twins as well as other siblings, indicated that sibling interaction patterns may moderate the shared environmental effects that influence adolescent smoking.
4. Studies of smoking behavior using ecological momentary assessment, designed to measure both macro- and microcontextual factors, show that smoking behavior varies with both location and companions. Such assessments serve as a possible future model for incorporating integrated social context issues such as actual clinical and public health efforts to reduce tobacco use within etiological architectures.
5. Future work incorporating social context within gene-environment studies of smoking behavior and nicotine dependence will benefit from a greater focus on environmental factors, including more-fine-grained and comprehensive assessments of potential environmental influences.

References

1. Lessov, C. N., G. E. Swan, H. Z. Ring, T. V. Khroyan, and C. Lerman. 2004. Genetics and drug use as a complex phenotype. *Substance Use and Misuse* 39 (10–12): 1515–69.
2. Boms, U., K. Silventoinen, P. A. Madden, A. C. Heath, and J. Kaprio. 2006. Genetic architecture of smoking behavior: A study of Finnish adult twins. *Twin Research and Human Genetics* 9 (1): 64–72.
3. Rende, R., and I. Waldman. 2006. Behavioral and molecular genetics and developmental psychopathology. In *Developmental Psychopathology*, 2nd ed., ed. D. Cicchetti and D. J. Cohen, 427–64. Hoboken, NJ: Wiley.
4. Moffitt, T. E. 2005. The new look of behavioral genetics in developmental psychopathology: Gene-environment interplay in antisocial behaviors. *Psychological Bulletin* 131 (4): 533–54.
5. Moffitt, T. E., A. Caspi, and M. Rutter. 2005. Strategy for investigating interactions between measured genes and measured environments. *Archives of General Psychiatry* 62 (5): 473–81.
6. Rutter, M., T. E. Moffitt, and A. Caspi. 2006. Gene-environment interplay and psychopathology: Multiple varieties but real effects. *Journal of Child Psychology and Psychiatry* 47 (3–4): 226–61.
7. Merikangas, K. R., and S. Avenevoli. 2000. Implications of genetic epidemiology for the prevention of substance use disorders. *Addictive Behaviors* 25 (6): 807–20.
8. Eaves, L. J. 1982. The utility of twins. In *Genetic basis of the epilepsies*, ed. Anderson V., W. A. Hauser, J. K. Penry, and C. F. Sing, 249–76. New York: Raven Press.
9. Shanahan, M. J., and S. M. Hofer. 2005. Social context in gene-environment interactions: Retrospect and prospect. *Journals of Gerontology Series B: Psychological Sciences and Social Sciences* 60 Spec. No. 1: 65–76.
10. Turner, L., R. Mermelstein, and B. Flay. 2004. Individual and contextual influences on adolescent smoking. *Annals of the New York Academy of Sciences* 1021: 175–97.
11. Turkheimer, E., B. M. D’Onofrio, H. H. Maes, and L. J. Eaves. 2005. Analysis and interpretation of twin studies including measures of the shared environment. *Child Development* 76 (6): 1217–33.
12. Purcell, S., and K. C. Koenen. 2005. Environmental mediation and the twin design. *Behavior Genetics* 35 (4): 491–98.
13. Kendler, K. S., S. H. Aggen, C. A. Prescott, K. C. Jacobson, and M. C. Neale. 2004. Level of family dysfunction and genetic influences on smoking in women. *Psychological Medicine* 34 (7): 1263–69.
14. Timberlake, D. S., S. H. Rhee, B. C. Haberstick, C. Hopfer, M. Ehringer, J. M. Lessem, A. Smolen, and J. K. Hewitt. 2006. The moderating effects of religiosity on the genetic and environmental determinants of smoking initiation. *Nicotine & Tobacco Research* 8 (1): 123–33.
15. O’Connor, R. J., G. A. Giovino, L. T. Kozlowski, S. Shiffman, A. Hyland, J. T. Bernert, R. S. Caraballo, and K. M. Cummings. 2006. Changes in nicotine intake and cigarette use over time in two nationally representative cross-sectional samples of smokers. *American Journal of Epidemiology* 164 (8): 750–5.
16. Lessov-Schlaggar, C. N., Z. Pang, G. E. Swan, Q. Guo, S. Wang, W. Cao, J. B. Unger, C. A. Johnson, and L. Lee. 2006. Heritability of cigarette smoking and alcohol use in Chinese male twins: The Qingdao twin registry. *International Journal of Epidemiology* 35 (5): 1278–85.
17. Kendler, K. S., L. M. Thornton, and N. L. Pedersen. 2000. Tobacco consumption in Swedish twins reared apart and reared together. *Archives of General Psychiatry* 57 (9): 886–92.
18. Heath, A. C., R. Cates, N. G. Martin, J. Meyer, J. K. Hewitt, M. C. Neale, and L. J. Eaves. 1993. Genetic contribution to risk of smoking initiation: Comparisons across birth cohorts and across cultures. *Journal of Substance Abuse* 5 (3): 221–46.
19. Madden, P. A., N. L. Pedersen, J. Kaprio, M. J. Koskenvuo, and N. G. Martin. 2004. The epidemiology and genetics of smoking initiation and persistence: Crosscultural comparisons of twin study results. *Twin Research* 7 (1): 82–97.
20. Rose, R. J., D. M. Dick, R. J. Viken, and J. Kaprio. 2001. Gene-environment interaction in patterns of adolescent drinking: Regional residency moderates longitudinal influences on alcohol use. *Alcoholism, Clinical and Experimental Research* 25 (5): 637–43.
21. Dick, D. M., R. J. Rose, R. J. Viken, J. Kaprio, and M. Koskenvuo. 2001.

- Exploring gene-environment interactions: Socioregional moderation of alcohol use. *Journal of Abnormal Psychology* 110 (4): 625–32.
22. Kendler, K. S., and C. O. Gardner Jr. 1998. Twin studies of adult psychiatric and substance dependence disorders: Are they biased by differences in the environmental experiences of monozygotic and dizygotic twins in childhood and adolescence? *Psychological Medicine* 28 (3): 625–33.
23. Kendler, K. S., M. C. Neale, P. Sullivan, L. A. Corey, C. O. Gardner, and C. A. Prescott. 1999. A population-based twin study in women of smoking initiation and nicotine dependence. *Psychological Medicine* 29 (2): 299–308.
24. Pergadia, M. L., A. C. Heath, A. Agrawal, K. K. Bucholz, N. G. Martin, and P. A. Madden. 2006. The implications of simultaneous smoking initiation for inferences about the genetics of smoking behavior from twin data. *Behavior Genetics* 36 (4): 567–76.
25. Hamilton, A. S., C. N. Lessov-Schlaggar, M. G. Cockburn, J. B. Unger, W. Cozen, and T. M. Mack. 2006. Gender differences in determinants of smoking initiation and persistence in California twins. *Cancer Epidemiology, Biomarkers, & Prevention* 15 (6): 1189–97.
26. Rhee, S. H., J. K. Hewitt, S. E. Young, R. P. Corley, T. J. Crowley, and M. C. Stallings. 2003. Genetic and environmental influences on substance initiation, use, and problem use in adolescents. *Archives of General Psychiatry* 60 (12): 1256–64.
27. Vink, J. M., G. Willemsen, and D. I. Boomsma. 2003. The association of current smoking behavior with the smoking behavior of parents, siblings, friends and spouses. *Addiction* 98 (7): 923–31.
28. White, V. M., J. L. Hopper, A. J. Wearing, and D. J. Hill. 2003. The role of genes in tobacco smoking during adolescence and young adulthood: A multivariate behaviour genetic investigation. *Addiction* 98 (8): 1087–1100.
29. Rende, R., C. Slomkowski, E. Lloyd-Richardson, and R. Niaura. 2005. Sibling effects on substance use in adolescence: Social contagion and genetic relatedness. *Journal of Family Psychology* 19 (4): 611–18.
30. Slomkowski, C., R. Rende, S. Novak, E. Lloyd-Richardson, and R. Niaura. 2005. Sibling effects on smoking in adolescence: Evidence for social influence from a genetically informative design. *Addiction* 100 (4): 430–38.
31. Alamar, B., and S. A. Glantz. 2006. Effect of increased social unacceptability of cigarette smoking on reduction in cigarette consumption. *American Journal of Public Health* 96 (8): 1359–63.
32. Christakis, N. A., and J. H. Fowler. 2008. The collective dynamics of smoking in a large social network. *New England Journal of Medicine* 358 (21): 2249–58.
33. Hu, M. C., M. Davies, and D. B. Kandel. 2006. Epidemiology and correlates of daily smoking and nicotine dependence among young adults in the United States. *American Journal of Public Health* 96 (2): 299–308.
34. Gilman, S. E., D. B. Abrams, and S. L. Buka. 2003. Socioeconomic status over the life course and stages of cigarette use: Initiation, regular use, and cessation. *Journal of Epidemiology and Community Health* 57 (10): 802–8.
35. Kestila, L., S. Koskinen, T. Martelin, O. Rahkonen, T. Pensola, S. Pirkola, K. Patja, and A. Aromaa. 2006. Influence of parental education, childhood adversities, and current living conditions on daily smoking in early adulthood. *European Journal of Public Health* 16 (6): 617–26.
36. Jefferis, B., H. Graham, O. Manor, and C. Power. 2003. Cigarette consumption and socio-economic circumstances in adolescence as predictors of adult smoking. *Addiction* 98 (12): 1765–72.
37. Fagan, P., J. S. Brook, E. Rubenstone, and C. Zhang. 2005. Parental occupation, education, and smoking as predictors of offspring tobacco use in adulthood: A longitudinal study. *Addictive Behaviors* 30 (3): 517–29.
38. Turkheimer, E., A. Haley, M. Waldron, B. D'Onofrio, and I. I. Gottesman. 2003. Socioeconomic status modifies heritability of IQ in young children. *Psychological Science* 14 (6): 623–2.
39. Harden, K. P., E. Turkheimer, and J. C. Loehlin. 2007. Genotype by environment interaction in adolescents' cognitive aptitude. *Behavior Genetics* 37 (2): 273–83.
40. Unger, J. B., P. Sun, and C. A. Johnson. 2007. Socioeconomic correlates of smoking among an ethnically diverse sample of 8th grade adolescents in Southern California. *Preventive Medicine* 44 (4): 323–27.

41. Diez Roux, A. V., S. S. Merkin, P. Hannan, D. R. Jacobs, and C. I. Kiefe. 2003. Area characteristics, individual-level socioeconomic indicators, and smoking in young adults: The coronary artery disease risk development in young adults study. *American Journal of Epidemiology* 157 (4): 315–26.
42. Giskes, K., F. J. van Lenthe, G. Turrell, J. Brug, and J. P. Mackenbach. 2006. Smokers living in deprived areas are less likely to quit: A longitudinal follow-up. *Tobacco Control* 15 (6): 485–88.
43. Virtanen, M., M. Kivimaki, A. Kouvonen, M. Elovainio, A. Linna, T. Oksanen, and J. Vahtera. 2007. Average household income, crime, and smoking behaviour in a local area: The Finnish 10-Town study. *Social Science and Medicine* 64 (9): 1904–13.
44. Miles, R. 2006. Neighborhood disorder and smoking: Findings of a European urban survey. *Social Science and Medicine* 63 (9): 2464–75.
45. Novak, S. P., S. F. Reardon, S. W. Raudenbush, and S. L. Buka. 2006. Retail tobacco outlet density and youth cigarette smoking: A propensity-modeling approach. *American Journal of Public Health* 96 (4): 670–76.
46. Croner, C. M., J. Sperling, and F. R. Broome. 1996. Geographic information systems (GIS): New perspectives in understanding human health and environmental relationships. *Statistics in Medicine* 15 (17–18): 1961–77.
47. Chassin, L., and E. D. Handley. 2006. Parents and families as contexts for the development of substance use and substance use disorders. *Psychology of Addictive Behaviors* 20 (2): 135–37.
48. Conrad, K. M., B. R. Flay, and D. Hill. 1992. Why children start smoking cigarettes: Predictors of onset. *British Journal of Addiction* 87 (12): 1711–24.
49. Kobus, K. 2003. Peers and adolescent smoking. *Addiction* 98 Suppl. 1: 37–55.
50. Alamar, B., and S. A. Glantz. 2006b. Modeling addictive consumption as an infectious disease. *B.E. Journal of Economic Analysis & Policy* 5 (1): Article 7.
51. Avenevoli, S., and K. R. Merikangas. 2003. Familial influences on adolescent smoking. *Addiction* 98 Suppl. 1: 1–20.
52. Rosendahl, K. I., M. R. Galanti, H. Gilljam, and A. Ahlbom. 2003. Smoking mothers and snuffing fathers: Behavioural influences on youth tobacco use in a Swedish cohort. *Tobacco Control* 12 (1): 74–78.
53. Agrawal, A., P. A. Madden, A. C. Heath, M. T. Lynskey, K. K. Bucholz, and N. G. Martin. 2005. Correlates of regular cigarette smoking in a population-based sample of Australian twins. *Addiction* 100 (11): 1709–19.
54. Farkas, A. J., E. A. Gilpin, M. M. White, and J. P. Pierce. 2000. Association between household and workplace smoking restrictions and adolescent smoking. *JAMA: The Journal of the American Medical Association* 284 (6): 7171–22.
55. Lieb, R., A. Schreier, H. Pfister, and H. U. Wittchen. 2003. Maternal smoking and smoking in adolescents: A prospective community study of adolescents and their mothers. *European Addiction Research* 9 (3): 120–30.
56. Clark, D. B., and J. Cornelius. 2004. Childhood psychopathology and adolescent cigarette smoking: A prospective survival analysis in children at high risk for substance use disorders. *Addictive Behaviors* 29 (4): 837–41.
57. Bricker, J. B., K. B. Rajan, M. R. Andersen, and A. V. Peterson Jr. 2005. Does parental smoking cessation encourage their young adult children to quit smoking? A prospective study. *Addiction* 100 (3): 379–86.
58. Chassin, L., C. Presson, J. Rose, S. J. Sherman, and J. Prost. 2002. Parental smoking cessation and adolescent smoking. *Journal of Pediatric Psychology* 27 (6): 485–96.
59. den Exter Blokland, E. A., R. C. Engels, W. W. Hale 3rd, W. Meeus, and M. C. Willemsen. 2004. Lifetime parental smoking history and cessation and early adolescent smoking behavior. *Preventive Medicine* 38 (3): 359–68.
60. McGee, R., S. Williams, and A. Reeder. 2006. Parental tobacco smoking behaviour and their children's smoking and cessation in adulthood. *Addiction* 101 (8): 1193–201.
61. Hoffman, B. R., S. Sussman, J. B. Unger, and T. W. Valente. 2006. Peer influences on adolescent cigarette smoking: A theoretical review of the literature. *Substance Use and Misuse* 41 (1): 103–55.
62. de Vries, H., M. Candell, R. Engels, and L. Mercken. 2006. Challenges to the peer influence paradigm: Results for 12-13 year olds from six European countries from the

- European Smoking Prevention Framework Approach study. *Tobacco Control* 15 (2): 83–89.
63. Bricker, J. B., A. V. Peterson, M. Robyn Andersen, B. G. Leroux, K. Bharat Rajan, and I. G. Sarason. 2006. Close friends', parents', and older siblings' smoking: Reevaluating their influence on children's smoking. *Nicotine & Tobacco Research* 8 (2): 217–26.
 64. Bricker, J. B., A. V. Peterson Jr, B. G. Leroux, M. R. Andersen, K. B. Rajan, and I. G. Sarason. 2006. Prospective prediction of children's smoking transitions: Role of parents' and older siblings' smoking. *Addiction* 101 (1): 128–36.
 65. Kokkevi, A., C. Richardson, S. Florescu, M. Kuzman, and E. Stergar. 2007. Psychosocial correlates of substance use in adolescence: A cross-national study in six European countries. *Drug and Alcohol Dependence* 86 (1): 67–74.
 66. Charlesworth, A., and S. A. Glantz. 2005. Smoking in the movies increases adolescent smoking: A review. *Pediatrics* 116 (6): 1516–28.
 67. Wills, T. A., J. D. Sargent, M. Stoolmiller, F. X. Gibbons, K. A. Worth, and S. D. Cin. 2007. Movie exposure to smoking cues and adolescent smoking onset: A test for mediation through peer affiliations. *Health Psychology* 26 (6): 769–76.
 68. Kendler, K. S., and J. H. Baker. 2007. Genetic influences on measures of the environment: A systematic review. *Psychological Medicine* 37 (5): 615–26.
 69. Kodl, M. M., and R. Mermelstein. 2004. Beyond modeling: Parenting practices, parental smoking history, and adolescent cigarette smoking. *Addictive Behaviors* 29 (1): 17–32.
 70. Chassin, L., C. C. Presson, J. Rose, S. J. Sherman, M. J. Davis, and J. L. Gonzalez. 2005. Parenting style and smoking-specific parenting practices as predictors of adolescent smoking onset. *Journal of Pediatric Psychology* 30 (4): 333–44.
 71. Harakeh, Z., R. H. Scholte, H. de Vries, and R. C. Engels. 2005. Parental rules and communication: Their association with adolescent smoking. *Addiction* 100 (6): 862–70.
 72. Bullock, B. M., and T. J. Dishion. 2007. Family processes and adolescent problem behavior: Integrating relationship narratives into understanding development and change. *Journal of the American Academy of Child & Adolescent Psychiatry* 46 (3): 396–407.
 73. Bullock, B. M., L. Bank, and B. Burraston. 2002. Adult sibling expressed emotion and fellow sibling deviance: A new piece of the family process puzzle. *Journal of Family Psychology* 16 (3): 307–17.
 74. Dishion, T. J., and J. Snyder. 2004. An introduction to the special issue on advances in process and dynamic system analysis of social interaction and the development of antisocial behavior. *Journal of Abnormal and Child Psychology* 32 (6): 575–78.
 75. Dishion, T. J., and L. D. Owen. 2002. A longitudinal analysis of friendships and substance use: Bidirectional influence from adolescence to adulthood. *Developmental Psychology* 38 (4): 480–91.
 76. Dishion, T. J., S. E. Nelson, C. E. Winter, and B. M. Bullock. 2004. Adolescent friendship as a dynamic system: Entropy and deviance in the etiology and course of male antisocial behavior. *Journal of Abnormal and Child Psychology* 32 (6): 651–63.
 77. Stormshak, E. A., C. A. Comeau, and S. A. Shepard. 2004. The relative contribution of sibling deviance and peer deviance in the prediction of substance use across middle childhood. *Journal of Abnormal and Child Psychology* 32 (6): 635–49.
 78. Neiderhiser, J. M., D. Reiss, and E. M. Hetherington. 2007. The Nonshared Environment in Adolescent Development (NEAD) project: A longitudinal family study of twins and siblings from adolescence to young adulthood. *Twin Research and Human Genetics* 10 (1): 74–83.
 79. Agrawal, A., A. C. Heath, J. D. Grant, M. L. Pergadia, D. J. Statham, K. K. Bucholz, N. G. Martin, and P. A. Madden. 2006. Assortive mating for cigarette smoking and for alcohol consumption in female Australian twins and their spouses. *Behavior Genetics* 36 (4): 553–66.
 80. Kuo, P. H., P. Wood, K. I. Morley, P. Madden, N. G. Martin, and A. C. Heath. 2007. Cohort trends in prevalence and spousal concordance for smoking. *Drug and Alcohol Dependence* 88 (2–3): 122–29.
 81. Shortt, J. W., D. M. Capaldi, T. J. Dishion, L. Bank, and L. D. Owen. 2003. The role

- of adolescent friends, romantic partners, and siblings in the emergence of the adult antisocial lifestyle. *Journal of Family Psychology* 17 (4): 521–33.
82. Stone, A. A., and S. Shiffman. 2002. Capturing momentary, self-report data: A proposal for reporting guidelines. *Annals of Behavioral Medicine* 24 (3): 236–43.
 83. Stone, A., S. Shiffman, A. Atienza, and Nebeling L., ed. 2007. *The science of real-time data capture: Self-reports in health research*. New York: Oxford Univ. Press.
 84. Shiffman, S., and J. Paty. 2006. Smoking patterns and dependence: Contrasting chippers and heavy smokers. *Journal of Abnormal Psychology* 115 (3): 509–23.
 85. Delfino, R. J., L. D. Jamner, and C. K. Whalen. 2001. Temporal analysis of the relationship of smoking behavior and urges to mood states in men versus women. *Nicotine & Tobacco Research* 3 (3): 235–48.
 86. Shiffman, S., C. J. Gwaltney, M. H. Balabanis, K. S. Liu, J. A. Paty, J. D. Kassel, M. Hickcox, and M. Gnys. 2002. Immediate antecedents of cigarette smoking: An analysis from ecological momentary assessment. *Journal of Abnormal Psychology* 111 (4): 531–45.
 87. Gwaltney, C. J., S. Shiffman, M. H. Balabanis, and J. A. Paty. 2005. Dynamic self-efficacy and outcome expectancies: Prediction of smoking lapse and relapse. *Journal of Abnormal Psychology* 114 (4): 661–75.
 88. Shiffman, S., S. G. Ferguson, and C. J. Gwaltney. 2006. Immediate hedonic response to smoking lapses: Relationship to smoking relapse, and effects of nicotine replacement therapy. *Psychopharmacology (Berl)* 184 (3–4): 608–18.
 89. Shiffman, S., and A. J. Waters. 2004. Negative affect and smoking lapses: A prospective analysis. *Journal of Consulting and Clinical Psychology* 72 (2): 192–201.
 90. Shiffman, S. 2005. Dynamic influences on smoking relapse process. *Journal of Personality* 73 (6): 1715–48.
 91. Henker, B., C. K. Whalen, L. D. Jamner, and R. J. Delfino. 2002. Anxiety, affect, and activity in teenagers: Monitoring daily life with electronic diaries. *Journal of the American Academy of Child & Adolescent Psychiatry* 41 (6): 660–70.
 92. Whalen, C. K., L. D. Jamner, B. Henker, R. J. Delfino, and J. M. Lozano. 2002. The ADHD spectrum and everyday life: Experience sampling of adolescent moods, activities, smoking, and drinking. *Child Development* 73 (1): 209–27.
 93. Shapiro, D., L. D. Jamner, D. M. Davydov, and P. James. 2002. Situations and moods associated with smoking in everyday life. *Psychology of Addictive Behaviors* 16 (4): 342–4.
 94. Chandra, S., S. Shiffman, D. M. Scharf, Q. Dang, and W. G. Shadel. 2007. Daily smoking patterns, their determinants, and implications for quitting. *Experimental Clinical Psychopharmacology* 15 (1): 67–80.
 95. Walls, T. A., and J. L. Schafer, ed. 2005. *Models for intensive longitudinal data*. New York: Oxford Univ. Press.
 96. Bierut, L. J., P. A. Madden, N. Breslau, E. O. Johnson, D. Hatsukami, O. F. Pomerleau, G. E. Swan, et al. 2007. Novel genes identified in a high-density genome wide association study for nicotine dependence. *Human Molecular Genetics* 16 (1): 24–35.
 97. National Institutes of Health. 2007. Genes, environment and health initiative: Exposure biology program. <http://www.gei.nih.gov/exposurebiology> (accessed December 19, 2008).

Using Ontologies in Hierarchical Modeling of Genes and Exposure in Biological Pathways

David V. Conti, Juan Pablo Lewinger, Rachel F. Tyndale,
Neal L. Benowitz, Gary E. Swan, and Paul D. Thomas

Existing studies of genetic associations with nicotine dependence frequently do not reflect complex relationships between genetic, environmental, and social factors underlying tobacco use. Moreover, the scope of potential genetic variations and their impact on analysis pose a conceptual challenge to effective studies of genetic factors.

This chapter examines the potential for the use of hierarchical modeling techniques within the framework of an ontology that quantifies relationships across genotypes and phenotypes for nicotine dependence. Topics discussed include

- *An overview of the existing statistical approaches for genetic association studies in tobacco use*
- *Design and analysis considerations in the use of hierarchical modeling in conjunction with stochastic variable selection for future genetic studies of tobacco use*
- *The use of ontologies for codifying prior knowledge to support efficient computational analysis of such hierarchical models*
- *Results of a study of nicotine metabolism using the data from the Northern California Twin Registry in conjunction with the Nicotine Pharmacokinetics Ontology, showing significant genetic associations with nicotine clearance levels*

The results of this pilot study, and the potential of these approaches to overcome the methodological issues inherent in existing genetic studies, show promise for these approaches as an area for further study.

The analyses described herein were supported by National Institutes of Health grants CA084735, CA52862, DA18019, DA20830, DA02277, DA11070, and HL084705. Analysis support was also provided by University of Toronto, Canada grants CAMH, and CIHR MOP53248 and a Canada Research Chair in Pharmacogenetics.

Introduction

This chapter examines the use of ontologies as a framework for creating hierarchical models that could support quantitative, computationally driven research in biological pathways for nicotine dependence, as a potential means of linking genetic and environmental factors to yield a more accurate understanding of why people smoke. It highlights a specific example using data from the Northern California Twin Registry^{1,2} to explore the heritability of nicotine metabolism, together with a discussion of broader issues involved in creating hierarchical models in conjunction with ontologies that quantify prior knowledge of relationships linking specific genotypes, endophenotypes, and phenotypes for nicotine dependence.

The multistep nature of tobacco use progression—from initiation, to episodic use, to dependence—provides several opportunities for risk factors to act. Although distinct factors may affect each step, universal factors may also create background characteristics for an individual throughout use progression. In addition, compounding the background profile are large, punctuated events, such as intervention programs, that may substantially alter an individual's tobacco use—both in isolation and synergistically with other factors. That is, smoking behavior is a composite consisting of large social factors, interpersonal relationships, and intrapersonal characteristics. Large social patterns substantially influence smoking behavior through demographic changes, financial mechanisms, cigarette availability, and perceptions of smoking. Economic factors such as unemployment rates, income levels, and cigarette prices also affect individuals' ability to purchase cigarettes.³

Although these large social forces often affect an individual's tobacco use, close

interpersonal relationships have considerable influence as well. Personal relationships with family, friends, peer groups, and classmates form immediate surroundings and an individual's attitudes.⁴ Especially among adolescents, it is within these social networks that individuals make behavioral choices about tobacco use—choices that depend on individuals' dispositional attributes as influenced by further biological, cognitive, and emotional characteristics such as the personality traits of hostility and depression.⁵ Of course, these personality traits are also under some genetic influence. For example, monoamine oxidase (MAO), a mitochondrial enzyme consisting of two isoforms, MAOA and MAOB, is found in neuronal and nonneuronal cells in the brain.⁶ Its main function is the breakdown of neurotransmitters; it is therefore a key enzyme in the regulation of serotonin and dopamine levels in the brain. Mouse models indicate that genetic variation within MAO are associated with changes in the levels of serotonin and dopamine in the brain and a change in behavior, especially indicators of hostility and depression.⁷⁻⁹ Once an individual first smokes, the response to a particular acute or chronic dose of nicotine is determined in part by the rate of nicotine metabolism and the genes that influence metabolic function. There is a long-term physiological and psychological response as well.

To simply test the hypothesis of an association between a single genetic variant and whether an individual currently smokes or not ignores any knowledge one might have of the underlying etiologic mechanism within the analysis framework. But how does one incorporate biological information into the analysis? Often, the inclusion of previous knowledge of the underlying biological mechanism has been limited to the design phase of a study, only informing the selection of potential candidate genes and exposures. Thus, the analysis is confined to determining the independent association

of each gene via contingency tables or regression models. If joint effects are suspected, the analysis is expanded to include the search for statistical interactions or, more specifically, the search for departures of independent and additive effects on the assumed scale of the outcome.^{10–12} However, it is often unclear how suspected or known mechanistic and biological joint action will manifest in population-based inferences relying on epidemiological data. This chapter will examine how appropriate hierarchical models can move beyond the existing approaches to help form a framework for examining such interactions at a more macro level, which, in turn, may help to better understand and describe the role of biology in human smoking behavior.

Methodological Issues

When examining factors in nicotine dependence, difficulties in estimating and testing effects are compounded with the expanding numbers of exposures, genotypes, intermediate measures, and multiple phenotypes now readily available and relatively inexpensive to obtain on population samples with modern technologies. Such an extent of available information may lead an investigator to

search for interaction effects in finer strata with limited information from the data or to exclude potentially valuable measures. For instance, possible “omic” measures such as metabolomics (e.g., surrogate measure of metabolite concentrations within a pathway),^{13,14} proteomics (e.g., surrogate measures of enzyme concentration or activity within a pathway),^{15,16} epigenomics (e.g., DNA methylation),¹⁷ and interactome (e.g., protein-protein binding interactions)^{18–20} are ignored in conventional gene-disease association analyses, or they are treated as an outcome in gene to intermediate-phenotype studies. Inclusion of all measures (e.g., exposures, genes, intermediate phenotypes, and disease) in a structured joint analysis may provide valuable information in clarifying the separate component contributions, their aggregate effects in complex pathways, and ultimately, determining an individual’s overall risk of disease. Furthermore, each factor may contribute only a small effect that may be detected only when all relevant factors are considered together. Here, conventional regression models often reach their limits in attempting to model all these factors jointly.²¹

These difficulties have led to the development of many data-mining statistical

Ontologies: A Definition

An ontology is a formal structuring of knowledge.^a For the purposes here, an ontology is a *formal model* of a domain of knowledge and consists of *entities* and *relations* between entities. An entity is simply a class, or category, of things that one wishes to model. An entity can be either a *continuant* (an object existing at a particular point in time) or an *occurrent* (an event or process occurring over time). Relations can be of many types, depending on the knowledge domain being represented. Two of the most common are the “is_a” relation, which specifies one class as a subclass of another (e.g., human is_a mammal), and the “part_of” relation (e.g., finger part_of hand). Ontologies have their origins in Aristotelian philosophy, but computer science has driven a renaissance in ontology development and use—initially, by the problem of representing computational knowledge in the artificial intelligence field, and subsequently, the Semantic Web.

^aSmith, B., W. Ceusters, B. Klagges, J. Kohler, A. Kumar, J. Lomax, C. Mungall, F. Neuhaus, A. L. Rector, and C. Rosse. 2005. Relations in biomedical ontologies. *Genome Biology* 6 (5): R46.

techniques aimed at detecting higher-order interactions.²² Such approaches include tree-based methods based on recursive partitioning of the data, such as random forests²³ and logic regression.²⁴ For these methods, the data are split by a single binary variable into two subsamples with varying trait or outcome characteristics. These subsamples are then investigated for further splits that may be warranted on the basis of additional variables. Higher-order interactions are inferred by identifying the combination of variables and the corresponding splits that identify particular subgroups. To avoid overfitting of the data or finding splits that may exist only by chance, pruning techniques are applied to reduce the number of splits according to some pruning criteria. While these techniques can be effective at identifying higher-order interactions, there are some limitations as far as interpretability and flexibility in the modeling (e.g., including covariates and forcing in certain effects). As an alternative within the regression framework, Millstein and colleagues proposed a method called the “focused interaction testing framework.”²⁵ This approach tests main effects and interactions among multiple candidate genes by using a series of orthogonal tests in a staged manner. Specifically, this approach tests the main effect of each candidate gene in stage 1, followed by models with two-way interactions in stage 2, and with three-way interactions in stage 3. An algorithm based on controlling false discovery rates (FDRs)^{26–30} is used to control the experiment-wise type I error to a predefined level (e.g., 0.05). While simulation work has shown promise for this method when a single polymorphism is present within a gene, it is not clear how this would work when multiple correlated single nucleotide polymorphisms (SNPs) are included for several genes.

Data-mining techniques rely solely on the data for inference and ignore any prior

knowledge that may exist regarding the factors of interest, specifically that these factors may be part of a biological pathway. An editorial in *Cancer Epidemiology, Biomarkers & Prevention* in 2005³¹ laid out the case for pathway-driven research in molecular epidemiology and the need for further methods development in support of such research. The editorial described two broad types of approaches: one based on mechanistic modeling of specific pathways of interest, the other based on empirical modeling that incorporates what is known about the factors involved in a pathway in a flexible manner without requiring such strong parametric assumptions. The mechanistic approach can be thought of as a structural equation model in which the topology of the structure is specified by biological knowledge. This was first introduced in an application to a case-control study of colorectal polyps in relation to well-done red meat consumption, tobacco smoking, and the various genes involved in the metabolism of polycyclic aromatic hydrocarbons and heterocyclic amines that these exposures produce.³² Here, the sequence of intermediate metabolite equilibrium concentrations was modeled in terms of a linear pharmacokinetic model, with person-specific metabolic rate parameters that depended upon their genotypes. The entire model, comprised of regression coefficients, individual- and genotype-specific population rate parameters, and their variances, was fit by using Markov chain Monte Carlo (MCMC) methods. While the authors of this chapter are continuing to investigate the statistical performance of this approach via simulation studies in a more general setting, it is recognized that the major limitation of this approach is the expertise needed to construct the topology of the mechanistic model. Unfortunately, very few biological pathways are understood well enough to specify the specific mechanism from genes to outcome. While extensions exist

to estimate the topology, these methods rely heavily on accurately measured intermediates—intermediate measures that are often unmeasured in epidemiological studies or measured on only a subsample of individuals.

As an alternative to these highly parametric models, a background and extensions to hierarchical modeling are presented here. Hierarchical modeling with prior covariates aims at stabilizing and informing estimation by incorporating similarities among regression estimates using categories describing biological similarities between genes and exposures. To narrow the space of possible regression models, the prior probability of including any variable as a function of known biology is further structured. This is accomplished via Bayes model averaging using stochastic variable selection. Similar to the parametric models, these hierarchical models utilize prior knowledge and information to aid inference. However, in contrast to the highly specified mechanistic models, the knowledge only specifies exchangeable classes or sets of factors with similarities. Often this reduces to a series of indicator variables based on expert opinion. Because these opinions may be susceptible to subjective influences, the use of ontologies is proposed. Ontologies attempt to represent the knowledge base in a computable form to provide “a shared and common understanding of some domain that can be communicated between people and application systems.”³³ Thus, ontologies attempt to transform implicit knowledge into specific and explicit relations. Here, a discussion is provided of how these relations may be incorporated into the hierarchical models to aid in model selection, inference, and interpretation of conclusions from observational studies.

Background on Statistical Approaches

Models for Multivariate Data within a Candidate Gene

Assume an investigation of G candidate gene regions for gene association and possible identification of specific causal variants for an identified outcome. Further assume that each gene is independent from the others—that is, no linkage disequilibrium (LD) or no underlying biological interaction between genes. A quantitative trait outcome is the focus, but by using a generalized linear framework and the appropriate link function, the discussed methods can be extended to other types of traits.³⁴ In addition to J exogenous or nongenetic covariates specified in the design or covariate matrix \mathbf{W} , assume that there are M_g finely spaced SNPs within each gene, g , and that for each polymorphism, genotype-level information for all individuals in the study is obtained. β_{gm} is used as an estimate of the risk from SNP m in gene g . For clarity, the modeling on SNPs is mainly discussed; however, the following analyses are also applicable to the modeling of other genetic markers such as microsatellites. First, treating the SNPs as independent, $\sum_g M_g$ separate regressions are performed, assuming a disease model of the form (1) where X_{gm} indicates the number of variant alleles for SNP m (i.e., additive coding) in gene g (e.g., $X_{gm} = 1$ if heterozygous and $X_{gm} = 2$ if an individual carries two copies of the variant allele), although one may also consider dominant or recessive genetic models.³⁵ The parameter estimate δ_{jgm} corresponds to the effects of the j th covariate on the outcome conditioned on SNP m in gene g .

$$Y | X_{gm}, \mathbf{W} = \beta_{0gm} + \beta_{gm} X_{gm} + \sum_{j=1}^J \delta_{jgm} W_j \text{ for all } m = (1, \dots, M_g) \text{ in all } g = (1, \dots, G) \quad (1)$$

Additional information may be incorporated if one accounts for the effect of an SNP conditional on all other SNPs within the candidate region. This is accomplished with a joint main effects model of the form (2).

Here, one sums over all the SNPs within a gene g but treat each gene as independent. The parameter estimate δ_{gj} corresponds to the effects of the j th covariate on the outcome conditioned on the SNPs in gene g . By accounting for the correlations between SNPs, this model may be useful in determining the independent contribution of each SNP within a given region, but it ignores any effects due to the arrangement of SNPs either on the same chromosome (i.e., haplotypes) or combinations of SNPs within an individual (i.e., interaction).

Aiming to capture synergistic effects between SNPs within a single candidate gene, the model in equation (2) may be extended to incorporate all interaction terms between SNPs. This model builds on the joint model in equation (2), with the form (3) where $X_{gm^*g\ell} = X_{gm} * X_{g\ell}$ and “...” indicates potential higher-order interaction terms. Here, the focus is only on all pairwise second-order interactions within a gene, although one may expand this model to higher-order interactions.

In the above models, a test of the statistical significance for association to disease for each SNP can be obtained via a Wald test, score test, or likelihood ratio test (LRT) of each β_{gm} . In addition, for the main effects model (2) and interaction model (3), one

may perform an omnibus LRT comparing a full model in which β_{gm} is estimated for each of M_g markers, $\hat{\beta}_g = (\hat{\beta}_{gm}, \dots, \hat{\beta}_{gM_g})$, to the null model in which all SNP effects within the gene are set to zero. This global M_g -degree of freedom LRT provides evidence for an overall association of the chromosomal segment to disease.

When multiple SNPs are available within a gene, an alternative is to analyze the association of haplotypes to disease. For a given set of haplotypes, H_g , the haplotypic risk may be modeled by using a similar logistic regression for H_g-1 of the haplotypes (4).

Here, X_{gh} is used as an indicator variable denoting the number of haplotypes of type h that an individual possesses within gene g . Usually for the haplotype model, the most common haplotype, h_{g1} , acts as the referent haplotype. Similar to the SNP analysis, a Wald test, score test, or LRT statistic may be calculated for each η_{gh} to test associations with each haplotype. In addition, an omnibus LRT can test the overall association of the gene region to the trait. If haplotypes are unknown, one may substitute for X_{gh} an expected probability for haplotype h .^{36,37} Haplotype-based analysis as outlined in equation (4) has been advocated because of the potential reduction in the number of comparisons made (because there are usually fewer common haplotypes than common SNPs), the ability of haplotypes to better exploit patterns of LD, and the capacity to capture causal effects that may

$$Y | X_{g1}, \dots, X_{gM_g}, \mathbf{W} = \beta_{0g} + \sum_{m=1}^{M_g} \beta_{gm} X_{gm} + \sum_{j=1}^J \delta_{gj} W_j \text{ for all } g = (1, \dots, G) \quad (2)$$

$$Y | X_{g1}, \dots, X_{gM_g}, \mathbf{W} = \beta_{0g} + \sum_{m=1}^{M_g} \beta_{gm} X_{gm} + \sum_{m=1}^{M_g} \sum_{\ell \neq m}^{M_g} \beta_{gm^*g\ell} X_{gm^*g\ell} + \dots + \sum_{j=1}^J \delta_{gj} W_j \text{ for all } g = (1, \dots, G) \quad (3)$$

$$Y | X_{g1}, \dots, X_{gH}, \mathbf{W} = \beta_{0g} + \sum_{h=2}^{H_g} \eta_{gh} X_{gh} + \sum_{j=1}^J \delta_{gj} W_j \text{ for all } g = (1, \dots, G) \quad (4)$$

be due to a combination of variants on the same chromosome.^{38,39} However, to attain these potential benefits one must often narrow each region to identify a limited number of haplotypes; this is typically done by identifying blocks or continuous regions of high LD along the chromosome. This, in turn, makes haplotype analysis subject to how one determines these regions via the underlying LD structure and the accompanying uncertainty in that determination.^{40–43}

As an alternative to haplotype analysis, Conti and Gauderman⁴⁴ proposed a modified pairwise interaction term to capture phase information in equation (3) to allow for most of the haplotype information in the data to be exploited, without having to consider all possible haplotype resolutions, as required for equation (4). At the genotype level within gene g , one can approximate haplotype information by modifying the second-order interaction terms in model (3) to describe the phase between pairwise SNPs, m and ℓ , and given the two haplotypes for individual i , h_{ig1} and h_{ig2} . Specifically, the definition is given in equation (5).

The above coding assumes that the *cis* configuration or double variant haplotype is additive to disease. However, it is also possible that the *trans* configuration of the variant alleles, as defined here, may be at higher risk. In this alternative case, one can specify the reverse coding for the double heterozygotes (i.e., if $X_{gm} * X_{g\ell} = 1$, and h_{ig1} or h_{ig2} is the double variant haplotype, then

$$X_{gm,g\ell} = \begin{cases} 2 & \text{if } X_{gm} * X_{g\ell} = 4 \\ 1 & \text{if } X_{gm} * X_{g\ell} = 2 \\ 1 & \text{if } X_{gm} * X_{g\ell} = 1, \text{ and } h_{ig1} \text{ or } h_{ig2} \text{ is a double variant haplotype} \\ 0 & \text{if } X_{gm} * X_{g\ell} = 1, \text{ and } h_{ig1} \text{ and } h_{ig2} \text{ is not a double variant haplotype} \\ 0 & \text{if } X_{gm} * X_{g\ell} = 0 \end{cases} \quad (5)$$

$$\rho_{A,B}^{(cis)} = \Pr(AB, ab) = \frac{P(AB)P(ab)}{P(AB)P(ab) + P(Ab)P(aB)} \quad (6)$$

$X_{gm,g\ell} = 1$). This parameterization allows for separate tests for each SNP effect (β_{gm}), pairwise phase term ($\beta_{gm,g\ell}$), and the overall contribution of the candidate region to disease via a global LRT. When the phase is unknown, the *cis* phase term is altered to reflect the probability of a *cis* haplotype in the population for each pair of loci assuming Hardy-Weinberg equilibrium. As an example, assume two SNPs, **A** and **B**, each with two alleles, (A, a) and (B, b), respectively, as well as the four possible haplotypes, AB, Ab, aB , and ab . Thus, one can calculate the probability of the *cis* configuration of the two SNP haplotypes as given in equation (6) where $P(AB)$, $P(Ab)$, $P(aB)$, and $P(ab)$ are estimated from genotype data using the expectation maximization, or EM, algorithm.⁴⁵ This is equivalent to altering the phase term in equation (5) by setting $X_{gm,g\ell} = \rho_{gm,g\ell}^{(cis)}$ if $X_{gm} * X_{g\ell} = 1$. Thus, a genotype model with phase interaction terms not only avoids long-range haplotype estimation but also allows for the investigation of which SNPs are driving the association within each candidate gene. In addition, this model provides a flexible framework for incorporating relations among numerous SNPs over several candidate genes.

Extensions to Multiple Genes and Exposures

The above models present various alternatives to the analysis of numerous variants within a candidate gene, with the

increase in complexity aiming to better capture the LD and joint effects of multiple SNPs. The complexity may be warranted if a true causal SNP is not measured, and the analysis must rely on how the combination of measured SNPs captures the underlying effect. Of course, if a true causal variant(s) is measured, the most appropriate model may be the one that focuses solely on that variant(s), ignoring all others. In contrast, it may be the combination of several SNPs acting together that leads to variation in the outcome. In this case, simple tests of the marginal effect of each SNP may not be sufficient, and interaction terms may be necessary to detect these higher-order joint actions. Thus, even within a single gene, there are uncertainties regarding the most appropriate model to use. These uncertainties only increase as one attempts to evaluate multiple candidate genes, each with multiple polymorphisms. The previous models treat each candidate gene as independent. This assumption may be adequate if the genes are unlinked, and therefore, SNPs between candidate genes are not in LD. However, because a set of candidate genes is most often selected with a priori knowledge that they act via an underlying biological mechanism or pathway, there is a good possibility that interactions may be present across genes. Their linear modeling framework may be expanded to accommodate multiple gene effects as given in (7) by summing over all possible genes G

and, within each gene, including all marker main effects and phase terms, and including interaction terms across genes (7).

For similar reasons, one may also want to investigate gene-environment interaction with measured covariates. This expands the model further as in (8).

The Challenge of Numerous Polymorphisms and Exposures

The investigation of associations for numerous polymorphisms within a single candidate gene and across multiple genes can raise concerns about multiple comparisons and sparse data bias in estimation. As one extreme approach, each polymorphism can be treated as independent, as in model (1). This approach is problematic: these reduced models may result in underestimated variance, and they do not account for the correlation that may exist among the polymorphisms, such as two polymorphisms in LD with each other within a gene region.⁴⁶ Furthermore, treating each polymorphism as independent and relying on statistical tests across all polymorphisms can lead to issues of multiple comparisons. While one may perform adjustment in the declaration of significance, such as a Bonferroni correction or control of the false discovery rates,^{27,47,48} these procedures may not accurately account for the relations between the

$$Y | \mathbf{X}, \mathbf{W}] = \beta_0 + \sum_{g=1}^G \left(\sum_{m=1}^{M_g} \beta_{gm} X_{gm} + \sum_{m=1}^{M_g} \sum_{\ell \neq m}^{M_g} \beta_{gm.g\ell} X_{gm.g\ell} \right) + \left(\sum_{g=1}^G \sum_{m=1}^{M_g} \sum_{k \neq g}^G \sum_{\ell=1}^{M_k} \beta_{gm^*k\ell} X_{gm^*k\ell} \right) + \sum_{j=1}^J \delta_j W_j \quad (7)$$

$$Y | \mathbf{X}, \mathbf{W}] = \beta_0 + \sum_{g=1}^G \left(\sum_{m=1}^{M_g} \beta_{gm} X_{gm} + \sum_{m=1}^{M_g} \sum_{\ell \neq m}^{M_g} \beta_{gm.g\ell} X_{gm.g\ell} \right) + \left(\sum_{g=1}^G \sum_{m=1}^{M_g} \sum_{k \neq g}^G \sum_{\ell=1}^{M_k} \beta_{gm^*k\ell} X_{gm^*k\ell} \right) + \sum_{j=1}^J \delta_j W_j + \left(\sum_{g=1}^G \sum_{j=1}^J \delta_{gj} X_g W_j \right) \quad (8)$$

polymorphisms, and they do not yield estimates of effect conditional upon other polymorphisms and exposures.

At the other extreme, the analyst may choose to model all main effects and interactions in one single model, as described in equation (8). Including all genetic polymorphisms and exposures in one model can lead to biased and unreliable estimates due to sparse data when the number of parameters approaches the number of individuals in the sample.^{21,49} These models tend to overfit the data, resulting in estimates that explain the observed data well, but will lead to unrealistic predictions for any new data or biased inferences implied by the estimates. While conceptually attractive, in modern observational studies this approach quickly reaches the limits of the data, especially given the relatively large expense of enrolling an individual into a study in comparison to the rapidly dropping costs of obtaining a plethora of genotype-level information for a given individual. Often, a compromise in analysis approaches comes in the form of model selection or using the data and/or prior information to determine which set of polymorphisms and exposures may have substantial effects and only include those terms in the model. Models (1) through (7) may be viewed as types of reduced models in which polymorphisms and/or genes are assumed to be independent or interacting effects are assumed to be nonexistent. The use of knowledge or statistical tests is attractive in providing the analyst with simplified models in which to estimate and interpret. However, it is important to realize that, by not including a certain term in the model, the analyst is implicitly stating a belief that, with 100% certainty, that term's effect estimate is zero. Is previous knowledge reliable enough to justify the exclusion of a term, or is there a level of uncertainty? Clearly, relying solely on a priori decisions of what to include in the model is limited to the accuracy

of the prior knowledge and, moreover, these a priori decisions ignore the data completely. In contrast, model selection procedures that use only the data to decide which terms to include in the model may underestimate the variance for each term by not accounting for the uncertainty in the selection procedure itself. Furthermore, automated procedures are prone to increased type I errors (i.e., false positive errors) by relying strictly on statistical cutoffs in the model-building process.⁵⁰

Potential Solutions

To address these issues, an approach is proposed that uses hierarchical modeling and stochastic variable selection. Hierarchical modeling allows for the construction of complex probability models that incorporate higher-level information to yield more stable and plausible measures of association. Stochastic variable selection utilizes both the data and prior knowledge to determine which terms to include in the models, resulting in a guided model search leading to more representative and interpretable models. These approaches are possible because the hierarchical nature of the data—that is, polymorphisms within genes and genes within pathways—provides an opportunity to formalize a bottom-up approach placing more emphasis on combinations of polymorphisms within a gene in comparison to combinations across genes. This hierarchy served as the foundation for the development of the various approaches outlined in equations (1) through (8). This culminates in the saturated model (8) in which one first sums over SNPs main effects and SNP interaction effects within a gene, then SNP interaction effects across genes, and finally, over SNP \times covariate interactions. It is proposed to formalize the combination of knowledge-based heuristics and model selection procedures in deciding which model is most appropriate. In this context, hierarchical modeling and stochastic variable selection

as conventionally applied are briefly introduced, and then these approaches are combined in a pathway-based model.

Hierarchical Modeling

A primary motivation for using hierarchical modeling and stochastic variable selection with structured priors is to describe the joint distribution of the underlying genetic structure and biological mechanism represented by the data and, notably, the uncertainty in representing that structure and mechanism. In doing so, the parameter estimates and corresponding uncertainty intervals will better capture the dependency between terms; therefore, the resultant tests will more effectively reflect the evaluation of multiple polymorphisms and exposures.^{49–53} This is similar in spirit to an approach proposed by Wacholder and colleagues⁵⁴ in which they introduced a Bayesian procedure for multiple comparisons that incorporates a prior specification of the probability of any given polymorphism being associated with an outcome. While the notion of incorporating prior knowledge into testing and estimation is an important one, the false positive reporting probability of Wacholder and colleagues⁵⁴ frames the decision into a binary choice between the null hypothesis and an effect size determined from estimation using observed data.⁵⁵ Alternatively, one can specify a prior distribution for the effect size via a hierarchical model. By incorporating known information regarding the relations among the genetic polymorphisms, a joint distribution is specified that both stabilizes the final effect estimates and incorporates dependencies across multiple tests of association. Specifically, one can model the regression coefficients β_{gm} from model (9) in terms of a regression on a vector of ρ “prior covariates” $\mathbf{Z}_{gm} = (\mathbf{Z}_{g1}, \dots, \mathbf{Z}_{gp})$. Thus, a second-level model of the form is adopted (9).

$$\begin{aligned} \underline{\beta} &= \mathbf{Z}_{\mu} \underline{\mu} + \underline{U} \\ \underline{U} &\sim N(0, \tau^2 \Sigma) \end{aligned} \quad (9)$$

The design matrix \mathbf{Z}_{μ} contains the second-stage covariates reflecting higher-level relations between the polymorphisms, $\underline{\mu}$ is a column vector of coefficients corresponding to these higher-level effects on the trait outcome, \underline{U} is a column vector of random effects capturing the residual variation after adjustment by the relations in \mathbf{Z}_{μ} , and Σ is a covariance matrix specifying any residual covariance among the regression coefficients. This hierarchy results in posterior estimates of effect for the polymorphisms $\tilde{\beta}$, which are an inverse-variance weighted average between the maximum likelihood estimates obtained from a conventional regression and the estimated conditional second-stage means $\mathbf{Z}_{\mu} \underline{\mu}$. Thus, the final estimates of effect are dependent upon the amount of information available. Estimates with less information may be unstable and will tend to have larger variances. This, in turn, will result in a final posterior estimate more heavily weighted toward the prior information reflected by the conditional second-stage means $\mathbf{Z}_{\mu} \underline{\mu}$.

An important assumption here is that the modeled parameters, the β s, are exchangeable. Formally, this means that conditional on the information in \mathbf{Z}_{μ} , the parameters have no prior ordering or grouping such that their joint distribution, $f(\beta_{11}, \dots, \beta_{gm})$, is invariant to permutations of the indexes $g = (1, \dots, G)$ and $m = (1, \dots, M)$. If this assumption holds, one may assume that the parameters are drawn from the same population distribution. In practice, the validity of this exchangeability assumption requires one to both focus on the interpretation of the β s and on how to group them via the design-matrix \mathbf{Z}_{μ} . First, in linear regression, the β s represent the increase in the outcome, Y , given a one-unit increase in the independent variable, X . In the analysis of SNPs, these effect estimates are the increase in Y given one unit in change in the variant allele, assuming an additive

coding for a selected variant. Here, across numerous SNPs, all the β s reflect similar interpretations for their corresponding effect estimates, and the design matrix \mathbf{Z}_μ may be constructed to incorporate a priori knowledge of SNPs having similar estimates of effect, for example. However, even in this simple example of multiple SNPs, care must be taken in how the effect estimates are interpreted and the impact this interpretation will have on the construction of the prior covariates. Specifically, for a particular SNP, one must consider which of the two alleles describes the increase in effect.⁵⁶ If it is known that two SNPs might share similar risks—that is, are exchangeable classes conditional on the design matrix—one is really assuming that the two variant alleles as defined at the two respective SNPs share similar effects *in the same direction*. If one does not have knowledge of the direction of effect for each variant, then one may incorrectly specify sharing of two effects that act in opposite directions and are thus not from the same population distribution.⁵⁷ Further complications arise as the analysis is expanded to include environmental covariates. On what scale does one define the effect estimates corresponding to environmental covariates? And, is the corresponding effect estimate exchangeable with other covariate or SNP estimates? To address these difficulties, it is proposed that the hierarchical model be modified to model the test statistics rather than the effect estimates. This will be discussed later in the “Methods” section.

Model Selection via Stochastic Variable Selection

Although hierarchical modeling can stabilize the estimates of effect across

$$\Pr(\beta_v | \gamma_v, \psi_t, \sigma) = \begin{cases} 0 & \text{if } \gamma_v = 0 \\ N(0, (\psi_t \sigma)^2) & \text{if } \gamma_v = 1 \end{cases} \quad (10)$$

the numerous terms, it is also of interest to highlight the linear combinations of SNPs and phase terms that best capture the gene-disease relations. Furthermore, it is desirable to account for varying prior beliefs that each polymorphism or term is involved in the trait outcome. That is, although all the genes were chosen with at least some belief that they are involved in the outcome under investigation, some genes are more likely to be involved given prior functional evidence or knowledge of the underlying biology. Similarly, within a specific gene, some polymorphisms are more likely to affect trait variation, with some polymorphisms chosen because of putative functional evidence and others chosen strictly to capture an unknown causal effect via LD. Thus, a stochastic variable selection approach is proposed to stochastically search the model space to highlight important SNP and phase terms and to average over all possible models. This approach has the advantage of accounting for uncertainty in model selection and allowing for a flexible prior structure in which one can incorporate the relations among terms when selecting representative models. Previously,⁵⁸ a variation was implemented of the stochastic search variable selection algorithm, first presented by George and McCulloch,⁵⁹ by introducing a latent variable, $\gamma_v = 0$ or 1, indicating whether a term, v , is included in a model (10).

The above specification is conventionally implemented with a prior second-stage normal distribution with a mean of zero. While others have discussed the use of semi-Bayes or empirical-Bayes approaches to prespecify ψ and σ^2 ,^{59–61} a fully Bayesian approach can be adopted to integrate over posterior distributions using MCMC methods as implemented in WinBUGS.^{44,58,62}

The posterior probability of $\gamma = 1$ and the set of possible models visited during the stochastic search can be used to gauge the impact of each term and the combinations of SNPs and phase terms that best explain the relation of genetic variation to disease. These posterior probabilities will depend on the specified prior distribution for γ . The simplest form of the prior is to assume a binomial prior distribution for γ (11) where ρ_v is the probability that $\gamma_v = 1$. By assuming that ρ_v is constant for all terms, one assumes that the corresponding parameters, β_v , are exchangeable, as indicated in equation (10), and equally likely to be included in any given model. Specifically, main effects and interaction terms are equally likely. However, it is desirable to structure the prior in equation (11) to both guide the stochastic search to models that are more parsimonious in relation to the number of SNPs or terms included in any given model, and also to assist the stochastic search in the inclusion of phase terms, conditional on the inclusion of both “parent” SNPs used to define the pairwise interaction term.⁶³ Following Conti and Gauderman,⁴⁴ the level of parsimony can be controlled by setting the prior for ρ for SNP main effects as $\Pr(\rho_{SNPs}) = \text{Beta}(1,3)$. This gives a low expected probability ($E[\rho_{SNPs}] = 0.25$) of inclusion for any given SNP and places emphasis on models with fewer SNPs.

Furthermore, following Chipman,⁶³ a conditional probability for inclusion of phase terms, $\gamma_{gm,gl}$, is defined as (12). This conditional prior reduces the model space visited by the stochastic search. This structure is invoked to reflect the approximation of the underlying haplotype

architecture with linear combinations of SNP and, if necessary, phase terms. Introducing a hierarchical dependency of phase terms on the “parent” SNP terms directs the stochastic search to simpler and more stable models, if appropriate. To offset this restriction and to encourage the exploration of the importance of phase, a higher probability is specified for the inclusion of phase terms, conditional on the inclusion of both “parent” SNPs, $\Pr(\rho_{gm,gl} | \gamma_{gm} = 1, \gamma_{gl} = 1) = \text{Beta}(3,1)$. This puts a higher prior expected probability on the phase terms ($E[\rho_{gm,gl} | \gamma_{gm} = 1, \gamma_{gl} = 1] = 0.75$). However, marginally, the prior expected probability for the inclusion of any given phase term is lower than the SNP main effects, $E[\rho_{gm,gl}] = 0.05$. This structured prior in equation (12) acts to both guide the stochastic search to models that are more parsimonious in relation to the number of SNPs included in any given model, and also assists the stochastic search in the inclusion of interaction terms, conditional on the inclusion of both “parent” main effects used to define the interaction term. In a similar fashion, the structured priors can be used to limit and/or guide the model search to combinations of SNPs across genes within subpathways and networks, and models can thus be summarized.⁶⁴

Methods

General regression approaches to the analysis of multiple SNPs within and across candidate genes have been reviewed. Also, both hierarchical and model selection extensions to these regression models have been discussed. As mentioned earlier,

$$f(\gamma_1, \dots, \gamma_V | \rho_1, \dots, \rho_V) = \prod_{v=1}^V \rho_v^{\gamma_v} (1 - \rho_v)^{(1-\gamma_v)} \quad (11)$$

$$\Pr(\gamma_{gm,gl} = 1 | \gamma_{gm}, \gamma_{gl}) = \begin{cases} \rho_{gm,gl} & \text{if } (\gamma_{gm}, \gamma_{gl}) = (1,1) \\ 0 & \text{otherwise} \end{cases} \quad (12)$$

it is desirable to combine the benefits of borrowing information from exchangeable classes via hierarchical modeling with the ability to search the expansive model space via stochastic variable selection. However, the combination of these two approaches introduces two notable practical difficulties. First, how does one reasonably define exchangeable classes across SNPs (and possibly microsatellites), environmental factors, and all possible interaction terms? Second, how does one search such a vast space of applicable models in a reasonable amount of computational time? One can begin by first framing the hierarchical model on unsigned summary statistics from the regression model rather than from the effect estimates. Thus, one only has to define exchangeable classes for the unsigned summary statistics and avoid specification for the effect estimates, which may vary in scale and direction. In addition, an empirical Bayes approach is used to regress these summary statistics on prior covariates to yield posterior estimates of the summary statistics and of the probability that a summary statistic is nonzero. This probability, in turn, determines the probability that a corresponding term is included in the model.

Hierarchical Model

Following Lewinger and colleagues,⁶⁵ one can begin by defining a Wald test statistic, $T_v^2 = \hat{\beta}^2 / \text{var}(\hat{\beta})$, for a specific term, v , in a regression model. This test statistic has an asymptotic χ^2 distribution with one degree of freedom and a noncentrality parameter λ_v^2 . Since the interest is in

defining exchangeable classes independent of the direction of effect, the focus is on the unsigned statistic $t_v = +\sqrt{T_v^2}$ and the corresponding noncentrality parameter $\lambda_v = +\sqrt{\lambda_v^2}$, resulting in an asymptotic distribution for t_v as $\chi_1(\lambda_v) = |N(\lambda_v, 1)|$. Specifically, this distribution is of the form (13) where φ is the standard normal density. This places a second-stage distribution on the test statistics obtained from a first-stage regression model. Of interest is deciding if this test statistic provides evidence for the SNP or factor being involved in the outcome of interest. If $\lambda_v = 0$, there is no association with the outcome. Positive values for λ_v indicate an association with increasing evidence as λ_v grows in magnitude. This can be formalized by modeling the λ s as a mixture between a chi distribution with a positive noncentrality parameter and a point mass $\delta(0)$ where $\lambda_v = 0$ (14).

Here, H_v is an indicator of whether a term is associated with the outcome and p_v is the corresponding probability of that association. Given that there is a true association, the expected noncentrality parameters are influenced by e_v and $\sigma > 0$.

The terms in a regression model are not all equivalent in regard to prior information that may be available (e.g., is the SNP known or predicted to affect gene function? Or, how important is the gene in a particular pathway?) and in regard to the hierarchical structure of the model (i.e., main effects versus interactions). Recognizing that differences exist across terms, both the probability that the association is true and magnitude of the noncentrality parameter are regressed on

$$t_v \mid \lambda_v \sim \varphi(t_v - \lambda_v) + \varphi(t_v + \lambda_v), t_v \geq 0 \quad (13)$$

$$\lambda_v \mid H_v, e_v \sim H_v \sigma^{-1} \chi_1(\sigma^{-1} e_v) + (1 - H_v) \delta(0) \quad (14)$$

$$H_v \sim \text{Bernoulli}(p_v)$$

a set of prior covariates constructed to indicate the prior knowledge (15).

$$\begin{aligned} \text{logit}(p_v) &= \underline{\pi}' \mathbf{Z}_{\pi,v} \\ e_v &= \left| \underline{\mu}' \mathbf{Z}_{\mu,v} \right| \end{aligned} \quad (15)$$

The intercept μ_0 is constrained to be nonnegative for identifiability. For details regarding the estimation of the relevant parameters, see appendix 1.

Model Selection via Stochastic Variable Selection

The above hierarchical model incorporates prior information into the estimation of the posterior probability that a term is associated with an outcome and the magnitude of the test statistics. However, the model assumes that there is a given regression model in which to obtain the corresponding test statistics. Given the immense space of all possible models outlined in equations (1) through (9), it is desirable for the priors and the data to influence which models are examined. Following the previous discussion on stochastic variable selection, a vector of variables, γ_v is introduced that indicates if a certain term is included in the model. Conditional on the selected terms, the test statistic is then calculated as (16).

$$t_v | \gamma_v = \begin{cases} \frac{\hat{\beta}_v^2}{\text{var}(\hat{\beta}_v)} & \text{if } \gamma_v = 1 \\ \chi_1(0) & \text{if } \gamma_v = 0 \end{cases} \quad (16)$$

To allow for both the priors and the data to influence model selection, one sets the probability that a term is included in a regression model to be equal to the probability that an association is true, that is, (17).

$$\gamma_v \sim \text{Bernoulli}(p_v) \quad (17)$$

Because of the hierarchical nature of the terms within a given regression model, a similar conditioning as outlined in equation (12) for the inclusion of interaction terms is included. For more details regarding the model selection algorithm, see appendix 2.

The prior structure specified via \mathbf{Z}_μ and \mathbf{Z}_π and incorporated into this hierarchical model serves two purposes. First, it allows the posterior estimates of \hat{P}_v and \hat{E}_v to borrow information from exchangeable classes, and second, via \hat{P}_v , it will guide the stochastic search to regression models that include more biologically relevant terms. The overall impact of these structured priors is to narrow the space of possible models searched via the stochastic algorithm. Thus, instead of being faced with an impossible number of main effect and interacting terms and possible models, the process is reduced with biological knowledge to an informed and guided search procedure.

In the process of the stochastic search, the data will serve to update the prior probability and inform one of the impact of each factor via the posterior estimates for \hat{P}_v , \hat{E}_v , and the posterior probability of certain terms being selected. For inference regarding the posterior magnitude of the test statistic, calculation (18) is made. For the posterior probability of an association to be true, calculation (19) is made.

Because the final inference regarding the importance of each factor via the posterior probability of association and the probability of each factor being selected must reflect the prior probability structure, one relies on Bayes factors for inference.⁶⁶ Bayes factors are the ratio of the posterior probability odds, comparing two hypotheses to the prior probability odds, and can be thought of as a type of marginal likelihood ratio for the comparison of two hypotheses. For example, calculate as in equation (20).

$$\tilde{E}_v = E[E_v | \gamma_v = 1, \mathbf{Y}, \mathbf{X}, \mathbf{Z}_\mu, \mathbf{Z}_\pi] = \frac{1}{N_v} \sum_{i=1}^{N_v} \hat{E}_v^i \quad (18)$$

$$\tilde{P}_v = E[P_v | \gamma_v = 1, \mathbf{Y}, \mathbf{X}, \mathbf{Z}_\mu, \mathbf{Z}_\pi] = \frac{1}{N_v} \sum_{i=1}^{N_v} \hat{P}_v^i \quad (19)$$

$$BF(\gamma_v) = \frac{\Pr(\gamma_v = 1 | \mathbf{Y}, \mathbf{X}, \mathbf{Z}_\mu, \mathbf{Z}_\pi) / (1 - \Pr(\gamma_v = 1 | \mathbf{Y}, \mathbf{X}, \mathbf{Z}_\mu, \mathbf{Z}_\pi))}{\Pr(\gamma_v = 1 | \mathbf{X}, \mathbf{Z}_\mu, \mathbf{Z}_\pi) / (1 - \Pr(\gamma_v = 1 | \mathbf{X}, \mathbf{Z}_\mu, \mathbf{Z}_\pi))} \quad (20)$$

The numerator is calculated by using the frequency distribution of $\gamma_v = 1$ from the MCMC iterations when examining the association to \mathbf{Y} . In a similar fashion, the denominator is calculated by calculating the frequency distribution of $\gamma_v = 1$ under the null of no association to \mathbf{Y} , or effectively removing \mathbf{Y} from the conditioning. Also, a Bayes factor should be calculated for the posterior probability of a true association. For each hypothesis comparison, a Bayes factor between 3 and 20 can be considered as “positive” evidence, 20 to 150 as “strong” evidence, and greater than 150 as “very strong.”⁶⁶

Prior Knowledge and Ontologies

The list of candidate genes has been chosen because they are involved in biological pathways suspected in the trait process. Thus, in branching out from assessing the impact of a single candidate gene to comprehensively evaluating the factors within interconnected pathways, one is faced with the a priori possibility that many interactions, often of higher order, will exist between factors (as represented in model [9]).

For genetic association studies, one wants to encode in computational form prior knowledge that can either (1) estimate the likelihood of effects from a specific genotypic or phenotypic variable or (2) hypothesize a relationship between two or more variables that would otherwise be assumed to be independent: genotype-genotype

relationships, phenotype-phenotype relationships, and genotype-phenotype relationships. Knowledge of these types has been used in association studies, but only in either the study design phase or as an independent analysis, not as an integral part of a global analysis as proposed here. As a familiar example, “coding SNPs” are often prioritized in genotyping studies because they cause a change in the protein product of a gene—either a missense (amino acid substitution) or nonsense (premature stop codon) change—that is, more likely to have a phenotypic effect than a random, noncoding SNP. Interactions are often tested between polymorphisms within a particular gene because they have a relatively high likelihood of interacting simply by virtue of being in the same gene. The LD provides knowledge of haplotype structure in the population that can be used to select SNPs for genotyping.⁶⁷

Prior Knowledge About Potential Functional Effects of Genetic Polymorphisms

A number of prediction algorithms exist for estimating the probability that a given genetic polymorphism may have phenotypic consequences. Most human polymorphisms are believed to have little or no detectable phenotypic effect;⁶⁸ it is almost certainly true that in any given genetic association study, the probability that a randomly chosen polymorphism affects the phenotype

of interest is vanishingly small. A number of computational methods have been developed to estimate the probability that a polymorphism has a functional effect, such as the Sorting Intolerant From Tolerant, or SIFT, procedure;⁶⁹ PolyPhen (polymorphism phenotyping);⁷⁰ and subPSEC (substitution position-specific evolutionary conservation).⁷¹

Most of these methods apply to nonsynonymous coding SNPs (SNPs that result in an amino acid substitution in the protein product of a gene), and they predict the probability specifically of a deleterious effect. The most commonly used methods analyze either (1) related protein sequences and judge a polymorphism to be deleterious if it causes a substitution at a highly conserved site (because conservation is due to natural selection *against* substitutions at that site)^{72–74} or (2) how the change may disrupt known elements of protein 3D structure (e.g., substitutions in the interior of proteins are more likely to destabilize protein structure).^{72,75} Figure 12.1 shows examples of these analyses, applied to the *2 variant of *CYP2A6* (cytochrome P450, subfamily 2A, polypeptide 6), which changes leucine 160 to histidine (L160H). This substitution completely inactivates the enzyme. This substitution can be predicted as deleterious by using evolutionary analysis (figure 12.1A): all *CYP2A* (and 2B and 2G, not shown) enzymes have either leucine, isoleucine, or phenylalanine (large hydrophobic amino acids) at that position, so histidine, which is polar, would be predicted to be deleterious. A structure-based analysis (figure 12.1B) shows that position 160 is on the interior of the protein, also predicting a probable deleterious effect.

Analysis of conservation patterns can also be applied to noncoding DNA sequences,⁷⁶ although there is generally less statistical power than for coding SNP analysis. Noncoding DNA sequences generally diverge faster than protein sequences, and local mutation rates can be difficult to estimate

in the absence of known, neutrally evolving sites (which in proteins can be estimated from synonymous coding changes).

It is important to note that these analyses provide prior information about the likelihood of a particular genetic change resulting in a phenotypic change, although not necessarily the phenotypic change (or changes) assayed in any particular association study.

Systems Biology and Genetic Association Studies

Of interest is building a model of the system (including both biological and environmental variables) that represents how a perturbation in any one variable will affect other variables in the system. The more information in the model, the more information can be used to infer effects of changes in genetic or environmental variables. In genetic association studies, the minimal set of variables includes genetic polymorphisms and phenotypic effects (outcomes). One way to visualize this system is in terms of a network model, in which nodes represent variables and edges represent potential paths for propagating perturbations to the system. Examples of networks are given in figure 12.2. In this model, a variant allele (e.g., a polymorphism) of a gene is a “perturbation” of the system relative to the wild-type allele. An association between a polymorphism and a phenotype implies that the perturbation due to the polymorphism was propagated through the system to affect the phenotype. If the phenotype is a defined event—for example, smoking cessation—then the polymorphism might affect the probability of occurrence of the event. If the phenotype is a quantitative trait—for example, cigarettes smoked per day—then the polymorphism might affect the magnitude or variance of the trait.

In the simplest case, a genetic association study will collect data only on one or

Figure 12.1 Evolutionary and Structural Analyses for the *CYP2A62 Variant**

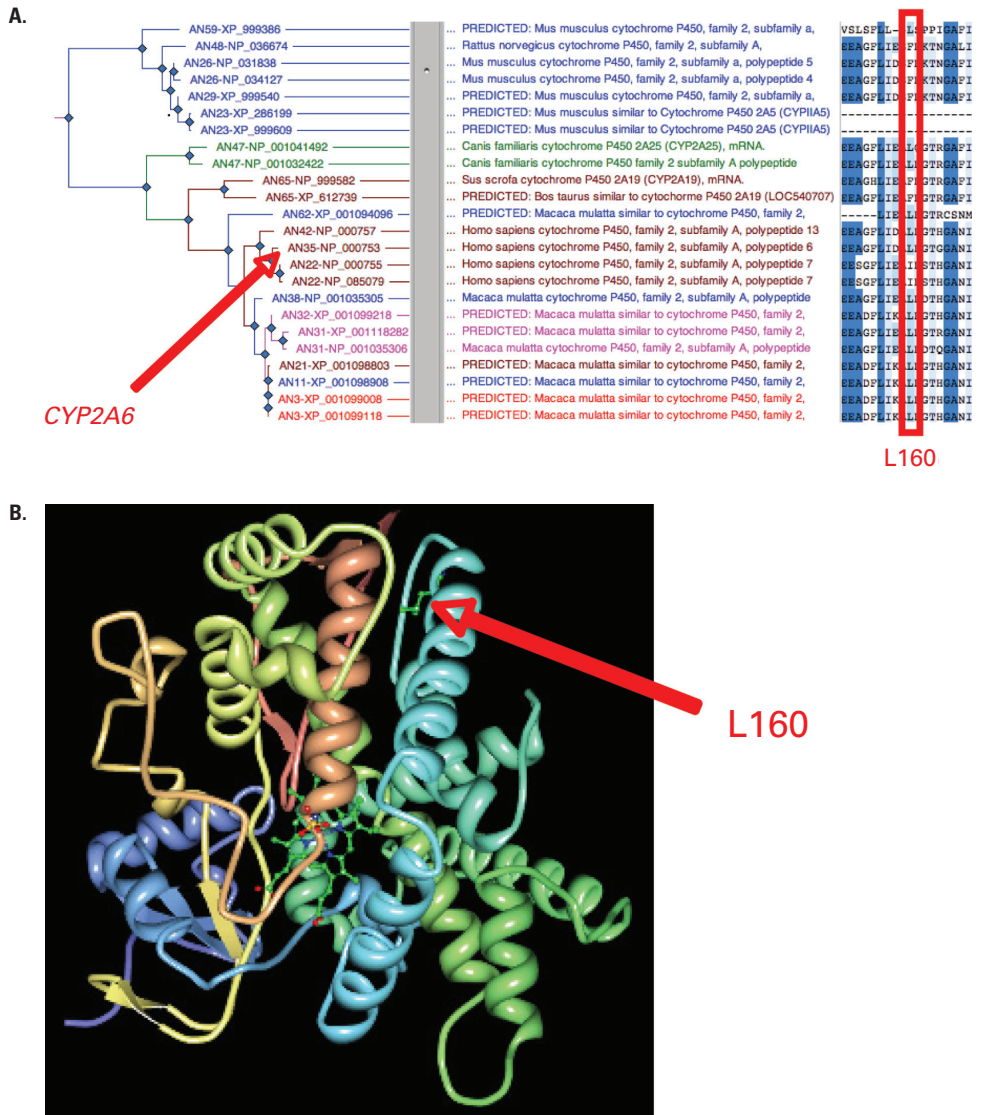

Note. In the top figure (A), evolutionary conservation in homologs of human *CYP2A6* at position 160 predicts that *CYP2A6**2 will have reduced function. Only large, hydrophobic amino acids (L:leucine, F:phenylalanine, I:isoleucine) are found in all homologues while the *CYP2A6**2 variant codes for a histidine at this position. The left panel shows a phylogenetic tree of some mammalian homologues of human *CYP2A6*, the middle panel provides information about each sequence including the gene and organism (mouse: *Mus musculus*; rat: *Rattus norvegicus*; dog: *Canis familiaris*; pig: *Sus scrofa*; cow: *Bos taurus*; macaque: *Macaca mulatta*; human), and the right panel shows part of the sequences of the corresponding protein near position 160 in *CYP2A6*. The tree was constructed using nonsynonymous divergence as the distance metric. mRNA = messenger RNA. In the bottom figure (B), protein structure analysis predicts that *CYP2A6**2 will have reduced function. Leucine 160 is buried inside the hydrophobic core of *CYP2A6*, where a substitution to histidine in *CYP2A6**2 would be predicted to destabilize the protein. Picture drawn with ProteinWorkshop.⁷⁷

more phenotypes and one or more genetic polymorphisms. If there is no prior knowledge about the potential relationships between these genetic polymorphisms and the phenotype, one implicitly assumes a completely connected network, in which any polymorphism can affect any phenotype by any path. An example of such a network, for the genes and phenotypes considered in this paper, is shown in figure 12.2A. In this network, each polymorphism is assumed, prior to data analysis, to have an equal probability of affecting the phenotype. All interaction terms are also considered a priori to be equally probable. The model makes no assumptions about the underlying mechanisms by which genetic (or environmental) perturbations will propagate to the phenotypes of interest. In this sense, it is hypothesis free, although in practice most genetic association studies focus on “candidate genes” that are hypothesized a priori to have a potential role in a particular phenotype.

An increasing amount of information is becoming available about the underlying

structure of these systems networks, which can be applied to genetic association studies. Computational representations are now available for a number of biochemical pathways,⁷⁸ modeling detailed (mostly intracellular) interactions between proteins, genes, and small molecules. One relevant example is the nicotine metabolism pathway now available in the HumanCyc⁷⁹ and PANTHER Pathways⁸⁰ databases. Higher-level representations are also available that model the relationships between various “constructs” (concepts) in a field, such as nicotine dependence, withdrawal, and smoking relapse.⁸¹ These data sources can be used to define a network structure that relates genetic and environmental variables to phenotypes (and endophenotypes) in a detailed manner, as illustrated in figure 12.2B. This network differs from the network in figure 12.2A in two main aspects. First, the actual number of edges (connections) can be much smaller than in the “hypothesis free” network, which reduces the “search space” of likely models for genotype-phenotype effects. Second, there are intermediate nodes between

Figure 12.2 Examples of Networks

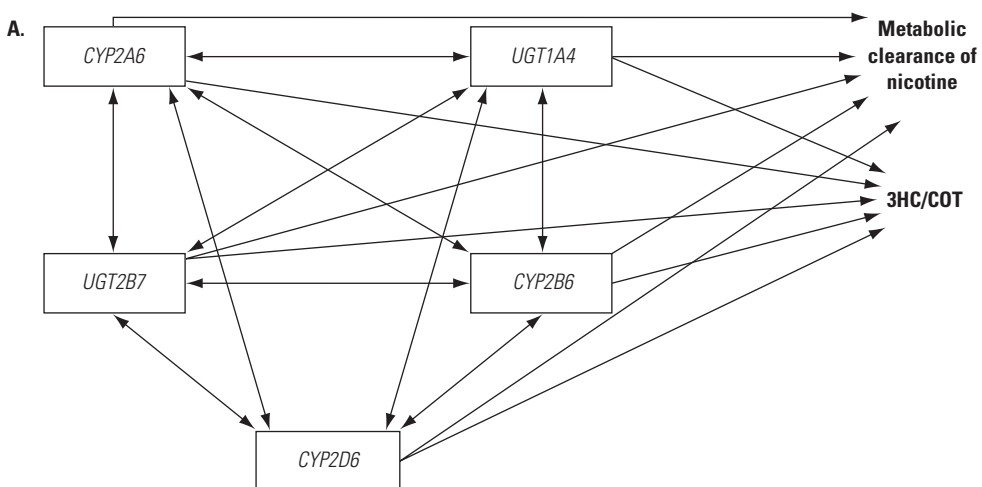

Note. Shown is a generalized network of genes and all possible relations within the nicotine metabolism pathway. 3HC/COT = *trans* 3'-hydroxycotinine to cotinine ratio.

Figure 12.2 Examples of Networks (continued)

B.

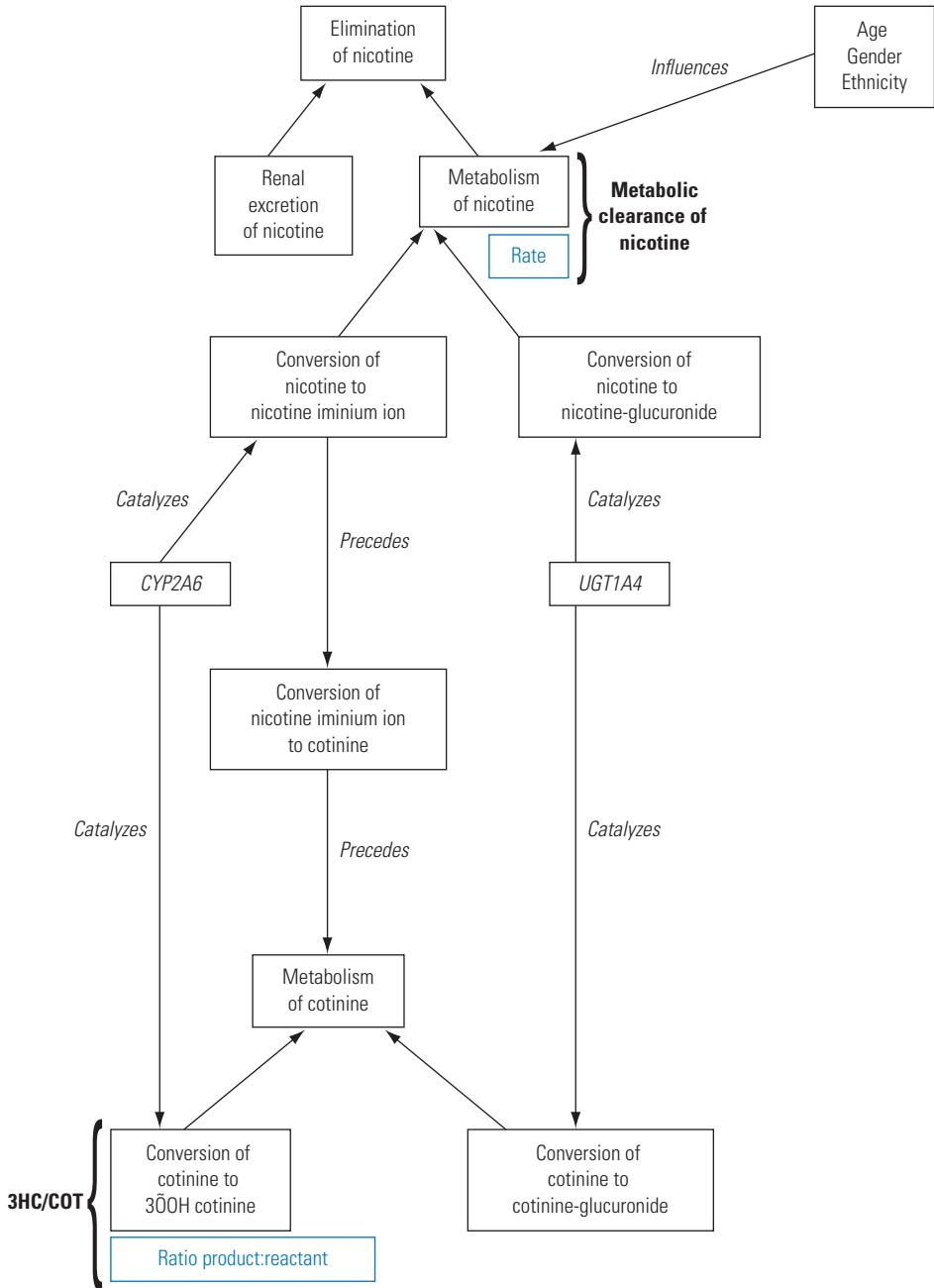

Note. Shown is a simplified Nicotine Pharmacokinetics Ontology. 3HC/COT = *trans* 3'-hydroxycotinine to cotinine ratio.

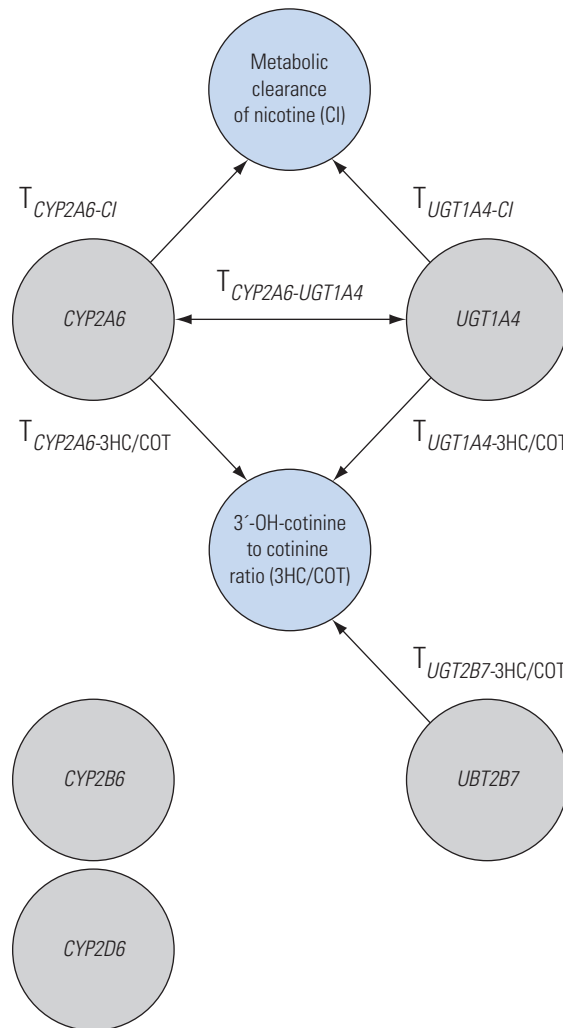
Figure 12.2 Examples of Networks (continued)**c.**

Note. Shown is the network characterization of the effect of each gene (via the test statistic T) and its impact on the outcome of interest (either nicotine clearance or 3'-OH-cotinine to cotinine ratios) and the relations to each other as specified in the ontology.

genotype and phenotype that can serve as “endophenotypes,” which can be assayed to model (and validate) mechanistic relationships between genotype and phenotype. For the purposes of this paper, the network structure can be used to estimate prior probabilities of effects and interactions that are different for different genetic and environmental variables, as well as for different interaction terms.

Using Ontologies to Represent Prior Knowledge About Relationships Between Variables

In genetic association studies, there is often prior knowledge of relationships that is applied to hypothesis testing. The most commonly used relationships are physical or genetic distance-based

relationships between individual single-position genotypes, such as LD, or, for functional relationships, presence in the same gene or in a list of “candidate genes.” Candidate genes are generally selected using prior knowledge, such as previously reported associations with the same or similar phenotypes or known or hypothesized biological relationships. Here, it is suggested that ontologies provide a useful formalization of these relationships, enabling the incorporation of multiple types of prior knowledge into computational analyses of genetic association data.

The goal of genetic association studies is to uncover statistical correlations between genetic (germline) variation and phenotypic variation. To be useful for genetic association studies, an ontology must represent concepts (or “entities”) in the domains of both genotypes and phenotypes and the relations between these concepts.

An ontology is a formal structuring of knowledge.⁸² For the purposes here, an ontology is a *formal model* of a domain of knowledge, and consists of *entities* and *relations* between entities. An entity is simply a class, or category, of things that one wishes to model. An entity can be either a *continuant* (an object existing at a particular point in time) or an *occurrent* (an event or process occurring over time). Relations can be of many types, depending on the knowledge domain being represented, but two of the most common are the “is_a” relation, which specifies one class as a subclass of another (for example, human is_a mammal), and the “part_of” relation (e.g., finger part_of hand). Ontologies have their origins in Aristotelian philosophy, but computer science has driven a renaissance in ontology development and use—namely, by the problem of representing computational knowledge in the artificial intelligence field and the Semantic Web.

Why Build an Ontology?

Formalizing a particular knowledge domain can have two main impacts on a scientific research field. First, it can help to *clarify* and *communicate* the (often) implicit models used by scientists to formulate and test hypotheses. It clarifies the models by making them formal and explicit. Trying to formalize an implicit model can often be a useful exercise in itself, but for knowledge domains that are too large or complex for a single scientist to be an expert in all relevant subdomains, it is critical. A structured representation can help to clearly communicate a model to other researchers and allow iterative community development and revision of the model.

Second, an ontology can make expert domain knowledge accessible to *computation*. A computer may not yet “understand” the knowledge (in the human sense, whatever that means), but it can take advantage of the relations between entities in computational models and numerous useful algorithms, such as those aiding humans to find relevant information on the Web. The focus in this paper is on one such application: ontologies can facilitate the building of computational models for the testing of genotype-phenotype associations.

Clearly, then, ontology development will have the greatest impact on a given scientific area of inquiry when the field is sufficiently complex to be beyond the expertise of (most) single researchers. Such fields are interdisciplinary almost by definition, including or depending on many subfields of specialized expertise. As noted by Karp,⁸³ a scientific theory can be structured “within a formal ontology so that it is available for computational analysis.” The resulting *computational symbolic theory* enables “analysis and understanding for theories that would otherwise be too

large and complex for scientists to reason with effectively.”

How To Build an Ontology Relating Genotypes and Phenotypes

Ontologies have been developed for a number of biomedical domains, including anatomy, gene function, biochemical pathways and mutant and strain phenotypes in experimental model organisms such as mouse, zebrafish, fruit fly, and yeast. The experiences of these groups, as well as groups from other domains, have led to a number of proposed best practices for ontology development.^{84–88} Here, the focus is on building an ontology that relates genotypes and phenotypes. A well-known ontology development process⁸⁹ has been adopted for this purpose.

Step 1: Determine the domain and scope.

A genotype-phenotype ontology must include concepts from the molecular level (such as gene and genetic variation) to the phenotypes (such as a disease), including any intermediate-level concepts that may bridge the genotype-phenotype gap (such as biochemical pathways, or particular cell types or organs). Obviously, the concepts will be specific to the phenotype(s) of interest. This is a good point in the process to define “competency questions”,⁹⁰ these are questions that the ontology, once completed, should be able to address. For a genotype-phenotype ontology, the competency questions should cover such areas as

- Are there any clues from previous association studies, or from linkage or twin studies?
- What are possible confounding/ environmental factors?

Step 2: Consider using existing ontologies.

As mentioned above, a number of ontologies exist already in the biomedical domain. One of the best sources for existing ontologies is the Open Biomedical Ontologies (OBO) project.⁹¹ Existing OBO ontologies cover many relevant domains such as anatomy (Foundational Model of Anatomy⁹²), biological processes (Gene Ontology⁹³), molecular “events” such as biochemical reactions (Event Ontology [EVO]⁹⁴), phenotype-directed qualities (Phenotype and Trait Ontology [PATO]), sequence types and features, such as genes and genetic variation (Sequence Ontology⁹⁵), and human disease (Disease Ontology [DO]). OBO ontologies are completely open, and most have ongoing active discussion groups and a process for community maintenance and expansion of the ontology. Of the ontologies mentioned above, all but EVO and DO are also part of the OBO Foundry project, which ensures adherence to strict principles of ontology development.⁹¹

Step 3: Enumerate important terms.

This step involves simply listing terms that are important in the domain of interest. At this point, it is not necessary to decide whether these terms will become entities (a class, or category desirable to model) or qualities (inherent “attributes”) of entities. These terms will help to refine the scope of the ontology and to provide the basis for formalizing ontology.

Step 4: Define entities (classes) and relationships between entities.

At this stage, one begins to define entities and relationships between them. When possible, terms from existing ontologies should be used. When a new entity is

introduced, it is critical that a definition also be provided, to ensure that the term can be interpreted correctly (preferably even by a nonexpert). Most of the necessary relationship types already exist in the OBO Relation Ontology, although one additional relationship, *influences*, was found to be useful for describing putatively causal relations between entities that are critical for a model of the existing domain knowledge. For example, in the Nicotine Pharmacokinetics Ontology given here (NPKO, figure 12.2B), *age influences metabolism_of_nicotine*.

A number of software packages are available for simplifying the task of constructing ontologies. The added benefit of using one of these packages is that at the end of the process, the ontology is stored in a standard ontology format, such as the OBO format. As a result, the ontology can be imported into a number of software tools, such as those developed for the Ontology Web Language, or OWL,^{84,96} for analyzing the ontology for consistency and for computational reasoning over the ontology. Among the most popular packages for developing biomedical ontologies are OBO-Edit⁹⁷ and Protégé.⁹⁸

For biochemical pathways, the BioPAX Ontology⁹⁹ is beginning to enter widespread use. Well-known pathway resources such as BioCyc,¹⁰⁰ Kyoto Encyclopedia of Genes and Genomes,¹⁰¹ Reactome,¹⁰² and PANTHER¹⁰³ have made a relatively large number of pathways available in BioPAX format⁹⁹ and SBML (Systems Biology Markup Language).¹⁰⁴ SBML has the advantage of being able to specify quantitative data such as reaction rate constants, but BioPAX has greater expressive capability for genomic and protein sequence data that is critical for treating genetic variation data. If a relevant pathway does not yet exist in sufficient detail in one of these resources, PANTHER Pathways has a community curation Web site where domain experts can take

advantage of the CellDesigner¹⁰⁵ program's interface to draw a pathway and store a formal ontology representation directly from the drawing.

Step 5: Define qualities important for representing phenotypes.

Once the entities are defined, *qualities* can be enumerated for each of the entities. The emerging standard for phenotypes is the PATO syntax. In this “bipartite” entity:quality definition, a phenotype (e.g., metabolic clearance of nicotine) is expressed as a combination of an entity (e.g., metabolism of nicotine) and a quality inherent in the entity (e.g., rate). Phenotypes can be quantitative or qualitative. For example, a particular chemical reaction type (entity) might have a rate (quality), which would then be specified by a particular quantitative measurement (value).

Most ontology development projects begin with the formation of a small working group that brings together expertise in the relevant knowledge domain, with expertise in ontology construction. In the biomedical field, the National Center for Biomedical Ontology (NCBO) has been established; one of its primary missions is to provide the ontology construction expertise to facilitate development of new ontologies for biomedical applications.¹⁰⁶ The NCBO is an excellent resource for expert guidance and software tools for this purpose.

The product of the initial working group is a draft ontology. If appropriate, this draft ontology can provide a framework and starting point for a larger, community-driven project to expand and refine the ontology. At this point, the ontology enters a completely new phase of development. Community projects such as this require an infrastructure for managing discussions to come to a resolution on proposed changes and then rapidly incorporate accepted changes to the ontology. The OBO

project provides a platform for facilitating community ontology projects, leveraging resources originally designed to support Open Source software development projects, such as the SourceForge Web site.¹⁰⁷

Example: Nicotine Metabolism

Data

As an example, data are used from a study involving the volunteer-based Northern California Twin Registry.^{1,2} This study of the heritability of nicotine metabolism included 278 individuals between the ages of 18 and 65 years. Individuals were excluded for the following: greater than 30% above normal weight range; pregnancy; use of known drug metabolism-altering medications (e.g., barbiturates, phenytoin, rifampin [or INN, rifampicin]); uncontrolled hypertension or diabetes; heart, lung and cardiovascular disease; cancer; liver and kidney diseases; substance abuse or dependence; positive human immunodeficiency virus status; history or evidence of hepatitis B or C; and discomfort with venipuncture procedures. Both nonsmokers and smokers were recruited. Further details regarding the study description can be found elsewhere.^{1,2} Quantitative data were obtained to measure the impact of genetic variants on the disposition kinetics and metabolism of nicotine after systemic administration. As such, participants of the twin study were administered intravenous deuterium-labeled nicotine and cotinine (the major proximate metabolite of nicotine) and blood samples were obtained for genotyping. From blood concentrations obtained at intervals over 72 hours and urinary excretion data, pharmacokinetic parameters were estimated using model-independent methods.¹⁰⁸ Here, attention is confined to two outcomes of interest: the total clearance

of nicotine, and *trans* 3'-hydroxycotinine to cotinine ratio (3HC/COT). *Trans* 3'-hydroxycotinine is the major metabolite of cotinine, and its formation is catalyzed almost or entirely exclusively by *CYP2A6*, the enzyme that is primarily responsible for the metabolism of nicotine. The 3HC/COT ratio has been used as a marker of *CYP2A6* activity and of the clearance rate of nicotine.¹⁰⁹ Because this data set has a limited number of smokers, and previous analyses have demonstrated that inference for pharmacokinetics of nicotine remained largely unchanged after controlling for smoking status, smoking status is not included in the present analysis for simplicity. The analysis is limited to only Caucasians ($N = 211$), and age is included as the only covariate for demonstration purposes. Genotypes available for analysis include "wild-type" *CYP2A6**1 and its most common variants: *CYP2A6**2, *CYP2A6**4, *CYP2A6**7, *CYP2A6**8, *CYP2A6**9, *CYP2A6**10, *CYP2A6**12; four SNPs within *CYP2B6*; a single SNP within *CYP2D6*; seven SNPs in *UGT1A4*; and four SNPs in *UGT2B7*.

Analysis

To begin, a univariate analysis was performed by comparing the means for the kinetic parameters by each variant by using a mixed linear model for the first-stage likelihood, $f(Y | \mathbf{X}, \beta, \gamma)$, in which a random effect is included for twins to control for nonindependence. For *CYP2A6*, a previously reported analysis was followed,¹⁰⁸ and three categories were created on the basis of the impact of individual genotypes on nicotine clearance, fractional clearance, cotinine clearance and the 3HC/COT ratio: (A) *1/*1; (B) *1/*9 or *1/*12; and (C) any of the following variants: *1/*2, *1/*4, *9/*12, *9/*4, *9/*9 (*CYP2A6**7, *8, *10 were not found in this data set). Thus, the linear model has two dummy variables for groups (B) and (C), reflecting the difference in means relative

to the referent group (A). For the remaining SNPs in the other genes, an additive coding representing the number of variant alleles was used. For the three SNPs with individuals with missing genotypes, the expected coding was substituted as a function of allele frequency. While this may result in an underestimated variance, one should not expect an appreciable difference in that the number of individuals with missing values is small ($N = 1, 6,$ or $7,$ respectively). Age is included as a continuous covariate in every model.

For the hierarchical stochastic search, the first step was to outline a full model in which there are 18 main effects for gene polymorphisms (two dummy variables for *CYP2A6* and 16 SNPs across the other four genes), one main effect for age, and 170 pairwise interaction terms that include within and across gene interactions and gene-by-age interactions. For interpretability, the two dummy variables for *CYP2A6* are always included in the model together. Because the SNPs within a single gene were in relatively low LD, only the conventional interaction term (i.e., a deviation from additivity) was modeled and a phase term as described in equation (5) was not created. For the stochastic search, a hierarchical constraint on interaction terms was included, allowing interactions in the model only if their parental main effect terms are included. For this example, interaction terms were included to illustrate the feasibility and computational challenge of searching over a substantial model space. However, in this particular application, one should not expect to be able to detect interaction effects because of the limited sample size. Under favorable assumptions for two genes interacting (i.e., common allele frequencies and a large effect size—comparable to that observed in Benowitz and colleagues¹⁰⁸ for the main effect of *CYP2A6*)—the power to detect an interaction with this sample is about 10%–20%.

Ontology and Incorporation into the Hierarchical Stochastic Search Model

An Example Ontology Linking Genotypes and Phenotypes for Nicotine Pharmacokinetics

As part of the Pharmacogenetics of Nicotine Addiction and Treatment project funded by the National Institute on Drug Abuse, the authors of the chapter are developing a draft ontology in the areas of nicotine pharmacokinetics, dependence, and treatment outcomes. Figure 12.2B shows part of the initial draft of the NPKO relevant to the outcome phenotypes addressed in this paper. The ontology has several notable properties. First, it is hierarchical (more properly, the structure is a directed acyclic graph, or DAG, meaning that a child class can have more than one parent). Second, it spans the range from genotype to phenotype, representing high-level phenotypes, intermediate-level “endophenotypes” down to molecules and genotypes. Third, phenotypes are represented using the emerging PATO standard,¹¹⁰ shown as two adjacent ontology terms, an *entity* (black typeface) and a *quality* (blue typeface) in figure 12.2B.

Using the Nicotine Pharmacokinetics Ontology to Derive Priors

A discussion follows on how the information encoded into the ontology can help to define priors in the context of the Bayesian model selection process outlined previously.

What does figure 12.2B reveal in terms of prior information regarding the influence of genes on the phenotypes? In other words, how might the different effect estimates as summarized in the test statistics be related to each other? The first phenotype, 3HC/COT, is the ratio of the

concentrations of 3HC and cotinine, and therefore variation in any genes connected in the network (figure 12.2B) to either 3HC or cotinine, or both, could have an effect on this ratio. *CYP2A6* catalyzes the conversion of 3HC to cotinine, which would clearly be expected to have the primary effect on the 3HC/COT ratio. However, since *UGT1A4* activity depletes cotinine by conversion to cotinine-glucuronide and *UGT2B7* activity depletes 3HC by conversion to 3HC glucuronide, variation in both *UGT1A4* and *2B7* could also affect the 3HC/COT ratio.

The second phenotype, metabolic clearance of nicotine, relates to the rate at which nicotine is converted to other compounds. In the simplified NPKO (figure 12.2B), there are two pathways for nicotine metabolic clearance: nicotine can be converted into either cotinine or nicotine glucuronide, reactions catalyzed by *CYP2A6* and *UGT1A4*, respectively. The ontology, therefore, specifies that variation in both *CYP2A6* and *UGT1A4* would be expected to affect nicotine metabolic clearance. One can use further prior information—namely, in most individuals, more nicotine was found to be metabolized through the cotinine pathway than the nicotine-glucuronide pathway, by a factor of about 15,¹¹¹ to specify the prior belief that *CYP2A6* variation will have a larger effect on nicotine metabolic clearance than does *UGT1A4*. The relative rates of these reactions are stored in the ontology in the following form:

```
conversion_of_nicotine_to_nicotine_
iminium_ion:relative__rate
```

```
Compar conversion_of_nicotine_to_
nicotine-glucuronide
```

M 15,

where Compar denotes “in comparison to” and M denotes “measurement,” using the PATO standard terms.

The relations between genes and phenotypes, represented in the ontology (figure 12.2C), therefore provide a list of nonzero priors for the effects of variation in each gene on each of the phenotypes. They also provide expected relative contributions to the phenotype; namely, *CYP2A6* is expected to have the primary effect on both 3HC/COT and nicotine metabolic clearance. For simplicity, the expected effect of *CYP2A6* on the 3HC/COT ratio was set to be four times as large as the expected effect of either *UGT2B7* or *UGT1A4*. The ontology can also provide prior effect estimates for gene-gene interactions. *CYP2A6* and *UGT1A4* are both involved in the two phenotypes, nicotine clearance and 3HC/COT, so the gene-gene interaction term is expected to be nonzero for these two genes in both phenotypes.

Finally, relatively little is known regarding the specific polymorphisms within each gene, so a single prior value applicable to all SNPs within a gene is assigned. Taken together, the ontology yields the following matrix of priors:

Gene	Metabolic clearance of nicotine	3HC/COT ratios
<i>CYP2A6</i>	4	4
<i>CYP2B6</i>	0.5	0.5
<i>CYP2D6</i>	0	0
<i>UGT1A4</i>	1	1
<i>UGT2B7</i>	0	1
<i>CYP2A6-UGT1A4</i>	1	1
All other interactions	0	0

Incorporating Priors into Statistical Analysis

In addition to the above prior covariates for each respective analysis, an intercept term and a dummy prior covariate are included for main effects versus interaction effects. The same prior covariates are used for both the means and probability portions of the

mixed model. Furthermore, in the means model, the intercept of the noncentrality parameter e_v is constrained to be equal to the expectation of a chi distribution under the null of no associated terms in the regression model for identifiability. This causes the interpretation of the remaining effects of the prior covariates on the magnitude—that is, the μ s—to reflect a deviation from the null expectation. In the probability portion of the model, $\pi_0 = 1$ and $\pi_1 < 0$ are constrained, corresponding to the effects of all the terms and the main effects on the probability of inclusion. These constraints limit the inclusion of main effects via π_1 and thus guide the stochastic search to more parsimonious models in terms of the number of main effects included in the model. This is important in that the relatively small sample size in this example ($N = 211$) prohibits the fitting of models with too many main effects. However, once a set of main effects is included in a model, one wants to encourage the exploration of models with interactions. Thus, by setting $\pi_0 = 1$, the expectation of the inclusion of an interaction conditional on the inclusion of the parental main effects is relatively high (21).

Sensitivity to Prior Specification

To compare and investigate the sensitivity of inference to the prior covariate specification, two alternative specifications are used. First, the above prior covariate matrix is altered by the assumption that *CYP2A6* has the same impact as *UGT1A4*. This is accomplished by replacing the “4” with a “1” in the previously described prior covariate matrix. Second, in assuming that the prior knowledge is limited, a prior covariate design matrix is used with five dummy variables indicating the gene in which a specific polymorphism

is found. Here, it is assumed that all the polymorphisms within a gene are exchangeable or share a common mean with a different mean for each gene. This allows sharing among polymorphisms within a gene, but not across genes.

Results

Univariately, polymorphisms for groups (B) and (C) for *CYP2A6* were significantly associated with measured nicotine clearance levels as seen in table 12.1 ($t_B = 2.15$, p -value = 0.03; $t_C = 3.86$, and p -value = 0.0002, respectively). In addition, SNP 4 within *UGT1A4* had a statistically significant result ($t_{SNP4} = 2.19$, p -value = 0.03). Because of the small sample size, a model could not be fitted in which all possible polymorphisms were included as represented in equation (2), thus limiting any further exploration of full joint models with interactions without some type of model selection procedure.

The hierarchical stochastic search model was implemented by using the statistical software R.¹¹² Posterior inference was based on 50,000 samples from a single chain after discarding the first 10,000 samples (i.e., burn-in) to ensure that the final inference is independent of the starting values.¹¹³ Visual inspection of time series and sensitivity to inference over time was used to check for convergence and model performance. The burn-in period was selected because it was found that the constraints in both the means and the probability portions of the model allowed for a nonzero probability of including any given main effect in the model. This results in sufficient mixing within the model space and a very limited dependence on the starting model. For example, under the null of no association between any

$$\Pr(\gamma_{m0} = 1 \mid \gamma_m = 1, \gamma_\ell = 1) = \frac{\exp(0)}{1 + \exp(0)} = 0.5 \quad (21)$$

Table 12.1 Results for Nicotine Clearance

Gene	Variant	Univariate		Hierarchical model			
		T^1	p -value	\tilde{E}_v^2	\tilde{P}_v^3	$BF(\tilde{P}_v)^4$	$BF(\gamma_v = 1)^5$
<i>CYP2A6</i>	Group A (*1/*1)	—	—	—	—	—	—
	Group B (*1/*9 or *1/*12)	2.15	0.03	3.53	0.09	3.16	17.38
	Group C (*1/*2; *1/*4; *9/*12; *9/*4; *9/*9)	3.86	0.0002	3.53	0.94	534.37	17.38
<i>CYP2B6</i>	SNP 1	1.22	0.23	2.14	0.02	0.62	0.82
	SNP 2	1.82	0.07	2.27	0.04	1.33	0.82
	SNP 3	1.56	0.12	1.78	0.04	1.36	0.74
	SNP 4	1.69	0.09	2.32	0.03	0.90	0.82
<i>CYP2D6</i>	SNP 1	0.21	0.83	1.51	0.02	0.49	0.70
<i>UGT1A4</i>	SNP 1	0.38	0.70	2.19	0.01	0.40	0.84
	SNP 2	0.02	0.98	2.18	0.01	0.40	0.84
	SNP 3	0.07	0.94	1.64	0.02	0.56	0.81
	SNP 4	2.19	0.031	2.01	0.08	3.90	0.76
	SNP 5	0.55	0.58	1.69	0.02	0.52	0.77
	SNP 6	1.57	0.12	2.43	0.02	0.75	0.81
	SNP 7	0.81	0.42	2.16	0.02	0.65	0.84
<i>UGT2B7</i>	SNP 1	1.22	0.23	1.58	0.03	0.84	0.73
	SNP 2	0.12	0.90	1.83	0.02	0.42	0.76
	SNP 3	0.50	0.62	1.53	0.02	0.54	0.67
	SNP 4	0.05	0.96	2.23	0.02	0.58	0.73

Note. Results were obtained by using a conventional univariate regression analysis and from the hierarchical stochastic search by using informative prior covariates derived from the ontology.

¹The absolute value of the χ test statistic obtained from the Wald-type test from a univariate regression model.

²Posterior expectation of the χ test statistic.

³Posterior expectation of the probability that the association is true.

⁴Bayes factor for the probability that the association is true.

⁵Bayes factor for the inclusion of the corresponding term in the regression model.

polymorphisms and nicotine, the average probability of including any term was 3%. This encourages sampling the model space, but since the probability of including a term is nonzero under the null, it also highlights the need to compare posterior estimates of the probability of a true association and the probability of including a given term conditional on the data to those under the null via Bayes factors to obtain valid inference. To guarantee sufficient mixing within the local model space, a random

walk over 500 iterations was incorporated in which an additional main effect to the model under evaluation was included.

The focus initially is on the posterior estimates of the magnitude of the association \tilde{E}_v for nicotine clearance. Recall that the ontology specified that the two groups of polymorphisms in *CYP2A6* would have twice the effect of polymorphisms in *UGT1A4* and that there would be no effect for all other variants in other genes.

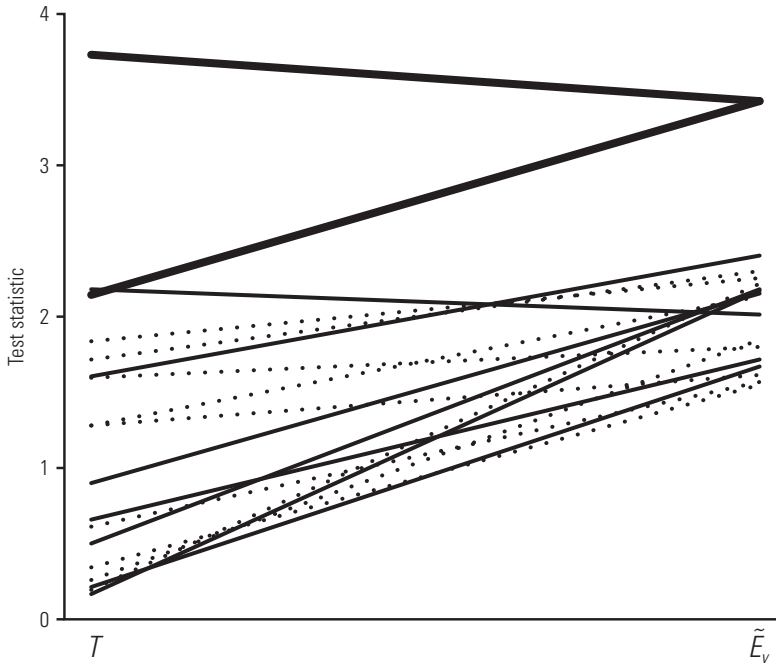
Figure 12.3 Shrinkage of Test Statistics

Note. Shown is the shrinkage of the univariate test statistics T by the hierarchical stochastic search to yield the posterior estimates of effect size \tilde{E}_v . For each term, the test statistic obtained from the univariate analysis is paired with the posterior estimate, demonstrating shrinkage to a conditional mean specified by the prior covariate structure.

This structure is reflected in the posterior estimates for \tilde{E}_v , summarized in table 12.1. The two groups of polymorphisms in *CYP2A6* have similar posterior estimates of $\tilde{E}_{CYP2A6,B} = 3.53$ and $\tilde{E}_{CYP2A6,C} = 3.53$. Similarly, the estimates for the posterior magnitude of the test statistics for SNPs within *UGT1A4* are shifted toward each other, albeit at a lower magnitude. The combined effect of the prior covariates is more clearly seen in figure 12.3, which demonstrates the shrinkage of the original test statistic to the posterior estimates. First, by grouping all main effects via the second covariate in \mathbf{Z}_μ , all the posterior estimates are shrunk upward toward a group effect. Furthermore, within this upward shrinkage, the prior covariate based on the ontology allows further borrowing of effects within *CYP2A6* (the bold solid lines) to be four times the magnitude of that of the SNPs within

UGT1A4 (the thin solid line). All other polymorphisms (dashed lines) have upward shrinkage based solely on the grouping of main effects.

In focusing on the posterior estimates of the probability of a true association \tilde{P}_v , it can be seen that *CYP2A6* group C has a much larger probability of being true ($\tilde{P}_{CYP2A6,C} = 0.94$) in comparison with group B ($\tilde{P}_{CYP2A6,B} = 0.09$) despite their similar posterior estimates for \tilde{E}_v . This is due to the contribution of the data for each polymorphism group reflected through their corresponding first-stage test statistic of $T = 3.86$ and $T = 2.15$, respectively. Furthermore, because the posterior probability is not zero under the null, inference into the significance of this estimate should be made via the Bayes factor. Here, very strong evidence can be seen for a true association for group C in

CYP2A6 ($BF(\tilde{P}_{CYP2A6,C}) = 534.37$) as well as positive evidence for an association of group B in *CYP2A6* ($BF(\tilde{P}_{CYP2A6,C}) = 3.16$). In addition, an indication can be seen for positive evidence of an association for SNP 4 in *UGT1A4* with $BF(\tilde{P}_{UGT1A4,A}) = 3.90$. Although these conclusions are qualitatively similar to conclusions based on the results obtained from the univariate analyses, there are some notable differences. For example, the test statistics obtained for group B in *CYP2A6* and for SNP 4 in *UGT1A4* are similar, suggesting comparable evidence for an association. However, they have very different posterior estimates for \tilde{E}_v with $\tilde{E}_{CYP2A6,B} = 3.53$ and $\tilde{E}_{UGT1A4,A} = 2.01$, reflecting the borrowing of information via the prior structure; mainly, the test statistic for group B is shrunk upwards toward group C within *CYP2A6*. When one accounts for the influence of the prior structure and focuses on the Bayes factors for a true association, there is slightly more evidence for SNP 4 in *UGT1A4*: $BF(\tilde{P}_{UGT1A4,6}) = 3.90$ versus $BF(\tilde{P}_{CYP2A6,B}) = 3.16$. The evidence for group B is tempered because of the strong prior for the influence of *CYP2A6*—that is, it would have a fourfold increase in effect. In contrast, it was believed that *UGT1A4* would have a much smaller effect, and thus, the impact of the data relative to the prior is greater.

The hierarchical stochastic search model did not find any evidence for interactions between polymorphisms or between the polymorphisms with age. Most likely, this is mainly a reflection of the limitations for obtaining statistical significance for interactions with such a small sample size ($N = 211$) of a narrow age range. However, one of the major goals of incorporating prior knowledge was to have an efficient stochastic search across the model space. In this regard, guiding the stochastic search via the proposal distribution as a function of the probability that an association is true results in a very high acceptance rate during the MCMC iterations (across the various

analyses, on average 90% of the proposed models are accepted). At first glance, this high acceptance rate may indicate poor mixing in the MCMC chain, leaving one unable to move around in the model space. To some extent, the exploration of the entire space is limited, but sampling of models believed to be more biologically plausible is actively encouraged. Specifically, the prior structure given from the ontology indicates the desirability of investigating interactions between *CYP2A6* and *UGT1A4*. As evidence of a guided search, it was found that, conditional on the inclusion of the two polymorphism groups within *CYP2A6*, interactions with SNPs within *UGT1A4* are included in 3% of the models searched. In contrast, in performing a stochastic variable selection and substituting a binomial proposal distribution that is not dependent on a prior structure but has probabilities reflective of the hierarchical model under the null, it is found that interactions between *CYP2A6* and *UGT1A4* are included in less than 0.1% of the models searched.

To gauge the sensitivity of the results to prior specification, two additional analyses were run using different prior covariates. To mimic the influence of incorrect priors and assuming a lack of knowledge for *CYP2A6*, a “1” was substituted in place of the “4” for *CYP2A6* in the previous prior covariate matrix. This had little impact on the final inference in regard to the posterior estimates corresponding to *CYP2A6*, further indicating that the data are driving the results for *CYP2A6*. However, under this prior structure, estimates for polymorphisms within *UGT1A4* were slightly attenuated because they were no longer shrunk upward toward the *CYP2A6* estimates, for SNP 4 $\tilde{E}_{UGT1A4,A} = 1.73$. Despite the change in estimates, the Bayes factor for the posterior probability of a true association still indicated some positive evidence for SNP 4, $BF(\tilde{P}_{UGT1A4,A}) = 3.81$. With the gene-specific prior covariate matrix that includes

a set of dummy variables indicating which gene an SNP is in, qualitatively similar results are found. Of course, inference in terms of both posterior estimate and the magnitude of the Bayes factors varies, reflecting differences in the borrowing of information across polymorphisms as specified by the prior structure (results not shown).

Results for the analysis in regard to 3HC/COT are presented in table 12.2. As before, similar

patterns are apparent in posterior estimates with the most notable evidence provided for the two groups of polymorphisms in *CYP2A6*. Of note are the estimates for SNPs in *UGT2B7*. For 3HC/COT, a prior covariate matrix was specified that placed a slight emphasis on *UGT2B7* in conjunction with *CYP2A6*. For the posterior estimation for the magnitude \tilde{E}_v , the four SNPs in *UGT2B7* are shrunk upward, reflecting a borrowing of information from the larger *CYP2A6* estimates.

Table 12.2 Results for 3HC/COT Ratios

Gene	Variant	Univariate		Hierarchical model			
		T^1	p -value	\tilde{E}_v^2	\tilde{P}_v^3	$BF(\tilde{P}_v)^4$	$BF(\gamma_v = 1)^5$
<i>CYP2A6</i>	Group A (*1/*1)	—	—	—	—	—	—
	Group B (*1/*9 or *1/*12)	-2.53	0.01	4.39	0.09	2.83	13.87
	Group C (*1/*2; *1/*4; *9/*12; *9/*4; *9/*9)	-4.9	4.0E-06	4.39	0.92	291.79	13.87
<i>CYP2B6</i>	SNP 1	-1.47	0.15	1.17	0.06	1.28	1.10
	SNP 2	2.39	0.02	1.35	0.14	3.47	1.02
	SNP 3	1.31	0.19	1.16	0.04	1.02	0.64
	SNP 4	2.18	0.03	1.22	0.09	2.25	1.05
<i>CYP2D6</i>	SNP 1	-0.51	0.61	1.32	0.03	0.58	0.86
<i>UGT1A4</i>	SNP 1	0.13	0.90	0.95	0.03	0.71	1.03
	SNP 2	-0.68	0.50	1.00	0.03	0.77	1.03
	SNP 3	0.93	0.35	0.98	0.04	1.03	0.97
	SNP 4	1.56	0.12	1.02	0.05	1.19	0.86
	SNP 5	0.89	0.38	0.95	0.03	0.80	1.00
	SNP 6	1.55	0.12	0.97	0.04	1.20	1.06
	SNP 7	-0.34	0.74	0.94	0.03	0.71	1.00
<i>UGT2B7</i>	SNP 1	-0.94	0.35	1.03	0.03	0.87	1.05
	SNP 2	0.16	0.87	0.86	0.03	0.80	0.97
	SNP 3	0.6	0.55	0.95	0.04	1.08	1.05
	SNP 4	-2.49	0.01	1.36	0.17	4.90	1.16

Note. Results were obtained by using a conventional univariate regression analysis and from the hierarchical stochastic search by using informative prior covariates derived from the ontology. 3HC/COT = *trans* 3'-hydroxycotinine to cotinine ratio.

¹The absolute value of the χ test statistic obtained from the Wald-type test from a univariate regression model.

²Posterior expectation of the χ test statistic.

³Posterior expectation of the probability that the association is true.

⁴Bayes factor for the probability that the association is true.

⁵Bayes factor for the inclusion of the corresponding term in the regression model.

Discussion

Statistical modeling does have limits, especially when evaluating multiple exposures and genes with a limited sample size. In light of these limitations, conventional univariate analyses can be appealing in their ease of implementation and straightforward interpretation. However, building upon the knowledge that guided the initial selection of the SNPs and genes for investigating, most researchers feel compelled to go beyond the independent treatment of each gene and attempt to model more complex joint action and interactions. Often, this includes ad hoc criteria for model building on the basis of prior biological knowledge with the analyst balancing the complexity of each model investigated with real world limitations of the data, such as multicollinearity, sparse data bias, and instability. Rarely do final models accurately reflect the statistical costs in terms of multiple comparisons or the uncertainty in arriving at a given “best” model. As an alternative, the analyst may opt to use strictly data-driven approaches and search for significant interactions by using statistical criteria. Within this context, the method presented here represents the use of a hierarchical model together with a means of using prior knowledge to guide statistical model selection by means of an ontology.

The idea of placing more emphasis on more biologically relevant SNPs is not new. Several other approaches have been presented. The false positive report probability uses prior information in the form of an investigator’s prior belief that an association is true. Likewise, a weighted FDR and Bayesian FDR approach have been presented to incorporate outside information on the a priori impact of a particular SNP. However, these approaches rely on prespecification of the weight or prior for every SNP and interaction term without allowing the data to enhance

or attenuate the influence of the prior information. In contrast, the hierarchical modeling approach discussed here relies on prespecification of only *how* it is believed that SNPs and interaction terms are related, but it relies on the data to determine *the degree* or the weight of the various specifications or prior covariates. This has the advantage of giving some flexibility in the prior specification, and correspondingly, final inference and conclusions may be less sensitive to those specifications. Thus, the posterior estimates for the importance of each term and interaction are conditional on the prior knowledge, and within this modeling framework these parameters are naturally interpreted in the context of that knowledge. This avoids having post hoc justification and rectification of conventional results with what is known. As knowledge changes, the analyses can be rerun to gauge how new knowledge combined with the sampled data may alter final conclusions. While sensitivity analysis is a vital part of any comprehensive Bayesian analysis, with subjective priors one does not expect the results to be quantitatively similar across a variety of prior structures. In fact, the goal is just the opposite. One would like to use subjective knowledge as a guide to models that would not have been found otherwise or to enhance posterior estimates that may have been overlooked without shrinkage to other SNPs or genes. But, one must also be careful that the final inference does not solely reflect specific prior beliefs. The use of Bayes factors gauges the evidence for the conclusions conditional on the data and in the context of the priors.

Ultimately, it is a fine line between deterministic weights and informative priors. The authors of this chapter believe that this line is drawn by the quality of the prior information. While much has been done with hierarchical modeling in epidemiological analysis, relatively little research has been done on the quality of

the prior covariate specification. Here, an approach is described that attempts to formalize the prior knowledge via an ontology. Ontologies provide a mechanism for investigators to specifically structure their prior knowledge in a usable format. Of course, what is specified in the ontology is not the truth, but only reflective of the available state of knowledge. As such, ontologies can and should be dynamic. In fact, how an ontology changes over time is instructive in indicating areas for advancement and further research.

Ontologies provide a structure for encoding prior knowledge or hypotheses. The existing PATO syntax allows for specifying relationships between concepts and for specifying relative quantities. An example has been given of how both relationships and relative quantities can be used to derive priors in the context of Bayesian model selection, which is, as far as known, a novel application of biological ontologies. The ontology provided a structure for estimating the prior probability that a given gene is involved in a phenotype of interest, as well as the probabilities that different pairs of genes interact with each other.

The part of the NPKO used here is based on extensive evidence from experimental studies, but it would also be possible to encode a more speculative, and even completely untested, hypothesis into an ontology structure to guide model selection. These priors would ensure that the hypothesis will be tested, with high probability, during the model selection step. Of course, whether the hypothesis is accepted will depend on the posterior probabilities after considering the data, and the strength of the evidence as reflected, for example, in the Bayes factors reported here.

In the example given, the ontology structure has been converted into quantitative priors by using expert interpretation. The reasoning followed was simple

and could be straightforwardly coded into a computational algorithm. Graph connectivity was used between phenotypes and genes to determine which priors would be nonzero: if a gene was closely connected to the phenotype of interest, the prior was set to be greater than zero. Relative measurements (of reaction rates, in this case) was also used from previous experiments to set the relative values of nonzero priors.

One can expect that one of the most valuable contributions of an ontology for larger studies will be in prioritizing the testing of potential gene-gene and SNP-SNP interactions. The sample data set used was too small to draw any conclusions regarding interactions, but for larger studies that assay a large number of polymorphisms, prioritizing interactions will be critical. Ontologies are one way of estimating a priori probabilities of different interactions. For instance, genes that are closely connected in the ontology relationship network can be hypothesized as being more likely to interact.

Finally, it is straightforward to extend this approach to provide different priors for different individual polymorphisms. For instance, rather than setting the prior expected effects for all polymorphic *CYP2A6* alleles to be the same (relative to the **1/*1* homozygote), functional polymorphism predictions could have been used to provide additional prior information. For instance, allele-specific priors could have been used for *CYP2A6*. The *CYP2A6*9* and *CYP2A6*12* alleles are known to have reduced activity (**9* reduces gene expression through an SNP in the TATA box,¹¹⁴ while **12* includes exons from the closely related *CYP2A7*, resulting in 10 amino acid substitutions relative to **1* and reduced activity¹¹⁵). The *CYP2A6*2* allele¹¹⁶ has a single amino acid substitution that completely inactivates the enzyme, and, in the *CYP2A6*4* allele, the entire gene is deleted.¹¹⁷ One could, therefore, have used

this prior knowledge (much of which could have been predicted from sequence data alone, e.g., figure 12.1) to specify different priors for the different *CYP2A6* genotypes, with the largest effects expected for individuals having the *4 or *2 alleles. Using functional information about each SNP yields a prior probability that a given SNP will affect gene function. To estimate a prior for the effect of the SNP on the phenotype of interest, one could take the product of (1) the conditional prior of the effect of a gene on the phenotype of interest (given an effect on gene function) estimated from the ontology and (2) the prior of the effect of the SNP on gene function.

When including ontological knowledge in statistical analysis, it is desirable to capture potential real world complexities while also addressing the practical limitations of the data—for example, sample size. It is believed that a stochastic variable selection procedure via a hierarchical model offers a potential approach to knowledge-based pathway analyses. Given modeling limitations, one can probabilistically restrict the number of terms included in any specific model via constraints on the conditional probabilities of including a given term. This limits the overall complexity for a regression model evaluated for each iteration of the stochastic search. However, when inference is averaged over all the models, one can begin to describe complex relations between SNPs and genes. In addition, it was demonstrated how prior knowledge can guide the stochastic search efficiently within the model space, yielding more biologically plausible models (in terms of the defined prior covariates). Of course, there is a trade-off of directing the search too narrowly and possibly missing some well-fitting models or of having a broad, nonfocused search in which one may spend most of the stochastic search in an area in which the models are not biologically relevant. Again, this hierarchical framework is a flexible approach that allows multiple sources of information (via the prior

covariates) to be included while having the advantage that their actual influence on posterior estimation and the stochastic search does not need to be prespecified but can be estimated from the data.

Details of the specific performance of the statistical model presented here in terms of estimation, sensitivity to prior covariates, ability to identify significant terms, and so on are being pursued in a separate, more statistically oriented paper. While this statistical framework makes use of MCMC methods for the stochastic search across the model space, for computational efficiency maximum likelihood approaches to estimate the first-stage generalized linear model parameters were chosen. Thus, a simplification is made when conditioning on the first-stage maximum likelihood estimates when modeling the second-stage mixture model. Clearly, one can imagine a fully Bayesian analysis in which the uncertainty in the first-stage estimates is propagated into subsequent stages. However, for model selection purposes across such a large model space, it was decided that computational efficiency trumps subtle refinement in estimation. Likewise, the second-stage mixture model uses a maximum likelihood estimation procedure as opposed to a fully Bayesian approach. Again, this decision was made for computational efficiency, and comparisons to the fully Bayesian approach for the mixture model demonstrated suitable performance.⁶⁵ With these simplifications, the computations are now on the order of hours as opposed to days with actual times depending on the specific computer. In addition to statistical issues surrounding estimation, there are also issues with how one deals with missing data across all the variables. At the heart of this model selection procedure is a likelihood comparison that requires the likelihoods to be calculated on the same number of individuals. Thus, individuals cannot be removed across models. In the

nicotine example, analysis was limited to individuals with complete data or, for the few individuals with missing genotypes, an expected score was imputed. As the number of polymorphisms examined increases, the number of individuals with any missing data will also increase, making this issue a much more serious concern. While the specifics of missing data analysis is beyond the scope of this particular work, the MCMC procedure for model selection provides a flexible framework in which to implement an imputation strategy.

Hierarchical modeling and stochastic variable selection can offer some robustness against multiple comparisons when deciding statistical significance. In 2007, Wakefield¹¹⁸ formalized the control of false discoveries in genetic epidemiology studies via a prior specification by presenting a Bayesian False Discovery Probability (BFDP). This method is relatively simple to implement and has the advantage of other proposed methods, such as the false positive report probability,⁵⁴ by specifying distributions for the null and alternative hypotheses for a given test of association. Furthermore, the BFDP may be calibrated to explicitly incorporate the costs of false discovery versus the costs of nondiscovery. The major limitation of this approach is that it treats each test of association across all polymorphisms as independent. The approach described in this chapter overcomes this limitation by representing a joint distribution over all the test statistics. That is, this method places a full distribution upon the test statistics (i.e., the second-stage mixture model) and allows for the posterior estimation of a probability of a true association conditional on the prior covariate structure. Because the hierarchical nature of the data—that is, SNPs within genes and genes within pathways—provides an opportunity to test from the “bottom up” in this analysis procedure, the method places more emphasis on tests of main effects or combinations of SNPs within a gene

in comparison to SNP interactions across genes. By formalizing the joint distribution of all the test statistics, the prior beliefs in the relations between them, and the uncertainty of the model form, the parameter estimates and corresponding uncertainty intervals will better capture the dependency between terms. This, in turn, results in tests that more effectively reflect the evaluation of multiple factors. This is in contrast to more conventional approaches, such as the Bonferroni correction and controlling for false discovery rates, in which a uniform adjustment of the critical level is made across all p -values. By focusing on the posterior estimates for final inference, some of the multiple comparison pitfalls may be avoided. However, when relying on Bayes factors to gauge statistical significance, the influence of the prior structure is removed and the focus is solely on what the data tell us. Here, one must be careful when determining a cutoff level for declaring significance and should consider the number of comparisons made in deciding what is truly significant.

Summary

An overview has been presented of the analysis of numerous SNPs across multiple genes in a pathway focusing on the overall idea of incorporating prior knowledge via ontologies into a Bayesian hierarchical framework. The method presented is viewed as a unified approach by guiding statistical model selection with one’s knowledge. In this framework, the method is based on the belief that polymorphisms, genes, and corresponding interactions vary in their biological plausibility and that by formally incorporating this differentiation into the statistical analysis, some of the difficulties in evaluating numerous factors may be lessened.

While there are many difficulties in pathway-based analyses, a pathway perspective has considerable promise. Many insights of

relations and assumptions may be gained by properly representing one's knowledge of the underlying processes via ontologies and corresponding graphical representations. Furthermore, the formal incorporation of one's knowledge into the statistical framework can both guide the model search to more relevant models and allow interpretation of findings specifically in the context of one's knowledge base. Ultimately, confirmation of results by further studies is the key to valid conclusions in this area of research. However, this hierarchical model selection procedure with the incorporation of prior knowledge can help not only in identifying individual components but also in the characterization of the underlying complexity of a particular trait's variation.

Conclusions

1. The available knowledge of nicotine dependence arises largely from studies that model the independent association of candidate genes with outcome measures. Such studies often fail to reflect the complexity of interacting factors and discrete events that can influence smoking behavior and, therefore, may not provide a clear picture of biological mechanisms affecting nicotine dependence.
2. A promising approach to the study of nicotine dependence involves the use of prior biological knowledge about the relations between genotypic and phenotypic variables in a hierarchical modeling framework. This allows prior knowledge to aid in estimating specific genotypic effects and to guide a stochastic search over all possible statistical models.
3. The use of ontologies is a promising new direction for the elucidation of the genetic basis of nicotine dependence. An ontology is a construct or model that represents entities in both genotypic and phenotypic domains as well as their interrelations. The use of an ontology permits the modeling of hierarchical relationships by using directed acyclic graphs spanning genotypes and endophenotypes and phenotypes, while taking advantage of prior knowledge to quantify these relationships, making them amenable to computational analysis.
4. A study of nicotine metabolism that used data from the Northern California Twin Registry to examine the total clearance of nicotine and the *trans* 3'-hydroxycotinine to cotinine ratio, with the Nicotine Pharmacokinetics Ontology as a framework, showed a significant association between specific polymorphisms for *CYP2A6* and measured nicotine clearance levels as well as statistically significant results for single nucleotide polymorphism 4 within *UGT1A4*.
5. Hierarchical modeling combined with the use of an ontology defining relationships between constructs of interest represents a promising area for further research in studying a possible genetic basis for nicotine dependence as well as for understanding the interaction between genetics and social and environmental influences on tobacco use and dependence.

Appendix 12A. Estimation for the Hierarchical Model

A two-step estimation procedure is performed. First, for a given regression model, obtain the maximum likelihood estimates for $\hat{\beta}_v$ and $\widehat{\text{var}}(\hat{\beta}_v)$ from a generalized linear model likelihood, $f(Y|X, \beta)$, and calculate the corresponding test statistic, t_v . Second, conditional on the set of test statistics, the contribution to the likelihood for each term in the second-stage model is the marginal distribution of t_v .

$$\begin{aligned} g(t_v | \underline{\mu}, \underline{\pi}, \sigma, \mathbf{Z}_\mu, \mathbf{Z}_\pi) &= \int a(t_v | \lambda_v) b(\lambda_v, \underline{\mu}, \underline{\pi}, \sigma, \mathbf{Z}_\mu, \mathbf{Z}_\pi) d\lambda_v \\ &= p_v \frac{a\left((t_v / \sqrt{1 + \sigma^2}) / (\underline{\mu}' \mathbf{Z}_\mu / \sqrt{1 + \sigma^2})\right)}{\sqrt{1 + \sigma^2}} + (1 - p_v) a(t_v | 0) \end{aligned}$$

where $a()$ is the chi distribution given in equation (13) and $b()$ is the mixture distribution given in equation (14). The full log-likelihood for the second-stage model is then the marginal distribution summed over the entire set of test statistics,

$$\sum_v \log\left(g(t_v | \underline{\mu}, \underline{\pi}, \sigma, \mathbf{Z}_\mu, \mathbf{Z}_\pi)\right)$$

and maximized with respect to $\Theta = (\underline{\mu}, \underline{\pi}, \sigma)$.

Application of the Bayes formula results in expressions for the posterior of the probability of an association being true:

$$\begin{aligned} P_v &= \Pr(\lambda_v > 0 | t_v, \mathbf{Z}_\mu, \mathbf{Z}_\pi; \Theta) \\ &= \frac{1}{1 + \frac{(1 - p_v)}{p_v} \frac{a(t_v | 0)}{(1 + \sigma^2)^{-1/2} a\left((t_v / \sqrt{1 + \sigma^2}) / (\underline{\mu}' \mathbf{Z}_\mu / \sqrt{1 + \sigma^2})\right)}} \end{aligned}$$

and for the posterior magnitude of the association:

$$\begin{aligned} E_v &= E(\lambda_v | \lambda_v > 0, t_v, \mathbf{Z}_\mu; \Theta) \\ &= \frac{\sigma}{\sqrt{1 + \sigma^2}} \frac{2/\pi \exp\left(-\frac{(\sigma^2 t_v^2 + (\underline{\mu}' \mathbf{Z}_\mu)^2)}{2\sigma^2}\right) + \lambda_+ \varphi(E_-)(2\Phi(\lambda_+) - 1) + \lambda_- \varphi(E_+)(2\Phi(\lambda_-) - 1)}{\varphi(E_+) + \varphi(E_-)} \end{aligned}$$

where

$$\lambda_+ = (\underline{\mu}' \mathbf{Z}_\mu + \sigma^2 t_v) / \sigma \sqrt{1 + \sigma^2}$$

$$\lambda_- = (\underline{\mu}' \mathbf{Z}_\mu - \sigma^2 t_v) / \sigma \sqrt{1 + \sigma^2}$$

$$E_+ = (t_v + \underline{\mu}' \mathbf{Z}_\mu) / \sqrt{1 + \sigma^2}$$

$$E_- = (t_v - \underline{\mu}' \mathbf{Z}_\mu) / \sqrt{1 + \sigma^2}$$

and Φ denotes the cumulative distribution function of a standard normal. Use a standard numerical maximization algorithm to maximize $\hat{\Theta}$. The estimated parameters $\hat{\Theta}$ are then substituted in the posterior expression to obtain \hat{P}_v and \hat{E}_v .

Appendix 12B. Model Selection Algorithm

Assuming that the second-stage mixed model is independent of the regression model conditional on the test statistics, first define the posterior probability as

$$h(\underline{\gamma} | Y, \mathbf{X}) \propto \sum f(Y | \mathbf{X}, \underline{\beta}, \underline{\gamma}) \prod g(t_v | \mathbf{Z}_\mu, \mathbf{Z}_\pi; \Theta) q(\underline{\gamma}) d\gamma$$

where $f(Y | \mathbf{X}, \underline{\beta}, \underline{\gamma})$ is the log-likelihood of the first-stage regression model. Because the model space is tremendous, one should not attempt to obtain a posterior estimation for the $\underline{\gamma}$ s by integrating over all possible models. Instead, adopt an MCMC approach by using a Metropolis-Hastings algorithm.¹¹³ Thus, during the iterations of the Markov chain, accept a new vector of $\underline{\gamma}$ s, $\underline{\gamma}^*$ at iteration $(i + 1)$ with probability

$$\alpha(\underline{\gamma}^i, \underline{\gamma}^*) = \min \left[1, \frac{h(\underline{\gamma}^* | Y, \mathbf{X}) PD(\underline{\gamma}^i | \underline{\gamma}^*)}{h(\underline{\gamma}^i | Y, \mathbf{X}) PD(\underline{\gamma}^* | \underline{\gamma}^i)} \right]$$

Here, a proposal distribution (PD) is defined as a function of \hat{P}_v^i , the probability that a term is associated with the outcome. Specifically, PD is defined as

$$PD(\underline{\gamma}^* | \underline{\gamma}^i, \hat{P}^i) = \prod_v \hat{P}_v^i \gamma_v^* + (1 - \hat{P}_v^i)(1 - \gamma_v^*)$$

where $\hat{P}_v^i = \Pr(\lambda_v > 0 | t_v, \gamma_v^i, \mathbf{Z}_\mu, \mathbf{Z}_\pi; \Theta)$. That is, the probability of a proposed vector of $\underline{\gamma}$ s is dependent upon the probability that the terms are associated with the outcome given the vector of $\underline{\gamma}$ s at iteration i .

The MCMC algorithm is

Initiate $\underline{\gamma}^0$ at $i = 0$

Repeat {

 For iteration i

 For all V ,

 Sample $\gamma_v^* \sim \text{Bernoulli}(\hat{P}_v^i)$

 Obtain t_v^* from $f(Y | \mathbf{X}, \underline{t}^*, \underline{\gamma}^*)$ if $\gamma_v^* = 1$ and from $\chi_1(0)$ if $\gamma_v^* = 0$

 Estimate \hat{P}_v^* and \hat{E}_v^* by maximizing $\sum_v g(t_v | \mathbf{Z}_\mu, \mathbf{Z}_\pi; \Theta)$

 Calculate $PD(\underline{\gamma}^* | \underline{\gamma}^i, \hat{P}^i)$ and $PD(\underline{\gamma}^i | \underline{\gamma}^*, \hat{P}^*)$

 Calculate $\alpha(\underline{\gamma}^i, \underline{\gamma}^*)$

 Sample $u \sim U(0,1)$

 If $u \leq \alpha(\underline{\gamma}^i, \underline{\gamma}^*)$

 Then $\underline{\gamma}^{i+1} = \underline{\gamma}^*$, $\hat{P}^{i+1} = \hat{P}^*$, $\hat{E}^{i+1} = \hat{E}^*$

 Else $\underline{\gamma}^{i+1} = \underline{\gamma}^i$, $\hat{P}^{i+1} = \hat{P}^i$, $\hat{E}^{i+1} = \hat{E}^i$

$i = i + 1$

 }

References

- Swan, G. E., N. L. Benowitz, P. Jacob 3rd, C. N. Lessov, R. F. Tyndale, K. Wilhelmsen, R. E. Krasnow, M. R. McElroy, S. E. Moore, and M. Wambach. 2004. Pharmacogenetics of nicotine metabolism in twins: Methods and procedures. *Twin Research* 7 (5): 435–48.
- Swan, G. E., N. L. Benowitz, C. N. Lessov, P. Jacob 3rd, R. F. Tyndale, and K. Wilhelmsen. 2005. Nicotine metabolism: The impact of CYP2A6 on estimates of additive genetic influence. *Pharmacogenetics and Genomics* 15 (2): 115–25.
- Dedobbeleer, N., F. Beland, A. P. Contandriopoulos, and M. Adrian. 2004. Gender and the social context of smoking behaviour. *Social Science and Medicine* 58 (1): 1–12.
- Evans, R. I. 1976. Smoking in children: Developing a social psychological strategy of deterrence. *Preventive Medicine* 5 (1): 122–7.
- Kandel, D. B., K. Yamaguchi, and K. Chen. 1992. Stages of progression in drug involvement from adolescence to adulthood: Further evidence for the gateway theory. *Journal of Studies on Alcohol* 53 (5): 447–57.
- Shih, J. C., and R. F. Thompson. 1999. Monoamine oxidase in neuropsychiatry and behavior. *American Journal of Human Genetics* 65 (3): 593–98.
- Brunner, H. G., M. Nelen, X. O. Breakefield, H. H. Ropers, and B. A. van Oost. 1993. Abnormal behavior associated with a point mutation in the structural gene for monoamine oxidase A. *Science* 262 (5133): 578–80.
- Cases, O., I. Seif, J. Grimsby, P. Gaspar, K. Chen, S. Pourmin, U. Muller, et al. 1995. Aggressive behavior and altered amounts of brain serotonin and norepinephrine in mice lacking MAOA. *Science* 268 (5218): 1763–66.
- Whitfield, J. B., D. Pang, K. K. Bucholz, P. A. Madden, A. C. Heath, D. J. Statham, and N. G. Martin. 2000. Monoamine oxidase: Associations with alcohol dependence, smoking and other measures of psychopathology. *Psychological Medicine* 30 (2): 443–54.
- Brennan, P. 2002. Gene-environment interaction and aetiology of cancer: What does it mean and how can we measure it? *Carcinogenesis* 23 (3): 381–87.
- Cordell, H. J. 2002. Epistasis: What it means, what it doesn't mean, and statistical methods to detect it in humans. *Human Molecular Genetics* 11 (20): 2463–68.
- Chatterjee, N., Z. Kalaylioglu, R. Moslehi, U. Peters, and S. Wacholder. 2006. Powerful multilocus tests of genetic association in the presence of gene-gene and gene-environment interactions. *American Journal of Human Genetics* 79 (6): 1002–1016.
- Kell, D. B. 2005. Metabolomics, machine learning and modelling: Towards an understanding of the language of cells. *Biochemical Society Transactions* 33 (Pt. 3): 520–24.
- Thomas, C. E., and G. Ganji. 2006. Integration of genomic and metabonomic data in systems biology—are we 'there' yet? *Current Opinion in Drug Discovery & Development* 9 (1): 92–100.
- Sellers, T. A., and J. R. Yates. 2003. Review of proteomics with applications to genetic epidemiology. *Genetic Epidemiology* 24 (2): 83–98.
- Feng, Z., R. Prentice, and S. Srivastava. 2004. Research issues and strategies for genomic and proteomic biomarker discovery and validation: A statistical perspective. *Pharmacogenomics* 5 (6): 709–19.
- Jones, P. A., and S. B. Baylin. 2002. The fundamental role of epigenetic events in cancer. *Nature Reviews Genetics* 3 (6): 415–28.
- Cusick, M. E., N. Klitgord, M. Vidal, and D. E. Hill. 2005. Interactome: Gateway into systems biology. *Human Molecular Genetics* 14 Spec No. 2: R171–R181.
- Vidal, M. 2005. Interactome modeling. *FEBS Letters* 579 (8): 1834–38.
- Wachi, S., K. Yoneda, and R. Wu. 2005. Interactome-transcriptome analysis reveals the high centrality of genes differentially expressed in lung cancer tissues. *Bioinformatics* 21 (23): 4205–8.
- Greenland, S. 1993. Methods for epidemiologic analyses of multiple exposures: A review and comparative study of maximum-likelihood, preliminary-testing, and empirical-Bayes regression. *Statistics in Medicine* 12 (8): 717–36.
- Hastie, T., R. Tibshirani, and J. Friedman. 2001. *The elements of statistical learning*. New York: Springer.
- Breiman, L. 2001. Random forests. *Machine Learning* 45 (1): 5–32.

24. Ruczinski, I., C. Kooperberg, and M. LeBlanc. 2003. Logic regression. *Journal of Computational and Graphical Statistics* 12 (3): 475–511.
25. Millstein, J., D. V. Conti, F. D. Gilliland, and W. J. Gauderman. 2006. A testing framework for identifying susceptibility genes in the presence of epistasis. *American Journal of Human Genetics* 78 (1): 15–27.
26. Benjamini, Y., D. Drai, G. Elmer, N. Kafkafi, and I. Golani. 2001. Controlling the false discovery rate in behavior genetics research. *Behavioural Brain Research* 125 (1–2): 279–84.
27. Sabatti, C., S. Service, and N. Freimer. 2002. *False discovery rate in and correction for multiple comparisons in linkage disequilibrium genome screens*, Paper 2002010116. Los Angeles: Univ. of California Los Angeles. Department of Statistics. <http://repositories.cdlib.org/uclastat/papers/2002010116>.
28. Devlin, B., K. Roeder, and L. Wasserman. 2003. Analysis of multilocus models of association. *Genetic Epidemiology* 25 (1): 36–47.
29. Sabatti, C., S. Service, and N. Freimer. 2003. False discovery rate in linkage and association genome screens for complex disorders. *Genetics* 164 (2): 829–33.
30. Whittemore, A. S. 2007. A Bayesian false discovery rate for multiple testing. *Journal of Applied Statistics* 34 (1): 1–9.
31. Thomas, D. C. 2005. The need for a systematic approach to complex pathways in molecular epidemiology. *Cancer Epidemiology, Biomarkers, & Prevention* 14 (3): 557–9.
32. Cortessis, V., and D. C. Thomas. 2003. Toxicokinetic genetics: An approach to gene-environment and gene-gene interactions in complex metabolic pathways. In *Mechanistic considerations in the molecular epidemiology of cancer*, ed. P. Bird, P. Boffetta, P. Buffler, and J. Rice, 127–50. Lyon, France: IARC Scientific Publications.
33. Gruber, T. R. 1993. A translation approach to portable ontology specifications. *Knowledge Acquisition* 5 (2): 199–220.
34. McCullagh, P., and J. A. Nelder. 1989. *Generalized linear models*. 2nd ed. Boca Raton, FL: CRC Press.
35. Schaid, D. J. 1996. General score tests for associations of genetic markers with disease using cases and their parents. *Genetic Epidemiology* 13 (5): 423–49.
36. Schaid, D. J. 2002. Relative efficiency of ambiguous vs. directly measured haplotype frequencies. *Genetic Epidemiology* 23 (4): 426–43.
37. Zaykin, D. V., P. H. Westfall, S. S. Young, M. A. Karnoub, M. J. Wagner, and M. G. Ehm. 2002. Testing association of statistically inferred haplotypes with discrete and continuous traits in samples of unrelated individuals. *Human Heredity* 53 (2): 79–91.
38. Stram, D. O., C. A. Haiman, J. N. Hirschhorn, D. Altshuler, L. N. Kolonel, B. E. Henderson, and M. C. Pike. 2003. Choosing haplotype-tagging SNPs based on unphased genotype data using a preliminary sample of unrelated subjects with an example from the Multiethnic Cohort Study. *Human Heredity* 55 (1): 27–36.
39. Stram, D. O. 2005. Software for tag single nucleotide polymorphism selection. *Human Genomics* 2 (2): 144–51.
40. Cordell, H. J. 2006. Estimation and testing of genotype and haplotype effects in case-control studies: Comparison of weighted regression and multiple imputation procedures. *Genetic Epidemiology* 30 (3): 259–75.
41. Kraft, P., D. G. Cox, R. A. Paynter, D. Hunter, and I. De Vivo. 2005. Accounting for haplotype uncertainty in matched association studies: A comparison of simple and flexible techniques. *Genetic Epidemiology* 28 (3): 261–72.
42. Schaid, D. J. 2004. Evaluating associations of haplotypes with traits. *Genetic Epidemiology* 27 (4): 348–64.
43. Schaid, D. J. 2006. Power and sample size for testing associations of haplotypes with complex traits. *Annals of Human Genetics* 70 (Pt. 1): 116–30.
44. Conti, D. V., and W. J. Gauderman. 2004. SNPs, haplotypes, and model selection in a candidate gene region: The SIMPLe analysis for multilocus data. *Genetic Epidemiology* 27 (4): 429–41.
45. Excoffier, L., and M. Slatkin. 1995. Maximum-likelihood estimation of molecular haplotype frequencies in a diploid population. *Molecular Biology and Evolution* 12 (5): 921–7.
46. Robins, J. M., and S. Greenland. 1986. The role of model selection in causal inference from nonexperimental data. *American Journal of Epidemiology* 123 (3): 392–402.

47. Goodman, S. N. 1998. Multiple comparisons, explained. *American Journal of Epidemiology* 147 (9): 807–12.
48. Thompson, J. R. 1998. Invited commentary: Re: “Multiple comparisons and related issues in the interpretation of epidemiologic data.” *American Journal of Epidemiology* 147 (9): 801–6.
49. Greenland, S. 2000. Principles of multilevel modelling. *International Journal of Epidemiology* 29 (1): 158–67.
50. Greenland, S. 2000. When should epidemiologic regressions use random coefficients? *Biometrics* 56 (3): 915–21.
51. Witte, J. S. 1997. Genetic analysis with hierarchical models. *Genetic Epidemiology* 14 (6): 1137–42.
52. Witte, J. S., and S. Greenland. 1996. Simulation study of hierarchical regression. *Statistics in Medicine* 15 (11): 1161–70.
53. Witte, J. S., S. Greenland, R. W. Haile, and C. L. Bird. 1994. Hierarchical regression analysis applied to a study of multiple dietary exposures and breast cancer. *Epidemiology* 5 (6): 612–21.
54. Wacholder, S., S. Chanock, M. Garcia-Closas, L. El Ghormli, and N. Rothman. 2004. Assessing the probability that a positive report is false: An approach for molecular epidemiology studies. *Journal of the National Cancer Institute* 96 (6): 434–42.
55. Thomas, D. C., and D. G. Clayton. 2004. Betting odds and genetic associations. *Journal of the National Cancer Institute* 96 (6): 421–3.
56. Aragaki, C. C., S. Greenland, N. Probst-Hensch, and R. W. Haile. 1997. Hierarchical modeling of gene-environment interactions: Estimating NAT2 genotype-specific dietary effects on adenomatous polyps. *Cancer Epidemiology, Biomarkers & Prevention* 6 (5): 307–14.
57. Hung, R. J., P. Brennan, C. Malaveille, S. Porru, F. Donato, P. Boffetta, and J. S. Witte. 2004. Using hierarchical modeling in genetic association studies with multiple markers: Application to a case-control study of bladder cancer. *Cancer Epidemiology, Biomarkers & Prevention* 13 (6): 1013–21.
58. Conti, D. V., V. Cortessis, J. Molitor, and D. C. Thomas. 2003. Bayesian modeling of complex metabolic pathways. *Human Heredity* 56 (1-3): 83–93.
59. George, E. I., and R. E. McCulloch. 1993. Variable selection via Gibbs sampling. *Journal of the American Statistical Association* 88 (423): 881–89.
60. George, E. I., and D. P. Foster. 2000. Calibration and empirical Bayes variable selection. *Biometrika* 87 (4): 731–47.
61. George, E. I., and R. E. McCulloch. 1995. Stochastic search variable selection. In *Markov chain Monte Carlo in practice*, ed. W. R. Gilks, S. Richardson, and D. J. Spiegelhalter, 203–14. London: Chapman and Hall.
62. Spiegelhalter, D., A. Thomas, N. Best, and D. Lunn. 2003. *WinBUGS user manual*. Version 1.4. Cambridge, UK: Univ. of Cambridge, Institute of Public Health. <http://www.mrc-bsu.cam.ac.uk/bugs/winbugs/manual14.pdf>.
63. Chipman, H. 1996. Bayesian variable selection with related predictors. *Canadian Journal of Statistics* 24 (1): 17–36.
64. Chipman, H. A., E. I. George, and R. E. McCulloch. 2001. Managing multiple models. In *Artificial intelligence and statistics 2001*, ed. T. Jaakkola and T. Richardson. San Francisco: Morgan Kaufmann.
65. Lewinger, J. P., D. V. Conti, J. W. Baurley, T. J. Triche, and D. C. Thomas. 2007. Hierarchical Bayes prioritization of marker associations from a genome-wide association scan for further investigation. *Genetic Epidemiology* 31 (8): 871–82.
66. Kass, R. E., and A. E. Raftery. 1995. Bayes factors. *Journal of the American Statistical Association* 90 (430): 773–95.
67. Patil, N., A. J. Berno, D. A. Hinds, W. A. Barrett, J. M. Doshi, C. R. Hacker, C. R. Kautzer, et al. 2001. Blocks of limited haplotype diversity revealed by high-resolution scanning of human chromosome 21. *Science* 294 (5547): 1719–23.
68. Kimura, M. 1983. *The neutral theory of molecular evolution*. Cambridge, UK: Cambridge Univ. Press.
69. Fred Hutchinson Cancer Research Center. 2008. Sorting intolerant from tolerant. <http://blocks.fhrc.org/sift/SIFT.html> (accessed December 19, 2008).
70. Harvard University. 2008. *PolyPhen: Prediction of functional effect of human nsSNPs*. <http://genetics.bwh.harvard.edu/pph> (accessed December 19, 2008).
71. SRI International. 2008. Evolutionary analysis of coding SNPs. <http://www.pantherdb.org/tools/csnpscoreForm.jsp> (accessed December 19, 2008).

72. Ng, P. C., and S. Henikoff. 2001. Predicting deleterious amino acid substitutions. *Genome Research* 11 (5): 863–74.
73. Sunyaev, S., V. Ramensky, I. Koch, W. Lathe 3rd, A. S. Kondrashov, and P. Bork. 2001. Prediction of deleterious human alleles. *Human Molecular Genetics* 10 (6): 591–7.
74. Thomas, P. D., M. J. Campbell, A. Kejariwal, H. Mi, B. Karlak, R. Daverman, K. Diemer, A. Muruganujan, and A. Narechania. 2003. PANTHER: A library of protein families and subfamilies indexed by function. *Genome Research* 13 (9): 2129–41.
75. Yue, P., E. Melamud, and J. Moul. 2006. SNPs3D: Candidate gene and SNP selection for association studies. *BMC Bioinformatics* 7:166.
76. Margulies, E. H., M. Blanchette, D. Haussler, and E. D. Green. 2003. Identification and characterization of multi-species conserved sequences. *Genome Research* 13 (12): 2507–18.
77. Research Collaboratory for Structural Bioinformatics. 2008. RCSB protein data bank. <http://www.rcsb.org/pdb/explore.do?structureID=2FDU> (accessed December 19, 2008).
78. Bader, G. D., M. P. Cary, and C. Sander. 2006. Pathguide: A pathway resource list. *Nucleic Acids Research* 34 (Database issue): D504–D506.
79. SRI International. 2008. HumanCyc database. <http://biocyc.org/HUMAN/NEW-IMAGE?type=PATHWAY&object=PWY66-201> (accessed December 19, 2008).
80. SRI International. 2008. PANTHER classification system. <http://www.pantherdb.org> (accessed December 19, 2008).
81. Piper, M. E., D. E. McCarthy, and T. B. Baker. 2006. Assessing tobacco dependence: A guide to measure evaluation and selection. *Nicotine & Tobacco Research* 8 (3): 339–51.
82. Smith, B., W. Ceusters, B. Klagges, J. Kohler, A. Kumar, J. Lomax, C. Mungall, F. Neuhaus, A. L. Rector, and C. Rosse. 2005. Relations in biomedical ontologies. *Genome Biology* 6 (5): R46.
83. Karp, P. D. 2001. Pathway databases: A case study in computational symbolic theories. *Science* 293 (5537): 2040–4.
84. Aranguren, M. E., S. Bechhofer, P. Lord, U. Sattler, and R. Stevens. 2007. Understanding and using the meaning of statements in a bio-ontology: Recasting the Gene Ontology in OWL. *BMC Bioinformatics* 8: 57.
85. Ashburner, M., C. A. Ball, J. A. Blake, D. Botstein, H. Butler, J. M. Cherry, A. P. Davis, et al. 2000. Gene ontology: Tool for the unification of biology. The Gene Ontology Consortium. *Nature Genetics* 25 (1): 25–29.
86. Diehl, A. D., J. A. Lee, R. H. Scheuermann, and J. A. Blake. 2007. Ontology development for biological systems: Immunology. *Bioinformatics* 23 (7): 913–15.
87. Gkoutos, G. V., E. C. Green, A. M. Mallon, J. M. Hancock, and D. Davidson. 2004. Building mouse phenotype ontologies. *Pacific Symposium on Biocomputing*: 178–89.
88. Yu, A. C. 2006. Methods in biomedical ontology. *Journal Biomedical Informatics* 39 (3): 252–66.
89. Noy, N. F., and D. L. McGuinness. 2001. *Ontology development 101: A guide to creating your first ontology*. Technical Report KSL-01-05. Palo Alto, CA: Stanford Univ., Stanford Knowledge Systems Laboratory. <http://www-ksl.stanford.edu/people/dlm/papers/ontology-tutorial-noy-mcguinness.pdf>.
90. Gruninger, M., and M. S. Fox. 1995. Workshop on basic ontological issues in knowledge sharing: Methodology for the design and evaluation of ontologies. In *1995 International Joint Conference on Artificial Intelligence*, ed. D. Skuce, 6.1–6.10. San Francisco: Morgan Kaufman.
91. OBO Foundry. 2008. The open biomedical ontologies. <http://www.obofoundry.org> (accessed December 19, 2008).
92. Distelhorst, G., V. Srivastava, C. Rosse, and J. F. Brinkley. 2003. A prototype natural language interface to a large complex knowledge base, the Foundational Model of Anatomy. *AMIA Annual Symposium Proceedings*: 200–204.
93. *Nucleic Acids Research*. 2006. The Gene Ontology (GO) project in 2006. *Nucleic Acids Research* 34 (Database issue): D322–6.
94. Kushida, T., T. Takagi, and K. I. Fukuda. 2006. Event ontology: A pathway-centric ontology for biological processes. *Pacific Symposium on Biocomputing*: 152–63.
95. Eilbeck, K., S. E. Lewis, C. J. Mungall, M. Yandell, L. Stein, R. Durbin, and M. Ashburner. 2005. The Sequence Ontology: A tool for the unification of genome annotations. *Genome Biology* 6 (5): R44.

96. W3C. 2008. OWL web ontology language. <http://www.w3.org/TR/owl-features> (accessed December 19, 2008).
97. Berkeley Bioinformatics and Ontologies Project. 2008. The OBO ontology editor. <http://oboedit.org> (accessed December 19, 2008).
98. Noy, N. F., M. Crubezy, R. W. Fergerson, H. Knublauch, S. W. Tu, J. Vendetti, and M. A. Musen. 2003. Protege-2000: An open-source ontology-development and knowledge-acquisition environment. *AMIA Annual Symposium Proceedings*: 953.
99. Luciano, J. S. 2005. PAX of mind for pathway researchers. *Drug Discovery Today* 10 (13): 937–42.
100. Karp, P. D., C. A. Ouzounis, C. Moore-Kochlacs, L. Goldovsky, P. Kaipa, D. Ahren, S. Tsoka, N. Darzentas, V. Kunin, and N. Lopez-Bigas. 2005. Expansion of the BioCyc collection of pathway/genome databases to 160 genomes. *Nucleic Acids Research* 33 (19): 6083–9.
101. Kanehisa, M., S. Goto, M. Hattori, K. F. Aoki-Kinoshita, M. Itoh, S. Kawashima, T. Katayama, M. Araki, and M. Hirakawa. 2006. From genomics to chemical genomics: New developments in KEGG. *Nucleic Acids Research* 34 (Database issue): D354–7.
102. Joshi-Tope, G., M. Gillespie, I. Vastrik, P. D'Eustachio, E. Schmidt, B. de Bono, B. Jassal, et al. 2005. Reactome: A knowledge base of biological pathways. *Nucleic Acids Research* 33 (Database issue): D428–32.
103. Mi, H., N. Guo, A. Kejariwal, and P. D. Thomas. 2007. PANTHER version 6: Protein sequence and function evolution data with expanded representation of biological pathways. *Nucleic Acids Research* 35 (Database issue): D247–52.
104. Hucka, M., A. Finney, H. M. Sauro, H. Bolouri, J. C. Doyle, H. Kitano, A. P. Arkin, et al. 2003. The systems biology markup language (SBML): A medium for representation and exchange of biochemical network models. *Bioinformatics* 19 (4): 524–31.
105. Kitano, H., A. Funahashi, Y. Matsuoka, and K. Oda. 2005. Using process diagrams for the graphical representation of biological networks. *Nature Biotechnology* 23 (8): 961–6.
106. Rubin, D. L., S. E. Lewis, C. J. Mungall, S. Misra, M. Westerfield, M. Ashburner, I. Sim, et al. 2006. National Center for Biomedical Ontology: Advancing biomedicine through structured organization of scientific knowledge. *OMICS* 10 (2): 185–98.
107. SourceForge. 2008. Open source software. <http://sourceforge.net> (accessed December 19, 2008).
108. Benowitz, N. L., G. E. Swan, P. Jacob 3rd, C. N. Lessov-Schlaggar, and R. F. Tyndale. 2006. CYP2A6 genotype and the metabolism and disposition kinetics of nicotine. *Clinical Pharmacology and Therapeutics* 80 (5): 457–67.
109. Dempsey, D., P. Tutka, P. Jacob 3rd, F. Allen, K. Schoedel, R. F. Tyndale, and N. L. Benowitz. 2004. Nicotine metabolite ratio as an index of cytochrome P450 2A6 metabolic activity. *Clinical Pharmacology and Therapeutics* 76 (1): 64–72.
110. Berkeley Drosophila Genome Center. 2008. Phenotype syntax. <http://www.fruitfly.org/~cjm/obd/pheno-syntax.html> (accessed December 19, 2008).
111. Hukkanen, J., P. Jacob 3rd, and N. L. Benowitz. 2005. Metabolism and disposition kinetics of nicotine. *Pharmacological Reviews* 57 (1): 79–115.
112. R Development Core Team. 2003. *The R project for statistical computing*. Vienna, AU: R Foundation for Statistical Computing. <http://www.r-project.org>.
113. Gilks, W. R., S. Richardson, and D. Spiegelhalter, ed. 1996. *Markov chain Monte Carlo in practice*. London: Chapman and Hall.
114. Srivastava, V. K., and D. C. Hill. 1975. Thiocyanate ion formation in rapeseed meals. *Canadian Journal of Biochemistry* 53 (5): 630–33.
115. Oscarson, M., R. A. McLellan, V. Asp, M. Ledesma, M. L. Bernal Ruiz, B. Sinues, A. Rautio, and M. Ingelman-Sundberg. 2002. Characterization of a novel CYP2A7/CYP2A6 hybrid allele (CYP2A6*12) that causes reduced CYP2A6 activity. *Human Mutation* 20 (4): 275–83.
116. Yamano, S., J. Tatsuno, and F. J. Gonzalez. 1990. The CYP2A3 gene product catalyzes coumarin 7-hydroxylation in human liver microsomes. *Biochemistry* 29 (5): 1322–9.
117. Nunoya, K., T. Yokoi, K. Kimura, K. Inoue, T. Kodama, M. Funayama, K. Nagashima, et al. 1998. A new deleted allele in the human cytochrome P450 2A6 (CYP2A6) gene found in individuals showing poor

- metabolic capacity to coumarin and (+)-cis-3,5-dimethyl-2-(3-pyridyl)thiazolidin-4-one hydrochloride (SM-12502). *Pharmacogenetics* 8 (3): 239–49.
118. Wakefield, J. 2007. A Bayesian measure of the probability of false discovery in genetic epidemiology studies. *American Journal of Human Genetics* 81 (2): 208–27.

Part

6

Future Directions

This final part explores future directions for genetic studies of nicotine dependence, taking into account social and environmental influences as well as complex G×E interactions. It presents chapter-specific and cross-cutting recommendations for future research in tobacco genetics.

13

Future Directions

Although a predominant scientific theory exists on how nicotine leads to dependence, further study is needed to explore the relationships between genetic, environmental, and social influences on dependence. This concluding chapter summarizes how tobacco genetics may affect basic and clinical research and provides summaries and recommendations for each part of the monograph and cross-cutting recommendations for the entire volume.

- *Continued research on genetics may enhance the understanding of how nicotine's positive and negative effects lead to smoking relapse and nicotine dependence, the role genetic variation plays in acquiring dependence, and how to develop more effective treatments for nicotine dependence.*
- *The next generation of nicotine-dependence investigators are encouraged to conduct research at varying levels of analysis and approaches to studying genotype-phenotype associations, take into account the environmental context as well as G×E interactions, use a broader range of more homogenous groups of tobacco users, and to clearly communicate their results to lay audiences and the media in ways that will not be used to stigmatize subgroups of the population.*

This research has promise to refine existing nicotine-dependence treatments and identify new ones. Understanding the role of genetic susceptibility to nicotine dependence within the context of what is already working in the field of tobacco control should help to design and implement more effective treatments for nicotine dependence and enhance tobacco prevention and control policies.

Introduction

This chapter begins with comments on how continued research in the area of genetics and nicotine dependence may influence future research at the basic and clinical levels by enhancing our understanding of the involvement of dopaminergic pathways responsible for nicotine dependence, the role of genetic variation in the initial acquisition of nicotine dependence, and the development of more effective treatments for nicotine dependence. The second portion of the chapter provides summaries and recommendations from parts 2–5 of the monograph and concludes with several crosscutting suggestions for the future.

Genetics and Nicotine Dependence: Implications for Basic and Clinical Research

Nicotinic and Dopaminergic Receptors

Tobacco smoke contains more than 5,000 compounds (many of which are of unknown impact with regard to dependence), and nicotine is widely considered to be the most addictive of these.¹ The predominant theory concerning how nicotine leads to dependence posits that acute nicotine binds to nicotinic receptors located on dopaminergic neurons in the ventral tegmental area (VTA) of the substantia nigra. The resultant dopamine release is associated with the experience of pleasure and the enhancement of some cognitive functions, such as sustained attention and vigilance, through neuronal projections from the VTA to the nucleus accumbens, frontal cortex, and striatum. Unfortunately, for the chronic tobacco user, long-term use results in a reduced

function of nicotinic and dopaminergic receptors and more nicotine is required to maintain the same effects on mood and cognition. At the same time, cues in the environment become conditional triggers to smoke. When a regular tobacco user attempts to quit, withdrawal from nicotine is associated with a concurrent upregulation of nicotinic receptors and downregulation of dopaminergic receptors thereby leading to unpleasant symptoms, dysphoria, and in some cases, a wide array of cognitive decrements. The simultaneous avoidance of negative symptoms (negative reinforcement) and the pursuit of the positive effects of nicotine (positive reinforcement) lead to a harmful and recurring cycle of relapse back to smoking.² Because nicotinic and dopaminergic receptors are but two of many pathways (such as glutamatergic, opioid, and serotonergic) implicated in the neurobiology of dependence, the complete picture of reward and dependence is undoubtedly much more complex and likely involves second-messenger systems.

A number of lines of evidence support the dopamine hypothesis of dependence. Various abused drugs, including nicotine, result in measurable and, in some cases, substantial increase in dopamine in terminal dopaminergic fields, particularly the nucleus accumbens.³ Significant changes in regional cerebral blood flow have been observed in the nucleus accumbens, hippocampus, and orbitofrontal cortex of smokers in response to the first cigarette of the day following overnight abstinence.⁴ In individuals with nicotine dependence, cue-induced changes dependent on blood oxygen level in brain regions along major dopaminergic pathways provide further neuroanatomical support to the hypothesis.⁵ Continued advances can be expected in the elucidation and validation of the dopaminergic basis for nicotine dependence as new phenotypic measures, such as those observed with functional

magnetic resonance imaging, are examined in relation to novel genetic variants.

Nicotine Dependence—A Note on Developmental Pathways

In addition to strides made in understanding the basic neurobiological pathways to nicotine dependence, evidence indicates that the neurobiological and social processes by which young people exposed to tobacco products become addicted to nicotine are likely to be different from those responsible for the maintenance of dependence. Because the developing child's brain is dynamic, it is possible that the brains of young people may be more susceptible than those of adults to the addictive properties of nicotine. For example, as the brain matures, the amount of gray matter on the cortical surface of the brain decreases from back to front as synaptic pruning occurs.⁶ It has also been shown that frontal and temporal lobe volumes are smaller in adolescents than in adults.⁷ Evidence from animal models shows that preadolescents, as compared with older adolescents, show increased upregulation of nicotinic receptors (including $\alpha 5$ and $\alpha 6$, and $\beta 2$) and increased nicotine self-administration following preexperimental exposure to nicotine.⁸ This suggests that age-gene-environment interactions may be operating to heighten the risk for entering into a tobacco use trajectory that ultimately leads to chronic tobacco use in adulthood. The use of developmental trajectories to describe how different people become dependent as adults (see chapters 4–6 in this volume) is a new area of research receiving increased attention.^{9,10} In the future, it will be possible to examine genomic differences among trajectory subgroups.

Genomic Studies of Nicotine Dependence in Adults

Early work involving twins suggested that genetic factors may account for more

than 50% of interindividual variation in smoking initiation and nicotine dependence. Subsequent studies have sought to understand how genetic variation may affect the underlying neurobiology of nicotine dependence.⁹ New analytic capacity will permit more powerful efforts to identify genetic variants key to nicotine dependence and its treatment. More than 25 whole-genome linkage scans involving nicotine dependence (and/or related phenotypes, such as number of cigarettes smoked per day and maximum cigarettes ever smoked in a single day) have been reported. A study in 2006¹¹ identified a linkage peak on chromosome 6 for scores from the Fagerström Test for Nicotine Dependence (FTND).¹² Swan and colleagues¹¹ also found suggestive linkage peaks on chromosomes 8 (nicotine dependence related to criteria of the *Diagnostic and Statistical Manual of Mental Disorders*)¹³ and 15 (report of a previous reason for relapse of “enjoyed smoking too much”). All three peaks are near candidate genes of interest in the nicotinic and opioid pathways. Significantly, a genome-wide association study in 2007 of 32,000 single nucleotide polymorphisms (SNPs) in nicotine-dependent cases ($n = 1,050$; FTND score more than 4 when smoking at maximum) and nondependent controls ($n = 879$; smoked at least 100 cigarettes lifetime but had a score of 0 on the FTND) provided evidence that some of the strongest associations were with variants in nicotinic, opioid, and dopamine genes, several of which were close to candidate chromosomal regions.^{14,15} What is apparent from this work is that convergence across studies and methodologies is now being seen.¹⁶ Great progress will continue to be made in identifying specific gene variants that play a role in nicotine dependence.

Figure 13.1 represents a schematic of what the future might hold as the pieces of the puzzle of nicotine dependence are identified, certified, and assembled. On the

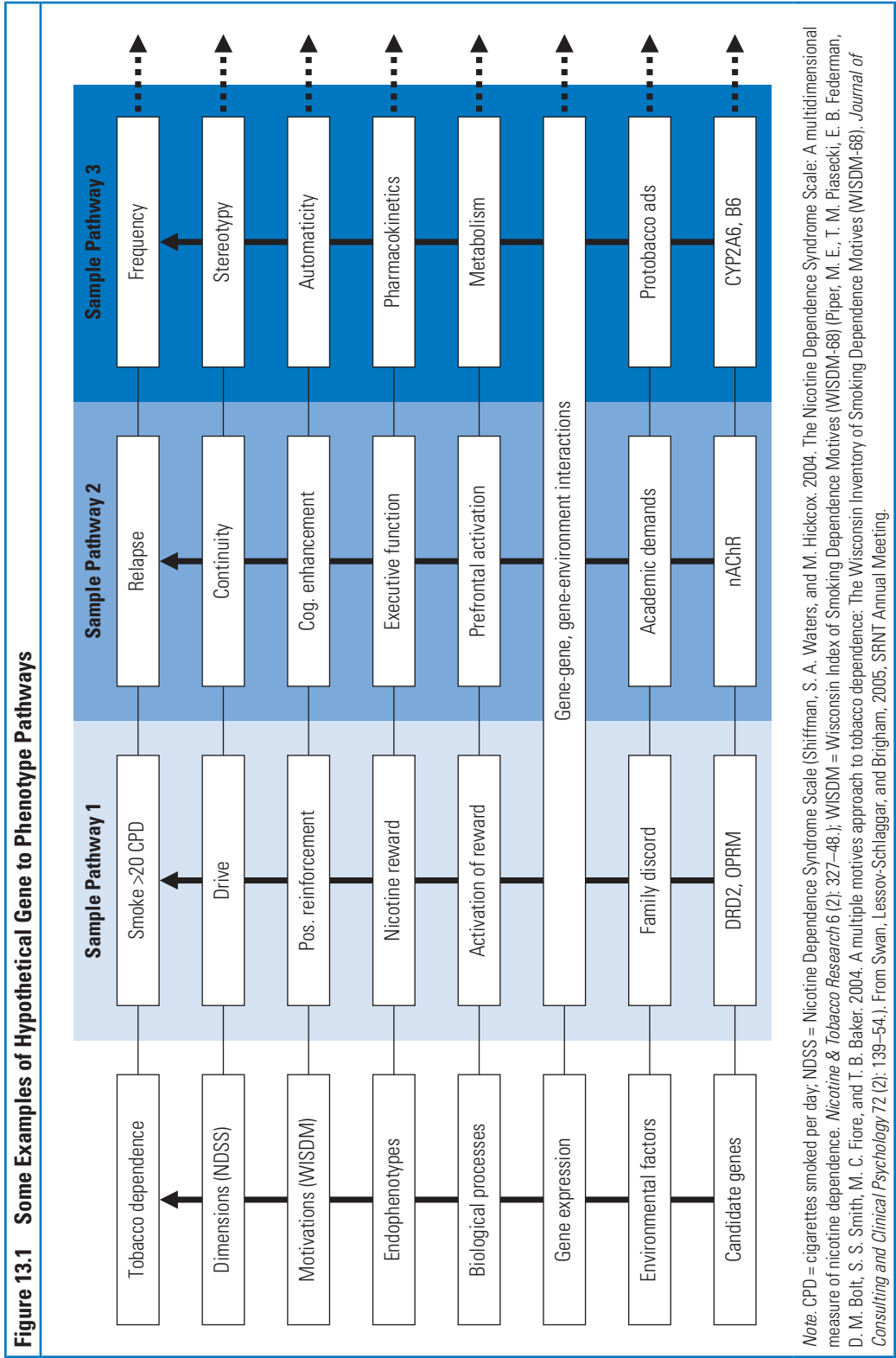

far left of the figure is the arrangement, in ascending order, of components of a pathway that begins with the impact of candidate genes through their expression in response to the environment (e.g., tobacco, tobacco advertising, peer or parental smoking, cigarette design, or other environmental pressures to use or not use tobacco). The result of the gene-environment interaction is to initiate a biological process that can be measured in some fashion (e.g., nicotine metabolism, reward, cognition)—that is, the endophenotype. The biological process, in turn, must contribute in some way to motivate an individual to continue smoking. While the primary motivations to smoke may be different across individuals, they must, in turn, be associated with any or all dimensions of nicotine dependence and, finally, to observable tobacco use behavior.

One of the key features in this progression of events is that every step in the path is potentially measurable. Another feature is the implied association between components of the pathway, testable through a planned series of experimental studies to determine the validity of the pathway. The temporal sequencing of components in the pathway to confirm causality could be investigated through the use of any of a variety of tools. Finally, the arrows extending through the rows of the diagram suggest a progression over time in which any individual, given his or her initial variation across a number of genes and subsequent variation across environments, could come to exhibit behavioral variation in a number of indices of nicotine dependence, including tobacco use trajectories.

Figure 13.1 provides three hypothetical pathways, each of which could be examined empirically. To illustrate, the first example begins with variation in genes involved in the reward pathway that are activated

through interaction with an environment that provides few reinforcers. Individuals with this confluence of initial conditions would be expected to experience heightened reward from nicotine and acquire the need for sustained positive reinforcement—a motivation to continue to smoke. The need for sustained reinforcement would result in an increased drive to smoke and an increase in number of cigarettes smoked per day. The remaining two pathways, initiated through interaction between variation in the nicotinic receptors or metabolic genes, can be viewed as leading, ultimately, to different components of nicotine dependence. Investigators of the future should use this schematic, or one like it, to place their efforts in a theoretical context that permits empirical tests of hypothesized connections in a nicotine dependence pathway (see chapter 3 for another formulation of potential pathways and chapter 12 for an analytic approach for studying pathways). Such an approach will help others make sense of the plethora of results likely to continue to emerge over the coming years.

Future Directions

This part summarizes the discussions of the research presented in the monograph (parts 2 through 5) and suggests future research agenda items.

Part 2—Theoretical Considerations

Research presented in part 2 from investigators who examined both competing and distinct models of dependence demonstrated that nicotine dependence is multidimensional and that numerous theories on its development are available.

Guided by their own hypotheses about the nature, manifestation, and development of dependence, investigators recommended

that incorporating a more comprehensive portrayal of dependence development may help find the link between genes and behavior for genetic dependence susceptibility.

Part 2 of this monograph also examined issues surrounding the complex genetic and behavioral measures that combine and contribute to nicotine dependence gleaned through studies of inbred mouse strains. Available evidence used to translate the validity of the mouse findings to humans holds promise in coming to understand individualized responses to nicotine.

Additional areas recommended for future research include the following:

- Phenotypic assessments are needed that reflect the different stages in progression to dependence (intermediate and transitional phenotypes) (chapter 3).
- Future research should address the extent to which the different types of tolerance (e.g., acute or chronic, behavioral or dispositional) are related to core features of dependence, such as a pervasive pattern of drug use. Further understanding of the neural and genetic substrata of tolerance, and how these compare with other causal influences on dependence, may elucidate the role of tolerance in dependence development (chapter 4).
- Given the tremendous potential created by the availability of well-characterized mouse strains and both knockout and knockin preparations, the use of such tools is needed to explore genetic influences on phenotypes that provide additional insight into the processes involved in nicotine dependence. Additional assays, both physiological and behavioral, should be used to expand understanding of the genetic contributors to the critical motivational processes of dependence (chapter 4).

Part 3—Developmental Trajectories of Tobacco Use and Their Relation to Tobacco Dependence

Over time, the paths that smoking behavior take vary widely. These patterns of development are an important basis for genetic studies of nicotine dependence. This third part of the monograph focused on issues related to studying these trajectories.

One chapter focused on the development of smoking patterns from adolescence (when smoking and other substance use are most commonly initiated) to adulthood. Data collected from related individuals were used to examine the association between smoking initiation and progression in an effort to understand the etiology of nicotine dependence. Genetic data indicating the existence of an overlapping developmental pathway between smoking and other substance use in identical and fraternal twins were also examined.

Suggested topics for continued study include the following:

- Future research should link hypothesized preexposure endophenotypes to trajectories that might constitute dynamic phenotypes of cigarette smoking. These studies should also consider other forms of tobacco use (chapter 5).
- Better specification is needed of the relation between trajectories of smoking behavior and the development of nicotine dependence, as well as the relation between adolescent and adult trajectories. Moreover, further research (using animal and human models) is required to understand the mechanisms underlying age-specific effects of initial nicotine exposure, which have shown a significant relation between an early age of onset and steeper acceleration over time (chapter 5).

- It is important to determine whether a particular individual feature of a trajectory (e.g., age of onset or steepness of acceleration) is the important phenotype or whether it is more useful to consider an entire trajectory group. Moreover, different research approaches are needed to determine whether phenotypes are best considered as categorical “groups” or as representations of an underlying continuous dimension. Future research will help determine if there are important ethnic differences in these groups (chapter 5).
- Efforts should be made to develop reliable and valid methods to retrospectively reconstruct trajectories in addition to pursuing a range of longitudinal study designs (chapter 5).
- Future development and applications of genetic latent growth curve models and genetic latent class models promise to improve the understanding of the role of genes and environment in smoking trajectories and transitions from nonsmoker to smoking dependence (chapter 6).
- Future genetic research should jointly examine the extent to which different trajectories (combinations, of course) and the use of multiple substances (comorbidity) are genetically influenced. If it can be shown that phenotypes represented by broader substance-use trajectories are equally or more heritable than are single-substance trajectories, both phenotypic and genetic work can proceed more efficiently. Findings would have implications for whether researchers should take a more genetic approach in preventing and treating substance-use disorders (chapter 7).

Part 4—Endophenotypes

Characteristics present at or before exposure to nicotine may help to identify individuals

genetically susceptible to nicotine dependence. Similarly, measures in smoking persistence may help predict the success of cessation attempts among chronic smokers.

Part 4 of the monograph focused on data indicating that genetic risk for nicotine dependence may also be affected by the presence of several psychological factors, such as approach-, avoidance-, and control-related smoking risk variables, at or prior to smoking and nicotine exposure. Chronic smokers were also a focus. Data presented indicate that the path to persistent smoking should include not only measurement of genetic factors but also motivational, sensory, cognitive function, craving, and other behavioral elements.

Additional areas recommended for future research include the following:

- Higher-order trait domains (approach, avoidance, control, and affiliation/empathy) all have some promise in relation to smoking risk. However, these traits are best understood in relation to lower-level neural systems, which, in turn, point to more molecular cognitive or physiological measures that can be examined as endophenotypes. More research is needed to evaluate a range of context-sensitive physiological measures as candidates of these lower systems (chapter 8).
- There is great potential for future research to provide the evidence for or against the criteria important for endophenotype measures of nicotine dependence and to inform the debate about the utility of endophenotypes in genetic research (chapter 9).
- Differences in quitting motivation between laboratory research participants and smokers in clinical studies may affect the development and validation of brief laboratory-based behavioral procedures that may serve as endophenotypes.

Future endophenotypic research should take these motivational differences into consideration (chapter 9).

Part 5—Epidemiological and Methodological Considerations

In part 5 of the monograph, methodological and epidemiological issues related to the future direction of genetic studies on nicotine dependence are discussed. An epidemiological approach for modeling smoking phenotypes, models that incorporate social context factors, and hierarchical modeling techniques were presented.

Using an epidemiologic approach to defining smoking phenotypes, three analyses were presented that demonstrated that using more tightly defined comparison groups would yield more consistent findings about the role of genetics in smoking behavior. Other analyses that incorporated social context into genetic studies of nicotine dependence indicated that genetic susceptibility to smoking may be influenced by the social context and environment—such as having peers, parents, and siblings who smoke. How the genetic variation affects the analysis and interpretation of the role of genetics in tobacco use closes out this part of the monograph.

Results from a pilot study using hierarchical modeling techniques demonstrated that formally incorporating different phenotypes and genotypes into the statistical analysis may help to lessen some of the difficulties experienced in evaluating the numerous factors affecting nicotine metabolism.

Research agenda items for future consideration include:

- Researchers should be encouraged to use more tightly defined phenotypes of smoking behavior that are based on transitions on the smoking trajectory and adequate prior exposure, as these have the potential to reduce misclassification bias and the lack of specificity inherent in broader existing phenotypes such as current smoking status (chapter 10).
- There may be etiological heterogeneity in the mix of genes and environments that can be captured only by incorporating candidate social contextual measures in genetically informative designs. To understand the mechanisms underlying such etiological heterogeneity, researchers should be encouraged to examine a broad number of both macro- and microsocial factors (i.e., conduct a “whole environment” scan) (chapter 11).
- Evaluating sources of etiological heterogeneity may help in understanding the mechanisms by which endophenotypes become salient for smoking behaviors under specific environmental conditions but not others. Therefore, future research should use advanced measurement of both endophenotypes and social contexts to potentially illuminate core environmental factors that dwarf individual-level propensities as well as highlight especially prominent endophenotypes that convey risk under particular environmental conditions (chapter 11).
- It is becoming increasingly untenable to ignore social contextual factors without sacrificing a broader and more comprehensive understanding of the etiological architecture of complex phenotypes such as nicotine dependence. Therefore, if the field is to take seriously the proposition that gene-environment interplay will play a key role in eventually understanding the mechanisms by which genes contribute to smoking behavior and nicotine dependence, a dedicated effort will be needed not only to incorporate environmental measures with more regularity and vigor but also to invest the time, resources,

and collaborative expertise necessary to provide the best available data on the environment (chapter 11).

- Since complex traits are the results of many factors acting in concert, statistical analysis needs to be rich enough to identify sets of factors acting synergistically. One approach is to use ontologies in hierarchical modeling in conjunction with stochastic variable selection for future genetic analyses of tobacco use.

Crosscutting Issues for Future Research in Nicotine Dependence

In developing this monograph and examining continuing developments in the field, the editors identified several higher level recommendations for future research in nicotine dependence that cut across the content of this volume.

- A comprehensive approach to examining and reporting genotype-phenotype associations should be adopted; single-gene, single-variant association studies should be discouraged unless accompanied by reports of replication and validation.
- Researchers working in the field of genetics and nicotine dependence should be mindful of the potential for misinterpretation of results by lay audiences. Efforts to communicate results to the media should include the limitations of the work along with the extent to which the results are reliable and generalizable. Doing so will minimize the chances of stigmatizing subgroups in the population.
- An ontology-based approach to nicotine dependence, with specification of expected relations within and between phenotypic domains, will provide an interpretive context and more focused hypotheses for future research; this will lead to an ongoing refinement of the ontology as new information becomes available.
- A greater use of strategies that combine differing levels of analysis is needed. The incorporation of measured genetics into genetic latent growth curve and/or latent class models in extended twin designs, for example, will provide information on the extent to which variation in one or more genes plays a role in the overall estimate of genetic variation in any particular phenotype. In addition, a nicotine reward phenotype may be characterized via behavioral measures of self-administration, self-report assays, and imaging measures of activity in brain regions associated with reward processing. This, in turn, could spur the hunt for more genetic variants and gene-gene or gene-environment interactions to account for more of the overall genetic variation estimated in the biometric models. Inclusion of quantified life events, cultural factors, and extant clinical and public health efforts in tobacco control and prevention in genetic studies is also warranted.
- Genome-wide association analysis of phenotypes considered to be risk factors for the adoption or maintenance of nicotine dependence would lead to further understanding of the pathways by which children progress to adult nicotine dependence.
- Given the enormous social, health, and economic impacts of nicotine dependence, the coordinated effort of multiple research teams to address the many opportunities for further research identified in this volume is warranted.
- There is a need to examine the association between gene variants and phenotypes of relevance in both the presence and absence of environmental risk factors. Emerging evidence from longitudinal

studies of adolescents suggests that genetic associations with indices of nicotine dependence may be stronger and more robust when acting in the absence of environmental pressure to not use tobacco. Another way in which gene-environment interactions may influence nicotine dependence is during and/or following attempts to quit the use of nicotine-containing products. For example, variation in genes responsible for drug metabolism could interact with the dosing or duration of pharmacotherapy for nicotine dependence to reduce drug efficacy. A third possibility for further exploration of gene-environment interactions involves the period following smoking cessation. The relationship between genetic variation and the likelihood of relapse back to nicotine dependence could well be dependent on the presence of conditioned cues to smoke or environmental stress.

- Epigenetic methodologies promise to further understanding of the impact of the environment on the differential expression of gene variants. One possible approach, described in chapter 2, involves the comparison, at the genomic and/or expression level, of lymphoblastoid cell lines from identical twins discordant for nicotine dependence or other characteristics such as nicotine metabolism. Informative measures of environmental exposures will enhance the power of this approach to account for monozygotic twin discordance.
- Much of the tobacco literature examines genetic susceptibility to smoking initiation and cessation only among very broad groups, without an understanding of the complexities or variations within these categories in patterns of smoking behavior. Combining very different subgroups of smokers into a few common phenotypes and then using such heterogeneous groups in research studies may be hindering progress in understanding the role of genetics in complex behaviors such as smoking. Moreover, standard definitions of smoking behavior from epidemiological surveys are not commonly used, making it difficult to compare results among genetics studies and to put these results into the context of knowledge gained from other disciplines. Therefore, researchers should be encouraged to use existing standardized definitions and measures of tobacco use behavior and to examine the role of genetics and environment in a greater number and broader range of more homogeneous groups of tobacco users.
- Epidemiologists and surveillance researchers should be encouraged to contribute more to the conceptualization, identification, definition, and operationalization of potential phenotypes of tobacco use behavior and then to demonstrate the utility, reliability, and validity of these potential phenotypes by using data from representative national surveys.

References

1. Fowles, J., and E. Dybing. 2003. Application of toxicological risk assessment principles to the chemical constituents of cigarette smoke. *Tobacco Control* 12 (4): 424–30.
2. Koob, G. F., and M. Le Moal. 1997. Drug abuse: Hedonic homeostatic dysregulation. *Science* 278 (5335): 52–58.
3. Di Chiara, G., and A. Imperato. 1988. Drugs abused by humans preferentially increase synaptic dopamine concentrations in the mesolimbic system of freely moving rats. *Proceedings of the National Academy of Sciences of the United States of America* 85 (14): 5274–78.
4. Zubieta, J. K., M. M. Heitzeg, Y. Xu, R. A. Koeppe, L. Ni, S. Guthrie, and E. F. Domino. 2005. Regional cerebral blood flow responses to smoking in tobacco smokers after overnight abstinence. *American Journal of Psychiatry* 162 (3): 567–77.
5. Smolka, M. N., M. Buhler, S. Klein, U. Zimmermann, K. Mann, A. Heinz, and D. F. Braus. 2006. Severity of nicotine dependence modulates cue-induced brain activity in regions involved in motor preparation and imagery. *Psychopharmacology (Berl)* 184 (3–4): 577–88.
6. Gogtay, N., J. N. Giedd, L. Lusk, K. M. Hayashi, D. Greenstein, A. C. Vaituzis, T. F. Nugent 3rd, et al. 2004. Dynamic mapping of human cortical development during childhood through early adulthood. *Proceedings of the National Academy of Sciences of the United States of America* 101 (21): 8174–79.
7. Sowell, E. R., P. M. Thompson, C. J. Holmes, T. L. Jernigan, and A. W. Toga. 1999. In vivo evidence for post-adolescent brain maturation in frontal and striatal regions. *Nature Neuroscience* 2 (10): 859–61.
8. Adriani, W., S. Spijker, V. Deroche-Gamonet, G. Laviola, M. Le Moal, A. B. Smit, and P. V. Piazza. 2003. Evidence for enhanced neurobehavioral vulnerability to nicotine during periadolescence in rats. *Journal of Neuroscience* 23 (11): 4712–16.
9. Lessov-Schlaggar, C. N., M. L. Pergadia, T. V. Khroyan, and G. E. Swan. 2008. Genetics of nicotine dependence and pharmacotherapy. *Biochemical Pharmacology* 75 (1): 178–95.
10. Karp, I., J. O’Loughlin, G. Paradis, J. Hanley, and J. DiFranza. 2005. Smoking trajectories of adolescent novice smokers in a longitudinal study of tobacco use. *Annals of Epidemiology* 15 (6): 445–52.
11. Swan, G. E., H. Hops, K. C. Wilhelmson, C. N. Lessov-Schlaggar, L. S. Cheng, K. S. Hudmon, C. I. Amos, et al. 2006. A genome-wide screen for nicotine dependence susceptibility loci. *American Journal of Medical Genetics Part B, Neuropsychiatric Genetics* 141 (4): 354–60.
12. Heatherton, T. F., L. T. Kozlowski, R. C. Frecker, and K. O. Fagerström. 1991. The Fagerström Test for Nicotine Dependence: A revision of the Fagerström Tolerance Questionnaire. *British Journal of Addiction* 86 (9): 1119–27.
13. American Psychiatric Association. 2000. *Diagnostic and statistical manual of mental disorders: DSM-IV-R*. 4th ed. text rev. Arlington, VA: American Psychiatric Publishing.
14. Bierut, L. J., P. A. Madden, N. Breslau, E. O. Johnson, D. Hatsukami, O. F. Pomerleau, G. E. Swan, et al. 2007. Novel genes identified in a high-density genome wide association study for nicotine dependence. *Human Molecular Genetics* 16 (1): 24–35.
15. Saccone, S. F., A. L. Hinrichs, N. L. Saccone, G. A. Chase, K. Konvicka, P. A. Madden, N. Breslau, et al. 2007. Cholinergic nicotinic receptor genes implicated in a nicotine dependence association study targeting 348 candidate genes with 3713 SNPs. *Human Molecular Genetics* 16 (1): 36–49.
16. Uhl, G. R., T. Drgon, C. Johnson, O. O. Fatusin, Q. R. Liu, C. Contoreggi, C. Y. Li, K. Buck, and J. Crabbe. 2008. “Higher order” addiction molecular genetics: Convergent data from genome-wide association in humans and mice. *Biochemical Pharmacology* 75 (1): 98–111.

Index

A

- $\alpha 4\beta 2$ nAChRs, 166, 168
- $\alpha 7$ nAChR receptors, 168
- $\alpha 7$ nAChR subunit knockout mice, 159
- abstainers (nonsmokers)
 - characteristics of, 22
 - inclusion *versus* exclusion of, 222–223, 235, 323
 - nicotine patches, 377
- abstinence
 - in behavioral economics effects, 420
 - deficits, 350–351
 - effects of, 405, 408
 - event-related potential, 429
- abstinence-induced craving, 438
 - effects of, 405
 - measurements, 403
 - during smoking cessation, 441
- α -bungarotoxin binding, 165, 167
- ACE model, 249–250
- acetaldehyde (alcohol studies), 86–87
- acoustic startle reflex. *See* startle response
- active avoidance, 435
- acute stress mimicry of withdrawal symptoms, 448
- acute tolerance, 162–163
- ADA (Americans with Disabilities Act), 49
- Add Health (National Longitudinal Study of Adolescent Health), 197–198, 261, 517
- addiction. *See also* nicotine dependence;
substance use
 - clinical manifestations of, 79
 - as dependence, 77
 - DRD2* gene and, 32
 - versus* habituation, 24
 - models of, 293
 - versus* smoking, 24
 - stress and, 36
- additive components, 511
- adenosine knockout mice, 159
- adenosine systems, in nicotine reinforcement,
159–160
- ADHI*2* alleles (alcohol studies), 86–87
- ADHD. *See* attention deficit hyperactivity disorder
- adipose tissue, nicotine concentrations in, 145
- ad libitum (ad lib) self-administration, 415–416,
419
- administration, 145–149, 418. *See also* self-
administration
 - in drinking water, 148, 172
 - intravenous, 146, 156, 410
 - oral, 148, 154, 412
- adolescent(s)
 - alcohol use by, 516
 - cognitive control, 358, 380
 - delay discounting choices, 350
 - depression in, 351–352
 - event-related potential, 429
 - extraversion in, 349
 - first mood effects, 375–376
 - neuroticism in, 351, 352
 - nicotine deprivation learning deficits, 436
 - nicotine response in, 194–195
 - novelty seeking behavior, 27, 348
 - P300 amplitude in, 360
 - physiological changes in, 589
 - protective factors, 343
 - research limitations, 367
 - social influences on, 346–347, 517
 - substance-use vulnerability of, 195, 199, 200–
201, 212, 233–234, 261, 292–293
 - transition to adulthood, 195
 - use of genetic information by, 46–47
- adolescent developmental trajectories, 189–235,
592
 - age of smoking onset, 200–201
 - empirically identified, 202–214
 - example of, 223–233
 - future research directions, 233–234
 - psychopathology, 191–202, 292–293
 - statistical models, 214–223
 - substance use, 295–296 (*See also* substance-
use comorbidity; *specific substance*)
- adolescent nicotine dependence, 191–195
 - animal models of, 155, 194–195
 - biological vulnerability for, 100, 193–195,
200–201, 233
 - future research directions, 233
 - genetic studies of, 86, 264–266, 342
 - individual symptoms of, 192
 - measurement of, 192, 230–231, 264
 - time and exposure required for, 192–193
 - withdrawal symptoms, 192
- adolescent smoking, 371
 - antisocial behavior and, 200, 202, 211, 232
 - environmental influences on, 196–197
 - ethnic differences in, 213–214, 279

- gender differences in, 196, 199, 260, 263–264, 342
 - gene-environment interactions in, 197–200, 259
 - genetic research on, 195–200, 259–269
 - heterogeneity in, 190, 233
 - as indicator of adult nicotine dependence, 230–231
 - latency between cigarettes, 371
 - molecular genetic studies of, 198–199
 - parental smoking and, 196–197, 200
 - peer smoking and, 197
 - prevalence of, 191
 - twin studies of, 196, 259–262
- adolescent smoking initiation, 191
- age range in, 261–262
 - heterogeneity of, 196, 201–202, 233
 - progression to dependence, 341
 - genetic studies of, 263–264
 - rate of acceleration, 201–202
 - psychosocial factors, 200, 202, 211
 - risk profile, 211–212, 232
 - shared environmental factors in, 260–261, 264, 280
- adoption studies, 196, 279
- ADRA1A* gene, 42
- adulthood, transition to, 195
- adult nicotine dependence, adolescent smoking indicators of, 230–231
- adult-onset events, 100
- adult smoking phenotype, limitations of, 190
- advertising
 - costs of, 21
 - in movies, 7, 20, 523
 - novelty seeking as response to, 348
 - protobacco, 7, 20, 30, 348
 - smoking index variable and, 30
- aerosols, nicotine, 147
- affective coping, 112–113
- affective response, 373–376
 - future research directions, 456
 - physiological measures of, 377–378, 445–446
 - regulation of, 358, 403, 443–449
- affiliation/empathy system, 362
- African Americans
 - adolescent smoking in, 213–214
 - genotypes linked to dependence, 47
 - linkage study focused on, 267
- age effects, 170–171
 - factor loadings by, 271–276
 - in smoking initiation assessment, 261–262, 279, 281, 322
 - in substance-use comorbidity, 322–323
- age-gene-environment interactions, 589
- age of onset, 26, 100, 371–372
 - developmental trajectories by, 200–201
- age-related macular degeneration, 46
- age-specific risk, measurement of, 35
- aggregate effects in complex pathways, 541
- aggression, 357
- agonists (activators), 143
- AHe mice, 435
- AIC (Akaike Information Criterion), 274, 312
- A inbred mice, 154, 165, 412, 422
- A/J mice, 435
- A/J×NMRI cross-bred mice, 154, 412
- Akaike Information Criterion (AIC), 274, 312
- alcohol use
 - adolescent, 516
 - in ATBC analysis, 496
 - Edwards's theory of, 82–83
 - Iowa gambling task as predictor, 350
 - nasal spray use correlated with, 373
 - in NHANES III analysis, 502
 - policies influencing, 294–295
 - as secondary reinforcement, 413
 - side effects, 86–87
 - tobacco use concurrent with, 98, 290, 296–298
 - empirical examples of, 307–323, 496, 502
 - health effects of, 290
 - modeling, 299–305
 - nicotine-dependence correlation, 369, 406, 411–412, 420
 - trajectories of, 295
- ALDH2**2 alleles (alcohol studies), 86–87
- alertness, 361–362
- allele(s)
 - identical by descent (IBD), 257, 258
 - variants of, 554
- allele frequency, 48, 258
- alpha subunits, 153
- Alpha-Tocopherol, Beta-Carotene Cancer Prevention Study (ATBC), 487, 494–497
- alternative reinforcement, 417
- Americans with Disabilities Act (ADA), 49
- amphetamine, 412
- analysis of variance (ANOVA), 215
- analytic methods. *See also specific method*
 - developmental trajectories, 214–223
 - molecular genetic studies, 257–259
 - phenotypic research, 96–103, 113–118

- anger, palliative effects on, 357
 animal studies. *See also* mouse models; rat models; *specific strain or study*
 ad lib administration in, 415
 adolescent nicotine exposure, 194–195, 589
 affective regulation, 443
 dependence, 134–135
 fetal nicotine exposure, 357
 impulsivity research in, 449–450
 reward studies, 372–373
 transfer to, 350
 ANOVA (analysis of variance), 215
 antagonists (inhibitors)
 CB1 receptors, 160
 for mu opioid receptors, 160
 muscarinic receptors, 141
 nicotine as, 143
 for nicotine dependence, 159
 anti-inflammatory effects of nicotine, 148–149
 antinociception, 162
 antisaccade task, 359
 antisocial behavior
 adolescent smoking and, 200, 202, 211, 232
 substance use and, 292–293, 304
 antitobacco stimuli, 20
 anxiety
 adolescent smoking and, 201
 nicotine linkage with, 352–353, 445
 anxiogenic effects of nicotine, 168
 apolipoprotein E testing, 48
 approach, *versus* impulsivity, 378–379
 approach-related risk, 339, 346–349, 362
 arousal, 378
ASN40ASP polymorphism, 407
 aspartame, 412
 association analysis, 258–259, 268–269, 280
 assortative mating, 251, 259, 280
 ATBC (Alpha-Tocopherol, Beta-Carotene Cancer Prevention Study), 487, 494–497
 ATR (Australian Twin Registry), 197, 260–261, 267
 attention, 361, 378, 432–434
 attentional bias, 440, 456
 attention deficit hyperactivity disorder (ADHD), 354–357
 adolescent smoking and, 201, 211
 as risk factor, 350, 433
 substance use and, 292–293, 304
 attrition biases, 224
 Australian Twin Registry (ATR), 197, 260–261, 267
 Automaticity subscale, 90–91
 aversive mood symptoms, 443
 avoidance-related risk, 339, 351–354, 362
- B**
- backcrossed mice, 151
 bacterial contamination, during administration, 145
 BALB/cBy mice, 164–165, 430–431, 435
 Barratt Impulsivity Scale, 450
 Bayes factors, 552, 570
 Bayesian analysis, 548–549, 570, 572
 Bayesian False Discovery Probability (BFDP), 573
 Bayesian Information Criterion (BIC), 310, 312
 Bayesian model averaging, 117
 Bayes model, 543
 BAY K 8644, 167
 behavior
 analysis of, 163–164
 antisocial
 adolescent smoking and, 200, 202, 211, 232
 substance use and, 292–293, 304
 drug-motivated, 404
 measurements of, 103
 nicotine and, 151–157
 phenotypes, 171
 response systems, 362
 smoking indices, 80
 substance-use comorbidity and, 322
 tolerance, 168
 traits, 344
 undercontrol, 98–99
 behavioral economics, 417, 420, 454
 behavioral genetics
 phenotypes in, 492
 of self-administration, 153–155
 in social context, 514–518
 behavioral modeling
 methodological issues with, 247–248
 of parental smoking, 246
 BFDP (Bayesian False Discovery Probability), 573
 BIC (Bayesian Information Criterion), 310, 312
 bioavailability of nicotine, 7, 20
 biochemical indices of smoking, 80, 415
 biochemical measures of self-administration, 97
 biochemical pathways, 561
 BioCyc, 561
 biological pathways, candidate, 105
 biological plausibility
 affective regulation, 443–445

- attention/vigilance, 432–433
 - craving, 438–439
 - event-related potential, 427–428, 429
 - impulsivity, 449–450
 - mood effects, 374
 - reinforcement, 368–369, 410–414
 - resting EEG activity, 425–426
 - rewards, 372–373, 421–423
 - startle response, 430–431
 - working memory, 434–436
 - biological vulnerability, in adolescent nicotine dependence, 194–195
 - biomedical ontologies, 561
 - biometric factor model, 253
 - biometric modeling, 37–45, 86, 88–89, 514
 - BioPAX Ontology, 561
 - bitter taste, 84, 148
 - BKW mice, 443
 - blood pressure, 448–449
 - β 2 nAChRs, 153
 - β 2 nAChR subunit knockout mice, 159, 166
 - Bonferroni correction, 546, 573
 - brain
 - nicotine concentrations in, 145
 - stimulation, 373
 - upregulation in, 144
 - of young people, 589
 - brain imaging, 360
 - breakpoint
 - drug use, 418
 - nicotine use, 420
 - preferring to wait, 350
 - breast milk, nicotine concentrations in, 145
 - breeding
 - mice, 150–151, 411
 - rats, 411
 - Brown University Transdisciplinary Tobacco Use Research Center (TTURC), 89, 521, 526
 - BUB/Bn mice, 165, 412
 - BUB inbred mice, 154
 - buzz, 374
- C**
- calcium, 136, 139–140
 - calcium calmodulin protein kinase II, 168
 - calcium channel blockers, 162, 167, 168
 - calcium signaling, 167–168
 - Canadian National Longitudinal Survey of Children and Youth, 212
 - cancer genetics, 50
 - candidate biological pathways, 105
 - candidate gene studies, 40–45
 - adolescent smoking, 342
 - discordant phenotype associations, 36
 - epigenetic differences, 37
 - linkage analysis, 32, 40–42, 267–268, 280–281, 589
 - multivariant data, 543–546
 - nicotine dependence, 42
 - prior knowledge of, 559
 - smoking association with, 24
 - SNP relationships over, 545
 - substance-use comorbidity, 325
 - trait pathways, 553
 - variants, 25, 35
 - candidate neural systems, 343–346
 - cannabis. *See* marijuana use
 - Card Arranging Reward Responsivity Objective Test, 350–351
 - CART (cocaine- and amphetamine-regulated transcript), 36
 - cases, in association analysis, 258
 - catechol-*O*-methyl transferase (*COMT*) gene, 269, 408–409, 430
 - categorical covariates, 276–278
 - causal contingent common (CCC) pathway model, 253, 263, 278–279
 - causal differences between groups, 492
 - causal paths
 - phenotypic research, 102, 107–110
 - sensitivity to, 105
 - smoking as, 352
 - types of, 111–113
 - CBA mice, 435
 - CB1 knockout mice, 160, 422
 - C57BL/6 inbred mice
 - conditioned place preference in, 159, 422
 - dose-dependent effects, 165
 - fear conditioning in, 169, 432
 - five choice serial reaction time task in, 433
 - nicotine consumption, 155, 159
 - nicotine-dependence risk, 161
 - nicotine effects in, 435
 - novelty-seeking behavior in, 156
 - oral self-administration in, 412–413
 - prepulse inhibition in, 430–431
 - strain comparisons, 153–154, 164–165
 - in tolerance, 167
 - C57BL/10 mice, 435

- C57BR/cd mice, 435
 CCC (causal contingent common) pathway model, 253, 263, 278–279
 CCK gene, 269
 CD-1 mice, 443
 CellDesigner, 561
 cell signaling, 161, 167–168
 Center for Antisocial Drug Dependence, 260
 Centers for Disease Control and Prevention, 498
 central nervous system (CNS), 344, 348, 353, 354
 centroid. *See* mean
 chain smoking, 37
 children
 - effortful control in, 358
 - secondhand smoke from parental smoking, 246
 - self-control in, 344
 - sleep problems in, 357
 - smoking by, 371
 children of twins (COT) design, 251–252, 279, 511
 C3H inbred mice
 - dose-dependence, 165
 - nicotine effects in, 431, 435
 - oral self-administration, 412
 - strain comparisons, 154, 164–165
 - tolerance in, 162
 chippers (light smokers)
 - adolescent, 213, 232
 - delay discounting, 350
 - genetic factors and, 29
 - versus* heavy smokers, 43, 81, 83–84, 90, 94
 - prevalence of, 193
 choice procedure, 369–370, 416, 419–420
 cholecystokinin (*CCK*) gene, 269
 Christchurch, New Zealand (CNZ) study, 266
CHRNA2 gene, 42, 376–377
CHRNA3 gene, 376–377
CHRNA4 gene, 268, 407–409, 412
CHRNA5 gene, 342, 376–377
CHRNA7 gene, 408, 409, 428
CHRNA5-A3-B4 haplotypes, 100, 407
CHRNA5-CHRNA3-CHRNA4 nicotinic receptor genes, 43
CHRNA2 gene, 268, 407, 408, 409
CHRNA3 gene, 342
CHRNA3-CHRNA6 nicotinic receptor locus, 43
 chronic exposure, 405, 449
 chronic smoker endophenotypes, 403, 404–406
 - affective regulation, 443–449
 - cognitive control, 432–438
 - craving, 438–443
 - electrophysiological measures, 425–432
 - future research directions, 452–457
 - impulse control, 449–452
 - investigation rationale, 406–410
 - motivational mechanisms, 410–424
 - summary/conclusions, 457–458
 chronic tolerance, 163
 CIDI (Composite International Diagnostic Interview), 81
 cigarette(s)
 - availability of, 99
 - consumption of, 4, 20
 - design of, 7, 20
 - pricing of, 20, 21, 520
 - vendor locations, 521, 522
 Cigarette Dependence Scale, 79n
 Cigarette Evaluation Scale, 423
 cigarettes per day (CPD)
 - in ATBC analysis, 496
 - with *CYP2A6* gene variants, 418
 - delay discounting correlation, 452
 - as dependence measure, 79, 80
 - in factor analysis, 88–89
 - in NHANES III analysis, 502
 - nicotine metabolism and, 406
 - predictive value of, 80
 - recall reliability, 26–27
 - as smoking cessation predictor, 81, 413
 - in TUS-CPS analysis, 498, 499
 cigarettes per month, 91
 class extraction, model misspecification related to, 222
 classic dependence criteria, 84, 86
 classification bias, 493
 class I–IV phenotypes, 28–31
 class membership, for familial resemblance, 256–257
 clinical preventive services, 4
 Clinical Research Support System, 415
 cluster analysis
 - developmental trajectories, 211, 217–223
 - discrete *versus* continuous phenomena in, 219
 - static *versus* dynamic, 219–220, 232
 - within-class variability in, 220–221, 233
 CNS (central nervous system), 344, 348, 353, 354
 CNZ (Christchurch, New Zealand) study, 266
 cocaine, 374, 456–457
 cocaine- and amphetamine-regulated transcript (CART), 36
 coexpression of receptors, 141, 142

- COGA (Collaborative Studies on Genetics of Alcoholism), 266
- cognition changes, 163–164
- cognitive control, 403, 424–425, 432–438
- during adolescence, 380
 - alertness in, 361
 - electrophysiological measures, 425–432
 - as endophenotype measurements, 358, 360
 - impairment, 113
 - impulsivity and, 112, 378–379
 - physiological basis of, 381
- cognitive deficits reversal, 434–435
- cognitive measures, of craving, 440
- cohorts
- effects of, 515
 - research models for, 519
- Collaborative Studies on Genetics of Alcoholism (COGA), 266
- colorectal polyps, 542
- commercial testing, 50
- common pathway model, 252, 270
- common-vulnerability model, 291–294, 306, 315–316
- communication of genetic findings, issues in, 45–50
- comorbidity
- psychiatric (*See* psychiatric comorbidity)
 - substance-use (*See* substance-use comorbidity)
- complementary dimensions of dependence, 97
- complex traits
- defining features, 31
 - genetic factors in, 35
 - genome-wide association studies for, 46
 - multiple determinations of, 22
 - replication difficulties, 45
 - sensitive genetic measures, 341
 - similarity of, 24–25
- Composite International Diagnostic Interview (CIDI), 81
- compulsive smoking, 80
- computational symbolic theory, 559–560
- COMT* gene, 269, 408–409, 430
- concurrent choice procedure, 416
- conditional independence, 256
- conditional triggers to smoke, 588
- conditioned place preference (CPP)
- biological plausibility of, 372–374, 421
 - in mice, 157–158, 161, 422
 - in rats, 423
- conditioning, contextual, 163–164
- conduct disorder
- adolescent smoking and, 201, 211, 232
 - definition of, 357
 - substance use and, 292–293, 304
- confounding factors, 32
- consensus, across indicators, 77
- constitutional hypothesis, 24
- construct
- definition of, 75
 - emerging, 520
 - proximal, 522
 - refinement of, 25–27
- construct properties, 75
- construct validation, 33, 34, 35, 75–78
- consumption level
- during adolescence, as indicator of adult dependence, 230–231
 - adolescent nicotine dependence and, 193
 - assessment of, 415, 418
- contamination, during administration, 145
- context-sensitive physiological measures, 363
- contextual conditioning, 163–164
- contingency table, smoking-drinking, 313, 315–316
- contingent factors, 247
- continuant, 541, 559
- continuous factors, 256
- continuous-level information, for behavioral modeling, 247
- continuous performance task (CPT), 362, 378, 433
- continuous phenomena, *versus* discrete phenomena, 219
- control, endophenotype measures of, 357–362
- control-related risk, 339, 354–357, 362
- controls, in association analysis, 258
- copy-number variation, 36
- core criteria, 76, 77
- core dependence dimension, 87–95
- core factors, 97, 168
- core strategy, 510
- cortisol, 447
- co-segregation of smoking behaviors, 24
- cost(s)
- genetic testing, 50
 - smoking cessation, 593
 - tobacco use, 4, 21
- COT (children of twins) design, 251–252, 279, 511
- cotinine
- biological activity of, 148
 - clearance factors, 39–40

- as nicotine by-product, 406
 - covariance, 32, 95–96, 341–342
 - in latent growth curve models, 254–255
 - in structural equation modeling, 248, 250
 - CPD. *See* cigarettes per day
 - CPP. *See* conditioned place preference
 - CPT (continuous performance task), 362, 378, 433
 - craving, 438–443
 - abstinence-induced (*See* abstinence-induced craving)
 - in adolescents, 192
 - cue-induced (*See* cue-induced craving)
 - dopaminergic systems associated with, 111
 - effects of, 405
 - measurement of, 403, 439–440
 - Craving subscale, 90–91
 - CREB activation, 160–161
 - CREB mice, 422
 - critical constituents, 25
 - cross-cultural differences, 515–516
 - cross-sectional studies, of substance-use comorbidity, 291
 - cross-species analysis, 348
 - cue(s)
 - in animal studies, 411
 - relapse, 99
 - reward signaling, 350
 - cue-induced craving, 438–439
 - with dependence, 441–443
 - effects of, 405
 - future research directions, 456–457
 - measurements, 403
 - physiological basis of, 111, 588
 - procedures to elicit, 440–441
 - research limitations in, 456
 - cue-self-administration response, 94
 - cultural transmission
 - adolescent smoking and, 198
 - effects of, 515
 - as environmental factor, 21
 - phenotypic, 251
 - research models for, 519
 - twin studies of, 262
 - cumulative effects, of pathogens, 103
 - cumulative risk, measurement of, 35
 - CYP2A6* gene
 - adolescent smoking and, 199
 - analysis of, 554, 555
 - association analysis of, 268
 - coding for, 408–409
 - mood effects with, 376
 - in nicotine metabolism, 22, 39–40, 149, 342, 406
 - in smokers, 413
 - variants in, 371, 418
 - Cyp2a5* gene variants, 149, 155, 413
 - CYP2B6* gene, 39
 - CYP2D6* gene, 39
 - Cys-Cys pairs, 136
 - cytochrome P-450 (CYP) system, 268
- D**
- danger-alarm responses, 353, 354
 - data-mining techniques, 541–542
 - data sets
 - ATBC analysis, 495
 - NHANES III analysis, 500–501
 - smoking cessation analysis, 493–494, 494
 - TUS-CPS analysis, 498
 - DAT/SLC6A3 (dopamine transporter protein), 268
 - DBA/2 inbred mice
 - conditioned place preference, 422
 - dose-dependent effects, 165
 - IV self-administration, 156
 - nicotine consumption, 159
 - nicotine effects, 435
 - oral self-administration, 412
 - prepulse inhibition in, 430–431
 - strain comparisons, 153–154, 164–165
 - tolerance in, 162, 163
 - DDC (DOPA decarboxylase), 269
 - definition variables, in structural equation modeling, 248
 - dehydroepiandrosterone (DHEA), 447
 - delay discounting
 - definition of, 348
 - in impulsivity, 349, 449, 450–452
 - physiological basis of, 379
 - study subjects for, 350
 - deleterious effect prediction, 554
 - dependence. *See also* nicotine dependence
 - addiction as, 77
 - core features of, 592
 - definition of, 75
 - distal measures of (*See* distal measures)
 - maintenance of, 598
 - model evaluation of, 78
 - patterns, 94

- severity with comorbidity, 98
- study of, 24
- depression, 351–352
 - nicotine amelioration and, 443
 - smoking association with, 444
 - subthreshold, 352
- desensitization, 146
- developmental pathways, 100, 589
 - impact on trajectory study, 222
- developmental psychopathology, 191–202, 292–293
- developmental trajectories. *See* adolescent developmental trajectories
- DH β E, 159, 169
- DHEA (dehydroepiandrosterone), 447
- diabetes mellitus, 46
- Diagnostic and Statistical Manual of Mental Disorders (DSM)* criteria
 - adolescent smoking, 192, 264
 - attention deficit hyperactivity disorder, 356
 - dependence, 37–38, 40, 81, 86
 - poor agreement with FTND, 25–26
 - scales in, 79
 - substance-use disorder, 291
 - as syndromal medical model, 80–81
- diagnostic criteria, heritability of, 30, 38
- diagnostic inferences, 77
- Diagnostic Interview Schedule (DIS), 501
- diary prompts/responses, 527, 528–529, 530
- Digit Span test, 433
- diltiazem, 168
- direct drug infusion, 152–153
- direct-to-consumer marketing, 50
- DIS (Diagnostic Interview Schedule), 81, 501
- disadvantaged youth, 520
- discrete phenomena, *versus* continuous phenomena, 219
- discrimination, against nicotine dependence, 46–47, 49
- discriminative validity, 77
- discussion groups (OBO Foundry project), 560
- Disease Ontology (DO), 560
- disease risk, 541, 550
- disinhibition, common trait of, 292–293
- disorder markers, 107
- dispositional tolerance
 - acquisition of, 162
 - versus* behavioral tolerance, 164
 - in tolerance, 168
- distal influence, *versus* proximal influence, 519–522
- distal measures
 - agreement among, 88
 - early *versus* mature states, 74
 - genetic mapping, 78–81, 86–87, 103–105
 - versus* proximal measures, 516
- distress tolerance, 448
- distributional assumptions
 - in growth curve models, 255
 - in structural equation modeling, 249
- DNA methylation, 36
- DNA sequences analysis, 554
- DO (Disease Ontology), 560
- DOPA decarboxylase (DDC), 269
- dopamine
 - in attention deficit hyperactivity disorder, 356
 - attention-vigilance associations with, 434
 - impulsivity linkage with, 451–452
 - inactivation of, 430
 - mesotelecephalic, 171
 - midbrain circuits, 348, 349, 350
 - in nicotine binding role, 406–407
 - in nicotine dependence, 43, 410
 - receptors, 156, 343
 - regulation of, 540
 - reinforcement role of, 374, 407
 - reward pathways, 342, 349, 352
 - signaling, 160
- dopamine β -hydroxylase (DBH), 269
- dopamine hypothesis of dependence, 588
- dopaminergic neurons, in ventral tegmental area, 588
- dopaminergic systems
 - adolescent smoking and, 198–199, 201
 - association analysis of, 268–269
 - craving associated with, 111
- dopamine transporter protein (DAT/SLC6A3), 268
- dopamine transporter (*SLC6A3*) *9-repeat allele, 441
- dose of nicotine, 161, 165
 - differences in, 367, 416
 - distribution of, 370
 - standardization, 152
- dose-response curve, 162, 444
- double variant haplotype, 545
- downregulation, 144–145, 588
- downstream processes, 81–82, 106
- DRD4 (dopamine receptor), 268
- DRD5 (dopamine receptor), 268
- DRD4* exon III polymorphism, 199

- DRD2* gene, 409
 addiction association with, 32
 coding for, 408
 commercial testing for, 50
 dependence association with, 407
 in craving, 441
 variants, 198
- DRD4*7*-repeat allele, 376
- drinking. *See* alcohol use
- drinking-water administration, 147–148, 172
- drug addiction. *See* addiction; substance use;
specific drug
- drug-motivated behavior, 404
- drug response comparison, 490–492, 491
- DSM. *See* *Diagnostic and Statistical Manual of
 Mental Disorders* criteria
- dual-trajectory model, of smoking-drinking
 trajectories, 315–316
- dynamic clustering
versus static clustering, 219–220, 232
 within-class variability in, 220–221, 233
- E**
- early-emergent motive, 91
- early-onset smokers
 risk for persistence, 200, 212–213, 230–231
 substance use and, 292, 296–297, 315, 320
- early smoking experiences (ESE), 375
- early tobacco exposure, 101, 155
- ecological momentary assessment (EMA), 255,
 525
- economic deprivation, 520
- educational attainment, adolescent smoking and,
 227–228, 232
- Edwards's theory of alcohol dependence syndrome,
 82–83
- EEA (equal environments assumption), 516–517
- EEG (electroencephalogram), 354, 403, 425–427
- effortful control, 358
- elasticity of demand, 417
- elation, 374
- electroencephalogram (EEG), 354, 403, 425–427
- electromyography (EMG), 431
- electrophysiological measures, 378, 425–432
- EMA (ecological momentary assessment), 255,
 525
- EMG (electromyography), 431
- empirical-Bayes approach, 549, 551
- empirical search strategies, 117
- employment discrimination, 49
- employment status, of hard-core smokers, 35
- encoding prior knowledge, 571
- endogenous cannabinoid systems, 159, 160
- endogenous enkephalin system, 160
- endogenous event-related potentials (ERPs),
 427
- endophenotypes, 5, 408–410
 caveats, 110–111
 characteristics of, 107–110
 in chronic smokers (*See* chronic smoker
 endophenotypes)
 conceptual issues, 381–383
 criteria, 413
 disorders associated with, 106
 future research directions, 455–457, 594
 gene linking in, 347, 409
 measurement of, 349–351, 353–354, 355,
 357–362
 motivational effects, 452, 454–455
 in network models, 558
 nicotine dependence, 409, 453
 phenotypes associated with, 5, 33–34
 pre-exposure risk, 340–347
 in psychiatric genetics research, 25
 replicability of, 27
 transitional, 107, 108, 200, 233
 types of, 340
- enhanced clearance. *See* dispositional tolerance
- entities, 541, 559, 560
- environmental factors, 99–103. *See also* social
 context; *specific factor*
 adolescent smoking, 196–197
 comorbidity, 99
 cue-induced craving, 438–439
 enrichment, 36
 in experimentation, 31
 gender differences in, 38
 gene expression variation from, 36–37
 genetic factors in, 35, 515
 importance of, 29
 linkage analysis, 258
 measurement of, 35
 in nicotine dependence, 22, 23
 nicotine use, 158
 relative contribution of, 30
 in smoking decline, 20
 substance use, 294–295
 twin studies, 251, 262, 279, 280
- environmental pathogens, 5, 25, 35

- epidemiology, 31–37
 future research in, 594
 genetic, 257
 extended, 250–252, 262–269, 279, 280
 hierarchical modeling in, 570–571
 perspectives from, 514
 phenotypic definitions in, 493
 public health outcomes in, 492
 triangle, 513
- epigenetics, 36
- epistasis, 32–33
- epistemology, 74, 77
- equal environments assumption (EEA), 516–517
- equifinality, 191, 220
- ERPs (event-related potentials), 403, 427
- ESE (early smoking experiences), 375
- ethanol, 412. *See also* alcohol use
- ethnic differences, in developmental trajectories, 213–214, 279
- etiological architecture, 510–511, 515–518, 519, 527, 530
- etiology
 diverse, 82, 106
 matrix of, 509
 of phenotypic assay, 83
 of symptoms, 78
- euphoria, 374
- Event Ontology (EVO), 560
- event-related potentials (ERPs), 403, 427
- EVO (Event Ontology), 560
- exchangeable classes, 551
- excitatory tone, 141
- executive function
 cognitive control and, 379
 definition of, 361
 nicotine dependence and, 34
- Executive Order 13145, 49
- exogenous event-related potentials (ERPs), 427
- experimental design, basics of, 149–150
- experimentation
 influences on, 31
 progression from, 30
- exposure model, 365
- extended structural equation modeling (XSEM), 249
- extended twin family studies, 250–252, 262, 279, 280
- extra-nicotinic mechanisms, 156–157
- extraversion, 346, 348–349
- extreme group membership, 96, 97
- extreme groups
 alternatives to, 116–118
 constructing, 114–116
- eyeblink response, 448
- ## F
- factor analysis, 37–38, 265
 consistency, 88
 correlation among, 80, 87
 DSM-IV correspondence with, 103
- factor loadings, 271–278
- factor mixture model (FMM), 256
- factor models, 256
- Fagerström Test for Nicotine Dependence (FTND), 79–80
 as assessment tool, 405
 dependence criteria, 37–38
 FTQ as precursor to, 24
 linkage analysis, 40–42, 589
 poor agreement with *DSM*, 25–26
 reliability and validity of, 26, 79–80
 scales in, 79
 visuospatial attention association with, 434
- Fagerström Tolerance Questionnaire (FTQ), 79–80
 for adolescent smoking, 192, 230–231, 264
 as physical dependence measure, 79
 startle response inconsistency, 448
 in susceptibility loci mapping, 24
 test-retest reliability, 26
- false discovery rates (FDRs), 542, 546, 570, 573
- false positive reports, 570
- familial resemblance, class membership for, 256–257
- family-based studies
 design of, 518
 ecological momentary assessment in, 526–527
 heritability documentation, 28–29
 new methodologies in, 521
- family dysfunction scores, 33
- family environment, adolescent smoking and, 196–197
- family history analysis, example of, 225, 230, 232
- fast-ionotropic nicotinic receptors, 136
- FDRs (false discovery rates), 542, 546, 570, 573
- fear conditioning, 169, 432, 435
- fear responses, 353, 354
- feeder stream influences, 81–82, 106

- female smokers. *See also* gender differences
 adolescent, 343
 blood pressure changes in, 448
 nicotine-dependence factors, 37, 38, 99
OPRM1 gene in, 419
 statistics on, 21
 twin studies, 515, 517
- fetal nicotine exposure, 357
- FHS (Framingham Heart Study), 266
- final common pathway, 82, 93, 106
- finite mixture model, 256
- Finnish Twin Registry, 262
- Finn Twin16-25 study, 307–323
 methods, 307–310
 results, 310–323
- first experience with smoking. *See* initial sensitivity
- first-stage estimates, 572
- Fisher, Ronald Aylmer, 22, 24
- five choice serial reaction time task (5CSRRT), 432
- five-class solution, example of, 226
- fixed effects, 215–216
- flunarizine, 168
- FMM (factor mixture model), 256
- focused interaction testing framework, 542
- forced choice procedure, 416
- formal model, 541, 559
- Fosb knockout mice, 161
- Foundational Model of Anatomy, 560
- four-point Likert scale, 375
- Framingham Heart Study (FHS), 266
- F344 rats, 423
- FTND. *See* Fagerström Test for Nicotine Dependence
- FTQ. *See* Fagerström Tolerance Questionnaire
- future research. *See also specific topics*
 crosscutting issues, 595–596
 implications of, 588–591
 understanding, 588–596
- G**
- γ -aminobutyric acid (GABA), 157, 406–407
- γ -aminobutyric acid receptors, 43
- GABA (γ -aminobutyric acid), 157, 406–407
- GABAergic interneurons, 142
- gateway theory of substance use, 292
- GAW (Genetic Analysis Workshops), 266
- gender differences. *See also* female smokers;
 male smokers
 adolescent smoking, 196, 199, 227–228, 260,
 263–264, 342
 animal studies, 155, 164
 cross-cultural, 515
 factor loadings by, 271–276
 nasal spray use, 373
 nicotine-dependence factors, 38, 99
 nicotine-dependence heritability estimates,
 279, 281
OPRM1 gene, 419
 smoking initiation, 267
 startle response, 378
 substance-use comorbidity, 304
 twin studies, 262, 517
- gender heterogeneity, 273–274, 276–278
- gene(s). *See also* candidate gene studies
 endophenotype linkage risks, 347, 409
 in nicotine dependence, 32, 43
- gene-environment interaction, 33, 515
 adolescent smoking, 197–200, 259, 346
 biological process initiation, 591
 environmental pathogens in, 25
 in etiology, 509
 investigation of, 546
 substance-use comorbidity, 320
 underuse of, 5
- gene expression, 36–37
- gene-gene interaction, 199, 343, 546
- gene-nicotine dependence associations, 45–46
- Gene Ontology, 560
- gene-pathogen relations, 100–101
- general growth mixture modeling (GGMM), 308–311
- generational changes, in smoking, 515
- Genes, Environment and Health Initiative, 531
- genetically informative designs, 527
- genetically modified mice, 444
- Genetic Analysis Workshops (GAW), 266
- genetic architecture, 510
- genetic association studies, 554, 556–559
- genetic drift, 150
- genetic epidemiology, 257
 extended, 250–252, 262–269, 279, 280
- genetic factors
 acute tolerance, 162–163
 conditioned place preference, 159
 craving, 441
 detection of, 493

- in experimentation, 31
- importance of, 29
- measured, 4
- in nicotine effects, 22, 39–40, 539
- quantitative models, 512
- in reinforcement, 418
- relative contribution of, 30
- selecting for, 96–97
- genetic heterogeneity, 32
 - adolescent smoking initiation, 196, 201–202, 233
 - in developmental trajectories, 190, 233–234
 - gender, 273–274, 276–278
 - phenotypes, 341
 - population, 217
 - estimating, 218, 221–222
 - receptor, 139
- genetic heterogeneity models, difference in fit
 - between homogeneity models and, 274–275
- Genetic Information Nondiscrimination Act (GINA), 49
- genetic latent class models. *See* latent class analysis
- genetic latent growth curve models. *See* latent growth curve models
- genetic mapping, 73–75. *See also* phenotypic research
 - analytic strategies, 96–103
 - construct validation, 75–78
 - core dependence dimension, 87–95
 - covariation among measures, 95–96
 - distal measures of dependence, 78–81, 86–87, 103–105
 - multidimensional measures, 81–86
 - person factors implications in, 97–98
- genetic modeling, 245–281
 - methodological and conceptual issues, 247–248
 - statistical framework for, 248–259
- genetic polymorphism effects, 553–554
- genetic substrata, associated with tolerance, 162
- genetic testing, 46, 50
- genetic variants
 - biological processes associated with, 109
 - causal, 546
 - disease association with, 550
 - evaluation context for dependence, 76
 - phenotypes with, 102, 106, 109, 111
 - pleiotropic associations of, 47–50
 - selection of, 101
 - value of, 110
- gene-to-phenotype influence, 78
- gene-transcription cascades, 169
- genome(s)
 - candidate genes in, 24
 - data, 561
 - studies of, 589
- genome markers, linkage analysis, 257–258
- genome scan, 266–267
- genome-wide association studies (GWAS), 25, 44, 269
 - event-related potentials, 428, 430
 - FTND, 42–45
 - genetic variant findings, 589
 - genotyping technologies used in, 258–259
 - potential of, 45–46
 - results from, 342
 - susceptibility loci identification, 407–408
- genotyping
 - effects of variables on, 553
 - mouse strains, 150
 - P450, 39
 - with phase interaction, 545
 - phenotypes and, 560–562
 - technologies, 257–259
- geographic information systems (GIS), 520–521
- GGMM (general growth mixture modeling), 308–311
- GINA (Genetic Information Nondiscrimination Act), 49
- GIS (geographic information systems), 520–521
- global use, 4, 21
- GluR (glutamate receptor), 157, 169
- glutamate receptor (GluR), 157, 169
- GMM (growth mixture modeling), 202, 218, 221, 308
- go/no-go task, 358–359, 451
- government policies, 7, 20
 - effect on adolescent smoking, 193
 - substance use, 294–295
- grant funding, 45–46
- graph connectivity, 571
- grouping variables, for growth curve modeling, 216–217, 232–233
- group membership, stability of, across statistical models, 229–230
- growth curve, nonlinear, 255
- growth curve mixture modeling, 215–217, 248–249
- growth mixture modeling (GMM), 202, 218, 221, 308

growth process, random effects for, 220–221
 gum. *See* nicotine gum
 gustatory reaction to tobacco, 75, 84
 GWAS. *See* genome-wide association studies

H

habituation, *versus* addiction, 24
 half-life of nicotine, 147
 haplotypes

- dependence and, 100
- disease association with, 544
- double variant, 545

 hard-core smokers, characteristics of, 35–36
 Hardy-Weinberg equilibrium, 545
 head rush, 374
 health care access, disparities in, 47
 health effects of smoking, statistics on, 4, 21
 heart rate, 351, 354, 440, 447
 Heaviness of Smoking Index (HSI)

- components of, 37, 413
- predictive value of, 80, 89–90
- scales in, 79
- zero-order correlations in, 80

 heavy smokers, 93

- delay discounting, 350
- diagnostic variance in, 89
- genetic factors in, 29
- versus* light smokers, 43, 81, 83–84, 90, 94
- substance use and, 296–297, 315

 Heavy Smoking Index, 265
 hedonic impact of nicotine, 158, 372, 424
 heritability

- adolescent nicotine dependence, 86, 342
- antisocial scores, 33
- anxiety, 445
- delay aversion, 351
- dependence, 37–38, 86, 433–434
- diagnostic criteria, 30, 38
- endophenotypes, 107
- estimates, 29–30
- event-related potential, 428, 429–430
- factors in, 28–29
- gender differences in, 279, 281
- impulsivity, 451
- neuroticism, 101
- nicotine metabolism/clearance, 38–40
- P450 genotype, 39
- prepulse inhibition startle response, 431–432
- response inhibition, 359
- resting EEG, 426
- smoking cessation, 406
- smoking heaviness, 90
- withdrawal symptoms, 30
- working memory, 437

 heterogeneity. *See* genetic heterogeneity
 hierarchical modeling

- estimation for, 575–576
- with ontologies, 551–552
- with prior knowledge, 570
- for statistical modeling, 117
- stochastic variable selection and, 547–549, 572, 573
- weighting in, 570

 high-affinity nAChRs, 156, 159
 higher-order joint actions, 546
 high genetic proneness, 96
 hippocampal activity, 141, 142
 HISTONE proteins, 36
 home smoking bans, 99
 homogeneity models, 271

- difference in fit between heterogeneity models and, 274–275

 homogeneous population

- assumption of, 248
- for growth curve modeling, 216–217

 Hooked on Nicotine Checklist, 26
 Horn-Russell Scale, 34
 hostility, 357, 362, 377
 Household Adult Questionnaire, 501
 HSI. *See* Heaviness of Smoking Index
HTR5A gene, 42
5-HTT gene, 33, 269, 441
5-HTTLPR gene, 101, 199, 409

- in adolescent girls, 343
- in affective response, 112, 446
- coding for, 408

 human clinical research

- affective regulation, 444–445
- electrophysiological measures, 426
- event-related potential, 428
- impulsivity, 450
- reinforcement, 413–414

 HumanCyc database, 556
 human genome, similarity with mice genome, 134
 3-hydroxycotinine, 406
 hyperactivity, 354, 356
 hypertensive rats, 449

- I**
 IBD (identical by descent), 257, 258
 ICD-10 criteria, 80–81, 192
 ICR mice, 159, 162, 163
 ICSS (intracranial self-stimulation), 372–373, 421
 identical by descent (IBD), 257, 258
 illicit substances. *See* substance use; *specific drug*
 impulse control, 449–452
 impulsivity, 348
 in attention deficit hyperactivity disorder, 354, 356
 clinical research, 433, 450–451
 cognitive control and, 112, 378–379
 delay discounting with, 349, 350, 449, 450–452
 heritability, 451
 measurement of, 450–451
 neural incentive system association, 346
 preclinical research, 449–450
 in response inhibition, 359
 incubation effect of initial exposure, 371
 independent pathway model, 253
 Indiana University Smoking Survey, 223–233
 data analysis, 225–226
 discussion, 231–233
 measures, 224–225
 procedures, 224
 results, 226–231
 individual pathways to mature state, 105, 106
 “infectious disease” model, 522
 inflammation masking, 145
 inhibitors. *See* antagonists
 inhibitory interneurons, 141, 142
 initial exposure response measures, 339
 initial sensitivity, 27, 363–364
 future research directions, 380–381
 innate sensitivity, 364–368
 other responses, 373–380
 reinforcement, 368–372
 rewards, 372–373
 innate sensitivity, 364–368
 instrumental learning, 158
 insurance companies, genetic testing and, 49
 integrative model of nicotine dependence, 22, 23
 integrative theory of triadic influence, 293
 intercept, distribution of, 219, 306, 310
 intercept models, initiation-based, 322
 intermediate phenotypes, 341, 342. *See also* endophenotypes

International Statistical Classification of Diseases and Related Health Problems, Tenth Revision (ICD-10) criteria, 80–81, 192
 interpersonal dynamics, 517, 522–525
 interval level, 247
 intracranial self-stimulation (ICSS), 372–373, 421
 intrathecal administration, 162
 intrauterine events, 100
 intravenous administration, 146
 humans, 415
 rodents, 152–157, 410–412
 in utero nicotine exposure, 357
 inveterate smokers, 87
 ion-channel receptors, 143
 Iowa gambling task, 350
 IRT. *See* item response theory
 item difficulty, 270
 item response theory (IRT), 254
 empirical example of, 269–279
 versus sum score approach, 278

J
 Jarvik, Murray, 24
 journal publishing requirements, 45–46

K
 kinship model, twin studies extended to, 250–252, 262, 279, 280
k-means clustering, 217
 knockout mice, 159, 160, 161, 166, 422
 Kraepelinian approach to diagnosis, 291
 Kyoto Encyclopedia of Genes and Genomes, 561

L
 laboratory-based measurements
 attention deficit hyperactivity disorder, 356
 consumption, 418
 endophenotypes, 349–351, 353–354, 357–362
 late emergent symptoms, 90–91
 latency to first puff, 415
 latent class analysis, 80, 92, 98, 248–249, 256–257, 266, 280
 latent class growth analysis (LCGA), 218, 226–229, 248–249
 latent growth curve (LGC) models, 254–256, 266, 280

- association data integrated into, 259
 - substance-use comorbidity, 306, 308, 321
 - latent phenotype model, 252, 270
 - latent profile modeling, 90–91
 - latent trait, 270
 - latent variables, 77, 248, 256
 - substance-use comorbidity, 306, 321, 324
 - LCGA (latent class growth analysis), 218, 226–229, 248–249
 - LD (linkage disequilibrium), 543, 545–546
 - learning associations, 349
 - learning differences, 158, 169
 - letter cancellation task, 433
 - level, in latent growth curve models, 254
 - Lewis rats, 411, 423
 - LGC. *See* latent growth curve models
 - liability models, of smoking behavior stages, 264, 280
 - lifetime regular smoking, definition of, 29
 - ligand-activated ion channels, 143
 - light smoking. *See* chippers
 - likelihood-based approaches, in cluster analysis, 217–218
 - likelihood ratio tests, 310, 312–313
 - linear growth, assumption of, 255
 - linear model, 116
 - linear regression, in structural equation modeling, 248
 - linear relations, 25
 - linkage analysis, 257–258, 266–268
 - candidate gene studies, 32, 40–42, 267–268, 280–281, 589
 - environmental factors, 258
 - genome markers, 24, 257–258
 - nicotine-dependence indices, 40–42
 - linkage disequilibrium (LD), 543, 545–546
 - Lister rats, 432–433, 444
 - lithium-chloride conditioned place aversion, 161
 - liver cytochrome P-450 enzyme CYP2A6. *See* CYP2A6 gene
 - location of smoking, 527
 - loci segregation, 40
 - locomotor activity, 369, 422
 - logarithm of odds (LOD) score, 40–42, 258, 267
 - logistic regression curves, 91
 - Long-Evans rats, 411
 - longitudinal data
 - growth curve modeling of, 218–219, 234
 - on substance-use comorbidity, 291, 320
 - Loss of Control subscale, 90–91
 - low genetic proneness, 96
 - LPAAT-delta gene, 42
 - lung, nicotine concentration in, 145
 - lung cancer, predisposition to, 44, 50
- ## M
- macrocontextual factors, 509, 514
 - as moderators, 515–516
 - macroenvironment proximal indicators, 521–522
 - macular degeneration, age-related, 46
 - magnetic resonance imaging (MRI), 351, 439, 456–457
 - maintenance of dependence, 589
 - male smokers. *See also* gender differences
 - adolescent, 342, 348
 - blood pressure changes in, 449
 - nicotine-dependence factors, 37, 38, 99
 - OPRM1 gene in, 419
 - statistics on, 21
 - twin studies, 515, 517
 - manifestations of dependence, 75
 - Mannheim Study of Risk Children, 199
 - MAO. *See* monoamine oxidase
 - MAP3K4 gene, 42
 - marginalization
 - of smoking, 4, 21
 - of social groups, 47
 - marginal nonnormality, 221
 - marijuana use
 - early pleasurable, 374
 - tobacco use concurrently with, trajectories of, 296–298
 - modeling, 304–305
 - trajectories of, 295–296
 - marketing direct-to-consumer, 50
 - Markov chain Monte Carlo (MCMC) methods, 542
 - masking etiology, 82
 - masking of causal factors, 74
 - maternal care, 36
 - mature subphenotypes, 82, 110–111
 - maximum acute tolerance, 162, 165
 - maximum price assessment, 418
 - McGill University Study on the National History of Nicotine Dependence, 199
 - MCMC (Markov chain Monte Carlo) methods, 542
 - mean (centroid)
 - cluster analysis, 217
 - growth curve modeling, 255
 - structural equation modeling, 248–249

- measured genetic factors, 4
measurement invariance, 247, 255, 276, 280
mecamylamine, 159
mediation
 of conditioned place preference, 161
 by endophenotypes, 107–108
 of nicotine, 160
memantine, 156, 171
memory, 379, 434–438
Mendelian randomization, 118
mesolimbic dopaminergic system, 410, 411
metabolic tolerance, 97
metabotropic glutamate receptor 5 (mGluR5), 156
methodological issues
 assessment precision, 520
 behavioral modeling, 247–248
 family-based studies, 521
 future research directions, 383–384, 594
 genetic modeling, 247–248
 innate sensitivity research, 366–368
 real-time interaction, 524–525
 research limitations, 366–368, 376, 383–384
 substance-use comorbidity, 321–323
methyllycaconitine citrate (MLA), 159
mGluR5 (metabotropic glutamate receptor 5), 156
mice. *See* mouse models
microchip analysis, 170, 258–259
microcontextual factors, 509, 514
 coding of real-time interaction, 524
 as moderators, 516–518
microsatellites, 543, 551
microsocial context, quantifying, 522–525
midbrain dopamine circuits, 348, 349
Mid-South Tobacco Family (MSTF), 267
migration levels, 516
Minnesota Nicotine Withdrawal Scale, 446
Minnesota Twin Family Study (MTFS), 196, 260, 360
mirror tracing, 448
misleading claims, 50
misspecification, model, 222
mixed models, developmental trajectories, 215
MLA (methyllycaconitine citrate), 159
model(s)
 clarification of, 559
 searching, 551
 selection of, 547
 with stochastic variable selection, 549–550, 551–552
model fit, evaluation of, 310, 312–313
modeling. *See also specific types of modeling*
 phenotype (*See* phenotype modeling)
 with prior knowledge, 570
 selection algorithm, 577–578
 uncertainties in, 546, 547, 549
model misspecification, 222
moderation of relationships, 248
modified pairwise interaction, 545
modulation
 dopamine receptors, 156
 nicotine rewards, 160
molecular genetic studies, 266
 of adolescent smoking, 198–199
 analytic framework for, 257–259
Monitoring the Future project, 299, 304
monoamine oxidase (MAO)
 in anxiety disorders, 353
 neuroticism and, 351
 in neurotransmitter breakdown, 540
monoamine oxidase (*MAOA/MAOB*) gene, 269
mood effects, 373–376, 380–381
 in ATBC analysis, 497
 measures of, 372
 of nicotine, 366
Mood Form of Diener and Emmons, 374–375, 446
morning smoking. *See* time to first cigarette
morphine, as nicotine substitute, 153
Morris water maze, 435
mortality statistics, 4, 21
motivational mechanisms, 84, 403, 408
 reinforcement, 410–420
 rewards, 420–424
Mouse Genome Informatics database, 150
mouse models, 134–135, 418
 adolescent exposure, 194–195
 behavioral changes, 151–157
 future research directions, 168–172
 nicotine administration, 145–149
 nicotine dependence, 149–151
 nicotinic receptors, 135
 customizing, 141–143
 functional diversity of, 136–141
 molecular biology of, 136
 nicotine as agonist/antagonist, 143–144
 upregulation, 144–145
 reward, 157–161
 startle inconsistency, 444
 strains, 134 (*See also* strain-specific differences; *specific strain*)
 research options with, 592
 selection of, 150–151

- tolerance, 162–168
 mouse-rat differences, 150
 movies, smoking in, 7, 20, 523
 MRI (magnetic resonance imaging), 351, 439, 456–457
 MSTF (Mid-South Tobacco Family), 267
 MTFS (Minnesota Twin Family Study), 196, 260, 360
 multidimensional measures, of nicotine dependence, 81–86
 multifinality, 191
 multilevel analysis, difficulties of, 248
 multiple trajectories, developmental, 191–202, 232–234
 multivariate analysis
 developmental trajectories, 215
 latent growth curve models, 255
 substance-use comorbidity, 315–316, 321
 twin studies, 262–263
 multivariate factor model, 252–253
 multivariate normal distribution
 in growth curve models, 255
 in structural equation modeling, 249
 multivariate normality, within-class, 221, 233
 mu opioid knockout mice, 422
 mu opioid receptors
 in conditioned place preference, 160
 in nicotine replacement therapy, 407
 reward mediation, 419
 in tolerance, 167, 168
 muscarinic acetylcholinergic systems, 166, 168
 muscarinic receptors
 in aging, 170
 blockading, 140–141
 metabotropic, 136
 muscle tension, 377–378
 mutations
 rate predictions, 554
 for tolerance, 166
 Muthén, Bengt, 218
- N**
- nAChRs. *See* nicotinic acetylcholine receptors
 Nagin, Daniel, 218
 naloxone, 160
 nasal spray. *See* nicotine nasal spray
 National Cancer Institute, 498
 National Center for Biomedical Ontology (NCBO), 561
 National Comorbidity Study, 445
 National Health and Nutrition Examination Survey (NHANES III), 487, 494, 500–503
 National Institute of Mental Health Diagnostic Interview Schedule (DIS), 81, 501
 National Institute on Drug Abuse Genetics Consortium, 43
 National Institutes of Health, 531
 National Longitudinal Study of Adolescent Health (Add Health), 197–198, 261, 517
 National Survey on Drug Use and Health, 93
 N-back task, 436
 NCBO (National Center for Biomedical Ontology), 561
 NDSS. *See* Nicotine Dependence Syndrome Scale
 NEAD (Nonshared Environment in Adolescent Development) Project, 509, 524–525
 Netherlands Twin Register, 262
 Netherlands Twin Study of Anxious Depression (NETSAD), 266–267
 network models, 554, 556–558
 neural analysis, 349–351, 353–354, 357–362
 neural incentive system, 346
 neural networks modeling, 340–341
 neural substrata, associated with tolerance, 162
 neural systems, candidate, 343–346
 neurexin 1 (*NRXN1*) gene, 43
 neurobiological analysis, 348
 neurobiological dependence pathways, 43
 neurobiological systems, 344
 neuroendocrine response, to stress, 354
 neuroimaging, 360, 379–380
 neuropeptide systems, 159, 160
 neuroprotection, 170
 neuroticism, 101, 351–353
 neurotransmitter systems
 in chronic tolerance, 166–167
 in conditioned place preference, 159–161
 New England Family Study, 526
 NHANES III (National Health and Nutrition Examination Survey), 487, 494, 500–503
 nicotine
 administration of (*See* administration)
 age-related response differences, 194–195
 as agonist/antagonist, 143–144
 anti-inflammatory effects of, 148–149
 anxiogenic effects of, 168
 behavioral changes from, 151–157
 bioavailability of, 7, 20
 enforcement timing, 369
 in free-base form, 148

- frequency of use, 4, 21, 369–371, 413, 420
- hedonic impact of, 158, 372, 424
- neuronal activity induced by, 43
- physical changes from, 162
- pre-exposure risk (*See* pre-exposure risk)
- pretreatment, 420
- reinforcement (*See* reinforcement)
- rewards and (*See* reward)
- tolerance (*See* tolerance)
- nicotine aerosols, 147
- nicotine-binding sites, 135, 144
- nicotine choice, 369
- nicotine choice procedure, 416, 419–420
- nicotine cigarette choice paradigm, 419
- nicotine clearance
 - dispositional tolerance, 162, 164, 168
 - genetic factors in, 39–40, 539
- nicotine dependence, 20–22, 149–151
 - in adolescence (*See* adolescent nicotine dependence)
 - concurrent with substance use (*See* substance-use comorbidity)
 - construct refinement, 25–27
 - craving associated with (*See* craving)
 - crosscutting issues, 595–596
 - developmental pathways in, 589
 - distal measures of (*See* distal measures)
 - endophenotypes in, 409, 453
 - epidemiological concepts, 31–37
 - future research directions, 455–457
 - heritability of (*See* genetic factors; heritability)
 - historical perspective of, 22–25
 - inference of, 77
 - mouse models of (*See* mouse models)
 - phenotype (*See* phenotype(s))
 - progression research, 592
 - psychiatric disorders correlated with, 98
 - risk with, 375–376
 - smoking compared with, 87
 - versus* tobacco dependence, 75
 - treatment of (*See* smoking cessation)
 - understanding of, 588–596
- nicotine-dependence measures, 26, 28, 37–45, 73, 78, 79
 - adolescents, 192, 230–231, 264
 - example of, 225
 - invariance, 276, 280
- Nicotine Dependence Syndrome Scale (NDSS), 82–84
 - abbreviated, 500
 - as assessment tool, 405
 - subscales of, 90
 - in TUS-CPS analysis, 498
- nicotine deprivation memory deficits, 436
- nicotine gum
 - as consumption assessment, 415
 - effect on EEG activity, 426
 - in memory effects, 435
 - versus* placebo, 370
- nicotine metabolism
 - association analysis of, 268
 - catabolism of, 149
 - CPD variation and, 34
 - CYP2A6* gene in, 39–40, 149, 342, 406, 418
 - in dependence risk, 22, 342
 - in ontology example, 562–569
 - pathway, 556
- nicotine nasal spray
 - aversion with *DRD4*7*-repeat allele, 376
 - as consumption assessment, 415
 - in current smokers, 374
 - memory effects of, 435–436
 - versus* placebo, 369–370
 - pleasurable responses to, 373
- nicotine patches
 - effect on EEG activity, 426
 - in memory effects, 435
 - on nonsmoking adults, 377
- Nicotine Pharmacokinetics Ontology (NPKO), 539, 561, 571
- nicotine replacement therapy (NRT), 406. *See also* smoking cessation
- nicotinic acetylcholine receptors (nAChRs), 134
 - association analysis, 268
 - as attention factor, 362
 - beta2-subunit (*CHRNA2*), 268
 - binding to, 588
 - blockading, 140–141, 143–144
 - chromosomal regions, 43, 44, 50
 - in chronic tolerance, 166–167
 - coding for, 408
 - customizing, 141–143
 - desensitization of, 146
 - fast-ionic, 136
 - functional diversity of, 136–141
 - high-affinity, 157
 - illustration, 409
 - as impulsivity mediator, 449
 - inactivation of, 143
 - inferences from, 152–153

- initial sensitivity response with, 376–377
 molecular biology of, 136
 in nicotine binding role, 406–407
 in nicotine dependence, 411
 structure of, 136–138, 138
 tissue-specific responses, 71, 133
 in tolerance, 168
 upregulation of, 135, 144–145, 588
- nicotinic receptor subunits, 136–140
CHRNA5/CHRN3 genes, 342
 composition of, 139
 functional variants of, 140
 limiting expression, 141–143
 structure of, 136, 137
- nimodipine, 162, 167, 168
- nitric oxide, in conditioned place preference, 161
- 7-nitroindazole, 161
- N*-methyl-D-aspartic acid (NMDA) glutamate receptors, 156
- NMRI outbred mice, 154, 412, 430
- nomological net, 76
- noncoding DNA sequences, 554
- nonlinear growth curves, 255
- nonnicotinic systems, 166
- nonnormality, 221
- Nonshared Environment in Adolescent Development (NEAD) Project, 509, 524–525
- nonsmokers (abstainers)
 characteristics of, 22
 inclusion *versus* exclusion of, 222–223, 235, 323
 nicotine patches, 377
- Northern California Twin Registry, 539, 540
- novelty seeking, 155–156, 199, 348–349
 by adolescents, 27
 nasal spray use in, 373
 neural incentive system association with, 346
 in substance use, 292–293, 348–349
- NPKO (Nicotine Pharmacokinetics Ontology), 539
- NRT (nicotine replacement therapy), 406. *See also* smoking cessation
- NRXN1* gene, 43
- NRXN3* gene, 43
- nutritional cancer prevention, 497
- O**
- OBO (Open Biomedical Ontologies), 560
- OBO-Edit, 561
- OBO Foundry project, 560
- OBO Relation Ontology, 561
- observed variables, in structural equation modeling, 248
- occurrent, 541, 559
- oddball stimulus, 429
- olanzapine, 456
- ontologies, 539–541
 definition of, 541, 559
 development process, 560–562
 discussion of, 570–574
 methods, 541–543, 550–562
 nicotine metabolism, 562–569
 statistical approaches, 543–550
- Ontology Web Language (OWL), 561
- Open Biomedical Ontologies (OBO), 560
- Open Source software, 561
- OPRM1* gene, 409
 coding for, 408
 gender differences in, 419
 in nicotine replacement therapy, 407
 in smokers, 423
 support interval proximity, 42
- oral administration, 147–149, 172, 412–413
- oral mucosa exposure to nicotine, 148
- ordinal data, analytical framework for, 247, 255
- osmotic minipump, 147
- outcomes of dependence, 75
- outliers, controlling for, 281
- OWL (Ontology Web Language), 561
- oxotremorine, 166–167
- P**
- P3 amplitude, 294
- panic disorder, 353
- PANTHER Pathways databases, 556, 561
- parent(s)
 educational level of, 519
 twin studies extended to, 251, 262, 279, 280
- parental monitoring, as smoking counterforce, 22
- parental smoking
 adolescent smoking and, 196–197, 200, 262, 346
 behavioral modeling of, 246
 nasal spray non-response, 377
 smoke-free home with, 523
 socialization effects from, 517
- parenting behavior, 342
- partition variation, 270, 280
- passive avoidance, 435
- patch. *See* nicotine patches

- path diagrams, in structural equation modeling, 248–250
- pathogen modeling, 100–101, 103
- PATO (Phenotype and Trait Ontology), 560, 571
- Pavlovian learning, 158
- PBT (problem behavior theory), 198, 292–294, 322
- PDAs (personal digital assistants), 525–527
- peers
- as influence, 100, 346, 517
 - as smoking predictors, 523
- peer smoking, effect on adolescent smoking, 197
- penetrance, incomplete, 31
- peripheral nervous system (PNS), 344, 348
- P50 ERP, 427–428
- persistence
- drug use, 417–418
 - negative affect with, 447
 - smoking (*See* smoking persistence)
- personal digital assistants (PDAs), 525–527
- personalized health care, 49–50
- person factors, 97–99
- PET (positron emission tomography), 439
- P300 event-related potential (ERP), 359–360, 429–430
- P450 genotype, 39
- pharmacokinetics, 37, 39, 118, 149, 542, 590
- pharmacokinetics ontology, 539, 561, 571
- phenotype(s)
- assays, 83
 - association of, 33
 - behavioral, 171, 492
 - characteristics of, 109
 - components, 341
 - developmental progression of, 74
 - effects of variables on, 553
 - as endophenotypes, 5, 33–34
 - environmental, 34–36
 - framework, 27–31
 - genetic mapping, 96–103
 - genetic variants to, 102
 - genotyping and, 560–562
 - heterogeneity, 341
 - intermediate, 341, 342 (*See also* endophenotypes)
 - of mouse strains, 150
 - pathways, 23, 590
 - as points in smoking trajectory, 490
 - research pitfalls, 489
 - stages, 109
 - substance-use disorders, 316–318, 321, 324
- Phenotype and Trait Ontology (PATO), 560, 571
- phenotype modeling, 487, 488–492
- examples, 493–503
 - methods, 492–494
 - summary, 503–505
- phenotypic assortative mating, 251
- phenotypic cultural transmission, 251
- phenotypic research, 105–106
- analytic strategies, 113–118
 - causal paths, 107–110, 111–113
 - caveats, 110–111
 - summary, 118–119
- phenylthiocarbamide (PTC) haplotype, 84
- phosphatase and tensin homolog (*PTEN*) gene, 269
- physical aggression, 357
- physical responses to nicotine, 169
- symptoms, 26
 - in tolerance, 162–163, 164–165
- physiological measures of response reward, 351
- physiological startle. *See* startle response
- physiology
- of affect, 377–378
 - of behavioral traits, 344, 345, 346
- Pittsburgh Youth Study, 214
- placebo, *versus* nicotine, 369–370, 420
- placenta, 145
- plasma nicotine levels
- with IV injection, 146
 - tissue nicotine levels compared with, 145
 - in tolerance studies, 163–164
- pleiotropy, 32, 47–50
- PNS (peripheral nervous system), 344, 348
- point mutation, 444
- policy interventions, 34–35
- polymorphisms, 553–554. *See also* single nucleotide polymorphism
- associations with, 116
 - different priors for, 571
 - in dopamine reward pathway, 342
 - emphasis within genes, 547
 - investigation of, 546–547
 - numerous, challenges of, 546–547
 - perturbations from, 554
 - trait variation effect of, 549
- PolyPhen (polymorphism phenotyping), 554
- polysubstance use, 43, 296
- population
- frequency of genetic factors in, 86

- for growth curve modeling, 216–217, 234
 - homogeneous, assumption of, 248
 - in latent class analysis, 256
 - response distribution in, 370, 373, 376–380
 - in structural equation modeling, 248–249
 - population heterogeneity, 217
 - estimating, 218, 221–222
 - Positive and Negative Affect Schedule, 374–375, 446
 - positron emission tomography (PET), 439
 - postural hypotension, 449
 - PPI (prepulse inhibition), 378, 403, 430–432
 - preclinical research. *See also* animal studies; mouse models
 - affective regulation, 443–444
 - electrophysiological measures, 425–426
 - event-related potential, 427–428
 - impulsivity, 449–450
 - reinforcement, 410
 - rewards, 421–423
 - precursors, class III phenotypes as, 30
 - predictive validity
 - of genetic testing, 50
 - of primary motives scales, 90–91
 - pre-exposure risk, 339, 340. *See also* smoking initiation and progression risk
 - endophenotypes, 340–347
 - future research directions, 381–385
 - initial sensitivity endophenotypes (*See* initial sensitivity)
 - preproenkephalin knockout mice, 160, 422
 - prepulse inhibition (PPI), 378, 403, 430–432
 - price-demand curve, 417
 - pricing, of tobacco products, 20, 21, 520
 - primary motive scales, as predictors, 90–93
 - prior covariate specification, 570–571
 - prior knowledge, ontologies and, 553–562
 - PR (progressive ratio) measures, 417–418, 420, 454
 - probability discounting, 450–451
 - problem behavior theory (PBT), 198, 292–294, 322
 - problem use, 196, 198, 263, 294
 - Profile of Mood States, 374–375, 446
 - programmed lapse procedure, 454
 - progression to smoking, 491
 - progressive ratio (PR) measures, 417–418, 420, 454
 - Project on Human Development in Chicago Neighborhoods, 520
 - “proof of concept” analyses, 493, 494
 - protective factors
 - in adolescents, 343
 - versus* vulnerabilities, 87, 114
 - protein sequence data, 561
 - protobacco advertising, 7, 20, 30, 348
 - prototypes, of nicotine-dependence research, 27–28
 - proximal indicators, 509
 - proximal influence, 519–522
 - proximal measures
 - versus* distal measures, 516
 - of social context, 518–527
 - psychiatric comorbidity, 81, 98–99
 - with *DSM-IV* dependence, 26, 81
 - empirical examples of, 496, 502
 - resolving, 115
 - psychiatric genetics research, 25, 27
 - psychoactive alkaloid, 22
 - psychological traits
 - approach-related risk, 346–349
 - avoidance-related risk, 351
 - control-related risk, 354–357
 - psychometric common factor model, 252
 - psychopathology
 - developmental, 191–202, 292–293
 - indices, 32
 - physiological basis of, 344
 - substance use and, 292–293, 304
 - psychophysiological responses
 - to acute stressors, 448–449
 - craving, 440
 - psychosocial factors
 - in adolescent nicotine dependence, 195
 - in adolescent smoking initiation, 200, 202, 211
 - PTC (phenylthiocarbamide) haplotype, 84
 - PTEN* gene, 269
 - public health messages, 47
 - public health outcomes, 492
 - public settings, smoking in, 4, 20–21
 - putative endophenotypes, 341
- Q**
- QSU (Questionnaire on Smoking Urges), 439
 - QTL (quantitative trait locus), 258
 - quantitative genetic models, 512, 522
 - quantitative trait locus (QTL), 258
 - quantity smoked measures, 28
 - Questionnaire on Smoking Urges (QSU), 439

R

- racial background, 439. *See also* African Americans
- racism, associated with genetic information, 47
- random effects, 216
 - within-class, 220–221, 233
- rapid-decision context, 358
- Rapid Visual Information Processing (RVIP) task, 433
- rat models
 - adolescent nicotine exposure in, 194–195
 - alcohol/nicotine correlation, 369
 - conditioned place preference in, 423
 - self-administration of electrical stimulation, 421
 - sensitivity in, 364
 - strains, 411 (*See also specific strain*)
- Reactome, 561
- real-time contexts, 526
- real-time interaction, 524–525
- recall, 379
- receptor heterogeneity, 139
- recovery, from acute tolerance, 162
- regression models, 248, 542, 543, 550–551, 572
- regular smoking
 - definition of, 29
 - genetic factors in, 29–30
- reinforcement, 151–152, 155–156, 366–372, 380
 - alternative, 417
 - in cognitive control, 349
 - enhancing, 413
 - genetic influences in, 418
 - in initial sensitivity, 368–372
 - measurement of, 414–420
 - motivational mechanisms, 410–420
 - secondary, 411, 413
- relapse
 - environmental influences in, 95
 - physiological basis of, 588
 - predictors of, 77, 413, 434, 442, 444–445
 - time to first cigarette as predictor of, 80, 89
- relations between entities, 541, 559, 560
- relative measurements, 571
- reliability. *See also* test-retest reliability
 - of developmental trajectory research, 234
 - of nicotine-dependence measures, 26, 79–80
 - recall, 26–27
- reliability coefficients, 79
- religiosity, adolescent smoking and, 198
- repeated-measures data, developmental trajectories, 215, 222
- replication, of gene-nicotine dependence associations, 45–46
- research findings, communication of, issues in, 45–50
- research limitations
 - adolescent smoking, 367
 - adult smoking phenotype, 190
 - ATBC analysis, 497, 504
 - behavioral measures, 104
 - cue-induced craving, 456
 - data, 572
 - distal measures, 103
 - DSM, 103
 - extreme groups, 114–116
 - methodology, 366–368, 376, 383–384
 - NHANES III analysis, 503–505
 - nicotine-dependence measures, 103–104
 - Nicotine Dependence Syndrome Scale, 84
 - retrospective reporting, 367
 - self-report measures, 367
 - smoking cessation research, 454–455
 - statistics modeling, 570
 - tobacco dependence assessments, 95
 - TUS-CPS analysis, 500, 504
 - twin studies, 279–280
 - Wisconsin Inventory of Smoking Dependence Motives, 85–86
- residual familial factors (F), 258
- residual item variances, 270
- respiratory sinus arrhythmia (RSA), 361
- response inhibition, 358–359
- resting EEG activity, 425–427
- retail tobacco outlets, 520, 521
- retrospective reporting limitations, 367
- reward, 157–161
 - definition of, 349
 - for depressed smokers, 352
 - future research directions, 454–455
 - immediacy over magnitude, 348, 349
 - in initial sensitivity, 372–373
 - measurement of, 351, 366, 372–373, 380, 423–424
 - modulation of, 160
 - motivational mechanisms, 420–424
 - mu opioid receptor mediation, 419
 - preclinical studies, 157–161, 372–373, 421–423
 - signaling, 350
- reward and pleasure pathways, 22
- reward-discounting tasks, 350

- rimonabant, 160
 risk. *See also* pre-exposure risk; smoking
 initiation and progression risk
 age-specific, measurement of, 35
 approach-related, 339, 346–349, 362
 avoidance-related, 339, 351–354, 362
 control-related, 339, 354–357, 362
 cumulative, measurement of, 35
 disease, 541, 550
 with nicotine dependence, 375–376
 nicotine metabolism and, 22, 342
 risk factors
 adolescent smoking initiation, 211–212, 232,
 350, 433
 substance use, 306, 340
 risk-taking behavior, by adolescents, 195, 199
 RNA analysis, 142
 rodent models. *See also* mouse models; rat models;
 specific strain
 adolescent nicotine exposure, 194–195
 adolescent sensitivity, 371
 intravenous self-administration, 410
 nicotine effects, 368, 435
 strain-specific differences, 418
 RSA (respiratory sinus arrhythmia), 361
 *RS578776 subunit gene, 43
 *RS16969968 subunit gene, 43
 Russell, M.A.H., 24
 RVIP (Rapid Visual Information Processing) task,
 433
- S**
- saccharin, 148, 154, 159
 S allele, 112, 113
 sample size/followup
 in ATBC analysis, 497
 for developmental trajectory research, 234
 in TUS-CPS analysis, 498
 saturated model, 547
 SBML (Systems Biology Markup Language), 561
 schizophrenia, 428, 443
 secondary criteria of nicotine dependence, 76, 77
 secondary motives scales, 92–93
 secondary reinforcement, 411, 413
 secondhand smoke, 20, 246
 second-stage mixture model, 572
 self-administration
 ad libitum (ad lib), 415–416, 419
 genetic effects on, 146
 intravenous, 146, 152–157, 410–412
 oral, 412–413
 self-control, in children, 344
 self-insuring firms, 49
 self-report measures
 of affect, 446–447
 components of, 79
 of craving, 439–440
 ecological momentary assessment in, 525
 limitations of, 367
 SEM. *See* structural equation modeling
 semi-Bayes approach, 549
 semistructured paradigms, 524
 Sensation Seeking Scale, 377
 sensitivity
 of measurements, 341
 modeling, 363–364, 364
 periodic, 96
 sensitivity analysis, 570
 sensory measures, 403
 Sensory Questionnaire, 423
 sequential process model, of substance-use
 comorbidity, 304
 serotonin
 association analysis, 268–269
 genetic variation in, 343
 metabolism of, monoamine oxidase in, 353
 regulation of, 540
 smoking cessation and, 407
 SES. *See* socioeconomic status
 seven-point Likert scale, 372
 shared environment effects
 in adolescent smoking, 197, 260–261, 264, 280
 twin studies, 251, 280
 Shiffman-Jarvik Withdrawal Scale, 440
 Shiffman Nicotine Dependence Syndrome Scale.
 See Nicotine Dependence Syndrome Scale
 sibling(s)
 IBD configurations for, 257–258
 smoking epochs of, 531
 as smoking predictors, 523
 socialization studies, 517
 twin studies extended to, 251, 262, 279, 280
 Sibling Partners Study, 526
 sickle cell discrimination, 47
 side effects
 from drinking-water administration, 172
 from intravenous administration, 146
 SIFT (Sorting Intolerant From Tolerant)
 procedure, 554

- simultaneous effect of genes, 32–33
- single-factor dependence, 79n
- single-factor structure, 81
- single-group growth curve model, 219
- single nucleotide polymorphism (SNP)
 - candidate gene variants, 25
 - disease association with, 544
 - genotyping, 43, 257–259
 - nonsynonymous coding, 554
 - as reflection of underlying effects, 546
 - relationships over candidate genes, 545
 - relevance of, 570
 - in whole-genome research, 4
- situational dependence, 27
- six-class solution, example of, 227–228
- skin conductance, 354, 377–378
- skin temperature, 440
- SLC6A3* gene, 198
- SLC6A4* gene, 32, 101, 112, 113
- sleep problems, in children, 357
- slope
 - distribution of, 219
 - factor loading and, 275–276
 - in latent growth curve models, 254, 306, 310
- 129S6 mice, 430
- SMOFAM (Smoking in Families Study), 267
- smoke-free laws, 520
- smoke-free settings, 20, 30, 523
- smokeless tobacco, 147
- smokers, characteristics of, 22
- smoking
 - bans on, 99
 - decline in, 20
 - developmental phenotypes (*See* adolescent developmental trajectories)
 - first experience with (*See* initial sensitivity)
 - frequency of, 369–371, 413, 420
 - during illness, 79, 80
 - nicotine dependence compared with, 87
 - quantitative genetic model and, 512
 - status, 28
 - transition levels, 42–43, 488–490
- smoking cessation
 - age-related changes in, 170
 - barriers to, 4–5, 46
 - CHRNA2* gene in, 407
 - commercial testing, 50
 - comparison groups changes, 493
 - data sets in, 493–494, 494
 - definition of, 492
 - delay discounting factor in, 350
 - demand for, 21
 - difficulties of, 97
 - drugs for, 160
 - failures in, 44–45
 - FTND predictions of, 80
 - future research directions, 454
 - gender differences in, 38
 - heritability in, 406
 - monoamine oxidase decrease during, 351
 - research limitations in, 454–455
 - serotonin pathway and, 407
 - subthreshold pretreatments, 162
 - success predictors, 81, 89, 413, 434
 - symptoms of, 447
 - tailored, 48
- smoking index variable, 30
- Smoking in Families Study (SMOFAM), 267
- smoking initiation, 31, 42
 - adolescent (*See* adolescent smoking initiation)
 - assessment of, age effects in, 279, 322
 - definition of, 29
 - gender differences in, 267
 - linkage analysis of, 267
 - versus* persistence, 406
- smoking initiation and progression risk, 346, 491.
 - See also* pre-exposure risk
 - approach-related, 346–349
 - avoidance-related, 351–353
 - control-related, 354–357
 - endophenotypic measures, 349–351, 353–354, 357–362
 - future research directions, 362–363
- smoking level
 - measurement of, example of, 224–225
 - substance-use comorbidity and, 308, 322
- smoking pattern, factor analysis of, 265
- smoking persistence, 29, 30, 406
 - definition of, 29
 - early-onset smokers' risk for, 200, 212–213, 230–231
- smoking topography devices, 415, 418
- SNP. *See* single nucleotide polymorphism
- social context, 509, 510–511
 - adolescent smoking, 193, 198
 - behavioral genetics in, 514–518
 - future research directions, 527–532
 - proximal measures of, 518–527
 - rationale for, 511–514
 - substance use, 294–295

- social development model, 293
- socioeconomic status (SES)
- adolescent smoking and, 232
 - distal to proximal influence, 519–522
 - of hard-core smokers, 35
 - nuanced approaches to, 519–520
- socioregional influences, 515–516
- “softening” of smoking, 193
- software
- association analysis, 259
 - item response theory, 270
 - linkage analysis, 258
 - ontology, 561, 562
- Sorting Intolerant From Tolerant (SIFT)
- procedure, 554
- SourceForge Web site, 562
- species-specific responses, 134
- specific-factor models, of substance use, 306–307, 315–316
- speed congenics, 151
- spinal cord minipumps, 163
- spouses, socialization effects from, 517
- Sprague-Dawley rats, 411, 431, 432–433
- stage models, developmental trajectories, 233
- startle-probe measures, 113
- startle response
- as affective response, 447–448
 - in humans, 377
 - increases in, 444
 - prepulse inhibition of, 378, 403, 430–432
 - test-retest reliability of, 446–447
- state laws, against genetic discrimination, 49
- static clustering, *versus* dynamic clustering, 219–220, 232
- statistics
- approaches to, 543–550
 - combining genetic studies with, 248
 - developmental phenotypes, 214–231
 - modeling, 248–259, 570
 - ontological knowledge in, 572
- ST/b inbred mice, 154, 155, 412–413
- stem cells, 151
- Sternberg Memory Task, 379, 436–437
- stigma, nicotine dependence as, 46–47
- stochastic variable selection
- hierarchical modeling and, 547–548, 572, 573
 - model selection with, 549–550, 551–552
- stop-go task, 359
- strain-specific differences
- aging, 170
 - conditioned place preference, 158
 - DNA markers, 151
 - five choice serial reaction time task, 432–433
 - genetic, 150
 - mouse models, 153–154, 164–165, 412–413
 - nicotine effects of, 135, 161, 169, 418
 - nicotinic acetylcholine receptors, 172
 - rat models, 411
 - tolerance, 164
 - unraveling of, 142
- strain surveys, 422
- stress, 351
- as influence, 100
 - influences on, 36
 - neuroendocrine response to, 354
 - response mediators, 143
- Stroop interference task, 379, 440, 451, 452
- Stroop paradigm, 113
- structural equation modeling (SEM), 248–249
- combined with latent class models, 256
 - of developmental trajectories, 215
 - linkage analysis and, 257–258
 - for twin data, 249–257
- study participants, selection of, 490–492
- subcutaneous administration, 147, 172
- subpopulation
- in latent class analysis, 256
 - in structural equation modeling, 248–249
- subPSEC (substitution position-specific evolutionary conservation), 554
- substance use. *See also specific substance*
- adolescent, shared environmental influences in, 261
 - age-dependent vulnerability to, 195, 198, 200–201, 212, 233–234, 292–293
 - attention deficit hyperactivity disorder in, 356
 - common-vulnerability model, 291–294, 306, 315–316
 - dopamine in, 410, 588
 - early pleasurable use, 374
 - environmental factors influencing, 294–295
 - interpersonal dynamics in, 522
 - Iowa gambling task as predictor, 350
 - modeling of, 43
 - nasal spray non-response, 377
 - novelty seeking in, 292–293, 348–349
 - prevention of, research approaches, 294–295
 - risk factors for, 340
 - specific-factor models, 306–307, 315–316

- substance-use comorbidity, 289–325
 association between smoking trajectories and, 296–298
 empirical examples of, 307–323, 496, 502
 future research directions, 323–324
 gender differences in, 304
 gene-environment interactions in, 320
 importance of studying, 290–292
 informative phenotypes for, 316–318, 321, 324
 literature review, 295–296
 mechanisms underlying, 291–292
 methodological issues, 321–323
 modeling, 298–307
 risk factors, 306
 two-stage models of, 323
- substance-use disorders
 common *versus* specific liability to, 292–295
 diagnosis of, 291
 shared genetic risk for, 294
- substitution position-specific evolutionary conservation (subPSEC), 554
- subthreshold depression, 352
- sucrose, 154–155, 412
- support interval, 40, 42
- Surgeon General's Report (1964), 24
- Surgeon General's Report (1979), 24
- susceptibility loci mapping, 24. *See also* candidate gene studies
- sweat gland activity, 440
- Swedish Twin Registry, 515
- Swiss mice, 435
- Swiss-Webster mice, 158, 161
- switching, between trajectory groups, 255–256
- systems biology, genetic association studies and, 554, 556–559
- Systems Biology Markup Language (SBML), 561
- T**
- targeted treatment, 21–22
- task performance, with nicotine deprivation, 436
- Taste/Sensory Processes subscale, 84
- taxon, nicotine dependence as, 93–94
- team sports, as protective factor, 343
- temperament-based model, 343–344
- test performance, definition of, 75
- test-retest reliability
 acoustic startle reflex, 446–447
 ad lib smoking, 415
 diagnostic tools, 81
 event-related potential, 429
 mood effects tests, 375
 nicotine-dependence measures, 26–27, 29
 prepulse inhibition startle response, 431
- thapsigargin, 167
- theta rhythm (slow-wave activity), 362
- TH* (tyrosine hydroxylase) gene, 198–199, 269
- threshold
 factor loading and, 275–276
 as “smoker,” 42
- time to first cigarette (TTFC)
 during adolescence, as indicator of adult nicotine dependence, 230–231
 correlations with, 90
 factor analysis of, 88–89
 nicotine metabolism association, 34
 as physical dependence measure, 79
 as quitting predictor, 80
- time to maximum tolerance, 162
- tissue levels of nicotine, *versus* plasma levels, 145
- Tobacco Craving Questionnaire, 440
- tobacco dependence, *versus* nicotine dependence, 75
- tobacco industry, 24
- tobacco policies, 7, 20
 effect on adolescent smoking, 193
 substance use policies and, 294–295
- tobacco settlement dollars, 4
- tobacco use. *See also* nicotine
 frequency of, 4, 21, 369–371, 413, 420
 history of, 27–28
 smoke compounds, 588
- Tobacco Use Supplement, U.S. Census Bureau' Current Population Survey (TUS-CPS), 487, 494, 498–500
- tolerance, 162–168
 genetic effects on, 146
 to repeated doses, 158
- Tolerance subscale, 90–91
- TPH* gene, 269
- trace fear conditioning, 435
- transcription factor CREB, 160–161, 422
- transcription factor Fosb, 161
- transcription levels, alterations in, 40
- transdisciplinary framework, 521
- Transdisciplinary Tobacco Use Research Center (TTURC), 89, 521, 526
- transitional endophenotypes, 107, 108, 200, 233
- translational validation, 172

TRPC7 gene, 43
 129T2/SvEmsJ mice, 431
 TTFC. *See* time to first cigarette
 TTURC (Transdisciplinary Tobacco Use Research Center), 89, 521, 526
 TUS-CPS (Tobacco Use Supplement, U.S. Census Bureau's Current Population Survey), 487, 494, 498–500
 twin studies. *See also specific study*
 adolescent smoking, 196, 259–262
 affective regulation, 446–447
 cross-substance concordance, 317, 319–320
 CYP2A6 effect, 40
 delay aversion, 351
 ecological momentary assessment, 527
 epigenetic regulation, 36
 equal environments assumption in, 516–517
 event-related potential, 428, 429
 extended family, 250–252, 262, 279, 280
 factor analysis, 88–89
 factor mixture models, 256
 genomic studies, 589
 heritability of dependence, 28–29, 86, 342, 406
 impulsivity, 451
 limitations of, 279–280
 multivariate, 252–253, 262–263
 P300 amplitude, 360
 prepulse inhibition startle response, 431
 resting EEG, 426
 smoking habits, 22, 24
 smoking initiation, 31
 structural equation modeling, 249–257
 substance-use comorbidity, 307–323, 324
 tobacco use history, 38–39
 working memory, 437
 two-factor structure, 81
 two-stage genetic models, initiation *versus* progression, 323
 tyrosine hydroxylase (*TH*) gene, 198–199, 269

U

univariate analysis, substance-use comorbidity, 322
 unmeasured genetic factors, 4, 511
 upregulation, of nicotinic receptors, 135, 144–145, 588
 U.S. Task Force on Community Preventive Services, 4

V

validity
 of developmental trajectory research, 234
 discriminative, 77
 predictive, 50, 90–91
 variables
 independent, 495–496, 498–499
 observable, 77
 ontologies to represent knowledge about, 558–559
 perturbations from, 554
 in structural equation modeling, 248
 variance
 in latent growth curve models, 254
 partitioning, 270, 280
 ventral tegmental area (VTA), 152–153, 588
 verapamil, 167, 168
 VET (Vietnam Era Twin) Registry, 263–264
 videotaped paradigms, 524
 Vietnam Era Twin (VET) Registry, 263–264
 vigilance, 432–434
 Virginia 30,000 Study, 262
 Virginia Twin Registry, 264, 269–279
 measures, 269–270
 methods, 270
 results, 270–276
 study conclusions, 276–279
 subjects, 269
 Virginia Twin Study of Adolescent Behavioral Development, 260
 visuospatial attention, 434
 VLMR LR (Vuong-Lo-Mendell-Rubin likelihood ratio) test, 310, 312
 VTA (ventral tegmental area), 152–153, 588
 vulnerability
 of adolescents, 343
 differences in, 22
 modeling, 363–364
 protective factors, 87, 114
 Vuong-Lo-Mendell-Rubin likelihood ratio (VLMR LR) test, 310, 312

W

Wald test, 544
 watershed model, 78–79, 81–82
 WCST (Wisconsin Card Sorting Test), 378, 436
 Wechsler Adult Intelligence Test-Revised, 433
 whole-environment scan, 530

- whole-genome association studies, 4
 - whole-genome linkage scans, 589
 - whole-genome quantitative transcript screening, 170
 - wild-type mice
 - conditioned place preference in, 159, 160, 161, 422
 - in CREB activation studies, 160
 - in nicotine reinforcement, 159
 - WinBUGS, 549
 - Wisconsin Card Sorting Test (WCST), 378, 436
 - Wisconsin Inventory of Smoking Dependence Motives (WISDM), 84–86, 85
 - as assessment tool, 405
 - subscales of, 90–93
 - Wistar rats, 425, 431, 449
 - withdrawal symptoms
 - in adolescents, 192, 194
 - cellular changes, 147
 - environmental influences in, 95
 - heritability of, 30
 - negative affect, 443
 - physical dependence inference from, 77
 - physiology of, 588
 - severity of, 97, 413, 447
 - support interval for, 40
 - within-class variability, estimation of, 220–221, 233
 - working memory, 434–438
 - World Health Organization, 80–81
 - World Mental Health Survey Initiative, 81
- X**
- XSEM (extended structural equation modeling), 249
- Z**
- zygosity, function of, in substance-use phenotypes, 316–317, 320

