



Naval Transformation Roadmap 2003

**Assured Access & Power Projection
...From The Sea**

(Page Intentionally Left Blank)

Foreword

Naval forces are unique in their contribution to the nation's defense. Versatile naval expeditionary forces are the nation's first responders, relied upon to establish the tempo of action, control the early phases of hostilities, and set conditions for decisive resolution. America's ability to protect its homeland, assure our friends and allies, deter potential adversaries, and project decisive combat power depends on maritime superiority. The transformation of naval forces is dedicated to greatly expanding the sovereign options available worldwide to the President across the full spectrum of warfare by exploiting our control of the sea. The result of our transformation will be a Navy -Marine Corps Team providing sustainable, immediately employable U.S. combat power as part of a transformed joint force ready to meet any challenge.

As directed in the Defense Secretary's *Transformation Planning Guidance*, the Department of the Navy presents its first annual update to the Naval Transformation Roadmap. Whereas the first roadmap submission in July 2002 described the framework for naval capability development, this roadmap update describes the key naval concepts, capabilities, initiatives, processes and programs that guide the efforts of the Navy-Marine Corps Team in support of the critical operational goals described in the 2001 Quadrennial Defense Review Report and the new joint operating and functional concepts currently being formulated.



Gordon R. England
Secretary of the Navy

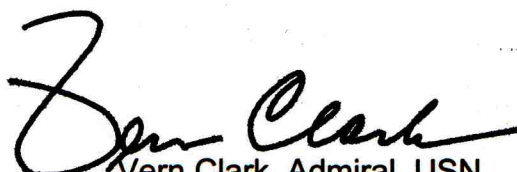

Vern Clark, Admiral, USN
Chief of Naval Operations

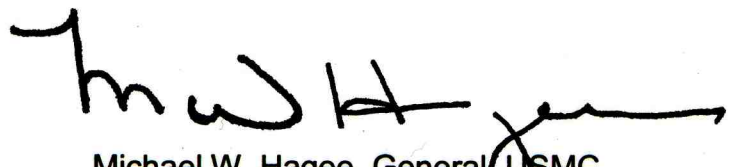

Michael W. Hagee, General USMC
Commandant of the Marine Corps

(Page Intentionally Left Blank)

Table of Contents

I. INTRODUCTION..... 1

II. TRANSFORMATION IN OPERATIONAL CONCEPTS—ENHANCED EMPLOYABILITY..... 8

 A. Global Concept of Operations 8

 B. Fleet Response Plan 9

 C. Flexible Deployment Concept 9

 D. Enhanced Networked Seabasing 10

 E. Streamlined MAGTF Scalability..... 10

 F. Maritime Contribution to Joint Forcible Entry Operations 10

III. TRANSFORMATIONAL CAPABILITIES 12

 A. Sea Shield 12

 1. Air and Missile Defense (AMD) 12

 2. Undersea Warfare (USW) 19

 a. Anti-Submarine Warfare (ASW)..... 19

 b. Mine Warfare (MIW) 26

 3. Anti-Surface Warfare (SUW) 31

 4. Force Protection 35

 B. Sea Strike..... 39

 1. Deliberate and Time-Sensitive Strike 40

 2. Ship-to-Objective Maneuver (STOM) 48

 C. Sea Base 56

 D. FORCEnet 63

 1. Networks 64

 2. Intelligence, Surveillance and Reconnaissance (ISR)..... 68

 3. Common Operational and Tactical Pictures (COTP)..... 74

IV. TRANSFORMATION PROCESSES 81

 A. People and Culture..... 82

 1. Sea Warrior 82

 2. Making Marines and MAGTFs..... 84

 B. Naval Support to Joint Concept Development and Experimentation 87

 C. Science and Technology 91

 D. Sea Enterprise 92

V. CONCLUSION 94

(Page Intentionally Left Blank)

I. INTRODUCTION

Naval transformation will support joint transformation by delivering new military capabilities and dramatically enhancing current capabilities to protect and advance America's worldwide interests by assuring access and projecting power from the sea. While the Navy – Marine Corps Team is expanding the entire array of naval capabilities we provide the Nation, our transformation is centered upon the development of Seabasing: the concepts and capabilities that exploit our command of the sea to project, protect, and sustain integrated warfighting capabilities from the maritime domain. Seabasing and the supporting tools we are developing will usher in dramatic new ways of employing naval forces to deter conflict and, when required, to wage war. Throughout, every aspect of naval transformation will be, first and foremost, committed to and built upon the principles of jointness. Seabasing will provide new naval capability options for use by Joint Force Commanders in innovative combinations with the transformed capabilities of the other Services and Agencies.

The transformation of America's naval forces is a continuous process, one that includes changes in the way we train, educate and employ our people; the way we organize and equip our warfighting formations; and the processes by which we distinguish and develop the naval capabilities that will be needed by future joint forces. This Naval Transformation Roadmap serves to identify the most significant of the enhanced naval capabilities we believe will be required by the nation, and captures many of the concrete steps we are taking to achieve them. It describes how naval forces will achieve the transformational warfighting capabilities needed to support the developing Joint Operating Concepts (JOCs) and the six critical operational goals described in the 2001 Quadrennial Defense Review (QDR). These naval capabilities are focused on projecting and sustaining forces in distant anti-access and area denial environments while protecting against our asymmetric vulnerabilities by exploiting our maritime superiority to protect and advance America's worldwide interests. Naval transformation also supports Sailors, Marines, civilians, and contractors through the modernization of naval personnel management systems. Throughout, our naval transformational process is intended to support the development of Department of Defense capabilities that are jointly integrated from inception, rather than being merely incorporated by future Joint Force Commanders under the pressure of emerging crises. The Navy – Marine Corps Team; with its two distinct Services, core competencies, and cultures; is proud to serve as a model for what can be achieved by different organizations working towards common ends.

Today's Navy - Marine Corps Team is transforming to exploit the emerging joint warfighting trends of increased speed, precision, shared awareness, persistence, and employability. These themes recur across the spectrum of naval capabilities. By increasing the speed of response of forward-deployed, prepositioned, and surge forces, we give military and National leadership more options earlier in a crisis or conflict. The shared awareness of elements distributed and employed across the battlespace gives warfighters a tremendous advantage in operational tempo. Precision weapons, battlespace knowledge from distributed sensors, joint networks, and precision navigation will generate new options for the

Joint Transformation Trends

- **Increased Speed**
- **Routine Precision**
- **Networked Awareness**
- **Distributed Sensors**
- **Greater Persistence**
- **Yielding Integrated Deployment, Employment, & Sustainment**

closer integration of combined arms at every level. Combined with the ability of naval forces to conduct operations for extended periods, these capabilities enable the comprehensive design of deployable, employable, and sustainable forces that matter, allowing the Joint Force Commander to exploit the discontinuous battlespace that characterizes modern warfare.

Naval Transformation...Seabasing

The Navy – Marine Corps Team’s transformation encompasses and integrates powerful extensions to current joint capabilities, as well as a range of innovative new capabilities. Seabasing is the overarching expression of our shared vision, incorporating the initiatives that will allow the joint force to fully exploit one of this nation’s asymmetric advantages - command of the sea. Seabasing, a national capability, is our overarching transformational operating concept for projecting and sustaining naval power and joint forces which assures joint access by leveraging the operational maneuver of sovereign, distributed, and networked forces operating globally from the sea. The sea base of the future will be an inherently maneuverable, scalable aggregation of distributed, networked platforms that enable the global power projection of offensive and defensive forces from the sea, and includes the ability to assemble, equip, project, support, and sustain those forces without reliance on land bases within the Joint Operations Area. Seabasing unites our capabilities for projecting offensive power, defensive power, command and control, mobility and sustainment around the world. It will enable commanders to generate high tempo operational maneuver by making use of the sea as a means of gaining advantage.

The inherent mobility, security, and flexibility of naval forces provide an effective counter to emerging military and political limitations to overseas access. Seabasing will maximize the ability of the naval elements of the joint force to conduct sustained, persistent combat operations from the maritime domain, minimize limitations imposed by reliance on overseas shore-based support, and enable the transformed joint force to exploit our Nation’s asymmetric advantage in the seaspace. Seabasing provides the dynamic access, speed of response, flexibility, and persistent sustainment capabilities necessary to execute combat operations ashore, exploiting the maneuver space provided by the sea to enable and conduct joint operations at a time and place of our choosing.

Naval Force Development

Naval force development is guided by our ever-evolving vision of future warfighting. Just as the Department of Defense’s transformation strategy is “hinged” upon the JOCs, enhanced naval capabilities are based on naval concepts that describe how the Navy - Marine Corps Team will operate as an integrated naval force from now through 2020 in a joint and multinational environment. Fusing the concepts, capabilities, and core competencies expressed in the Navy’s Service vision *Sea Power 21* and the Marine Corps’ capstone concept *Expeditionary Maneuver Warfare (EMW)*, the *Naval Operating Concept for Joint Operations (NOC)* provides overarching guidance for the development of future naval forces and the basis for incorporating new naval concepts within a broader joint context. It describes how the Navy - Marine Corps Team will operate across the full range of military operations in the near-, mid- and far-term. It also serves as the foundation for further naval participation in the iterative development of JOCs.

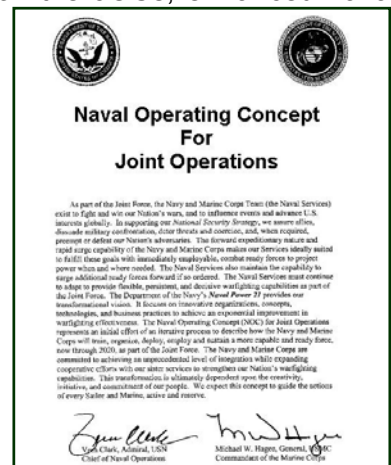

Naval Transformation Roadmap

The NOC is more than a significant step in the integration of the Navy and Marine Corps cultures and capabilities. It is a practical demonstration of the ability of different Services to integrate their force development processes by focusing on a common endstate, just as the Secretary of Defense requires in his *Transformation Planning Guidance*.

Documents including the JOCs, the NOC, and a variety of more focused concepts allow us to identify the capabilities that will be required to ensure that the joint force will succeed against a wide variety of threats. Ongoing efforts within the Department of Defense to identify and integrate Department of Defense capabilities will shape the transformation of the Department of the Navy, while the naval Services' active participation within those efforts will ensure a more robust and sound framework for future joint capabilities. As separate Services, the Navy and Marine Corps each then have distinct force development methods that allow us to maximize the value of the core competencies we bring to joint force development. The Navy's Naval Capability Development Process (NCDP) includes extensive participation by Navy and Marine Corps warfighters to identify, validate, and prioritize Navy capabilities required by the joint force, while the Marine Corps' Expeditionary Force Development System (EFDS) produces the capabilities defined in the singular EMW Capability List (ECL) for integration across the entire Marine Air-Ground Task Force (MAGTF). Far from being merely equal, however, the NCDP and EFDS are mutually supporting, with defined interconnections between the two.

These linkages begin with the shared vision expressed in the NOC. The Navy - Marine Corps Team then utilizes a common force development construct, the Naval Capability Pillars, to allow us to identify capabilities of common interest and joint importance. This common construct includes the dual identification of critical naval capabilities, such as Theater Air and Missile Defense (TAMD) and Ship-To-Objective Maneuver (STOM), for integrated development. The NCDP and EFDS provide for mutual participation in critical inputs, including naval experimentation and wargaming through the Sea Trial process, as well as naval science and technology investment via the Office of Naval Research. The processes also generate mission level capability metrics useful in addressing the six critical transformational goals and the JOCs. The production of a multi-Service *Naval Transformation Roadmap* itself helps focus Navy and Marine Corps planners and programmers, and serves as a common front end for subsequent budget cycles. The development of a selectively integrated naval force development system remains a work in progress, as we continue to determine the best methods for bringing our processes together and aligning them to the joint process while retaining our individual expertise in specific functions.

A series of Navy – Marine Corps capabilities to operationalize Seabasing are being developed through four interdependent and synergistic Naval Capability Pillars (NCPs). Condensed titles for broad groups of naval capabilities, **Sea Shield**, **Sea Strike**, and **Sea Base** summarize the naval tools that will help Joint Force Commanders produce and exploit a discontinuous battlespace within which distributed and sustainable surface, sub-surface, air, ground and space elements form a unified force that assures access and projects both offensive power and defensive capability.



These capabilities will come alive in the hands of 21st century Sailors and Marines enabled by **FORCEnet**, an emerging, integrated information technology backplane that combines state of the art sensors, networks, decision aids, weapons and supporting systems, integrated into a single comprehensive maritime command and control network. When combined with the

Naval Transformation Roadmap

capabilities of the other Services in accordance with a series of new joint concepts, these advanced naval concepts and capabilities will help create an integrated, multi-dimensional operational maneuver space. Within this maneuver space the Joint Force Commander will project power and protect joint forces from the most independent, exploitable, and secure portion of the battlespace -- the sea.

Sea Shield describes the capabilities that extend precise and persistent naval defensive capabilities not only throughout large maritime areas, but also deep overland to protect joint forces and allies ashore. Sea Shield will assist the joint force in operating effectively despite adversary efforts to deny theater access to U.S. forces. It will achieve these goals by exploiting global sea control to defeat enemy area denial threats including aircraft, missiles, small littoral surface combatants, mines, and submarines. Sea Shield helps assure allies, deter adversaries, and generate operational freedom of action for the projection of naval and joint power.

Sea Strike describes the naval capabilities to project dominant and decisive offensive power from the sea in support of joint objectives. These capabilities include and integrate long-range, precise aircraft and missile fires; large-volume covert strike capability; high-tempo decisive maneuver; Naval Surface Fire Support (NSFS); maritime special operations; and information operations to capitalize on the strategic agility, operational maneuverability, precise weapons employment, battlespace influence capabilities and persistent sustainment of naval forces. By providing full connectivity to, and the core of an early in-theater network backbone for a powerful grid of national, joint, and sea-based sensors, the immediately employable naval elements of the joint force will be able to degrade the enemy's ability to effectively command and control and offer an array of capabilities to strike or assault with speed measured in minutes, precision measured in a few meters, and volume of fire measured in many hundreds of fixed or mobile aimpoints struck per day.

Sea Base describes the capabilities that allow naval forces to exploit the maneuver space provided by U.S. control of the sea. It includes those capabilities that provide unimpeded mobility and persistent sustainment. Incorporating the complementary characteristics of amphibious, maritime prepositioning, and critical connecting platforms, Sea Base capabilities provide movement without the need for permission or infrastructure, and logistics without fixed and vulnerable stockpiles ashore. Sea Base capabilities will minimize limitations imposed by reliance on overseas shore-based support, maximize the ability of the naval elements of the joint force to conduct sustained, persistent combat operations from the maritime domain, and enable the transformed joint force to exploit our Nation's asymmetric advantage in the seaspace.

FORCEnet, as the integral naval component of the Department of Defense (DoD)-wide Internet Protocol-based advanced network, will provide the open architecture and building blocks that integrate sensors, networks, decision aids, weapons, warriors, and supporting systems into a highly adaptive, human-centric, comprehensive system that operates from seabed to space and from sea to land. By facilitating comprehensive battlespace awareness, it will support the attainment of dimensional superiority by geographically dispersed forces as they execute a wide variety of missions across the entire range of military operations. It is focused on accelerating the speed and accuracy of information gathering, assessment, decision and action at every level of command. FORCEnet includes assured access to networks and information through secure administration of networks and robust Computer Network Defense in Depth strategies.

Naval Capability Pillars and the Joint Operating Concepts (JOCs)

The naval capabilities produced across the interdependent and synergistic **Sea Shield**, **Sea Strike**, **Sea Base**, and **FORCENet** Naval Capability Pillars will support each of the developing JOCs. The Naval Capability Pillars are integrated to support the Deployment, Employment, and Sustainment continuum described especially in the *Major Combat Operations* (MCO) JOC. Specific capabilities such as **Sea Shield’s** layered Air and Missile Defense and Force Protection support the *Homeland Security* and *Strategic Deterrence* JOCs, while **Sea Strike’s** Deliberate and Time-Sensitive Strike and Ship-To-Objective Maneuver (STOM) provide the integrated fire and maneuver required by both MCO and *Strategic Deterrence*. **Sea Base** will be a critical enabler for the Force Projection required by the *Strategic Deterrence* JOC, and is especially useful in supporting the Focused Logistics and Joint Command and Control required for *Stability Operations*. **FORCENet** will provide the collaborative connectivity described by each of the JOCs, and enables each of the other Naval Capability Pillars. Figure 1 shows the applicability of each transformational naval capability to each of the JOCs.

		Major Combat Operations	Stability Operations	Strategic Deterrence	Homeland Security
Sea Shield	Air & Missile Defense	√		√	√
	Anti-Submarine Warfare	√			
	Mine Warfare	√	√		
	Anti-Surface Warfare	√	√		√
	Force Protection	√	√	√	√
Sea Strike	Deliberate & Time-Sensitive Strike	√	√	√	
	Ship to Objective Maneuver	√	√	√	
Sea Base		√	√	√	
FORCENet	Networks	√	√	√	√
	Intelligence, Surveillance & Reconnaissance	√	√	√	√
	Common Operational & Tactical Pictures	√	√	√	√

Figure 1: Contribution of Naval Transformational Initiatives to Joint Operational Concepts

Naval Capability Pillars and the QDR Six Critical Operational Goals

Naval transformation addresses the operational challenges cited in the 2001 Quadrennial Defense Review Report. Figure 2 shows the applicability of each of the capabilities to the QDR goals.

		Protecting Critical Bases of Operations	Protecting and Sustaining U.S. forces in Distant Anti-Access or Area Denial Environments and Defeating Anti-Access Threats	Denying Enemies Sanctuary Through Persistent Surveillance, Tracking, and Rapid Engagement With High-Volume Precision Strikes	Assuring Information Systems in the Face of Attack and Conducting Effective and Discriminate Offensive Information Operations	Enhancing the Capability and Survivability of Space Systems and Supporting Infrastructure	Leveraging Information Technology and Innovative Concepts to Develop an Interoperable, Joint C4ISR Architecture and Capability That Includes a Tailorable Joint Operational Picture
Sea Shield	Air & Missile Defense	♦♦	♦♦	♦			
	Anti-Submarine Warfare	♦♦	♦♦	♦			
	Mine Warfare	♦♦	♦♦	♦			
	Anti-Surface Warfare	♦♦	♦♦	♦			
	Force Protection	♦♦	♦♦	♦	♦	♦	
Sea Strike	Deliberate & Time-Sensitive Strike	♦	♦♦	♦♦	♦♦		
	Ship to Objective Maneuver	♦	♦♦	♦♦	♦		
Sea Base		♦	♦♦	♦			
FORCENet	Networks	♦	♦♦	♦	♦♦	♦♦	♦♦
	Intelligence, Surveillance & Reconnaissance	♦	♦♦	♦♦	♦	♦♦	♦♦
	Common Operational & Tactical Pictures	♦	♦♦	♦	♦	♦	♦♦
Legend: ** - Strongly Supports * - Supports							

Figure 2: Contribution of Naval Transformational Initiatives to QDR Objectives

Protecting critical bases. Sea Shield air and missile defense capabilities, enabled by FORCENet, and supported by precise, timely attack operations on enemy missile capabilities from Sea Strike, will play a major role in the protection of critical bases of operations from threats in all dimensions-- air, sea, undersea, ground, and cyber. Furthermore, the use of the mobile, protected, enhanced, networked sea-based forces will significantly reduce U.S. basing vulnerability.

Projecting and sustaining U.S. forces. Naval initiatives in Sea Strike, Sea Shield, and Sea Base supported by FORCENet, will enable joint forces to gain and maintain access to critical theaters of operation despite enemy anti-access or area denial efforts. Sea Base will provide a dynamic “platform” to project and sustain forces, while integrating strategic, operational, and tactical maneuver. The naval combat power projected includes Sea Strike’s offensive capabilities, Sea Shield’s defensive capabilities, and FORCENet’s early arriving battlespace awareness and decision superiority, all of which create an operational advantage for joint force exploitation.

Denying enemies sanctuary. The sustainable strategic agility, tactical flexibility, and operational reach of naval forces operating from the sea base will enable joint forces to locate and engage critical mobile and fixed targets with integrated combinations of complementary air and ground capabilities, at various ranges and in all weather and terrain. Sea Shield will protect the forward deployed force, increasing the on-station collection persistence of airborne, ground, surface ship, and subsurface sensors, both manned and unmanned. FORCENet will integrate and enhance the dynamic tasking, cross-cueing, and effectiveness of these sensors. FORCENet, in conjunction with enhanced Sea Strike capabilities, projected and coordinated

from the sea base, will enable high volume precision strikes, including fires, maneuver, and non-kinetic effects.

Assuring information systems. FORCEnet initiatives will provide a secure and robust architecture based on a defense-in-depth approach to operations in support of the joint commander, including intrusion detection and other measures to secure naval information networks against compromise. The use of distributed sensors, particularly those based at sea beyond the ready reach of the adversary, will provide both added redundancy and decreased vulnerability to capability/service interruptions. Sea Strike will employ offensive information operations to shape and control the enemy information environment and help enable the projection of precise military force.

Enhancing space systems. Transformational initiatives associated with the creation of FORCEnet will provide additional security to the sea-based and shore-based infrastructure through which the Navy - Marine Corps Team ties into and exploits the national space architecture. Forward, operational-level joint command and control provided through the sea base will also enable the projection of offensive fires and maneuver within denied areas. These offensive capabilities can be used to deny an enemy's ability to exploit space.

Leveraging Information Technology. FORCEnet efforts will include the development of a common operational and tactical picture (COTP), based on a combination of information from naval assets, national assets, and other Service, joint and coalition assets available in the battlespace. As the provider of forward, sea-based command and control for the Joint force, these naval capabilities will sometimes provide the COTP, and in other cases, provide relevant, appropriately formatted data inputs that supports the presentation of the COTP by another lead element of the Joint force.

At its core, transformation is based on a willingness to constantly challenge old thinking and introduce new concepts. Most important are the processes that are put in place to institutionalize a culture that promotes and rewards the introduction of new concepts and thinking. Guided by the JOCs and NOC, and framed by the Naval Capability Pillars of Sea Shield, Sea Strike, Sea Base and FORCEnet, naval transformation will utilize new organizational constructs and operational schemes that challenge the deployment and employment models that have governed the operations of naval forces for years. The Navy and Marine Corps are working synergistically to develop the capabilities called for by the NOC, which we believe will be consistent with those called for in the JOCs once approved. The remainder of this document describes these aspects of transformation.

II. TRANSFORMATION IN OPERATIONAL CONCEPTS—ENHANCED EMPLOYABILITY

“Our security will require transforming the military...a military that must be ready to strike at a moment’s notice in any dark corner of the world.”

President George W. Bush, 01 June 2002

The demands of the Global War on Terrorism have underscored the need for forces that can quickly be deployed to any “dark corner of the world,” and arrive ready for the entire range of combat operations. The forward expeditionary nature and rapid surge capability of the Navy - Marine Corps Team combine to make our Services ideally suited to meet these challenges by providing combat-ready forces nearly anywhere in the world, by projecting decisive power with sea-based forces, and by enabling the rapid arrival of transformed combat-ready forces from other Services and Agencies.

We are transforming the methods by which we organize and train, deploy, and employ naval forces to enhance our ability to rapidly transition across the continuum from peacetime deterrence operations to major combat operations. The Global

- **Organized to Meet New Requirements**
- **Increased Employability**
- **Enhanced Networked Seabasing**
- **Seamless Scalability**
- **Joint Forcible Entry Operations**

Concept of Operations was developed to guide our planning to distribute naval striking power simultaneously to a greater number of locations, deterring aggression, providing immediate response, and setting conditions for the rapid deployment of additional forces. A number of innovative initiatives are being developed to increase the employability of the various elements of the naval force. Seamless Scalability of our Marine Air-Ground Task Forces (MAGTFs) will allow us to more rapidly close and combine additional forces, increasing operational tempo and seizing early opportunities for Joint Force Commanders. Interwoven combinations of transformed forward-deployed, pre-positioned, and surge capabilities will support Joint Forcible Entry Operations by leveraging the speed and mobility gained by our control of the maritime domain.

A. Global Concept of Operations

The Navy and Marine Corps met the challenges of the Cold War by deploying in Carrier Battle Groups and Amphibious Ready Groups, which carry Marine Expeditionary Units (Special Operations Capable), both supported by the Combat Logistics Force and supplemented by the Maritime Prepositioning Force (MPF). Now we are transforming that force to meet the challenges of the Global War on Terrorism by implementing a new Global Concept of Operations.

To support the forward deterrent and rapid response requirements of today and tomorrow, new organizational constructs such as the Carrier Strike Group (CSG) and Expeditionary Strike Group (ESG) are being instituted as key components of the global integrated naval force. Organizing naval deployments around ESGs and CSGs will increase the number of independently employable naval strike groups that provide Regional Combatant Commanders with greater operational freedom and scalable joint response options. In the far term, forward naval operating forces will be organized into an Expeditionary Strike Force (ESF), elements of

which will train together to ensure readiness for a wide range of contingencies. The ESF will consist of CSGs, ESGs, and Maritime Prepositioning Groups (MPGs). The ESF can be enhanced with the introduction of forcible entry-capable Marine Expeditionary Brigades in combination with in-theater assets. The ESF will bring complementary capabilities to Air Force Air and Space Expeditionary Task Forces, Army Future Forces, and Joint Special Operations Forces for integrated joint operations across the spectrum of conflict.

B. Fleet Response Plan

The requirement to be able to swiftly defeat aggression in overlapping conflicts called for in the 2001 QDR has necessitated a focus on developing new surge capabilities to complement and capitalize on our current competency in providing immediately employable forward-deployed naval forces. The recently created Fleet Response Plan (FRP) will significantly increase the rate at which we can augment deployed forces as contingencies require. Under the regular rotation approach, the training, manning, maintenance, and readiness funding practices of the Inter-Deployment Readiness Cycle (IDRC) were optimized to meet the requirements of Global Naval Forward Presence Policy. While a modest number of forward deployed units were at peak readiness, the majority of ships and associated units were not deployed and thus at a point in their IDRC that made it difficult and expensive to swiftly "surge" to a crisis, conflict or for Homeland Defense.

The FRP features a change in readiness posture that institutionalizes an enhanced surge capability for the Navy. Under the guidance of Commander Fleet Forces Command (CFFC), a revised IDRC is being developed that meets the demand for a more responsive force. With refined maintenance, modernization, manning and training processes, as well as fully-funded readiness accounts, the Fleet can consistently sustain a level of at least 6 surge-capable carrier strike groups, with two additional strike groups able to deploy within approximately 90 days of an emergency order. In parallel with this, the Naval Reserve Force is embarked on a fully integrated active-reserve transformation to a more flexible unit structure. Part of this transformation is focused on providing a rapid surge capability of skilled aviators who have trained with active-duty units to reinforce them and rapidly boost their ability to generate combat sorties.

C. Flexible Deployment Concept

The enhanced and expanded readiness availability delivered by the Fleet Response Plan provides the President with unprecedented responsiveness. Instead of predictable, lock-step, 6-month deployments to pre-determined regions in support of the Global Naval Forward Presence Policy, the Flexible Deployment Concept allows units that have attained high readiness to embark on deployments of varied duration in support of specific national priorities such as Homeland Defense, multi-national exercises, security cooperation events, deterrent operations, or prosecution of the Global War on Terrorism...often in multi-Carrier Strike Group formations. These deployments provide "presence with a purpose" and can also occur in less predictable patterns, thereby forcing potential adversaries to adjust to our operational timelines. The sustained readiness created via the Fleet Response Plan will enable the Flexible Deployment Concept.

Flexible Deployment Concept implementation will occur under the emerging Joint Presence Policy. Naval implementation of these new presence requirements will be carefully monitored to ensure that schedules and OPTEMPO standards are adhered to so that our unprecedented force levels will not result in uncertainties for our sailors or allies.

D. Enhanced Networked Seabasing

The recent Navy-Marine Corps concept for *Enhanced Networked Seabasing* (ENS), a subordinate operating concept that supports the NOC, provides a vision for how the naval Services will use more employable naval forces to provide Joint Force Commanders (JFCs) with the ability to project and sustain multi-dimensional power from the sea. Recognizing that the declining number of overseas bases, and the uncertain degree of future of host nation support, ENS exploits the strategic, operational, and tactical mobility available to those who control the sea. More than just a collection of platforms, it is a new way of projecting, employing, and sustaining expeditionary naval forces to support and enhance the enduring missions of the naval Services: sea control, deterrence, forward presence, and power projection. ENS provides a “place” for increasingly employable naval forces to surge “to”, whether they are supporting theater security cooperation efforts and the demands of the Global War on Terror or conducting Major Combat Operations. The sea base will integrate: Joint Command and Control capabilities; Expeditionary Strike Groups, Marine Expeditionary Brigades, Carrier Strike Groups, Maritime Prepositioning Forces, Combat Logistics Forces; and emerging high-speed sealift and lighterage technologies. Reflecting the synergy achieved through the use of combined arms, ENS will concentrate the many technical improvements in naval warfighting systems and networked naval forces – both current and future. *Enhanced Networked Seabasing* enables forward deterrence and assures access from the sea for the joint force without dependence on static land bases, ports or airfields in the Joint Operations Area (JOA). Like the NOC, ENS also demonstrates the ability of the Navy – Marine Corps Team to develop and pursue a common vision that enables and exploits the capabilities being developed by the other Services and Agencies.

E. Streamlined MAGTF Scalability

Recent operations including ENDURING FREEDOM and IRAQI FREEDOM reaffirmed the scalability and tailorability of our MAGTFs. The ability to rapidly combine Marine forces from around the world under a single commander provides joint warfighters with a powerful operational advantage, one that enables the potential of other joint capabilities. As the Navy – Marine Corps Team pursues innovative methods such as Seabasing to support the JOCs, however, we are working to speed the seamless blending of Marine Corps units from around the globe as crises demand. The ability to more rapidly fuse MAGTFs from in-and out-of theater along with integrated naval tactical aviation and other elements of the flow-in echelon to support our single battle concept will require careful consideration of our MAGTF training and readiness cycles. The experimentation campaign SEA VIKING 04 is being developed in part to help support key decisions and strategies to support this goal. Along with the Navy’s transformation in the operational availability of our ESGs and CSGs, streamlined scalability of our MAGTFs will provide Joint Force Commanders with superior strategic agility by more rapidly and effectively integrating forward-deployed, pre-positioned, and surge forces.

F. Maritime Contribution to Joint Forcible Entry Operations

Building on the Global Concept of Operations, the Fleet Response Plan, and the Flexible Deployment and *Enhanced Networked Seabasing* concepts, maritime Joint Forcible Entry Operations (JFEO) forces provide flexible and adaptable warfighting capabilities, staying power, and self-sufficiency that are uniquely tailored for creating opportunities for early-entry capabilities of other joint and coalition forces. The capabilities required to execute Forcible Entry – providing strategic agility, operational reach, and tactical flexibility- will also allow new methods for conducting a wide range of operations across the spectrum of conflict. In addition,

the utilization of naval forces in these types of contingencies enables a compressed timeline for planning and movement.

The naval concepts for maritime JFEO support parallel—vice sequential—execution of all phases of forcible entry with a shortened time of response. They provide for the simultaneous defeat of a multi-dimensional threat without in-theater host nation support. These concepts enable a rapid, scalable, pre-emptive Joint Forcible Entry capability, tailored to the threat and mission. By the 2015 time frame, naval forces employing ESGs, CSGs, Amphibious Forces, and MPF(Future)-equipped MPGs will provide the sea-based assets required to ensure dominance across the joint operating area, and compress the timeline for assembling a MEB to 7-14 days. This concept will transform naval forces' ability to conduct forcible entry and will preclude the adversary's integration of his anti-access capabilities against joint and coalition efforts.

III. TRANSFORMATIONAL CAPABILITIES

The Navy and Marine Corps are working in a synergistic fashion to transform the capabilities in each of the Naval Operational Concept's Naval Capability Pillars: Sea Shield, Sea Strike, Sea Base, and FORCEnet.

A. Sea Shield

The Navy – Marine Corps Team will provide the naval defensive capabilities that will enable the joint force to operate effectively despite adversary efforts to deny theater access to U.S. forces. Sea Shield will extend precise and persistent naval defensive capabilities not only throughout large maritime areas, but also deep overland to protect joint forces and allies ashore. We will achieve these goals by exploiting global sea control to defeat enemy area denial/anti-access threats including aircraft, missiles, small littoral surface combatants, mines, and submarines; as well as terrorist and asymmetric threats, both in CONUS and abroad. The sections that follow discuss transformational concepts and capabilities being pursued within the Sea Shield mission capability areas of air and missile defense, undersea warfare, anti-surface warfare, and force protection. .

- **Assure Access for the Joint Force**
- **Project Defense Around Friends & Joint Forces at Sea & Ashore**
- **Provide a Sea-Based Layer of Homeland Defense**

1. Air and Missile Defense (AMD)

Key Elements of Transformational Improvements in Air and Missile Defense. Transformational efforts in air and missile defense focus on two areas: the initial deployment of sea-based ballistic missile defense capability, and dramatically improved and integrated air and cruise missile defenses. Efforts in ballistic missile defense will provide a completely new sea-based capability. This transformational capability will greatly expand the options of the Joint Force Commander for protecting forward-deployed U.S. and coalition forces as well as key host nation targets from missile-borne chemical, biological, radiological, nuclear, and high-explosive (CBRNE) weapons, while also supporting homeland defense ballistic missile defense operations. Naval air defense efforts will provide the existing sea-based system with far greater capabilities against a broader range of targets and under a wider spectrum of circumstances by integrating both Navy and Marine Corps systems to extend protection to naval, joint, and coalition forces at sea and ashore. Together, these capabilities will enable projection from the sea of a highly effective air and missile defense umbrella that reaches over the horizon and deep inland, extends from ground level to the exo-atmosphere, and defends against multiple types of aircraft, ballistic and cruise missile threats.

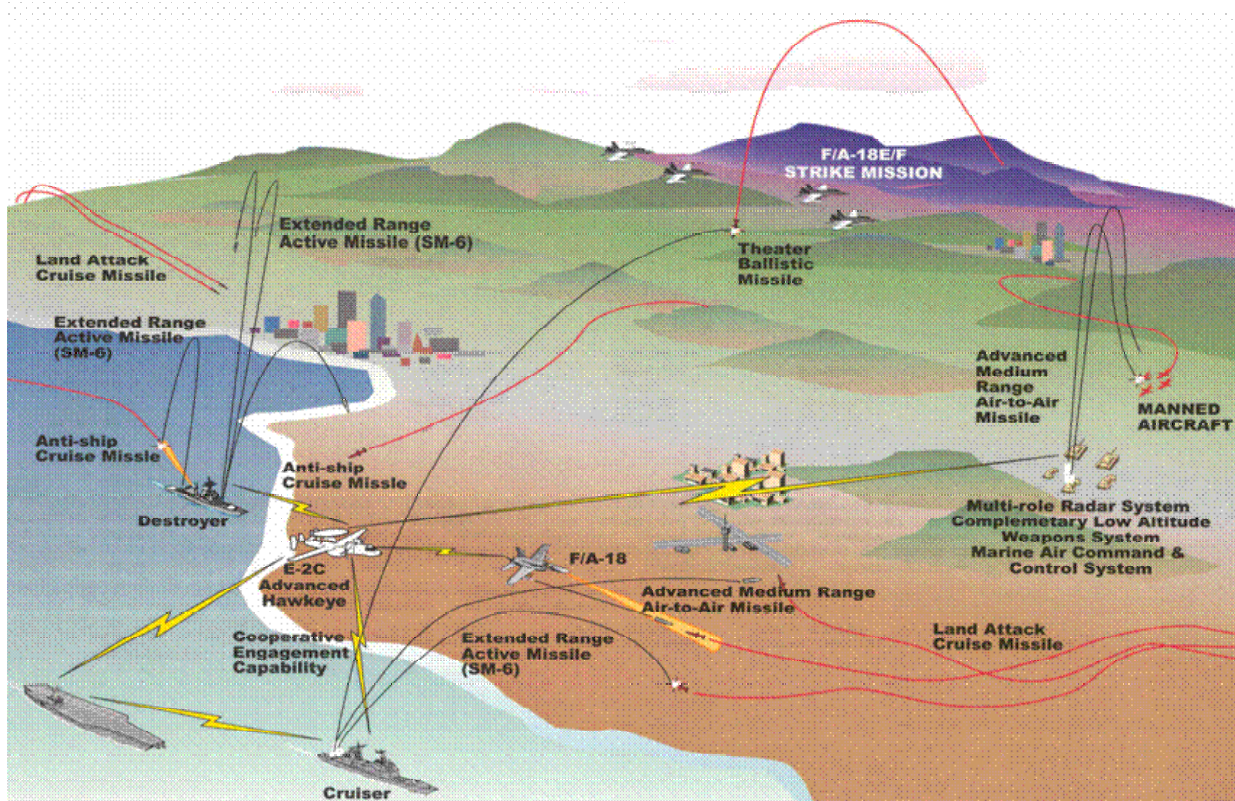

Figure 3: Naval Air and Missile Defense Concept of Operations

AMD Transformational Concepts and Capabilities—Near- and Mid-Term (2005-2015).

Theater Air and Missile Defense (TAMD), the ability to shoot down hostile aircraft and cruise missiles, will be based upon the participation of U.S., allied and coalition air defense elements at sea and ashore to effect improved defensive response times, more rapid and effective sensor-weapon-target pairings, and long-range engagement of threats. The Navy's Cooperative Engagement Capability (CEC) and the Marine Corps' CEC-based Composite Tracking Network (CTN), including a new "backbone" of joint common tracking algorithms, will fuse radar data across the battleforce, creating a common network of sensors and weapons that extends the naval air defense capability over sea and shore. These advances will also reduce requirements for airborne Defensive Counter Air (DCA) patrols, thus freeing sorties for offensive operations, enhancing naval platforms' ability to deliver precise offensive effects.

The AEGIS mid-course intercept BMD system, slated for deployment at the end of the decade, is designed to destroy theater-range ballistic missile re-entry vehicles while they are moving through the exo-atmosphere. AEGIS BMD-capable ships will be linked to a network of airborne, space- and land-based sensors and directed by a highly responsive command and control system. Leveraging the inherent ability of naval forces to operate with sovereignty in international waters, these ships will provide detection, command and control, and engagement capability throughout the battle-space against theater-range ballistic missiles. In the near term, AEGIS combatants, deployed in the right place at the right time, will also provide early surveillance and track data on longer-range ballistic missiles that endanger the United States to

the Ballistic Missile Defense System (BMDS) for potential engagement by ground-based, mid-course interceptors.

The Navy - Marine Corps Team is working with the Missile Defense Agency (MDA), which assumed responsibility for development of all ballistic missile defenses in January 2002, to develop and field a ballistic missile defense system (BMDS) for protection of the U.S. homeland by 2004. The objective of this system, which is being developed in accordance with National Security Presidential Directive 23 (NSPD-23), signed by President Bush in November 2002, is to protect the United States and her allies from the threat of long-range ballistic missiles. The Navy is working with the MDA to accelerate deployment of the sea-based element of this capability as part of the Initial Defensive Operations (IDO) capability in October 2004.

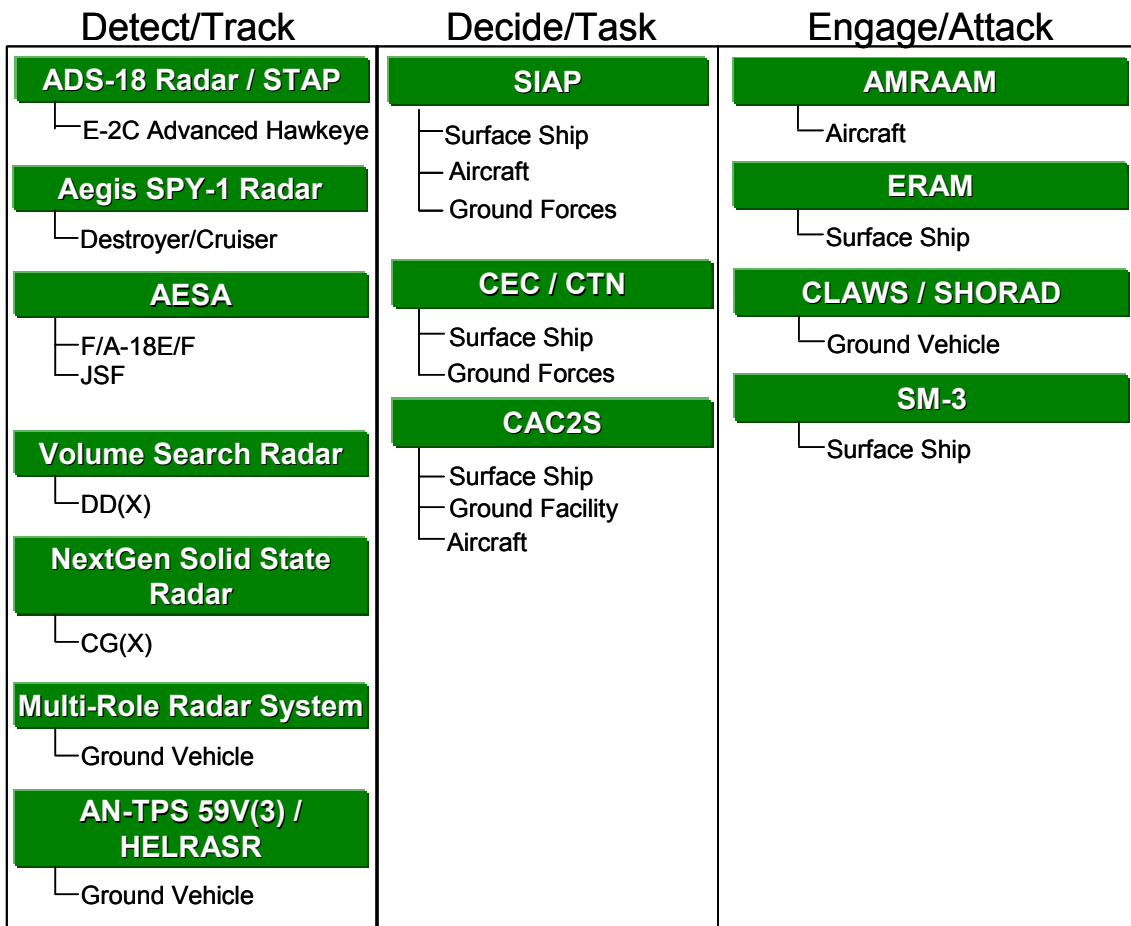

Figure 4: Key Elements of AMD Transformation

The Navy and MDA are working together to provide engagement solutions against ballistic missiles at a variety of altitudes and phases of flight—including a sea-based system, which is designed to intercept longer-range missiles while they are in midcourse flight. Progress in this effort—recently re-named the AEGIS Ballistic Missile Defense System—has included a series of test flights in which a missile launched by a Navy cruiser at sea hit its targets on three out of four occasions. With respect to lower-altitude, endo-atmospheric ballistic missile intercepts, MDA is currently planning a series of experiments, beginning in 2003, to assess sea-based

terminal BMD solutions, as part of a range of alternative means to fulfill this mission requirement.

The Navy, in conjunction with the Joint Staff and MDA, is also exploring a sea-based terminal missile defense capability. It is currently conducting a study of the requirements and options to develop a capability to defend American and allied forces in areas requiring a protected footprint against TBMs, particularly where land-based TBMD options are restricted. It is anticipated that the study will be followed by creation of a roadmap for developing the sea-based terminal defense capability through the integration of existing technology and future capabilities, as they become available.

Figure 4 lists key Navy-Marine Corps elements of the engagement cycle for providing transformational capabilities in air and missile defense.

Detect/Track. In addition to incorporating joint and national air and missile defense capabilities, the Navy and Marine Corps are working toward a transformational capability to detect and track threat aircraft and cruise missiles at significantly longer ranges using integrated airborne, sea-based and land-based sensors. While part of this capability derives from new sensors and platforms, much of the synergy in detection and tracking accrues from the ability to share and leverage sensor data through a Single Integrated Air Picture (SIAP), which is made possible by extensive sensor networking. Joint development and acquisition of other systems, joint development and implementation of new tactics, techniques and procedures that take advantage of the newest technologies, and joint training on these new technologies will speed transformation and ensure its long-term success.

As part of Naval Integrated Fire Control – Counter Air (NIFC-CA), the E-2C Advanced Hawkeye (AHE), equipped with an ADS-18 radar and Space-Time Adaptive Processor (STAP), will significantly improve our ability to detect and track air and cruise missile threats in difficult overland and littoral environments. Cueing from the E-2C AHE will improve the detection and tracking capability of the Active Electronically Scanned Array (AESA) radar, installed in the F/A-18E/F fighter and the Joint Strike Fighter. In recognition of the important contribution of the E-2C Advanced Hawkeye, the Navy is examining adding in-flight refueling to the E-2C to increase the persistence of its surveillance capability and remove the potential need for performing handovers during critical stages of an engagement. Through CEC and CTN, the AHE radar data will be fused with other naval force air surveillance sensors such as the next-generation AEGIS SPY radar, VSR on the DD(X), the new CG(X) solid-state radar, and USMC Multi-Role Radar System (MRRS) to create a SIAP.

The MRRS is designed to be the first land-based sensor ashore. The High mobility Multi-Wheeled Vehicle (HMMWV) mounted radar will possess the mobility required to keep pace with supported maneuver elements to fill gaps in naval Air and Missile Defense coverage created by extended littoral operations. The MRRS is transportable by CH-53 or MV-22. It will provide cueing information for the Complementary Low Altitude Weapons System (CLAWS), Stinger MANPADS and Avenger. The radar will provide detection and tracking of small radar cross-section cruise missiles and Unmanned Aerial Vehicles.

The Marine Corps AN/TPS-59 (V) 3 long range air surveillance radar tracks theater ballistic missiles and calculates their launch points and impact points and forwards this information to joint command centers and weapon systems. The AN/TPS-59 (V) 3 will be replaced by the Highly Expeditionary Long Range Air Surveillance Radar (HELRASR), which will provide air surveillance of TBMs with increased of battlefield mobility compared to the AN/TPS-59 (V) 3.

Naval Transformation Roadmap

The Common Aviation Command and Control System (CAC2S) will provide real-time shared awareness of the joint battlespace and provide commanders and weapons controllers with intuitive decision aids. The ultimate advantage of CAC2S is its expeditionary packaging and modular application that allows commanders the flexibility to employ CAC2S from the sea base, ashore, and aboard airborne platforms. The shared awareness of the enemy, friendly and non-combatant situation, coupled with decision aids and collaboration tools, will increase the speed of command and decision making in a time competitive environment.

The AEGIS SPY-1 radar will serve as the foundation of the Navy's ability to detect and track ballistic missile threats. In the near term, planned upgrades to this radar will enhance its detection and discrimination capabilities for effectively performing the BMD mission. Over the longer term, the advanced solid-state radar to be deployed with CG(X) will provide even greater power, sensitivity and discrimination to enable sea-based detection and tracking to keep pace with the evolving ballistic missile threat.

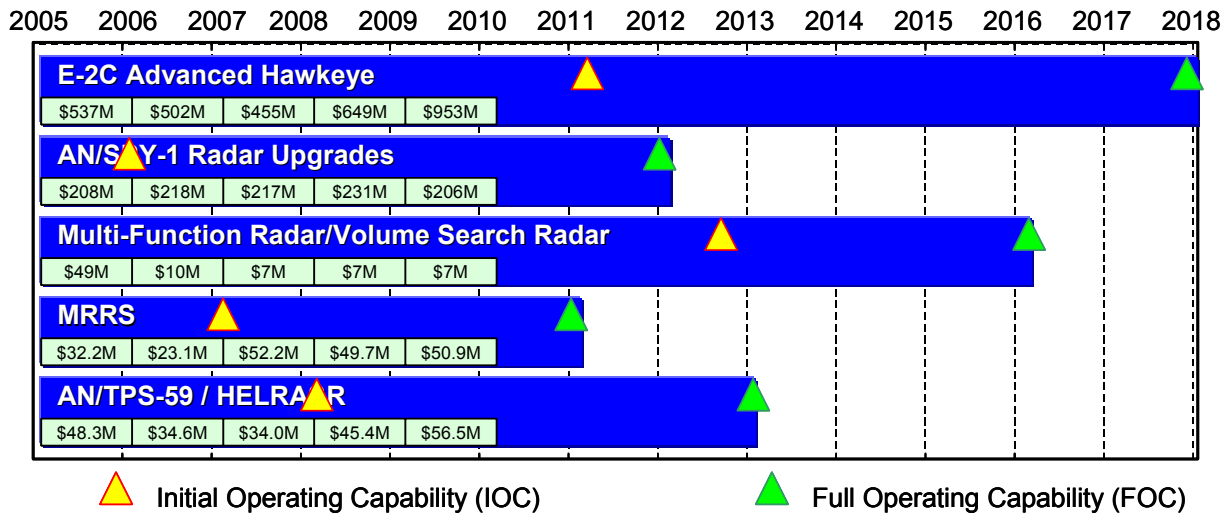

Figure 5: Programs Supporting Transformation of AMD Detect/Track

Decide/Task/Relay. The networking of sensors, command and control elements, attack platforms, and weapons to share information in real time to increase the speed of command and decision making will be realized through upgrades to CEC/CTN and the fielding of the SIAP. Advanced BMD command and control systems are being developed for joint theater and homeland defense by the MDA. CAC2S will provide real-time shared awareness of the joint battlespace and provide commanders and weapons controllers with intuitive decision aids. The ultimate advantage of CAC2S is its expeditionary packaging and modular application that allows commanders the flexibility to employ CAC2S from the sea base, ashore, and aboard airborne platforms.

The Office of Naval Research is sponsoring the Advanced Multifunction Radio Frequency Concept to investigate the feasibility of developing a system with a common set of radio frequency apertures whose function would be determined by software. This system could integrate and simultaneously support multiple beams for radar, electronic warfare (EW) and communications functions. Replacing legacy disparate radar, EW and communications system would have significant impact on the physical design of ships allowing them to be made more

Naval Transformation Roadmap

stealthy and efficient, and would reduce the number of independent logistic support chains needed for sustainment of the systems.

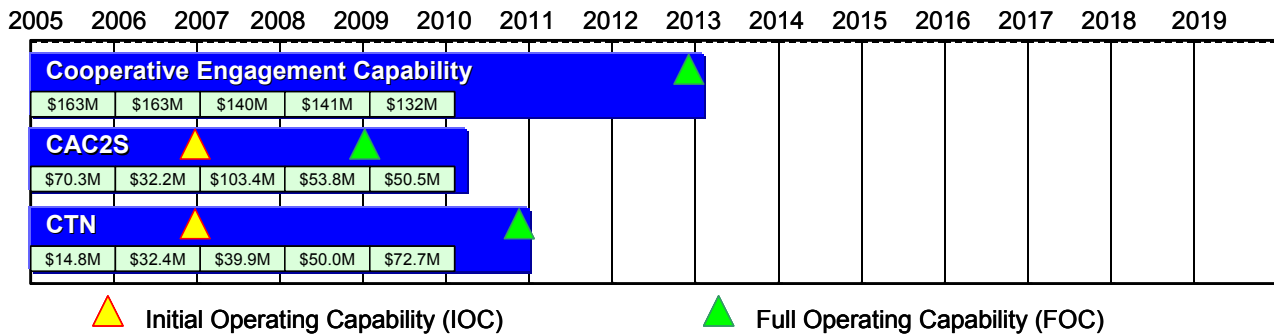

Figure 6: Programs Supporting Transformation of AMD Decide/Task/Relay

Engage/Attack/Assess. In the near-to-mid term, naval initiatives will provide a number of new weapons and platforms for engaging air targets from the air, from the sea, and from ground-based platforms.

Air-to air engagements will be conducted by an upgraded version of the Advanced Medium-Range Air-to-Air Missile (AMRAAM). A pre-planned product improvement (P3I) to AMRAAM will provide the missile with improved kinematics, as well as GPS and enhanced data-link capabilities.

New naval aircraft such as the stealthy Joint Strike Fighter (JSF) will increase our ability to provide air defense at extended ranges and over extended durations. JSF will also include software systems that enable the aircraft to participate as both sensors and shooters in the new integrated air defense. Similarly, upgrades to the weapons control systems for F/A-18 will enable these aircraft to fully support collaborative air defense engagements.

In addition to air defense from aviation platforms, the Navy is developing a new surface-to-air missile, the ship-launched Extended Range Anti-Air Missile (ERAM). In the future Joint Integrated Fire Control Architecture, this new ship-launched missile will be fully capable of conducting over-the-horizon engagements to its maximum kinematic range against manned/ and unmanned aircraft, cruise missiles flying over the land and the sea, and short range TBMs.

The Marine Corps' CLAWS integration within the NIFC-CA architecture allows for engagements of cruise missile threats attacking deployed ground forces and assets ashore via netted and shared E2-C sensor data. When deployed ashore, CLAWS extends the battlespace by providing the joint force additional overland cruise missile defense capability. CLAWS, provides the speed and flexibility required for enhanced air defense capabilities in the execution of Expeditionary Maneuver Warfare.

Naval Transformation Roadmap

For BMD, the achievement of an engagement capability is focused on the development of a hit-to-kill warhead for the SM-3 missile. This weapon will be utilized to intercept theater class ballistic missiles while they are in the exo-atmosphere and will utilize AEGIS Weapon System data integrated into the BMDS. Progress in this effort, recently re-named the AEGIS Ballistic Missile Defense System, has included a series of test flights in which a missile launched by a Navy cruiser at sea hit its target on three out of four occasions.

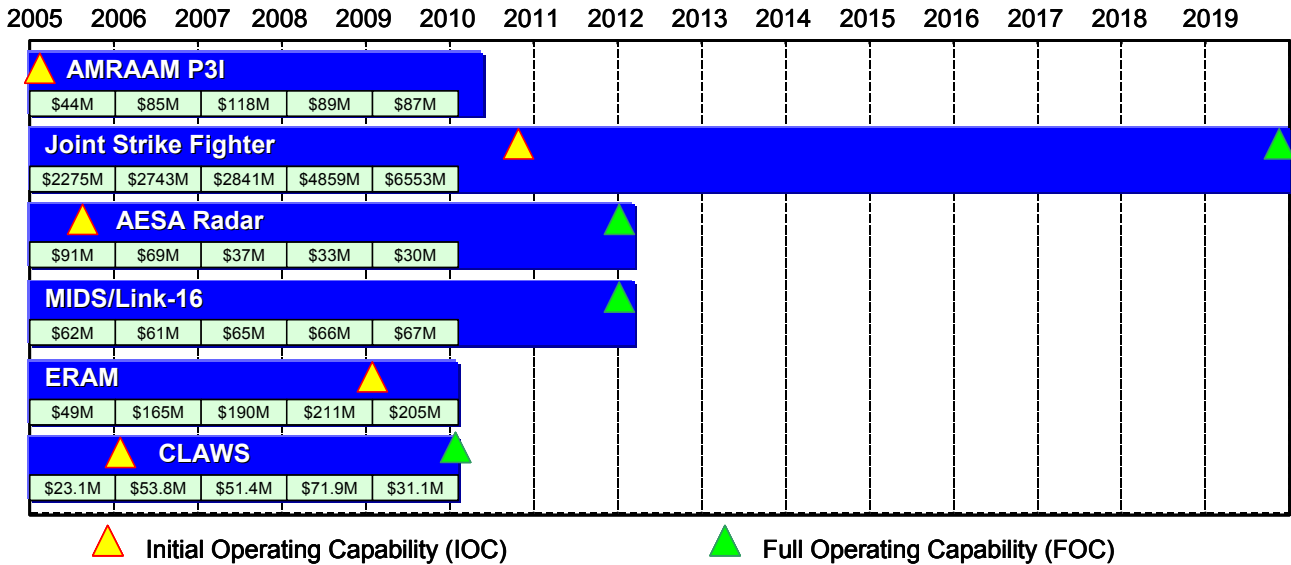

Figure 7: Programs Supporting Transformation of AMD Engage/Attack/Assess

AMD Transformational Concepts and Capabilities – Long-Term (Beyond 2015).

Advancements in TAMD beyond 2015 will be realized with improved data-links, sensor networking, use of unmanned vehicles to provide sensor or weapons capabilities, and next generation weapons such as hypersonic and directed energy weapons that will significantly improve defense against high-speed/high-G maneuvering threats.

All forms of "survival" and "planning" information, including sensor data, historical archives, automated decisions, battle management, will flow through and be supported by Global Information Grid Enterprise Services (GIG-ES). The architecture will be based on a "post before process" approach, allowing real-time data to support a Common Operating Picture using information processes to reach decisions and take action before windows of opportunity close or before joint forces are otherwise placed in harm's way.

In BMD, the Navy will work with the MDA to explore the potential to intercept ballistic missiles in the boost phase from a sea-based platform, based on the development of an interceptor missile with sufficient acceleration, tracking and high-g turning capability to hit the threat missile in the limited, boost-phase time window. This attractive missile defense option would exploit the synergies between new technologies enabling such intercepts, and the unique ability of naval forces to position shooters close enough to ballistic missile launch sites to enable an intercept while the missile is still in its boost phase.

Support from other Services and Agencies. The following support from other Services and Agencies will be required to enable delivery of the transformational capability in AMD:

- Continued support from the MDA for exploration and development of sea-based missile defense options
- Timely ballistic missile launch detection and tracking data from space-based infrared systems (SBIRS) and land-based tracking radars
- Compatible sensor measurement data from other Services to support the SIAP and collaborative engagement of overland targets in support of ground forces
- Seamless integration of AMD weapons and sensors throughout the joint battlespace, to allow multilateral sensing and engagement
- Compatible, persistent, communication relays, such as UAVs and satellite communications systems, provided by the other Services and Agencies

Metrics. Progress toward a transformational capability in air and missile defense will be measured in terms of the achievement of capabilities. Mission area capability metrics are listed in a separate appendix.

Advances in ballistic missile defense will be measured against the BMD experimentation plan and the associated two-year capability blocks defined by the MDA.

Planned AMD Sea Trial Activities. The Missile Defense Future Naval Capability (FNC) program addresses gaps in Navy and Marine Corps overland AMD capability. Missile Defense FNC projects are focused on technology enabling engagements of stealthy cruise missiles, UAVs and manned aircraft at extended ranges in defense of forces ashore and afloat, and other protected assets in littoral theaters. Projects include an advanced radar for the Marine Corps MRRS, battle management algorithms for integration of ISR data with real-time tracks, combat identification, efficient and effective force-wide use of weapons, and Science and Technology (S&T) planning effort for the Fiscal Year 2007-2008 (FY07-08) ADSAM demonstration in support of the transformational NIFC-CA capability.

Over the next several years, the Navy will be conducting a number of concept studies and field experiments and carrying out operational prototyping of key technologies and systems to support the development of the capabilities discussed in the previous sections. Some of these activities include:

- Composite Combat Identification (CCID) demonstrations in FY04 and FY06
- A live fire Air Directed Surface to Air Missile (ADSAM) capability demo at White Sands Missile Range in FY07-08.

2. Undersea Warfare (USW)

The Navy is pursuing transformational capability improvements in two domains of undersea warfare: anti-submarine warfare and mine warfare.

a. Anti-Submarine Warfare (ASW)

Key elements of transformational capability in ASW:

Transformational efforts in Anti-Submarine Warfare (ASW) are focused on gaining maritime superiority by rapidly finding, destroying or, where necessary, avoiding enemy submarines, thus rendering the submarine irrelevant as an anti-access weapon against U.S. and coalition naval forces and sealift capabilities. The underlying FUTURE ASW WARFIGHTING VISION, focuses

Naval Transformation Roadmap

on capabilities in three functional areas: (1) the ability to form a “Protected Passage” of the sea-lines-of-communications (SLOCs) and to protect forces during transits, (2) the maintenance of a “Maritime Shield” that would deny submarine access to operating areas, and (3) the ability to “Hold at Risk” enemy submarines throughout the maritime theater.

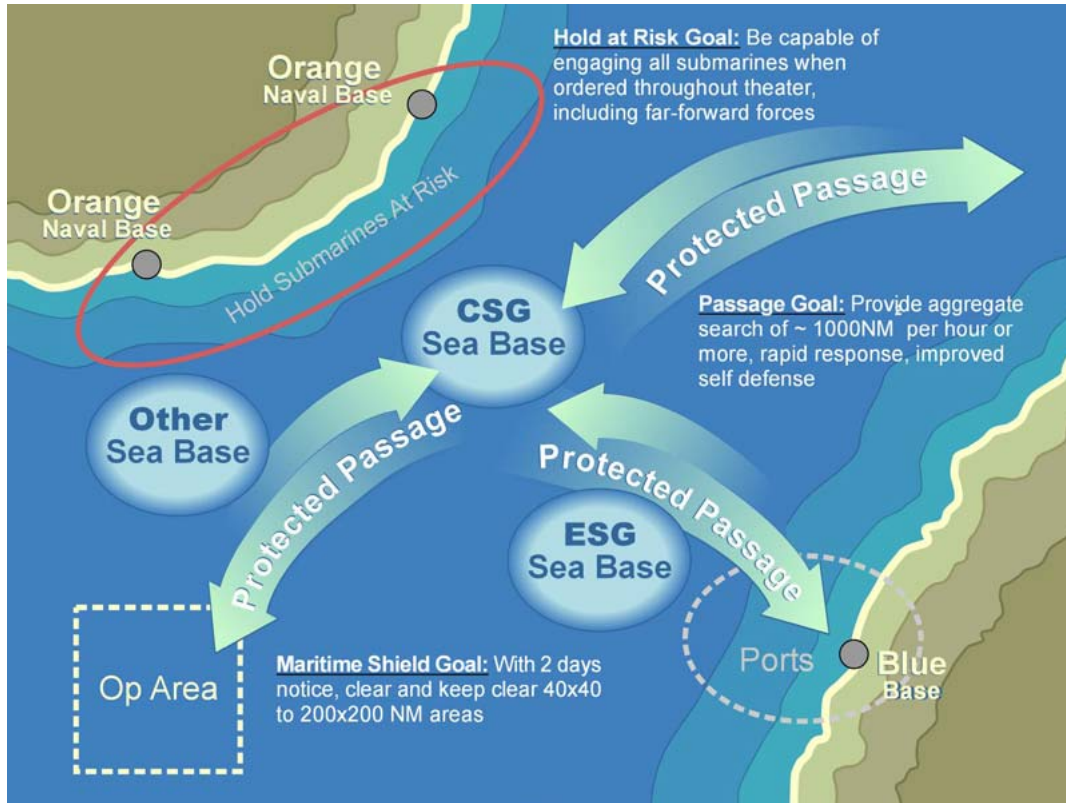

Figure 8: Future Anti-Submarine Warfighting Concept of Operations

To implement this new approach to ASW, the Navy is developing a series of advanced technologies that will improve wide-area surveillance, detection, localization, tracking and attack capabilities against quiet adversary submarines operating in the SLOCs or in a noisy and cluttered littoral environment. The impact of these new capabilities will be multiplied through their integration into advanced networks. These networks will distribute data and help convert it into operational knowledge, including underwater weapons system suites that will accelerate the speed and accuracy of decisions, and, finally, support employment of improved kill systems, which can more reliably engage and destroy enemy submarines.

ASW Transformational Concepts and Capabilities—Near- and Mid-Term (2005-2015)

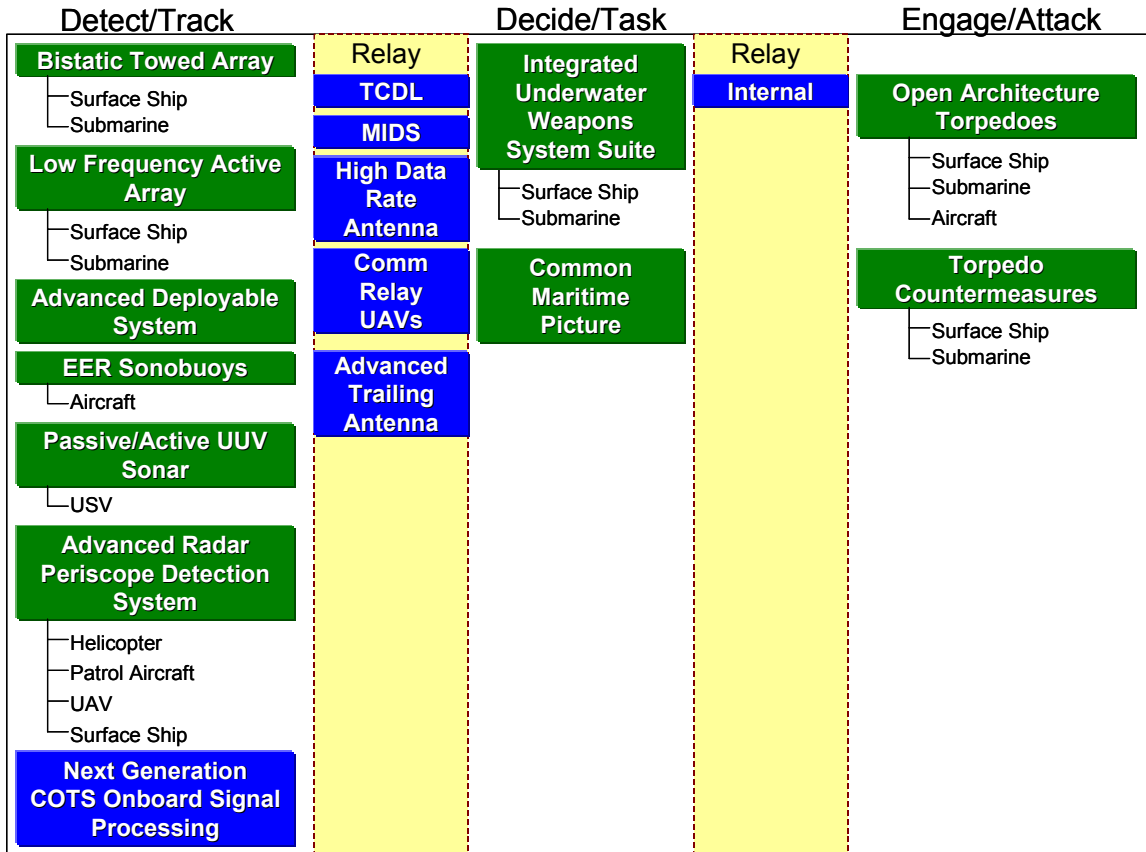

Figure 9: Key Elements of ASW Transformation

Detect/Track. Good intelligence, surveillance and reconnaissance (ISR) will continue to be the preparatory bedrock of all ASW capabilities and we shall endeavor to take full advantage of the situational knowledge, including environmental data, accumulated during peacetime surveillance missions. However, new ISR technologies such as the Advanced Deployable System (ADS) and Low Frequency Active (LFA) sonar will enable U.S. forces to be more responsive to changing threats and potential adversaries and help ensure that they are comprehensively held at risk.

The Advanced Deployable System (ADS) is an example of the transformational potential of off-board distributed systems that is likely to become a central part of the Integrated Undersea Surveillance System (IUSS). It consists of a series of passive, bottom-fixed, battery-powered hydrophones connected to one another and linked to a processing site ashore or afloat by fiber optic cables or radio signals. Given relatively short notice, current technology trends suggest that a system could be deployed on demand to provide reliable subsurface awareness, the number of sensors set out being dependent on the prevailing acoustic environment. IUSS will

also be given considerable boost in capability by a high-powered, low frequency active (LFA) acoustic system that will provide long-range detections in most conditions.

To supplement IUSS detection capabilities, U.S. attack submarines (SSN), surface combatants like the Littoral Combat Ship (LCS) operating in conjunction with mission reconfigurable unmanned vehicles, maritime patrol aircraft, MH-60R helicopters and dedicated ocean surveillance vessels, will collect information about the local undersea environment, technical characteristics of adversary submarine systems and indications of where and how potential adversary submarine forces operate. These platforms will link to national and Joint ISR systems to form a common maritime picture capable of supporting timely and accurate decisions.

As a transformational platform, the LCS will be critical to implementing the new operational concepts and to providing a focused, littoral mission platform for Joint forces. Its superior speed, maneuverability, low radar, infrared and acoustic signatures and ability to lay distributed sensor fields are all fundamental to success. It will also carry a 'squadron' of unmanned vehicles (air, surface and undersea) that will considerably extend its sensor coverage and provide substantial ASW capabilities.

The submarine Acoustic Rapid Commercial-Off-The-Shelf (COTS) Insertion (ARCI) program, married with new sensors such as arrays optimized for the littorals and networked processing applications, has provided the capability to extract more than an order of magnitude of additional gain and recognition differential from passive submarine sensors. The ARCI advanced processing build (APB) concept is being expanded to include surface platform sonar systems, for example the SQQ-89 A(V)15, and the integrated undersea surveillance system.

Due to their speed, area of coverage, versatility and payload, maritime patrol aircraft and helicopters will continue to be indispensable ASW assets. Utilizing Extended Echo Ranging (EER) technology and Automatic Radar Periscope Detection and Discrimination (ARPDD) equipment, large areas of the battlespace, both below and above the surface of the sea, will be searched at a greater rate and with greater confidence than any existing systems. The Airborne Low Frequency Sonar (ALFS) is also being procured to dramatically increase the acoustic capability of ship-based MH-60R helicopters. The transformational, bottom-up architecture of the new Multi-mission Maritime Aircraft (MMA) will tailor integration of its on-board mission suite with UAVs and space-based systems and sensors. Furthermore, S&T efforts are ongoing to develop promising active and passive electro-optical techniques that will be integrated into MPA, helicopters and ultimately the unmanned air vehicles that will be fielded to complement them.

Naval Transformation Roadmap

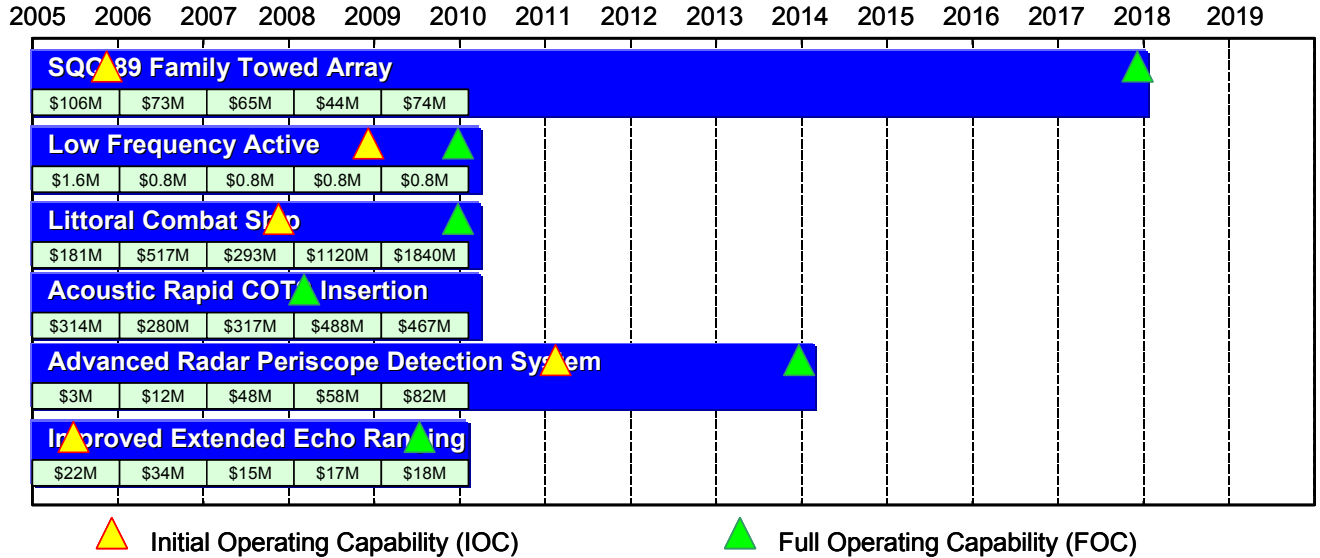

Figure 10: Programs Supporting Transformation of ASW Detect/Track

Improved ASW capabilities in the littoral will be achieved by more effectively networking surveillance and localization sensors, command elements, attack platforms, and weapons to share information in near real-time. Cross-correlated information from these elements will be used to build a common undersea picture that will be widely shared by all nodes and platforms engaged in ASW activity throughout the area of operations. To this end, the Navy is developing and, in some cases, fielding several new communication systems including: advanced fiber optic cables; communication relay UAVs; Joint Tactical Radio System (JTRS), the high data rate and advanced trailing antennas for SSNs and SSGNs, and vastly improved communications connectivity to submerged submarines. The Command and Control (C2) of off-board and unattended distributed sensor fields remains a challenge but S&T initiatives are pro-actively narrowing the range of possible solutions.

To take advantage of this improving connectivity, the Common Undersea Picture (CUP) program is devoted to fielding, via spiral development, a single suite of decision support and collaboration tools that will provide shared awareness and situational understanding of the underwater battlespace. As part of the Common Maritime Picture, it will be targeted at the naval commander's warfighting responsibilities and will automate the current manpower intensive performance prediction process and generate validated, optimized plans for asset, sensor and weapon employment in a manner that is not possible today.

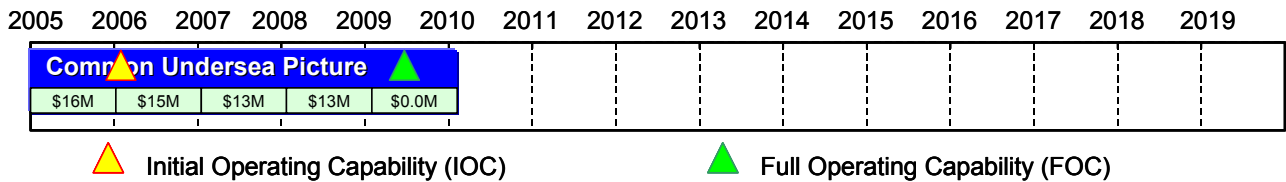

Figure 11: Programs Supporting Transformation of ASW Decide/Task

It will be hosted on the maritime variant of the Global Command and Control System (GCCS) that will itself migrate to the Joint Command and Control (JC2) capability.

Engage/Attack. For the foreseeable future, the primary weapon system for prosecuting submarines will remain the homing torpedo, in particular, an upgraded version of the highly capable Mk 48 heavyweight torpedo fired from submarines and Mk 54 lightweight torpedoes fired from aircraft and surface ships.

In addition, the Navy is also examining technologies for a compact, rapid-attack weapon. The transformational potential of this initiative leverages significant improvements in target location to reduce the required endurance of the torpedo, and thereby also its size, allowing the weapon to be carried on a broader range of future platforms.

The Navy is also working toward creating a range of decoys and local area jamming capability for use as countermeasures against torpedo attack. In the near-term, the Navy will employ substantially improved countermeasures to protect its own ships from a new generation of enemy torpedoes. For the future, the Navy is examining the use of an off-board platform, such as a large unmanned surface vehicle (USV) to carry some of these systems.

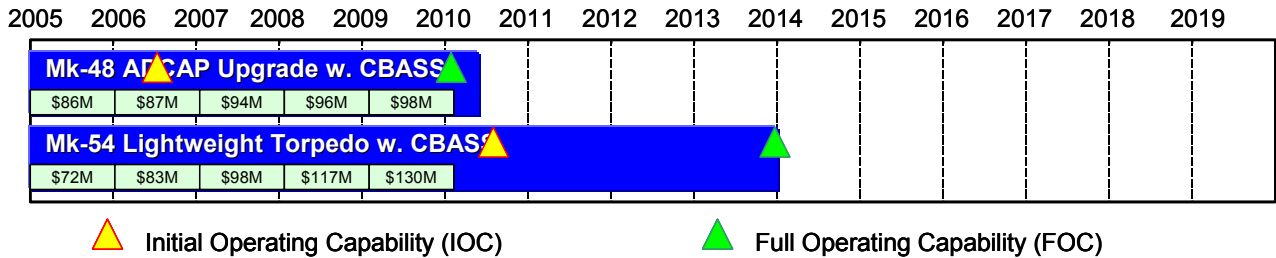

Figure 12: Programs Supporting Transformation of ASW Engage/Attack

ASW Transformational Concepts and Capabilities – Long-Term (Beyond 2015)

Long-term ASW improvements revolve around two fundamental higher-level requirements: 1) to transform from a ‘platform intensive’ to a ‘sensor-rich’ mission area operating construct; 2) to reduce the ‘Detect-to-Engage’ timeline.

These key tenets of ASW transformation reflect the changing face of warfighting that is intended to reap the benefits of the advanced, integrated networks and decision support tools that FORCENet promises.

To meet the first of these requirements, the Navy is exploring a system of small, autonomous, dispersed sensors that would provide persistent coverage of large areas, both in deep water and littoral underwater environments. Such a system would employ much smaller, easily deployed, and more persistent underwater sensors using both active and passive techniques to achieve desired results.

In order to better take advantage of submarine signatures that reach or break the surface of the sea, the Navy S&T community is also working on a number of large-area, non-acoustic search technologies. Standoff ASW capabilities from long endurance UAVs hold the potential to achieve very high search rates against shallow submarines through the use of EO/IR digital focal plane sensors. The Multi-Mode Magnetic Detection System (MMMDS) on low-altitude capable tactical UAVs will allow small area search and prosecution. The potential utility of synthetic aperture radar (SAR) to enhance the EO/IR technologies is also being examined.

To realize the second requirement, the Navy is considering long-range standoff ASW weapons that could be launched from a surface combatant, submarine, aircraft or unmanned vehicle--or possibly from land. Simultaneously, it is also exploring new options for unmanned, loitering delivery mechanisms and new precision targeting systems to meet the lethality requirements for slow speed diesels employing countermeasures and decoys. Some of these systems possess the potential to acquire and localize a target upon arrival on-station. Termed "compact rapid-attack weapons", alternatives to the traditional torpedo are also being investigated. Meanwhile, the Torpedo Bridging Technologies project within the Littoral ASW FNC will develop a tactically revolutionary improvement in the probability of kill against quiet submarines operating in harsh shallow water environments employing advanced countermeasures.

Support from other Services and Agencies

The following ISR support from other Services and Agencies will be required to enable achievement of the transformational improvements in ASW:

- All-source ISR data and intelligence – including imagery – of foreign submarine bases with a time latency of hours (or less) in order to determine when and where submarines are present as well as operational status
- Satellite and airborne communications systems to support the networking of sensors, assessors, controllers, and shooters
- New sensor technologies and processing and analysis techniques to leverage the capabilities of national security space systems in detection and tracking of submarines.

ASW Metrics

Progress toward a transformational capability in ASW will be measured in terms of the achievement of capabilities. Mission area capability metrics are listed in a separate appendix.

Planned Littoral ASW Sea Trial Activities

There are several venues and programs that are part of the Sea Trial CD&E Campaign Plan that support ASW experimentation. These include:

- Experimentation in support of Littoral Combat Ship ASW module development
- Distributed Mobile ASW sensor experimentation
- Four OPNAV ASW Demonstrations, exploring various technological approaches to the protected passage, barrier, and hold at risk concepts laid out earlier
- Undersea Dominance Advanced Warfighting Experiment, examining rapid ASW against SSKs using offboard systems, MPA, and submarines.

As with all Sea Trial activities, results will be tracked using the Sea Trial Information Management System (STIMS), maintained by the Navy Warfare Development Command (NWDC).

b. Mine Warfare (MIW)

Enemy mines and obstacles pose perhaps the most significant challenge to the Navy - Marine Corps Team's ability to project full dimension naval power -- from the stern gate, over water, across the beach, and to objectives ashore. Legacy naval MIW forces, although highly capable, require significant time to move to theater, and unique support not found elsewhere in the naval expeditionary force. At the same time, the adequacy of legacy MIW capabilities is deteriorating with the proliferation of new technologies and weapons, including small numbers of advanced mobile mines, and very large numbers of increasingly capable "traditional" mines such as surf-zone, shallow shelf and deep water rising fixed or drifting mines. The transformation of naval mine warfare is centered upon the transition from a specialized MIW force to an agile, scalable capability that is not tied to dedicated platforms, with the ultimate goal of "removing the man from the minefield" by the use of unmanned vehicles.

Naval efforts in offensive, defensive, and assault-breaching MIW will address the challenges of restricted capabilities and proliferating threats by moving to a range of solutions which are more flexible, more effective and more rapidly employable. A significant body of analysis has verified that simple avoidance will not be an option in many key areas of national interest. In these areas the current "Detect and Avoid When Possible, Breach When Necessary" approach must be taken. The transformational naval approach to MIW is based on a Concept of Operations (CONOPS) that integrates a range of new technologies that will enable future naval forces to freely operate and maneuver in the littorals, and deliver ground forces throughout the beach regions. This transformational CONOPS will assure access for naval combat and supporting forces by forming a "protected passage" of routes, transit lanes, operating areas, and attack lanes, while simultaneously employing offensive mine warfare to hold the enemy at risk, and to allow the combatant commander to employ the ground forcible entry option.

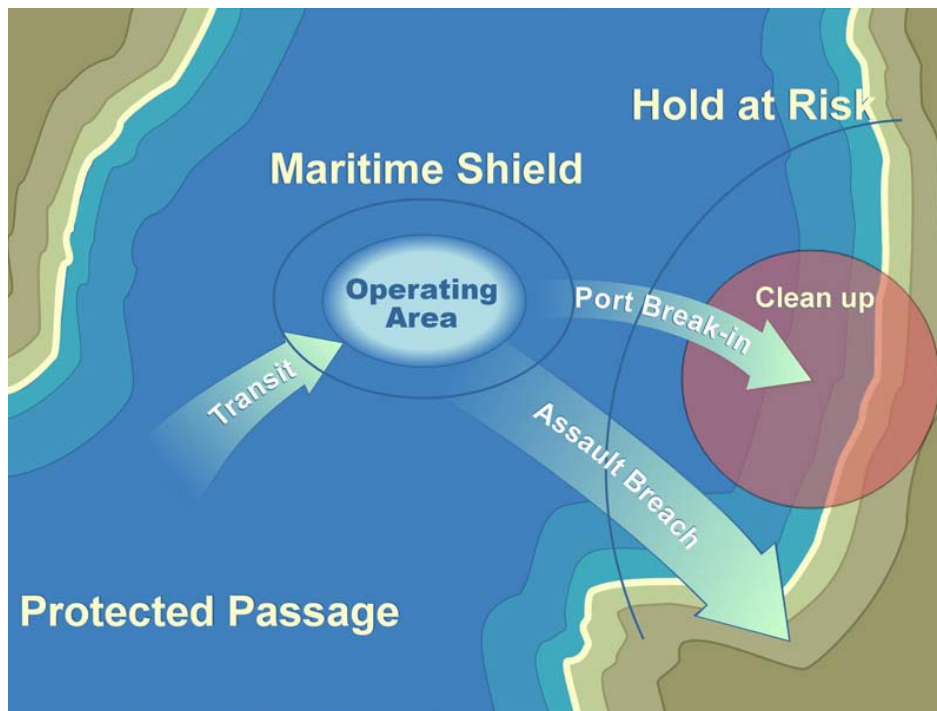

Figure 13: MIW Concept of Operations

MIW Transformational Concepts and Capabilities—Near- and Mid-Term (2005-2015)

In the near to mid-term, manned mine countermeasures activities, including the direct use of MCM ships and divers will be largely replaced by offboard unmanned systems such as unmanned helicopters, surface and subsurface vehicles, and standoff detection and breaching systems. Detailed mapping of undersea terrain and advance mapping of non-mine objects will assist these systems in rapid identification and clearance of mines. The use of unmanned systems to hunt or sweep for mines in contested areas--such as those within the range of enemy aircraft, patrol boats, and anti-ship cruise missiles--will greatly expand the range of options available to the joint commander by accelerating mine clearance while freeing up for other high value missions force protection assets that would previously have been allocated to protecting dedicated MIW platforms. In difficult terrain such as the surf zone/beach zone, stand off detection and breaching systems will be employed. Autonomous, cooperative unmanned vehicles will be remotely deployed to clear mines in advance of the arrival of naval expeditionary forces, and to offensively deploy mines in contested areas, while minimizing risk to personnel.

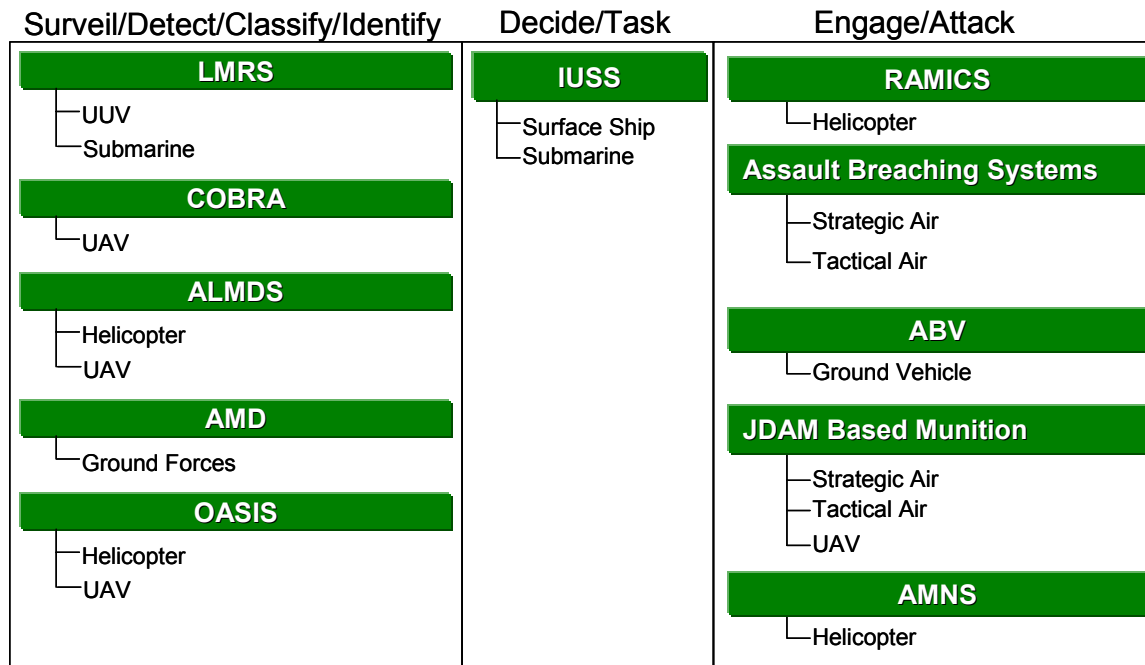

Figure 14: Key Elements of MIW Transformation

Survey/Detect/Classify/Identify. The capability to monitor the operating environment and detect and classify mine-like contacts will be greatly enhanced by a series of new capabilities. The introduction of the Navy's first Organic MCM systems in FY05, will include the Remote Minehunting System (RMS), followed by introduction of the Airborne Laser Mine Detection System (ALMDS). New covert surveillance UUVs, including the Long Term Mine Reconnaissance System (LMRS), equipped with laser and sonar detection systems and electro-optic identification means and carried by Littoral Combat Ship (LCS) and other ships and submarines will provide the capability to conduct minehunting without hazarding a ship and its crew. The Coastal Battlefield Reconnaissance and Analysis (COBRA) system, designed specifically to provide accurate battlefield intelligence depicting tactical objectives, minefields, obstacles, and fortifications on the beach and inland areas can be fielded on a variety of UAV

Naval Transformation Roadmap

platforms, and provides expeditionary operations the ability to more effectively detect minefields both on the beach and inland.

AUV technologies for clandestine reconnaissance will use small, near-expendable, man portable vehicles, including the Composite Endoskeleton Testbed Untethered Underwater Vehicle System (CETUS), Lemmings, and Remote Environment Monitoring Units (REMUS) with sensors for hydro recon and minehunting, real-time CAD/CAC processing, precise navigation, acoustic communications data relay, and neutralizer delivery. Buried mine sensing, classification and identification for AUVs will combine acoustic and magnetic buried mine sensors, automated processing, data fusion, sensor integration, and buried mine classification algorithms for detection and classification of buried mines.

The Advanced Mine Detector (AMD) will provide close-in mine detection of low- and non-metallic mines. In the FY07/09 timeframe, AMD will use Nuclear Quadropole Resonance (NQR) technology to detect the explosives within a mine or boobytrap – a quantum leap forward from the metal detection technology within the current AN/PSS-12 mine detector. In the FY04/05 timeframe, while NQR technology matures, the AMD Program Manager intends to procure 225 U.S. Army Handheld Standoff Mine Detection Systems (HSTAMIDS) as an interim capability.

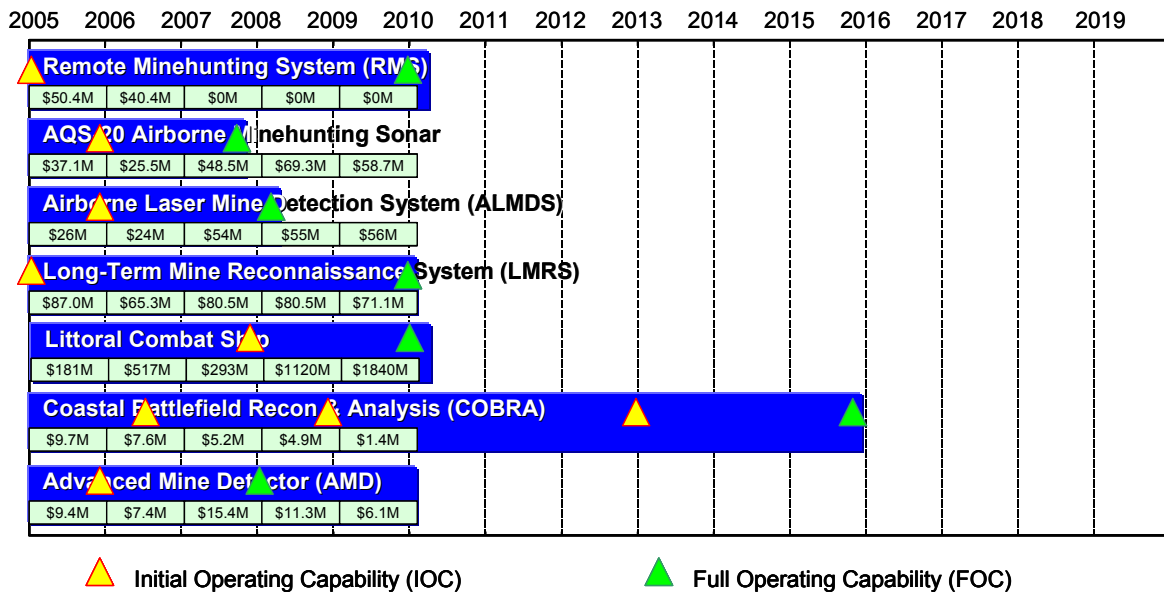

Figure 15: Programs Supporting Transformation of MIW Surveil/Detect/Classify/Identify

Engage/Neutralize. The capability to neutralize mines with offboard systems will greatly enhance the naval MIW capability. Using an air-based neutralization UV and unmanned surface vessels for influence minesweeping, the speed at which the Navy can counter the mine threat will no longer be dependent upon the rate at which divers and ships can serially engage mines. At the same time, emulator, jamming, and sweeping systems will use modular, high-fidelity sweep signal generators (magnetic/acoustic), enabling unmanned surface vehicles to use own-ship degaussing coils to jam or spoof modern influence mines. With the fielding of Rapid Airborne Mine Clearance System (RAMICS), Airborne Mine Neutralization System (AMNS), and the Organic Airborne/Ship Influence Sweep (OASIS) System, the Navy is improving the organic capability of forward deployed forces to generate operational freedom of action.

Naval Transformation Roadmap

In the surf and beach zone, the Navy is currently evaluating the ability of GPS-guided Joint Direct Attack Munitions (JDAM) 2000lb bombs to remove or destroy obstacles and surface-laid mines in the Surf Zone/Beach Zone for the interim period. In addition, it is developing a family of sub-munitions based on the JDAM to allow rapid clearance of mines and obstacles for landing forces.

The Assault Breacher Vehicle (ABV) is specifically designed to conduct in-stride breaching of minefields and complex obstacles from the beach exit to the objective. ABV will clear a lane of sufficient width and depth for mechanized assault forces, allowing assault units to move rapidly through obstacles before threat forces have the full opportunity to react to the attack and mass fires or establish defenses. The ABV integrates a full-width mine plow, line demolition charges, a lane marking system, and (as a P3I) a standard robotic system on an M1A1 tank chassis.

Precision navigation is another key to forcible entry operations in the 2010-2015 time frame for various amphibious delivery platforms such as the LCAC (X), LCU (R), and Expeditionary Fighting Vehicle (EFV). Precision navigation capabilities will allow naval forces to share accurate locations of detected mines, avoiding them where possible, clearing them where necessary, and then accurately transiting cleared lanes. EFV is integrating the Marine Corps' command and control applications with its navigation system. The EFV has a moving map display, integrated with its GPS and inertial navigation unit for periods when GPS data is not available. The EFV crew is provided a digital chart/map displaying an icon representing position, route, steer-to information, and an overlay depicting control measures.

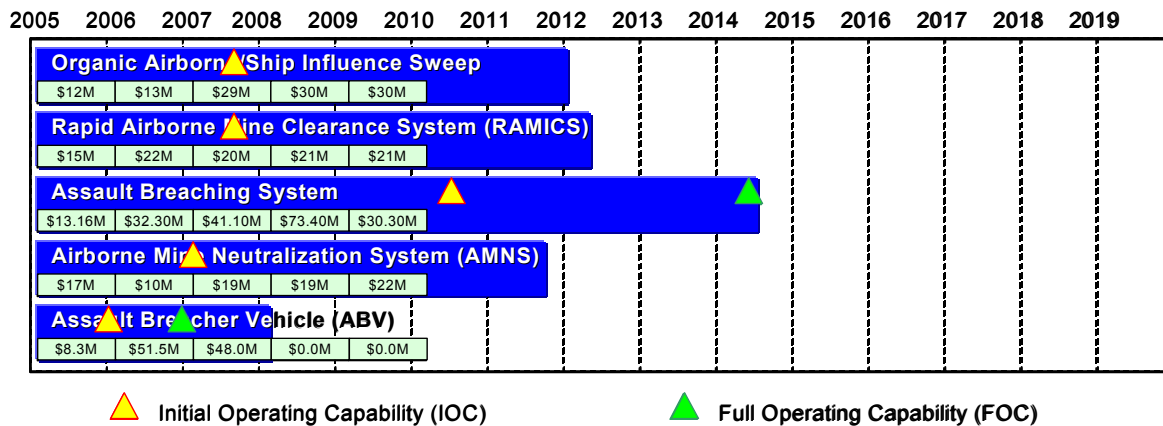

Figure 16: Programs Supporting Transformation of MIW Engage/Neutralize

MIW Transformational Concepts and Capabilities—Far-Term (Beyond 2015)

In the far-term, the ability to free an area of mines will also be dramatically accelerated by next generation mine sensors that fuse the processes of detection, classification and identification of explosives and by increasing the effective ranges of sensors, eliminating the current need to use high frequency sonar presentations and visual identification for classification. With the realization of this capability, influence minesweeping -- traditionally used in environments that preclude mine hunting and is operationally problematic, easily countered, and extremely threat sensitive -- would no longer be required.

Science and Technology investments in mine warfare are primarily within the Mine Countermeasure (MCM) FNC that develops and transitions technologies addressing critical gaps in the ability of naval forces to conduct operations in mined environments. The focus of these efforts is on 1) the fielding of the first generation organic MCM systems; 2) standoff mine countermeasures from very shallow water through the beach to support STOM; and 3) on the development of cooperating, unmanned MCM systems, such as autonomous cooperatively behaving swarms of bottom crawlers and a rapid surf and beach zone energetics system to quickly clear mines and obstacles from the path of oncoming forces.

MIW Metrics

Progress toward a transformational capability in MIW will be measured in terms of the achievement of capabilities. Mission area capability metrics are listed in a separate appendix.

Support from other Services and Agencies

The following support from other Services and Agencies will be required to enable achievement of the transformational improvements in MIW:

- Intelligence data and imagery of foreign mine storage areas, transshipment points, and depots, which can be leveraged to gain insight into the extent of the mine threat
- Improved range and bandwidth of satellite communications systems to support the networking of mine detection and clearance systems
- Improved ability of Joint forces to deliver assault breaching systems in support of the overall scheme of maneuver and power projection
- New sensor technologies and processing and analysis techniques to leverage the capabilities of national security space systems to support detection and geolocation of mines and minelaying activity.

Planned MIW Sea Trial Activities

HQMC has established a MCM Working Group, with a charter to develop, institute, and update a comprehensive Marine Corps MCM Master Plan during FY 04. Including members from across the Marine Corps and OPNAV staff, the MCM Working Group will ensure that the MCM master plan specifies naval engagement with the other Services and Agencies. Other activities included in the Sea Trial CD&E Campaign Plan that support MIW experimentation include:

- Office of Naval Research (ONR) experiments with shallow-water autonomous undersea vehicles for clandestine mine reconnaissance, including demos in 2003, 05, and 07.
- Field experiments with COMINEWARCOM evaluating use of HSV offboard systems for minefield reconnaissance and mine neutralization.
- COMINEWARCOM evaluation of HSV for high-volume mine delivery in a field experiment
- Operational evaluation of dedicated mine countermeasures in a CSG.

3. Anti-Surface Warfare (SUW)

Key Elements of Transformational Capability in SUW:

Anti-surface warfare will be transformed by the development of more persistent maritime surveillance and targeting, kinetic and non-kinetic weapons, more effective distributed network of fires and more precise and voluminous firepower. These initiatives will leverage new technologies to enhance each phase of the surface warfare detect-to-engage cycle. Integration of these enhanced assets via a network will dramatically improve effectiveness and accelerate the surface warfare kill chain. Earlier detection, identification and tracking of attacking ships will be combined with accelerated tactical control decisions and attack implementation, with desired effects delivered by the optimal weapon, faster and from a safer posture.

The transformational shift to a network of fires in surface warfare leverages new technologies and operational concepts at each phase of the detect-to-engage cycle. A new generation of more capable, more persistent sensors in the air, on and below the sea, including the capabilities of upgraded legacy platforms will be networked together to greatly improve passive and active target detection, assessment of intent, and engagement. This connectivity will enable a synergy between sensing capabilities, ensuring that hostile forces will be detected more quickly and reliably, and tracked with greater consistency, against a backdrop of shared situational awareness of blue assets and their status.

As in other warfare areas, FORCEnet will enable this integration. As a result, initial engagements will take place at greater distance from capital ships and other manned assets such as LCS, confidence in avoiding fratricide and the inadvertent engagement of non-combatants will increase, the speed of decision will accelerate, and the number of opportunities for successful engagement will increase. The shared picture of the battlespace, in combination with the tools to exploit it, such as the Joint Fires Network (JFN), which is currently under development for the overland battle, may be adapted to the maritime portion of the campaign and will allow a distributed form of rapid engagement that ensures the choice of the right weapon for the right target to achieve the desired effect. While each individual enhancement will add an increment of capability, the impact of the naval system of systems will transform the conduct and effectiveness of surface warfare.

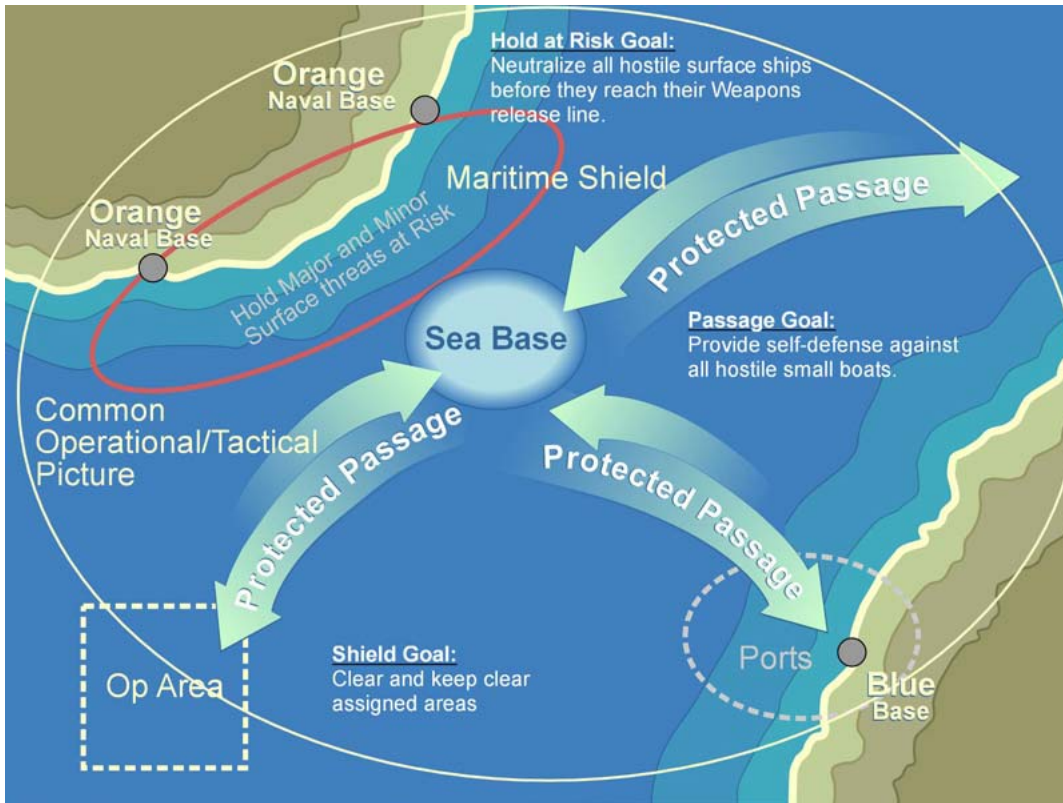

Figure 17: Surface Warfare Concept of Operations

SUW Transformational Concepts and Capabilities—Near and Mid Term (2005-2015)

Naval surface warfare initiatives with transformational impact are being pursued in all phases of the anti-surface warfare kill chain, including the introduction of new manned and unmanned platforms, as well as upgrades to existing platforms, all designed to operate within and leverage a fully networked fires architecture. The key transformational elements of the SUW engagement cycle are depicted in Figure 18.

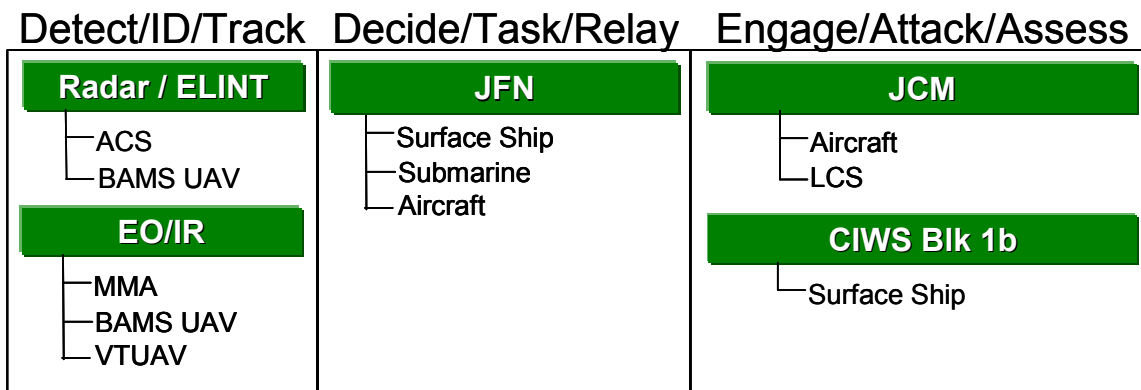

Figure 18: Key Elements of SUW Transformation

Detect/Classify/Track. The Navy will significantly increase its ability to detect, classify and track targets in support of surface warfare by upgrading the capability and connectivity among sensors and other nodes in the battlespace. The Broad Area Maritime Surveillance (BAMS) UAV is being developed to provide persistent, maritime surveillance and reconnaissance capability with worldwide access. BAMS will operate at altitudes over 40,000 feet, above the weather and most air traffic to conduct continuous open-ocean and littoral surveillance of targets as small as exposed submarine periscopes. BAMS will be fully integrated into the joint ISR architecture, providing this information to the joint force in near real time. Long-endurance BAMS UAVs will be able to provide a continuous on-station presence at ranges of 1000-3000 nautical miles from the launch point. BAMS will thus play a key role in providing the commander with a persistent, reliable picture of surface threats while minimizing the need to put manned assets in harms way to execute surveillance and reconnaissance tasks.

BAMS will be complemented by the Maritime Multi-Mission Aircraft (MMA) for special purpose, generally lower-altitude missions and by the VTUAV operating from LCS to ID contacts with EO/IR sensors. Together, the aircraft will be able to provide coverage over nearly all the world's high-density sea-lanes, littorals, and areas of national interest. In addition, Mobile SURTASS surveillance ships and underwater fixed surveillance systems will operate in conjunction with the U.S. Coast Guard to identify, track and acoustically profile warships and commercial shipping. Working in concert, these systems will provide the unique ability to merge a contact's acoustic, electronic and visual signatures into an undeniable profile.

Key naval programs supporting transformational advances in the detect/classify/track portion of the surface warfare engagement cycle are depicted below:

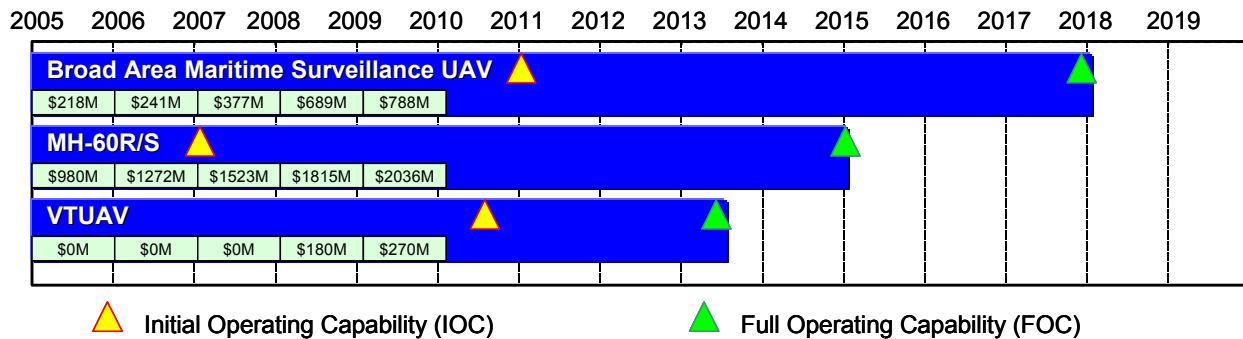

Figure 19: Programs Supporting Transformation of SUW Detect/Track/Classify

Decide/Task/Relay. The implementation of FORCEnet, including the common operational and tactical pictures and decision aids it will support, will transform Navy surface warfare from collections of ships individually combating other ships, to collaborative solutions for delivering precision effects against maritime objectives. In this new naval surface warfare paradigm, the most appropriate physical assets for delivering precision effects can be optimally selected through an automated system that considers attributes of available assets, targets, and the operating environment, then tasking the appropriate asset digitally on an accelerated timeline. In the near- to mid-term, the Navy is advancing down this path through the development of the Joint Fires Network. Key naval programs supporting transformational advances in the Decide/Task/Relay portion of the surface warfare engagement cycle are depicted in Figure 20.

Naval Transformation Roadmap

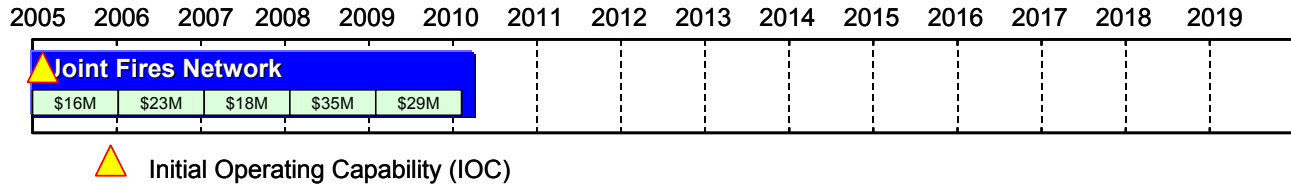

Figure 20: Programs Supporting Transformation of SUW Decide/Task/Relay

Engage/Attack/Assess. The connectivity of new platforms and upgraded legacy assets with ISR sensors through FORCEnet will enable them to fire on remote cues. Remotely cued engagement will increase the lethality and survivability of these assets by allowing them to engage targets over-the-horizon before entering the threat envelope of those hostile vessels. Moreover, the combination of off-board cueing, new passive tracking systems such as next-generation infrared sensors, and munitions with their own terminal guidance against moving targets will dramatically increase the stealth and survivability of U.S. naval surface assets by freeing them from the need to radiate energy to illuminate targets for precision munitions.

Upgraded legacy and new platforms will also possess significant capabilities to provide an effective defense-in-depth against swarms of small watercraft. Multi-mission cruisers, destroyers, LCS, and unmanned surface vehicles will employ high-volume fire weapons and Joint Common Modular Missile launched from helicopters and the VTUAV, and upgraded close-in defense systems such as CIWS Block 1B to provide an inner layer of defense against the small boat threat. Additionally, the fielding of high-energy weapons under development by the Office of Naval Research has the potential to greatly enhance defensive capabilities against small watercraft.

Key naval programs supporting transformational advances in the Engage/Attack/Assess portion of the surface warfare engagement cycle are depicted in Figure 21 below:

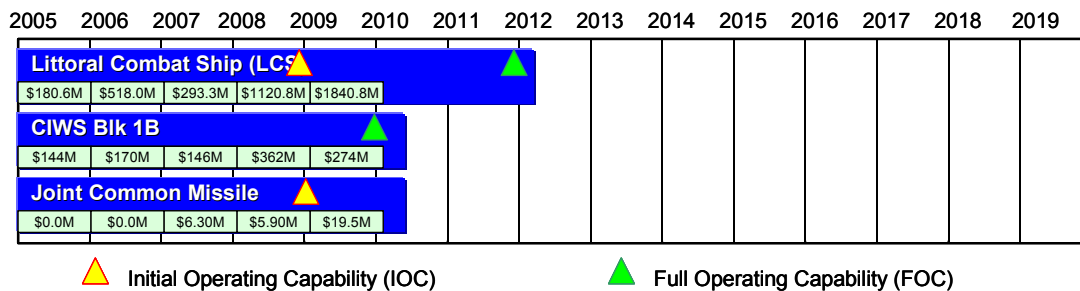

Figure 21: Programs Supporting Transformation of SUW Engage/Attack/Assess

SUW Metrics

Progress toward a transformational capability in SUW will be measured in terms of the achievement of capabilities. Mission area capability metrics are listed in a separate appendix.

Planned SUW Sea Trial Activities

The following specific Sea Trial events from the 2004 Exercise plan will support the development of transformational capabilities in SUW:

- Predictive Analysis wargame. March 04.
- HSV Force Protection C2 Rapid Response platform experimentation. January-June 04 (based on HSV schedule)
- Shielding Elements of the sea base. Runup and M&S September-October 04. Live Force play in PACFLT Area of Responsibility (AOR) November 04.
- Shipboard Protection System Limited Objective Experiment (LOE). FY04.
- MUSTANG CANTER FY04

4. Force Protection

New Transformational Capabilities for Force Protection:

Transformation in Force Protection focuses on full-dimension protection of forces afloat and ashore, installations, and the development of terrorist response capabilities that can be either expeditionary or serve homeland defense.

Afloat. Afloat force protection will be accomplished through a combination of technology insertion of an integrated Shipboard Protection System (SPS) as well as embarkation of specialized expeditionary security forces. This integrated system will support standalone defensive operations to protect a single asset without external support, while also fully enabling coordinated operations when external force protection assets are present.

The integrated protection system will incorporate a variety of advanced technologies, and as a byproduct of its integrated functionality, the system will help to address a number of significant force protection challenges, including

- Anti-swimmer defense
- Swimmer delivery vehicle detection and tracking
- Detection of low cross-section air and surface targets
- Detection and identification of surface threats at night and in conditions of reduced visibility
- Joint Combat Identification
- Situational awareness in restricted waters, harbors and anchorages
- Employment of the full spectrum of lethal and non-lethal means to defeat threats
- The ability to detect, identify and neutralize personnel, cargo and vehicular threats to moored naval vessels
- Integrated chemical-biological-radiological defense
- Effective use of collaborative command and control and planning systems, including tactical decision aids

Naval Transformation Roadmap

- Creating interoperability with waterside, landside, and expeditionary forces, including other Service, U.S. non-DoD, allied and host nation organizations involved in the force protection mission.

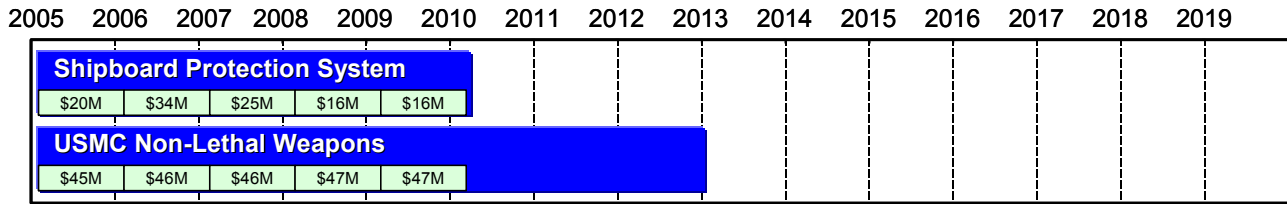

Figure 22: Programs Supporting Transformation of Force Protection

Dedicated expeditionary forces such as Naval Coastal Warfare (NCW) and Mobile Security Force (MSF) will provide full dimension area and point defense respectively. The concept for the MSF was conceived after the bombing of the USS COLE in October 2000. The mission of the MSF is to provide point defense force protection for High Value Assets (HVAs) such as U.S. Navy ships, Military Sealift Command ships, commercial ships, and aircraft against terrorist attacks in locations or in situations where U.S. or host nation shore security infrastructure is either inadequate or does not exist. The detachments are designed to be a highly mobile, expeditionary force capable of maintaining a high operational tempo. A detachment will normally deploy with up to 10 days sustainment and will be primarily focused on threats existing within 500 to 1,000 yards of a protected asset. NCW will continue to evolve to support Joint force operations in and around Sea Port of Debarkations/Embarkations, and in a Homeland Defense role as needed. NCW will maintain the requisite sensor, C4I, and engagement capability to deter, defeat and respond to terrorists and special operations forces.

To better protect the landside and waterside interface at Navy installations and some major ports, Navy is teaming with the United States Coast Guard to develop a command and control operations center capable of providing a seamless response to potential conventional and asymmetric threats. This Joint Harbor Operations Center (JHOC) will function as a well defined, flexible, and seamless structure to provide commanders timely exercise of authority and direction over assigned and attached forces. In addition, this capability will significantly improve connectivity and interoperability among maritime, joint, interagency, and selected commands that routinely conduct operations within a port environment.

The Fleet/Force Protection Future Naval Capability (FNC) demonstrates matured technology focused on organic self-protection of naval platforms against ant-platform weapons asymmetric threats. Technologies include Radio Frequency, Electro-Optic and Infrared weapons, sensors, countermeasures and signature control as well as elements of damage control.

Installations. The Navy - Marine Corps Team is devoted to supporting DoD Directive 3000.3, which establishes joint service organizational responsibilities in Homeland Defense matters and concerns in Force Protection. In particular, the naval team is engaged in the Critical Infrastructure Protection Program (CIP) to support this goal. The Department of the Navy Critical Infrastructure Program (DONCIP) consists of integrated naval vulnerability assessments, defense industrial base surveys, education and training, and regional infrastructure collaboration with other Federal, state, and local authorities. This partnership develops entities that are essential for the DON to achieve effective protection of critical infrastructures. CIP capitalizes on physical, operational, and information security to establish mission assurance, and

leverages the efforts of DoD to develop integrated physical/cyber and on/off base infrastructure protection strategies.

The Navy and Marine Corps are actively engaged in the Joint Service Installation Pilot Project (JSIPP) and the Unconventional Nuclear Warfare Defense (UNWD) to enhance force protection at the installation level. JSIPP is a Department of Defense program to protect personnel on military installations from Chemical Biological Radiological Nuclear and High Explosive (CBRNE) attacks. The program is designed to respond to attacks with trained and equipped emergency responders, and to resume essential operations after an attack. The JSIPP project involves the procurement of Chem/Bio detection equipment designed to provide situational awareness and aid in the command decision-making cycle. The UNWD pilot program is intended to provide a test bed for radiological and nuclear detection equipment at the installation level, and is being fielded at one installation per service with exercises being conducted at the beginning of FY04.

Force protection in domestic and some politically sensitive international situations may require non-lethal weapons. DoD Directive 3000.3 designated the Commandant of the Marine Corps as Executive Agent for the DoD Non-Lethal Weapons (NLW) Program, with the responsibility of providing, "...program recommendations and for stimulating and coordinating non-lethal weapons requirements." NLW capabilities in the near-to-mid term will provide an increased ability to deny an area to ground traffic, including the Mobility Denial System, a joint program to develop an anti-traction material (ATM) and delivery method. Other systems, like MK Short Range Munitions, will provide an increased volume of Non Lethal response capability. This system will be able to project sting ball munitions that can be fired with an effective range of up to seventy meters. Also, the naval team will have an increased ability to distract and deter individuals from their hostile intent through the Clear-A-Space Distract/Disorient device, that is expected to be capable of delivering several modular payloads including flash-bang, rubber balls, sparks, concussion/overpressure, or riot control agents. The USMC is exploring scaleable, directed energy/non-kinetic full spectrum weapons that will be completely rheostatic (non-lethal to lethal/counter personnel, counter material) and fully integrated into the Marines' warfighting capability.

Terrorism Response. The Marine Corps is combining JSIPP and UNWD at one installation, giving the DoD one preeminent installation in which a full spectrum CBRNE capability is being fielded. Congress recently increased the end strength of the Marine Corps in order to allow the 4th Marine Expeditionary Brigade (MEB) Anti-Terrorism (AT) to establish its own command element and Anti-Terrorism (AT) Battalion. These developments will enable the Marine Corps to be fully manned to meet the unique challenges of anti-terrorism by having the DoD's only on call anti-terrorism force for short notice deployments where the threat and nations interests demand. Other reorganization efforts that are being pursued include a realignment of structure for the increase in the area of Military Police. This realignment proposal calls for an increase of 1089 Military Police officers and 361 civilians, negating the need for operational forces to be utilized as augmenters during heightened threat scenarios. The Marine Corps is acting with creativity to establish new methods in organization and personnel employment to face the threats and demands present in an unpredictable environment.

The collective impact of successfully addressing these force protection issues will dramatically expand the options available to the joint commander for providing a forward presence in high-risk areas across the range of military operations, including not only operation in coalition ports in support of major combat operations, but also in homeland security, and in using forward

deployed naval forces to support peacetime engagement activities, strategic deterrence, stability operations, and other contingency operations.

Support from Other Services and Agencies

The following support from other Services and Agencies will be required to realize the transformational potential of naval integrated force protection efforts:

- All-source intelligence, accessible over the Global Information Grid for real time use in naval threat detection and consequence management tools
- Administrative and technical cooperation from the Coast Guard, federal, state and local law enforcement organizations, and selected foreign governments and international maritime organizations
- Compatible, persistent communication relays, such as UAVs and satellite communications systems provided by other Services
- Ability to leverage the work of the U.S. Coast Guard on harbor defense and small boat entanglement devices.
- Ability to leverage the efforts of the U.S. Army in development of new types of lethal and non-lethal ammunition.
- Continued support from the Joint Non-Lethal Weapons Directorate (JNLWD) for development and procurement of flash-bang warning munitions, hailing and warning devices to determine intent, directed energy weapons, and acoustic/visual devices to disable and disorient the threat.
- New sensor technologies and processing and analysis techniques to leverage the capabilities of national security space systems to support detection and geolocation of threats to naval forces, both at sea and in port.

Metrics

Progress toward a transformational capability in force protection will be measured in terms of the achievement of capabilities. Mission area capability metrics are listed in a separate appendix.

Planned Force Protection Sea Trial Activities

Over the next several years, the Navy – Marine Corps Team will be conducting a number of concept studies, field experiments, and operational prototyping of key technologies and systems to support the development of the force protection capabilities discussed in the previous sections. Some of these planned activities include:

- The testing of the Integrated Radar Optical Sighting and Surveillance System (IROS3) in the Summer of 2003, involving an integrated radar, EO/IR sensor and the operation of a remotely operated small arms mounts from centrally controlled operating stations in on the USS RAMAGE. RAMAGE will use the system in a CCG-8 swarm exercise in OCT 2003 and will deploy wit IROS3 in order to gain lessons learned and integrated logistics support requirements.
- The 4th MEB (AT) is participating in a joint Commandant of the Marine Corps (CMC) – Chief of Naval Operations (CNO) mission analysis addressing Navy Nuclear Weapons Security. The mission analysis is developing a force consisting of Marines and Sailors

that will protect strategic assets at both NSB Bangor and Kings Bay. Previously, these assets were protected solely by Marines.

- Conduct of a workshop to evaluate the potential predictive analysis as a tool to influence the allocation and location of DON FP efforts and resources.
- Conduct of a Force Protection C2 Rapid Response Platform LOE, using HSV as a surrogate to investigate desired attributes of an afloat force protection command and control platform, able to move quickly to a port and set up force protection and security for follow-on vessels.
- Extensive testing of new force protection technologies at the North Island Test Bed, such as swimmer detection sonars and non-lethal weapons.
- Extensive testing in Fall 2003 in USS BLUE RIDGE of 12 gauge and 40mm flash bang munitions.
- Continued at-sea testing of the 5"/54 Force Protection BB-round for small boat defense. Intend to integrate the software into all 5"/54 equipped ships in 2004. Testing of a "Look-point-shoot" capability for 5"/54 gun system. Integrated an enhanced EO/IR device and laser range finder with the GFCS will enable operators to simply point and shoot for extended ranges and lethality against small RCS surface craft.

B. Sea Strike

An integrated set of innovative operational concepts, new organizations and advanced technologies will be combined to transform the capabilities available to the joint commander for the projection of offensive power from the sea. Significant enhancements in naval deliberate and time-sensitive strike capabilities, combined with bold Ship-to-Objective Maneuver (STOM) operations will enhance the ability of naval forces to damage, seize, or destroy enemy forces at extended ranges in accordance with the Joint Force Commander's objectives in the littorals, deep inland, and on the high seas. We are transforming the ability to employ these capabilities at a speed and rate that defeats any adversary's ability to conduct effective operations against us despite his use of mobility and deception to neutralize our efforts.

- **Project Dominant and Decisive Offensive Power Anywhere in the World**
- **Immediate, Agile, and Sustainable Fire & Maneuver From the Sea**

Operating as part of a joint and combined force, naval forces are becoming increasingly capable of delivering joint effects from extended range and with increased lethality, accuracy and timeliness. Joint and naval forces will employ a combination of highly responsive fires in support of maneuver forces and deep strikes that will result in the rapid achievement of the desired effects. Transformational future naval strike capabilities feature more flexible land attack cruise missiles launched from ships and submarines, electronic Radio Frequency or digital attack from manned aircraft, UAVs, and ships, precision-guided munitions delivered by naval manned and unmanned aircraft and surface ships, as well as highly-maneuverable and increasingly lethal Marine forces and Sea Air and Land (SEAL) teams operating ashore. The transformed strike capabilities of the Navy and Marine Corps will complement the improved strike capability of the Air Force, Army, and Special Operations Forces.



Figure 23: Deliberate & Time-Sensitive Strike Concept of Operations

1. Deliberate and Time-Sensitive Strike

Key Elements of Transformational Improvements in Deliberate and Time-Sensitive Strike Capabilities:

Naval initiatives will dramatically increase the flexibility and effectiveness of strike operations against fixed and fleeting, time-sensitive targets. Targets will be identified more rapidly and effectively through enhanced, networked, persistent ISR systems. Netted fires and automated decision aids will accelerate the mounting of precision attacks on critical targets with appropriate precision strike means in order to create the appropriate effects. These precision fires will be complemented by the enhanced operational reach and tactical flexibility of sea-based MAGTFs able to conduct Ship-to-Objective Maneuver. In addition, the range of effects available to the joint commander through the use of improved naval strike capabilities will be substantially expanded by including Information Operations (IO), incorporating influence operations and non-

kinetic attacks. The combination of these capabilities will fundamentally alter the ability of the joint commander to execute both deliberate and time-sensitive strikes on targets throughout the battlespace in order to damage, seize, or destroy critical objectives with the highest tempo possible.

The Navy – Marine Corps Team will combine these new operational concepts, technologies, and automated procedures to achieve responsiveness to calls-for-fire against an increasingly mobile, adaptive adversary. This approach exploits network-centric capabilities, integrating remote sensor information with the full range of potential weapons via an end-to-end, sensors-to-weapons architecture to open a range of new possibilities. Included will be the option to transmit in-flight target location updates allowing the redirection of munitions in flight, and new opportunities to rapidly redirect aircraft from their preplanned mission to prosecute time-sensitive targets and respond to immediate calls-for-fire. Naval efforts will also increase responsiveness to rapidly engage fleeting targets by dramatically reducing the time required for a weapon to reach its assigned target through a number of advanced munitions concepts including hypersonic speed. Non-kinetic weapons will deny or degrade enemy command and control resulting in a decisive operational advantage for the joint force.

To achieve these capabilities, S&T is being conducted in innovative designs, materials, structures and propulsion systems. Robust materials with lighter weight and higher temperature capabilities are being developed which will permit higher velocity aircraft and missile performance, as well as reduced procurement costs.

Forward deployed naval assets will increasingly employ unmanned vehicles such as UAVs and UUVs to greatly extend the persistence of sensors, dramatically expanding the commander's options to effectively detect and verify time-sensitive targets while minimizing the exposure of our forces to increasingly lethal weaponry. These platforms will carry more effective multi-spectral sensors, leveraging advances in electronics and miniaturization. The combination of improved sensors, greater persistence, and greater latitude for use across the battlespace will dramatically increase the amount of multi-source information available to commanders. At the same time, connectivity between sensors and other nodes will enable earlier target identification, faster verification, improved ability to maintain a target track, faster deconfliction and identification of the appropriate effect, and the system to deliver it with reduced possibility of fratricide or collateral damage. At the same time, new battle management tools will allow both the firing platform and other manned platforms to rapidly assign ordnance and aircraft flight paths to assist in rapid engagements and further improve our lethality and operational effectiveness.

Transformational Concepts and Capabilities—Near- and Mid-Term (2005-2015)

Naval initiatives will enhance all dimensions of the engagement chain for deliberate and time-sensitive strike. The combination of more persistent, netted ISR with greater decision speed and an expanded range of options for delivering precision effects will substantially increase the capability of the joint commander to conduct deliberate and time-sensitive strike. The key transformational elements of the greatly improved deliberate and time-sensitive strike engagement cycle are depicted in Figure 24.

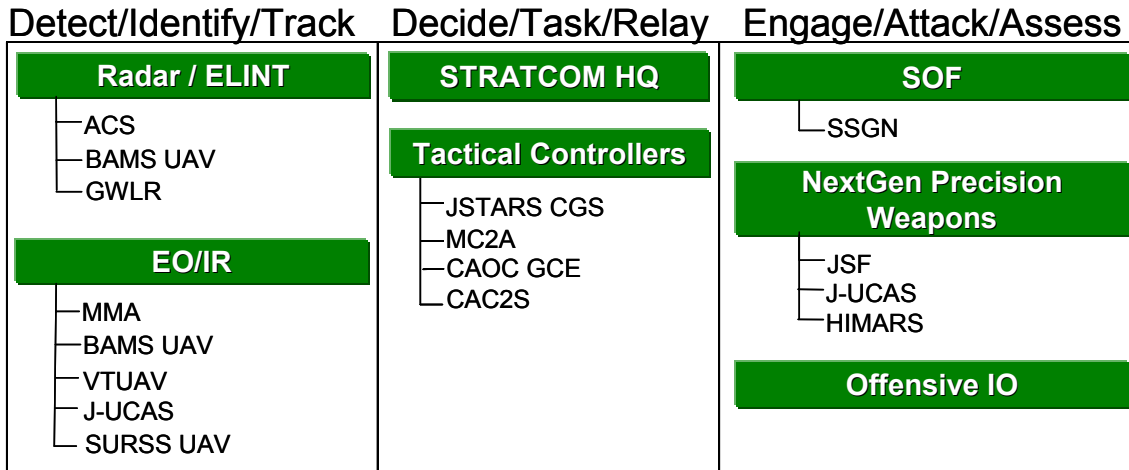

Figure 24: Key Elements of Deliberate and Time-Sensitive Strike Transformation

Detect/Identify/Track. The key naval advances in the detect/identify/track portion of the deliberate and time-sensitive strike detect-to-engage sequence will include expanded ability to covertly insert and communicate with SEAL and Marine reconnaissance teams, to employ other SSN-hosted sensors, and to collect intelligence data through a variety of unmanned craft such as the BAMS UAV, as well as the ability to leverage the data from this proliferation of human and unmanned sensors that will be “born integrated” into a joint fires architecture.

Special Operations Forces (SOF) equipped to conduct clandestine missions, and delivered to the area of operations covertly by a submarine outfitted with tactical planning and execution tools will provide the naval expeditionary and joint forces with far broader and more flexible options in this arena. The SSGN, for example, will be able to embark, deploy, and sustain a large special operations force for several months. Significant improvements in habitability, stowage, mission planning capability, and physical fitness facilities, will allow the SSGN to support a broad variety of collection missions and other operations over an extended period of time, spanning the full spectrum of conflict from initial preparation of the battle space through full-scale conflict. A robust FORCENet capability will allow the Joint Special Operations Task Force (JSOTF) commander and his planning cell to complete his assessment of alternatives to successfully complete the mission.

In support of both deliberate and time-sensitive strike, UAVs such as BAMS, Small Unit Remote Scouting System (SURSS), VTUAV, and the Joint Unmanned Combat Aerial System (J-UCAS), naval forces will provide the Joint Force Commander the ability to increase battlefield sensor density with greater persistence and less risk to personnel. Organic sensors throughout the battlespace will contribute to the increased operational picture. From space-based sensors to unmanned remote sensing systems, from the E-2C Advanced Hawkeye to the Ground Weapons Locating Radar (GWLR), these networked systems will provide a single coherent picture of enemy actions and locations.

The following graphic depicts timelines and funding for key naval capabilities in the detect/identify/track portion of the time-sensitive strike detect-to-engage sequence.

Naval Transformation Roadmap

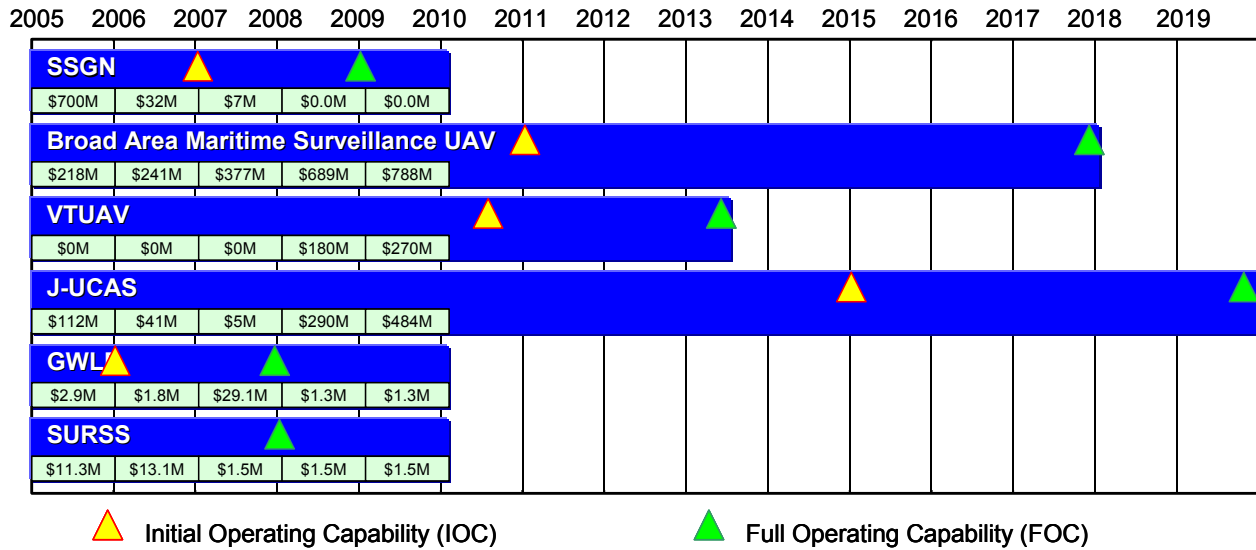

Figure 25: Programs Supporting Transformation of Strike Detect/Identify/Track

Decide/Task/Relay. The Navy – Marine Corps Team is pursuing transformational approaches to the “Decide/Task/Relay” portion of the engagement cycle for deliberate and time-sensitive strike. Future naval forces will engage targets throughout the battlespace from more dispersed formations. Improving and building upon the cooperative, collaborative and networked naval system is essential to using the sea as an effective maneuver space. This networked systems approach to warfare will be achieved by combining sensors, command and control, and fires, to form a networked “system of systems” that allows the joint commander to develop the knowledge superiority that enables rapid self-synchronizing and decisive action.

Joint tactical controllers providing dynamic tasking of strike systems to mount timely attacks with naval fires will be located in the air, on land and at sea. Airborne platforms capable of joint strike command and control will include the new Multi-sensor Command and Control Aircraft (MC2A), the Aerial Common Sensor aircraft that will replace the EP-3E, and the UH-1Y. These capabilities will be integrated with ground-based and sea-based control elements such as those in the Common Aviation Command and Control System (CAC2S), Combined Air Operations Center, Common Ground Station (CGS) for the JSTARS and with the Maritime Component Commander. All of the joint controllers will have access to both near-real time sensor data, and the latest information on the availability of ready “shooters”— Tomahawk-equipped surface ships and submarines, strike aircraft and UCAVs; and MAGTF fire support assets. The result will be a scalable command and control architecture supporting commanders across the joint force.

In general, naval migration towards open system architectures in new systems and upgrades to legacy systems is a key enabler of Sea Strike transformation. Each element in the emerging system will promptly post an expanding array of minimally processed sensor data on the Internet Protocol network. This posted data will be rapidly accessible by controllers, and by assessment centers that produce the common operational and tactical pictures--effectively filling the battlespace with “eyes” that collectively will significantly increase the joint capability to detect, verify, identify, track, and relay information on time-sensitive targets. The combination of the near real-time shared picture enabled by FORCEnet and the decision aids to exploit this data will allow tactical controllers to more rapidly verify targets, nominate the attack asset best

Naval Transformation Roadmap

able to deliver the most appropriate effect, and to assess the effectiveness of the attack, in order to decide on the necessity of re-targeting.

The graphic below depicts timelines and funding for key naval capabilities in the decide/task/relay portion of the time-sensitive strike engagement cycle.

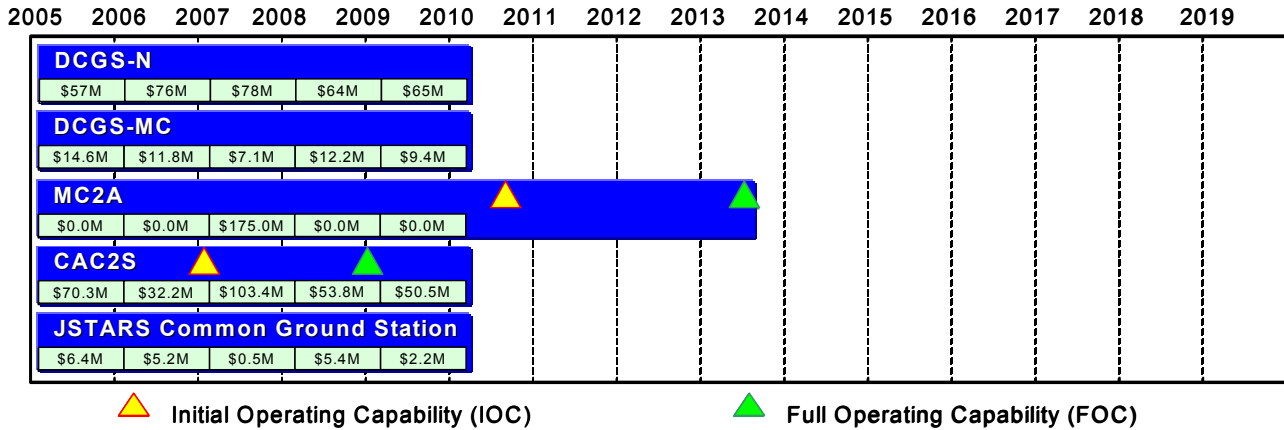

Figure 26: Programs Supporting Transformation of Strike Decide/Task/Relay

Engage/Attack/Assess.

For both deliberate and time-sensitive strikes, forward deployed naval forces will provide a broader range of engagement options to the joint commander with greater precision, reach and stealth. Increased use of next-generation missiles such as Tactical Tomahawk and Joint Common Missile, and unmanned platforms such as J-UCAS will continue to reduce the risk to pilots and increase the flexibility of the commander. The combination of manned and unmanned assets will be available to launch precision attacks from forward-deployed naval forces at sea and ashore with greatly reduced prospect of detection and engagement.

CVN21 will be the principal future sea base platform for Naval Tactical Aviation. Manned tactical aircraft and UAVs carrying precision-guided munitions will operate off the electrified, automated flight deck at potentially twice the tempo as previous classes. Core to the CVN21 design is incorporating the excess electrical power and additional space that will allow future technological advances to be absorbed as they evolve. CVN21 will be able to accept new technologies in netted operations that are not even envisioned today.

The SSGN will be capable of carrying a broad range and substantial quantity of capabilities, including special operations forces, sensors, processors, delivery vehicles (UAVs, USVs, UUVs), and strike munitions such as Tomahawk cruise missiles packaged for submarine delivery. SSGNs will also be capable of carrying large special operations teams and equipment such as the Advanced SEAL Delivery System over an extended period to carry out a range of missions.

As a complement to a range of new delivery system capabilities, naval initiatives are also developing next-generation precision weapons with increased accuracy, making them both more lethal and more usable in environments in which collateral damage is a significant consideration. Naval efforts in this area include next-generation EO/IR seekers, and other forms of precision terminal guidance, including terminal controllers equipped with advanced target designation and data-burst technologies.

Naval efforts toward precision terminal guidance that can be employed against all classes of moving targets, in adverse weather, and at standoff ranges is a key dimension in the transformation of kinetic attack on time-sensitive targets. Developments in this area have applicability across the range of delivery platforms, and include assuring day-night, all weather precision effects at standoff ranges. These developments will ensure that enemy time-sensitive targets can be placed at risk on a continuing basis, significantly limiting adversary options on the battlefield. Enhancements being explored to weapon terminal guidance in adverse weather include the use of GPS up-dates, and use of next-generation, affordable miniaturized sensors that leverage technologies which are degraded less by adverse weather such as millimeter wave radar and high power Light Amplification Direction and Ranging (LADAR) systems.

The Navy and Marine Corps are also integrating the power of our precision-guided munitions inventory with improved ISR and C2 capabilities. We are migrating to network-centric transfer of precision-guided missile (PGM) mission data so that new targets can be struck even after launch platforms and PGMs are in flight. This will allow increased flexibility and precision in time-sensitive missions against specific locations such as rooms in buildings, and bridge sections or piers, as targeted by emerging ISR capabilities.

Naval efforts to develop automatic target recognition capability and autonomous weapons will also enable a new generation of precision seekers that can find and follow mobile targets without placing Sailors or Marines within the enemy threat envelope. To achieve these advances, the Navy is exploring ways to combine and gain synergies between new miniaturized sensors and advanced decision algorithms.

Naval initiatives are also seeking to increase the likelihood of desired effects delivery by increasing the flexibility of weapons payloads for attack aircraft. Such flexibility will increase the odds that each candidate in-flight “shooter” can access a munition appropriate to emerging targets, while reducing the number of cases in which the environment in which the target is operating precludes action against it. One leading-edge technology for achieving this flexibility is adaptive ordnance. Adaptive ordnance payloads will consist of newly developed, advanced energetic materials and embedded micro-initiators to control the directionality, form, and extent of lethal effects. It will make use of a range of damage mechanisms ranging from “agent defeat” through conventional high explosive blasts to multi-phase blasts and other advanced approaches. It will be used, for example, to cause coupled overpressure buckling of an entire building complex, or for precision engagement of a small WMD site. Adaptive ordnance will also enable faster, more accurate battle damage assessment and a reduced re-strike requirement, with an attendant reduction in risk to platforms and crews, and will contribute to a smaller deployed logistics footprint and overall campaign cost.

The Navy – Marine Corps Team is also developing an expanded portfolio of non-kinetic attack means, including Information Operations (IO) such as Psychological Operations (PSYOP) delivery capabilities, maritime Computer Network Attack and advanced Electronic Attack, which will broaden the range of options available to the commander for achieving operational effects. The development of capabilities through naval initiatives in this area could influence, deny, disrupt, corrupt or usurp adversary command and control, ISR and other computer systems to achieve psychological advantages, negate warfighting effectiveness, and redirect adversary efforts toward threat targets of our choosing.

Finally, the integration of weapons into the information architecture through systems such as QuickBolt, carried by weapons that transmit data on target engagement just prior to target impact, will accelerate the attack tasking cycle, increasing the likelihood that a “missed” target

Naval Transformation Roadmap

can be rapidly re-engaged, while freeing up assets traditionally used in battle damage assessments (BDA) to search for other critical targets.

Figure 27 depicts timelines and funding for key naval capabilities in the engage/attack/assess portion of the deliberate and time-sensitive strike engagement cycles.

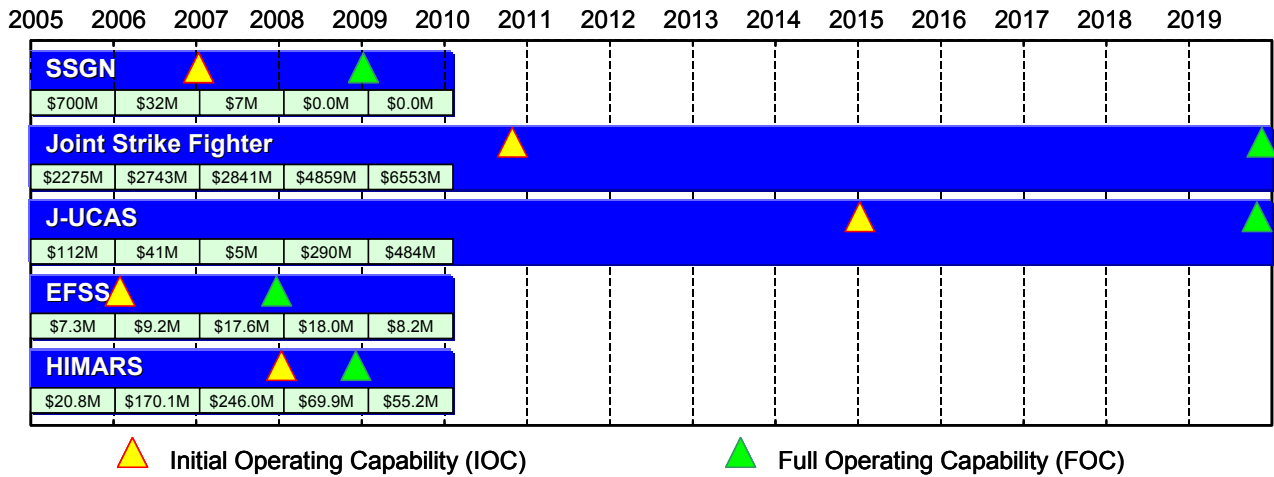

Figure 27: Programs Supporting Transformation of Strike Engage/Attack/Assess

Transformational Concepts and Capabilities – Long-Term (Beyond 2015)

Long term naval efforts in deliberate and time-critical strike are directed at forging a responsive network of strategic, operational and tactical fires and maneuver throughout the littoral area that can be fully integrated with the projection and operation of highly mobile ground forces. We will conduct simultaneous, widely dispersed operations that combine naval strikes with naval fires in support of ground units ashore as envisioned in the Marine Corps' and Army's future warfighting concepts. Challenges associated with this integrated network of sea-based fires and maneuver forces include development of the capability to provide rapid, accurate, direct support fires to maneuver forces at extended ranges, including long range precision fires against moving targets, and the development of enhanced sensor and command and control capabilities to support these long range timely fires and enable simultaneous operations. Programs under development by ONR with revolutionary promise to address some of these challenges include hypersonic weapons and electromagnetic gun technologies.

Support from other Services and Agencies

The following support from other Services and Agencies will be required to enable delivery of the transformational capability in deliberate and time-sensitive strike:

- Compatible sensor data from other Services' ISR assets to support ship-based naval fires and strikes by manned and unmanned naval platforms.
- Joint tactical controllers that task and assist joint strike forces in locating and engaging key targets
- Compatibility of other service engagement/attack assets with the naval portion of the joint architecture, allowing Air Force or Army shooters to act on target information provided by forward Navy sensors and to be tasked by Navy and Marine Corps tactical controllers.

- Compatible, persistent communication relays, such as UAVs and satellite communications systems provided by other Services
- New sensor technologies and processing and analysis techniques to leverage the capabilities of national security space systems to support time-critical strike.

Deliberate and Time-Sensitive Strike Metrics

Progress toward a transformational capability in deliberate and time-sensitive strike will be measured in terms of the achievement of capabilities. Mission area capability metrics are listed in a separate appendix.

Planned Deliberate and Time-Sensitive Strike Sea Trial Activities

Over the next several years, the Navy – Marine Corps Team will be conducting a number of concept studies, field experiments, and operational prototyping of key technologies and systems to support the development of the capabilities discussed in the previous sections. Some of these activities include:

- Naval electric weapons experimentation demonstrating hypersonic projectile firing and railgun scalability for naval fires, including Rail Gun Limited Technical Experiment (LTE) #2 January 2004 in Kirkcudbright, Scotland.
- Examination of affordable weapon system capabilities to provide volumes of fires in support of ground forces
- Experiments with the clandestine employment of special operations forces (SOF) in support of timely targeting
- Enabled by FORCEnet software agent capabilities, examination of the utilization of targeting data provided by the common tactical pictures tailored to individual users
- Evaluation of the SSGN capability to launch Tomahawk Land Attack Missile (TLAM) Block III or the Tactical Tomahawk with a payload of 132 to 154 missiles.
- Evaluation and refinement of tactics, techniques, and procedures for the Tactical Tomahawk Weapons System in order to maximize the transformational deliberate and time-sensitive strike capabilities of this precision, long-range weapon.
- Sea Viking 04 experiments to assess ISR capabilities required to support *Expeditionary Maneuver Warfare* (EMW). The following specific Sea Trial events from the 2004 Exercise plan will support the development of transformational capabilities in Deliberate and Time-Sensitive Strike:
 - Joint Force Maritime Component Commander (JFMCC) Wargame November 2003.
 - Terminal Fury 04. December 2003 in C7F AOR.
 - Silent Hammer LOE #2. C3F AOR. June 04.
 - JTF-EX 04. June 04.
 - Global Engagement VII (USAF Title X Wargame) July 04.
 - NAVSPECWARCOM SEAL Interoperability LOE. August 04.
 - Fleet Battle Experiment-Lima. Command Post Exercise (CPX)--September-October 04. Exercise--November 04.

2. Ship-to-Objective Maneuver (STOM)

Transformational Objectives

Marine Corps forces have long provided a scalable, tailorable and expeditionary combined-arms option, enabling joint commanders to deal with a wide range of contingencies. For decades, however, Marine power projection has included a deliberate buildup of combat power ashore. This buildup required the establishment of a force beachhead, with relatively fixed fire support, logistics, and command and control positions located ashore. Only after naval forces fought ashore and established a beachhead would the MAGTF begin to focus its combat power on the Joint Force's operational objective. A combination of naval initiatives in advanced mobility, fires, and sustainment capabilities, leveraging substantially enhanced information connectivity, will enable future Marine forces to be employed in a dramatically different manner, making them an even more effective tool of national power.

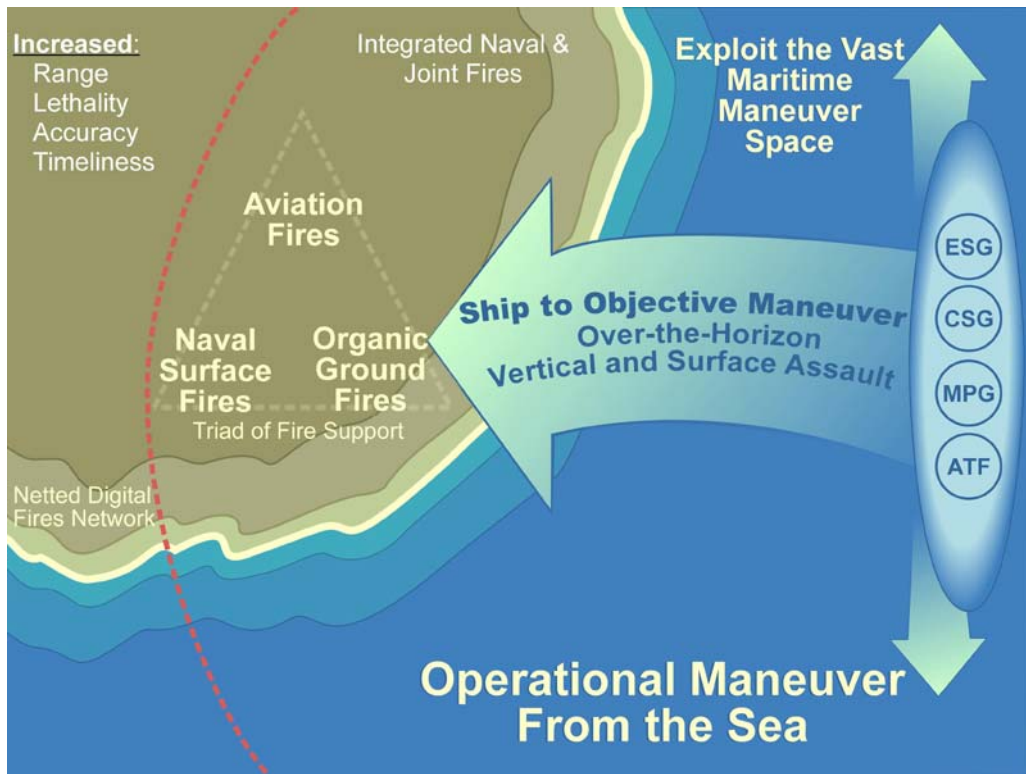

Figure 28: Ship to Objective Maneuver Concept of Operations

Ship-to-Objective Maneuver (STOM) is a transformational tactical application of enduring naval capabilities for Operational Maneuver from the Sea (OMFTS) and exploits each of the enhanced capabilities described by *Expeditionary Maneuver Warfare* (EMW). Enabled by persistent, responsive, and dynamic sea bases, forward deployed in international waters, naval forces executing STOM will be able to project Marine Air-Ground Task Forces (MAGTFs) directly to critical operational objectives located deep inland, dislocating our adversaries both in space and in time. STOM includes combined arms penetration and exploitation operations from over the horizon by both air and surface means, with forces moving rapidly to operational objectives without stopping to seize, defend, and build up beachheads or landing zones. STOM provides the Navy - Marine Corps Team with an enhanced sea-based forcible entry capability, optimized

Naval Transformation Roadmap

for the introduction of follow-on Air Force, Army and multinational forces. In combination with other joint forces, naval forces capable of operational maneuver and STOM can also provide the Joint Force Commander with Operational Maneuver Elements (OMEs), ideal for creating dilemmas for adversaries during sustained operations ashore. Because naval forces able to conduct STOM will be able project power more swiftly than ever before, they will be able to not only “kick down the door” that the enemy’s defense’s present, they will also be able to “get a foot in the door”, and preclude him from effectively integrating his anti-access defenses as crises threaten.

The realization of STOM requires advances in a range of capabilities in order to move, shoot, and communicate while sustaining operations over greater ranges and at a higher tempo than ever before. To ensure that we pursue comprehensive change, we must comprehensively consider the way in which we intend to organize, deploy, employ and sustain our new capabilities. The realization of STOM capabilities requires changes in our equipment, our organizations, and our concepts. These concepts will include not only our operating concept, describing our broad vision of STOM, but also the detailed development of functional concepts, describing the warfighting functions required to achieve this objective. The ongoing development of the *STOM CONOPS* provides a more detailed examination of capabilities required to execute STOM in a particular scenario, and serves as a baseline for further naval force development.

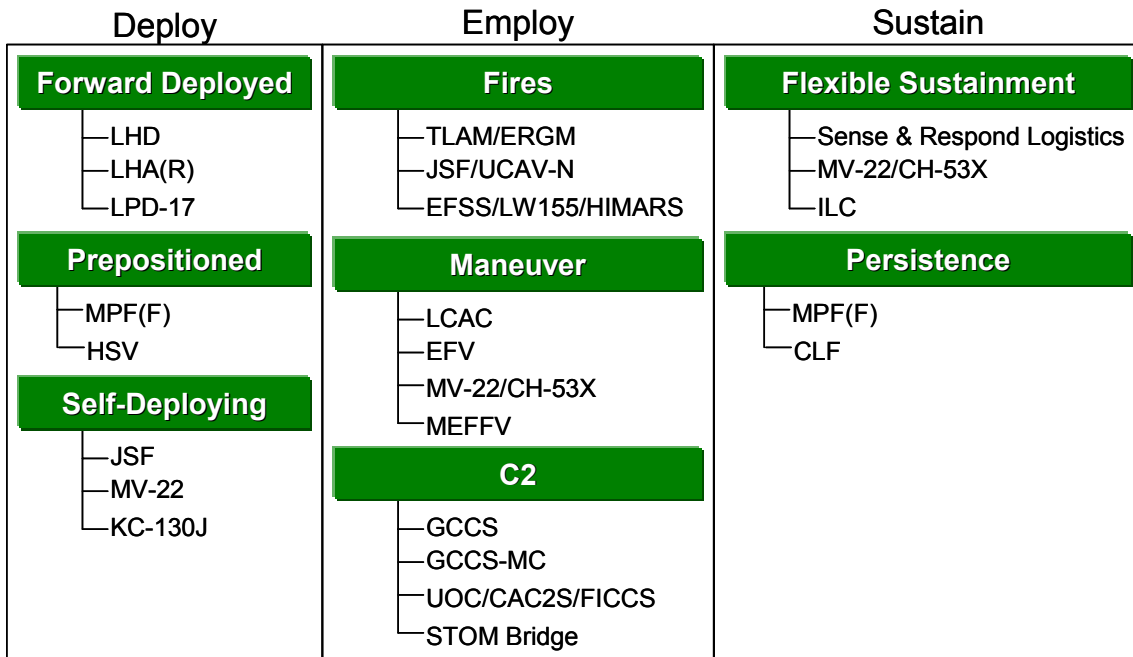

Figure 29: Key Elements of Ship to Objective Maneuver Transformation

Transformational Concepts and Capabilities—Near- and Mid- Term (2005-2015)

Development and fielding of improved capabilities to apply operational maneuver from the sea at the tactical level via STOM in the near and mid-term timeframe is incorporated within the Sea Strike Naval Capability Plan (NCP). Naval work in this area is planned and assessed under the Fires and Maneuver Mission Capability Package and through the Marine Corps’ EMW Capability List (ECL).

Key Elements of Transformational Improvements in STOM Capabilities

Maneuver: Advances supporting STOM begin with the development of advanced capabilities for maneuver itself. Complete exploitation of the battlespace by naval forces based upon the MAGTF begins with the dedicated platforms described in the Sea Base capability section, including the LHA-R, LPD-17, and future Maritime Prepositioning Force (MPF(F)) vessels. It also depends upon a new generation of tactical mobility platforms to project forces ashore. The MV-22 Osprey will provide the high-speed airlift necessary to rapidly move credible fighting forces from ships directly to operational objectives, contributing substantially to the operational agility necessary to establish a sustained dominant maneuver advantage over an enemy force. Its development will also provide USSOCOM with the special operations variant, the CV-22. The expanded capability the MV-22 provides versus the CH-46 will also permit the dedication of our heavy-lift aircraft to insert and sustain the MAGTF with heavy or out-sized cargo. The CH-53X will provide the heavy lift required to transport heavy weapons, equipment, and supplies during STOM, and is an essential enabler of mobile forward area refueling and rearming operations.

On the surface, the Expeditionary Fighting Vehicle (EFV) combines capabilities for high-speed movement across both water and land with armor protected firepower and transportation for forces ashore. The Internally Transportable Vehicle (ITV), also being developed in conjunction with USSOCOM, will replace our current Interim Fast Attack Vehicles (IFAVs), providing critical ground mobility to vertically lifted elements of the MAGTF. Finally, replacements for both the Landing Craft Air Cushion and traditional lighters, such as the LCAC-R and LCU-R, provide the ability to combine high speed vertical lift operations with the heavy combat power and sustainment available for delivery via surface means. The combination of these new mobility sources will give naval commanders dramatically increased flexibility to bring ground forces to bear from unexpected directions, with great speed, at the time of their choosing, and without an operational pause at the beach.

Fires: While fire without maneuver is most often indecisive, maneuver without responsive and lethal fires can be suicidal. STOM will require the longer range and more precise fires that will be provided by a combination of fixed and rotary-winged aircraft, Naval Surface Fire platforms, and the MAGTF's organic ground combat systems, including those described in the Deliberate and Time-Sensitive Strike section above. STOM will integrate decisive maneuver with a variety of fires with increased range, lethality, accuracy, and timeliness from aircraft, ships, submarines, unmanned vehicles, and ground forces. Improved fire support capabilities will be enabled by FORCEnet, allowing the cross-correlation of information from naval, joint, national, and multinational ISR assets and the timely tasking of naval strike capabilities. The ability to provide timely supporting fires and responsive sustainment from secure platforms at sea will eliminate historical sources of operational inflexibility, such as the need for an operational pause and force build-up at the beach, and the need to transport large quantities of supplies and support equipment ashore, actions that slow the operation and reduce its flexibility once forces are committed to a particular avenue of approach. The absence of these constraints will enable the Joint Force Commander to commit more combat power, more rapidly, in a far more flexible manner than in the past.

Navy and Marine Corps aircraft, including the Joint Strike Fighter and AH-1Z Cobra, with extended tactical reach, carrying precision weapons and linked via an enhanced naval fires architecture to Joint Tactical Attack Controllers with the Marine Corps forces via advanced data links, will operate from Carrier Strike Groups (CSGs), Expeditionary Strike Groups (ESGs), Amphibious Forces, and Maritime Pre-positioning Groups (MPGs) to provide more effective

close air support (CAS) at much greater ranges. Next-generation naval guns and GPS-guided ordnance such as the Extended Range Guided Munition (ERGM) and the Long-Range Land Attack Projectile carried on surface combatants will provide expanded direct support capabilities to forces operating ashore. Naval initiatives to increase strike surge capacity, including miniaturized munitions, and the ongoing development of intelligent submunitions, will also play an important role in providing the required quantity of precise, responsive fires to support STOM, while greatly expanding the number of aimpoints that each platform sortie can attack in support of forces ashore. Technologies incorporated into next-generation naval platforms such as DD(X) will also increase the rate and responsiveness of fires through the automation and acceleration of ordnance stowage, sorting, upload, and other facets of munitions handling. Advances in the triad of organic and highly-responsive ground combat fire support, including the Expeditionary Fire Support System (EFSS), the Lightweight 155mm howitzer, and the High Mobility Artillery Rocket System (HIMARS) will allow MAGTF units to integrate considerable firepower with agile maneuver forces, ensuring the MAGTF can conduct high-tempo operations in all weather. As appropriate, the planning and execution of STOM will also integrate the range of non-kinetic capabilities available to the Joint force, including military deception, PSYOP, EW, and Computer Network Attack (CNA).

Communications: STOM will require new capabilities supporting command, control, and communication by forces that are on the move (OTM) and over the horizon (OTH). These capabilities must include support for both precision navigation, and the integration of all available naval, joint, and national capabilities. The FORCENet section describes the majority of these efforts to support future naval forces. Current legacy Marine Corps digital communication capabilities are designed for operation in Line of Sight (LOS) environments. This construct will not work in areas where Marine Corps units are geographically dispersed – either OTH or where LOS operations are obstructed by mountainous or urban terrain. This shortfall will be corrected by the STOM Bridge and Point of Presence – Vehicle (POP-V) concept – a simple fix now that will provide a networked OTH, OTM capability, with minimal changes to fielded communications equipment baseline, but similar to the capabilities of the networked battlespace that will be provided by Joint Tactical Radio System (JTRS) in the 2010 and the Transformational Communications System (TCS) in the 2015 timeframe. The bridge networked architecture will not require significant modification as JTRS and TCS equipment comes on-line - the Marine Corps will replace the POP-V equipment with JTRS equipment and the STOM Bridge equipment with TCS terminals as they are fielded. Finally, the STOM Bridge will provide enhanced warfighting capabilities by better equipping units to fight the type of warfare experienced in OIF and OEF – one of fluid geographic separation - extending warfighting doctrine and Techniques, Tactics and Procedures (TTPs) to take advantage now of the network-centric communications and information exchange capabilities planned for the 2010 and 2015 timeframes.

Sustainment: STOM, enabled by Sea Base capabilities, will reduce the need to deploy forces into relatively fixed and vulnerable forward ports or airfields to conduct operations, dramatically accelerating timelines and reducing operational vulnerabilities for bringing significant forces to bear. However, these changes in our concepts and capabilities for fire and maneuver will demand changes in the methods we use to sustain naval forces, which are being developed as part of the Naval Logistics Integration effort. These include adjustments to our logistics organizations, the further adoption of advanced information technology (IT) systems, and by streamlining cargo packaging, handling, and delivery. Additionally, transformational advances in Total Asset Management will enable the Future Logistics Enterprise in such areas as predictive maintenance and the ability to repair and reconfigure platforms “on the fly.”

A major characteristic of future MAGTF logistic/Combat Service Support (CSS) capabilities will be the realignment of logistics functions and responsibilities—in garrison and deployed—so that they are functional both afloat and ashore. The logistics/CSS capabilities in the MAGTF (minus aircraft support and maintenance) will migrate to the MAGTF's Combat Service Support Element (CSSE) and will be structured along General Support and Direct Support units. The principal strength of this organization is the ability of the MAGTF commander to place CSS capability when and where it is most needed, with a reduction of footprint ashore- footprint with force protection and support requirements of its own. Logistics and other supporting functions will operate from multiple locations. Thus, logistics sustainment can come from a secure sea base, providing tailored support packages for movement directly to dispersed forces. By enabling the Ground Combat and Aviation Combat Elements (GCE & ACE) to focus resources on their primary missions, the MAGTF will realize a substantial enhancement in operational and tactical agility.

Advanced IT systems and Decision Support Tools (DSTs), such as the Single Integrated Ground Picture (SIGP), Global Combat Support System – Marine Corps (GCSS-MC), LogC2, and SEAWAY, will permit rapid planning and evaluation of available combat service support capabilities, integrating sustainment and readiness with naval and joint operations. GCSS-MC is the physical implementation of the enterprise information technology architecture designed to support both improved and enhanced MAGTF CSS functions and MAGTF commander and Combatant Commander (COCOM)/Joint Task Force (JTF) combat support information requirements. GCSS-MC is not a singular system but a portfolio of information technology capabilities that will support MAGTF CSS functions in expeditionary, joint, and combined environments. By implementing standard procedures and IT solutions across the pillars of CSS within the MAGTF, the joint theater, and seamlessly back to the Supporting Establishment, it will be a key contributor to the Global Information Grid (GIG) and help integrate operations and sustainment. The implementation of the GCSS-MC system, with the uniformly accessible Shared Data Environment (SDE), will enable the Sense-and-Respond Logistics (S&RL) capabilities to support maneuver forces both afloat and ashore.

In coordination with the Office of Force Transformation, S&RL will be developed and experimented with by the naval Services as a cross-service, cross-organization capability to provide a task and point-of-effect organized network of logistics resources and capabilities; where any entity (military, government, commercial) within the network is a potential consumer and provider of logistics. It will provide flexibility, robustness, and scalability for joint adaptive warfare. “*Co-evolution*” techniques guide the development of S&RL. The techniques are used to stimulate disruptive innovation through the continuous development and refinement of concepts, processes, technologies, and organizations. The objective is to start influencing change immediately. The transformational logistics context that S&RL support includes: Real Time Management and Control, Prediction and Anticipation, Dynamic Optimization (reallocation-reconfiguration-reprioritization), Seamless Logistics, and Short term Inventory Optimization.

The logistics demand of forces ashore must be reduced by streamlining both what and how items are taken ashore. Additional technology must reduce the size and weight of items taken ashore, improve efficiency in vehicles and equipment, remotely monitor equipment, and by ensure total visibility of logistics assets (both supplies and transportation) and requirements. Advanced packaging must support integrated strategic, operational, and tactical sustainment, minimizing delays as equipment and supplies move from around the world to the most forward tactical units. Advanced intermodal modular packaging techniques will also improve handling and reduce retrograde, waste, and storage requirements. Prescribed loads must be small enough for the maneuver force to move with organic transportation and large enough to

Naval Transformation Roadmap

anticipate possible disruptions in resupply from the sea base caused by weather and enemy action. Future naval capabilities to marry up equipment, assemble mission-tailored packages, and re-constitute at sea will be key enablers for STOM, and are discussed in greater detail in the Sea Base capability section.

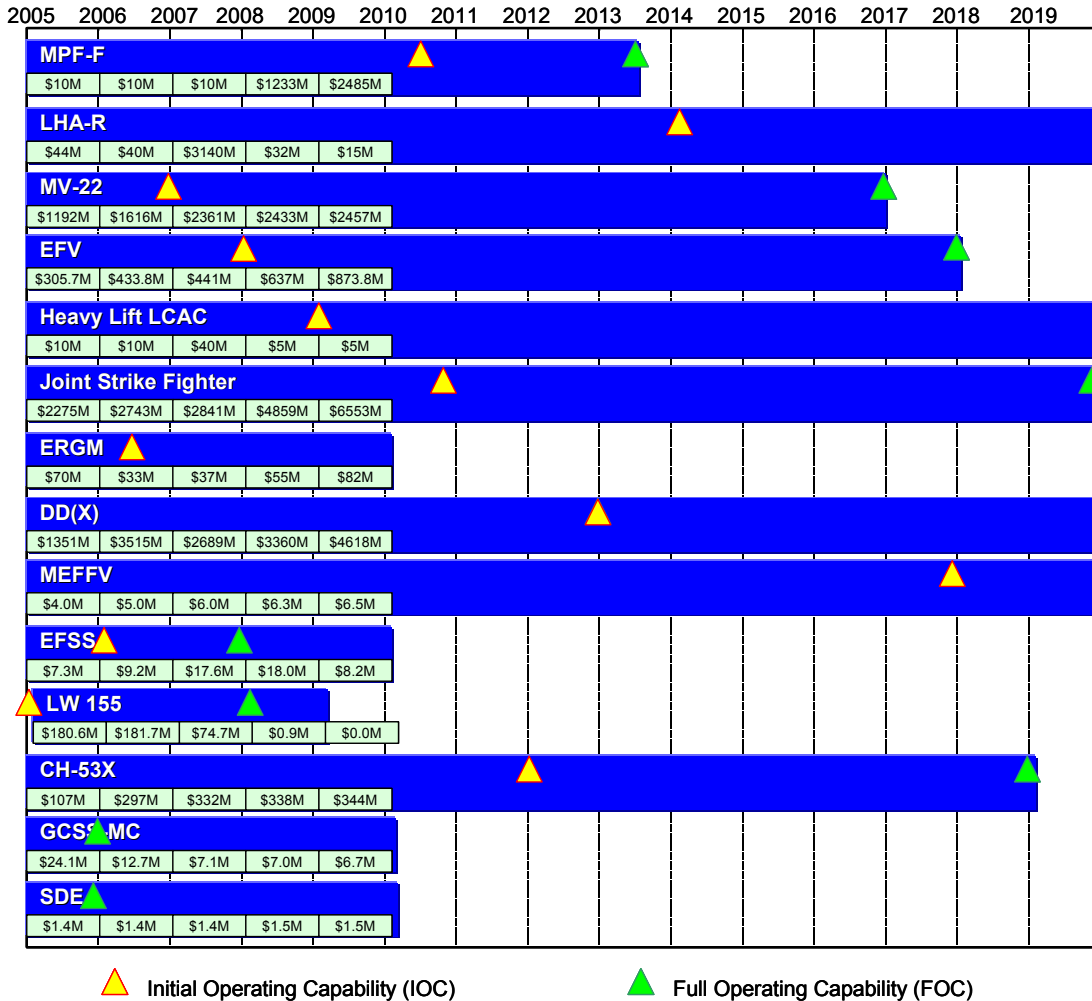

Figure 30: Programs Supporting Transformation of STOM

Transformational Concepts and Capabilities – Long-Term (Beyond 2015)

In the long-term, the application of Ship-To-Objective Maneuver to Operational Maneuver from the Sea by Naval Expeditionary Force elements will incorporate further advances in maneuver, fires, communications, and sustainment, each validated by rigorous analysis and experimentation. Maneuver and direct fire ashore will be provided by the MAGTF Expeditionary Family of Fighting Vehicles (MEFFV), intended to replace the capabilities provided by the current family of LAVs and the M1A1 Main Battle Tank in the 2018-2022 timeframe. MEFFV potentially will consist of other combat, combat support, and combat service support variants, and options to integrate development with the Army’s Future Combat System are being aggressively pursued. Ship to shore movement of vehicles and heavy cargo may be provided by a new generation of high-speed lighters now being considered that exploit advanced hull forms and propulsion technologies. These platforms may also benefit from joint exploration of technology with the Army’s Theater Support Vessel.

Fire support will be managed by a fully netted, joint digital fires network, enabling the massing of firepower from dispersed forces, including hypersonic missiles, electromagnetic guns, long-range projectiles, and miniaturized munitions. Innovative concept exploration and planning is ongoing in several areas, including directed energy weapons, space transport and insertion capabilities, advanced fuel technologies, and the doctrine, organization, training, leadership, personnel, facilities (DOT_LPF) elements that support these concepts and technologies. The future capabilities being explored will produce even more integrated options for joint force power projection throughout the battlespace, leveraging joint, other Service and national assets for ISR and other elements of the operation.

The capabilities developed to support STOM are complementary with those required to conduct Urban Operations. Specific efforts such as See Through The Wall and Standoff Breaching technology will be especially useful in the urban fight. However, ongoing work to provide Small Unit Communications; combat identification and position location; and information connectivity to decision makers will enable a force to exploit opportunities while conducting STOM and while operating in the urban environment. Technologies to mark targets, both day and night, and at micro-distances for the urban fight, will also lead to further capabilities for integrated combined arms on every battlefield. Whether across city blocks or the larger operational battlespace, Navy - Marine Corps Team is developing the ability to conduct coherent multiple, overlapping, and simultaneous operations to achieve Joint Force Objectives.

Both Operation ENDURING FREEDOM and Operation IRAQI FREEDOM demonstrated the potential of STOM by allowing the seizure of Forward Operating Base Rhino and critical oil production facilities at Al Zubayr directly from the sea base. Future STOM operations must be capable of similar operations, at expanded ranges, in a shorter time period, and against a higher threat, without the benefit of available Host Nation support or extended planning and rehearsal opportunities. STOM requires the integration of decisive maneuver with a variety of fires with increased range, lethality, accuracy, and timeliness from aircraft, ships, submarines, unmanned vehicles, and ground forces. The ability to provide timely supporting fires and responsive sustainment from secure platforms at sea will eliminate historical sources of operational inflexibility, such as the need for an operational pause and force build-up at the beach, and the need to transport large quantities of supplies and support equipment ashore, actions that slow the operation and reduce its flexibility once forces are committed to a particular avenue of approach. The absence of these constraints will enable the Joint Force Commander to commit more combat power, more rapidly, in a far more flexible manner than in the past.

STOM Metrics

Progress toward a transformational capability in STOM will be measured in terms of the achievement of warfighting capabilities. As a “mark on the wall,” the capabilities we are pursuing include:

- Projecting the vertical assault forces of a Marine Expeditionary Brigade 110 NM during a single period of darkness in order to conduct immediate tactical operations
- Maneuvering vertical and surface assault forces 200 NM within 24 hours
- Maneuvering smaller forces (reconnaissance, radio relay teams, etc) 240 NM as required to support the MAGTF
- Ensuring sufficient mobility and counter mobility capabilities exist to support maneuver

Progress toward a transformational capability in STOM will be measured in terms of the achievement of capabilities. Mission area capability metrics are listed in a separate appendix.

Support from other Services and Agencies

The following support from other Services and Agencies will be required to enable execution of STOM capability:

- Compatible sensor data from other Services to support ship-based naval fires and strikes by manned and unmanned naval platforms.
- Compatibility of other Service capabilities within a Joint architecture, allowing Air Force or Army “shooters” to act on target information provided by forward naval sensors, both manned and unmanned.
- Continued development of joint “Blue Force Tracking Systems” to exploit the integration of joint fires with joint maneuver across an expanded battlespace
- Coordinated development of joint tactics, techniques, and procedures for urban operations
- Compatible, persistent communication relays and precision navigation capabilities, including UAVs and space systems
- An integrated joint logistics capability which will provide depth to the support for STOM launched from the sea base, and may support other joint forcible- and early-entry capabilities
- Advanced packaging technology to scale cargo throughput from strategic lift through tactical delivery

Planned Sea Trial Activities

Over the next several years, the Navy - Marine Corps Team will conduct a number of concept studies, field experiments, and operational prototyping of key technologies and systems to support the development of the capabilities supporting STOM. Some of these activities include:

- Development of naval strike capabilities, including integrated fires and maneuver, under the OMFTS concept using maritime forces described in the NOC.
- Improved integration of ground forces C2 with maritime operations enabled by the FORCEnet collaborative information environment (CIE).
- Improved combat ID of ground forces by maritime forces enabled by the FORCEnet common tactical picture (CTP) processing.
- Examination of the JFMCC organization and processes enabling the most effective employment of the maritime functional component within the joint task force.
- Consideration of a maritime operations planning process and function-based JFMCC staff organization.
- Continued development of S&RL technologies in conjunction with the Office of Force Transformation to integrate operations and logistics.

The following specific Sea Trial events from the 2004 Exercise plan will support the development of transformational capabilities in STOM:

- Sea Viking 04 Advanced Warfighting Experiment. Preliminary activities December 03-October 04. AWE October-November 04.
- Rail Gun LTE#2. January 04 in Kirkcudbright, Scotland.
- Medical Aspects of Seabasing Workshop. March 04 in Newport.
- Naval Supply Systems Command (NAVSUP) Combat Feeding Tracking Prototype Demonstration. March/April 04.
- MAGTF Distribution LOEs. Mar-Jun 04
- Sense & Respond Logistics LOE. Apr 04
- Silent Hammer LOE #1. June 04 in the C3F AOR.
- Global Engagement 7 (USAF Title X Wargame). July 04.
- Fleet Battle Exercise Lima. CPX September-October 04. Exercise November 04 in the C3F AOR.

C. Sea Base

Transformational Objectives:

The Sea Base Naval Capability Pillar (NCP) incorporates the elements of our naval vision that contribute the mobility and sustainment required to project combat credible and persistent forces anywhere in the world at any time. The threats that the United States will face in this century require the capability of joint forces to conduct a full range of military operations, from small SOF units engaged in combating terrorism to large forces conducting major combat operations. Effective power projection, however, depends on the joint force's ability to rapidly close, effectively employ, and reliably sustain forces. Anti-access technologies including missiles, mines and weapons of mass destruction; and area denial strategies, including regional and ethnic tensions, require new U.S. capabilities for power projection. Representing more than a single system, the Sea Base NCP combines the capabilities needed to provide a sovereign, maneuverable and secure "base" that can be used to assemble, command, project, sustain, and reconstitute combat power, relatively unconstrained by political and diplomatic restrictions.

- **Exploit Maneuver Space Provided by Control of the Sea**
- **Project and Sustain Responsive Forces Worldwide**
- **Minimize Vulnerabilities Tied to Bases Ashore**

Tools developed through the Sea Base NCP will provide our Nation and the Regional Combatant Commanders with unprecedented freedom of action and flexibility, and serve as a basis for new methods of joint warfighting. We will provide a family of maritime platforms, capable of supporting at-sea arrival and assembly, selective offload, rapid movement ashore, combat sustainment and reconstitution of combined-arms MAGTFs, with supporting precision fires which will support a range of joint operations, without reliance on ashore facilities within the Joint Operational Area. The resulting ability to immediately project power from the sea will

develop new capabilities that support Seabasing. During the mid-term, Maritime Prepositioning Groups (MPGs) and their associated Marine Expeditionary Brigades (MEBs) will be available for Seabasing. The results of the near-term S&T investments, and experimentation, will provide increased sustainment support, both for the sea base and the forces operating from it. New platforms entering the fleet such as LHA(R) and MPF(F) will reduce force closure timelines through the ability to conduct at-sea arrival and assembly, and will provide an enhanced capability to employ, sustain, re-constitute, and re-deploy those forces, as required. These changes in the methods we use to organize, deploy, and sustain forces through the sea base will provide future Joint Force Commanders with transformed physical freedom of movement, freedom of action, reduced vulnerability to attack, and increased agility.

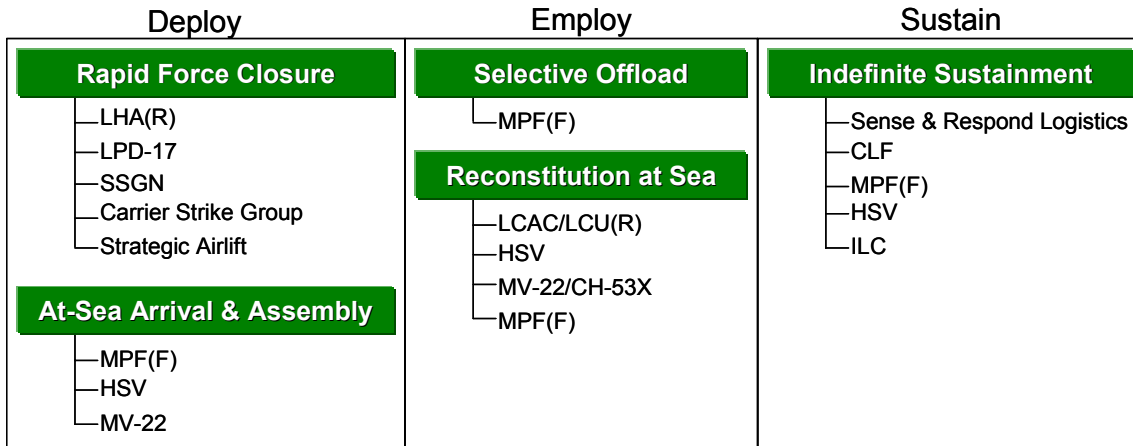

Figure 32: Key Elements of Sea Base Transformation

Closing the Force. Seabasing will provide the JFC with significantly expanded options for rapidly bringing significant force to bear in support of his operational and strategic objective. ESGs with their embarked Marine Expeditionary Unit (Special Operations Capable) (MEU(SOC)) on amphibious ships such as LHA(R) and LPD-17 and supported by DD(X)s, CGs, LCS, and SSGNs, CSGs, and MPGs will continue to be forward deployed and pre-positioned around the world to provide presence and initial response to developing crises. When required, an Expeditionary Strike Force (ESF), consisting of ESGs, CSGs, Amphibious Forces, and MPGs with associated MEBs, capable of conducting a wide range of military operations, including forcible entry operations, can be formed within 7-14 days. Marines will flow from CONUS to advanced bases (AB) or intermediate support bases (ISBs), and on through some type of air or high-speed surface connectors to the MPG, where their equipment is pre-positioned. The ability to flow these troops to the advanced sea base without reliance on land facilities within the Joint Operating Area (JOA) is a transformational change from today's capabilities.

At-Sea Arrival and Assembly. The at-sea arrival and assembly capability provided by the sea base will give naval and joint forces transformational options for rapidly assembling a significant force. This capability will significantly compress the force employment timeline for the MPF from the current 10 days from force arrival to offload in a benign seaport, to a period of 24-48 hours from when forces arrive at the sea base. Through en-route collaborative planning, forces will arrive ready to be married up with the pre-positioned equipment required for their mission, and immediately employed. The key to this capability will be the introduction of the MPF(F) with its designed-in capability to receive large numbers of troops and selectively offload only the equipment required for the assigned mission. This ability to match arriving troops with

their equipment, without the requirement for an in-port offload is a transformational change from today's capabilities.

Employing Forces. The capability to rapidly employ elements of a MEB-sized force within 10 hours and sustain that force indefinitely from the sea base is a transformational warfighting capability.

Seabasing will provide the JFC with significantly expanded options and flexibility for employing the joint force from a secure and maneuverable base of operations. Joint forces, rapidly assembled and prepared for operations at the sea base, will move to their objectives using surface assets such as, Landing Craft Air Cushions (LCACs) and next generation Heavy Lift LCACs (HLLCACs), High Speed Vessels (HSVs), Utility Landing Craft (LCU(R)), and Expeditionary Fighting Vehicles (EFVs). These Joint forces will also be transported by aircraft, including MV-22s and CH-53X Assault Support aircraft. SSGNs, as part of the sea base, will be able to employ a SOF contingent of up to 66 personnel for an extended period of time providing clandestine insertion and retrieval via built in lockout chambers, dry deck shelters, or the Advanced SEAL Delivery System (ASDS). These employment options will provide JFCs with flexible and tailorable range of force packages for conducting operations and projecting effects ashore, from non-combatant evacuation and humanitarian assistance operations to high intensity combat. Marines and SOF projected ashore from amphibious ships and MPF(F) ships, located over the horizon and at least 25 nm at sea, will have the capability to seize critical objectives deep within enemy territory.

High-speed transport vessels will contribute greatly to our ability to project power with expeditionary forces. The Office of Naval Research will conduct risk mitigation demonstrations for high-speed vessel technologies using the X-Craft, scheduled for delivery in FY 2004. Additional research is being conducted into the unique aspects of composite high-speed vessel technologies, such as structural and environmental testing, aviation certification analysis, and lifting body performance assessments.

Sustaining Forces. Near-term experimentation and investments in science and technology, combined with the introduction of new air and surface platforms and the ability to maintain total asset visibility, will improve sustainment at sea, minimize or eliminate time off-station for replenishment, and decrease the time required to flow sustainment to forces operating ashore. The use of the MV-22, CH-53X, HSV, LCAC, HLLCAC, and LCU(R) will enable faster logistics support to forces ashore from greater distances, thus increasing the survivability of sea base platforms by allowing them to operate further off-shore. Investments are being made in advanced technologies that will allow at-sea transfer of heavier cargo, improve station keeping during at-sea transfer operations, and increase the weight capacity of the LCAC, among other efforts.

As currently envisioned, the sea base will be able to accept forces and materiel for sustainment directly from CONUS, from an advanced base no further than 2000nm from the sea base, or from closer intermediate sites, with an anticipated throughput of 2000 short tons per day. Operating 25-100nm from shore, the sea base will be capable of sustaining forces ashore out to a total of 240nm away. The sea base will possess the capability of transferring a maximum of 1500 short tons per day to forces engaged in high intensity operations ashore or other naval forces operating in or outside of the sea base operating area. Sustaining forces operating ashore from the sea base will minimize the requirement for accumulating an "iron mountain" of supplies ashore, reducing both operational pauses during operations and force protection requirements. New initiatives within the Marine Corps' Logistics Enterprise Integration will

Naval Transformation Roadmap

streamline logistics processes, and standardize deployed logistics to best support sea-based operations. Sense & Respond Logistics, as an adaptive method for maintaining operational availability of units by managing their end-to-end support network, may provide a powerful set of tools for sustaining our forces while maintaining the highest possible operational tempo.

Finally, improved sustainment at sea depends on effective maintenance with increased warfighting system availability. Since maintenance consumes about 40% of the Operations and Maintenance budget, ONR is conducting S&T directed at reduced maintenance enabling capabilities. This research and development focuses on technologies that will reduce significantly the labor hours required for maintenance activities, as well as the financial burden of inspection, component replacement, refurbishment, and maintenance procedures.

Reconstituting and Redeploying Forces. Sea Base capabilities will also dramatically expand the options of the JFC by enabling forces to reconstitute at sea, restore combat power and re-deploy. Technologies achieved in the mid-term will enable forces to move back to the sea base via both air and surface means, restore combat power by resting and training personnel, and repair, replace, refit, rearm, and refuel equipment in preparation for re-deployment. This retrograde operation will take place in 12-48 hours with a 48-hour window for re-employment. The redeploying forces may require more services over a longer time, if they are to be recommitted to intense combat operations than to humanitarian assistance operations.

The following table shows the naval investment over the FYDP in programs for developing Sea Base capabilities and the timelines for the introduction of these capabilities to the fleet.

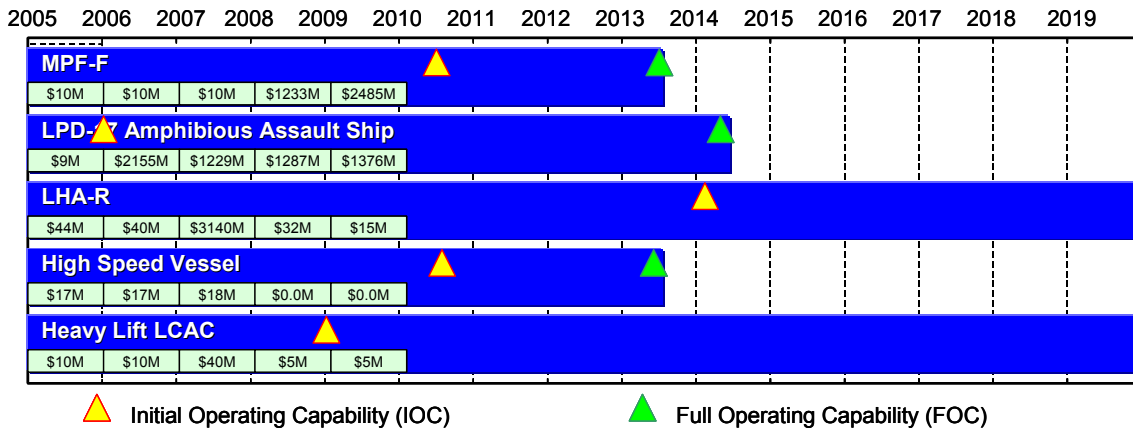

Figure 33: Programs Supporting Transformation of Sea Base

To realize the full potential of Seabasing, technologically based advancements in areas such as selective offload, joint command and control, integration of naval logistics and joint in-transit visibility, at-sea transfer of personnel, inter-modal containers, and out-sized equipment, bulk liquid transfer and delivery, and at-sea reload of munitions are required. These new capabilities will enhance our ability to close the force, conduct at-sea arrival and assembly, employ the force, sustain the force, and reconstitute and redeploy the force.

ONR, through the Future Naval Capabilities (FNC) process, is exploring a number of approaches to enhance the sustainment, onboard material handling, and selective offload from the sea base. This is primarily being advanced by the Expeditionary Logistics Future Naval Capabilities (ExLog FNC). The ExLog team is developing an integrated model of the entire logistics chain, from CONUS departure to delivery to the warfighter, to simulate current and

proposed logistics systems and identify bottlenecks. Involvement with the development of the Sea Base CONOPS, the MPF(F) CONOPS, the MPF(F) Analysis of Alternatives, and other efforts enables the ExLog component of the Littoral Combat Power Projection (LCPP) FNC to identify critical capability gaps and promising technological solutions.

The current Combat Logistics Force (CLF) is sized to provide logistics support to sustain the Carrier Battle Groups of the past, not the CSGs, ESGs and MPGs of the future. An ONR funded study of a Heavy Underway Replenishment (UNREP) system (12,000 pound capacity) determined that an acceptable engineering solution was viable and work is now progressing with Research and Development (R&D) funding from the MPF(F) and CVN-21 programs. The Heavy UNREP system will increase the capability of the CLF but the enhanced CLF will still be unable to sustain the entire sea base.

One option is to leverage commercial shipping to augment the CLF during crisis periods, and to expand the defense sealift capability to support additional platforms beyond the current operating practices. Because the vast majority of commercial shipping is done by intermodal containers, it is anticipated that containerships will be the delivery vessel of choice. Investment is being made in the High Capacity Alongside Sea Base Sustainment (HiCASS) product line to enable the transfer of 20-foot International Organization for Standardization (ISO) containers, or other packaging that can be handled as a 20 foot ISO container (or Twenty-foot Equivalent Unit, TEU), from non-self-unloading containerships to the logistics ships. HiCASS is also investing in technologies to improve the Navy's ability to conduct UNREP safely. As part of naval distribution supporting Fleet and joint operations, the initial transition target is MPF(F), but it will be possible to provide this increased volume handling capability on other CLF ships as well.

The ENS concept requires the ability to selectively offload equipment and supplies in order to provide tailored forces and tailored support packages. The sea base must be capable of rapid resupply from commercial ships through the at-sea transfer of heavy intermodal packaging such as twenty-foot equivalent units (TEUs). New intermodal naval packaging that connects to form TEUs facilitates the breakdown and transshipment within the sea base. The focus for at-sea transfer of actual TEUs will be the MPF(F) ships with the other platforms within the sea base (CSG, ESG and CLF) capable of 12,000 pound intermodal container (similar to current Quad-Cons) transfer. Current breakbulk/palletized transfer capabilities will be maintained to sustain the legacy and coalition forces. The ExLog FNC is making investments in shipboard automation, robotics, packaging, and elevator technologies to enable rapid selective offload with minimal manpower and high stowage densities in MPF(F), and support increased sortie rates in CVN-21 by moving weapons quickly from the magazines to the flight deck. Ropeless elevator product lines are developing technologies, which, when integrated with automated warehousing systems for stores and weapons, will provide maximum flexibility to handle a wide variety of naval cargo. This capability will more effectively support future throughput requirements by enabling cargo to be rapidly moved from the automated holds to transfer and rearm stations on the upper decks. The ability to rapidly stow materials will also reduce the time alongside CLF ships during replenishment.

Current lighterage – LCACs, LCUs, and other craft used to move materials short distances in a Joint Logistics Over the Shore (JLOTS) operation – are limited by sea state or load. Airborne rotary wing connectors like CH53X and MV-22 can operate in higher sea states, but don't have the load carrying capability to deliver the throughput and cannot move many of the large end items like trucks and tanks.

R&D in this area includes the Heavy Lift LCAC (HLLCAC) program, with the ExLog investment focused on the development of high lift propulsion fans and high volume lift fans. HLLCAC will provide increased rapid amphibious transport across a broader variety of terrain, proliferating

support options and increasing the throughput of equipment and assault forces to tactical positions. High Speed Vessel technology is also being evaluated to meet lighterage requirements and to serve other critical intra-theater needs. ONR funded instrumentation of HSV-X1 provided mobility, seakeeping and structural load data to enable a critical assessment of commercial fast ferry technology. This experiment will determine the limits of COTS technology, validate engineering analysis tools for lightweight aluminum catamarans, and identify areas requiring investment, and may benefit the Army's exploration of Theater Support Vessel (TSV) development.

The ExLog component of the LCPP FNC has also developed a line of products focused on sustainment command and control in support of Seabasing. These decision support systems incorporate situational awareness, demand forecasting, and logistics mission planning technologies. The C2 Combat Service Support (CSS) Tool Kit, supporting LogC2 under GCSS-MC, integrates a number of these capabilities and will provide independent and interoperable modules, enabling and automating logistics planning, decision support, execution and assessment.

Transformational Concepts and Capabilities: Far-Term (Beyond 2015)

In the far-term, the naval Services will realize the goal of fielding three operating Maritime Prepositioning Groups (MPGs) to provide full advanced ENS capability in three theaters simultaneously. The continued drive toward commonality of equipment between the Services will increase the extent to which joint and coalition forces will be capable of flowing through the integrated sea base, supporting and being supported from it. Our Seabasing concept depends upon the fielding of capabilities for at-sea arrival and assembly, selective offload, and reconstitution to support the ability of an Expeditionary Strike Force (CSGs, ESGs, Amphibious Forces, and MPGs) to mount a forcible entry operation in any two of four critical regions within 7-14 days.

Joint Support

As the U.S. joint force becomes lighter and more operationally agile, the application and sustainment of joint forces from a secure sea base will enable U.S. forces operating unilaterally or with coalition forces to dominate any adversary or situation within the littorals, across the full range of military operations. Systems developed within the Sea Base NCP will provide a secure and maneuverable location to integrate the Standing Joint Force Headquarters (SJFHQ) with elements of the JFC staff that require actual presence in the JOA along with reach-back support as required to C2 elements outside the JOA. The sea base will be capable of supporting a forward JFC staff (including subordinate components and coalition staff elements) of 500-800 personnel for crises of any nature, throughout the duration of an operation, without displacing or inhibiting combat capability inherently resident in the sea base. FORCEnet will provide adaptable command and control network capabilities that will make naval platforms the optimal location for future JFCs.

Experimentation

Naval forces have been working together to build concepts of operations for the future including the STOM CONOPS (draft) and Sea Base CONOPS (draft). These draft CONOPS are based the Secretary of the Navy's *Naval Power 21*, the Navy and Marine Corps senior concepts, *Sea Power 21* and *EMW*, and the *Naval Operating Concept for Joint Operations*. These draft CONOPS establish the foundation for further concept development and experimentation that will help determine how the Navy - Marine Corps Team will operate in the future.

The FY04 Experimentation Plan outlines Sea Base experimentation objectives and plans. The two long-term goals of Sea Base experimentation are to develop the Seabasing concept and the organization and procedures for the ESG in support of the Global CONOPS. FY04 Sea Base experimentation objectives serve as stepping-stones towards achieving the long-term goals and include: to assess the scalability of the sea base and its ability to support joint forces; to assess the effectiveness of new platforms, systems and other technologies (e.g. selective offload) in support of the sea base; to develop the organization, procedures, and tools required to support an ESG.

The FY04 Experimentation Plan also includes plans to examine FORCEnet in relation to its ability to support ENS concepts. The experiment will study C2 functions that may be more efficiently executed from shore-based locations, identify the FORCEnet capabilities needed to enable a distributed ESG C2 organization to conduct missions, address new procedures required to conduct distributed C2, and study the how FORCEnet might enable the ESG C2 organization to operate with fewer embarked personnel. The following specific Sea Trial events from the 2004 Exercise plan will support the development of transformational capabilities in the Sea Base NCP:

- JFMCC Wargame. Nov 03
- Sea Viking 04 Advanced Warfighting Experiment. Preliminary activities November 03 – October 04. AWE October-November 04
- NAVSUP Smart Store Project Demo. Jan 04
- NWDC/Naval War College (NWC) Medical Workshop #2. Mar 04
- NAVSUP Combat Feeding Tracking Demo. Mar/Apr 04
- Unified Quest (Army Title X Wargame) Game. Apr 04
- NAVSUP Inter-ship Stores Demo. Jun 04
- Joint Task Force Exercise (JTFEX) 04-02. Jun 04
- Global Engagement 7 (USAF Title X Wargame). Jul 04
- Heavy UNREP Equipment Ship Installation. Nov/Dec 04

D. FORCEnet

FORCEnet is the operational construct and architectural framework that will provide the capability to deliver the persistent and comprehensive surveillance, rapid networked command, and common, accurate battlespace picture necessary to support decision making at a tempo that overwhelms an adversary's capability to react and respond. To do this we will field an optimum mix of persistent distributed and penetrating naval sensors that contribute to joint comprehensive surveillance and targeting in all dimensions of the battlespace; jointly-interoperable, secure, and interconnected networks that move data with minimum latencies; and command and decision systems that provide the real-time, common, and precise operational and tactical picture needed by each unit to support its role in the force. Recognizing that space system capabilities are integral to FORCEnet but that most space systems are acquired outside of DON, a proactive strategy will be employed to shape the outcome of joint deliberations on national security space. Building upon the substantial increase in combat capabilities made possible through aligned and integrated systems, FORCEnet is the enabling capability for a fully networked naval force, connecting it to the similarly networked joint force that will be linked together by the Internet Protocol (IP) - enabled, Global Information Grid. Our systems will be

conceived, developed and implemented as truly joint, integrated capabilities – capable of generating improved coalition effectiveness.

- **Connect Sensors, Networks, Weapons, Decision Aids and Warriors from Seabed to Space**
- **Accelerate Speed and Accuracy of Decisions Across Spectrum of Command**

Implementing the FORCEnet vision will link warfighters ashore, at sea, and in the air into a series of highly integrated distributed services networks that are capable of providing critical operational and tactical information to specified users on a rapid and continuous basis. The “publish and subscribe” construct for moving data within the network backplane will facilitate greatly improved, shared battlespace awareness, rapid dissemination of the Joint Force Commander’s evolving campaign plan/”intent,” and faster passing of information about the enemy from surveillance systems through controllers to ready forces with the right weapons for attacking key targets. FORCEnet enhances naval capabilities to quickly make and execute decisions in the battlespace, to synchronize the activities of widely distributed forces to mass effects on the enemy, and to reduce threats to Sailors and Marines by providing broader situational awareness. The distributed services and specialized mission applications carried on FORCEnet are as important to future naval combat capabilities as the platforms and weapons they link. Thus, FORCEnet is a critical enabler of naval force transformation.

1. Networks

Key Elements of Transformational Network Capabilities

Future communications systems will distribute data and information to the warfighter across fault tolerant, adaptable, self-organizing, self-monitoring and healing, continuously available networks. A wide range of transmission paths, interoperable with those used by joint, coalition, civil and law enforcement agencies, will be utilized. Warfighters embarked in net-ready aircraft, tanks and ships will be able to communicate freely and autonomously down to the data-level, while the underlying communications and network infrastructure will be invisible to the users. The infrastructure will also be readily deployable to any operating environment.

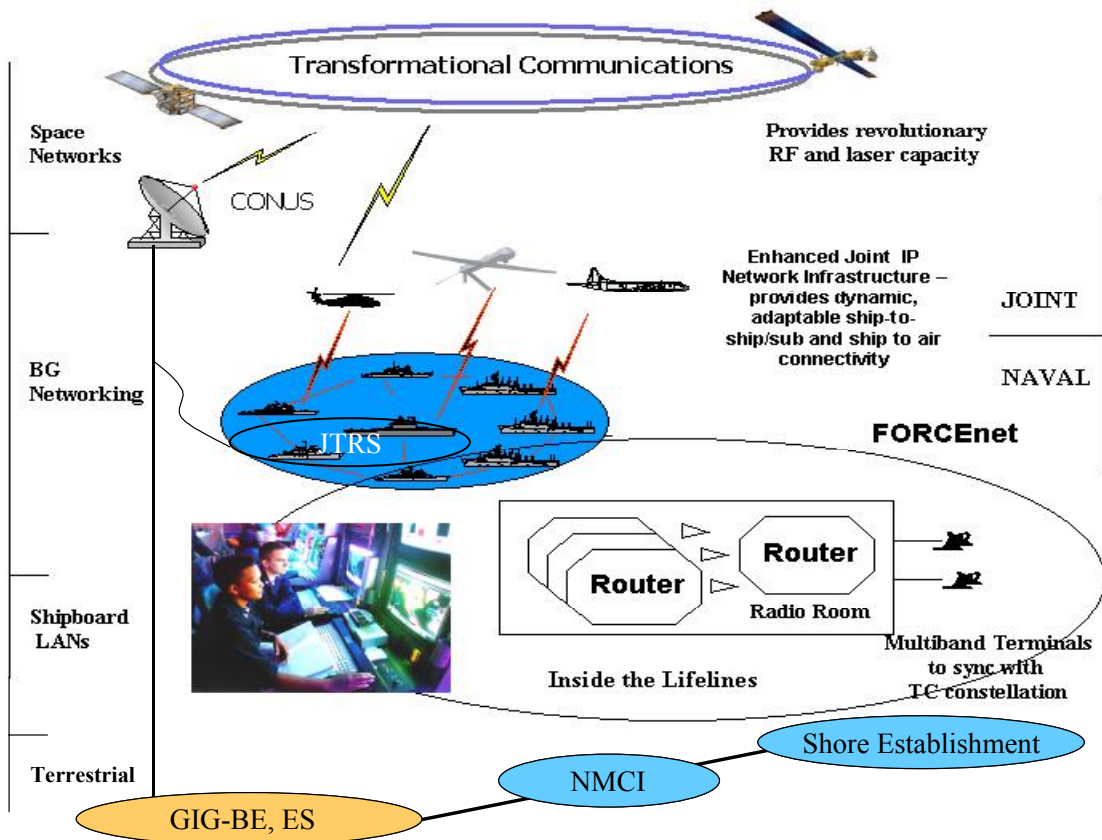

Figure 34: FORCEnet Integrated with DoD Network Infrastructure

Figure 34 illustrates the fully integrated relationships between the various elements of FORCEnet and the DoD-wide network infrastructures. The FORCEnet network infrastructure will contain two major components: the deployed infrastructure and the fixed ground infrastructure. Deployed naval forces will maintain connectivity to the shore infrastructure via satellite communications through Teleports (high bandwidth distribution systems) and Standardized Tactical Entry Point sites, strategically located earth terminals providing a set of pre-positioned services. Deployed Marine forces connect through the MAGTF Tactical Data Network (TDN) ashore with reachback capability to the Global Information Grid (GIG). When not deployed, units will maintain connectivity through the Navy-Marine Corps Intranet (NMCi) for locations in the United States and through the Base Level Information Infrastructure for locations outside the U.S. In all cases, terrestrial connectivity between the major tactical shore components will be provided via the DoD network infrastructure.

Transformational Network Concepts and Capabilities—Near- and Mid-Term (2005-2015)

In the future, the networking elements of the FORCEnet architecture will be positioned to make maximum use of the reach-back capabilities of the Transformational Communications Architecture (TCA) space-based network system, Teleports, and the significantly enhanced terrestrial network infrastructure being implemented under the GIG-Bandwidth Expansion (GIG-

BE) initiative. The GIG-BE will be a cornerstone of the transport infrastructure, enabling worldwide operations by connecting key intelligence, command and operational locations. The TCA will provide advanced wideband satellite communications with very high capacity, protected and unprotected radio frequency and laser communications. The goal of TCA is, to the extent practical, to remove bandwidth as a constraint to military operations.

Teleports are an essential component of the reach-back architecture, providing connectivity to the DoD long-haul infrastructure for deployed/mobile users and providing the capability to automatically pass user information from a channel operating on one frequency band to a channel operating on another frequency band (cross-banding) that enhances communications interoperability.

Naval forces have unique mobility requirements that limit access to available network capacity, despite rapid technology advancements. The FORCEnet communications and network architecture includes alternative communications paths for essential networks to provide the required operational throughput to the warfighters. The centerpiece is the global secure, interoperable family of afloat and ashore IP networks. Allied and coalition networks will be included within this federation through connectivity provided via various gateways and guards, both afloat and ashore. Non-IP Tactical Data Link networks will be included in the federation through the creation of a gateway. Critical warfighting information, such as track data, will be able to flow seamlessly between the IP network infrastructure and the tactical links.

The Joint Tactical Radio System (JTRS) will be the primary means of Line-of-Sight (LOS) radio communications for mobile forces. It will replace virtually the entire current inventory of tactical radios and, UHF satellite communications terminals. The JTRS Wideband Networking Waveform is an example of a key transformational capability that will enable distributed applications services and advanced agent-based computing.

The network-centric environment will enable agile command and control through the use of adaptive, flexible, responsive, self-networking/self-healing networking capabilities that are secure, web enabled, mobile, adhoc, and wireless. The MAGTF TDN expeditionary network will be the deployed tactical portion of the Marine Corps enterprise-wide network and will incorporate future joint capabilities through the Transformational Communication System (TCS) and the Mobile User Objective System (MUOS).

These systems will substantially augment and eventually replace current satellite communications (SATCOM) capabilities and enable a netted force via embedded SATCOM terminals. TCS and MUOS, along with the JTRS, will form the transport layer for all FORCEnet network communications and will be interoperable with the Army's Future Combat System/Warrior Information Network-Tactical (FCS/WIN-T) as well as the Air Force's C2 Constellation. It also provides those network components that will enable FORCEnet to become a reality. As OEF and OIF reinforced, our C4 systems must be mobile, scalable, modular, and able to support joint and combined operations. Our systems must also facilitate the movement of information and situational awareness across the force – down to the individual rifleman, sailor, pilot, or mechanic – and provide a capabilities-based network to support EMW. As enablers, FORCEnet and the Marine Corps' TDN will support joint and multinational operations, strategic agility, operational reach, tactical flexibility, and sustainment of deployed forces.

The RF network must be highly reliable and sufficient to satisfy high data rate information users, as well as the requirements for lower bandwidth of power-constrained forces ashore. Reliable

Naval Transformation Roadmap

network access can only be obtained currently when platforms are within line of sight of one another, or are within line-of-sight of a common relay or routing node, such as a satellite. A tactical, high altitude airborne relay is a potential means of providing area coverage and range extension for platforms or forces that are obscured or operating beyond line-of-sight from one another. ONR is developing an Airborne Communications Payload that can provide high bandwidth relay and routing of tactical link signals originated by sensor platforms or forward communications platforms. Such efforts, if properly coordinated, can produce a significant, affordable capability for the naval forces.

Information assurance and network protection initiatives will provide defense-in-depth capabilities that maintain effective command and control by negating or turning to friendly advantage an adversary's efforts to deny netted information to friendly forces or an adversary's efforts to corrupt, degrade or destroy the friendly command and control network. Sources of intentional network attack will be intercepted, identified, rapidly localized, and ultimately overcome. To this end, the Office of Naval Research is sponsoring the Knowledge Superiority and Assurance Future Naval Capability (FNC) program to focus on issues of connectivity, knowledge superiority and information assurance for distributed naval forces in both the RF and non-RF spectrum.

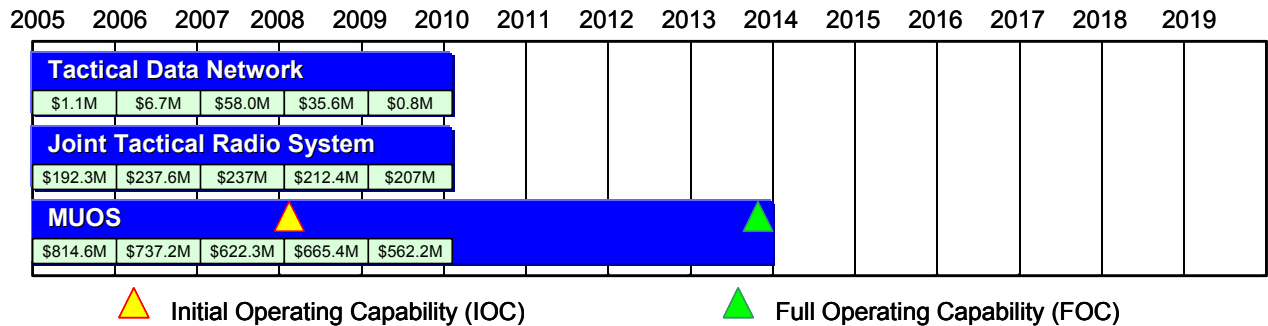

Figure 35: Programs Supporting Transformation of FORCENet Networks

Transformational Network Concepts and Capabilities—Long-Term (Beyond 2015)

The process for developing policy guidance and standards that determine the evolution of the FORCENet communications and networking architecture will include on-going reviews of commercial and military efforts in protocol development as well as assessments of evolving military communications and data sharing requirements. This will include standards of the DoD Joint Technical Architecture and the Internet Engineering Task Force, an open international community of network designers, operators, vendors, and researchers concerned with the evolution of the Internet architecture and the smooth operation of the Internet, and protocol feature lists of major information technology vendors.

Support from other Services and Agencies

The following support from other Services and Agencies will be required to enable delivery of the transformational capability in the network portion of FORCENet:

- Establishment of joint protocols and standards, and adherence to those standards by all Services and defense agencies that provide GIG components, which will directly or indirectly interface with FORCENet.

Network Metrics

Progress toward a transformational capability in FORCEnet networks will be measured in terms of the achievement of capabilities. Mission area capability metrics are listed in a separate appendix.

Planned Sea Trial Activities

Over the next several years, the Navy will be conducting a number of concept studies, field experiments, and operational prototyping of key technologies and systems to support the development of the FORCEnet network capabilities discussed in the previous sections.

The following specific Sea Trial events from the 2004 Exercise plan will support the development of transformational capabilities in Networks:

- Spiral 3a LTE 1 (Multiple Security Levels) July 03-January 04 in Newport and Norfolk.
- Sea Viking 04 Advanced Warfighting Experiment. Preliminary Activities December 03-October 04. AWE October 04.
- JTFEX 04-01. Spiral 2 January 04 in Norfolk.
- Silent Hammer LOE #1. June 04. C3F AOR. July 04 in Southern California.
- Predictive Analysis Wargame. March 04 in Newport.
- FORCEnet ASW Integration LOE (NUW Distributed Lab-Based event). April 04.
- Trident Warrior 04. Preliminary events October 03-May 04. LOE July 04.
- Extensible Tactical C4I Framework (XTCF) Prototype LTE. September 04 in San Diego and Newport.
- Fleet Battle Experiment Lima. C3F. November 04. C3F AOR.

2. Intelligence, Surveillance and Reconnaissance (ISR)

Key Elements of Transformational Capabilities in ISR:

The evolving U.S. defense strategy rests on a foundation of transformed intelligence capabilities. Recent operations including OEF and OIF have confirmed that ISR capabilities will increasingly act as a critical determinant of and catalyst for mission success. Today, ISR provides the linchpin for exploiting our nation's competitive advantages and protecting our vulnerabilities. Future contributions of transformed naval ISR must be understood in terms of strategic direction regarding the role of the naval Services in joint and combined warfighting.

Ensuring U.S. naval forces remain the nation's pre-eminent first responders requires implementation of a strategy for transition from unit- and platform-defined ISR assets to platform-independent, widely-distributed, vertically/horizontally integrated and tightly-networked ISR capabilities. Enabled by FORCEnet, transformed naval ISR will dramatically improve the speed and effectiveness of operations -- expanding the range of options available to the commander and ensuring decision superiority across the range of military operations.

ISR transformation encompasses redesigned sensor and processor capabilities, redefined operational concepts, processes, organizational relationships and culture, as well as personnel training, skills, and performance standards. Naval ISR capabilities and operations are being

reengineered for alignment with joint warfighting concepts, including the JOCs, Joint ISR Operational Concept/Architecture (ISR JOC/JOA), and the JFCOM joint transformation roadmap and Joint Battle Management Command and Control (JBMC2) construct. The dynamics of network-centric operations will translate into redefined standards and metrics for the operational contribution of ISR to an expanded set of military missions.

Definition and Scope of ISR and Naval ISR Operations

Transformed naval ISR will constitute an integrated set of functions and activities that lie at the intersection of today's operations and intelligence domains. Implicit in the roadmap is a new operational concept for naval ISR that addresses capability objectives associated with the 2010-2019 timeframe. Naval ISR operations will be optimized for joint warfighting and for implementation of joint transformational constructs such as Standing Joint Force Headquarters (SJFHQ) and will be merged across today's operations-intelligence boundaries. Naval ISR capabilities will be balanced between organic assets – emphasizing those required for immature theaters of operation – and networked infrastructure required to leverage allied/coalition, national, theater and other Service ISR assets, data and services and to integrate seamlessly with the theater ISR architecture.

Naval ISR operations rely on end-to-end integration of national, theater and Service sensors/collectors, communications segments, and processes that directly support tactical naval operations. ISR capabilities will be viewed as a holistic enterprise integral to Navy's ability to effectively conduct network-centric operations in support of enduring and emerging naval and joint missions. This vision for transformational ISR capabilities provides a frame of reference for measuring progress against specific capability objectives.

Naval ISR Transformation Strategy and Roadmap – Near to Long-Term

Naval ISR capabilities will transition from today's disparate, redundant, legacy, stove-piped systems to an open architecture with commonality across platforms and afloat/ashore/airborne environments, and integrated across DON and DoD. Dynamics of the "information age" reinforce the need to reengineer the architecture. Increasingly, ISR data will be extracted from the battlespace and distributed and posted for processing and use in a continuous rather than cyclical or episodic manner. Increasing network data rates and multiplying indirect nodal connections already result in large quantities of raw ISR data posted for ubiquitous access, but absent traditional source context and meta-data regarding accuracy, certainty, source pedigree and track record. Information management requirements alone dictate transformation of today's capacity to deal with the deluge of data that must be ingested, categorized, processed, exploited, analyzed and fused to arrive at knowledge about events occurring in the battlespace and their underlying causes. Naval ISR will be reengineered to better balance the "load" on the network between the processing and analytical power resident afloat and the capability available in shore-based and reach-back nodes.

Naval Transformation Roadmap

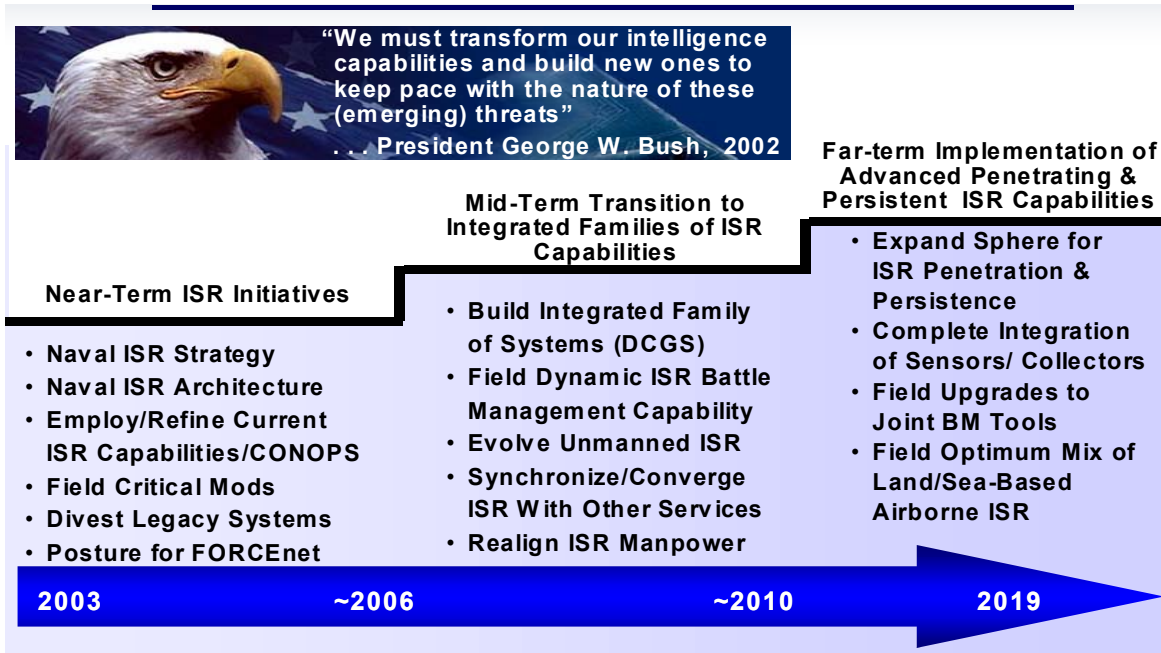

Figure 36: Naval ISR Strategy and Transformation Roadmap

Figure 36 charts the Navy and Marine Corps plan for identifying, developing and implementing naval ISR capabilities necessary for executing joint operational concepts in the future environment. The strategy is shaped by architecture principles and strategic vectors derived from DoD, DON and CNO guidance and from assessment of ISR capability requirements versus resources.

- Network integrated collectors, sensors, processors, data and intelligence;
- Sea-based, long-dwell, penetrating sensors with mission-reconfigurable capability;
- Real-time vertical/horizontal integration of collectors and sensors, processing, data;
- Seamless, on demand interoperation with naval, theater, national ISR architectures;
- Platform-centric to network-centric – platform-independent and autonomous sensors;
- All nodes configured for continuous sensing, reporting and net distributed processing;
- Emphasis on ISR capabilities required to prepare and shape the forward battlespace;
- Expert real-time leveraging of national, theater, other Service ISR assets/resources;
- Improved integration of reach-back capabilities, including ONI FIST and Maritime Security Centers (MSCs), into tactical ISR operations;
- Integrated dynamic, adaptive Battle Management (BM) of ISR assets and resources;
- Human footprint reduced where automated ISR processes best serve operational requirements, and automated support where human cognition is better suited.

These vectors channel the action plan for the ISR components of the FORCENet architecture. Specified requirements, actions and focus areas articulate how the program of record must be enhanced, evolved, migrated, and, in some cases, divested to meet ISR capability objectives.

ISR transformation will be attained through application of penetrating and persistent unmanned, autonomous and stealthy sensors and through employing pervasive, expeditionary sensing capabilities of off-board and platform organic systems. ONR’s FNC process is developing technologies to greatly reduce the need for human intervention in multiple classes of naval unmanned vehicles. These technologies will provide organic unmanned systems that can be

dynamically re-tasked to perform reconnaissance, surveillance, target acquisition, target designation, tactical oceanography and battle damage assessment. This capability will extend the reach of current platforms into high threat, contested shallow-water littorals. Technologies will also be developed under the FNCs that enable the cooperation of multiple heterogeneous unmanned vehicles through networked autonomy. More effective ISR-to-shooter connectivity and enhanced processing power will be required to exploit the dramatic increase in information collected by these systems to support high volume precision naval fires from the next generation of sea-based strike aircraft, from ships and submarines.

ISR Platform Nodes Naval ISR capabilities will be significantly increased by the next generation of multi-mission maritime aircraft (MMA) and Aerial Common Sensor (ACS) as well as naval Unmanned Aerial Vehicles (UAVs) with mission-reconfigurable advanced sensors as well as continued development and fielding of Unmanned Surface Vehicles (USVs), a family of Unmanned Underwater Vehicles (UUVs), and Unmanned Ground Vehicles (UGVs) adapted for littoral reconnaissance. The deployment of families of Navy and Marine Corps UAVs, equipped with various sensors and networked via the Tactical Control System, will play a critical role in extending the reach, coverage, and persistence of the naval ISR systems across the full range of the intelligence spectrum. Acquiring and fielding an optimum mix of airborne ISR capability packages suited to the future operational environment will be a major focus area. This will entail careful balancing of inventory and capability requirements between land-based and sea-based, manned and unmanned, autonomous and controlled, stealthy and protected platform options. In other domains, naval Special Operations Forces will increasingly be relied upon for real-time reconnaissance and surveillance, and SSGNs and VIRGINIA class SSNs will provide critical close-in stealth ISR capabilities.

ISR Sensor Nodes In the distributed services framework of FORCEnet, every sensor in theater becomes an ISR asset; from traditional ISR sensor packages to Special Forces laser designators and the Joint Strike Fighter sensor suite. Every sensor will be netted and configured for efficient and adaptive front-end processing, data tagging and smart reporting of ISR data. Sensors will be increasingly implemented as off-board, platform-independent, and autonomous capabilities. Network integration of sensors will be designed to accomplish cross-cueing, cooperative sensing and, where feasible and prudent, automated target recognition or classification. ISR will include state of the art radio frequency and cyber exploitation capabilities and other sensitive sources of information that contribute to an advantage in battlespace awareness and targeting. Critical enablers of integrated sensor capabilities include communications relay services, ad hoc wireless network technologies, and innovative means to “exfiltrate” ISR data from unattended sensors and special collection programs. Pervasive application of meta-data tagging standards and protocols will also be required. Functionally, the introduction of FORCEnet enabled dynamic ISR asset battle management capability coupled with extensive vertical and horizontal integration of ISR will rapidly erode distinctions between collection management and sensor management.

ISR Processor Nodes Naval tactical ISR data will be fused with that from broader national, theater and joint intelligence activities within the Distributed Common Ground/Surface System (DCGS), the Marine Air-Ground Intelligence System (MAGIS), and the Joint Fires Network (JFN) sub-component. Coupled with skilled ISR operators and TTP appropriate to networked, distributed ISR functions, this fusion will vastly improve the accuracy and speed of actionable intelligence. DCGS describes the family of systems (FOS) that each Service is developing to provide networked ISR support to all warfare areas. DCGS specifically entails migration to multi-intelligence, common, interoperable, open systems ground station architecture. DoD DCGS consists of service unique tactical ISR systems supported by defense agency ISR

Naval Transformation Roadmap

elements, creating a FOS functioning as a highly responsive interoperable collaborative ISR enterprise providing assured, actionable information and knowledge. Navy and Marine Corps DCGS must meet DoD-mandated standards for open-architecture, web-based interoperability to include as many applications and components common to all Services as practical. In this regard, Navy and Marine Corps DCGS will be implemented as the core component of FORCENet ISR capability and will be the ISR backbone supporting the full spectrum of naval and joint warfighting mission areas. Navy and Marine Corps DCGS will receive, process and manage data derived from all intelligence disciplines and all sensor data types. SIGINT components of Navy DCGS will be available via the network from the Ships Signals Exploitation Equipment (SSEE) program and other infrastructure supporting collection “remoting” and distributed national to tactical exploitation. DCGS encompasses not only multiple systems, but also the personnel, processes, and training required to operate the systems and provide intelligence analysis in support of operational decision-making.

The Marine Corps Air Ground Intelligence System (MAGIS) network provides the capability to collect, process, analyze, fuse, and disseminate information derived from all USMC organic intelligence disciplines (imagery intelligence, signals intelligence and human source intelligence) and some theater as well as national systems. A subset of MAGIS is identified as Distributed Common Ground Systems– Marine Corps (DCGS-MC). This emerging architecture meets the requirements of a threshold as outlined in Under Secretary of Defense for Intelligence (USD (I)) DCGS Draft Capstone Requirements Document. The current DCGS-MC includes Intelligence Analysis System (IAS), Joint Surveillance Target Attack Radar System Common Ground Station (JSTARS-CGS), Technical Control and Analysis Center (TCAC) and Tactical Exploitation Group (TEG). MAGIS connects intelligence professionals to multi-discipline joint, national and organic data sources, analytic assessments, and collection assets, supporting MAGTF commanders with the all-source, fused intelligence necessary to make informed decisions rapidly across the dynamic, chaotic and complex battlespace.

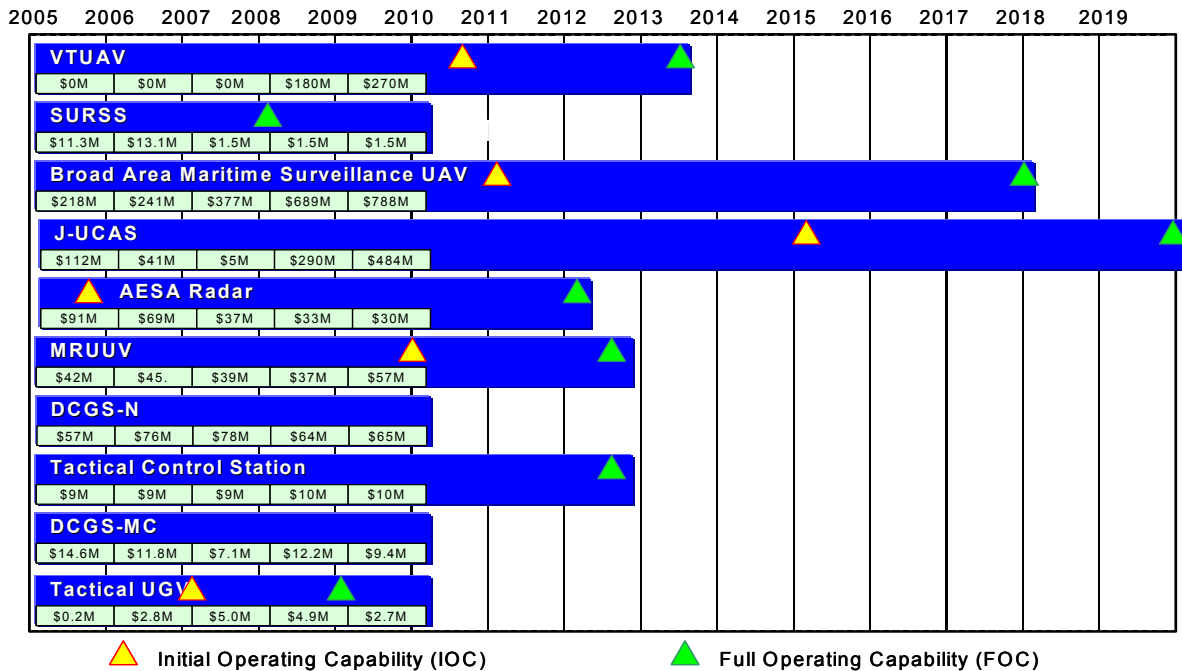

Figure 37: Programs Supporting Transformation of FORCENet ISR

Support from other Services and Agencies

The following support from other Services and agencies will be required to enable attainment of transformational ISR capabilities.

- Extend collaboration on identification and implementation of common DCGS multi-intelligence applications and services, where practical, across all the Services,
- Collaborate in definition, development and implementation of a Common Intelligence Picture (CIP) capability supported by real-time, two-way replication of General Military Intelligence, targeting, and foundation data sets;
- Modify policies to allow implementation Multi-Level Security services in all network domains enabling full interoperability and ISR data exchange capability with allies, coalition partners, and non-DoD agencies and organizations;
- Expand partnership with Army in development and fielding of the Aerial Common Sensor (ACS) asset to meet maritime ISR capability requirements;
- Expand partnership with Air Force in Joint UCAS program for development and fielding of unmanned combat aircraft that meet maritime requirements for persistent surveillance and penetrating reconnaissance;
- Partner with Army to ensure naval capability to leverage advanced unattended ground sensors (UGS), unmanned ground surveillance vehicles, and associated sensor data sets;
- Facilitate on demand access to joint and other Service communications relay (Adaptive Joint C4ISR [Command, Control, Communications, Computers, Intelligence, Surveillance, Reconnaissance] Node [AJCN], Roll-On Beyond Line-of-Sight Enhancement [ROBE], etc.) and ad hoc mobile wireless network capabilities as one means to achieve horizontal integration of sensors and transport of sensor data to processors and users;
- Collaborate on common path to integration of the Transformational Communications Architecture with tactical communications supporting network-centric ISR functions and processes;
- Expand partnership with USCG in defining requirements, architecture, and systems infrastructure facilitating ISR support to maritime security components of Home Land Security/Home Land Defense missions and Maritime Domain Awareness;
- Expand partnership with the DoD space community to ensure naval ISR requirements are factored in to system capabilities and CONOPS from the outset.
- Expand partnership with the National Security Space community to ensure naval ISR requirements are factored into system capabilities and CONOPS from the outset, and ensure that naval requirements are protected during the system development and acquisition process.

Metrics for Transformed Naval ISR operations

Progress toward a transformational capability in ISR will be measured in terms of the value of the ISR contribution to network-centric operations. Metrics appropriate to network-centric and effects-based ISR operations are being evolved. Mission area capability metrics are listed in a separate appendix.

Planned Sea Trial Activities

Over the next several years, the Navy - Marine Corps Team will conduct a number of concept studies, demonstrations, laboratory and field experiments, and operational prototyping of key technologies and systems to support transformation of ISR capabilities. In many cases, ISR capabilities will be delivered in spirals via innovative Sea Trial (USN) and Sea Viking (USMC) events. Related activities will include:

- Embedding and evaluating ISR CONOPS, TTPs and systems functionality in FORCEnet Limited Objective Experiments and Initial Prototype Demonstrations;
- Participating in joint and multi-Service battle lab and field experiments focused on evaluation and evolution or spiral delivery of advanced ISR capabilities;
- Targeting and leveraging of selected joint experiments and exercises for examination of ISR architecture, CONOPS, TTPs, advanced sensors, and systems;
- Leveraging selected joint experiments and exercises for examination of ISR asset battle management/optimization capabilities, automated processing tools, and collaborative environments;
- Exploiting ongoing experimentation focused on JFMCC CONOPS and TTPs to refine ISR functions, activities, and capabilities supporting the JFMCC;
- Investigating Air Force DGS-X model for evaluating ISR systems and applications from the perspective of transformation and compliance with architecture standards;
- Developing and demonstrating tactical UAV capabilities in the Fire Scout demonstration;
- Examining maritime long-dwell UAV requirements/capabilities via Global Hawk Maritime Demonstration and Broad Area Maritime Surveillance (BAMS) program;
- Examining CVW-integrated, ship-launched and recovered ISR capability leading to development of the joint unmanned combat air system (J-UCAS);
- Examining surface ISR requirements and capabilities via SPARTAN USV integration in experiments and exercises;
- Leveraging Autonomous Operations Future Naval Capability (FNC) research with UUVs in experiments and demonstrations;
- Continuing examination of Tactical Exploitation of National Capabilities (TENCAP) initiatives in experiments and demonstrations;
- Leveraging work of NWDC's Warfare Innovation Development Teams (WIDTs) and the CNO's Strategic Studies Group (SSG) to drive Sea Trial experimentation;

3. Common Operational and Tactical Pictures (COTP)

Key System Elements of Common Operational and Tactical Pictures

Another key to network centric warfare operations, increased speed of command, and self-synchronization in force execution is the widely shared awareness provided by networked dissemination of the common operational and tactical pictures (COTP). The COTP will be underpinned by an accurate, time-tagged, geo-spatially referenced database of operational and tactical information, available via an IP-based network to all users, with individualized presentations tailored to the needs of specific users.

A key aspect of the Department of the Navy's challenge is developing the information backplane that enables delivery of the right information to the right users in the right format at the right time. Transformational information management technologies and processes will be developed

Naval Transformation Roadmap

to ease the burden of dealing with unprecedented volumes of data and information. With improved ability to collect and disseminate information, commanders will require the capability to assess information that is generated at lower levels without being overwhelmed, impeding decisions or slowing operational cycles.

The naval solution is a natural extension of the planned joint command and control operational vision. The elements of FORCEnet will employ a common set of core Network Centric Enterprise Services (NCES) that will be used throughout DoD. This approach will allow mission application solutions to be developed by Communities of Interest (COIs) such as those providing timely fires directly supporting maneuver forces, the cross-cueing of ISR collection, the mounting of time-sensitive attacks, and executing focused, time-definite delivery logistics. All of these COIs are addressing a common problem and share common needs. Figure 38 depicts this future network architecture that will support the creation, continuous updating, and wide sharing of the common operational and tactical pictures. The core services noted are being developed by the Defense Information Service Agency and will not be duplicated within the FORCEnet architecture; rather, they will be used and leveraged by the naval COIs.

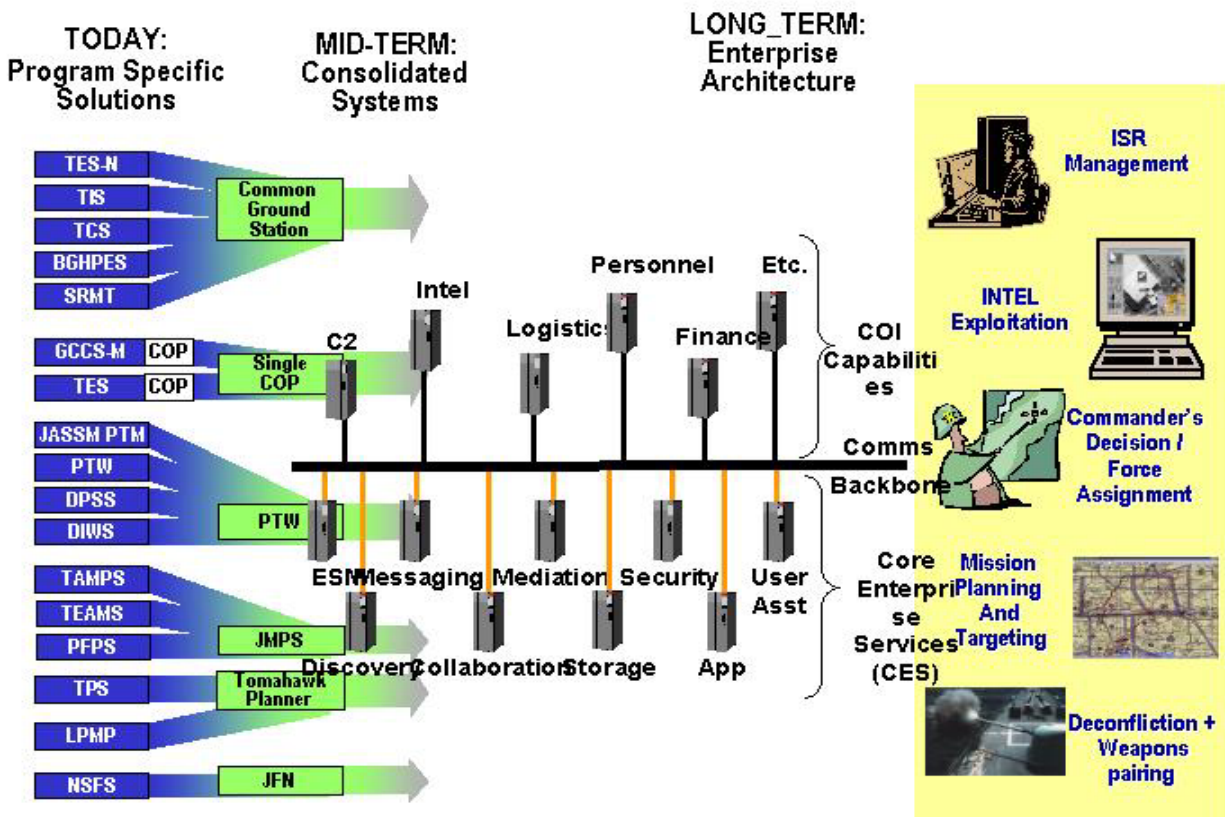

Figure 38: Examples of Alignment and Consolidation of Programs to Common Joint Baselines

A common set of collaboration, coordination and direction business rules (doctrine) will be employed to ensure each node (platform) can exchange information as needed. The collaboration, coordination and direction tool set will enable the deployed force to connect to “reach-back cells” that provide direct support to the deployed command element. These reach-back cells not only will provide direct support, but also will have the ability to connect into the DoD’s subject matter expertise at each of the services laboratories, warfare centers and doctrine organizations.

Common Operational and Tactical Pictures Transformational Concepts and Capabilities—Near and Mid Term (2005-2015)

The information technologies required to meet FORCENet COTP goals will be diverse. The technologies/functions required to meet future needs for dynamic and adaptable forces of distributed, diverse platforms and sensors to support wide area battlespace awareness and focused targeting, includes multi-sensor data fusion from both organic and non-organic sources, platform and sensor management, distributed processing, and information visualization and decision support.

Technical capabilities in each of these areas exist to some degree today but not in a form that allows rapid information generation and assured interoperability with any appropriate user, in any desired command structure. It is envisioned that technical capabilities and systems in these areas will have to evolve considerably, in combination with new TTPs, CONOPS, doctrine, and organizations to achieve FORCENet goals.

In the mid-term, legacy systems that feed or provide the COTP and interim Blue Force Tracking capability will be integrated selectively through evolving standards. The GIG Enterprise Services (GES) is a transformational initiative to replace the current Global Command and Control System mission applications with a web-services architecture for information support to users throughout the DoD. GES consists of a set of Network-Centric Enterprise Services (NCES), which provide core services commonly used across the DoD enterprise, and common applications that are designed around COIs. The core services to be provided will include: messaging, directory, discovery, mediation, collaboration, security, storage, application, user assistant, and enterprise systems management services. Additionally, GES will provide the means to conduct adaptive mission planning and rehearsal (AMP&R) allowing sea based forces to conduct joint training, rapidly plan joint operations, and adapt the plan to changing situations, all based on the common picture developed by persistent ISR. AMP&R will be a critical capability at the strategic, operational and tactical levels of operations. GES will change the way warfighters receive and process information, as well as the business processes associated with many of the individual functions performed. Users will be able to rapidly leverage COI data producers and prompt their release of real-time data to a global data repository for use by decision makers.

Specific new and continuing developments being pursued by each of the services, the Defense Advanced Research Projects Agency (DARPA) and industry will be leveraged to address the technical areas listed above. The capabilities achievable in the 2015 time period are data fusion automation, platform/sensor planning, distributed processing, multi-level security, and integrated information visualization.

Delivering actionable knowledge to the operator, from commanders down through junior Sailors and Marines, requires modifications to the existing paradigm of viewing systems and operators as different entities. Systems and operators must now be viewed as interdependent design parameters when building capabilities. Human Factors Engineering, Cognitive Sciences and Intelligent Agent-based applications are key parts of this effort to enable delivery of the right information to the right users in the right format at the right time – actionable knowledge. Knowledge Management also requires transformational shifts in the training environment in order for operators to understand and exploit the coming knowledge superiority from FORCENet enabled network-centric operations.

Other capabilities that will be required to enable the COTP implementation outlined in this section include a defined information infrastructure, an integrated laboratory environment like the FORCEnet Composable Environment, leveraging existing facilities and incorporating recent advances in modeling and simulation, and the use of spiral development processes to move incremental technical capabilities from the laboratory to the fleet through Sea Trial.

COTP Transformational Concepts and Capabilities—Long-Term (Beyond-2015)

Future demands for maintaining situational awareness will require increasing degrees of automation to monitor large numbers of sensors and maintain large numbers of diverse targets over the battlespace. Advances in information technology will enable increasingly sophisticated automation tools for dynamically planning and executing operations. At the same time, the accelerating pace and complexity of military operations make such tools ever more necessary.

Future COTP development will build on a studied understanding of the appropriate use of technology and automation to co-evolve the technology with the CONOPS and TTPs to provide the greatest possible enhancements in automated performance, suited to human needs and training. This iterative process will likely require the continuing evolution and upgrade of the information framework, an upgraded integrated laboratory environment and continuing use of spiral development processes to move incremental technical capabilities from the laboratory to the fleet.

Support from other Services and Agencies

The following support from other Services and Agencies will be required to enable delivery of the transformational synergies embodied by the COTP:

- Definition and adherence to Joint standards for assets feeding data into or using the COTP, including common data formats and standards for establishing trusted networks using multi-level security
- Active coordination with JFCOM, the defense agencies and the Services on development of systems and architecture components to ensure their compatibility and the timely resolution of issues

COTP Metrics

Progress toward a transformational capability in COTP will be measured in terms of the achievement of capabilities. Mission area capability metrics are listed in a separate appendix.

Planned Sea Trial Activities

Over the next several years, the Navy will be conducting a number of concept studies, field experiments, and operational prototyping of key technologies and systems to support the development of the COTP. The following specific Sea Trial events from the 2004 Exercise plan will support the development of transformational capabilities with respect to development of the Common Operational and Tactical Pictures:

- Sea Viking 04 Advanced Warfighting Experiment. Preliminary Activities December 03-October 04. AWE October 04.
- Spiral 3b LTE 2 (Agent-Based Computing). November 03-May 04 in Norfolk.

- JFMCC Wargame November 03 in Newport.
- Terminal Fury 04. December 03 in Commander, 7th Fleet (C7F) AOR.
- Spiral 2 JTFEX 04-01. January 04 in Norfolk.
- Silent Hammer LOE #1. June 04 in the C3F AOR.
- Trident Warrior 04. October 03-July 04. Wargame July 04.
- Joint Combat ID and Evaluation Team Exercise (JCIET). May 04 at Joint National Integration Center (JNIC) Colorado Springs.
- FORCEnet ASW Integration LOE (NUWC-Distributed Lab-Base Event). April 04.
- JTFEX 04-2. June 04.
- XTCF Prototype LTE. September 04. San Diego and Newport.
- Fleet Battle Experiment Lima. CPX September-October 04. Exercise November 04 in the C3F AOR.

FORCEnet Processes to Achieve Success

The highly dynamic nature of information technology highlights the importance of strong and flexible processes for ensuring that key FORCEnet objectives are met, including choices of technologies and approaches that best fulfill evolving Joint warfighting requirements, and are consistent with Joint architectures and standards. The FORCEnet construct must also comply with the respective interface requirements for each of the joint C4ISR programs (e.g., JTRS, Deployable Joint Command and Control [DJC2], MUOS, SIAP, SIGP, Single Integrated Maritime Picture [SIMP]) with which information is to be exchanged. The following section outlines some of the proven processes followed by FORCEnet to successfully accomplish its transformational goals.

Joint Service Integration FORCEnet represents a transformational shift from platform-centric operations to global, distributed, combat operations using the family of fully networked, composable systems available to the operational commander.

The processes and organizational structures for implementing FORCEnet are designed to ensure that it plays an integral role across the range of Joint warfighting architectures. Working with the Air Force Command and Control and Intelligence, Surveillance and Reconnaissance Center, the Army Training and Doctrine Command, the Naval Education and Training Center, the National Reconnaissance Office, the DoD Executive Agent for Space and the services' lead SYSCOMs (Space and Naval Warfare Systems Command, Marine Corps Systems Command, Air Force Electronic Systems Command, Army Communications Electronics Command), this joint integration effort will ensure the Secretary of Defense's direction to organize train and equip as a joint force rather than as individual services is carried out.

With continuous integration among the major efforts indicated above, the service-specific initiatives will adopt and migrate towards the joint solution space represented by dominant architectural constructs like the GIG and the TCA and augmented by the best available service proposals selected from the service-specific initiatives. Only essential service unique applications will remain in the domain of the service-specific architecture. This notional transformational migration strategy will contain potential for spiral or block development of various service initiatives as they migrate towards the joint solution.

The FORCEnet Operational Advisory Group (OAG) will lead an integrated requirements process designed to provide a fleet-validated catalog of naval operational needs that FORCEnet must enable across Sea Shield, Sea Strike, and Sea Base. The process will produce a User Needs

Catalog that will be used in concept development, innovation, experimentation, architectural development, assessments, development of investment and acquisition strategies and the integration efforts with joint services and agencies, bringing Fleet and MAGTF commander needs to the forefront of operational requirements discussions.

Co-development of CONOPS, TTPs, and available technology solutions covering the full spectrum of Doctrine, Organization, Training, Materiel, Leadership, Personnel and Facilities (DOTMLPF) alternatives will be achieved through the innovation and experimentation continuum elaborated in a Concept Development and Experimentation Campaign Plan. The Trident Warrior series of Sea Trial, in conjunction with the Sea Viking series from the Marine Corps, are focal points for FORCENet innovation, using operational concepts-based experimentation for evaluating new FORCENet requirements and viable technologies. Additionally, a deliberate leave behind strategy for transition of these viable technologies to fielded status will feed into the disciplined speed to capability acquisition strategies described below.

The Office of Naval Research (ONR), in partnership with DARPA, Industry, Space and Naval Warfare Systems Command (SPAWAR) and other SYSCOMs and select technology venture capital opportunities through the Naval Venture Initiative Technology Exploitation, has developed a Science and Technology (S&T) Roadmap of viable, relevant technologies for FORCENet. The innovation continuum will demand acquisition domain agility in formalizing deliberate leave behind of capabilities, including transition of selected S&T opportunities from this roadmap, and execution year modifications to programs of record to initiate spiral development of critical technology capabilities without having to wait two years for Program Object Memorandum (POM) submissions to take effect.

This transformational acquisition agility must still exert deliberate influence on existing POM and acquisition processes to improve speed to capability while recognizing and addressing DOTMLPF implications. The FORCENet Chief Engineer, SPAWAR and other Naval SYSCOMs, the Program Executive Officers and the Assistant Secretary of the Navy (Research, Development and Acquisition) (ASN(RDA)) Chief Engineer, are establishing the processes and policies to formalize this acquisition agility in improving disciplined speed to capability for FORCENet.

Architecture and Standards The FORCENet Integrated Architecture will be fully integrated with the DoD network and communications architectures and also fully compliant with the DoD IT Standards. It will serve as the guideposts for shaping the development and preplanned product improvement migration towards delivering FORCENet capabilities.

The architecture and standards will be used for assessments in developing Navy and Marine Corps investment strategies and for FORCENet certification and compliance of programs during acquisition and prior to fielding. The integrated architecture will also be the vehicle for FORCENet integration with joint service and agency initiatives. The C4ISR and Combat Systems communities' convergence on functional module development and allocations, design guidance that decouples software development from hardware development and a standardized computing environment will facilitate FORCENet implementation.

Open Architecture The FORCENet Open Architecture development effort is a cornerstone in the foundation of FORCENet enabling capabilities. The C4ISR and Combat Systems communities' convergence on functional module development and allocations, design guidance that decouples software development from hardware development and a standardized

Naval Transformation Roadmap

computing environment that will satisfy a range of quality of service demands up to and including essentially real-time deterministic operations, provide the kernel of technical capability to implement global distributed combat system's services.

The national military strategy calls for the services to operate as a fully interoperable and integrated joint force. The Navy and Marine Corps will leverage theater, national and organic assets to ensure there are sufficient resources available to execute missions assigned by the Regional Combatant Commander. FORCEnet is more than just better communications, higher capacity networks and better applications for interfacing with these joint and agency assets. FORCEnet is the transformational enabling infrastructure to conduct global distributed combat operations.

IV. TRANSFORMATION PROCESSES

The Navy - Marine Corps Team (active, reserve and civilians) is an effective fighting force that has consistently capitalized on technological and operational innovations. Capabilities we have developed across our history, including carrier aviation, amphibious warfare, vertical envelopment, underway replenishment, nuclear power, the Marine Air-Ground Task Force, and Aegis integrated air defenses are examples of a rich intellectual heritage. By achieving greater commonality, we strengthen the foundation for future integrated naval operations, and set the scene for increased Joint integration among all Services.

Major changes to culture are long-term endeavors, and achieving fully integrated naval operations may require a full generation. Organizational changes that reduce unnecessary redundancies can increase efficiency and optimize the allocation of resources while providing a more potent fighting force. Combining units with complementary capabilities that have overlapping missions and functions will enhance the overall capability set while streamlining overhead. Therefore, the first significant steps in the way ahead will be those philosophical, conceptual, doctrinal and organizational actions that will lead to greater integration. The initial *Naval Transformation Roadmap* and the *Naval Operational Concept for Joint Operations* are significant accomplishments toward this integration.

Sailors and Marines are integral to effecting transformation. Historically, both the Navy and Marine Corps embody the culture that will be at the heart of the future naval force. However, the environment in which our people—Sailors, Marines, civilians, and contractors—must operate has changed significantly since the All-Volunteer Force military was established thirty years ago, when the world was in the grips of the Cold War with its bi-polar orientation: the West versus the Soviet-Warsaw Pact. In contrast, since the fall of the Berlin Wall in 1989, the world became multipolar, dominated and characterized by globalization. Today, threats to safety and security come from multiple directions, often in diffused and difficult to predict ways. As the geopolitical ground shifts in ways not before imagined, so have the means to produce military, political, and economic opportunities for those who are agile and entrepreneurial. As a result, in the Global War on Terrorism, our military forces are conducting more operations to more different places than anytime in the past thirty years. Along with this shift towards globalization, the world now

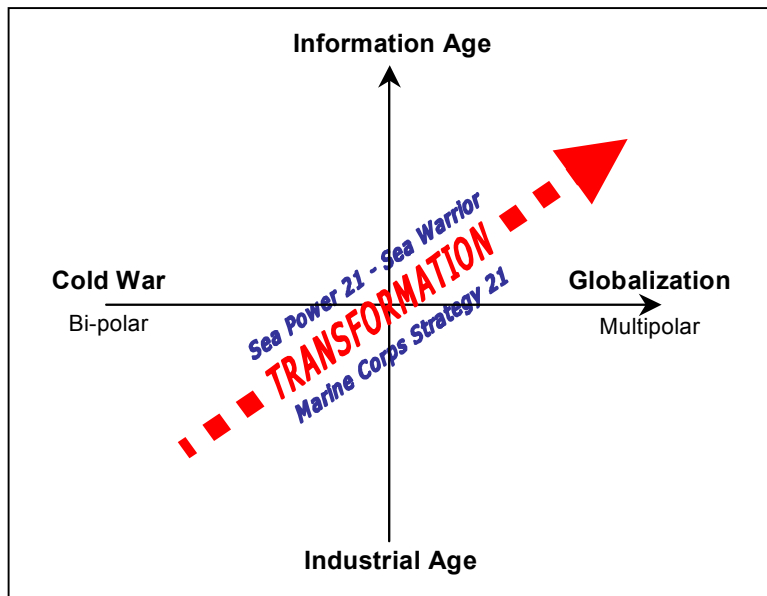

does business in profoundly changed ways, moving from the Industrial Age to the Information Age. Information technology and business processes have evolved to faster and more accurate products at lower costs. People are adapting to these changes in the workforce, changing careers and jobs more frequently, learning to operate in a knowledge-centric environment, expecting higher responsiveness from management, and significantly increasing productivity. Naval personnel are likewise acquiring the technology and the skills to succeed in this new environment, and the abundance and accessibility of information is enhancing the performance

of our warfighters and those who support them. Whether conducting precision maneuver on the battlefield, locating and identifying fast moving threats, or managing global sustainment assets, naval personnel are expected to be experts in the Information Age. To support their efforts, naval personnel management systems need to be agile, flexible, integrated, cost efficient and effective. Sea Power 21 and the Sea Warrior initiative, and Marine Corps Strategy 21, provide the framework for supporting these transformational efforts. Transforming to an integrated naval force requires institutionalizing fundamental changes, including more effective integration with and utilization of our reserve forces, while remaining true to our warrior cultures. Historically, both Services have produced committed, dedicated, and professional warfighters. The Navy will continue to do this through implementation of Sea Warrior, which reflects its commitment to the continued growth and development of its people. The Marine Corps will continue to make Marines through a rigorous process that focuses on building cohesion while preparing Marines for the physical and psychological challenges of battle.

A. People and Culture

1. Sea Warrior

Sea Warrior is the human resource component of the Navy's Sea Power 21 transformational effort. The purpose of Sea Warrior is to maximize human capital, placing optimally trained Sailors in jobs that best suit their talents, skills, abilities and desires. The ultimate objective is to minimize a Sailor's time-to-competence, leading to a marked improvement in Fleet operational readiness.

Realizing the need to accomplish a broader, more complex mission in the future, Navy leadership recognizes the need to develop a single integrated business process that places Sailors in the right jobs, in the right location, at the right time, thereby maximizing Fleet readiness. This will have to be done with a smaller force that is better trained, educated, and motivated to perform critical tasks to meet 21st century mission requirements.

The development of Sea Warrior initiatives is focused on accelerated capturing of requirements, rapid development of new prototype processes, and conducting timely, and effective pilot programs in the Fleet to validate new approaches. Further refinement of new Sea Warrior processes will occur in an iterative, spiral-development-fashion, taking full advantage of feedback from the Fleet.

The Sea Warrior program reflects the understanding that the integration of training and education at appropriate levels of the professional development for Sailors and Marines creates a shared experience that facilitates improved understanding, communication and coordination between the Services. Successful integrated training and education programs, such as the Naval Justice School, Expeditionary Warfare Training Groups Atlantic and Pacific, Amphibious Ready Group (ARG)/MEU(SOC) workups, and initial naval aviation flight training, increase both warfighting effectiveness and training efficiency. As the integration process in logistics, C2, mission planning and naval fires/tactical aircraft within the naval Services mature, Sea Warrior will work toward a single, common system of training and education.

As the Navy defines and builds the Information Operations (IO) Career Force, Sea Warrior will be a crucial part of the development and implementation. The IO Career Force will be composed of Specialists in each of the five Information Operations core areas as well as Information Operations Planners who are experienced in all facets of this warfare area. It will include Officers, Sailors and civilians from many communities within the Navy with the goal of

developing a technically competent and professionally competitive IO Career Force. As we identify the skill requirements and billets necessary to mature Information Operations in the naval force, Sea Warrior will assist in developing training for warfighting strategies and technical capabilities for current and future fleet operations while dynamically managing our personnel throughout their professional careers.

The 18 October 2001 Secretary of Defense Memorandum, Subject: National Security Space Management and Organization specifically tasked the Secretaries of the Military Departments to promulgate guidance on the development and maintenance of a cadre of space-qualified professionals comprised of military and civilian personnel in sufficient quantities to represent their Military Department's interests in space requirements, acquisition, and operations. This guidance would also ensure each Service generates a sufficient number of appropriately qualified personnel to man joint space organizations as well as function as space experts within Service organizations. In response to this and subsequent additional guidance, the Navy has appointed a Naval Space Cadre Advisor, identified an initial group of space cadre officers and is working toward identification of enlisted, civilian and reserve cadre members. The Naval Space Cadre is defined as a distinct body of expertise horizontally integrated within the Navy and Marine Corps active duty, reserve, and civilian employee communities.

As part of this process, the professional education curricula of the Naval War College and Marine Corps University will be more closely aligned to teach common elements of our warfighting philosophy. Navy and Marine Corps officers will be given increased opportunities to attend each other's service school. Training on equipment operated by both Services will be evaluated as candidates for integration, including F/A-18 maintenance training, Joint Force Air Component Commander (JFACC) staff and Theater Battle Management Core System training, and network operations and information technology training. The Naval Postgraduate School and the Naval War College will continue to increase their curriculum coordination and integration. Follow-on Sea Warrior analyses will explore other areas where additional integration opportunities are appropriate. Where full integration is not applicable, Sea Warrior will seek to use training and education venues to help build elements of the common warfighting philosophy, conceptual understanding, and integrated operational culture.

Sea Warrior will also incorporate cutting-edge technology into the naval personnel system. The Capable Manpower FNC is enabling a revolution in personnel management, training, and human-systems integration. The FNC programs are developing technologies to match Sailors' knowledge, abilities, aptitudes and preferences with their fleet assignments. Through this series of initiatives, Sea Warrior is working to ensure the abilities of individual Sailors and Marines are used most effectively in support of the naval contribution to the joint warfighting capability. Advances in training and simulation technologies will drive a complete overhaul in naval training. For example, Virtual At Sea Training (VAST) is a family of transformational training technologies that exploit advances in Modeling and Simulation to give combat units the ability to employ live or constructive fire against simulated targets in synthetic geo-specific terrain. This capability will allow realistic, deployable mission training at any time or place.

Sea Warrior will integrate all component human resource core processes including career planning, personnel distribution, mission performance (Fleet) readiness and a Sailor- and Marine-centric acquisition system. Sea Warrior will bundle all of these core processes into a web-based, information-rich environment.

Development of the four components of Sea Warrior cited above will be integrated and synchronized across several organizational boundaries. A project management business

process is in place to provide the necessary integration and synchronization by controlling the scope, facilitating progress, managing resources, and adjusting priorities. Sea Warrior is being executed in a coordinated fashion, with full realization that it must ultimately be fully integrated with the Defense Integrated Military Human Resources System (DIMHRS), which will eventually become the authoritative human resource system for the Department of Defense (DoD). Accordingly, Sea Warrior is being pursued in close coordination with DIMHRS development. By keeping DIMHRS requirements at the forefront, Sea Warrior will ensure the compatibility of its core processes with DIMHRS for eventual incorporation within that broader initiative.

Some of the biggest challenges for Sea Warrior involve identifying funding requirements and collaborating and communicating across various DoD/DON organizations involved in the various activities. Accordingly, the Navy's Sea Warrior leadership is in the process of establishing a framework for obtaining a funding line, beginning in Fiscal Year 2006, and institutionalizing a long-term organization structure to manage this complex program.

It is also critical that our Sea Warrior manpower requirements reflect a well reasoned mix of Total Force Manpower (active, reserve, civilian, contractor) so that we not only deliver readiness, but also do so in the most economic manner. Moreover, manpower represents both an essential investment and an opportunity cost as well. By measures such as the replacement of non-military essential uniformed manpower in our infrastructure with civilians or contractors we can help make available the funds that will be necessary to enable transformation.

Overall, Sea Warrior is using a Sailor-centric, mission-focused process to achieve a responsive human resource system. Sea Warrior will empower the fleet and individual sailors, and will foster an ongoing, responsive, two-way, customer-driven human resource system. In short, Sea Warrior will empower naval personnel to play their critical role as enablers of military transformation.

2. Making Marines and MAGTFs

The Marine Corps continues to view transformation as founded on four broad and interdependent pillars. First, **operational changes**, first expressed as concepts, will alter the means by which the operating forces project power and influence. Second, **leap-ahead technology** will create new opportunities for warriors of tomorrow. Third, the Marine Corps changes in **business and acquisition processes** generate the most efficient investment of the nations resources, while enabling the rapid development of effective capabilities in a timeframe that gives us a competitive advantage. Finally, these opportunities can be created and exploited only by **agile organizations**, ready to adapt our institution to maximize the potential of both Marines and their units. Changes across each of these pillars depend upon our most fundamental transformation: the creation of innovative Marines eager to continually adapt, and fully prepared to pursue, embrace, and exploit further transformational changes to our concepts, capabilities, people, and organizations.

Making Marines: To a large extent, our cultural capacity for rapid reorganization stems from developing creative and adaptive leaders who can function in ambiguous and uncertain environments, and make timely and effective decisions under stressful conditions. Today's force is an all-recruited force, comprised of some of the best and brightest young Americans. The manner in which Marines are recruited, trained, developed, and managed is an essential aspect of the Corps' organizational and institutional transformation. Most importantly, the development of Corps of decision makers, each eager to exploit the chaos of the battlefield, provides us with a sustained asymmetric advantage over future adversaries.

Naval Transformation Roadmap

Our training and education continuum begins with a true transformation that takes young Americans and molds them into quality citizens and Marines capable of winning our nation's battles. The Corps continues to "Make Marines" through a constant effort across an individual's career. These programs are fundamentally focused on developing comprehensively educated, mentally astute, and physically tough Marines, ready to succeed in chaotic combat environments. The warrior ethos is instilled in individual Marines by rigorous and challenging training that transforms them into intelligent and disciplined warriors, and mirrors the Marine Corps' own institutional transformation in equipment, doctrine, and structure. As they move along the continuum, Marines increasingly focus on collective and unit-level skills, with an emphasis on their role as part of a Marine Air Ground Task Force (MAGTF). Transformational advances to MAGTF, naval, and joint capabilities depends upon the skill, creativity, and vision of these Marines and our joint partners, and must be enabled by an organization systemically ready to adapt to new demands and exploit new opportunities.

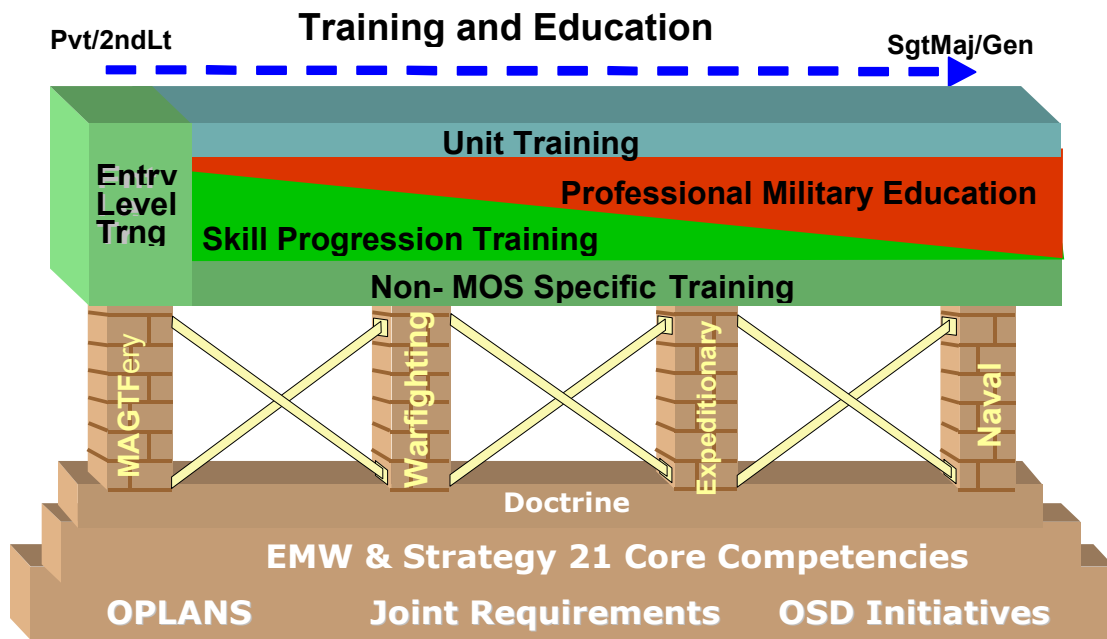

Figure 39: USMC Training and Education Continuum

Making MAGTFs: Recognizing and expeditiously adjusting organizational arrangements to take full advantage of the adoption of new operational concepts, new technologies, and acquisition reform, the Marine Corps must be prepared to reorganize its structure while remaining true to a combat-proven heritage. Getting the Right Marine to the Right Place at the Right Time, with the Right Skills and Right Quality of Life remains the overriding driver of the Marine Corps Human Resources Development Process (HRDP). The Marine Corps continually strives to transform its HRDP by leveraging technology and innovating processes to achieve efficiencies. Managed by the Deputy Commandant for Manpower and Reserve Affairs (DC M&RA), as the executive agent for the HRDP, the Marine Corps intends to promote Human Resource transformation through a number of initiatives, including reengineering our methods for manpower planning and administration. They also include a number of efforts to exploit the

potential of a truly Total Force that encompasses our Reserve Marines, our Civilian Marines, and our Former Marines.

Prime examples of our organizational agility can be seen in the creation and rapid tasking of the 4th MEB (Anti-Terrorism) and in the Logistics Enterprise Integration effort. In order to provide Regional Combatant Commanders with unique, proactive capabilities that help them defend against unconventional threats and reduce their vulnerability to terrorist actions, the Marine Corps quickly reorganized a number of smaller units into a cohesive, capable force. With only a minimal increase in force structure, the Marine Corps relied on the adaptive, decentralized organization of its warfighting units to create, with little impact on the operating forces, and deploy a new capability in support of OPERATION ENDURING FREEDOM. Similarly the Logistics Enterprise Integration initiative focuses on removing redundant layers of maintenance and supply support and streamlining logistics processes, providing a more responsive and effective combat support capability.

The inherent flexibility of the Marine Air Ground Task Force is also largely due to the integral support, organization and training of the Marine Corps Reserve. The mirrored structure and training of Reserve and Active forces provide commanders with additional flexibility in planning and task organizing for a wide range of military operations. Where certain skill sets are found only in Reserve units, such as the Civil Affairs Groups, the Marine Corps is working to generate opportunities to associate these units with units of the Active component in order to develop working relationships between Active and Reserve components maximizing the diverse often civilian-acquired expertise that will enhance military capabilities. Other examples of the constant adjustments to our warfighting capabilities include:

- **Marine Corps Special Operations Integration:** In coordination with USSOCOM and their Executive Agent, Naval Special Warfare Command, the Marine Corps has developed a plan for an integrated 80-90 man Marine detachment to USSOCOM. This detachment has been designed as an initial “proof of concept”, and will serve as the foundation for future contributions. The detachment is organized, trained and equipped to conduct special reconnaissance, direct action, coalition support, foreign internal defense and other missions as directed. The detachment was formally stood-up on 20 June 03. Presently the detachment has begun training at Camp Pendleton California. The detachment will transfer to the operational control of USSOCOM during October 2003, and deploy in April 2004 as augmentation to a Naval Special Warfare Squadron supporting both USPACOM and USCENTCOM.
- **Information Operations (IO) and Space Professional Military Operational Specialties (MOSs):** The Marine Corps is actively developing policy and doctrine in order to institutionalize IO, and is establishing MOSs for both IO and Space Operations, in order to identify officers with particular training and experience, identify key billets requiring this expertise, and support both the Operating Forces and Supporting Establishment with trained and knowledgeable staff officers. This work will be pivotal in the success of the Marine Corps' ability to recruit, train, assign, promote and retain the two specialties within IO: planners and specialists. In a supporting effort, the Marine Corps is developing a tactical, front-end PSYOP dissemination capability. This capability will be forward deployed and responsive to MAGTF operations, while integrating and supporting the larger capability provided by USSOCOM. The Marine Corps road ahead will focus on integrating PSYOP training into all levels of the MAGTF while leveraging all available theater PSYOP assets to

support our operating forces. The desired end state is MAGTFs capable of planning, executing, coordinating, and synchronizing IO as part of an overall Joint Force campaign.

- **Reserve Mobilization** – Activation of Marine Reserve units is an essential element of all major operational plans. With structure, training and equipment that mirror the Active Component, these units provide ready, relevant forces that augment and reinforce the capability of the Marine Air Ground Task Force. In regard to contingency operations when certain specific skills are required that may not necessarily be found in the active component, the development of the Marine Corps Mobilization Processing System (MCMPS) will allow for the identification of a Marine with that skill, follow-on contact and activation.
- **Reach-back capabilities**, such as the Marine Corps Intelligence Activity's support to the warfighting requirements during the Global War on Terrorism, provide the MAGTF commander with significant additional capability without an increase in deployed personnel, facilities, or other infrastructure.
- **Marine Tiltrotor Test and Evaluation Squadron 22 (VMX-22)**: VMX-22 will conduct operational test and evaluation for the V-22 Osprey, serving as a center of excellence for tiltrotor technology and ensuring that the Defense Department moves forward with the continued development of the V-22.
- **USMC Joint and MAGTF Training Requirements**: Efforts underway to extend our current Joint Air/Land maneuver space in order to replicate modern and future Joint battle spaces include Joint Military Operations on Urban Terrain (MOUT) and Joint Close Air Support (JCAS). These allow the coordination of deep close and rear battles and support the extended ranges of modern and future Joint/MAGTF weapons systems. This, in turn, will enhance our capability to conduct both live fire and force-on-force training. The Marine Corps is also embarking upon virtual scenario simulation with digital links to other training centers and continuous constructive feedback and After-Action Review (AAR) capabilities.
- **Marine Combat Instructor Military Operational Specialty**: To reaffirm our fundamental belief that "every Marine is a Rifleman", regardless of individual MOS, the Marine Combat Instructor MOS has been created and designated as a Special Duty Assignment. This initiative will provide the highest quality instruction to our Marines, both during Marine Combat Training at the School of Infantry and across the Corps, while providing critical stability to an essential training resource.

B. Naval Support to Joint Concept Development and Experimentation

The Navy and Marine Corps are carefully harmonizing naval Concept Development and Experimentation (CD&E) activities in support of the Joint Concept Development and Experimentation Campaign plan under development. This campaign aims to collaboratively develop concepts that, through vigorous debate, refinement, and experimentation in realistic joint warfare scenarios can be translated into warfighting capabilities that strengthen the effectiveness of Regional Combatant Commanders in the field. Perhaps more important than fostering the creation of new concepts, the campaign serves as a mechanism to synchronize the efforts of combatant commanders, Services, and interagency partners as we collectively develop concepts and plan experiments in the course of transforming the military.

The partnership between the Navy Warfare Development Command and the Marine Corps Combat Development Command is an outstanding example of how collaborative efforts between the Services can yield products that contribute to future integrated operations. This collaboration will be expanded to include regular coordination on a broad spectrum of additional activities.

As concepts are developed, the emerging doctrine, procedures, organizations and technology must be evaluated through a coherent and aggressive experimentation process. To achieve this coherency, the Navy and Marine Corps will closely coordinate the Navy's Sea Trial process and the Marine Corps' experimentation process. This process must tap into the creativity of all our Sailors and Marines and engender a culture in which the testing of new ideas is encouraged, even if they fail.

The Center for Emerging Threats and Opportunities (CETO) helps prevent operational and tactical surprise to senior warfighting commanders by assessing the future security environment in light of emerging threats and potential conceptual and technical opportunities. The center aims to serve as a catalyst to stimulate thought and debate on issues of importance to the Marine Corps, and also responds to requests for support from the senior warfighting commanders.

Sea Trial. Sea Trial is the Navy's recently created process for formulating and testing innovative operational concepts, most of which harness advanced technologies and are often combined with new organizational configurations, in pursuit of dramatic improvements in warfighting effectiveness. Sea Trial concept development and experimentation (CD&E) is being conducted in close coordination with, the Marine Corps combat/force development process and reflects a sustained commitment to innovation. These efforts tie warfare innovation to the core operational challenges facing the future joint force. The Navy is conducting this CD&E campaign in a joint context, closely coordinating with and leveraging the similar efforts of Joint Forces Command (JFCOM), the other Services, and the Combatant Commanders.

Sea Trial is designed to convert innovative concepts and breakthrough technologies, validated and refined by means of experimentation, into changes in doctrine, organization, training, material, leadership development, personnel and facilities (DOTMLPF) that are rapidly introduced into the fleet. It relies upon an experimentation process in which the fleet participates as a major partner, bringing added operational experience and realism to experiments and fostering increased personal commitment to vigorous force transformation among line personnel, who are direct participants in the process. Wargaming and other analytical efforts allows investigation of "virtual capabilities and threats" to ensure our transformation addresses a mid- and far-term possibilities.

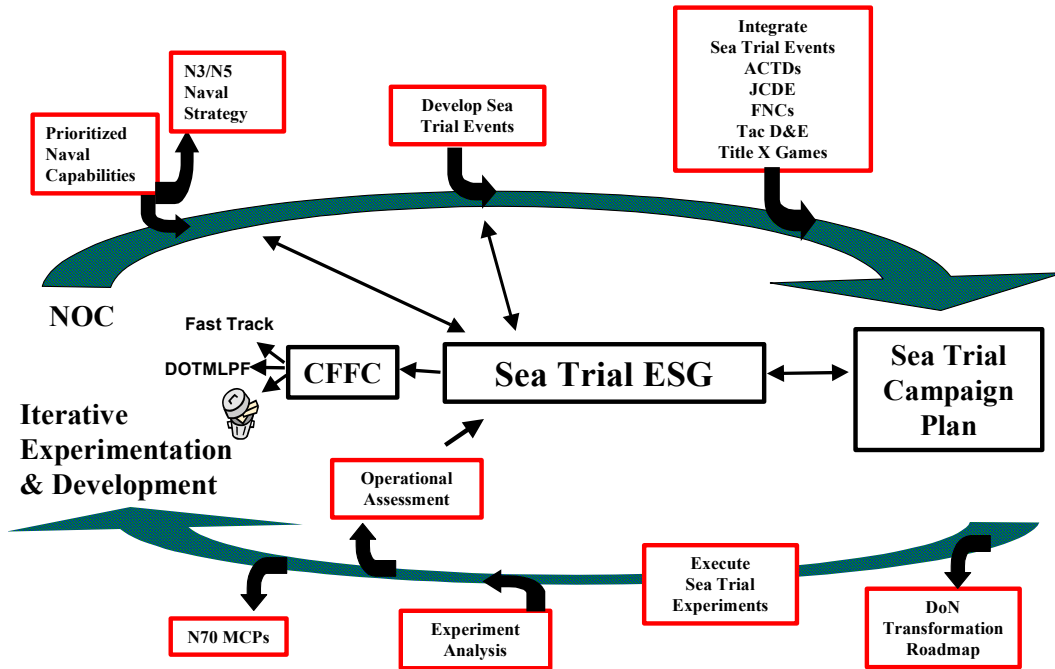

Figure 40: The Sea Trial Process

Commander, Fleet Forces Command (CFFC) is the lead agent for Sea Trial with responsibility for overseeing CD&E activities with regard to Sea Strike, Sea Shield, Sea Base, and FORCEnet. As the lead agent, CFFC has developed and is executing a comprehensive Sea Trial Campaign Plan to rapidly mature new concepts, technologies and doctrine. This campaign plan focuses on increasing warfighting effectiveness to meet the near-, mid- and long-term warfighting challenges associated with the new joint operational, operating, and functional concepts.

Sea Trial experiments investigate, develop and compare solutions to the challenges and opportunities faced by the Navy derived from a rigorous analysis of current and potential future operational capabilities, shortfalls and opportunities. The core of this campaign will be a series of experiments that will test the validity of concepts and compare the effectiveness of alternative ways of implementing these concepts in the fleet.

Data, analytic findings, assessments and operational prototypes emerging from these experiments as well as lessons learned from real-world operations will feed into the Navy's requirements and acquisition process, shape Navy science and technology initiatives and guidance, and drive changes in doctrine, tactics, and procedures. Ultimately, a refined and experimentally proven set of innovations will be passed to the Naval Capabilities Development Process (NCDP) for implementation via the Navy's Planning, Programming, Budgeting and Execution System, as well as its acquisition efforts and training programs.

A large number of Navy commands already involved in the CD&E process are responsible to CFFC for the execution of the Sea Trial campaign plan. Under Sea Trial these commands take on greater responsibilities delineated by CFFC. The Commander, Navy Warfare Development

Naval Transformation Roadmap

Command (CNWDC) is the project coordinator for Sea Trial. A flag level Sea Trial Executive Steering Group (STESG), chaired by CFFC, provides oversight of the Sea Trial process. Membership of the STESG includes:

- Commander, Fleet Forces Command(CFFC– dual hatted as COMLANTFLT)
- Commander, Pacific Fleet (COMPACFLT)
- Commander, U.S. Naval Forces Europe (COMUSNAVEUR)
- Deputy CNO for Warfare Requirements and Programs (OPNAV N6/N7)
- Chief of Naval Research (CNR)
- Commander, Navy Warfare Development Command (CNWDC)
- Commanding General of the Marine Corps Combat Development Command, (CG MCCDC)
- Commander, Second Fleet (COMSECONDFLT)
- Commander, Third Fleet (COMTHIRDFLT)
- Commander, Naval Net Warfare Command (NETWARCOM)

Operational Marine Corps commanders, as designated by CG MCCDC, will participate and address naval issues as appropriate. COMSECONDFLT, partnered with COMFIFTHFLT and COMSIXTHFLT, are acting as the operational agents for CD&E activities with regard to Sea Shield, Sea Strike, and Sea Base. COMTHIRDFLT, partnered with COMSEVENTHFLT, act as the Sea Trial operational agent for Sea Shield. In addition, COMTHIRDFLT is coordinating activities of the Sea- Based Battle Lab (SBBL) aboard USS CORONADO and the Network Centric Innovation Center (NCIC) to support the Sea Trial Campaign Plan. COMNAVNETWARCOM is the Sea Trial operational agent for FORCEnet. Flag-level representatives of the system commands (SYSCOMs) and Commander, Operational Test and Evaluation Force (COMOPTEVFOR) participate as non-voting advisors for matters relating to Research and Development (R&D) and Operational Test and Evaluation (OT&E). The STESG meets quarterly to review Sea Trial operational assessments, approve the overall Sea Trial Campaign Plan, resolve issues of resources and priorities, and make recommendations to CFFC on the viability of emergent concepts, technologies and doctrine.

Sea Trial Pillar groups have been established by each of the operational agents to coordinate CD&E activities for Sea Strike, Sea Shield, Sea Base and FORCEnet. The Sea Trial Pillar groups provide the direction in their respective areas for the development and implementation of an iterative experimentation process that brings necessary operational capability to the Fleet and Fleet Marine Force. Sea Trial efforts are fully coordinated within each core competency as well as across the four Pillars. In support of their coordination efforts, Sea Trial Pillar groups establish an interface with related processes and/or commands, as appropriate. Each Sea Trial Pillar group member is responsible for fully coordinating Sea Trial efforts within their parent command to ensure synergy with other related processes. These groups include representatives from CFFC, NWDC (CD&E coordination), OPNAV sponsors, ONR, lead SYSCOMs, MCCDC, and numbered fleet staffs. Each Pillar group oversees activities to develop operational concepts, plan and schedule Sea Trial events, and review and process assessments of CD&E efforts.

CFFC has formed collaborative teams to leverage fleet expertise in each of the mission capability areas, such as USW, Ship-to-Objective Maneuver (STOM), Integrated Joint Logistics, ISR. These collaborative teams parallel the mission capability package (MCP) organizations established by OPNAV N70 to ensure that alignment is maintained between Sea Trial activities and the NCDP. Collaborative teams will be extensively used to develop a comprehensive

concept development and experimentation (CD&E) plan. This plan will incorporate lessons learned from operations and exercises, create new CONOPS and doctrine, and coordinate related Navy efforts in Advanced Concept Technology Demonstrations (ACTDs), FNCs, S&T and Tactical Development and Experimentation. This collaboration among fleet and consulting commands will fully leverage the intellectual capital of Warfare Centers of Excellence (WCOEs), NWDC, ONR, type commanders (TYCOMs), and SYSCOMs.

In addition to the Sea Trial activities listed in support of each mission capability, naval forces will partner with JFCOM and other services in the following FY-04 Joint Concept Development & Experimentation (JCDE) events:

- Joint Anti-Access Wargame (UNIFIED COURSE 04)
- Decision Superiority Wargame
- Joint Major Combat Operations (MCO) Wargame (UNIFIED QUEST 04)
- Joint Coherent Effects Wargame (GLOBAL ENGAGEMENT VII)
- Seabasing and Expeditionary Maneuver Warfare in a Joint Context (Sea Viking 04)

Sea Viking. Sea Viking 04 (SV 04) is the Marine Corps Concept Development and Experimentation Campaign plan that will assess future Marine Corps and naval capabilities in a joint forcible entry context. SV 04 will examine future MEB capability sets operating as part of the JFMCC conducting joint forcible entry operations from a sea base. SV 04 consists of two mutually supporting pathways designed to help inform decisions and strategies for achieving 2015 transformational goals.

- The prototype pathway will explore the force organizations, equipment, and existing technologies that will impact our warfighting capabilities in the near- and mid-term, and directly supports a similar pathway in the JCDE Campaign plan. If experimentation demonstrates that the capabilities supported by systems within the program of record can be further augmented and expanded within DOTMLPF.
- A conceptual pathway co-sponsored by JFCOM will be a modeling and simulation event designed to assess future MEB capability sets in a joint forcible entry context. This pathway will examine naval and joint command relationships and interfaces, future MEB capability sets, and Joint capability sets for forcible entry. Results from this experiment will assist in future CONOPS development and experimentation efforts.

SV04 will involve all facets of Marine Corps concept development and experimentation, including the Marine Corps Combat Development Command, the Marine Corps Warfighting Laboratory, the Center for Emerging Threats and Opportunities, and naval operational forces. The endstate of SV04 is a better understanding of MAGTF contributions to the future Joint force, a clearer definition of Marine Expeditionary Brigade capabilities, clarification of future naval C2 relationships, and a requisite determination of the capabilities required to achieve sea-based Expeditionary Maneuver Warfare.

C. Science and Technology

Technology, when integrated with new operational concepts and organizational constructs, is a critical element of transformation for the fleet. Leveraging technology is the key to both force modernization and transformation to preserve the decisive U.S. advantage across the range of military operations.

Naval Transformation Roadmap

The Office of Naval Research (ONR) is charged with scientific research and technology development for both the Navy and Marine Corps and is the sponsor for all naval technology programs.

The Future Naval Capabilities (FNC) program, which concentrates resources on key technology programs addressing top priority naval needs is one of the most concrete steps ONR has taken to increase the transition of technology to naval operating forces. The FNC program is designed to facilitate technology transition to the Fleet, and to incorporate SYSCOM and Fleet “ownership” in the FNC process and its many associated individual technology projects. The key to the FNC process is the FNC Integrated Product Team (IPT) structure, which places senior OPNAV/Headquarters USMC, acquisition, Fleet, and technical personnel in a position to direct the technology activities addressing individual capability needs.

Representing about one third of the naval S&T budget, the aggregate funding level of the FNCs is about \$500M annually, divided among approximately 225 individual projects. Solid transition plans are a requirement for the initiation of an individual FNC project, but the FNC program allows flexibility for support of high-transformational-potential projects that may not have established firm transition plans as yet. An 80% - 20% split between transition /high-transformation-potential projects is a rule of thumb applied to FNC project structure. The highest level of authority for the FNC program is the S&T Corporate Board, consisting of ASN(RDA), Vice Chief of Naval Operations (VCNO), and Assistant Commandant of the Marine Corps (ACMC). This long-standing board is in place to assure top-level DoD and naval policy is reflected in the total naval technology program (6.1-6.3), including the FNC program.

The Technology Oversight Group (TOG) provides oversight, integration and investment balance functions across all FNCs to complement the leadership provided for each individual FNC by their respective IPTs,. The TOG was established in 2002 by the S&T Corporate Board, meets several times a year, and is tasked with identifying cross-FNC issues and resolving these issues by adjusting individual FNCs.

The FNC process is tuned to identifying Transformational capabilities, and assuring their transition to the Fleet via the strict transition requirements associated with most FNC projects. As mentioned above, the FNC process has the flexibility of supporting high-transformational potential projects that may not have an established transition structure as yet. Additionally the overall naval technology program is structured to identify technologies of high-transformation-potential within the overall Office of Naval Research technology program and moving promising high-transformation-potential projects into the FNC program as appropriate.

The Marine Corps Warfighting Laboratory (MCWL)’s purpose is to improve current and future naval expeditionary warfare capabilities across the spectrum of conflict for current and future operating forces by conducting **concept-based** experimentation to develop and evaluate **tactics, techniques, procedures and technologies** in order to enhance current and future warfighting capabilities. Among other initiatives, MCWL partners with the operating forces by sponsoring **Project Metropolis** to develop the techniques, tactics, and procedures associated with tactical level urban operations, as well as those technological innovations that will facilitate those operations. **Project Albert** is being developed to support decision makers in meaningful ways through modeling, analysis, and new ways of combining them to include important phenomena inadequately represented by current techniques. MCWL helps represent Marine Corps-specific requirements within the FNC process, led by a Commanding General who also serves as the Deputy Chief of Naval Research.

D. Sea Enterprise

Among the critical challenges that we face today are finding and allocating the resources needed to transform the Navy – Marine Corps Team. We must replace Cold War-era systems with significantly more capable sensors, networks, weapons, and platforms appropriate to the new security challenges and new American way of war, if we are to increase our ability to deter and defeat 21st Century foes. To extract the utmost from scarce resources, all aspects of the Department will be critically and continually examined to determine how we might reap efficiencies across all headquarters, acquisition, research, and operating force and field support activities. Sea Enterprise initiatives will drive the Department of the Navy's transformation into a 21st Century Force that focuses on what truly matters – warfighting readiness and combat capability.

Sea Enterprise is the flagship effort for freeing up additional resources to support military transformation initiatives through streamlining naval business processes. Involving the Navy Headquarters, the systems commands, and the Fleet, Sea Enterprise seeks to improve organizational alignment, refine requirements, and reinvest savings to buy the platforms and systems needed to transform the naval contribution to the joint force. Drawing on lessons from the business revolution, Sea Enterprise will reduce overhead, streamline processes, substitute technology for manpower, and create incentives for positive change. Legacy systems and platforms no longer integral to mission accomplishment will be retired, and we will make our Department's business processes more efficient to achieve enhanced warfighting effectiveness in the most cost-effective manner.

To accomplish Sea Enterprise, the Navy and Marine Corps have parallel but separate and coordinated efforts underway to deliver required resources for recapitalization. In March 2003, the Navy stood up the Sea Enterprise Board of Directors, co-chaired by the VCNO and ASN(RDA) and comprised of key elements of the headquarters staff, major systems commands, and the Fleet. The Sea Enterprise Board of Directors is focused on execution of existing initiatives programmed in the Navy's budget as well as identification of new savings opportunities to generate additional resources towards recapitalization. The USMC is an invited participant of the Board to address cross-service concerns and promote the sharing of ideas and best practices.

In June 2003, the Marine Corps Requirements and Oversight Council (MROC) established the Marine Corps Business Enterprise Office, headed by a Senior Executive Service (SES) civilian, to coordinate implementation of better business practices across all three strategic business processes: providing installation support, acquisition, and logistic/combat service support. Marine Corps leaders will incorporate performance measures into the Planning, Programming Budgeting, and Execution (PPBE) process for installations, following on the successful realignment of over \$300 million and 2,000 Marines from our bases to higher priorities. The USMC Business Plan implements the Commandant's direction to manage the Business Enterprise of the Marine Corps through application of better business practices and reflects our commitment to exercise resource stewardship by aggressively seeking to maximize our effectiveness and efficiency.

Sea Enterprise involves identifying and spreading knowledge about best business practices so that naval leaders can provide the greatest return on the taxpayer's investment. Accordingly, the Department is creating educational opportunities to teach its leaders about executive business management, finance, and information technology. For example, the Center for

Executive Education at the Naval Postgraduate School brings together rising Flag Officers, SES members, senior enlisted, and private industry decision-makers to discuss emerging business practices. The Marine Corps Center for Business Excellence provides training and education in business process reengineering, Activity-Based Costing and Modeling, and business enterprise management. Sea Enterprise will extend this understanding from the classroom to the deck plates so that future naval leaders gain experience in a culture of productivity and effectiveness.

Sea Enterprise is also pursuing operational efficiencies through enhanced inter-service integration. The Navy and Marine Corps tactical aviation integration plan, for example, will save billions of dollars across the Services, enhance interoperability, and more fully integrate the Navy - Marine Corps Team. Whether it is cooperation with the U.S. Coast Guard's Deepwater Integrated Systems Program, new munitions being developed with the U.S. Air Force, joint experiments with the U.S. Army on high-speed vessels, or a new, combined intelligence structure with the U.S. Marine Corps, Sea Enterprise will identify foster opportunities for and promote the sharing of technologies and systems whenever possible. Savings captured by Sea Enterprise will play a critical role in the Navy's transformation into a 21st-century force that delivers what truly matters: increased combat capability for the joint force.

V. CONCLUSION

The security environment of today and tomorrow will continue to be characterized by uncertainty, chaos, surprise, and conflict. The precise nature of conflicts to be prosecuted and the peacetime requirements for naval forces, will be broad in scope and difficult to predict, but will undoubtedly involve a wide range of actions to shape the global environment, to deter coercion and aggression, and to defeat determined, creative adversaries, who employ a variety of asymmetric means. Naval forces must exploit the power of networked information to seize the advantage over potential adversaries, and must be postured to sustain and advance a broad competitive advantage that readily over-matches any adversary.

Naval force transformation will seek to take advantage of rapid advances in technology. However, the real increases in capability will come from co-evolving the introduction of these advanced technologies with the implementation of new operational concepts and concurrent changes in organizational arrangements that allow naval forces to carry out routine peacetime operations, crisis response actions, and, if required, wage war in innovative ways with both new and legacy systems. This *Naval Transformation Roadmap* describes the myriad efforts planned and underway to create the concepts, practices, and capabilities needed to field a flexible, agile, networked, sea-based power projection force, which will lead and participate in joint force operations throughout the world.

Naval transformation is a continuous process, tailored by each naval service to its particular missions and culture, culminating in a set of complementary, total force capabilities in support of joint force capabilities. In addition to seizing the opportunity to achieve transformational capabilities today, the processes required to establish and maintain a culture of innovation must be encouraged, nurtured and rewarded. The naval services are embarked today on a wide range of initiatives to radically change organizational arrangements, adopt fundamentally different concepts for military operations, and alter existing operational concepts with the incorporation of advanced technologies to achieve profound increases in military capabilities. Agile and adaptive by nature, the Navy and Marine Corps are fostering the culture of innovation required to achieve transformational operational concepts and capabilities.