

DEPARTMENT OF COMMERCE

CIRCULAR
OF THE
BUREAU OF STANDARDS

S. W. STRATTON, DIRECTOR

No. 38

THE TESTING OF RUBBER GOODS

[Fourth Edition]

SEPTEMBER 28, 1921

(Superseding 3d Edition, July 19, 1915)



PRICE, 20 CENTS

Sold only by the Superintendent of Documents, Government Printing Office
Washington, D. C.

WASHINGTON
GOVERNMENT PRINTING OFFICE

1921

DEPARTMENT OF COMMERCE

CIRCULAR
OF THE
BUREAU OF STANDARDS

S. W. STRATTON, DIRECTOR

No. 38

THE TESTING OF RUBBER GOODS

[Fourth Edition]

SEPTEMBER 28, 1921

(Superseding 3d Edition, July 19, 1915)



PRICE, 20 CENTS

Sold only by the Superintendent of Documents, Government Printing Office
Washington, D. C.

WASHINGTON
GOVERNMENT PRINTING OFFICE

1921

THE TESTING OF RUBBER GOODS

ABSTRACT

This circular gives the methods used at this Bureau in the testing of rubber goods. The various physical tests commonly employed are described in detail and the machines used for this purpose, many of which were designed at this Bureau, are illustrated and described in detail. Data are given showing the effect of various factors on the tensile properties of rubber. Special attention is given to the effect of temperature on the physical tests. The circular also contains a brief outline of the methods of collecting crude rubber and the processes used in the manufacture of various rubber articles. The methods used in the chemical analysis are given, together with an explanation of the reasons for making these tests and their significance. Regulations are given concerning the conditions under which tests are made for State and municipal governments.

CONTENTS

	Page
I. Introduction.....	6
II. Materials used in the industry.....	6
1. Rubber—Sources, collection, and preparation.....	6
(a) Wild rubber.....	7
(1) Sources.....	7
(a) Euphorbiaceæ.....	7
(b) Apocynaceæ.....	7
(c) Asclepiadaceæ.....	8
(d) Urticaceæ.....	8
(e) Compositæ.....	8
(2) Collection and coagulation.....	9
(b) Plantation rubber.....	11
(1) Sources.....	11
(2) Collection and preparation for market.....	11
(c) Synthetic rubber.....	12
(d) Chemical and physical properties of rubber.....	12
2. Gutta-percha and balata.....	14
3. Reclaimed rubber.....	15
4. Rubber substitutes.....	16
5. Vulcanizing ingredients.....	16
6. Compounding ingredients.....	16
(a) Fillers.....	17
(b) Accelerators.....	18
(c) Pigments.....	19
III. Processes used in the industry.....	20
1. Washing of crude rubber.....	20
2. Drying.....	20
3. Compounding or mixing.....	20
4. Calendering.....	22
5. Frictioning.....	23
6. Vulcanization.....	24

	Page
IV. Manufacture of rubber goods	25
1. Solid rubber tires	25
2. Pneumatic tires	27
(a) Fabric	27
(b) Cord	28
3. Inner tubes	29
4. Plied hose	29
(a) Machine-made hose	29
(b) Handmade hose	30
5. Braided hose with rubber tube and cover	31
6. Cotton rubber-lined hose	31
7. Rubber tubing	32
8. Rubber belting	32
9. Molded rubber goods	33
10. Insulated wire	33
11. Boots and shoes	34
12. Rubberized fabrics	34
13. Druggists' sundries	35
14. Rubber bands and thread	36
15. Rubber sponge	36
V. Testing of rubber	36
1. Physical testing of rubber	37
(a) Physical tests most commonly employed	37
(1) Comparison of normal and accelerated aging	39
(2) Tensile strength and ultimate elongation	48
(a) Separating rubber from fabric	48
(b) Emery wheel for grinding the surface of rubber	49
(c) Form and preparation of test pieces	50
(d) Measuring the thickness of rubber	51
(e) Grips for holding test pieces	51
(f) Testing machines	53
(3) Elasticity or "set"	57
(a) Machine for testing elasticity or "set"	57
(4) Reduction in tension when rubber is held at a definite elongation	58
(a) Machine for testing reduction in tension	59
(5) Conditions affecting the results of tension tests	60
(a) Influence of speed on tensile strength and ultimate elongation	60
(b) Influence of temperature on strength, elongation, and "recovery"	60
(c) Influence of cross section on tensile strength and ultimate elongation	61
(d) Influence of the direction in which specimens are cut on strength, elongation, and "recovery"	62
(e) Influence of "backing" on the tensile strength and "recovery" of hose lining	63
(f) Influence of previous stretching on strength, elongation, and "recovery"	64
(g) Influence of the form of test piece on the results of tension tests	66

V. Testing of rubber—Continued	Page
1. Physical testing of rubber—Continued	
(a) Physical testing most commonly employed—Continued	
(6) "Friction" test	71
(7) Hydraulic-pressure test	75
(8) Steaming test	76
(9) Testing the rubber insulation of wire	76
(10) Comparative tests of machine and handmade tubes	77
(11) Testing of rubber bands	79
(a) Under one-fourth inch in width	79
(b) Bands one-fourth inch in width or over	80
(b) Bureau of Standards procedure for physical testing of rubber	81
(1) Sampling	81
(2) Physical test methods	81
(a) Articles of irregular shape	81
(b) Preparation of samples for test	82
(c) Temperature of testing room	83
(d) Preparation of tension test pieces	83
(e) Tensile strength and ultimate elongation	85
(f) Set	87
(g) Friction	88
(h) Hardness	91
(i) Steam test	92
(j) Hydraulic-pressure test	93
(k) Interpretation of results	94
2. Bureau of Standards methods of chemical analysis	95
(a) Reasons for the analysis	95
(b) Sampling	98
(1) Preparation	98
(2) Classification	99
(c) Reagents	99
(d) Analysis	100
(1) Qualitative	100
(2) Quantitative	100
(a) General procedure	100
(b) Procedure for the analysis of 30 or 40 per cent Pará insulation	107
(c) Special determinations	108
(d) Joint Rubber Insulation Committee method	118
(e) Notes	121
VI. Testing of fabrics	122
1. Normal atmosphere and moisture content	122
2. Weight	122
3. Threads per inch	123
4. Tensile strength	123
VII. Appendix	123
1. List of specifications	123
2. Bibliography	124
3. Table of specific gravities	126
4. Determination of the specific gravity, cost per pound, and cost per cubic foot of a rubber compound	127

I. INTRODUCTION

The testing of rubber goods is a matter the importance of which is more generally appreciated now than formerly. The constantly increasing demand for rubber goods by the general public, automobile manufacturers, railroad companies, and other large consumers points to the necessity for developing standard specifications and tests for rubber, as has been done in the case of iron, steel, cement, etc.

The purpose of this circular is to describe the methods of testing used at this Bureau, with the hope that sufficient interest may be aroused among manufacturers and purchasers of rubber goods to assist in bringing about that concerted action which is necessary for the standardization of tests and to furnish information which will enable the users of rubber goods to determine the quality of the materials that they secure.

In order that one may readily understand the fundamental principles involved in these tests, this circular gives a brief account of the sources and preparation of the raw materials used in rubber manufacture and briefly describes some of the manufacturing processes through which the materials pass. Without proper correlation of manufacturing processes, service rendered, and test results, the actual figures obtained by these tests are of little value.

II. MATERIALS USED IN THE INDUSTRY

1. RUBBER—SOURCES, COLLECTION, AND PREPARATION

Rubber is generally derived by a process of coagulation from a milky fluid (latex) contained in a special cell system (laticiferous system) of various trees, vines, and shrubs. The laticiferous system, which is distinct from the sap-bearing cell system, generally lies between the outer bark and the cambium, and by cutting through the former the latex is obtained as a white to cream-colored, more or less viscous, fluid. This operation is termed "tapping." The rubber is contained in the latex as small particles which are generally suspended in the serum in the form of a negative emulsion. The rubber is separated from the latex either by evaporating off a part of the water or by a process of coagulation which varies according to the species, district, etc. After the coagulum has been separated from the serum, it is generally purified and dried and is then exported.

(a) WILD RUBBER

(1) SOURCES.—Rubber-bearing species are indigenous to considerable tracts of the tropical and subtropical zones of South and Central America, Asia, Africa, and Australia. The chief botanical orders are the Euphorbiaceæ, Apocynaceæ, Urticaceæ, and Compositæ.

(a) *Euphorbiaceæ*.—The most important genus of this order is the “Hevea,” and from the species *H. brasiliensis* about two-thirds of the world’s output is obtained. From this we get the famous Pará rubber. There are two main districts in which fine Pará rubber is prepared: (1) The “islands” at the mouth of the Amazon River, and (2) the “up river” regions, near and above Manáos.

The scraps of rubber adhering to the trees and tapping cups are compressed into irregular masses and sold as “negroheads.” Up-river negroheads are generally termed “scrappy.” Island negroheads go by the name of “Sernamby.” A third variety of negrohead, the Cameta, comes from the district of that name in southwest Pará.

Among the other varieties of *H. brasiliensis* may be mentioned:

- | | |
|--|--|
| (a) Matto Grosso, fine and entfrefine. | } From the Province of Matto Grosso, Brazil. |
| (b) Matto Grosso, virgin sheets. | |
| (c) Matto Grosso, negroheads. | |
| (d) Mollendo (Bolivian Pará). | |
| (e) Peruvian (fine, coarse, or scrappy). | |
| (f) Caucho (partly from Brazil, partly from Peru). Some caucho and Peruvian ball come from <i>Castilloa elastica</i> and <i>Castilloa ulei</i> . | |

Although the rubbers referred to above consist mainly of *H. brasiliensis*, the latices of other species of Hevea, such as *spruceana*, *itaube*, *discolor*, *similis*, and *speciosa*, are also employed to some extent in their preparation.

Another genus of the Euphorbiaceæ is the Manihot. The most important commercial variety of rubber is the Manicoba or Ceara, which comes from the Province of Ceara, Brazil.

(b) *Apocynaceæ*.—The bulk of African rubbers belong to this order, and the main genera are Funtumia, Landolphia, and Clitandra.

The only species of Funtumia which is of commercial importance is *F. elastica*. The natural habitat of the tree is on the Gold and Ivory Coasts in Uganda and in other parts of tropical Africa. The rubbers are known as Gold Coast lumps, Ivory Coast lumps, Niger niggers, Benin lump, Congo, and Cameroon.

The species of *Landolphia* are all creepers or vines, which attain considerable size. They yield red and black Kassai, Upper Congo balls, and Equateur from the Congo region; virgin sheets and pinky from Madagascar; Sierra Leone niggers, twists, and cakes, all from the Sierra Leone and southern rivers; and Conarkry, Soudan, and Bassam niggers and twists from French West Africa.

The species of *Clitandra* are likewise vines and are largely distributed throughout Africa.

In certain Brazilian Provinces the *Hancornia*, which yields the rubber known commercially as Mangabeira or Matto Grosso sheets, occurs in considerable quantity.

(c) *Asclepiadaceæ*.—A rubber of high resin content termed Jelutong is obtained from species of *Dyera*, the most common being *D. costulata*. Jelutong varieties are among the commonest forest varieties in Borneo, the Malay Peninsula, and Sumatra. Pontianak is a variety of Jelutong grown in South Borneo.

(d) *Urticaceæ*.—The most important species of this order occur in tropical Asia, Mexico, and South and Central America.

Ficus elastica is found mainly in Asia (Burma, Ceylon, Malaya, Java, and India). The principal commercial brands are Assam, Rangoon, Java, and Penang.

The species of *Castilloa* (principally *C. elastica* and *C. uleri*) represent the indigenous rubber trees par excellence of Mexico and Central America. We have Peruvian "caucho" rubber from Peru, Negro caucho from Ecuador, and Mexican strips and the different "West Indian" or Centrals from Costa Rica, Nicaragua, Honduras, San Salvador, and Guatemala.

(e) *Compositæ*.—The name guayule is derived from the Spanish "hay" and the Indian "hule" or rubber yielder. The rubber-bearing species is *Parthenium argentatum*. It is a gray woody shrub of spreading habit, growing generally between 1 and 3 feet high. It differs from other rubber-bearing plants in that it has no latex but contains the rubber in the cellular tissue of the epidermis and to a small extent in the branches and leaves. The plant, when cut at the roots, will send up new shoots if rain falls within a certain time.

Guayule is now cultivated scientifically on plantations in California and southern Arizona, and the next few years should show marked progress in the cultivation of the guayule shrub in the United States.

(2) COLLECTION AND COAGULATION.—In the Amazon district the trees are tapped by means of a small iron hatchet having a blade about 1 inch broad. The incisions are generally made in the form of V-cuts or oblique lines. The first tappings are made at a height of from 6 to 7 feet, subsequent incisions at roughly $1\frac{1}{2}$ to 2 inches below the first one until the base of the tree is reached. About 35 consecutive daily tappings are therefore necessary to complete a tapping line. A fresh tapping line is then commenced at approximately 18 inches from the first one. The latex is collected in small tin or earthenware cups fixed to the tree by means of moist clay. The daily yield of latex from a mature tree is about $1\frac{1}{2}$ ounces. On this basis the annual yield of rubber from the average Amazon tree is about 5 pounds. The latex is transferred to pails and is coagulated by a smoking process.

In a small brazier a fire is made from palm nuts. A long wooden rod or paddle is so arranged, one end on a crosspiece, the other on the operator's knees, that it can be rolled either over the top of the chimney and so be exposed to the full volume of smoke, or over the basin containing the latex. The operator pours a small quantity of latex over the wooden paddle and thus forms a thin film of liquid. This is rotated in the smoke until it sets. A fresh quantity of latex is then poured upon the first film, smoke is again applied, and so on until a "biscuit" or ball of rubber of the required size (20 to 100 pounds), consisting of innumerable thin layers tightly adhering to one another, is formed. The ball is then removed from the paddle and is ready for export as the "fine Pará" of commerce.

There is some difficulty in collecting the latex from the *Manihot* trees, owing to its viscous character and its property of rapidly coagulating. The natives allow the latex to coagulate naturally as it flows down the tree, and the bulk of the rubber is collected in tears and scraps which are stripped off. A certain amount of latex reaches the ground and this is collected on leaves or directly from the soil.

The African rubber trees of the genus *Funtumia* are tapped in a manner similar to that used on the *Hevea* trees. The collecting is done entirely by the natives, and relatively little is known of their methods. *Funtumia* latex coagulates readily on boiling and most native methods are based on this fact.

The methods employed by the natives for coagulating vine latices are of the most diverse kind. Thus, red Kassai is said to be

obtained by smearing the latex on the body and allowing the natural heat to evaporate the water, after which the rubber is stripped off. Black Kassai is obtained by a combined boiling and smoking process. Some of the "ball" rubbers are obtained by applying a coagulant such as salt to the cuts made in the vine. The thread rubber thus obtained is wound into a ball of the desired size. More salt is also added at intervals so as to maintain constant coagulation. Vines do not readily lend themselves to tapping. They are generally cut down and bled to death.

Jelutong is obtained from a number of species of *Dyera*. The trees grow to a very large size, those having a diameter of from 4 to 6 feet being quite common. A mature tree will yield about 100 pounds of latex with 40 tappings per year. The latex is rich in solids and will yield about 65 per cent of wet but solid Jelutong. The latex is coagulated by the natives, who use curious mixtures of kerosene, copper sulphate, and alum. The solid matter in Jelutong, however, is quite largely resin and contains only a small percentage of rubber.

The wild guayule shrub is generally collected by pulling up the entire plant, which is baled for shipment to the factory for extraction. Special methods are used to obtain the crude rubber because it is held in the cells of the plant. The dry plant yields about 9 per cent of pure rubber, although the percentage is often greater. Guayule that is cultivated scientifically gives a yield of from 10 to 20 per cent of the weight of the dry shrub. Three types of processes have been used for the extraction of rubber from the plant: (1) The alkali process, in which the shrub is boiled with a solution of caustic alkali; (2) the solution process, in which the rubber is extracted with carbon bisulphide or some other solvent; and (3) the mechanical process. The great bulk of guayule rubber is obtained by this latter process. The shrub is crushed and ground in pebble mills with water. The material is then run into settling tanks where the water-logged woody fiber sinks, while the rubber floats and is skimmed off. It is then sheeted and washed on rubber mills and dried. The rubber so obtained is quite dark in color on the surface and contains about 20 per cent of resin. In quality it is about equal to the softer rubbers such as caucho ball and the softer crêpes. When used with the better grades of rubber, as plantation sheets and crêpes, excellent results are obtained. A large amount is also used in friction compounds.

(b) PLANTATION RUBBER

(1) SOURCES.—The plantation rubbers are obtained chiefly from Ceylon, the Federated Malay States, Dutch East Indies, Borneo, and the Pacific Islands.

The tree which is now almost exclusively grown in these plantations is the *Hevea brasiliensis*. The Hevea grows in a narrow belt on both sides of the Equator, provided there is plenty of moisture. Before planting, a great amount of work must be done to clear the land, by cutting down the trees and underbrush, then burning it over when dry. The deadwood is removed and not allowed to rot upon the ground. From this point on a vast amount of labor is required to keep out the weeds. The seeds are carefully selected from trees which give the greatest yield of rubber, and extreme care is taken in their propagation. One or two year old plants from the nurseries are set out from 50 to 200 to the acre during the rainy season. The trees increase in height from 6 to 10 feet a year and in girth from 3 to 5 inches. They are not ready for tapping until 5 or 6 years old. The annual yield from such young trees is less than a pound of rubber each and gradually increases as the trees grow older. The mature trees yield up to 4 pounds of rubber per year.

(2) COLLECTION AND PREPARATION FOR MARKET.—The trees are tapped mostly on the herringbone system, which consists of a series of oblique cuts running into a central channel. In making the cuts strips of bark of one-thirtieth to one-twentieth inch are pared away. Tappings take place daily or on alternate days over certain periods. This is repeated until a certain area of bark has been removed. The portion of the tree so operated on is then allowed a period of rest sufficient for the renewal of the bark; for this three to four years appears to be an appropriate period. The latex is collected in a cup attached at the lower end of the channel.

Plantation latex is generally coagulated by the addition of a small quantity of acetic acid. The coagulum is then passed through the washing rolls, which squeeze out much of the remaining mother liquor and wash out the excess of the other constituents of the latex. These rolls are of much the same construction as those used in the factory for washing. (See Fig. 1.) The treatment to which the rubber coagulum is subjected has an important bearing on the quality and marketability of the rubber. One of two courses is usually adopted: (a) The rubber is merely

sheeted by the action of the washing rolls, by which process an appreciable quantity of the other constituents of the latex is retained. In order to avoid mold or tackiness, the rubber should be thoroughly smoked. (b) The rubber is converted into crepe and thoroughly washed during the process to remove the other constituents of the latex as far as possible.

The rubber as it leaves the washing rolls is in sheets about one-eighth inch thick and 10 to 14 inches wide; the length may vary from a few feet up to 30 or 40 feet. These sheets are hung in a room at a temperature of 90 to 100° F until they are dry. Sometimes the room is kept full of smoke during the drying process. Almost any hardwood, coconut husks, or the like may be used to produce smoke. Smoke not only acts as an excellent antiseptic and preservative but seems to improve the strength of the rubber. The latter effect has yet to be explained. The sheets of rubber are pressed into blocks and are exported as plantation crepe or smoked sheets.

It is interesting to note the tremendous development of the production of plantation rubber. In 1900 practically none was produced; in 1910 about 8000 tons and in 1919 over 285 000 tons were produced. The plantation acreage has increased from slightly over 1 000 000 acres in 1910 to about 2 900 000 in 1919. The annual production of wild rubbers from Brazil and Africa was about 60 000 tons during this period. Unless modern scientific methods are adopted this amount will not be increased. The United States used over 75 per cent of the world's production of rubber in 1919.

(c) SYNTHETIC RUBBER

Synthetic rubber has been made by the gradual polymerization of the hydrocarbons butadiene, monomethyl butadiene (isoprene), and dimethyl butadiene (methyl isoprene). Each yields a different type of rubber of somewhat different composition and properties. Such rubber oxidizes readily, requires accelerators for vulcanization, and its physical properties are comparable with those of the poorer grades of natural rubber. Unless synthetic rubbers can be made as good as the natural rubbers and as cheaply, they will not be manufactured commercially.

(d) CHEMICAL AND PHYSICAL PROPERTIES OF RUBBER

Rubber belongs to the class of compounds known to the chemist as hydrocarbons; that is, substances which contain only the elements carbon and hydrogen. Harries, Weber, and other investigators determined that the formula for the rubber molecule is

polyprene, which is derived from the simpler hydrocarbon isoprene. The preparation of synthetic rubbers is based on the above work.

Rubber can be made to combine with sulphur by a process known as vulcanization. In 1839 Charles Goodyear found that the physical properties of crude rubber are considerably altered by heating it with sulphur. At about the same time John Hancock found that by immersing rubber in a bath of molten sulphur vulcanization takes place. In 1846 Parkes discovered the cold cure process, which consists of immersing the rubber in a weak solution of sulphur chloride, or subjecting it to the vapors of such a solution. The solvent is generally carbon bisulphide or carbon tetrachloride. This method gives only superficial vulcanization, and can be used only on very thin sheets, for the rapidity of the reaction is so great that thick material will be overvulcanized on the surface by the time the interior is vulcanized.

The beneficial changes that are brought about by the process of vulcanization are as follows: The strength, elasticity, and resilience of the rubber are increased, it loses its adhesiveness, is less affected by changes of temperature, and becomes insoluble in the ordinary rubber solvents.

Attempts to explain the process of vulcanization have been made, but the various investigators do not agree. Thus Weber believed that vulcanized rubber is an "addition product" which is formed by chemical combination between sulphur and rubber hydrocarbon, whereas Ostwald believed that it is only a physical combination between the rubber and sulphur. It is not the purpose of this circular to attempt to discuss the different theories of vulcanization.

The specific gravity of clean commercial rubber is about 0.92, but varies with the species, method of coagulation, and purity; the values obtained by various investigators are from 0.91 to 0.97. On warming, unvulcanized rubber becomes soft, then sticky, and finally melts. At temperatures below the freezing point of water it loses its elasticity and becomes rigid, and on immersion in liquid air becomes as brittle as glass. It is insoluble in water, but upon soaking in water for a long time it will absorb up to 25 per cent. It dissolves in a number of organic solvents such as benzene, chloroform, carbon bisulphide, naphtha, etc. Rubber is a poor conductor of electricity and heat. It is not affected by alkalis, or weak hydrochloric and sulphuric acids, but concentrated sulphuric acid and nitric acid of any concentration attack it. It gradually oxidizes in air with the formation of resins.

2. GUTTA-PERCHA AND BALATA

These substances are not rubber but have many properties similar to those of rubber, and are used in the rubber industry.

Gutta-percha is obtained from various trees, belonging to the natural order Sapotaceæ, growing on the Malay Peninsula and the Archipelago. The trees of the species *Dichopsis* (*Palaquium*) *payena* and *Dichopsis polyantha* are the main sources.

The latex is collected generally by cutting down the tree and ringing the bark at intervals of 12 to 18 inches along the trunk. The milky fluid fills the grooves, soon coagulates, and is scraped off with a knife. Some latices do not coagulate quickly and these are collected in vessels. They are gently boiled with or without the addition of water. The raw gutta is cut up, softened in hot water, washed on a washing machine, and then forced through a strainer. After a second washing the inclosed water is forced out by a kneading machine and the mass is sheeted out in about 5-foot slabs one-eighth to one-fourth inch in thickness. The above method of collecting the latex by cutting down the trees is extremely wasteful.

Commercial gutta-percha is hard and tough, but on warming to 115 to 122° F it can be pressed into any shape, which it will retain on cooling. Its main use is for the insulation of submarine cables. A small amount is used for handles for surgical instruments and for golf balls.

Gutta-percha consists of 30 to 84 per cent of "gutta," a rubber-like material, and 10 to 60 per cent of resin, which consists of albane, a crystalline resin, and fluavile, a yellow amorphous resin, in the ratio of about 2 to 1.

Gutta-balata is obtained from the latex of the *Mimusops balata*, a tree growing in British, Dutch, and French Guiana. The commercial product comes in slabs about one-fourth inch thick, horny, and from a white to dark cream in color. It is collected in the same manner as gutta-percha, for which it is the only substitute. It has similar properties, although it is somewhat softer, owing to the fact that it contains more of the softer resin fluavile. It contains the resins in the proportion of approximately two parts of albane to three parts of fluavile. The main use of gutta-balata is in the manufacture of belting for power transmission.

3. RECLAIMED RUBBER

The object in reclaiming rubber is to restore useful properties to the scraps of worn-out articles, so that the material may be used again. The aim is to restore to the vulcanized rubber the properties of crude rubber. This has not been accomplished, for no one has yet succeeded in removing the combined sulphur. All that can be done is to restore its plasticity so that it can be again worked and further vulcanized. The methods used are as follows: Alkali, acid, and solvent reclaiming.

The alkali process was patented in 1899. The old rubber is ground and then treated with caustic-soda solution in a closed tank at a temperature of about 360° F for about 20 hours. The residue is then washed and dried. This treatment removes the fabric, free sulphur, and a portion of the fillers.

The acid process was patented in 1881. The ground rubber is treated in a closed tank with sulphuric or hydrochloric acid of suitable strength in contact with live steam for from one to five hours. The residue is washed and dried. This treatment removes the fabric and dissolves all the acid-soluble fillers.

The solvent process is misnamed. The oils added do not dissolve the rubber but merely soften and agglutinate it. In general, the finely ground rubber is heated with vegetable, resinous, or mineral oils to agglutinate the mass. The objection to this method is that it does not remove the free sulphur present and gives a very soft and sticky "reclaim." This process is very little used to-day.

Variations of the above processes have been tried; for instance, the fabric and free sulphur have been removed by alkali and then the resultant mass treated with an oil or other material like phenol or aniline.

The properties of reclaimed rubber may be summed up as follows:

1. No reclaimed rubber has yet been produced which is equal to good new rubber.

2. Compounds made from reclaimed rubber are more or less inferior in strength and stretch to those made of new rubber.

3. Good reclaimed rubber is a valuable ingredient in rubber goods of a moderate price and in which a large quantity of mineral fillers can not be employed. It also serves a useful purpose in producing better aging properties in compounds to be used under special conditions.

4. RUBBER SUBSTITUTES

No true rubber substitute—that is, no material possessing all the properties of rubber—has yet been produced. Synthetic rubber is identical in composition with crude rubber and so can not be called a substitute. The term “rubber substitute” is commonly applied to materials which are produced by vulcanizing certain vegetable oils, such as rape, corn, and cottonseed oils, either by treatment with cold sulphur chloride or by heating with sulphur. The sulphur-chloride process produces a white substitute, while that made with sulphur is known as brown substitute. These substitutes are used in the manufacture of cheap soft rubber articles of low specific gravity. Their use tends to reduce the strength, elasticity, and wearing qualities of the finished product, and they are unsuited for use in articles which are subjected to high temperatures.

The so-called mineral rubbers should not be considered forms or varieties of rubber. They are bituminous materials, either natural products, such as gilsonite, or other types of asphalt, or the crude tar residue from the distillation of petroleum.

5. VULCANIZING INGREDIENTS

Since the time when Charles Goodyear patented the vulcanization of rubber by heating with sulphur, a large number of experiments have been carried out to vulcanize rubber by means of some ingredient other than sulphur. Vulcanization was attained by the use of chlorides, nitrates, nitrites, fluorides, bromides, iodides, sulphides, polysulphides, sulphites, and thiosulphates of nearly all of the common earths and metals, and also by the use of selenium, bromine, and iodine. None of these methods is in use.

6. COMPOUNDING INGREDIENTS¹

The substances that are mixed with rubber in the manufacture of rubber goods comprise a list of materials of widely varying natures. The rubber compounder finds it advantageous to classify these substances into definite groups, although often there is some overlapping between them.

What may be accomplished by the proper use of compounding ingredients is indicated by the fact that countless commodities

¹ The specific gravities of a number of the substances used in the rubber industry are given in the appendix. These results, which were taken from a number of sources, indicate how the specific gravities of these substances may be expected to vary. The methods for the determination of the specific gravity, cost per pound, and cost per cubic foot of a rubber compound are also given in the appendix.

of rubber are now made. The ingredients may be classified as follows: (a) Fillers (1, inorganic, 2, organic); (b) Accelerators (1, inorganic, 2, organic); (c) Pigments.

(a) **FILLERS**

Certain fillers when mixed with rubber add qualities to the rubber compound which make their use desirable. A number are added merely as cheapeners and impart no desirable properties. If an excess of fillers is used, their effect on the rubber compound may be detrimental. The cost per unit volume is often the determining factor in the use of one filler in preference to another.

(1) **INORGANIC FILLERS.**—Among the inorganic fillers are those which when added to rubber impart certain definite properties, such as toughness, increase in tensile strength (within certain limits), hardness, compressive strength, increased insulating properties, and resistance to steam and abrasion. The following list contains the most frequently used fillers and some of their general properties:

Zinc oxide, lithopone, carbon black, lampblack, and magnesium carbonate not only slightly increase the rate of vulcanization but have a decided toughening effect on the rubber. Zinc oxide also improves the insulating properties of rubber.

Aluminum flake, whiting, barytes, barium carbonate, and china clay impart no special properties and are considered as being inert.

Tripoli (infusorial earth), talc, and soapstone tend to make the compound dry and stiff. Talc and soapstone are used mainly for dusting sheets of unvulcanized rubber and molds to prevent sticking during vulcanization. Asbestine is used in heat-resisting compounds; powdered glass and pumice are used in erasers.

(2) **ORGANIC FILLERS.**—The organic fillers include a large number of oils, vulcanized oils, waxes, paraffins, bitumens, and pitches. They are used mainly to facilitate the mixing of the inorganic fillers with the rubber, to render the compound adhesive, to soften the texture of the vulcanized compound, to soften the compounds which have to go through a tubing machine, etc., to decrease the porosity, increase the resistance to water, gas, acids, and alkalies, to decrease the specific gravity, and in the manufacture of insulated wires and waterproof material.

Blown asphalts, called mineral rubbers, asphalts, pine tar, and coal tar are used in the manufacture of insulated wires, and tend

to prevent the "flowering" out of the sulphur. They are also used, as well as resin and shellac, in compounds that are to be used as frictions. They may be called the adhesive softeners.

Paraffin, ceresin, and ozocerite are used to make compounds work more smoothly during the mixing and if properly used improve the aging qualities of rubber compounds. Palm oil and vaseline also make compounds work more smoothly during the mixing.

White, brown, and black substitutes impart to the finished product the soft velvety feeling of a purer rubber compound.

Ground cotton, leather, cork, and wood pulp are used mainly in the manufacture of soles, in which lightness, nonslipping properties, and increased porosity are desirable.

Linseed oil, paraffin oil, and aluminum palmitate are used in the manufacture of waterproofing material.

(b) ACCELERATORS

Accelerators are substances which, when added to a rubber compound, decrease the time required for vulcanization. Without their use the output of a factory would be much smaller and the cost of rubber goods proportionally higher. They may be classified in two groups, inorganic and organic.

(1) INORGANIC ACCELERATORS.—Litharge, magnesium oxide, and lime are the most frequently used and are especially good for the vulcanization of soft rubbers that are rich in resins, and to which have been added oils, waxes, and pitches. White lead (basic lead carbonate), sublimed white lead (basic sulphate), and red lead are used to a less extent.

(2) ORGANIC ACCELERATORS.—During the last few years the use of the organic accelerators has increased considerably because of the large number of investigations that have been carried out. Their importance lies in the fact that they are extremely active and decrease the time of vulcanization to a greater extent than the inorganic accelerators. However, because of their activity extreme care must be taken in their use to avoid overvulcanization. Many organic compounds may be used as accelerators. They may be classified as follows. ²

² Andrew H. King, *Chemical and Metallurgical Engineering*, 15, No. 5.

CLASSIFICATION

- 1.—Carbon bisulphide addition products with:
 - (a).—Aniline.
 - (b).—Dimethylaniline.
 - (c).—Tetrahydropyrrole.
 - (d).—Dimethylamine.
- 2.—Ammonium compounds:
 - (a).—Ammonium borate.
 - (b).—Aldehyde ammonia.
 - (c).—Quaternary ammonium bases.
- 3.—Amino compounds:
 - (a).—Paraphenylenediamine.
 - (b).—Tetramethylenediamine.
 - (c).—Sodium amide.
 - (d).—Naphthylenediamine.
 - (e).— $\beta\beta$ dimethyl trimethyleneamine.
 - (f).—Trimethyleneamine.
 - (g).—Benzylamine.
- 4.—Piperidine and derivatives:
 - (a).—Piperidine.
 - (b).—Methyl piperidine.
- 5.—Quinoline and derivatives:
 - (a).—Quinoline.
 - (b).—Quinoline sulphate.
 - (c).—Quinosol.
 - (d).—Oxyquinoline sulphide.
- 6.—Miscellaneous:
 - (a).—Anthraquinone.
 - (b).—Urea derivatives.
 - (c).—Formanilides.

However, the most commonly used are thiocarbanilide (diphenylthiourea), hexamethylenetetramine, paranitrosodimethylaniline, and aniline.

(c) PIGMENTS

These are essentially used for their pigmenting value, although some, such as zinc oxide, lithopone, carbon black, and lampblack, are used for the special properties that they impart to the rubber compound. Antimony sulphide is used as a sulphur carrier. The following are used merely as pigments: Red oxide, Indian red, Venetian red, ultramarine blue, cobalt blue, Prussian blue, indigo, chrome green, cadmium sulphide, vermilion, yellow ocher, and chrome yellow.

III. PROCESSES USED IN THE INDUSTRY

1. WASHING OF CRUDE RUBBER

The wild rubbers and some grades of plantation rubbers must be washed to remove mechanically mixed impurities, such as sand, wood, stones, fragments of plant tissue, salts, etc. The method of washing depends upon the type of rubber. Most of the plantation rubber, however, reaches the factory clean and ready for use.

The rubber to be washed is placed in tanks of warm water until soft, after which the larger pieces are cut up by circular knives or powerful shears and torn up on the cracker. The cracker is a massive machine which has two corrugated hardened steel rolls (see Fig. 1) which rotate toward each other at different circumferential speeds and thus produce a tearing action. The rubber comes out torn into ragged pieces. During the process a continuous stream of water is allowed to flow down on the rubber. If the rubber is very dirty, it is placed in a churn or beater washer. The churn washer consists of an oval tank in which a large paddle wheel keeps the rubber and water in continuous agitation, while the impurities settle to the bottom. After this the rubber is washed on a washer until it comes out in a continuous uniform sheet having the appearance of crepe. A washer (see Fig. 1) is similar to a cracker, except that the corrugations are finer.

2. DRYING

The method of drying depends upon the properties of the various rubbers. Those having sufficient strength are hung in sheets in a large dark room, through which a current of warm air is passed. The lower grades of rubber which are sticky and not strong enough to bear their own weight are dried on horizontal racks. By this method four weeks or more are required. It has been largely replaced by the more rapid method of vacuum drying by which the rubber is dried in pans. Rubber is also dried under automatically controlled temperature and humidity.

3. COMPOUNDING OR MIXING

The mixing of the rubber compound is carried out on a massive "mill," similar to Fig. 1, which consists of two smooth, polished cast-steel rolls which rotate toward each other, the back roll rotating slightly faster. They are hollow and have steam and cold-water connections for the regulation of the temperature as required by different types of rubber compounds. The distance between

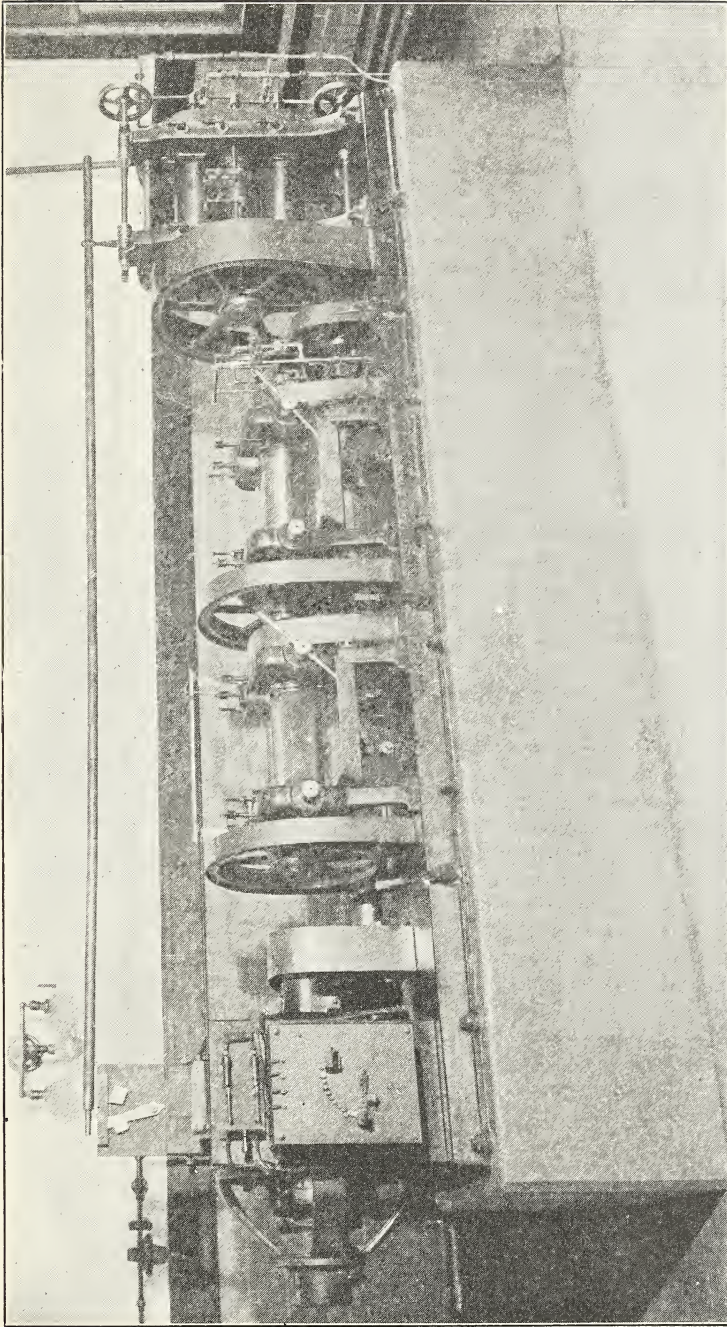

FIG. 1.—Experimental "cracker," mixing mill, and calender used in preparing rubber compounds of definite composition

The cracker is used to wash dirt, bark, etc., from the crude rubber; the mixing mill is used for incorporating the compounding ingredients with the rubber, and the calender for sheeting out the rubber compound

the rolls is adjustable by means of set screws in the front part of the frame.

The rubber is placed on the rolls and adheres to the slower moving front roll, which is the warmer. At first the rubber has the appearance of a ragged sheet. Pieces which break off are caught in a pan set beneath the rolls and are again added to the mass. The mass gradually softens and becomes a smooth sheet, when it is ready for the addition of the fillers. The operation just described is called "breaking down" the rubber. The fillers are now gradually added. The part which sifts through into the pan is again added to the mass. During the breaking down of the rubber and the mixing the operator slits the sheet with a short knife and folds

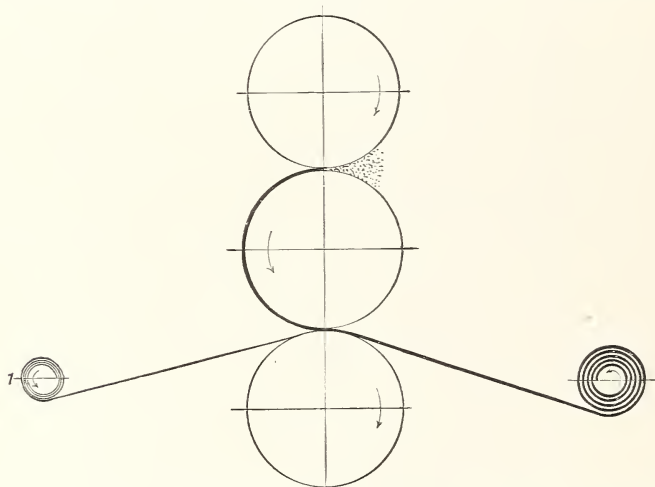

FIG. 2.—Diagram showing operation of calender rolls illustrated in Fig. 1

it back on itself as it goes in between the rolls. The sulphur and accelerator are frequently and preferably added after the fillers have been incorporated with the rubber. The mixing is continued until a homogeneous mass has been obtained, when it is cut off in slabs, dusted with talc or soapstone, and sent to the storage room.

4. CALENDERING

Sheets of any thickness are produced by running the rubber on a calender (see Fig. 1) which consists of three adjustable hollow, smooth, polished steel rolls, similar to those of a mixing machine, set vertically in a massive iron frame and rotated at the same rate of speed. The temperature required for various rubber compounds is secured by steam and cold-water connections to the rolls. The

rubber compound before going to the calender must be softened by working on a "warmer," which is generally located in front of the calender and is similar to a mixing machine. The skeleton diagram in Fig. 2 shows the method of operation.

The rubber from the warming mill is fed in between the two top rolls, which rotate toward each other. The rubber compound adheres to the middle roll until it is taken up by the running cloth from reel 1 which passes between the second and third rolls, which rotate toward each other. As the rubber comes in contact with the winding cloth, which is to keep it from sticking together, and

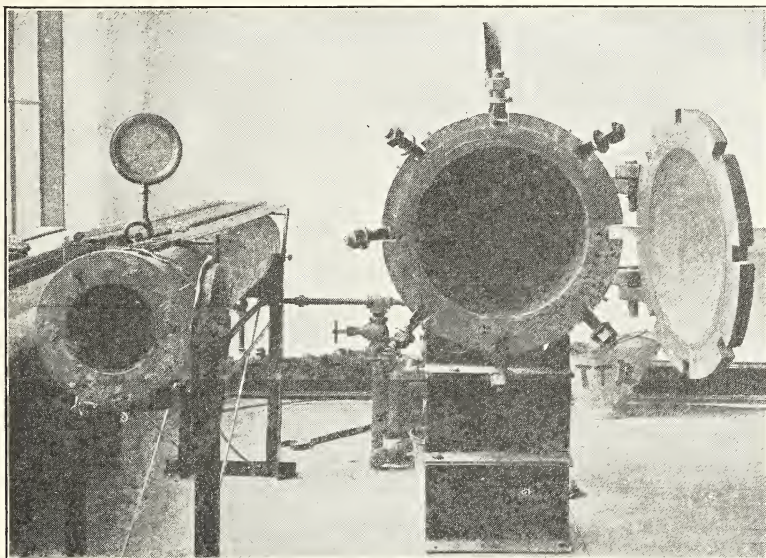

FIG. 3.—Vulcanizing boilers for the vulcanization of hose, tubing, etc., which are cured in open steam

is carried to reel 2, a winding apparatus automatically winds the rubber and cloth on a wooden or metal drum. The desired thickness is obtained by building up the necessary number of layers. This process tends to avoid flaws in the finished sheet.

5. FRICTIONING

The "friction" is a layer of rubber which acts as an elastic bond to hold together layers of rubber and fabric or layers of fabric. The "frictioning" is carried out on the same type of machine as a calender; in fact, a calender is generally geared so that it can be used for calendering or frictioning. In calendering

the rubber is merely sheeted out to a definite thickness, whereas in frictioning it is forced into the meshes of the fabric. The forcing of the rubber compound into the fabric is accomplished by driving the bottom roll at a slower speed than the middle roll.

6. VULCANIZATION

Vulcanization is the term applied to any process that so combines a part of the sulphur with the rubber as to transform the raw

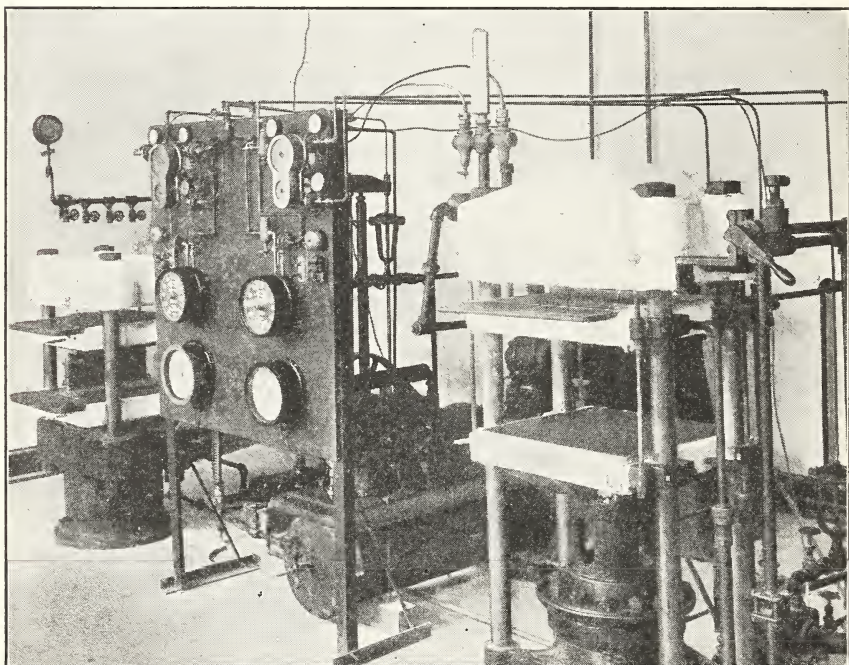

FIG. 4.—Vulcanizing press equipped with constant temperature control

This is used for the vulcanization of molded articles which are cured under pressure. The temperature and time of vulcanization are controlled automatically

mixed rubber by physical and chemical reactions to the finished article.

The different methods of vulcanization are:

(a) *Open Steam Cure.*—The vulcanizer or heater (see Fig. 3), which consists of an insulated cylinder provided with steam and drip connections, is heated either by direct steam or a steam jacket. The rubber goods are placed in an iron carriage which is run into the heater on tracks, the door is closed, and the steam turned on. The temperature of the heater should be controlled automatically.

(b) *Press Cure.*—The vulcanizing press (see Fig. 4) is used for molded goods. It consists of two or more hollow platens heated by

steam with automatic temperature control. They are forced and held together by hydraulic pressure, the rubber being contained in molds placed between the platens.

(c) *Cold Cure*.—"Cold cure" consists in dipping the rubber article in a solution of 1 to 3 per cent of sulphur chloride in carbon bisulphide or carbon tetrachloride. This method is used only for the manufacture of thin articles.

(d) *Bath Cure*.—Vulcanization is also carried out by dipping the rubber articles into a bath of molten sulphur.

(e) *Hot-Air Cure*.—Vulcanization is carried out in large chambers heated by steam in which the air is thoroughly circulated.

(f) *Vapor Cure*.—This is accomplished by exposure to the vapors of a solution of sulphur chloride.

IV. MANUFACTURE OF RUBBER GOODS

1. SOLID RUBBER TIRES

Although there are several types of solid tires, the methods of manufacture are essentially the same in most respects. They all consist of a tread or wearing portion which constitutes the larger part, and a hard rubber base. In some tires there is a strip of rubber to act as a bond between the tread and the base. The base is squirted through a tubing machine and comes out in the proper shape to fit the steel tire rim. A tubing machine (see Fig. 5) contains a great screw revolving inside a cylinder. The rubber is fed into the mouth of the cylinder and is forced out through a die which gives it the proper shape. The opening through which the rubber comes out is heated by steam to make the rubber more plastic. The stock is delivered from a "warming-up" mill directly to the tubing machine. After leaving the machine the tubed stock passes out on a table where it is cut into proper lengths. The tread stock is tubed as described above or built up to the required thickness from calendered sheet which is wound over the hard rubber base. The steel rim is painted with rubber cement; then the base and tread are put on. After the base and tread have been placed upon the rim, the tire is allowed to rest at least a day before it is vulcanized. About 20 tires are vulcanized at once, the molds being stacked one upon the other and closed by hydraulic pressure exerted by a plunger which passes up through the bottom of the steam-heated vulcanizer. The "cure" or time required to vulcanize tires is several hours, the exact time depending on the nature of the stocks.

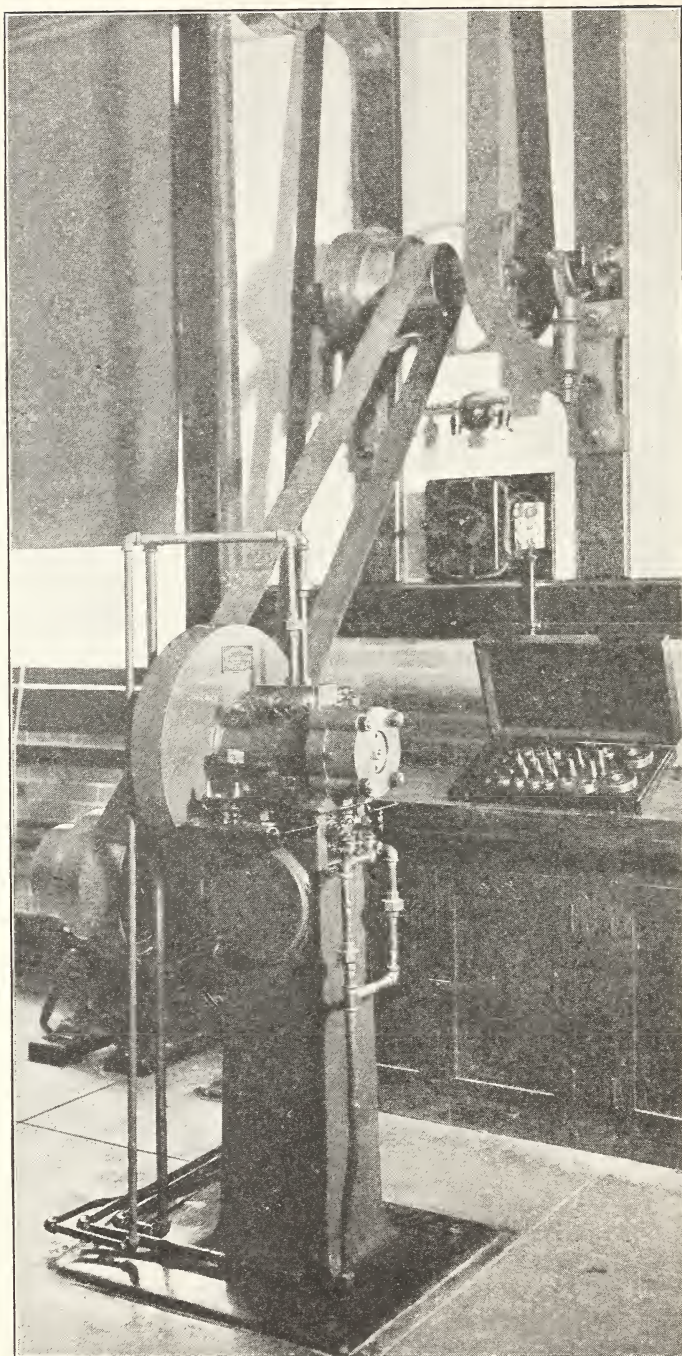

FIG. 5.—Machine for making seamless rubber tubing by forcing the rubber compound through a die

The cure is longer for solid than for pneumatic tires, because of the thickness of rubber through which the heat must penetrate.

2. PNEUMATIC TIRES

(a) FABRIC

The fabrication of pneumatic tires consists in building up on a core the tire structure from the various parts which are distinctive and are made independently. The building of the tire consists therefore in assembling these various essential parts, called the "bead," the "frictioned fabric," the "cushion," "breaker strip," "side wall," and the "tread."

The "bead" is the edge of the casing which holds the tire in place on the rim. There are two types of beads, the clincher and the straight side. The clincher bead is usually made of rubber which is run on a tubing machine and partially cured before going into the tire. The straight-side bead is rubber reinforced with strands of steel wire. A coat of cement is applied, and layers of fabric are put on. The beads are now ready for tire building.

The tread is run on a tubing machine or on a calender designed to give the desired shape. The side wall is cut from a calendered sheet.

The fabric which is to be frictioned is first dried by passing it slowly over steam-heated rolls. While still warm it is delivered to the frictioning calender. When cloth is to be frictioned on both sides, it is sent back through the same process. As it comes from the calender a "liner" is wound up with it to prevent the rubber from sticking. Besides being frictioned on both sides, the fabric is "skimmed" on one side; that is, a thin layer of rubber is calendered on. The fabric is now taken to bias cutters, which cut definite widths on a 45° angle with the warp. The machine operates as follows: A row of automatic fingers grasps the edge of the fabric and pulls it forward the required distance. Then a knife drops and cuts off a strip. The fingers release the strip and return to grasp another width of fabric. The fabric is unwound automatically from the roll as it came from the frictioning calender and a slack is maintained between the unwinding device and the cutter. The pieces as they are cut off drop upon an endless belt which carries them to the operator, who picks them up and places them between layers of fabric. They are now taken to the "splicer," who laps the ends and presses them

down with a roller. The continuous lengths are now wound upon rolls with a liner between the layers of fabric, which is now ready for tire building, the general procedure being as follows:

Tires are built on iron cores having the shape and size of the inside of the tire. The tire-building machine is arranged so that the core can be revolved and the frictioned fabric fed from rolls on adjacent racks. About half of the total number of plies which are to be used in making the tire are put on. In doing this, care is taken that no seams shall come over each other. Each ply is rolled down smooth before applying the next one. After this has been done the bead is put in place on each side and the remaining plies are put on. The plies of fabric are worked around the bead, and the side wall is put in place. A strip of practically pure rubber, called the "cushion," goes on top of the fabric. On the cushion is placed a "breaker strip" of coarse loosely woven fabric, and finally the tread is applied. It is good practice to have the work inspected after each operation in order to detect any defects in workmanship which might otherwise be concealed in the finished tire. Tires are vulcanized on the iron cores in molds which have depressions to produce the characteristic design of the tread. The vulcanizer is the same as that used for solid tires.

(b) CORD

Cord tires are manufactured substantially the same way as fabric tires. Cord fabric is composed of parallel warp cords laid close together without the usual filler strands other than small threads of soft, light yarn, spaced about one-half inch apart. These threads act as a temporary support for the warp cords to hold them in place until the tire has been fabricated.

The cord fabric is run over steam-heated rolls to dry it completely, and is then frictioned on a calender or run through a trough containing a solution of rubber friction stock. In the latter case the fabric is dried by being conducted over steam-heated coils or rolls. It then passes into a second tank of rubber solution, is dried thoroughly, and wound up with a liner. The cord fabric is then cut on an approximately 45° bias and the plies are butted instead of lapped as in the fabric construction. The tires are cured over an inflated bag which is similar to an inner tube reinforced with two or three layers of fabric. After the molds are on, the bags are inflated and the tires cured in the same manner as fabric tires.

3. INNER TUBES

The method of manufacture of inner tubes varies. In general, the rubber sheet which has been calendered to the proper thickness is cut to the desired width and length. This is wrapped one or more times around a steel tube called a "pole" and the edge rolled down, so as to form a tight seam. The poles are piled in racks and the tubes cured in steam, the method being similar to that described under "plied hose." After they are removed from the vulcanizer the tubes are drawn off the poles by inflating them with compressed air in such a manner as to turn them inside out. The ends, if not already tapered during the process of manufacture, are placed on mandrels and forced against a wet, high-speed, circular knife which skives them so that they can be smoothly spliced without much increase in thickness. The tapered ends are roughened on a wire buffing wheel. At the point where the valve is to be inserted the tube is reinforced with a valve patch, which consists of an oval-shaped piece of rubber, generally with two plies of fabric inserted. The valve hole is punched and the valve screwed on. The ends are now placed on special sleeves and coated with rubber cement. After the cement has dried they are brushed with a dilute solution of sulphur chloride, and by means of compressed air one end is slipped over the other end and strapped down firmly with a rubber strip until properly vulcanized, after which the strip is removed. The ends are less frequently cured by heat. The tube is then inflated and immersed in water to detect any leaks.

4. PLIED HOSE

(a) MACHINE-MADE HOSE

For hose of small diameter it is usual to form the tube by passing the rubber compound through a tubing machine. The compound is first softened on a warming mill, generally situated near the tubing machine. The tube as it comes from the nozzle of the machine is carried away on an endless belt which is adjusted to run at the proper speed. The desired lengths of tube are cut and talc blown in, if this has not already been done as it emerges from the die. These tubes are placed on steel mandrels by a rather ingenious process, as follows:

The mandrel, which is about 52 feet long, is placed on an endless belt and held stationary. One end of the tube having been placed over the mandrel, sufficient air pressure to expand the tube

slightly is applied at the other end. The belt is now set in motion, and the tube as it is fed upon the belt floats over the mandrel on a cushion of air.

Canvas for use in making rubber hose is usually cut on the bias from strips 40 to 42 inches wide into pieces long enough so that when placed end to end and lapped the resulting strip is just wide enough to produce the necessary number of plies on the hose.

The tube is wiped off with a rag moistened with gasoline and the frictioned fabric applied. The frictioned fabric is wrapped on by a machine which consists of three rolls of about 2 inches in diameter and slightly over 50 feet long. The two bottom rolls lie in the same horizontal plane, and the top roll, which is just above and between the other two, can be raised while the pole or mandrel carrying the tube to be wrapped is being placed on the bottom rolls. After the mandrel is in place the top roll is lowered and thus held firmly between the three rolls. A rotary motion imparted to the rolls causes the tube to revolve, and the fabric and the rubber cover, which is attached to the fabric, are wrapped on in a few seconds. Before going to the vulcanizer the hose is wrapped with wet cloth. First a long strip is wrapped lengthwise on the hose and over this a narrow strip is wrapped spirally. This is done in a machine similar to that used for wrapping the frictioned fabric and rubber cover around the tube. The narrow strip is held under tension and guided by hand. The hose is now placed on racks set in a carriage and run into the vulcanizer and cured. The steam pressure and time necessary for vulcanization depend upon the composition of the rubber compound, size of the hose, and the use for which the hose is intended.

After vulcanization the wrapping cloth is wetted, stripped off, and the hose is removed from the mandrel by means of compressed air. The couplings are now put on and the hose sent to the store-room.

(b) **HANDMADE HOSE**

For hose of a diameter greater than $1\frac{1}{2}$ inches the tube is usually made from a strip of sheet rubber calendered to the proper thickness. The sheet is skived or cut with a tapering cut and wrapped around a mandrel by hand so that the edges overlap. They are pressed flat by means of a small roller to make a perfect seam. The frictioned fabric is cut as above for tubed hose, laid over the rubber tube on the mandrel, and gradually rolled around it by

means of a small hand roller until the required number of plies have been made. The rubber cover is made from a sheet of calendered rubber of the proper width to pass around the hose once and form a narrow lap, and put on in the same manner as the fabric except that the lap is carefully rolled down to form a perfect seam. In suction or high-pressure hose, wire is generally used to strengthen the walls. It is wound on spirally and strips of rubber used to fill the spaces between the turns of wire. The hose is generally wrapped with a long strip lengthwise on the hose and then with a narrow strip wound spirally by rotating the hose on roller bearings. The narrow strip is held under tension and guided by hand. The hose is then finished as described above under tubed hose.

5. BRAIDED HOSE WITH RUBBER TUBE AND COVER

Another type of hose is made by passing a rubber tube, which is distended by moderate air pressure, through a bath of cement and then to the braiding machine where the first ply of fabric is braided over fresh cement. The dipping and braiding are repeated until the desired number of plies have been formed. Then the rubber cover is put on and the hose is vulcanized in a mold. While being vulcanized the hose is subjected to air pressure from within, which forces the rubber well into the meshes of the loosely braided fabric. Braided hose is wrapped and vulcanized in open steam under air pressure.

6. COTTON RUBBER-LINED HOSE

In the manufacture of woven cotton hose with a rubber lining the tube is made by hand in the usual way, and partially vulcanized in order that it may develop sufficient strength to be drawn through the cover. In the better grades the semicured tube is covered with a thin layer of softer compound known as the "backing." In the cheaper grades of hose the tube is sometimes merely coated with rubber cement. A long slender rod is passed through the cover and carries with it a stout cord which is attached to the end of the rubber tube. This tube is now drawn through the cover. The ends are clamped over cones and the hose is filled with steam under pressure. This expands the tube, forces the backing into the fabric, and vulcanizes the rubber. The vulcanization is carried out on an inclined table in order that the condensed steam may escape through a trap at the lower end.

7. RUBBER TUBING

Rubber tubing, for which there is a large demand, is made either with a tubing machine, as described on page 29 (tubed hose) or from calendered sheet as described on page 29 (inner tubes). Compounded tubing which is most extensively used for general purposes is made by the former method. Dies and cores of different sizes are provided. They may be interchanged to produce any diameter and thickness of wall within the machine's capacity.

Pure gum tubing is usually made from calendered sheet, but it is sometimes run on a tubing machine. Its production by the latter method is rather difficult and requires careful supervision.

Tubing is vulcanized in open steam. The lower grades, through which talc has been blown to prevent adhesion of the walls, are coiled up and imbedded in pans of talc and vulcanized. The better grades of tubing, which become very soft during vulcanization, have to be placed on mandrels and wrapped with sheeting. They are vulcanized as described on page 30.

8. RUBBER BELTING

Duck for rubber belting is passed over steam-heated rolls to remove the moisture and is then frictioned on both sides, as described under manufacture of pneumatic tires. The frictioned duck is cut lengthwise into strips, the width of which depends not only on the size of the belt, but also on the method of manufacture. The duck is cut to any desired width by an arrangement of adjustable circular knives.

One method is to make the inner plies of the belt with strips which are equal in width to that of the belt. These strips, stacked one above the other, are placed in the center of a strip of double the width and in this position they are drawn through an opening with flared edges which folds the bottom strip over the others and forms a butt joint on the top face of the belt. The belt then passes between rolls which press the plies firmly together and at the same time lay and press a narrow strip of rubber over the joint. When the belt is to have a rubber cover, this is generally calendered on the outside ply of fabric before it is put on. Rubber-covered belting is necessary only for conveyors and a few other special uses.

In another method the plies are made of folded strips. The first strip is folded upon itself, as described above, so that its

edges form a butt joint. This folded strip is placed with the joint down upon the next strip which is, in turn, folded to form a butt joint on the back of the first strip. In this way the belt is built up with the desired number of plies. Where there is an odd number of plies the first strip is not folded. The last joint is covered with a narrow strip of rubber which is rolled flush with the surface.

The belt is vulcanized while it is stretched and held under heavy pressure between the steam-heated faces of a long hydraulic press. This drives the friction into the meshes of the duck, vulcanizes the rubber, and prevents the belt from stretching excessively when in use.

9. MOLDED RUBBER GOODS

A large variety of rubber goods, such as valves, heels, fiber soles, mats, erasers, tiling, etc., are vulcanized in molds under hydraulic pressure. They are usually made from calendered sheet built up to the required thickness. Pieces are cut from the sheet either by hand or machine by means of dies of the approximate size of the finished article. The pieces are trimmed to a definite weight so that they all have the same volume before they are placed in molds and cured.

10. INSULATED WIRE

Vulcanized rubber is used in large amounts for electrical insulation. The wire, which is generally coated with tin, is covered with rubber in one of two ways: The rubber may be "squirted" on the wire through a machine resembling the tubing machine, or it may be calendered into thin sheets which are cut into strips and pressed around the wire by means of a coating machine. Small wires are wound in layers on slightly tapered drums and then vulcanized, but the larger sizes must first be wrapped with tape frictioned on one side so that the insulation may not be pressed out of shape. Vulcanization is carried out in open steam. It is of great importance that the steam throughout the vulcanizer be dry and circulate uniformly around the wire. After vulcanization the wire is sometimes protected from injury by a covering of braid. If waterproofing is desired, the braided wire is dipped in melted tar and paraffin.

11. BOOTS AND SHOES

Rubber boots and shoes are made up on lasts similar to those used for leather shoes. The sole stock is calendered to the proper thickness, during which operation the tread design is embossed upon it. The soles are stamped out by steel dies either by hand or in a stamping machine. The upper stock is made by calendering the fabric with a thin sheet of rubber. The calendered sheet is not rolled up like others because of its stickiness and the undesirability of having the impression of the cloth upon it. It is cut off in the required lengths as it comes from the calender and the pieces spread out on cloth-covered racks. The various parts of the shoes are cut from these according to pattern.

The inside includes inner soles, half soles, heel pieces, and instep pieces, which are covered by the upper and the sole. The last is painted with rubber solution and the linings of the uppers are stretched over it, the inside portions are laid on, the inner sole put in place, and the seams carefully rolled down. The half sole is put on and then the instep pieces, heel pieces, counter, the upper, and finally the soles.

The shoes are dipped in a varnish which generally consists of blown linseed oil, sulphur, turpentine, and gasoline. They are placed on racks and cured by dry heat in large chambers heated by steam coils. The time of cure is comparatively long.

12. RUBBERIZED FABRICS

In the manufacture of rubberized fabrics, the fabric is run slowly over a series of steam-heated coils to thoroughly dry it, after which it is kept in a drying room at a temperature of about 60° C (140° F) until it is to be spread or calendered. When the fabric is calendered no solvent is required, and the loss due to the evaporation is entirely avoided. Calendered fabric is more uniform and it can be made more quickly because no time is required for drying. Calendering, however, requires more skill than spreading.

A spreading machine consists of a horizontal roll supported on an iron frame. A long knife is so supported above the roll that it can be raised or lowered to obtain the desired thickness of rubber on the fabric. The rubber is mixed into a dough with a solvent, generally gasoline. A thin coating of rubber is spread on the fabric by placing the rubber dough in front of the knife as the fabric passes between the knife and the roll. The cloth now passes over

steam-heated pipes where the solvent is evaporated. The above operation is then repeated until the desired thickness of rubber is obtained.

Rubberized fabric can be vulcanized by either the cold or the heat cure. The cold cure is carried out by allowing the rubber to come in contact with a dilute solution of sulphur chloride in carbon bisulphide or carbon tetrachloride. After the cure some magnesium carbonate is dusted on to neutralize any acid that is formed. If the rubber compound contains reactive fillers, such as litharge, lime, magnesia, or zinc oxide, the cold cure must not be used. When a velvety finish is desired, the rubber is dusted with starch before it is vulcanized.

For the heat cure the fabric is dusted with starch or talc and is wound on a steel drum. A sheet of tin foil is sometimes placed between the layers of fabric in order to facilitate the distribution of heat and to insure uniform vulcanization. When the cure is to be carried out in a vulcanizer, the drum is inclosed in a waterproof bag to keep the fabric dry. When dry heat is used no covering is necessary. In some factories the fabric passes from the spreading machine through the heated chamber at such a rate that the rubber will be properly vulcanized. Calendering is carried out in the usual manner, and the rubberized fabric is cured as described above.

13. DRUGGISTS' SUNDRIES

Druggists' sundries comprise a great variety of rubber articles, a large part of which are dipped goods, which are manufactured as follows: The forms on racks are dipped into a solution of rubber in naphtha or benzene and dried, the operation being repeated until a film of the required thickness is obtained. They are cured by immersion in a solution of sulphur chloride or by exposure to its vapors. They are then removed, usually turned inside out, and the inner side cured.

Hot-water bottles, ice bags, water and air cushions are either molded or handmade. In the former case the article is vulcanized in a mold under hydraulic pressure. Handmade goods, in which rubberized fabric is sometimes used, are made up from parts cut according to pattern and vulcanized in open steam.

14. RUBBER BANDS AND THREAD

These goods are generally made from pure rubber, sulphur, and small amounts of fillers. Rubber bands are made either on a tubing machine or from calendered sheet. The calendered sheet is cut into widths, the edges of which are cemented together to form tubes. These are passed under a trip hammer which presses down the seam. The tubes are cured in open steam or under water. After vulcanization the tubes are cut, while wet, by revolving cutters. The bands are dried in hot air, inspected, and boxed.

The calendered sheet from which elastic thread is to be cut is wound with a liner upon a hollow iron drum and vulcanized under water. The rubber sheet is then unrolled, coated with thin shellac solution, and tightly rewound. The sheet is then cut into threads on a cutting lathe. The threads are then boiled with caustic-soda solution to remove the shellac and free sulphur, thoroughly washed, dried, and stored in the dark.

15. RUBBER SPONGE

Rubber from which sponge is made contains substances which volatilize during vulcanization. Ammonia and its salts are commonly used for this purpose. An interesting procedure is as follows: A mixture of amyl acetate, alcohol, and a little water is compounded with the rubber mixing. During vulcanization vapors are formed in bubbles throughout the mass. The rubber is then boiled in a dilute solution of caustic soda and at once run through rolls into boiling water. This process is repeated until the bubbles burst. The sponge is then washed and cut up.

V. TESTING OF RUBBER

For a number of years this Bureau has been investigating rubber products for various branches of the Government service. The purposes were to determine the character of the materials used, how they met the conditions of service, how they could be improved in quality, and finally to develop specifications for the purchase of goods of the desired properties without unnecessarily restricting competition. This investigation could not be made without suitable laboratory tests for measuring the qualities desired. Old tests were adopted or modified, new ones were devised, and apparatus was designed. The investigation also

required knowledge of industrial processes, which was gained by visits to manufacturing plants.

Physical tests measure the tensile strength, the permanent set after stretching, the strength of the adhesion of plies in built-up fabrics, and the various other physical properties which each specific material should possess.

Chemical analysis can not of itself furnish information on these points until physical tests and actual service have demonstrated what compounds are best adapted to particular needs. In many cases chemical analysis furnishes the only available information as to the nature and uniformity of composition of rubber goods.

Finished rubber products are not in a stable condition, but undergo change when exposed to heat, light, and air. It is therefore desirable to learn, if possible, what is the probable life of a given product in actual service or in storage. Various accelerated aging tests have been devised, but the results obtained by them should be used with caution. When satisfactory aging tests are devised they should be incorporated in specifications.

It was found that there were many different specifications for the same products. This state of affairs is unfortunate because it increases the cost without any material advantage. This Bureau is endeavoring to standardize specifications for rubber goods.

In the following pages the methods and apparatus for making physical tests are described in detail.

1. PHYSICAL TESTING OF RUBBER

Rubber testing in the present stage of its development is not susceptible of very great refinement as regards measurement. The nature of the material is such that refinement seems of less importance than uniformity of methods, which is absolutely essential where the work of different laboratories is to be compared. A more general interest in this matter would result in a substantial benefit not only to reputable manufacturers and large consumers, but also to the public.

(a) PHYSICAL TESTS MOST COMMONLY EMPLOYED

The different properties that have been found desirable in rubber intended for different purposes have naturally given rise to numerous tests, of which the most widely applicable are the various tension tests. These tests in various forms are used to determine the more important physical properties, such as ten-

sile strength, ultimate elongation, elasticity, and reduction in tension when held at a definite elongation.

In the case of such materials as pneumatic tires, rubber hose, and rubber belting, which are built up with layers of duck cemented or frictioned together with rubber, it is customary to determine the friction or adhesion between the plies of duck as well as the quality of rubber. It is also usual to subject hose (particularly fire hose and air hose) to a hydraulic-pressure test, in order to detect any imperfections in materials or workmanship.

An important test in the case of steam hose consists in passing steam at about 50 pounds pressure through a short length of the hose, in order to determine if the tube, cover, and friction are of suitable composition to withstand the effects of service conditions. This test usually lasts for about six days, the steam being turned off at night to allow the rubber to cool. A decided hardening or softening of the rubber, or a large decrease in the value of friction, as a result of steaming, is an indication of inferior quality.

No absolutely reliable test (other than an actual service test) has been devised for rubber steam packing, but in many cases valuable information may be obtained by clamping a piece of the packing between metal plates and subjecting it to the action of steam at a pressure equal to or slightly above that under which it is to be used. A more satisfactory method is to clamp the packing in the form of a gasket between pipe flanges and apply the desired steam pressure from within. The test should last several days, the steam being turned off at night to see if the joint has a tendency to leak as a result of the cooling effect. This, however, practically constitutes a service test.

The testing of tires, or rather the materials used in their construction, is done almost exclusively by manufacturers. Manifestly it would be too expensive for the individual consumer or small dealer to sacrifice whole tires for the purpose of securing test pieces. The more progressive manufacturers, however, realize that money expended in thorough and careful testing is more than justified by the increase in efficiency of their product.

The tests which have been outlined above aid considerably in determining the quality of rubber goods. The problem of finding properly accelerated aging tests merits further investigation.

One which has been used extensively consists in the application of dry heat.

(1) COMPARISON OF NORMAL AND ACCELERATED AGING.—The object of this work was to find an accelerated aging test which can be used to determine how a vulcanized rubber compound will age under normal conditions.

Twelve compounds were used. They were press-cured at $288^{\circ} \pm 1^{\circ}$ F. Each compound was represented by 42 sheets³ measuring 6 by 8 by $\frac{3}{32}$ inch. Fourteen of these sheets were undervulcanized, 14 overvulcanized, and 14 properly vulcanized according to the best judgment of the manufacturer. The composition of each compound and length of cure are given in Table 1.

TABLE 1.—Description of Test Samples of 12 Rubber Compounds

Degree of vulcanization	Vulcanization period at 288° F, in minutes, for samples Nos. G-1 to G-12											
	G-1	G-2	G-3	G-4	G-5	G-6	G-7	G-8	G-9	G-10	G-11	G-12
Undercure.....	15	30	30	70	5	5	15	20	10	15	15	15
Proper cure.....	20	40	45	90	10	15	20	30	15	20	20	20
Overcure.....	25	50	60	110	15	20	25	40	20	25	25	25
Ingredient	Composition in parts per thousand											
Fine Pará.....	450	250	450	250	300	100	100	200	200
Coarse Pará.....	200	200	100	100	100	150
Caucho ball.....
Red Congo.....	100	200	200
Reclaimed.....	150	350
Zinc oxide.....	200	200	200	200	200	200	200	200	200	200	200	100
Barytes.....	215	215	175	175	200	160	200	200	200	200	300
Litharge.....	100	100	100	100	100	100	100	100	50
Whiting.....	375	175	150	175	285	285	235
Lime.....	40	40	50	20
Sub. white lead.....	100	100
Petroleum jelly.....	20
Sulphur.....	35	35	35	35	25	25	20	25	15	15	15	30
Litharge and red lead.....	100

The tensile strength and ultimate elongation were determined at different periods: (1) After the samples had been normally aged by storing in a well-ventilated dark cabinet, at a temperature of approximately 75° F, and (2) after being subjected to the effect of dry heat at a temperature of 160° F. The results obtained are plotted in Figs. 6 to 17, inclusive.

³ These compounds were obtained through the courtesy of Dr. W. C. Geer, connected with a commercial rubber company.

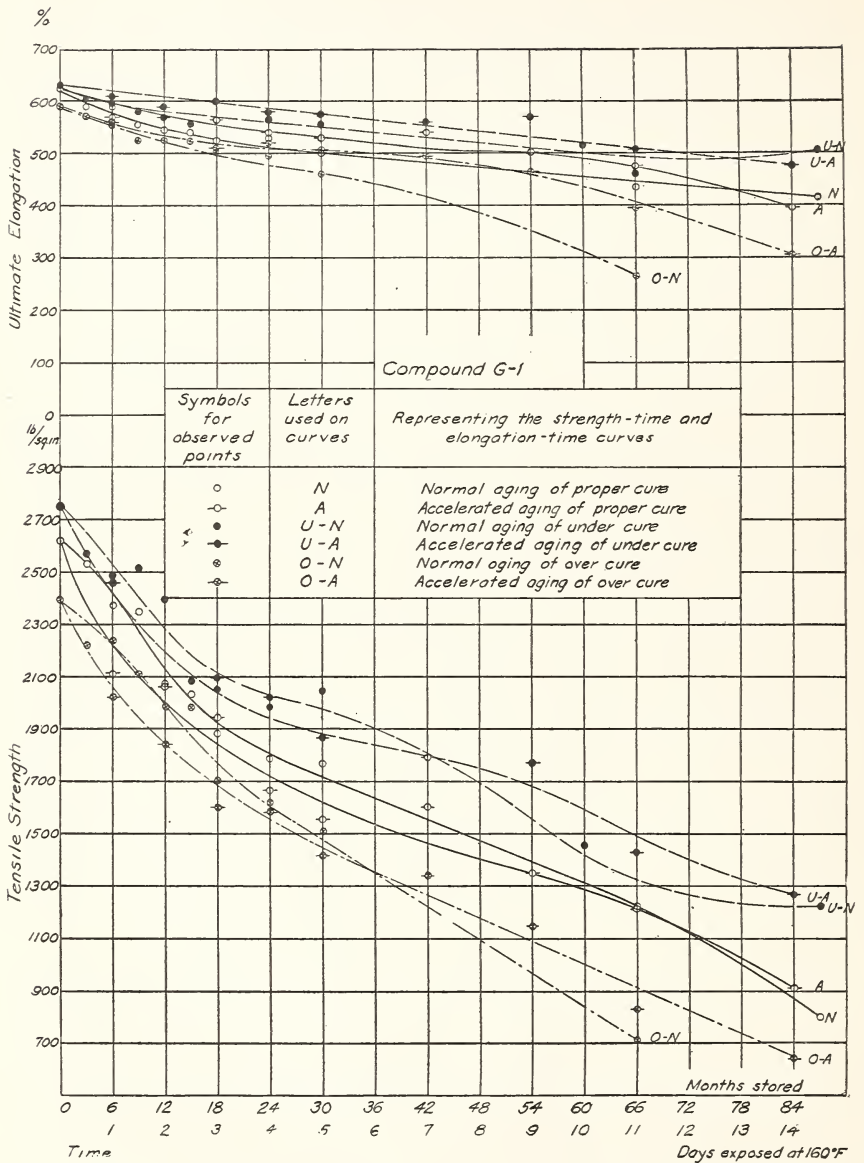

FIG. 6.—Tensile curves for compound G-1. This and the following figures contain curves for the various compounds G-1 to G-12

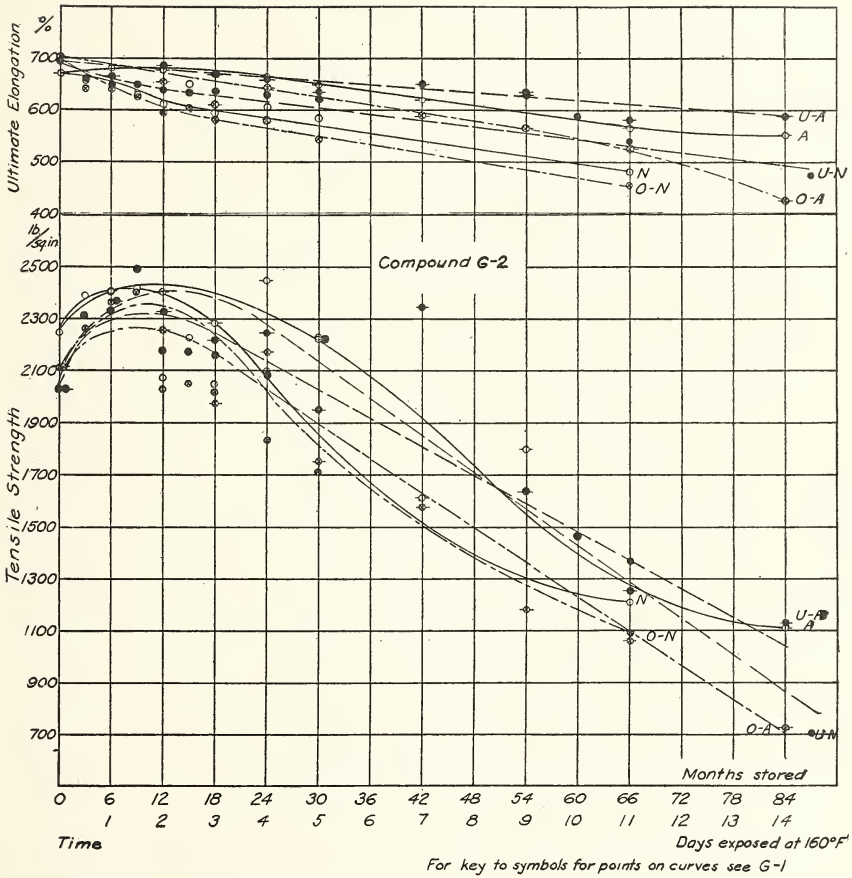

FIG. 7.—Tensile curves for compound G-2

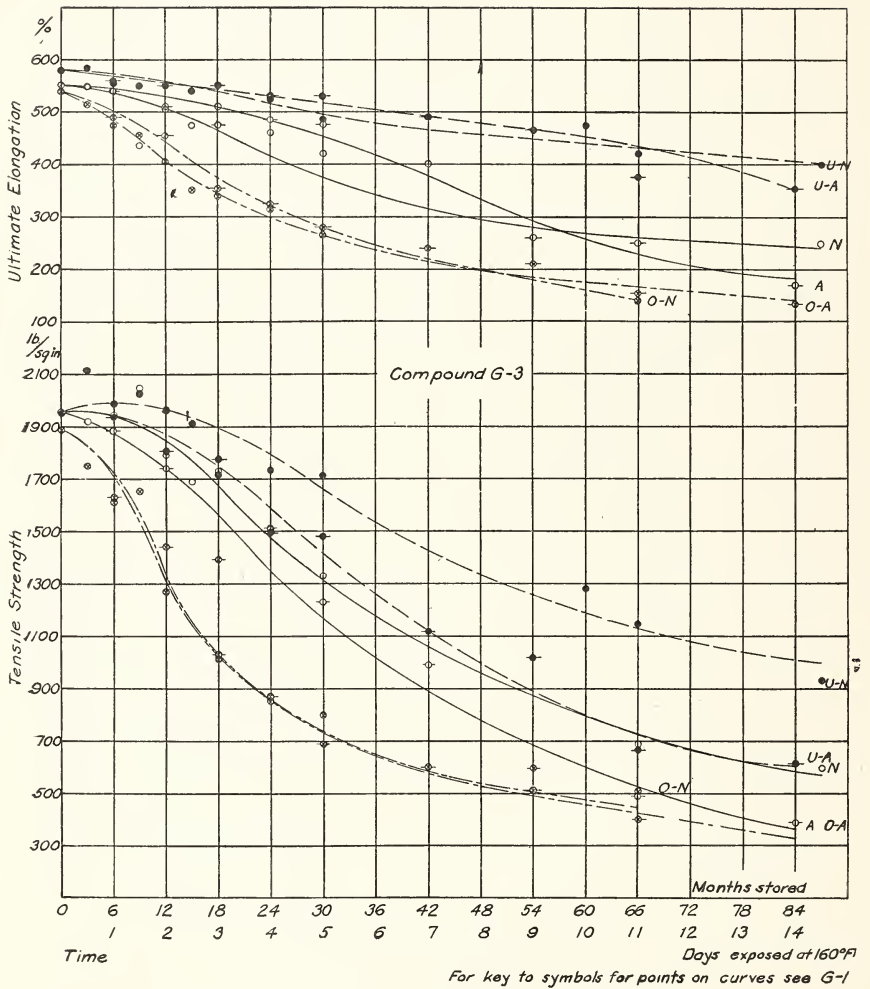

FIG. 8.—Tensile curves for compound G-3

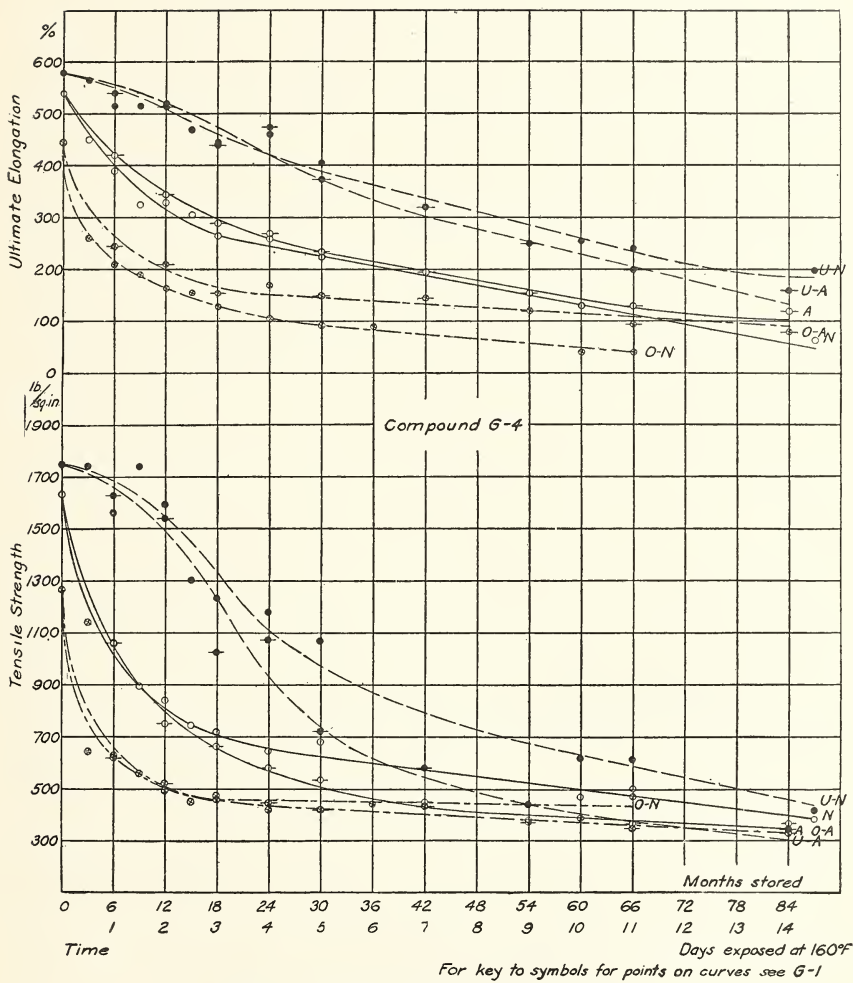

FIG. 9.—Tensile curves for compound G-4

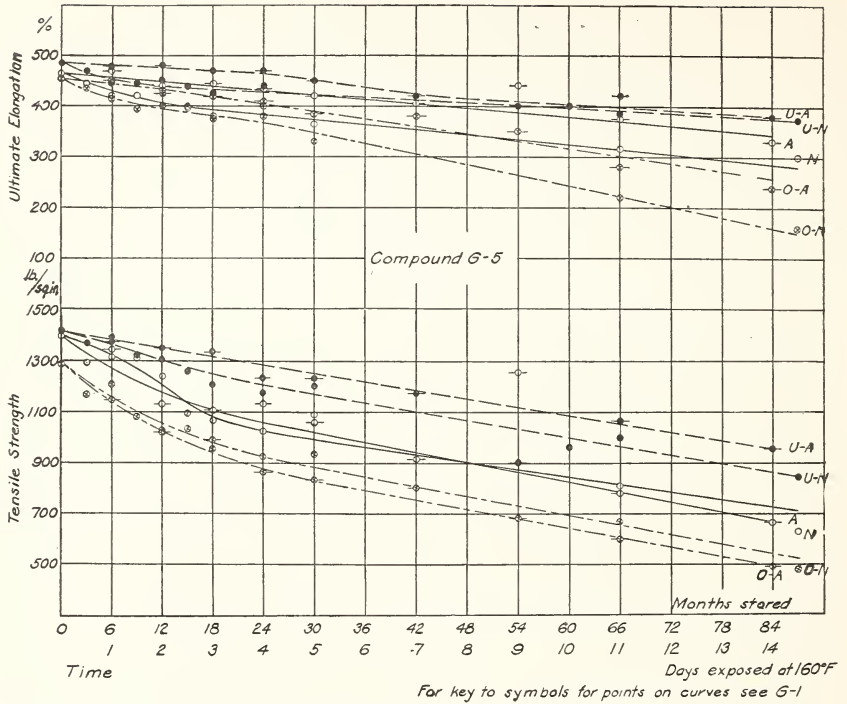

FIG. 10.—Tensile curves for compound G-5

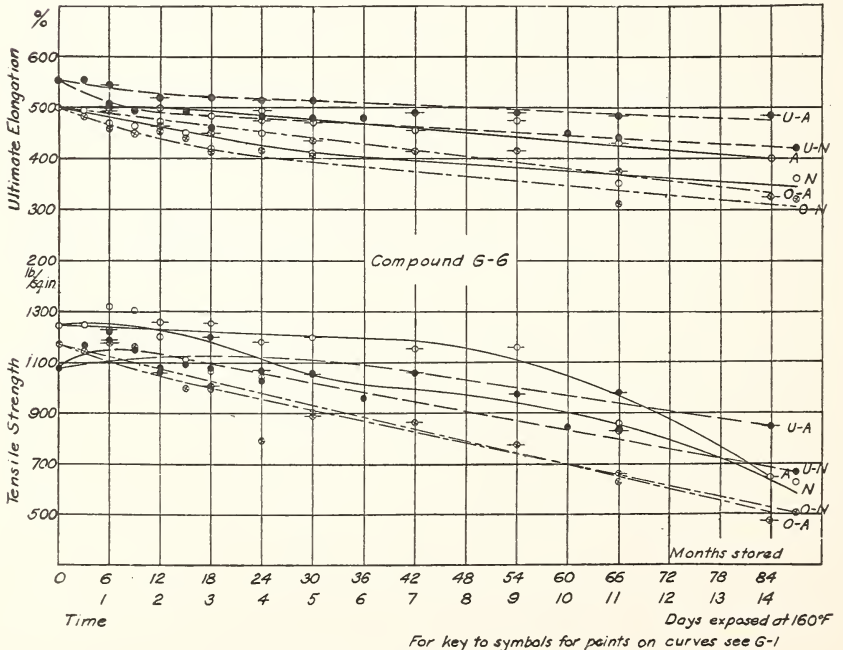

FIG. 11.—Tensile curves for compound G-6

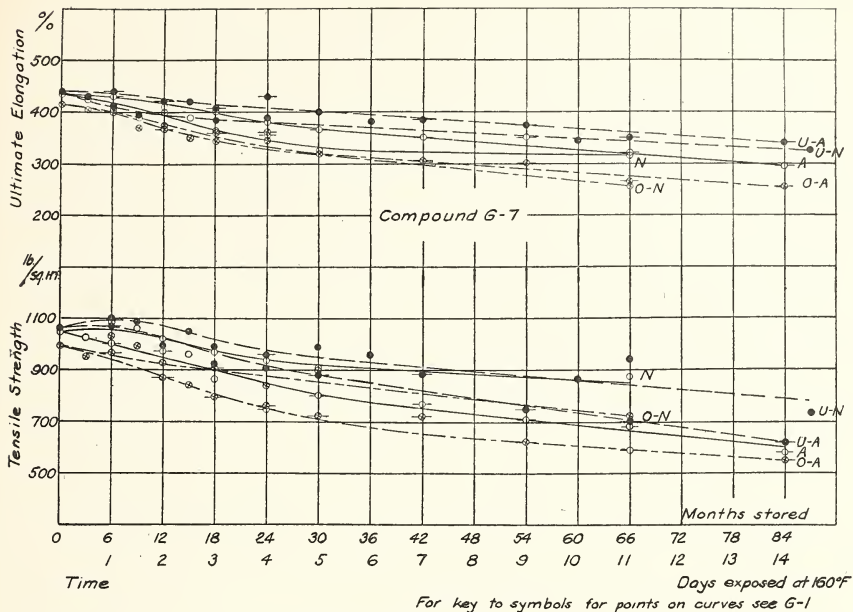

FIG. 12.—Tensile curves for compound G-7

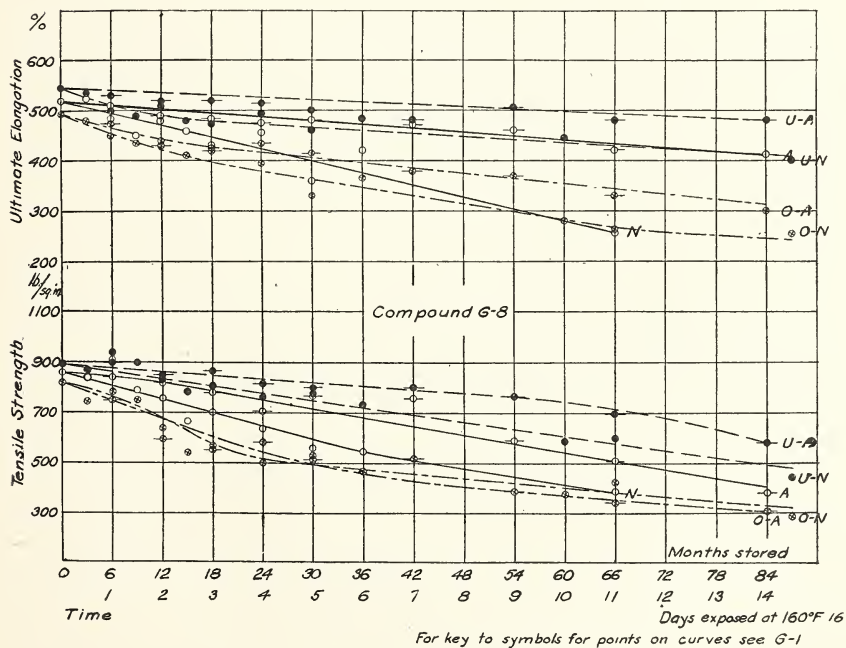

FIG. 13.—Tensile curves for compound G-8

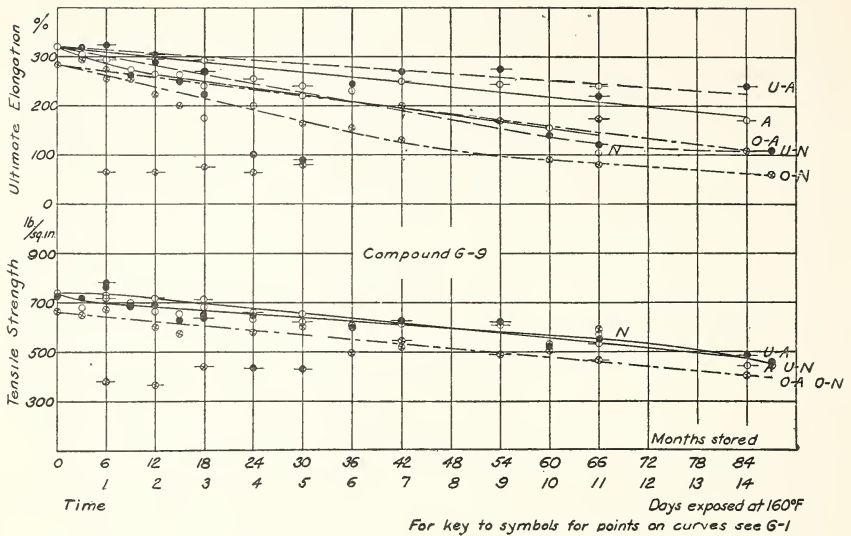

FIG. 14.—Tensile curves for compound G-9

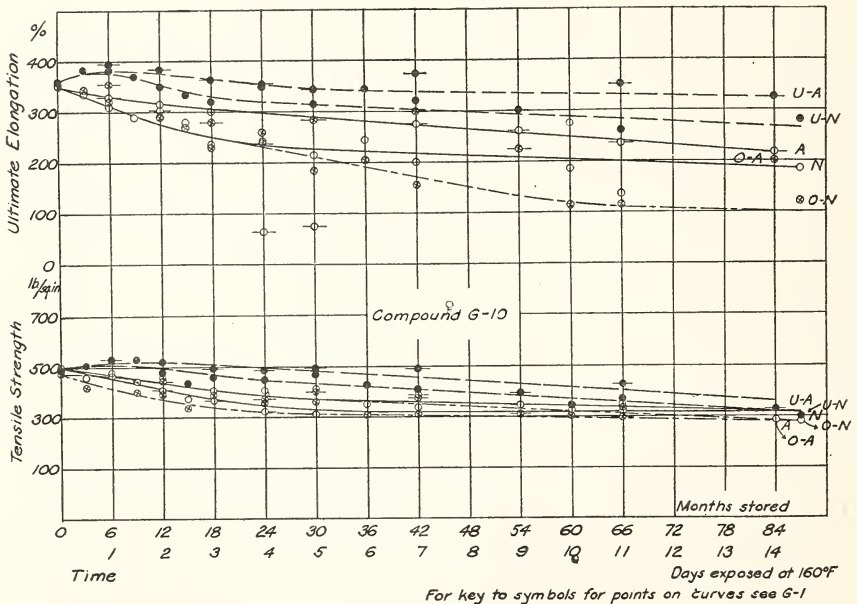

FIG. 15.—Tensile curves for compound G-10

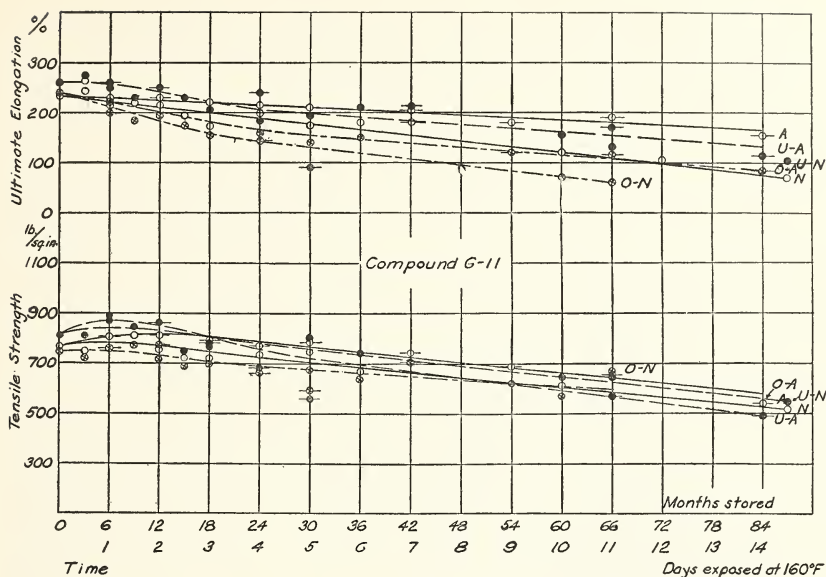

FIG. 16.—Tensile curves for compound G-II

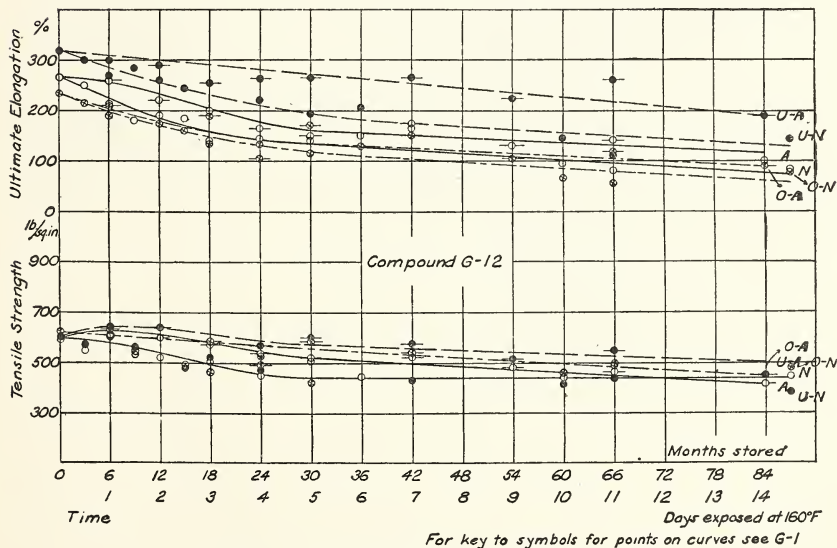

FIG. 17.—Tensile curves for compound G-12

From a study of these curves it may be concluded that—

1. An apparent relationship exists between samples that have been aged normally and those that have been subjected to the action of dry heat at a temperature of 160° F. Our experiments seem to show that subjecting a sample to dry heat at 160° F for one day is equivalent to six months' normal aging.

2. In all cases the relatively undervulcanized samples showed less deterioration and the relatively overvulcanized samples more deterioration than those which were properly vulcanized.

A more complete series of rubber compounds should be subjected to the same tests in order to confirm these results.

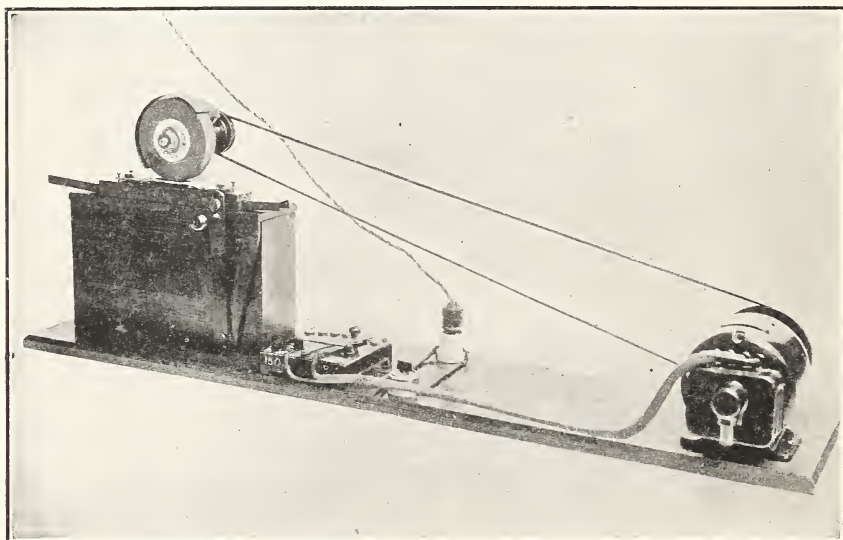

FIG. 18.—Emery wheel for grinding the surface of rubber test pieces to produce a smooth surface

(2) TENSILE STRENGTH AND ULTIMATE ELONGATION—(a) *Separating Rubber from Fabric*.—When the material is made up with layers of fabric, as in the case of rubber hose, the first step in preparing specimens for the tension test is to separate the rubber from the fabric. Unless the frictioning is very poor, this will necessitate the use of a solvent. If there is more than one layer of fabric, the easiest way is to remove the first layer along with the rubber. The rubber is then separated from the adjoining layer of fabric with the aid of gasoline blown from a wash bottle. Narrow strips are more easily handled than larger pieces and there is less danger of injuring the rubber. Great pains should be taken during this operation, because any flaw or local imperfection will

seriously vitiate the results. The rubber should be allowed to rest for several hours, in order that it may recover from the stretching it has received and that the gasoline may thoroughly evaporate.

(b) *Emery Wheel for Grinding the Surface of Rubber.*—The strips thus removed retain the impressions of the fabric from which they have been separated, and it is necessary to grind the surface smooth in order to measure accurately the thickness of the test pieces. The emery wheel shown in Fig. 18 was designed at this Bureau to accomplish this purpose, and has proven a very convenient and satisfactory arrangement. The wheel is operated by a one-eighth horsepower motor. The rubber to be buffed is clamped, as shown, to a carriage which is moved back and forth under the 5 by 1¼ inch emery wheel (No. 40), running at about 3000 revolutions per minute. The central portion of the carriage just under the rubber is slightly raised, by which means it has been found that the operation is more easily performed and with less danger of injury to the rubber. An adjusting thumbscrew serves to lower the wheel by very small amounts as the buffing proceeds. Shields are provided to keep the fine particles of rubber off the guide. The starting box, though not necessary, is desirable in bringing the wheel gradually up to full speed. The face of the wheel should be dressed at intervals as may be required to maintain a good abrasive surface.

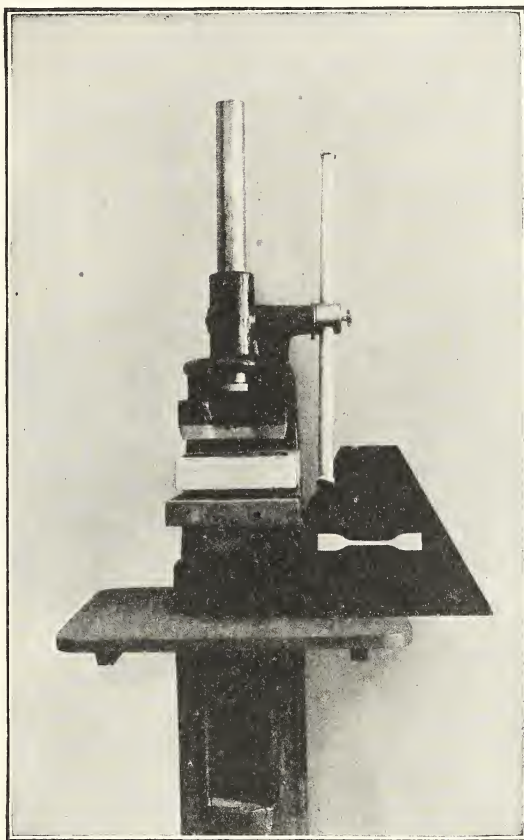

FIG. 19.—Arbor press and die for cutting rubber test pieces for determining the tensile properties

(c) *Form and Preparation of Test Pieces.*—Test pieces are cut with a metal die, which not only saves much time, but also insures uniform width, which it is impossible to obtain if the specimens are cut by hand. An arbor press, Fig. 19, is perhaps the most convenient and satisfactory means of forcing the die through the rubber, although many prefer to cut the test pieces by striking the die with a mallet. The operation is facilitated by wetting the

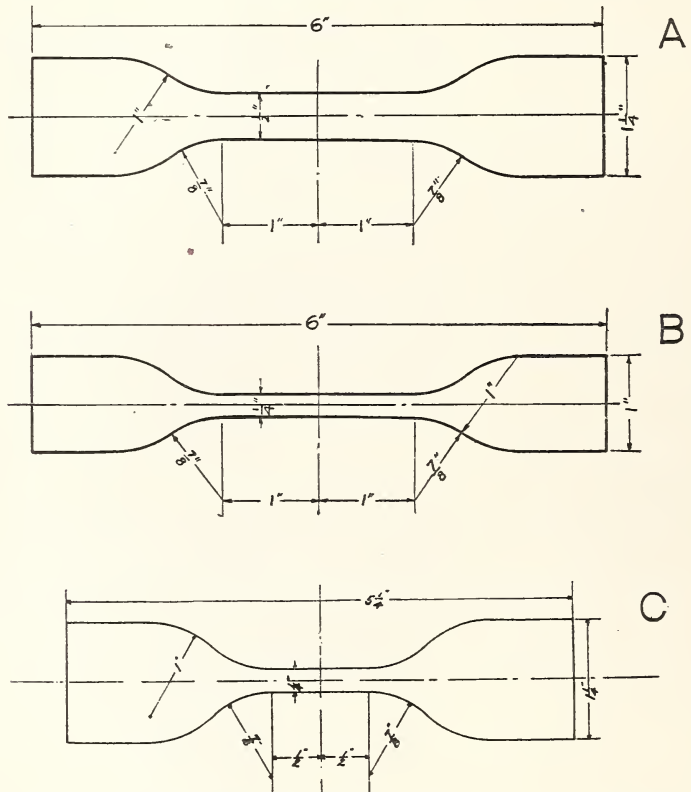

FIG. 20.—One-fourth and one-half inch test pieces with enlarged ends

cutting edges of the die, and the rubber should rest on a smooth and slightly yielding surface which will not injure the cutting edges. A piece of leather is suitable for the purpose. The central portion of the test piece is straight, and the ends are gradually enlarged to prevent tearing in the grips of the testing machine. The width of the contracted section is usually made either one-fourth or one-half inch. Fig. 20 gives the dimensions of test pieces which have been found to give satisfactory results. Fig. 21 shows the various dies used at this Bureau. The one-fourth

inch test piece is to be preferred for general use, for the reason that there is a less tendency for the rubber to tear in the grips or across the shoulder where the cross section changes.

Parallel lines are placed on the specimens, and by means of these gage marks elongation and permanent extension are measured. A stamp consisting of parallel steel blades enables one to mark very fine lines with ink, without cutting the rubber, and in this way much time is saved and the chance of error very much reduced.

In testing pure gum or compounds containing a large percentage of rubber, it is not practicable with a machine of convenient length to break test pieces having a gage length of 2 inches. In such cases shorter test pieces one-fourth inch wide over a gage length of 1 inch and $1\frac{1}{4}$ inches wide at the ends are used. Test pieces in the form of a ring will be referred to later on page 66.

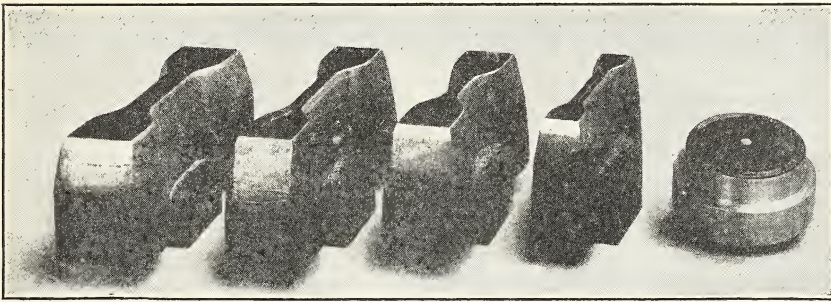

FIG. 21.—Shapes of dies used for cutting test pieces

(d) *Measuring the Thickness of Rubber.*—A special form of micrometer caliper (Fig. 22, A) provided with enlarged contact surfaces and a ratchet stop is used to some extent for measuring the thickness of rubber and textile materials. The ratchet stop makes it possible to measure each specimen under the same pressure and thus adds to the uniformity of results. A spring micrometer (Fig. 22, B) is more generally employed for this purpose. It is exceedingly convenient and very easily read.

(e) *Grips for Holding Test Pieces.*—In testing rubber one of the greatest difficulties has been to grip the test piece in such a way as to prevent slipping, without at the same time injuring the rubber. Even a very small scratch on the surface of a rubber test piece is often sufficient to cause failure at that point.

In order to prevent slipping of the test piece as its section is gradually reduced under increasing tension, it has been found

advisable to provide means for automatically tightening the grip. This may be conveniently accomplished by using a number of thin cylindrical disks, with knurled faces, mounted eccentrically

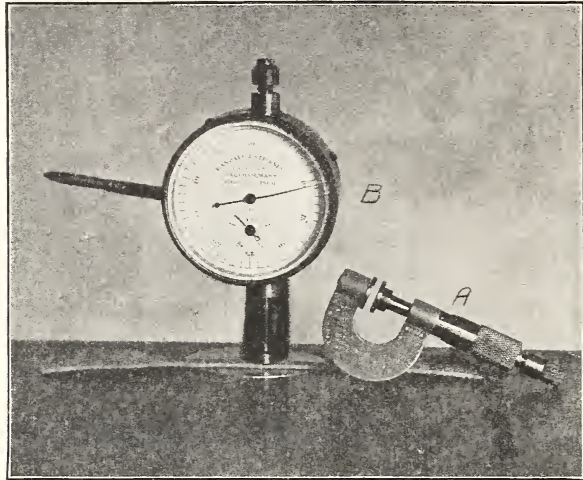

FIG. 22.—Instruments for measuring the thickness of rubber. A, micrometer; B, spring micrometer

on a pin (Fig. 23, A), which act independently, thus producing a uniform pressure over the gripping surface and preventing any uneven slipping.

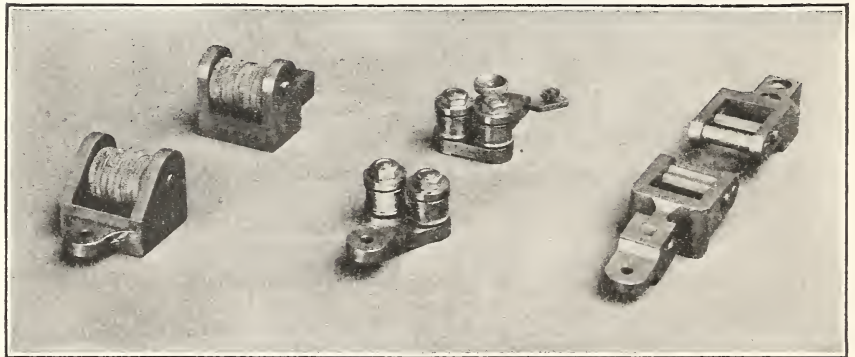

FIG. 23.—Grips used in making tensile tests of rubber. A, Eccentric disks which tighten automatically as the tension increases; B, spools with ball bearings for testing ring-shaped specimens

When it is desired to test specimens of circular form, as in the case of rubber bands, jar rings, or washers, grips of the design shown in Fig. 23, B, may be used. Each grip consists of two rollers

mounted on ball bearings. The action of these rollers is such that as tension is applied they rotate in opposite directions, thus tending to equalize the stress around the circumference of the test piece.

(f) *Testing Machines.*—(The machine shown in Figs. 11, 12, and 13 is used for determining the tensile strength and ultimate elongation.) The dynamometer 1 (Fig. 24), having a capacity of 125 pounds and graduated to one-fourth pound, is attached to the upper end of column 2, which is slotted to receive the rack 3, carrying the eccentric grip 4 at its upper end. The machine is operated by a one-twelfth horsepower motor, which is belted to the stepped pulley 5. A worm on the pulley shaft drives a worm wheel which is geared to a spur (not shown) inside of column 2. The eccentric grip 4 (Fig. 25) is attached to the dynamometer through pin connections 7 and 8. The plate 9 serves to prevent recoil of the springs when a specimen is broken, and acts in the following manner: The rod 10, which is rigidly attached to column 2, passes with very little clearance through a hole in the back of plate 9. The front of plate 9 is slotted to receive the rod 11, and is supported by the shoulder 12. As tension is applied to the specimen, plate 9 is free to follow the shoulder 12, and passes down over the rod 10, but when the specimen breaks

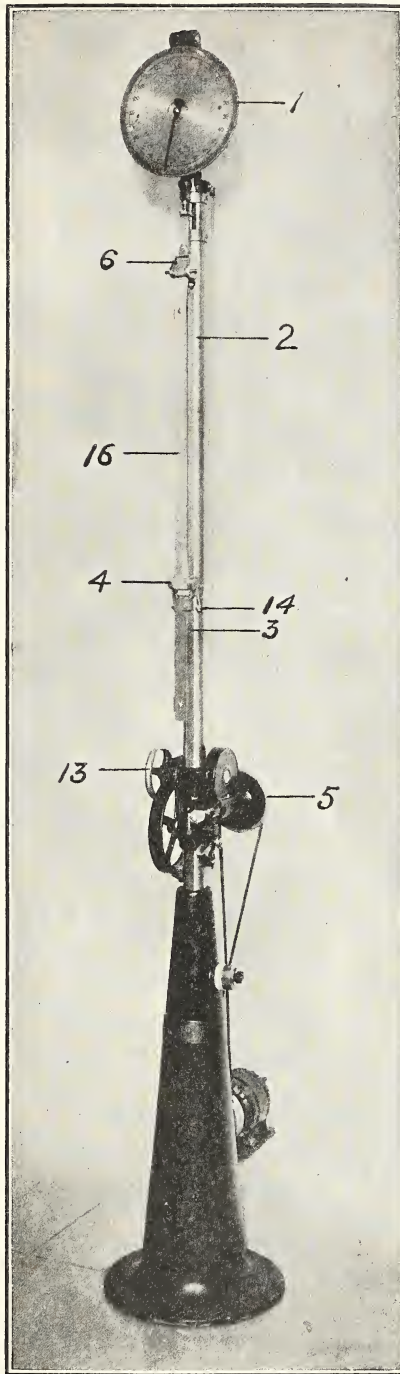

FIG. 24.—Motor-driven machine for testing the tensile strength of rubber. See Figs. 25 and 26 for details

the upward pressure of the shoulder 12 causes the plate to bind on the rod 10, thus holding the springs under the maximum tension. The dynamometer is so constructed that the pointer remains at the maximum load when a specimen breaks.

The load having been recorded, the upper grip is pulled downward (by means of the hand wheel 13 and hooks 14, if necessary, Fig. 24) to relieve the pressure of the shoulder 12 against plate 9, and at the same time the rear end of the plate is raised to release the rod 10. The tension of the springs may now be relieved by allowing the grip to rise, and the pointer is returned to zero.

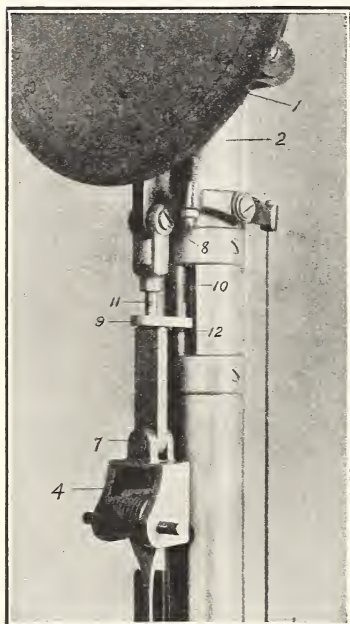

FIG. 25.—Detail of upper portion of machine shown in Fig. 24, illustrating method of attaching grip and device for preventing recoil of spring

At the end of a test the worm and gear are disengaged by means of the spring clutch 15 (Fig. 26), and the rack is rapidly raised by hand to its initial position.

The stepped pulleys provide for different speeds to meet the requirements of experimental work.

Elongation between gage marks on the specimen may be measured on the scale 16, attached to column 2, but to do this requires the services of two operators. A simpler and equally accurate method is as follows: A wooden scale graduated to one-

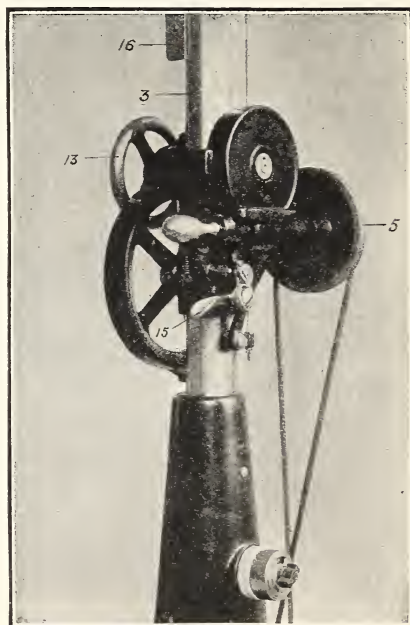

FIG. 26.—Detail of lower portion of machine shown in Fig. 24, illustrating stepped pulley, gear drive, and releasing mechanism

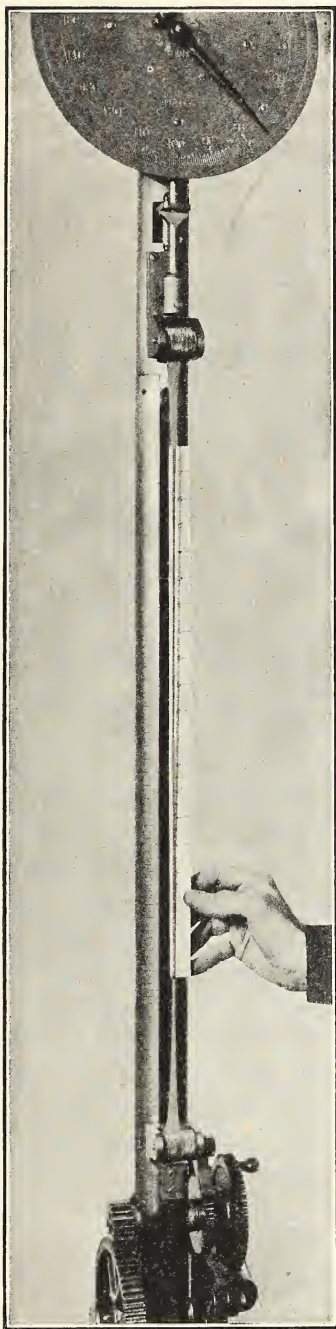

FIG. 27.—Illustrating method of measuring ultimate elongation

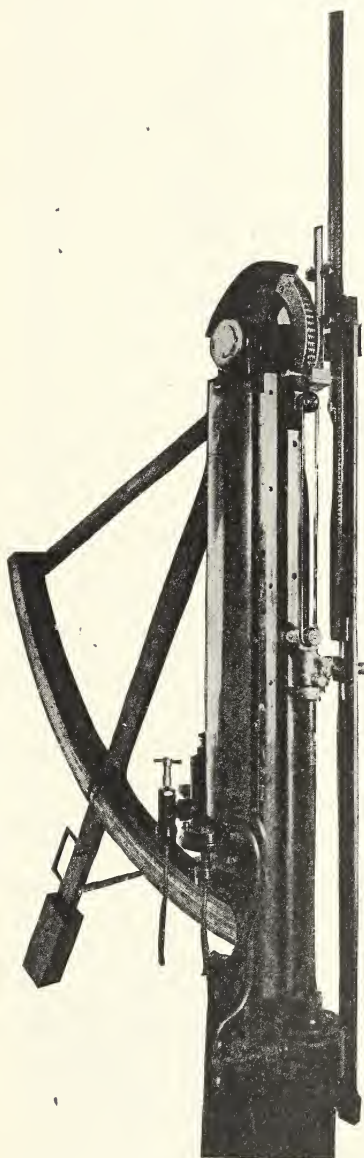

FIG. 28.—“Schopper” machine for testing the tensile strength of rubber

This machine operates on the principle of a weighted lever

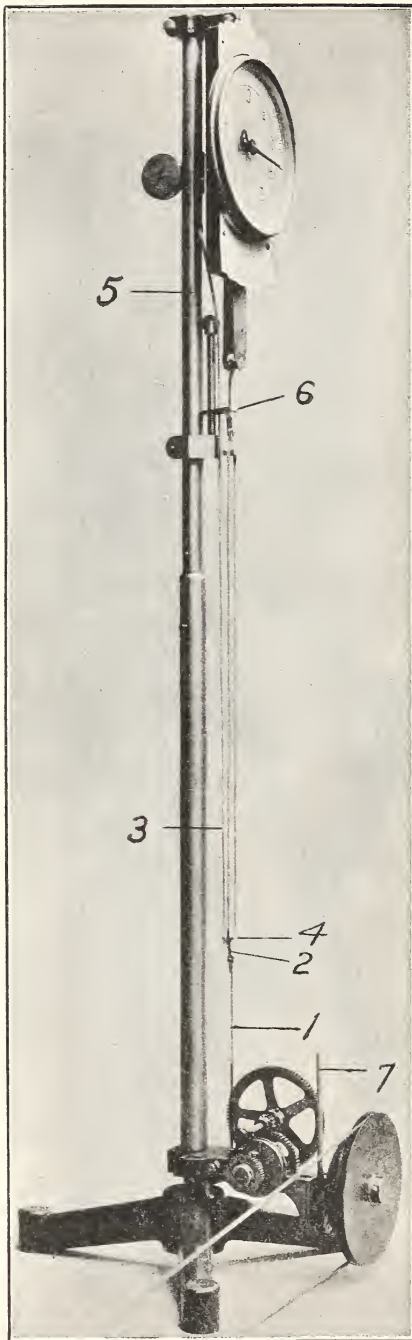

FIG. 29.—Motor-driven machine for testing rubber bands

This machine operates on the same principle as the one illustrated in Fig. 24

tenth inch, as shown in Fig. 27, is held in a slightly inclined position at the back of the test piece with its lower end pressed lightly against the rubber just back of the lower gage mark. As the rubber is stretched the eye follows the scale just back of the upper gage mark. With a little practice the elongation at break may be measured with a fair degree of accuracy.

The Schopper machine illustrated in Fig. 28 is worked by hydraulic power, its operation, briefly stated, being as follows: The rubber test ring is placed over the spools, and the lower spool is geared to the rack in such a way that it is caused to revolve during a test. This motion is transmitted to the top spool by the rubber test ring, the object of rotating the spools being to equalize the tension at all parts of the specimen. As the tension is increased, the weighted lever, to the short arm of which the top spool is attached, is gradually deflected. When the test ring is broken, the lever is held at the point of maximum load by means of a set of pawls, the breaking load being read from the curved scale and the elongation being indicated by the vertical scale just opposite the test ring.

Fig. 29 shows a motor-driven machine of 15 pounds capacity which was designed for testing rubber bands. The load is ap-

plied through the steel tape 1, at the end of which is the grip 2, carrying spools 4, similar to those shown in Fig. 23, B. The graduated steel tape 3, attached to grip 2, with its zero point coinciding with the center of the spools 4, passes up behind the test specimen and through the column 5 to a reel just behind the spring balance. When the specimen breaks its elongation is determined by the distance between the centers of the spools, as shown by the tape 3. The plate 6 holds the springs under the maximum tension in a way already explained in connection with Fig. 25. Stepped pulleys provide for different speeds. When a specimen has been broken, the worm and gear are disengaged by means of the lever 7, and the bottom spools are raised by hand to their initial position. This machine is also provided with eccentric grips which are used for testing straight specimens of low tensile strength.

(3) ELASTICITY OR "SET."—"Set" or "recovery" as applied to rubber is, in a way, synonymous with elasticity, and is measured by the extent to which the material fails to return to its original length after having been stretched. The set, together with the ultimate elongation and tensile strength, determines whether the compound has been properly vulcanized. For a given compound high set indicates undercure, whereas a low set indicates overcure.

For example, if a test piece is stretched from 2 to 10 inches for 10 minutes and then released, and if its length measured after 10 minutes' rest is 2.4 inches, the "set" under these conditions is 0.4 inch, or 20 per cent.

(a) *Machine for Testing Elasticity or "Set."*—For merely stretching rubber to determine its elasticity or recovery after a definite elongation, without reference to the tension applied, the apparatus shown in Fig. 30 is used, in which six specimens may be tested at once. The spools 1 are free to slide on the shaft 2, and are slotted to engage pins 3 (not shown), which act as clutches. The movable grips are attached to three-fourth inch strips of leather-belt lacing which pass through clamps 4 and then to the spools 1. The action of these clamps is similar to that of an ordinary letterpress, and, with a one-half by three-fourth inch bearing plate, a moderate twist of the knurled head is sufficient to prevent any slip of the belt lacing when under tension. The operation of the apparatus is as follows:

Six specimens being in the grips, one of the spools is moved along the shaft until it engages the corresponding pin, and the

shaft is revolved until the desired elongation measured between gage marks on the specimen is secured. The clamp is tightened to hold the specimen in this position, and the spool is shifted back so as to disengage the pin. The operation is repeated with each of the specimens in turn. Each specimen is released after a specified length of time (usually 1 or 10 minutes) and after an equal interval of rest the permanent extension or set is measured with a scale graduated to 0.01 inch.

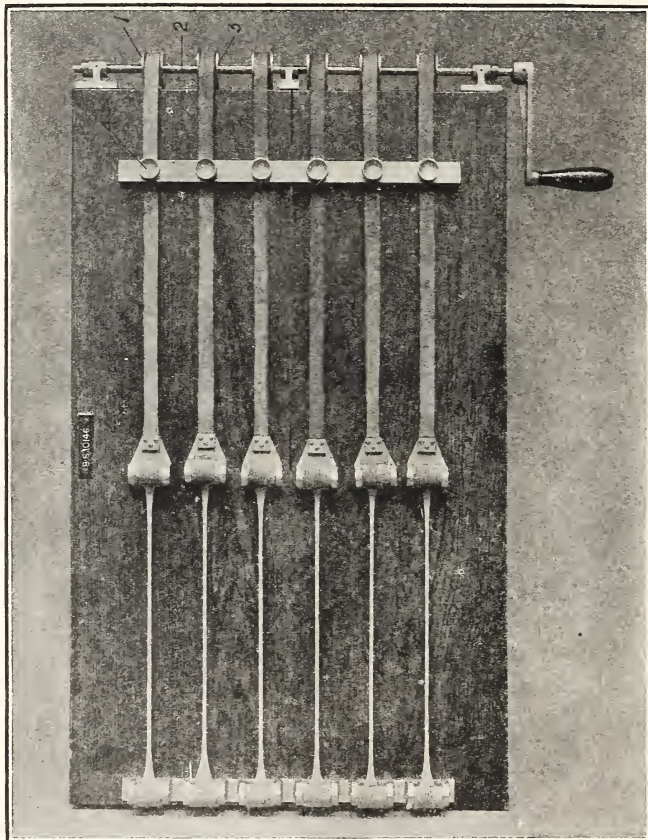

FIG. 30.—Apparatus for stretching rubber to determine its elasticity

(4) REDUCTION IN TENSION WHEN RUBBER IS HELD AT A DEFINITE ELONGATION.—When rubber is stretched in a testing machine the extension gradually increases with the applied tension, as is the case with other materials, but if the machine is stopped at any point so that the test piece is held fixed under a constant elongation, the tension in the test piece will gradually decrease.

The determination of this decrease in tension under specified conditions constitutes a test which is thought to be indicative of the quality of rubber and the extent of vulcanization.

(a) *Machine for Testing Reduction in Tension.*—The apparatus shown in Fig. 31, which has a capacity of four test pieces, is used in conducting this test. The spring balances are provided with live and dead pointers, which show the maximum tension as well as the tension at any time during the test. The balances have a

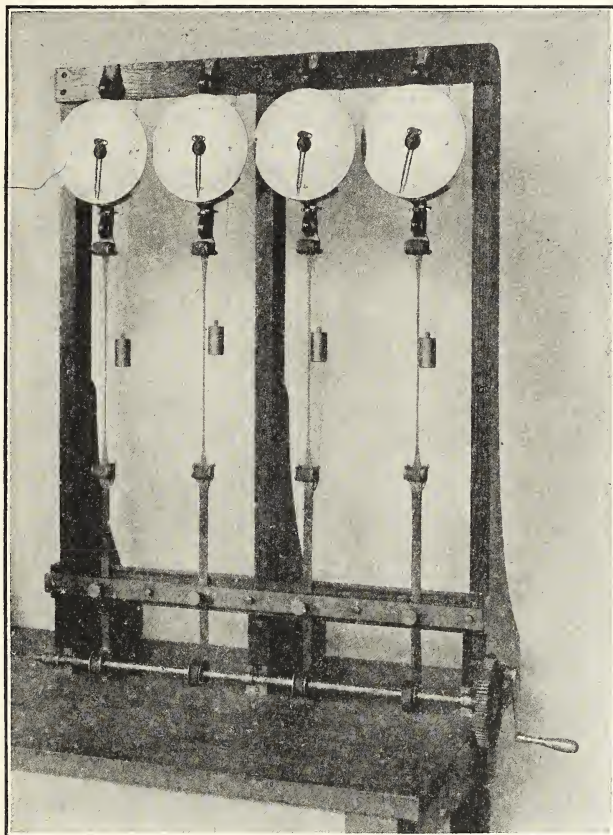

FIG. 31.—Apparatus for determining the reduction in tension when rubber is stretched and held at a definite elongation

capacity of 50 pounds, with 8-inch dials graduated to 0.2 pound. The lower grips are counterbalanced by weights, which are suspended from cords passing over pulleys just back of the spring balances. In this way each grip is held in an accessible position and is prevented from falling should the specimen break.

(5) CONDITIONS AFFECTING THE RESULTS OF TENSION TESTS.—In the absence of uniform methods of testing, it is found that results obtained in different laboratories sometimes show marked discrepancies which are due to the varying conditions under which the tests are made.

(a) *Influence of Speed on Tensile Strength and Ultimate Elongation.*—The speed at which rubber is stretched probably affects the results to a less extent than is often supposed, though doubtless different rubbers are not equally affected.

Table 2 shows the results obtained in a comparative test of four compounds.

TABLE 2.—Tensile Strength and Ultimate Elongation as Affected by Rate of Stretching.

[Gage length=2 inches]

Specimen	Rate of stretch	Tensile strength	Ultimate elongation
		Lb./in. ²	Per cent
G-18.....	5	2495	605
	25	2690	635
	45	2720	635
M-1.....	5	1900	465
	25	1940	500
	45	1970	490
B-1.....	5	375	340
	25	430	350
	45	465	375
Gy-1.....	5	340	105
	25	390	115
	45	430	120

These results would indicate a general tendency toward higher values for both tensile strength and ultimate elongation as the speed of stretching increases.

(b) *Influence of Temperature on Strength, Elongation, and "Recovery."*—It is generally recognized that the physical properties of rubber are affected by changes in temperature, though, of course, to a less extent after vulcanization than before.

Fig. 32 shows the results of tests at 50, 70, and 90° F. In each case the room was maintained at the specified temperature for three hours before the tests were made. It will be noticed that the rubbers are not all affected to the same extent by equal differences in temperature, but there is a marked tendency in each case toward decreased strength, decreased set (increased elasticity), and increased elongation as the temperature is raised.

It will be noted further that in nearly every case greater differences occur between 50 and 70° than between 70 and 90°.

The set in each case was measured after one-minute stretch and one-minute rest. Nos. 1 and 2 were stretched 350 per cent, Nos. 3 and 4, 300 per cent, and No. 6, 250 per cent.

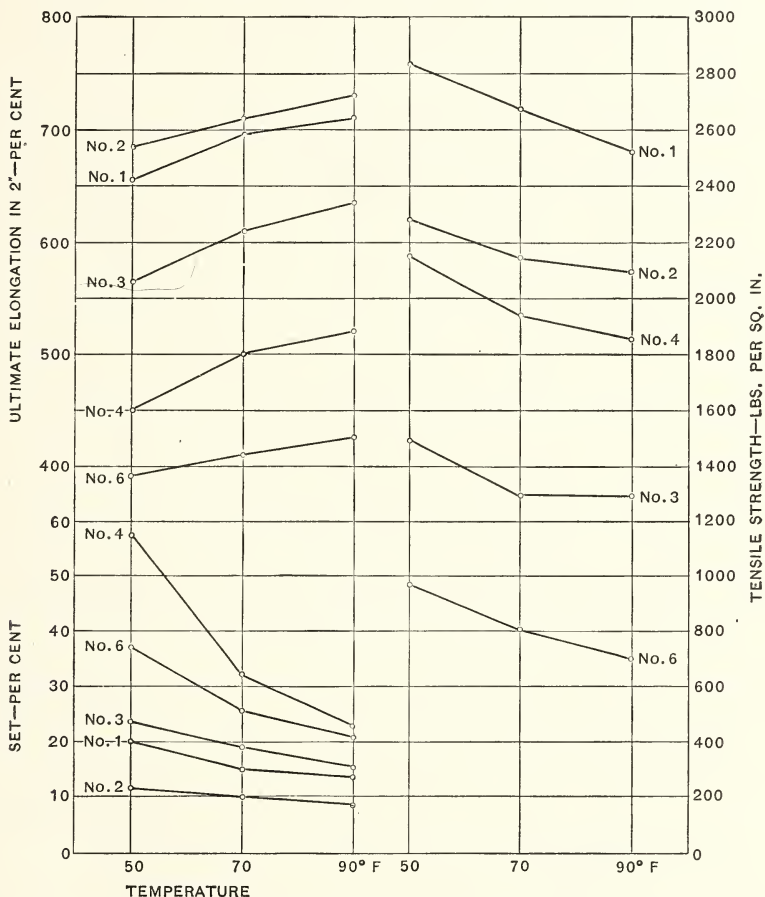

FIG. 32.—Curve showing influence of temperature on the elasticity, tensile strength, and ultimate elongation of rubber

(c) Influence of Cross Section on Tensile Strength and Ultimate Elongation.—Tensile strength and ultimate elongation are theoretically independent of sectional area, but, as in other materials, there is a tendency for small test pieces to develop higher unit values than large ones. Complete data on this subject are not at hand, but it is thought that test pieces one-fourth and one-half inch wide will show, in general, but little difference in ultimate

elongation, but an appreciable difference in tensile strength, in the case of high-grade compounds.

Comparative results obtained with test pieces one-fourth and one-half inch wide are shown in Table 3. These rubbers represent commercial compounds. The test pieces were cut from the tubes and covers of plied hose, and the impression left by the fabric was carefully removed with the emery wheel shown in Fig. 18.

TABLE 3.—Influence of Cross Section upon the Tensile Strength and Ultimate Elongation of Rubber

Specimen	Width of specimen	Tensile strength	Ultimate elongation
	Inch	Lb. in. ²	Per cent
M-4 cover.....	$\frac{1}{4}$	1565	525
	$\frac{1}{2}$	1455	515
M-3 tube.....	$\frac{1}{4}$	2160	580
	$\frac{1}{2}$	1955	570
G-19 tube.....	$\frac{1}{4}$	1025	350
	$\frac{1}{2}$	955	340
G-19 cover.....	$\frac{1}{4}$	735	255
	$\frac{1}{2}$	690	250
M-5 tube.....	$\frac{1}{4}$	2490	615
	$\frac{1}{2}$	2060	575

TABLE 4.—Influence of Direction in which Specimens Are Cut on Tensile Properties

Sample No.	Direction	Tensile strength ^a	Ultimate elongation	Set ^a after 300 per cent for 1 minute with 1 minute rest
		Lb. in. ²	Per cent	Per cent
1.....	Longitudinal.....	2730	630	11.2
	Transverse.....	2575	640	7.3
2.....	Longitudinal.....	2070	640	6.0
	Transverse.....	2030	670	5.0
3.....	Longitudinal.....	1200	480	22.1
	Transverse.....	1260	555	16.3
4.....	Longitudinal.....	1850	410	34.0
	Transverse.....	1700	460	24.0
5.....	Longitudinal.....	690	320
	Transverse.....	510	280
6.....	Longitudinal.....	880	315 320	34.3
	Transverse.....	690	315 320	25.9

^a The set and tensile strength were determined with different test pieces.

(d) *Influence of the Direction in which Specimens are Cut on Strength, Elongation, and "Recovery."*—The tensile properties of

sheet rubber are not the same in all directions, as will be shown later in connection with comparative tests of straight and ring-shaped test pieces. There is a tendency for specimens cut longitudinally, or in the direction in which the rubber has been rolled through the calender, to show greater strength and (at least for the better grades of rubber) less elongation than specimens cut transversely or across the sheet. The recovery, however, is greater in the transverse direction. Table 4 illustrates this.

No. 3 shows slightly greater strength transversely and No. 5 greater elongation longitudinally, while No. 6 shows the same elongation in each direction. The exception noted in No. 3 is attributed to experimental errors or to small defects in the specimens which escaped detection. It may be, however, that low-grade rubbers, such as Nos. 5 and 6, are not more extensible transversely than longitudinally. Further tests are necessary to determine this point.

(e) *Influence of "Backing" on the Tensile Strength and "Recovery" of Hose Lining.*—In the case of cotton rubber-lined hose the "backing" which is used to cement the lining to the fabric, if not removed, affects to a greater or less extent the values obtained for tensile strength and "set" or "recovery."

If the backing has an ultimate elongation greater than that of the lining, it must necessarily increase the tensile strength which is figured from the breaking load and the measured cross section of the rubber lining. The observed value for "set" which is obtained as described on p. 57, is greater or less than the true value, according as the lining is more or less elastic than the backing. If the elasticity of the backing differs very much from that of the lining, it will be found that the broken test pieces have a tendency to curl up like a watch spring, with the backing on the inside or outside according as its elasticity is greater or less than that of the lining. It is customary to test hose linings with the backing removed.

In Table 5 are recorded the results of tests that were made to determine the effect of backing on the tensile properties of hose linings. For these tests the backing was removed with the emery wheel shown in Fig. 18. Differences in the values of tensile strength in lines A and B may be attributed partly to errors in measuring the thickness of the specimens that were tested without removing the backing. In the case of No. 1, however, it is thought that the thickness was determined without appreciable error. The adhesion between tube and backing being weak, it

was possible to separate the two by hand, and the eight specimens thus secured showed a maximum variation in thickness of only 0''.003. The average thickness was used in computing the strength of specimens tested with backing (line A). It is seen that in this case the backing very materially increased the strength of the test pieces.

TABLE 5.—Effect of Backing on the Tensile Properties of Hose Linings

Sample <i>a</i>	Set after elongation and release	Tensile strength	Ultimate elongation
	Per cent	Lb./in. ²	Per cent
1, A.....	<i>b</i> 24.5	3080	590
1, B.....	<i>b</i> 23.0	2535	575
2, A.....	<i>b</i> 17.5	3015	625
2, B.....	<i>b</i> 18.5	2790	635
3, A.....	<i>b</i> 17.5	3025	645
3, B.....	<i>b</i> 19.0	2615	610
4, A.....	<i>b</i> 20.5	2705	650
4, B.....	<i>b</i> 19.0	2720	645
5, A.....	<i>b</i> 24.0	2795	580
5, B.....	<i>b</i> 23.5	2300	585
6, A.....	<i>c</i> 20.5	2555	535
6, B.....	<i>c</i> 22.5	2410	540
7, A.....	<i>b</i> 21.0	2095	550
7, B.....	<i>b</i> 17.5	2335	590
8, A.....	<i>c</i> 21.5	1190	535
8, B.....	<i>c</i> 20.5	1190	535

a A, tested without removing backing; B, tested with backing removed.

b Measured after 400 per cent elongation for 10 minutes, with 10 minutes' rest.

c Measured after 350 per cent elongation for 10 minutes, with 10 minutes' rest.

(*f*) *Influence of Previous Stretching on Strength, Elongation, and "Recovery."*—Test pieces that have been used to determine set usually show greater strength and ultimate elongation than are obtained with test pieces that have not been previously stretched.

TABLE 6.—Influence of Repeated Stretch on Tensile Strength and Ultimate Elongation

Sample No.	Tensile strength		Ultimate elongation	
	Single stretch	Repeated stretch	Single stretch	Repeated stretch
	Lb./in. ²	Lb./in. ²	Per cent	Per cent
1.....	2470	2610	645	765
2.....	1740	1960	665	780
3.....	990	1180	510	645
4.....	1710	1790	460	555
5.....	750	790	430	440
6.....	930	920	375	465

Table 6 gives the strength and ultimate elongation obtained in testing six samples of rubber, first, with a single stretch, and second, by repeated stretching, beginning with 200 per cent and increasing each stretch by 100 per cent until failure.

In testing rubber as described above, it is found that if during the latter part of the test the increments in extension for successive stretches are small (say, 25 per cent of the original length), a point is reached where the rubber breaks down, and beyond which it fails on a subsequent stretch at a tension less the maximum which it has already developed.

The recovery after a definite elongation is usually greater if the rubber has been previously stretched than if determined in the usual way. This is illustrated by the results shown in Table 7, in which the columns marked "Repeated stretch" show the set after repeated stretching, beginning with 100 per cent and increasing 100 per cent for each subsequent stretch. The results in columns marked "Single stretch" were obtained in the usual way, each specimen being stretched but once. In each case the set was measured from the original gage marks, after 1-minute stretch and 1-minute rest, the tabulated results being the average of the values obtained in testing a number of specimens.

TABLE 7.—Influence of Repeated Stretch on the "Recovery" of Rubber

No.	Method of testing—	Set (in per cent) after being stretched—				
		100 per cent	200 per cent	300 per cent	400 per cent	500 per cent
1	Repeated stretch.....	1.0	4.5	9.5	16.0	25.0
	Single stretch.....			11.7	19.8	29.0
2	Repeated stretch.....	1.8	4.0	7.7	13.7	21.2
	Single stretch.....			8.0	14.7	21.5
3	Repeated stretch.....	3.7	9.0	17.7	27.0	37.0
	Single stretch.....			21.7	34.0	47.0
4	Repeated stretch.....	4.0	12.3	28.7	48.7
	Single stretch.....		14.3	33.0	56.0
5	Repeated stretch.....	8.1	19.4	34.0
	Single stretch.....		19.3	33.0
6	Repeated stretch.....	4.3	16.3	34.0
	Single stretch.....		17.0	35.3

It will be noted that the effect of previous stretching is very marked in the case of Nos. 1, 3, and 4; that it is very slight in the case of Nos. 2 and 6; and that in the case of No. 5 the set is slightly increased by previous stretching.

(g) *Influence of the Form of Test Piece on the Results of Tension Tests.*—There is a wide difference of opinion in regard to the relative merits of the straight and ring-shaped test pieces. The ring, which is highly recommended by some, undoubtedly possesses certain advantages as regards convenience in testing, and uniform results may be obtained by this method.

Ring test pieces, however, do not show the full tensile strength of rubber, on account of the uneven distribution of stress over the

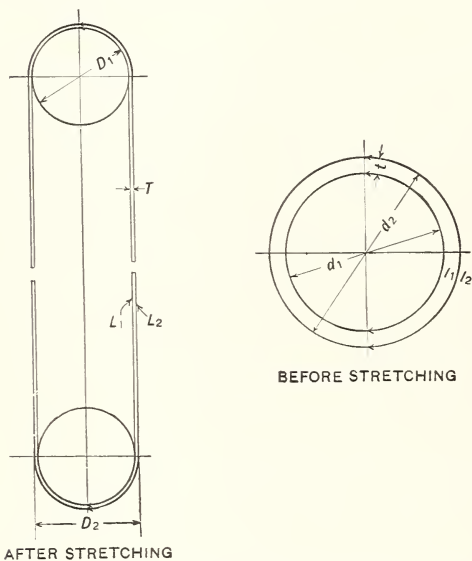

FIG. 33.—Ring test piece before and after being stretched

cross section. This fact is evident from a simple analysis, and may be verified by comparative tests with straight and ring-shaped test pieces, provided the straight test pieces are sufficiently enlarged at the ends to prevent failure in the grips, and provided further that the change in width is not made too abruptly.

Assuming for simplicity that the extensibility of rubber is the same in all directions, it will be seen by reference to Fig. 33, which represents a ring

test piece before and after extension, that,

If E_1 = per cent elongation of the inside surface at breaking point (automatically measured),

$$\text{then } E_1 = \frac{L_1 - l_1}{l_1} \cdot 100 \dots \dots \dots (1)$$

If E_2 = per cent elongation of the outside surface when specimen breaks,

$$\text{then } E_2 = \frac{L_2 - l_2}{l_2} \cdot 100 \dots \dots \dots (2)$$

$$L_2 = L_1 + \pi/2 (D_2 - D_1) = L_1 + \pi T \dots \dots \dots (3)$$

$$T = t \sqrt{\frac{l_1}{L_1}} \text{ approximately } \dots \dots \dots (4)$$

(assuming that the volume of rubber is constant.)

From equations 1, 2, 3, and 4 we have

$$E_2 = E_1 \cdot \frac{l_1}{l_2} \cdot \frac{L_1 + \pi t \sqrt{\frac{l_1}{L_1}} - l_2}{L_1 - l_1} \dots \dots \dots (5)$$

which is represented graphically in Fig. 34 (a) for the usual size of ring in which $l_1 = 70$ mm and $t = 4$ mm.

This relation is practically a linear one, and $E_2 = 0.83 E_1$ approximately. Fig. 34 (b) shows the slight error introduced by neglecting the term $\pi t \sqrt{\frac{l_1}{L_1}}$

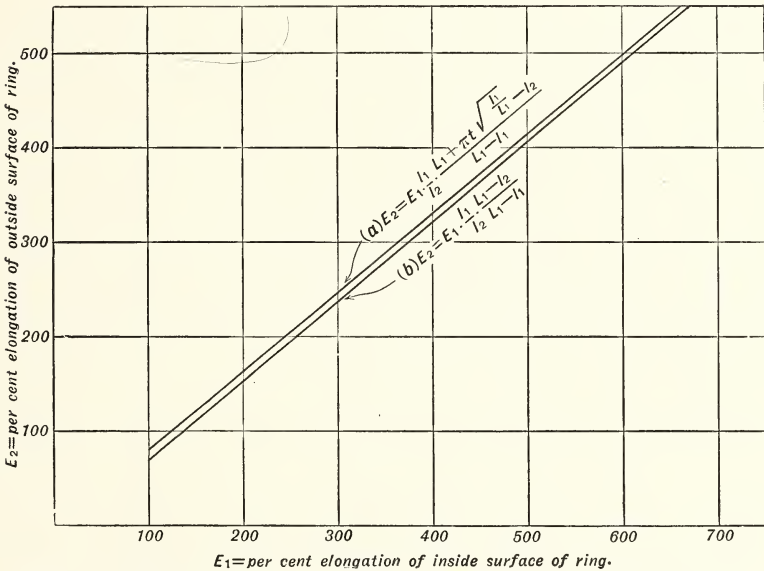

FIG. 34.—Relation between the elongation at the inside and outside of a ring

Now, since the percentage of elongation at the outside surface of the ring is less than at the inside surface, the tensile stress must also be less at the outside than at the inside surface. From equation (5) it follows that the decrease in the percentage of elongation is approximately uniform from the inside to the outside of the ring, this relation being shown in Fig. 35 for $E_1 = 600$ per cent and $l_1 = 70$ mm. The relation between stress and elongation being practically a linear one for values of elongation near the breaking point, the decrease in tensile stress must also be fairly uniform from the inside to the outside of the ring at the time of failure. This is illustrated graphically in Fig. 35, in which the values for tensile stress were taken from the stress-strain diagram shown in Fig. 36, No. 1.

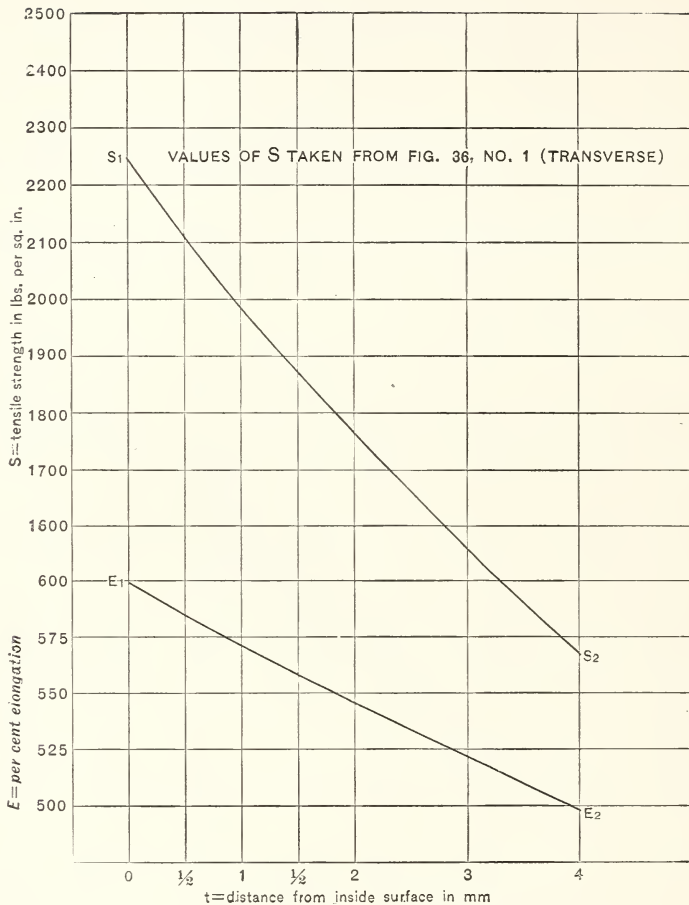

FIG. 35.—Variation in elongation and tensile strength from the inside to the outside of a ring

If S_1 = the stress at the inside surface of the ring at failure, or true tensile strength of the rubber corresponding to E_1 , and S_2 = the stress at the outside surface, corresponding to E_2 , and S = the average stress over the cross section of the ring, which is the value for tensile strength obtained by the ring method, we have

$$S = \frac{\text{Breaking load}}{\text{Area of section}} = \frac{S_1 + S_2}{2} = \frac{S_1}{2} \left(1 + \frac{S_2}{S_1} \right) \text{approximately} \dots \dots \dots (6)$$

Now, since the ratio $\frac{S_2}{S_1}$ varies for different rubbers, S does not bear a constant ratio to, and, therefore, can not be taken as, a measure of tensile strength. Elongation, however, is measured at

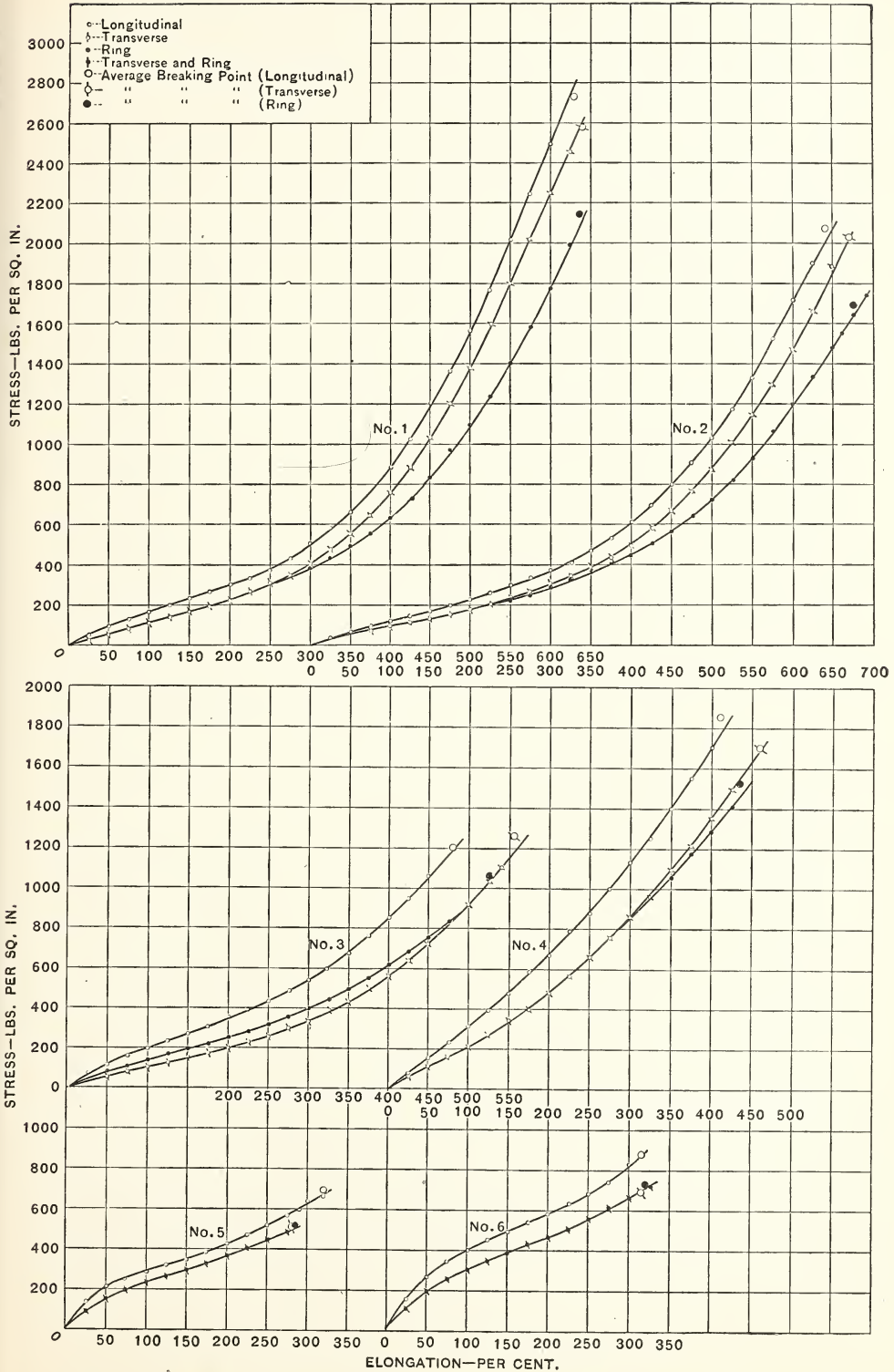

FIG. 36.—Stress-strain curves for rubber tested with straight and ring-shaped specimens

the inside surface of the ring and, therefore, represents the maximum extension of the rubber around the inside of the ring. The average elongation over the cross section of the ring is,

$$E = 1/2 (E_1 + E_2) \text{ approximately} \dots\dots\dots (7)$$

If the extensibility of rubber were the same in all directions, values of S and E obtained from equations (6) and (7) would, theoretically, give a point lying very near the stress-strain curve for the same rubber tested in the form of a straight specimen. This, however, is not the case, as has been already pointed out, and as may be seen from Fig. 36.

The difference between S and S_1 is greater for high-grade rubbers than for compounds of poor quality, as may be seen by reference to Fig. 36, which represents stress-strain curves plotted from the results of tests on straight and ring specimens. Table 8 shows values for tensile strength and ultimate elongation obtained for the same rubbers by the two methods.

The ring test piece obviously does not give a true stress-strain curve on account of the varying stress over its cross section.

TABLE 8.—Relative Tensile Strength and Elongation of Rubber Tested with Straight and Ring-Shaped Specimens

Specimens	Tensile strength, in pounds per square inch, for rubber compounds Nos. 1 to 6					
	1	2	3	4	5	6
Straight specimens:						
Longitudinal (L) ^a	2730	2070	1200	1850	690	880
Transverse (T).....	2575	2030	1260	1700	510	690
Ring specimens (R).....						
R.L.....	0.78	0.82	0.88	0.82	0.74	0.83
R.T.....	0.83	0.83	0.84	0.89	1.00	1.06
Ultimate elongation, in per cent						
Straight specimens:						
Longitudinal.....	630	640	480	410	320	315
Transverse.....	640	670	555	460	280	315
Ring specimens.....	635	675	525	435	285	320

^a Longitudinal indicates the direction in which the rubber has been passed through the calender rolls.

Straight specimens were cut both longitudinally and transversely, with reference to the direction in which the rubber had been passed through the calender rolls. They were tested with the machine shown in Fig. 24, and the ring specimens were tested

with a Schopper machine, Fig. 28. In each case the specimens were stretched at the rate of about 8 in. per minute. A number of test pieces, both straight and ring shaped, particularly in the case of No. 3, showed abnormally low tensile strength and elongation on account of small holes or particles of grit at the point of rupture. Such specimens are not included in the results tabulated below, each of which represents the average of from 5 to 15 tests.

A line was drawn across each of the ring specimens to indicate the longitudinal direction, and the point of failure was noted. There was a tendency for the rings to rupture along this line, thus indicating that the sheets were strongest longitudinally, or in the direction of rolling. This difference in strength is shown by the straight test pieces, except in the case of compound No. 3. It is seen from Fig. 36 that the curve for transverse specimens lies below that for longitudinal specimens, thus showing that a given stress will produce a greater elongation if applied transversely than if applied longitudinally. It is to be expected, therefore, that the elongation of a ring will be less than that for a transverse straight specimen. The natural variation in rubber, however, is often sufficient to obscure small differences in elongation, due to the methods of testing.

In the case of Nos. 5 and 6, the curves for the ring specimens almost coincide with those for the transverse straight specimens, and the tensile strengths of these rubbers when tested by the two methods are seen to agree fairly well. It is to be noted, however, that for the higher-grade rubbers the difference in tensile strength by the two methods is very marked. Although the difference is not great, there is a tendency for the transverse specimens to show a greater ultimate elongation than the longitudinal specimens, notwithstanding the greater strength shown in the latter case.

(6) "FRICTION" TEST.—The "friction" or adhesion between the plies of fabric, or between the fabric and rubber parts, is of great importance; in fact, the life of pneumatic tires, belting, hose, etc., depends in a great measure upon the efficiency of this adhesion. For a detailed description of test methods see page 88.

Friction is preferably determined autographically with the machine illustrated in Fig. 37, which records the tension required to cause a definite rate of separation between the two parts considered.

The autographic machine for testing friction, Fig. 37, is operated by a one-eighth-horsepower worm-gear shunt motor which is

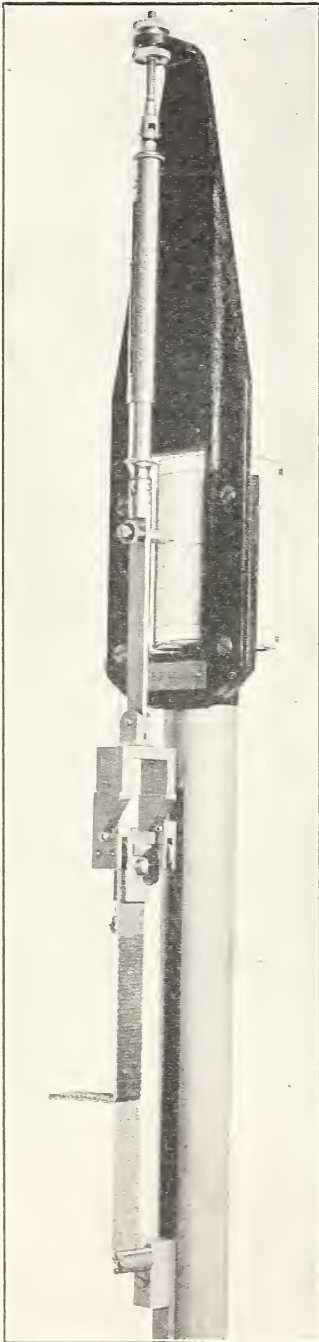

FIG. 37.—Autographic friction machine for measuring and recording the adhesion between plies of fabric

belted to a stepped pulley. A worm on the pulley shaft drives a worm wheel which is geared to a spur inside of the vertical steel column. This spur drives a steel rack to the upper end of which is attached the movable grip. From the top of the machine is suspended a spring which carries at its lower end a fork or suitable grip for holding the test piece. Between the spring and fork is a pencil holder in front of which is a drum carrying a paper chart on which the record is drawn.

The capacity of the spring is 40 pounds, the extension being 1 inch for 10 pounds pull. The spring is replaceable, thus permitting the use of a spring suitable for the grade of material under test. The drum is driven by a cord which passes over a small guide pulley and thence to a spool on the spur gear shaft. The surface speed of the drum is the same as the rate of separation of the plies of fabric being tested.

In the case of rubber hose, a 1-inch section is fitted over a mandrel and placed in the fork suspended from the top of the machine, and the detached end of the fabric is secured to the lower grip as shown.

In the case of rubber belting a 1-inch strip containing two plies is used. The plies are separated for a short distance and the ends secured in the two grips, the upper grip being a clamp held in the fork above mentioned.

The method formerly used, but which is rapidly going out of use, is illustrated in Fig. 38 and consists in measuring the rate of separation produced by the action of a dead-weight.

A marked difference is often found in the friction between different plies of the same hose, as well as at different points along the same ply. Uniformity in the friction is desirable.

The results of this test are influenced by the temperature conditions, the rate of stripping caused by a given weight being greater at high than at low temperatures. Also, the rate of stripping is greater if the mandrel fits snugly in the ring than if the ring is allowed to sag over a loose mandrel. The variation in friction, however, in the same hose is often such as to obscure these influ-

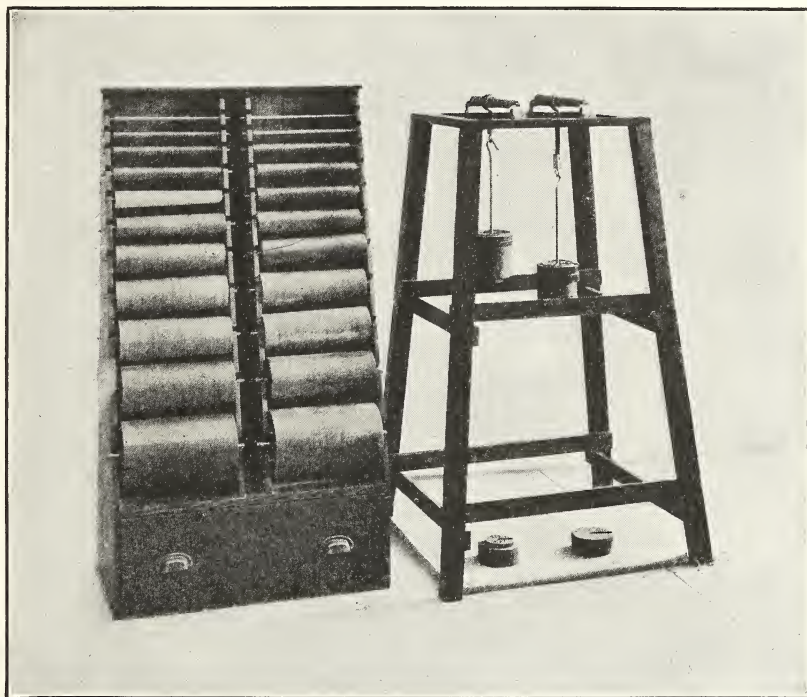

FIG. 38.—Apparatus for testing the "friction" of rubber hose by the dead-weight method

ences, unless observations are made under conditions which differ greatly.

In connection with this test, attention may be called to a point which, though generally recognized, is sometimes lost sight of in the interpretation of results.

It has been observed that no stripping is produced by increasing the weight up to a certain point, after which the rate of stripping increases gradually at first, and then more rapidly, with small increments in weight, until finally a very small increase in weight causes a large change in the rate of stripping. The general

behavior is illustrated graphically in Fig. 39, in which each point represents the average of a number of tests on a very uniformly frictioned hose.

As a result of this behavior, an air hose, for example, which is required to show a rate of stripping not exceeding 6 inches in 10 minutes under 25 pounds, might be regarded as of very inferior quality if it stripped, say, 20 inches in 10 minutes, whereas the same hose would probably show little or no stripping under 20 pounds and come within the required limit under 22 pounds.

In testing fire hose (see p. 89) the central portion of the lining is separated from the jacket for a short distance. The detached end of the jacket is clamped in a stationary grip, and the weight is suspended from the rubber lining.

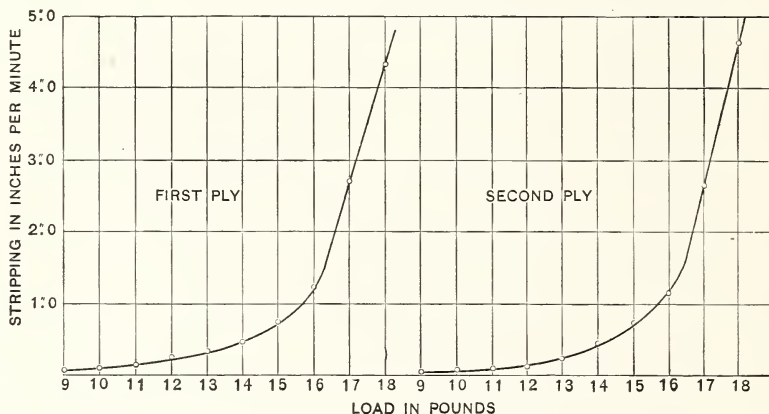

FIG. 39.—“Friction” test of rubber hose. Curves showing rate of stripping under different loads

The “friction” between the plies of duck in rubber belting is sometimes tested by applying the load in a direction at right angles to the plane of separation, as in the case of “plied” hose. As shown in Fig. 40, A, this is done by cutting the belt about halfway through along parallel lines 1 inch apart. The belt rests on horizontal supports just outside of the strip which has been cut, and the weight is suspended from the detached end of the duck. Fig. 40, B, illustrates a method by which a 1-inch strip is held in a fixed clamp with the weight suspended from the end of a detached layer of duck. In testing by this method it will be found that the angle of separation varies somewhat according to the thickness of the strip and that the results are thereby influenced to some extent. The difficulty may be avoided by subdividing the 1-inch section into strips of two plies each, as shown in

Fig. 40, C, and very satisfactory results are obtained in this way. It is found that for a given weight the rate of stripping is decidedly greater by methods B and C than by method A. Fig. 41 shows graphically the results obtained by the three methods.

(7) HYDRAULIC-PRESSURE TEST.—The pressure test as usually made consists simply in subjecting the hose to water pressure created by a force pump of any convenient type. The coupling at the free end is closed with a plug, and the pump connection is made with a reducing coupling. By using two clamps at each

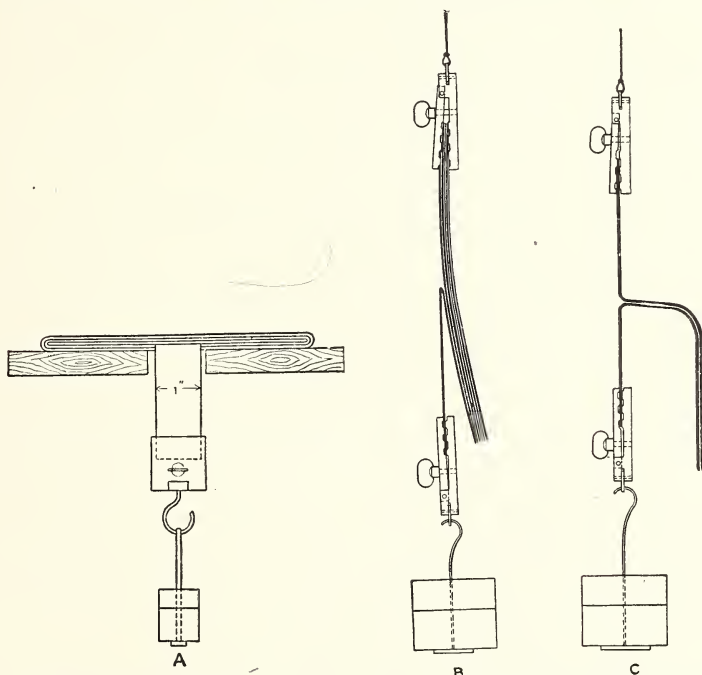

FIG. 40.—Illustrating methods of testing the "friction" of rubber belting by the application of dead weights

end it is possible to make a tight joint even under high pressure. It is necessary to provide a check valve to protect the pressure gage against shock when a hose bursts. A pet cock must be provided to release the air as the hose is being filled.

Requirements of specifications as regards the pressure test vary according to the kind of hose, but, as a rule, the test is made not with the view of developing the ultimate strength of the hose but rather to detect defects in workmanship, which are usually noticeable at a pressure well below that necessary to rupture the hose.

In the case of fire hose it is usual to specify a certain pressure when the hose is lying straight or when bent to the arc of a circle of given radius, and the hose must stand a specified pressure when doubled upon itself. A full 50-foot length must not show excessive expansion, elongation, warping, or twist under pressure, and the twist must be in a direction tending to tighten the couplings.

(8) STEAMING TEST.—Fig. 42 illustrates a method of testing steam hose. The header 1 is provided with six outlets, each of which is controlled by a one-half-inch globe valve. The header 2, which is connected to a steam trap 3, is similarly provided with

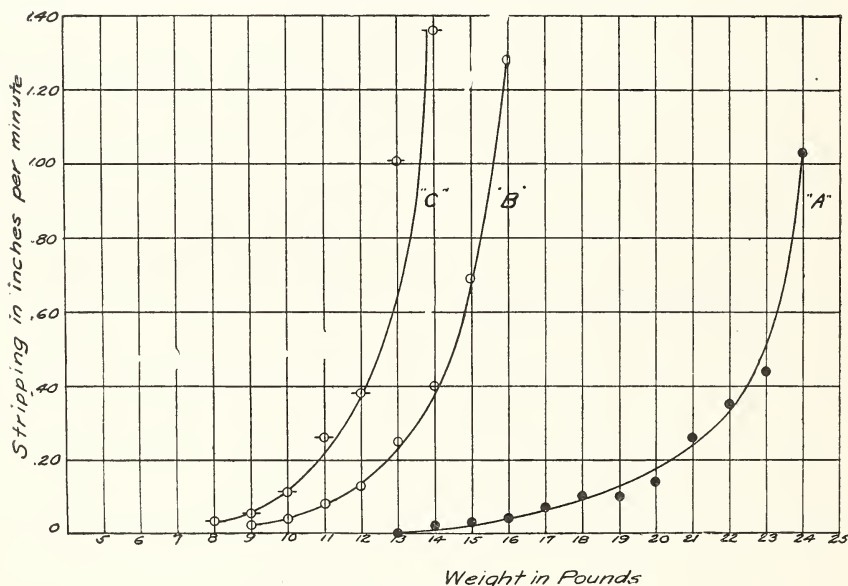

FIG. 41.—Friction test of rubber belting

Curves showing rate of stripping when tested by the methods illustrated in Fig. 40

inlets and controlling valves. The hose to be tested is cut into lengths that will just fit between the connections on the headers, the bottom connections being made with unions. Steam passes through a regulating valve (not shown) into the header 1 and thence through the hose to the header 2, from which the condensation is carried to the steam trap.

(9) TESTING THE RUBBER INSULATION OF WIRE.—The mechanical tests that are usually specified for the rubber insulation of wire are the same as those already described in connection with tension tests.

The method of preparing test pieces, however, is not always the same, but depends upon the size of conductor and the character of insulation. (See p. 85.)

(10) COMPARATIVE TESTS OF MACHINE AND HANDMADE TUBES.—

A question is sometimes raised as to whether the tube of a hose has been made in a tubing machine or from calendered sheet. Calendered tubes are often specified, and since it is sometimes impossible to determine by inspection if a tube is machine-made or handmade, a test that could be depended upon in all cases to distinguish between the two kinds of tubes would serve a useful purpose.

From the nature of the case a chemical analysis could not determine this point, because a compound might be calendered or run through a tubing machine without in any way altering its composition. The mechanical properties of a compound, however, are influenced to a greater or less extent by the method of manufacture.

Comparative results for elasticity or "set," tensile strength, and ultimate elongation are given in Table 9. Each of the three compounds was made into two tubes of the same size, one from calendered sheet and the other made in a tubing machine. The conditions of vulcanization were the same for each pair of tubes, so that any difference in their physical properties is fairly attributable to the effects of the tubing machine and calender rolls.

In comparing the results it is interesting to note that the squirted tubes show practically the same set when tested longitudinally and transversely, whereas the calendered stocks are much more elastic in the transverse direction, as has been pointed out in connection with tests previously described. This is more clearly illustrated in Fig. 43, which shows graphically the relation

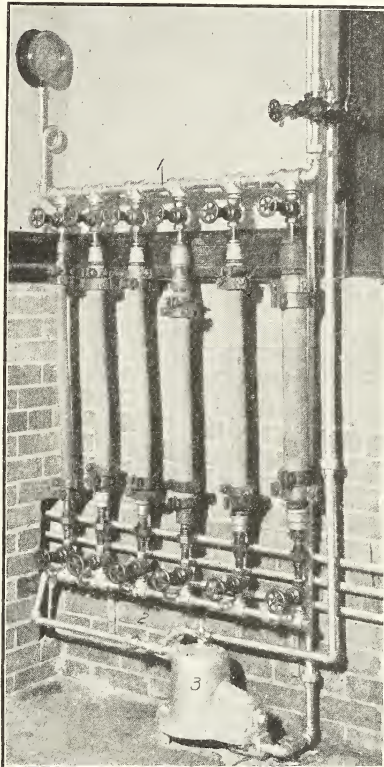

FIG. 42.—Six samples of steam hose connected up for steaming test

between set and elongation for test pieces cut longitudinally and transversely from the compound G-13. In the same way Fig. 44 shows stress-strain curves for G-13. Similar tests of the other two compounds could not be made for lack of material.

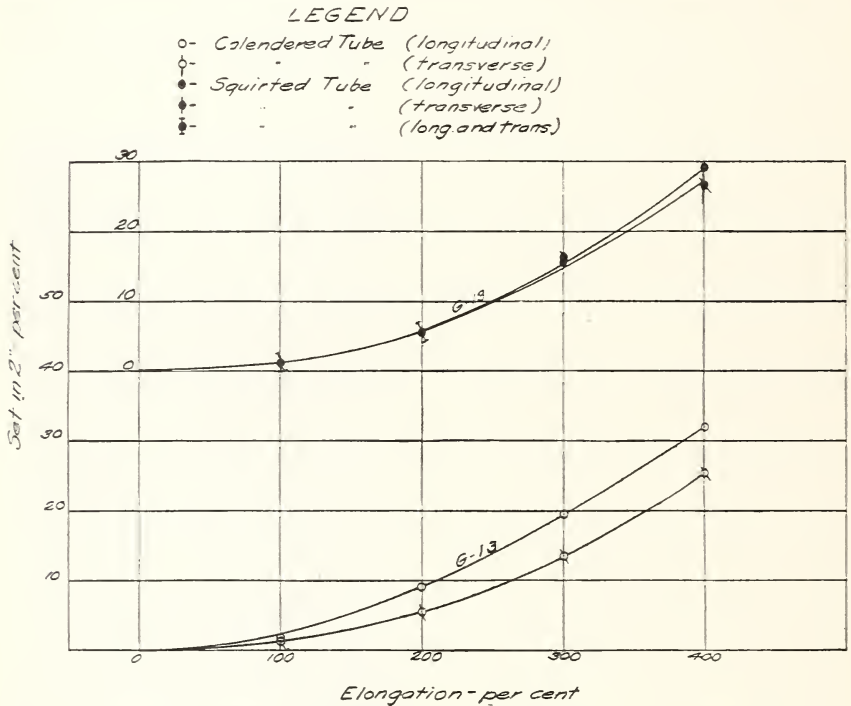

FIG. 43.—Curves showing the elasticity of a "squirted" tube as compared with a calendered tube, tested in the longitudinal and transverse directions

TABLE 9.—Relative Tensile Properties of "Squirted" and Calendered Tubes when Tested in the Longitudinal and Transverse Directions

Sample No.	Method of manufacture	Set ^a after one-minute stretch and one-minute rest		Tensile strength		Ultimate elongation	
		Longitudinal	Transverse	Longitudinal	Transverse	Longitudinal	Transverse
		Per cent	Per cent	Lb. in. ²	Lb. in. ²	Per cent	Per cent
V-14.....	Calendered.....	11.7	10.5	520	530	275	290
	Squirted.....	12.5	12.5	460	460	240	235
V-16.....	Calendered.....	24.7	20.0	1450	1380	530	535
	Squirted.....	23.0	21.8	1310	1290	525	505
G-13.....	Calendered.....	26.0	18.5	1110	1295	455	510
	Squirted.....	22.5	21.5	1130	1330	470	510

^a V-14 was stretched 200 per cent; V-16 and G-13, 350 per cent.

Definite conclusions should not be drawn from these preliminary tests, but the results, which indicate that the elastic properties of squirted stock are practically the same in all directions for extensions up to at least 75 per cent of the ultimate elongation, may be verified by further experiments.

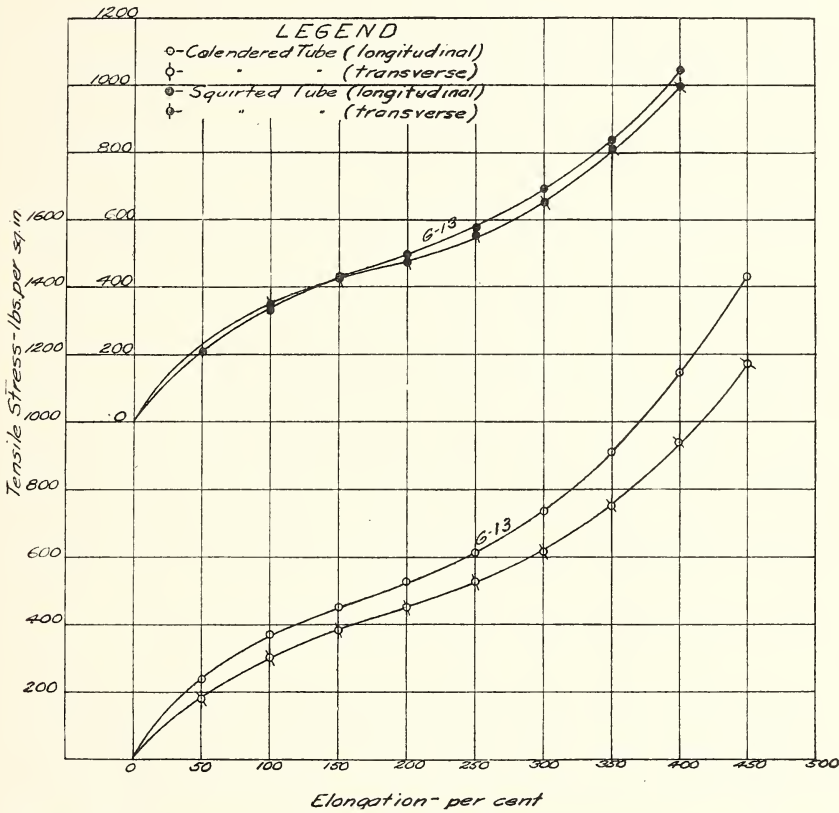

FIG. 44.—Stress-strain curves for a “squirted” and a calendered tube tested in the longitudinal and transverse directions

(II) TESTING OF RUBBER BANDS.—(a) Under One-fourth Inch in Width.—In the testing of rubber bands a different method is employed from that used in the testing of other types of rubber goods. Owing to the size of the specimens, it is impracticable to obtain accurately the cross-sectional area, consequently the tensile strength is not computed in pounds per square inch, as is customary in other goods.

Double-spool grips similar to the grips illustrated in Fig. 23, B, but smaller, are used. The test machine used for this work is shown in Fig. 29, and a description may be found on page 56.

Tensile Strength and Ultimate Elongation.—The tensile strength is measured in pounds and is expressed on the basis of two hundred or one hundred 2-inch bands per ounce, according as the bands are one-sixteenth or one-eighth inch wide. The elongation is expressed in percentages of the original length.

The average inside length (measured flat) of several ounces of the bands to be tested is measured. These bands are weighed and the equivalent number of 2-inch bands per ounce (N) is calculated, the following formula being used:

$$N = \frac{n \times L \times 28.35}{2.0 \times w}, \text{ where } ^4$$

n = number of bands weighed;

L = average inside length of band in inches (measured flat);

w = weight of bands in grams.

The tensile strength on the basis of two hundred or one hundred 2-inch bands per ounce (S) is calculated as follows:

$$S = \frac{TN}{200} \text{ for bands one-sixteenth inch wide;}$$

$$S = \frac{TN}{100} \text{ for bands one-eighth inch wide, where}$$

T = tensile strength of bands in pounds.

Ultimate elongation, per cent = $\frac{(L - L_1) 100}{L_1}$, where:

L = one-half the distance around spools at time of failure;

L_1 = initial inside length of band, measured flat (one-half total length).

(b) *Bands One-fourth Inch in Width or Over.*—The testing of bands one-fourth inch in width or more requires the use of the grips shown in Fig. 23, B, and the tests are made on the machine usually employed for determining the tensile strength of rubber. (Fig. 24.)

Tensile Strength and Ultimate Elongation.—In bands of this size it is practicable to measure the width and the thickness.

⁴If avoirdupois weights are used, the equation becomes

$$N = \frac{n \times L}{2.0 \times w}$$

In this case w is the weight in ounces.

The tensile strength is calculated in pounds per square inch as follows:

Tensile strength in pounds per square inch = $\frac{B}{2wt}$, where

B = breaking load in pounds;

w = width of band in inches;

t = thickness of band in inches.

Elongation is measured and expressed in the same way as described above for bands under one-fourth inch in width.

Jar rings are tested in the same way as rubber bands. Owing to the shape of the material the internal length L_1 becomes one-half of the internal circumference thus:

$L_1 = \frac{\pi D}{2}$, where

D = internal diameter in inches.

(b) BUREAU OF STANDARDS PROCEDURE FOR PHYSICAL TESTING OF RUBBER

1. (1) SAMPLING.—Samples shall be taken directly from the finished material. They should be marked with the maker's name, date of sampling, and sufficient other data to insure easy and complete identification. Unless otherwise specified, the size of sample should be in accordance with the following schedule:

AMOUNT OF MATERIAL REQUIRED FOR TESTS

Hose of 3-inch diameter and less.....	2 feet.
Hose over 3-inch diameter.....	1 foot.
Hose for pressure or steam test.....	4 feet.
Sheet packing.....	1 square foot.
Insulated wire.....	4 to 6 feet.
Bicycle and motor cycle tires.....	whole tire.
Automobile tires, solid.....	section 30 inches long.
Automobile tires, pneumatic.....	whole tire.
Inner tubes.....	whole tube.
Miscellaneous rubber goods, sufficient material to provide at least 15 pieces.....	1 by 6 inches.

2. (2) PHYSICAL TEST METHODS.—(a) *Articles of Irregular Shape*.—When articles are of such shape or size as not to admit of standard test pieces being prepared, the manufacturer shall submit test strips 8 inches long, $1\frac{1}{2}$ inches wide, and one-eighth inch thick, unless otherwise specified. The strips shall be guaranteed to be of the same composition and cure as the articles delivered.

3. (b) *Preparation of Samples for Test.*—Separating Rubber From Fabric.—The gasoline used in separating rubber from fabric should be 72 to 76° Bé, and upon evaporation should not leave an appreciable amount of oily residue. To avoid stretching the rubber unnecessarily it is desirable to cut the material into strips slightly wider than a test piece, and the separation should be made gradually and a little at a time, while the rubber is gripped near the point of separation. The rubber should then be so placed as to permit free evaporation from all parts of its surface. Benzene (benzol) can also be used.

4. *Removing Fabric Impressions.*—Any unevenness of surface, such as impressions caused by contact with fabric parts, which would interfere with an accurate measurement of thickness, is removed by careful grinding with an abrasive wheel of about No. 30 grit. (See Fig. 18.) A wheel for this purpose should be provided with a slow feed in order that very little rubber be removed at one cut, otherwise the rubber may be injured by overheating. The speed should be from 2500 to 3000 rpm for a wheel of 5 inches diameter. If a backing is used, as in the case of cotton rubber-lined fire hose, it should be entirely removed in the same way. The face of the wheel should be kept sharp.

5. *Cutting Test Pieces for Determinations of Tensile Strength, Ultimate Elongation, and Set.*—Test pieces shall be cut with a metal die (see Figs. 20 and 21) which should be kept sharp to avoid leaving ragged edges on the rubber.

6. The distance between cutting edges of the blade over that portion of the die corresponding to the gage length of the test piece shall not vary more than 0.002 inch.

7. An arbor press (see Fig. 19) is recommended for forcing the die through the rubber in preference to the practice of striking the die with a mallet. The operation is facilitated by wetting the cutting edges of the die. The rubber should rest on a smooth and slightly yielding surface which will not injure the blade. A piece of rubber belting, or preferably leather belting, is suitable for the purpose. When the material on which the test pieces are cut has become slightly rough from use, a sheet of paper placed under the rubber will be of advantage.

8. *Shape and Size of Test Pieces for Determinations of Tensile Strength, Ultimate Elongation, and Set.*—Unless otherwise specified, the central portion of test pieces shall be one-fourth inch wide over a gage length of 2 inches, the ends being gradually enlarged to a width of 1 inch to provide a satisfactory gripping surface. If

one-half-inch test pieces are specified the end portions should have a width of $1\frac{1}{4}$ inches. (See Fig. 20, A.)

9. In the case of pure gum or compounds containing a large percentage of rubber which have a very great elongation, shorter test pieces one-fourth inch wide over a gage length of 1 inch and $1\frac{1}{4}$ inches wide at the ends are used. (See Fig. 20, C.)

10. In the case of insulated wire and cable the form of test piece shall be as described in paragraph 22, entitled "Insulated Wire."

11. Gage Marks.—Unless otherwise specified, the gage length shall be 2 inches, except that if the rubber has an elongation greater than 700 per cent, or if the article to be tested is not of sufficient size to produce a test piece of this length, the gage length shall be 1 inch. Gage marks shall be made with ink by using a stamp consisting of parallel steel blades which produce very fine lines, care being taken in all cases not to injure the rubber.

12. Temperature of Testing Room.—All tests of rubber shall be made at a room temperature between 65 and 90° F. The samples should remain at this temperature for at least one hour before being tested.

13. (d) *Preparation of Tension Test Pieces.*—Unless otherwise specified eight test pieces shall be prepared, four for the tensile strength test and four for the set test.

14. Sheet Packing, Rubber Belting, etc.—Test pieces from material of this sort may be cut in any direction. Strips are first cut of a length and width slightly greater than the corresponding maximum dimensions of the test pieces. If the material contains fabric, the rubber is carefully separated as described in paragraph 3, and after the gasoline has evaporated the surface is buffed over the central portion of the strip for a distance somewhat greater than the gage length of the test piece. The test piece is then cut out with a die as described in paragraph 5.

15. Hose.—Unless otherwise specified, as in the case of cotton rubber-lined fire hose, test pieces shall be cut longitudinally.

16. In the case of plied hose, sections of sufficient length for test pieces are cut out. The sections are cut into longitudinal strips slightly wider than the test pieces, after which the cover and the tube are separated from the fabric as described in paragraph 3. When the gasoline has evaporated, the fabric impressions are removed by buffing over a portion of the strip slightly greater than the gage length, as described in paragraph 4. The test pieces are then cut out with a die as described in paragraph 5.

When the diameter of the hose is one-half inch or less, test pieces should be first cut with a die and then buffed.

17. With cotton rubber-lined hose, a section of sufficient length to produce the desired number of test pieces is cut. This section is cut at the lap and subdivided into transverse strips from which the cotton jacket is removed by the use of gasoline. When the gasoline has evaporated, the rubber backing is buffed off and the test pieces are cut out as described above, except that the central portion of the test piece shall be one-half inch wide over a gage length of 2 inches. (See Fig. 20, A.) The fold shall be within the gage length.

18. To determine the strength of the lap, another section of sufficient length to produce the desired number of test pieces is cut. This section is cut so that the lap will be in the center of the constricted portion of the test piece. The cotton jacket is removed by the use of gasoline. When the gasoline has evaporated test pieces are cut out as described above, without being buffed.

19. Solid Rubber Tires.—First cut from the tire a section of rubber 6 inches long, measured in the direction of its circumference. From the center of this section cut a longitudinal strip $1\frac{1}{2}$ inches wide normal to the axis of the tire. This strip is subdivided in a slicing machine or by other suitable means into strips $1\frac{1}{2}$ inches wide and one-eighth inch thick. These strips are buffed if necessary before being cut into test pieces.

20. Pneumatic Tires.—Strips 6 inches long and $1\frac{1}{4}$ inches wide are cut longitudinally from the center of the tread and from the side wall, and the rubber is separated from the fabric with the aid of gasoline. The nonskid portion of the tread rubber is sliced off with a knife, after which the central portion is buffed on both sides over a length of $2\frac{1}{2}$ inches until free from all friction compound, fabric impressions, or any irregularities of surface. The side wall is buffed on one or both sides, as may be necessary. The test pieces shall be of the shape and size illustrated in Fig. 20, B.

21. Inner Tubes.—Strips 5 inches long and $1\frac{1}{2}$ inches wide are cut longitudinally from the tube. These strips shall not be buffed unless the impressions left by the wrapping fabric are so pronounced as to vitiate the results of tests. The die used for cutting test pieces from this grade of rubber should be kept very sharp and each strip of rubber should be thoroughly wet before the die is used. A piece of paper should be inserted under the

strip before the test piece is cut. The test pieces shall be of the shape and size illustrated in Fig. 20, C.

22. Insulated Wire.—When the diameter of wire is large enough and the insulation thick enough, test pieces are prepared as follows: The insulation is cut through to the wire in the longitudinal direction and the rubber is removed in one piece. The rubber is then laid out flat and cut with a die. Test pieces are buffed on both sides until they are smooth all the way across the constricted portion.

23. When the diameter of wire is too small or the insulation too thin to permit of buffing, test pieces may be cut to better advantage if the rubber is held down with pins. In this case the cross section of test piece is approximately a sector of a ring.

24. When the diameter of the wire is too small to permit of specimens being cut with a die, the insulation is tested as a whole. The general method for removing the insulation as a whole from a single wire is as follows: The insulation is removed for a distance of one-half inch at each end of a 7-inch length of wire and a slight nick is made in the wire at one end of the insulation. The uncovered ends are gripped in the jaws of a testing machine and the wire pulled until it breaks at the nick. The stretching of the wire reduces its cross section, and thus facilitates the removal of the insulation. The end of the wire should be rounded before pulling it through the insulation as the rough end might cut the rubber. In some instances adhesion between the wire and rubber is so great that the insulation can not be easily removed after the above treatment. When this is the case the sample is immersed in mercury, which forms an amalgam with the tin coating on the wire. Within one-half hour the amalgamation has usually progressed sufficiently to permit the insulation to be easily removed. When there is a longitudinal bead or fin on the surface of the insulation it should be removed with a small sharp wood plane before the wire is withdrawn.⁵

25. (e) *Tensile Strength and Ultimate Elongation.*—Measurement of Cross Section.—The width of the test piece shall be measured with a gage or caliper (see Fig. 22) graduated to 0.001 inch, the instrument being used in such a way that the compression of the rubber between the contact surfaces is negligible. The thickness of the test piece shall be measured with a gage graduated to 0.001 inch, under a pressure of approximately 3 ounces, exerted by a contact foot of approximately 0.3 inch diameter. The cross section shall be considered as the product of

the minimum width by the minimum thickness of the test piece between the gage marks.

26. If the cross section of the test piece is not of rectangular shape, as in the case of wire insulation, its area is computed from measurements as follows (Fig. 45):

(1) When the test piece is cut with a die and buffed (par. 22) the width is taken as the average of the top and bottom widths of the buffed portion between the gage marks.

(2) When the test piece is cut with a die and not buffed (par. 23)

$$A = \frac{\text{arc}}{4D}(D + d)(D - d), \text{ where}$$

A = area of cross section in square inches;

D = outside diameter of insulation in inches;

d = diameter of wire or wire core in inches;

Arc = width of test piece corresponding to outside diameter D .

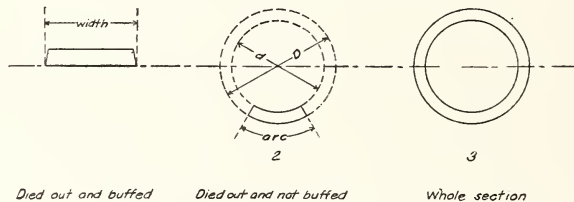

FIG. 45.—Cross section of test pieces

(3) When the insulation is tested as a whole, in the form of a hollow cylinder (par. 24)

$$A = 0.7854 (D + d) (D - d), \text{ where}$$

A = area of cross section in square inches;

D = outside diameter of insulation in inches;

d = diameter of wire or wire core in inches.

27. Testing Machine.—The machine (see Figs. 24, 25, 26, 27, 28, and 29) used for this test shall fulfill the following requirements:

(1) The dial or scale for indicating the applied tension shall be accurate within 0.1 pound for samples having a breaking strength less than 15 pounds. For all loads above 15 pounds the maximum error shall not exceed 0.5 pound. The indicator shall remain at the point of maximum load after rupture of the test piece.

(2) The grips (see Fig. 23) for holding test pieces shall be of such a design that a uniform pressure will be exerted across the gripping surface to avoid uneven slipping, and to insure failure of the test piece within its constricted portion.

(3) The machine shall be power driven, and the rate of separation of the grips shall be 20 inches per minute, unless otherwise specified.

28. Method of Test.—Care should be exercised to adjust the test pieces symmetrically in the grips in order that the tension shall be distributed uniformly over its cross section. If the tension is greater on one side of the test piece than on the other, the gage marks will not remain parallel and the maximum strength of the rubber will not be developed. The ultimate elongation may be measured by holding a scale (graduated to 0.1 inch) in a slightly inclined position at the back of the test piece with its lower end pressed lightly against the rubber just back of the lower gage mark. As the rubber is stretched the eye follows the scale just back of the upper gage mark. With a little practice the elongation at break may be measured with an error not exceeding 0.05 inch.

29. Computation of Results.—Tensile strength is expressed in pounds per square inch, and is determined by dividing the breaking load in pounds by the minimum cross section of the test piece in square inches. Ultimate elongation is expressed in percentage. For example, if a test piece of cross section 0.25 by 0.1 inch failed at a tension of 50 pounds, when the distance between the gage marks was 14 inches, the tensile strength would be $50 \div (0.25 \times 0.1) = 2000 \text{ lbs./in}^2$, and the ultimate elongation would be $14 - 2 = 12$ inches, or 600 per cent.

30. (f) *Set*.—Definition.—The term “set” refers to the extension remaining, after a specified elongation for a given period of time, followed by a specified interval of rest.

31. Testing Machine.—The machine recommended for this test is illustrated in Fig. 30. This machine is adapted to test six specimens at once, thus permitting a very great saving of time.

32. Method of Test.—The test piece is stretched at an approximately uniform rate of speed such as to require about 15 seconds to reach the specified elongation and is held in this position for 10 minutes, including the time required for stretching (unless otherwise specified), after which it is immediately released (without being allowed to snap back), and laid out on the test table. After a rest of 10 minutes (unless otherwise specified), the distance between the gage marks is measured to the nearest 0.01 inch and the set recorded in percentage of the original gage length. In stretching a test piece it is convenient to use a measuring rod of a length equal to the exact distance required between the gage marks. By holding the rod beside the test piece while it is being stretched the operation is simplified and the chance of stretching the test piece more or less than the desired amount is

very much reduced. In taking the time of the various operations in this test, a stop watch or a watch having a second hand should be used.

33. Computation of Results.—For example, a test piece is stretched from 2 to 10 inches (400 per cent) for 10 minutes and then released. Its length measured after 10 minutes' rest is 2.4 inches, so that the set under these conditions is 0.4 inch, or 20 per cent.

34. (g) *Friction*.—Definition.—The term "friction" is used to indicate the adhesion between the two parts considered and is expressed numerically by (1) the average tension, in pounds, required to cause separation at a definite rate (1 inch per minute, unless otherwise specified) under stated conditions, or (2) the average rate of separation in inches per minute caused by a specified tension exerted between the parts under the stated conditions. In either case, the test piece is 1 inch wide unless otherwise specified.

35. Preparation of Test Pieces.—*Wrapped Hose*.—The most satisfactory way of preparing test pieces is as follows: A short length of hose is pressed snugly over a smooth, slightly tapered mandrel. The mandrel is put in a lathe, and 1-inch sections or rings are cut with a short pointed knife, which is forced gradually through the cover and plies of fabric, but not entirely through the rubber tube. Upon removal from the mandrel the rings are easily cut apart with a knife. The pointed knife used in cutting the rings should be kept sharp and should be wetted before each cut. A cut is made through the rubber cover at the point where the outside ply of fabric ends. The fabric is then unwound until the outside ply carrying the rubber cover is entirely separated from the rest of the sample.

36. *Braided Hose*.—One-inch rings are cut as for wrapped hose. A cut is made through the rubber cover and first ply of braid. The braid is stripped just enough to admit of a clamp being attached.

37. *Hose Reinforced with Metal*.—When metal reinforcement is present as in suction hose, which is reinforced by means of metal embedded in the rubber tube, between the plies of duck, or embedded in a layer of rubber in the central portion of the hose, test pieces are prepared as follows: A transverse section $2\frac{1}{2}$ inches long is cut from the hose and opened so as to form a flat strip. Two parallel lines 1 inch apart are drawn on the rubber

tube, the reinforcement being symmetrically located between them. The sample is then cut through on these lines making a strip 1 inch wide and equal in length to the circumference of the hose.

38. Cotton Rubber-Lined Hose.—With a soft pencil draw two parallel lines $2\frac{1}{2}$ inches apart, following the filler strands around the circumference of the hose. Cut the hose at the lap and also along these lines so as to form a strip of a length equal to the circumference of the hose. This strip is laid out flat, and the rubber lining cut through to the jacket along parallel lines $1\frac{1}{2}$ inches apart or as may be specified. The central portion of the lining between these two cuts is separated from the jacket for a short distance.

39. Belting.—A 1-inch section about 8 inches long is cut from the belt in the longitudinal direction unless otherwise specified. This section is subdivided into strips of two plies each, one end of which is separated for a distance of 2 inches.

40. Packing.—Test strips are prepared from sheet packing, and from square packing in the same way as from belting, except that if square packing is of a size that does not permit of a 1-inch strip a narrower test piece shall be used. Test pieces are prepared from round packing in the same manner as from plied hose.

41. Pneumatic Tires.—Friction is determined with a 1-inch section of the tire. The test piece may be conveniently prepared as follows: Cut a section approximately 2 inches long and remove the beads. Wrap the section tightly around a mandrel, using friction tape. The mandrel is put in a lathe and a 1-inch section cut with a pointed knife.

42. Testing Machine.—Friction should preferably be determined with a machine (see Fig. 37) which automatically records on a chart the value of the friction at all points of the test piece. The machine should be adapted to maintain a uniform rate of separation of the parts as specified.

43. Method of Test.—If so specified, or if the nature, form, or construction of the material is such as to preclude the use of a testing machine, the dead-weight method is used. This consists in suspending the specified weight from the detached end of one of the parts to be separated. The length stripped is measured after the weight has been removed, between marks made on the other part at the beginning and end of the test. The duration of the test is timed with a stop watch or a watch having a second hand.

44. *Wrapped Hose.*—A test piece prepared as in paragraph 35 is pressed snugly over a short wooden mandrel which is free to revolve in roller bearings attached to the upper jaw of the testing machine. The detached end of the fabric is held in the lower jaw. The downward movement of the lower jaw produces a radial pull which separates the fabric, and at the same time makes a graphical record which shows the length of fabric separated and the tension required at each point. In this case the rate of separation of the jaws is the same as the rate of stripping.

45. *Braided Hose.*—The method is the same as for wrapped hose.

46. *Hose Reinforced with Metal.*—The method is the same as that for belting except that the test is made upon the entire section of hose.

47. *Cotton Rubber-Lined Hose.*—The end of the fabric from which the rubber has been separated is clamped in a stationary grip. From the detached end of the rubber is suspended a weight of 12 pounds, and the rate of separation is determined from the length stripped during a measured interval of time. Measurements are made to the nearest 0.05 inch, between marks made on the fabric at the beginning and end of the test. The time shall be measured with a stop watch or with a watch having a second hand, and the duration of test shall be five minutes or such part thereof (measured to the nearest second) as may be required to strip a length of 5 inches.

48. *Belting.*—One of the loose ends of a test strip (prepared as in par. 39) is clamped in the upper jaw and the other end in the lower jaw of the testing machine. In this case the rate of separation of the jaws is twice the rate of stripping.

49. *Packing.*—Method is same as for belting.

50. *Pneumatic Tires.*—Between tread and breaker: Remove the tread at one end up to the breaker strip and separate the two for a distance of about one-fourth inch. The detached end of the tread is clamped in the lower jaw and the corresponding end of the tire section in the upper jaw.

51. *Between side wall and carcass:* When the friction test between tread and breaker strip has been made, remove the test piece from the machine and separate the tread by hand until the point has been reached where the side wall joins the carcass. Cut off a portion of the tread, leaving only sufficient material to be clamped in the lower jaw; clamp the corresponding end of the tire section in the upper jaw.

52. Between breaker and cushion: Remove the tread (with breaker strip attached) for a sufficient distance to admit of its being clamped in the lower jaw; clamp the corresponding end of the tire section in the upper jaw.

53. Between cushion and carcass: Remove the cushion (with breaker strip attached) for a sufficient distance to admit of its being clamped in the lower jaw; clamp the corresponding end of the tire section in the upper jaw.

54. Between plies of fabric: The tread, breaker strip, and cushion having been removed, the outside ply of fabric is separated for a sufficient distance to admit of its being clamped in the lower jaw. The corresponding end of the tire section is clamped in the upper jaw. The other plies of fabric are separated in succession and tests are made in the same way. Cord tires require special treatment because it is necessary to clamp at least three plies of fabric in each jaw.

55. If during a test one of the parts begins to tear, instead of separating from the other part the material being torn is cut with a knife up to the surface of contact between the two parts and the test started again.

56. The graphical record shows the length stripped and the tension required at each point.

57. Computation of Results.—The value of the friction is recorded as the average tension required to cause separation at the rate specified, this being determined over that portion of the chart corresponding to an actual separation of the parts being tested. If one of the parts repeatedly tears, instead of separating from the other part, the average load at which tearing takes place is taken as the value of friction.

58. If the dead-weight method is used, the value of friction is recorded as the average rate of separation under the action of a specified weight.

59. (*h*) *Hardness*.—Definition.—The term “hardness” is used to express the depth of indentation produced by a spherical ended plunger of definite size, under a stated normal pressure exerted for a period of one minute.

60. Instrument for Measuring Hardness.—There appears to be no definite relation between the indications of different instruments that have been designed for measuring the hardness of rubber.

61. Unless otherwise specified the instrument used will consist of a plunger with spherical end of 3.2 or 6.4 mm diameter on

which a pressure of 1 kilogram is exerted by means of a dead-weight and a gage graduated to one one-hundredth millimeters for measuring the depth of indentation. The smaller plunger is used except in the case of very soft rubbers.

62. Method of Test.—The sample to be tested is supported in a horizontal position and the instrument is adjusted so that the plunger is vertical. In testing sheet rubber the sample should rest on a smooth unyielding surface.

63. The needle of the gage is set at zero with the plunger resting on the sample, after which the 1-kilogram weight is lowered upon the plunger and allowed to remain for one minute. The reading on the gage dial then shows the depth of indentation in millimeters.

64. The average of four readings is recorded as the hardness of the sample.

65. (i) *Steam Test.*—Hose.—Unless otherwise specified, steam hose is tested as illustrated in Fig. 42. The header 1 is provided with six outlets, each of which is controlled by a one-half-inch globe valve. The header 2, which is connected to a steam trap 3, is similarly provided with inlets and controlling valves. The hose to be tested is cut into lengths that will just fit between the connections on the headers, the bottom connections being made with unions. Steam passes through a regulating valve (not shown) into header 1 and thence through the hose to the header 2, from which the condensation is carried to the steam trap.

66. The hose is subjected in this way to the action of steam at a pressure of 50 lbs./in.² for six days of seven hours each, the steam being turned off and the hose allowed to cool during the intervals.

67. The results of tension and friction tests before and after steaming are indicative of the quality of the hose.

68. Steam Packing.—Sheet packing is bolted between iron plates and subjected to the action of steam in an autoclave as illustrated in Fig. 46. Steam is generated by an automatic gas burner which is controlled by the pressure gage, the arrangement being such that the needle on the gage opens and closes the gas valve by making electrical contact at points corresponding to the minimum and maximum pressures for which the contact points are set.

69. The test samples, several of which may be steamed at once by placing thin sheets of iron between them, are supported on a wire stand which holds them well above the water level.

70. Valves.—Rubber pump valves are steamed in the autoclave as described above, except that they are not bolted between plates.

71. (j) *Hydraulic-Pressure Test.*—Fire hose.—A 3-foot sample when subjected to hydraulic pressure increasing gradually at the approximate rate of 300 pounds per minute should not burst at a pressure less than that specified. The test is made first with the hose lying straight, and second with the hose held to a circular arc of 27 inches radius. The coupling remote from the source of water is closed with a cap or plug provided with a pet cock to permit the escape of air while hose is being filled with water.

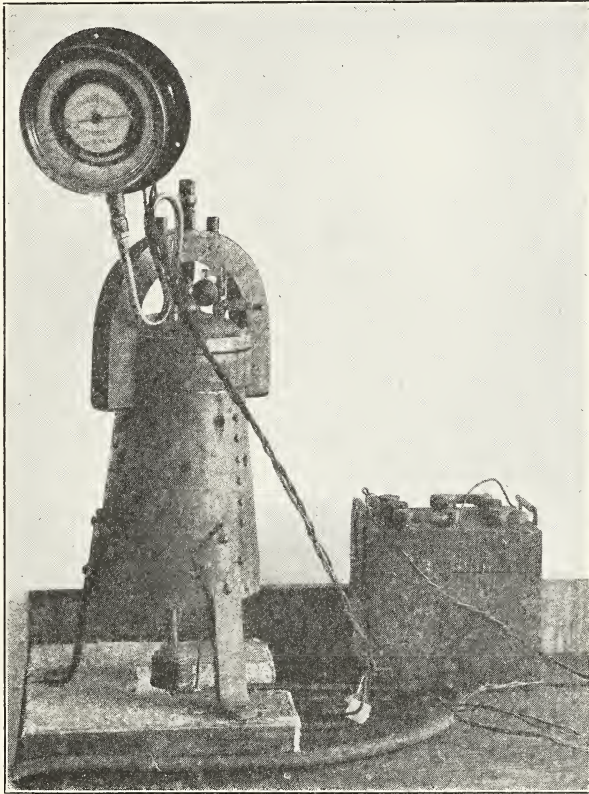

FIG. 46.—Autoclave for testing valves and packing in steam under high pressure

72. A full length of hose is laid out straight on a smooth surface such as a cement walk. One coupling is connected to the source of water supply, the other coupling being closed with a cap or plug provided with a pet cock for the escape of air while the hose is being filled with water. To insure the complete removal of air from the hose, the surface on which the hose rests should be slightly inclined toward the source of water supply.

73. With a crayon or soft pencil three marks are made around the hose jacket, dividing its length approximately into four equal parts. The circumference of the hose is measured at these marks during the test, as described later.

74. With the pet cock open, admit water into the hose gradually until the air has been expelled and the hose is completely filled with water. The pet cock is then closed and the pressure gradually increased until the gage (which has been tested for accuracy) shows a pressure of 10 lbs./in.², when the water supply is cut off and a mark made on the top surface of the hose jacket adjacent to the closed coupling. This mark is used as a means of measuring the amount of twist during the test.

75. With a steel tape measure the length of hose between backs of couplings, recording the result to the nearest one-quarter inch, and with a small flexible steel tape measure the circumference of the hose at the three equidistant points above referred to and record the results to the nearest one-thirty-second inch.

76. Water is now gradually admitted into the hose in such quantity as will increase the pressure per square inch at an approximate rate of 300 pounds per minute, and while the pressure is being increased the hose is carefully examined for leakage or other defects. When the test gage indicates the pressure specified for the kind of hose being tested, the source of water supply is shut off and the hose allowed to remain under this pressure for 10 minutes. When 8 minutes have elapsed, the following measurements are taken and recorded: (1) The length of hose between the backs of couplings, following the contour of the hose; (2) the circumference of hose at the three equidistant points; (3) the amount of twist as indicated by the mark on the hose jacket adjacent to the closed coupling; (4) the amount of "warp" or deviation from a straight line as measured from a cord stretched from center to center of the backs of couplings; and (5) the rise from the surface on which the hose rests.

77. Two pressure gages should be provided for this test, one graduated from 0 to 20 lbs./in.² and the other from 0 to about 1000 lbs./in.² The low-pressure gage is used only to indicate the pressure of 10 lbs./in.², at which the initial measurements are taken. It should be provided with a shut-off valve and relief cock to protect it against the higher pressures used in the test.

78. (*k*) *Interpretation of Results.*—The average of the results of four test pieces is used for a determination of tensile strength,

ultimate elongation, and set. If in any case the result of a single test piece is found to be very much lower than that of the others, indicating a flaw in the material, the low result is discarded and the average of the results of the other three tests is recorded. If the result thus obtained fails by less than 5 per cent to meet the requirements of the specifications, a check test is made with four additional test pieces, the results of which, computed as above, shall be considered final.

79. The value of friction is based on the result of a single test. If the average value as determined with an autographic machine fails by less than one-half pound to meet the specification, or if the result of a dead-weight test is greater than 1 inch per minute, but less than 1.1 inches per minute, a check test is made, the result of which shall be considered final.

2. BUREAU OF STANDARDS METHODS OF CHEMICAL ANALYSIS

The methods given below are not entirely original, but have been compiled from the various publications on rubber analysis, from the information gained through the routine testing of rubber goods for delivery on Government contracts, and from cooperative research with various scientific organizations. These methods are subject to revision whenever this Bureau is convinced that changes would improve them.

(a) REASONS FOR THE ANALYSIS

ACETONE EXTRACT.—If the acetone extraction is made on a vulcanized compound, the acetone extracts the rubber resins, the free sulphur, any mineral oils or waxes, and part of any bituminous substances or vulcanized oils that may have been used. The percentage of free sulphur is determined and deducted from the total extract. The corrected figure thus obtained will at times give valuable information regarding the quality of the rubber present. For the best grades of Hevea rubber this should not exceed 5 per cent of the rubber present. A higher extract may indicate the presence of inferior or reclaimed rubbers. If the acetone extract solution is fluorescent it indicates the presence of mineral oil.

FREE SULPHUR.—The free sulphur is that part of the sulphur originally added as such which remains unchanged after vulcanization. Small amounts of free sulphur are not harmful, but there are some who object to it in excessive amounts, claiming that in such cases it increases the rate of deterioration of the rub-

ber. It is difficult, however, to place a limit beyond which the free sulphur is to be considered excessive.

A limit is usually placed on the free sulphur in high-grade insulation compounds, not particularly on account of its effect on the rubber, but because it may corrode the copper wire.

TOTAL SULPHUR.—Sulphur occurs in vulcanized rubber as free sulphur, in combination with the rubber, and at times in the mineral fillers and rubber substitutes.

It is limited by specification in high-grade material in order to eliminate undesirable sulphur minerals and to prevent as far as possible the use of inferior or reclaimed rubbers and rubber substitutes. The inferior rubbers require a larger percentage of sulphur than Hevea rubber for proper vulcanization, while the reclaimed rubber and substitutes usually contain large amounts of sulphur. If it is desired to have material made from Hevea rubber only, the effect of placing the limit for sulphur where it will just suffice for the vulcanization of the amount of Hevea rubber called for will be to make it difficult to use inferior grades of rubber, reclaimed rubber, and substitutes and still have the total sulphur fall within the specified limit.

ASH AND SULPHUR IN THE ASH.—The ash is the residue left after ignition. It consists principally of the nonvolatile mineral fillers. The percentage of ash is of no great importance in itself, but is used in the calculation of the rubber present, as will be explained later.

The sulphur in the ash consists of the sulphur from some of the mineral fillers and also part of the sulphur that was combined with the rubber, but which during ignition enters into combination with one or another of the mineral fillers. Its amount is determined merely for the purpose of obtaining a correction figure and has no other significance.

BARYTES.—It has been stated above and elsewhere that sulphur may be present in the mineral fillers. There can be no objection to such sulphur provided the mineral containing it has no injurious effect on the rubber and, further, that the amount of such sulphur can be readily determined. Barytes is such a substance, and it is permitted in practically all compounds where the amount of sulphur is limited by specifications. Barium carbonate is sometimes used, and this must be considered when correcting for sulphur as barytes.

RUBBER.—The determination of the amount of rubber present in a vulcanized compound is an important though difficult matter. For a long time this was determined by igniting a weighed sample and determining the mineral fillers or ash. The rubber was calculated by the difference between 100 per cent and the sum of the ash (sulphur free), total sulphur, and corrected acetone extract. This procedure is still extensively used, and, although it can not be depended upon always to give accurate results, it is probably as good as any method yet devised.

The problem is to-day being attacked from several points. Some chemists are endeavoring to find a suitable solvent which will remove the rubber and permit the weighing of the mineral residue. Turpentine, terebene, cymene, anisole, phenetole, cresol, aniline, and many others have been used with more or less success. Those compounds which contain ingredients such as glue, carbon, cellulose, and antimony sulphide, which will burn or volatilize during ignition, must be analyzed by use of a suitable solvent. This Bureau has had good success with the methods described further on. Other chemists are working along the line of the direct determination of the rubber present by means of the various addition products, such as tetrabromide, nitrosite, etc., but the methods are not yet satisfactory.

SPECIFIC GRAVITY.—The specific gravities of the various constituents of vulcanized rubber differ greatly. (See Appendix.) The percentages found by analysis are, however, always expressed by weight. It is apparent, therefore, that with equal percentages, by weight, a compound of specific gravity of, say, 1.5 will have less rubber per unit volume than one of a higher specific gravity. The present tendency is to state the minimum percentage of rubber by volume.

WAXY HYDROCARBONS.—The efficiency of rubber as an insulator is very much lessened by the absorption of moisture. To prevent this, small amounts of paraffin or ceresin are added. Their presence is usually permitted in specifications, the limit being generally placed at 4 per cent, although the tests made in this Bureau indicate that the maximum amount is seldom used. The amount of such waxy hydrocarbons is determined not only in order to learn if the specifications have been complied with, but also to obtain the percentage of acetone extract from the rubber itself.

The chloroform extraction removes a large portion of the mineral rubbers, which are only partially soluble in acetone. Only a small amount of properly vulcanized rubber of good quality is dissolved by the chloroform.

ALCOHOLIC SODA EXTRACT.—Some of the rubber substitutes are prepared by the action of sulphur or sulphur chloride on vegetable oils. The purpose of the alcoholic-potash extraction is to detect the presence of such substitutes and to give some idea of their amount. Hevea rubber contains only a small percentage of material extracted by this solvent.

(b) SAMPLING

1. (1) PREPARATION.—Before preparing a sample for analysis the analyst shall, by inspection, assure himself that it has not been contaminated in any way before reaching him.

2. Not less than 25 grams of the sample shall be prepared by taking pieces from various parts of the original material. This shall be separated as far as possible from foreign matter—that is, different grades of rubber, backing, friction, cloth, wire, and the like—by stripping or buffing. Pieces shall be laid aside for the specific-gravity determination before grinding the sample.

3. Samples of soft rubber shall be prepared by breaking down on the experimental mill to the required fineness. Care must be taken not to overheat the sample. With compounds of high rubber content such as inner tubes, and floating stocks, the required fineness is usually attained when the sample has been sheeted out very thin. If no mill is available, the rubber is to be cut very fine with scissors, or if heating can be avoided, it may be run through a meat chopper.

4. Samples of hard rubber shall be prepared for analysis by rasping or buffing.

5. Raw, reclaimed, or unvulcanized rubber shall be sheeted out very thin on the experimental mill and shall be rolled in holland or other cotton cloth to prevent the sample from sticking. It may be also cut with scissors.

6. Samples of rubberized cloth shall be taken from various parts of the original material and prepared by cutting into pieces $1\frac{1}{2}$ mm square with the scissors and then well mixed.

7. Samples prepared for the determination of rubber by the nitrosite method shall be ground to pass a 20-mesh screen or cut with the scissors to the smallest size practicable.

8. (2) CLASSIFICATION.—Samples of rubber goods may be classified roughly as follows: Those for which the rubber content may be arrived at by going through the regular procedure of analysis; that is, specific gravity, acetone extract, chloroform extract, alcoholic-soda extract, free sulphur, total sulphur, ash, sulphur in ash, and free carbon.

9. Those for which the regular procedure must be augmented by the addition of special analyses to determine those substances which decompose when the rubber is ashed. The members of this class may contain antimony sulphide, glue, cloth, cork, etc.

10. Those which must be analyzed according to other required specifications, as some insulation, code wires, etc.

11. Those which contain a solvent or thinner, as pastes, putties, cements. The solvent or thinner is evaporated, and the dried residue is then analyzed as an unvulcanized sample; it usually comes under the class described in paragraph 8. The quantity and composition of the solvent or thinner should be determined.

12. Those which require the Joint Rubber Insulation Committee method. This class includes compounds which are high in carbonates and sulphides as well as those for which the above method is specifically requested.

(c) REAGENTS

13. The acetone used for extractions shall be chemically pure and shall be freshly redistilled over anhydrous sodium carbonate. Acetone to be used for the determination of ash, free carbon, and nitrogen may be recovered acetone which has been redistilled as above.

14. The alcoholic-potash or alcoholic-soda solution shall be of normal strength and shall be freshly made by dissolving the required amount of alkali in the smallest possible quantity of distilled water and adding this to specially purified alcohol. The alcohol for this purpose shall be prepared by allowing an approximately twice normal alcoholic solution of sodium hydroxide to remain in a warm place, preferably at 50 to 60° C, for several weeks and then redistilling.

15. The nitric acid-bromine reagent shall be prepared by adding a considerable excess of bromine to concentrated nitric acid, shaking thoroughly, and allowing it to stand some hours before using.

16. The fusion mixture for sulphur determinations shall be made by mixing equal quantities of sodium carbonate and powdered potassium nitrate. According to the alternative method (par. 27) only sodium carbonate is used.

17. Barium-chloride solution shall be made by dissolving 100 grams of crystallized barium chloride in 1 liter of distilled water and adding 2 or 3 drops of concentrated hydrochloric acid. If there is any insoluble matter or cloudiness, the solution shall be heated on the steam bath overnight and filtered. Care should be taken not to add more acid than the amount specified.

18. If sulphur is to be determined, the carbon bisulphide must be redistilled through a fractionating column filled with small pieces of bright metallic copper.

19. All other reagents shall be chemically pure and should be tested before use.

(d) ANALYSIS

20. (1) *QUALITATIVE*.—In order to properly classify the sample, a rough qualitative analysis is necessary. The color and nature of the sample should be noted when beginning an analysis, so as to get an indication of the presence of carbon, antimony sulphide, vermilion, cloth, and cork. In order to determine whether glue is present, the qualitative test (par. 45) must be carried out. Also by close observation during the course of an analysis considerable qualitative information as to the constituents may be gained. The appearance of the extracts, the color of the fusions, the color of the ash, both hot and cold, should always be noted. If the complete mineral analysis is desired, time is saved by first making a qualitative analysis. There are a number of standard books which may be referred to for this purpose.

21. (2) *QUANTITATIVE*.—(a) *General Procedure*.—Specific Gravity.—If plenty of the material is available a piece weighing about 25 grams is cut off, suspended from the balance by a very fine silk thread, and weighed to the third decimal place. The sample is then immersed for two to three minutes in boiling water, removed, and cooled. It is suspended from the balance by the silk thread used above and weighed while completely immersed in distilled water at 15° C. The specific gravity is found by dividing the weight of the sample in air by the difference between its weight in air and water. For very porous material it is well to have the water in a flask and after short boiling to connect the

flask to the vacuum line. This will cause the water to boil at a gradually decreasing temperature and will assist greatly in removing air bubbles from the rubber. If only a small amount of the rubber is available, the determination is made by means of the pycnometer bottle. About 5 grams of the sample is cut into small strips and weighed. It is treated as before to remove air bubbles. A pycnometer bottle is filled with water at 15° C and weighed. The sample is placed in the bottle, which is again filled

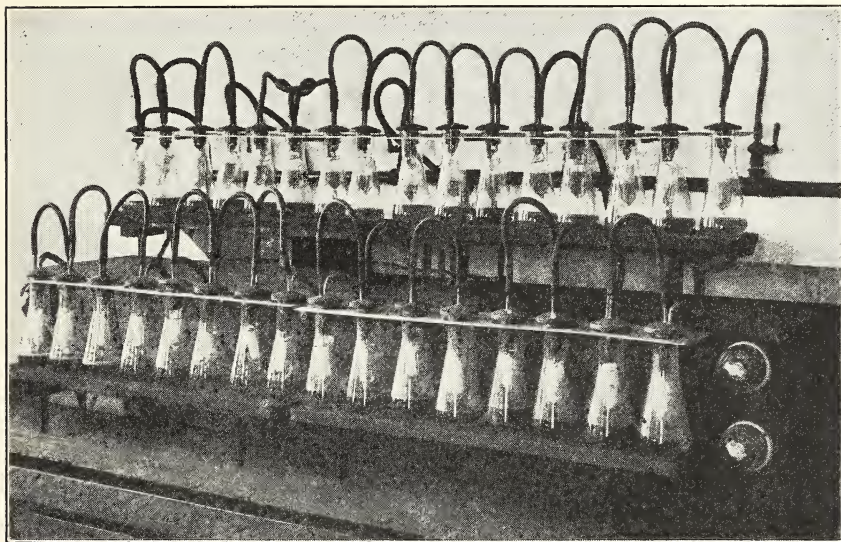

FIG. 47.—Acetone and chloroform extraction apparatus

For the extraction of the rubber resins, free sulphur, any mineral oils or waxes, and part of any bituminous substances or vulcanized oils

with water and weighed. The specific gravity is calculated as follows:

A = weight of pycnometer when filled with water;

B = weight of pycnometer filled with sample and water;

C = weight of sample.

$$\text{Sp. gr.} = \frac{C}{C - (B - A)}$$

22. Acetone Extract.—Place 2 grams of rubber into a thimble made by folding a 9-cm filter paper, so that it will fit into the extraction cup, which is suspended in a weighed assay flask. (See Fig. 47.) Extract the sample continuously for eight hours unless the solution in the thimble is still colored at the end of that time,

when the extraction shall proceed for a further period of four hours or longer. Carefully note all characteristics of the acetone extract, both when hot and cold. Distil off most of the acetone in a recovery still and drive off the remaining solvent on the steam bath at as low a temperature as possible by means of a gentle current of air. Care must be taken to avoid allowing the flasks to stand on the steam bath after the solvent has been removed and while the air is still passing through, because appreciable quantities of free sulphur may be lost by so doing. Dry the assay flask and contents in an air bath for one-half hour at 90 to 95° C, cool, and weigh. Call the residue "acetone extract, uncorrected." To calculate, divide the residue in grams by the weight of the original sample.

23. Chloroform Extract.—The rubber sample, without removing the acetone from it (see par. 22), is suspended in a second weighed assay flask (see Fig. 47) and extracted for one hour with chloroform. If the solution in the extraction bucket is colored, the extraction is continued until it becomes colorless. Care should be taken that any small particles of rubber, which are often carried down into the extract, are filtered off. Evaporate off the solvent (see par. 22), dry for one-half hour at 90 to 95° C, cool, and weigh. The color of the chloroform solution should be recorded in the laboratory notebook. Reserve the rubber for extraction with alcoholic soda. (See par. 24.)

24. Alcoholic-Soda Extract.—Dry the rubber at about 50 to 60° C, transfer to a 200 cc Erlenmeyer flask, add 50 cc of alcoholic-soda solution, and heat under a reflux condenser for four hours. Filter through a pleated filter into a 250 cc beaker, wash first with 50 cc of 95 per cent alcohol, then with 50 cc of boiling water, and evaporate the filtrate to dryness. Use about 75 cc of distilled water to transfer the residue to a separatory funnel. Add a few drops of methyl orange, and acidify the solution with 10 per cent hydrochloric acid. Extract with four portions of ether, 25 cc each, unless the fourth portion should be colored, when the extraction must be continued until no further quantity can be removed. Unite the ether fractions, wash thoroughly with distilled water, and evaporate the ether in an Erlenmeyer flask. Dry at 90 to 95° C, cool, and weigh.

25. Free Sulphur.—Add to the flask containing the acetone extract, uncorrected (see par. 22), 50 to 60 cc of distilled water and 2 or 3 cc of bromine. (If the acetone extract indicated a large

amount of free sulphur, the amount of bromine used may be increased.) Allow the flask to stand one-half hour on the side of the steam bath, then heat cautiously over the direct steam bath until the solution is practically colorless, and filter through a pleated filter into a 250 cc beaker. Cover the beaker with a watch glass, heat on the steam bath, add 10 cc of hot 10 per cent barium-chloride solution, and allow the precipitate to stand overnight. The next day filter the precipitate on a 9 cm filter paper, and wash until free from chlorides. Ignite in a small porcelain crucible over a Bunsen flame or in a muffle furnace, but do not allow the paper to inflame; cool, and weigh. Calculate the barium sulphate to sulphur by means of the factor 0.1373, and calculate the percentage of free sulphur.

26. Total Sulphur.⁵—Place 0.5 gram of rubber in a porcelain crucible of about 75 cc capacity. Add 20 cc of the nitric acid-bromine mixture (see par. 15), cover the crucible with a watch glass, and let it stand for one hour in the cold. Heat for one hour on the steam bath, remove the cover, rinse it with a little distilled water, and evaporate to dryness. Add 5 grams (weigh to about 0.5 gram) of fusion mixture (see par. 16) and 3 to 4 cc of distilled water, and stir at once. Digest for a few minutes, spread the mixture halfway up the side of the crucible to facilitate drying, and dry on a steam bath. Fuse the mixture by heating either over a sulphur-free gasoline flame, or in a muffle furnace, the temperature of which should be regulated by a rheostat and determined by a pyrometer.

If the flame is used, place the crucible in an inclined position on a wire triangle and start the ignition over a low flame. The tendency for the rubber to burn too briskly is controlled by judicious use of the stirring rod, which scrapes the burning portion away from the rest. When part of the mass is burned white, a fresh portion is worked into it, and so on until all of the organic matter is destroyed. It is necessary to hold the edge of the crucible with tongs. Toward the last half of the operation the flame should be increased somewhat, but it is never necessary to heat the crucible to redness. With care a crucible can be used for at least 10 or 12 fusions.

When a furnace is used the crucible should be covered with a watch glass to prevent loss by spattering. The crucible is set on

⁵ Waters and Tuttle, B. S. Sci. Paper, No. 174. See also Tuttle and Isaacs, B. S. Tech. Paper, No. 45. For the most accurate work occluded salts can be corrected for by adapting the suggestion of Johnson and Adams, J. Am. Chem. Soc., 33, pp. 829-845; 1911. See also Waters, B. S. Tech. Paper, No. 177.

a low tripod made from an iron or copper wire triangle with the ends bent down. Several of these crucibles can be placed in an iron tray which will protect the lining of the muffle from any fusion mixture if a crucible should break. The rate of heating of the muffle should be as shown below. For convenience the rate of heating on igniting to ash is also given.

TABLE 10.—Rate of Heating of the Electric Furnace for the Sulphur and Ash Determinations

Time in minutes	Sulphur determination temperature	Ash determination temperature	Time in minutes	Sulphur determination temperature	Ash determination temperature
	°C	°C		°C	°C
5.....	130	130	70.....	450	450
10.....	320	320	80.....	470	470
15.....	345	345			
20.....	350	350	90.....	490	490
30.....	370	370	95.....	500	525
			100.....		595
40.....	390	390	110.....		640
50.....	410	410	115.....		690
60.....	430	430			

After a fusion by either method allow the crucible to cool, place it in a 400-cc beaker, add sufficient distilled water to cover the crucible (about 125 cc is required), and digest on the steam bath for two hours with occasional stirring. If the filtration can not be made in the same day do not add the water and allow the mixture to stand overnight. Filter the solution into a covered 400-cc beaker containing 8 cc of concentrated hydrochloric acid, and wash the residue thoroughly with hot water. Now complete the acidification of the filtrate and washings and add 2 cc of concentrated hydrochloric acid in excess. Cover the beaker and heat the solution on the steam bath. The total volume of the solution should not exceed 300 cc. The solution must be acid to congo paper in order to insure the complete destruction of the carbonates. Add 10 cc of hot 10 per cent barium-chloride solution and allow to stand overnight. Filter off the barium sulphate as before. (See par. 25.) Calculate to the percentage of sulphur present.

27. Alternative Method⁶.—Place 0.5 gram of rubber in a 75 cc porcelain crucible. Add 10 cc of nitric acid-bromine mixture (see par. 15), cover the crucible with a watch glass, and let it stand one hour in the cold. Heat on steam bath for one hour,

⁶ Waters, *J. Ind. Eng. Chem.*, 12, pp. 482-485; 1920. See also B. S. Tech. Paper, No. 177. See also Levin and Collier, *Rubber Age and Tire News*, 9, 2, pp. 47-48; 1921.

uncover and evaporate to dryness. Add 3 cc of nitric acid, cover, warm a short time on bath, then let it cool. Carefully add in small portions, by means of a small glass spatula, 5 grams of sodium carbonate (weighed to 0.5 gram). The watch glass is to be raised only high enough to permit of the introduction of the spatula. The carbonate is allowed to slide down the side of the crucible and is not dropped directly into the acid. Rinse the watch glass with 2 or 3 cc of hot distilled water and stir the mixture thoroughly with a glass rod. Digest for a few minutes, spread the mixture halfway up the side of the crucible to facilitate drying, and dry on the steam bath. Fuse the mixture. (See par. 26.) Allow the crucible to cool, place it in a 400-cc beaker, add sufficient distilled water to cover the crucible (about 125 cc is required), and digest on the steam bath for two hours, with occasional stirring of the solution. If the filtration can not be made the same day do not add the water, but allow the mixture to remain overnight. Filter into a 400-cc beaker, containing 5 cc of concentrated hydrochloric acid, and wash the residue thoroughly with hot water. Add sufficient concentrated hydrochloric acid to neutralize the excess carbonates, using congo-red paper as an indicator, and add 2 cc in excess. Dilute the solution to 300 cc. A strip of gummed paper may be placed on the beaker to show the 300-cc level. Heat on the steam bath, add 10 cc of hot 10 per cent barium-chloride solution, and allow to stand overnight. Filter off the precipitate, wash, and ignite in the usual way.

28. Ash.—Wrap a 1 gram sample in an 11 cm filter paper, extract with acetone for four hours (recovered acetone can be used), and transfer to a weighed, medium-sized porcelain crucible. Distil off the rubber over a very small flame, not allowing it to catch fire, and ignite until burnt clean; cool, and weigh.

The sample may be ashed in a muffle furnace if preferable. The rate of heating should be as given in Table 10. (See par. 26.)

29. Sulphur in Ash.—Add 3 cc of nitric acid-bromine mixture (see par. 15) to the ash (see par. 28), heat on the steam bath, and after one hour remove the crucible and allow it to cool. Carefully add 5 grams of sodium carbonate as described in paragraph 27, and finish as under paragraph 27. Save the insoluble residue on filtering the solution of the fusion mixture in water for testing according to paragraph 43.

30. Free Carbon⁷.—Extract a 0.5-gram sample for eight hours with a mixture of 68 per cent chloroform and 32 per cent acetone,

⁷ Smith and Epstein, B. S. Tech. Paper, No. 136.

by volume. Transfer the sample to a 250 cc beaker and heat on the steam bath until it no longer smells of chloroform. Add a few cubic centimeters of hot concentrated nitric acid and allow to stand in the cold for about 10 minutes. Add 50 cc more of hot concentrated nitric acid, taking care to wash down the sides of the beaker, and heat on the steam bath for at least one hour. At the end of this time there should be no more bubbles or foam on the surface. Pour the liquid while hot into a Gooch crucible containing a thick pad of asbestos, taking care to keep the insoluble material completely in the beaker. Filter by slowly applying gentle suction and wash well by decantation with hot concentrated nitric acid. *Empty the filter flask.* Wash with acetone and a mixture of equal parts of acetone and chloroform until the filtrate is colorless. The insoluble material, which has been carefully retained in the beaker, is digested for 30 minutes on the steam bath with 35 cc of a 25 per cent solution of sodium hydroxide. Dilute to 60 cc with hot distilled water and heat on the steam bath. Filter the alkaline solution and wash well with a hot 15 per cent solution of sodium hydroxide. Test for the presence of lead by running some warm ammonium-acetate solution, containing an excess of ammonium hydroxide, through the pad into a solution of sodium chromate. If a yellow precipitate appears, the pad must be washed with the ammonium-acetate solution until the washings no longer precipitate the sodium-chromate solution. Next wash the residue a few times with hot concentrated hydrochloric acid, and finally with a warm, 5 per cent hydrochloric-acid solution. Remove the crucible from the funnel, taking care that the outside is perfectly clean, dry it in an air bath for one and one-half hours at 150° C, cool, weigh, burn off the carbon at a dull red heat, and reweigh. The difference in weight represents approximately 105 per cent of the carbon originally present in the form of lampblack or gas black.

31. Rubber Hydrocarbons.—Calculated by difference: Subtract from 100 per cent the sum of the following: Chloroform extract; alcoholic soda or potash extract; acetone extract, corrected; ash, sulphur free; total sulphur; and free carbon. Call the figure thus obtained "rubber hydrocarbon by difference." The method of obtaining the corrected figures for ash and acetone extract used above is as follows: (1) Subtract the "free sulphur" from the "acetone extract, uncorrected" and report the difference as "acetone extract, corrected." (2) Subtract the "sulphur in ash" from the "ash" and report the difference as "ash, sulphur free."

(3) Subtract from the total sulphur the percentage of sulphur present as barytes, if the latter determination has been made (see par. 43), and report the difference as "total sulphur corrected." Then add the sulphur so deducted to the ash, in this case reporting the latter simply as "ash corrected." In other words, only the sulphur other than barytes will be deducted from the ash when the total sulphur is corrected for barytes.

32. Rubber as Compounded.—Rubber hydrocarbon plus 5 per cent of its weight is taken as "rubber as compounded," except when the sum of the acetone extract, corrected, chloroform extract, and alcoholic-soda extract is less than the figure represented by the arbitrary 5 per cent, as in many high-grade compounds. Rubber as compounded is then: Rubber hydrocarbon plus the sum of the acetone extract, corrected, the chloroform, and the alcoholic-soda extract.

33. Rubber by Volume.—Rubber as compounded (determined as in the preceding paragraph) is multiplied by the specific gravity of the compound and divided by 0.94 (taken as the average specific gravity of crude rubber). The result expresses the percentage of rubber by volume.

34. Ratio of Acetone Extract to Rubber.—This is calculated by dividing the percentage of the acetone extract, corrected, by the percentage of rubber as compounded, and the quotient, expressed in percentage, gives approximately the corrected acetone extract of the rubber used in the compound.

35. (b) *Procedure for the Analysis of 30 or 40 per cent Pará Insulation.*—The determinations made on high-grade insulation compounds are acetone extract, unsaponifiable matter, waxy hydrocarbons, free sulphur, ash, and total sulphur.

36. Acetone Extract.—Determine as under paragraph 22.

37. Unsaponifiable Matter.—Add to the acetone extract (see par. 36) 50 cc of normal alcoholic potash (see par. 14), heat on the steam bath under a reflux condenser for two hours, remove the condenser, and evaporate to dryness. Transfer to a separatory funnel, using about 100 cc of water, add 25 cc of ether, and shake. Allow the two layers to separate thoroughly, then draw off the water layer. Continue the extraction of the water layer with fresh portions of ether until no more unsaponifiable matter is removed, unite the ethereal layers, and wash with distilled water, adding the first wash water to the extracted aqueous layer. This aqueous solution is reserved for the free-sulphur determination. (See par. 39.) Transfer the ether to a tared Erlenmeyer flask (it will be

found convenient to use the flask in which the acetone extract was weighed), distil off the ether, dry one-half hour at 90 to 95° C, cool, and weigh.

38. Waxy Hydrocarbons.—To the unsaponifiable matter (see par. 37) add 50 cc of absolute alcohol and heat on the steam bath for one-half hour. Place the flask in a mixture of ice and salt and let stand for one hour. Filter off the separated waxy hydrocarbons, using filter paper and applying a gentle suction. Wash with alcohol (95 per cent will do) which has been cooled in an ice-salt mixture. The funnel should be surrounded by a freezing mixture in order that the temperature may not rise during filtration. Dissolve the precipitate from the filter paper with hot chloroform and catch the solution in a weighed 100 to 150 cc beaker. Wash the flask with hot chloroform, which is added to the same beaker, in order to include any waxy matter adhering to the walls of the flask. Evaporate off the solvent, dry the residue at 90 to 95° C, cool, and weigh.

39. Free Sulphur.—Transfer the water layer (see par. 37) to a 250-cc beaker and heat on the steam bath until the ether has been removed. Add 25 cc of bromine water, heat one hour, add 5 cc of concentrated hydrochloric acid, and heat until the excess of bromine has been driven off. (Test for acidity with congo paper; the amount of acid specified is sufficient if instructions are followed exactly; a large excess of acid is to be avoided.) Filter into a 250-cc beaker, add 10 cc of hot 10 per cent barium-chloride solution, and finish the determination as under paragraph 25.

40. Ash.—Proceed as under paragraphs 28 and 29.

41. Total Sulphur.—Proceed as under paragraph 26.

42. Calculations.—(1) Subtract the sum of the free sulphur and waxy hydrocarbons from the acetone extract, uncorrected, and report the difference as "acetone extract, corrected." (2) Subtract from 100 per cent the sum of the acetone extract, corrected, waxy hydrocarbons, ash—sulphur free, and total sulphur—and report the result as "rubber by difference." (3) Calculate the "rubber as compounded" as under paragraph 32. (4) Calculate the "ratio of the acetone extract to rubber" as under paragraph 34.

43. (c) *Special Determinations.*—Barytes.—The barytes is calculated from the barium in the ash; this is determined as follows: Filter off the insoluble matter after the fusion and extraction in paragraph 29, wash back into the original beaker with hot water. Dissolve the residue in the beaker and any traces on the filter paper with hydrochloric acid, and heat the solution on the steam

bath. Filter through the same filter as before and wash thoroughly with hot water. Nearly neutralize the solution with ammonium hydroxide, leaving it slightly acid. Saturate the solution with hydrogen sulphide in the cold, and when the lead sulphide has settled filter into a 400-cc beaker and wash thoroughly. The total volume should not be over 200 cc. Cover the beaker containing the filtrate, heat to boiling, and add 10 cc of hot 10 per cent sulphuric acid. Allow the precipitate to stand overnight. Filter off the barium sulphate as directed in paragraph 25. Calculate the percentage of barytes. Then calculate the percentage of sulphur in the barytes by the factor 0.1373.

44. Barium Carbonate.⁸—Barytes was determined by the calculation to barytes of all barium found in the sample. Obviously if barium carbonate is present, it must be determined in order that an undue correction will not be made. The determination is as follows: A 1-gram sample, in a porcelain boat, is placed in a combustion tube through which passes a current of carbon dioxide. The sample is ashed in the tube. After ignition and cooling in the atmosphere of carbon dioxide, the boat is removed, the residue finely ground in an agate mortar, transferred to a 250-cc beaker, and treated with 5 to 10 grams of ammonium carbonate, 15 to 20 cc of strong ammonia water, and about 50 cc of distilled water. The mixture is boiled for 20 minutes, filtered, and the precipitate thoroughly washed to remove all soluble sulphates. The residue on the filter paper is washed back into the original beaker and about 10 cc of glacial acetic acid with sufficient water to make the total volume about 100 cc is added. This is heated to boiling and filtered through the same paper as before. Hydrogen sulphide is passed into the filtrate to precipitate the lead and the solution is subsequently treated as in the determination of barytes. The final weight of barium sulphate obtained is calculated to barium carbonate.

45. Glue Detection.—About 0.5 gram of the rubber sample to be tested for the presence of glue is digested in 25 cc of freshly distilled cresol (b. p., 195° C) in a tall beaker for about 16 hours at 120° C. This is most conveniently done in a properly regulated Freas oven overnight. The cresol solution is allowed to cool, and 250 cc of petroleum ether is added slowly, with constant agitation. When this solution has settled and the supernatant liquid is clear, it is filtered through a Gooch crucible, using gentle suction. The

⁸ Tuttle, B. S. Tech. Paper No. 64.

beaker and contents and the crucible are washed thoroughly with petroleum ether, then with hot benzene. The pad is removed from the crucible, placed inside of the beaker, and digested for several minutes with boiling water. The solution is filtered through a pleated filter paper, and the filtrate is to be used for the glue test. The volume of this solution should not exceed 150 cc. After it has cooled it is poured very slowly into a concentrated solution of tannic acid. In the presence of glue a permanent cloudiness will appear at first, and finally a precipitate as more of the glue solution is added. Large percentages of glue give heavy curdy precipitates, while small quantities give a decided cloudiness. In the absence of glue no permanent precipitate or cloudiness will appear immediately in the tannic-acid solution as the liquid is added to it.

46. Glue Determination.—Extract a 2-gram sample with a mixture of 68 per cent of chlôroform and 32 per cent of acetone for six hours. Remove the solvents from the sample and transfer the latter to a 750-cc Kjeldahl flask. Add 25 to 30 cc of concentrated sulphuric acid, 10 to 12 grams of sodium sulphate, and about 1 gram of copper sulphate. Place the flask on the Kjeldahl digesting apparatus and heat gently until the first vigorous frothing ceases, then raise the heat gradually until the liquid boils. Continue the boiling until the solution becomes clear. Allow the flask to cool to 40 to 60° C (if allowed to become thoroughly cold, the solution solidifies), dilute carefully with 150 cc of water, and allow to cool. Add 100 cc of 50 per cent sodium-hydroxide solution, pouring it carefully down the side of the flask, so that it does not mix immediately with the acid solution. Add about 1 gram of granulated zinc to prevent bumping and a piece of paraffin the size of a pea to diminish frothing. Connect the flask quickly with a condenser the delivery tube of which dips into a 500-cc Erlenmeyer flask containing 50 cc of N/10 sulphuric acid diluted to about 100 cc. Shake up the Kjeldahl flask and heat gently at first, increase the flame as the danger of foaming over diminishes, and finally boil briskly until about one-half of the liquid has passed over into the receiver. Add methyl-red solution and titrate the excess acid by means of tenth-normal sodium-hydroxide solution.

Calculation:

$$\frac{100 (\text{cc H}_2\text{SO}_4 \times \text{normality} - \text{cc NaOH} \times \text{normality}) (0.014) (5.56)}{\text{weight of sample}} = \text{percentage glue.}$$

47. Rubber by Nitrosite Combustion.⁹—Preliminary extractions of a 2-gram sample are made according to the usual methods to determine the amount of acetone, chloroform, and alcoholic-potash extracts. These extractions will prove the presence or absence of mineral rubbers and oil substitutes. In the absence of both, proceed as below. If mineral rubbers are present, make a chloroform extraction; if oil substitutes, an alcoholic-potash extraction; and if both, make both extractions. In every case make these extractions after the acetone extraction and before the sample is allowed to swell in chloroform. When an alcoholic-potash extraction is made, wash the sample thoroughly with 5 per cent hydrochloric acid, hot water, and alcohol.

48. Take 0.500 to 1 gram of the finely ground sample (call this weight *W*) and extract with acetone for eight hours. Dry the residue in hydrogen (or other inert gas) for two hours at 100 °C. Place the sample in 50 to 75 cc of chloroform and allow it to swell. Pass into this until the green color which is formed persists for 30 minutes the gases formed by heating arsenic trioxide and nitric acid of specific gravity 1.30. To avoid contamination it is important that no rubber connections be used. Immerse the flask containing the rubber in cold water during the nitration. Allow the solution to stand overnight; the next day filter off the nitrosite through a Gooch crucible and wash with small quantities of chloroform. Remove the acid gases and chloroform from the flask by means of a gentle current of air. Evaporate the filtrate to dryness. Dissolve the nitrosite remaining in the flask in the Gooch crucible and in the residue from the filtrate in acetone and filter the solution through asbestos into a weight burette. The total volume should be about 100 cc. Allow this solution to stand a short time so as to permit any sediment which may form to settle out in the bottom of the weight burette. Weigh the burette before and after filling, calling the difference *N*. Draw off about 25 cc into a small Erlenmeyer flask, reweigh the burette, and call the difference *O*. Evaporate the portion drawn off to a small volume, transfer to a porcelain boat (about 14 cm long and 1 cm wide) which has been filled with alundum, and wash the flask with acetone. (It is best to make this transfer in small portions, drying the boat and contents for a few minutes between each addition.) After the final washing and drying add 1 or 2 cc of 1 per cent solution of ammonia in distilled water, and dry in an

⁹ Wesson, B. S. Tech. Paper, No. 35. See also Tuttle and Yurow, B. S. Tech. Paper, No. 145.

inert gas for one hour at 90° C. Repeat with a second portion of ammonia and dry as before. By this means all of the organic solvent will be removed.

49. Place the boat in the furnace and proceed with the combustion as usual. The furnace should be carefully tested before using. Pass the products of combustion through U-tubes or other satisfactory absorption tubes placed in the following order: *a*, *b*, *c*, potassium bichromate-sulphuric acid; *d*, powdered zinc, 20-mesh; *e*, *f*, soda lime and calcium chloride; *g*, potassium bichromate-sulphuric acid; *h*, dilute palladium-chloride solution. (Very little palladium chloride is needed. Use about 1 drop of a 10 per cent solution in 10 cc of distilled water.) Weigh *e*, *f*, and *g* before and after each combustion; refill *c* and *g* frequently from the same solution, so that the gases which enter *e* and those that leave *g* will have the same moisture content. The palladium chloride serves to detect the presence of carbon monoxide or other reducing gases; if there is any blackening, it shows incomplete oxidation. In this event, discard the results and repeat the determination.

50. The carbon dioxide will equal the algebraic sum of the differences in tubes *e*, *f*, and *g*. Call this *p*. The factor for calculating from carbon dioxide to rubber hydrocarbon is 0.309. The formula is therefore as follows: $P \times 0.309 \times N/O \times 100/W =$ percentage of rubber hydrocarbon. Correct this figure for whatever extractions were made previous to nitration.

51. Total Fillers, Uncorrected.—Extract a 0.5-gram sample with acetone for eight hours. If the extract indicates that bituminous substances are present, the sample should be further extracted with chloroform until the chloroform in the extraction bucket is colorless. Evaporate off the excess solvent from the rubber samples by heating on a steam bath for a short time, and finally remove in a vacuum desiccator the last traces of the solvent. Transfer the sample to a tared 150-cc lipped assay flask, add 25 cc of cymene, and heat on an electric hot plate or in an oven at 130 to 140° C until the rubber has completely dissolved, as shown by the fillers settling out and the supernatant liquor becoming almost clear. It has been found that the time required for complete solution varies with different cures and different compounds. As a rule, six hours is sufficient. Remove the flask, allow the solution to cool, dilute with 100 cc of petroleum ether, and allow the solution to stand overnight. Prepare a Gooch crucible with a tight pad made of asbestos which has been

treated previously with 10 per cent caustic-soda solution, concentrated hydrochloric acid, and finally water. Carefully wipe off the crucible, dry, ignite, and weigh.

For the best results it is necessary to filter slowly by means of gentle suction. Collect the filtrate in a 500-cc Erlenmeyer flask under a bell jar and set it aside for the determination of the sulphur of vulcanization. Keep as much as possible of the fillers in the assay flask. Wash with about 50 cc of petroleum ether, using about 10 cc at a time. Then wash with hot benzene, using 5 cc at a time, and finally with hot acetone. In each case the washing should be continued until the solvent comes through colorless. Care must be taken to see that the bottom of the crucible is not in contact with the rubber holder, because of the solvent action of the benzene and acetone. Carefully wipe off the sides of the flask and crucible with a cloth moistened with benzene, dry for one hour at 100° C, cool, and weigh. Subtract the weight of the empty crucible and flask and record the difference as total fillers, uncorrected.

52. Total Fillers, Corrected.—Digest the contents of the flask and crucible from the determination of total fillers, uncorrected (see par. 51), with a 25 per cent solution of sodium hydroxide for 30 minutes on the steam bath. Dilute to 60 cc with hot distilled water and heat on the steam bath. Filter through a Gooch crucible, wash twice with hot water and then very thoroughly with hot concentrated hydrochloric acid. If silicates are not present, the digestion with sodium hydroxide is unnecessary. Care must be taken in adding the first portion of acid, since in the presence of carbonates the effervescence which ensues may cause some of the fillers to be lost. It is best to add the acid a few drops at a time until the effervescence is over and then proceed with the washings in the usual way. Wash at least 10 times with boiling distilled water and transfer the contents of the flask to the crucible with the aid of a "policeman." Dry for one hour at 105° C, cool, and weigh; ignite and reweigh. In the absence of free carbon this loss in weight represents the organic matter which was left behind in the total fillers, uncorrected. (See par. 51.) In the presence of free carbon the organic matter is arrived at by subtracting the amount of free carbon from this ignition loss. Subtract the organic matter from the total fillers, uncorrected (see par. 51), and report the results as total fillers, corrected.

53. Sulphur in Total Fillers.—The total fillers, corrected, include any sulphur combined with the mineral fillers. It is thus necessary to make a correction. This is obtained by dissolving in cymene a separate 0.5-gram sample previously extracted with acetone. The solution is diluted with petroleum ether, filtered, and the residue washed as described in the determination of the total fillers. The flask and crucible are dried and the pad removed from the crucible and placed in the flask. Any fillers which adhere to the sides of the crucible are transferred by means of a swab of moistened asbestos. Then place the crucible in the mouth of the flask, wash with two 5 cc portions of nitric acid saturated with bromine (see par. 15) and finally with a fine stream of water. Cover the flask and allow it to stand in the cold 30 minutes, then on the steam bath for 30 minutes, evaporate to dryness, add 3 cc of concentrated hydrochloric acid, and repeat the evaporation to get rid of any nitrates. If a qualitative test shows that there is no barytes present in the residue from the total sulphur determination, add hot water to the residue in the flask and heat on the steam bath. Filter off the asbestos and determine the sulphate in the acidified filtrate. (See par. 25.) If barytes is found, determine the sulphur by the fusion method for total sulphur. (See par. 27.) Subtract sulphur in total fillers so obtained from total fillers, corrected (see par. 52), and report the result as total fillers, sulphur free.

54. Antimony Stocks.—The following determinations are carried out when rubber containing antimony sulphides is to be analyzed: Acetone extract (see par. 22); chloroform extract (see par. 23); alcoholic-soda extract (see par. 24); free sulphur (see par. 25); total sulphur (see par. 26); total fillers, uncorrected (see par. 51); total fillers, corrected (see par. 52); sulphur in total fillers (see par. 53); specific gravity (see par. 21). Subtract from 100 per cent the sum of the following: Acetone extract, corrected; chloroform extract; alcoholic-soda extract; total sulphur; and total fillers, sulphur free. Call the figure thus obtained rubber hydrocarbon by difference.

55. Decomposable Fillers.—When decomposable fillers are known to be present, the sample should be analyzed as outlined for antimony stocks. (See par. 54.) It may be found advisable in some cases to use the Joint Rubber Insulation Committee's procedure when analyzing stocks of this type.

56. Cork, Leather, Wood Pulp, and Vegetable Fibers:¹⁰ Samples of rubber soles, special packings, and other products for special purposes which contain the ingredients given above must be analyzed according to the procedure for total fillers. (See Par. 51.) The percentage of rubber hydrocarbon is obtained as the difference between 100 per cent and the sum of the following: Acetone extract, corrected; chloroform extract; alcoholic-soda extract; total sulphur; and total fillers, sulphur free, not corrected. The figure for rubber hydrocarbon will not be absolutely accurate because of the impossibility of correcting for the organic matter which is left behind in the total fillers, uncorrected. The error from this source is dependent upon the nature of the stock, but will usually be in the neighborhood of 1 per cent.

57. Cellulose.¹⁰—Treat a 0.5-gram sample of rubber with 25 cc of freshly distilled cresol (b. p., 198° C) on the electric hot plate for four hours at 165° C. Allow to cool and add 200 cc of petroleum ether very slowly and with constant agitation. After the solution has settled completely, filter through a Gooch crucible and wash three times with petroleum ether. Wash very thoroughly with boiling benzene and finally with acetone. Treat the contents of the flask with hot 10 per cent hydrochloric acid and transfer the entire contents to the Gooch crucible with the aid of a "policeman." Continue to treat with hot 10 per cent hydrochloric acid until the pad has been washed at least 10 times. Wash the pad free from chlorides with boiling water, and run small portions of acetone through it until the filtrate is colorless. Treat with a mixture of equal parts of acetone and carbon bisulphide in the same manner. Wash with alcohol and dry for 1 hour and 30 minutes at 105° C. Remove the pad from the crucible with the help of a pair of sharp-pointed tweezers, using the underneath portion of the pad as a swab to clean the sides of the crucible, and place all of this material in a tared weighing bottle. Replace in the drying oven for about 10 minutes, cool, and weigh. Weight of weighing bottle, pad, insoluble fillers, and cellulose—weight of weighing bottle=weight of pad, insoluble fillers, and cellulose. Transfer the contents of the weighing bottle to a 50-cc beaker and pour over it 15 cc of acetic anhydride and one-half cc of concentrated sulphuric acid and allow to digest for at least one hour on the steam bath. After the mixture has cooled thoroughly, dilute with 25 cc of 90 per cent acetic acid and filter

¹⁰ Epstein and Moore, B. S. Tech. Paper, No. 154.

through a weighed Gooch crucible. To guard against traces of the material being carried through, this filtration as well as the ones to follow must be very slow and only gentle suction can be used. Wash with hot 90 per cent acetic acid until the filtrate comes through absolutely colorless and then wash about four times more. Wash with acetone about five times. After having taken care that all of the material has been washed out of the beaker in which the acetylation took place, remove the crucible from the funnel, clean the outside thoroughly, and dry for two hours at 150° C; cool and weigh. Original weight of crucible + weight of pad, fillers, and cellulose – weight of crucible after acetylation = cellulose.

58. Total Antimony.¹¹—When a qualitative analysis indicates that antimony is present, extract a 0.5-gram sample with acetone for eight hours to remove free sulphur, rubber resins, mineral oils or waxes, and part of any bituminous substances or vulcanized oils. If the extract indicates that mineral oils or substitutes have been used, the sample must be further extracted with chloroform until the chloroform in the extraction bucket is colorless. Completely evaporate off the solvent from the rubber sample in a vacuum desiccator. Transfer the sample to a tared 150-cc lipped assay flask, add 25 cc of cymene, and heat on an electric hot plate or in an electric oven at 130 to 140° C until the rubber has completely dissolved, as shown by the fillers settling out and the supernatant liquor becoming almost clear. Remove the flask, allow the solution to cool, dilute with 100 cc of petroleum ether, and allow the solution to stand overnight. Prepare a Gooch crucible with a tight asbestos pad, using asbestos which has been previously treated with alkali, concentrated hydrochloric acid, and finally water. Carefully wipe off the crucible, dry, ignite, and weigh.

For the best success it is necessary to filter slowly by means of gentle suction. The solution is now filtered, keeping as much as possible of the fillers in the flask. Wash by decantation with petroleum ether until the filtrate is colorless. At least five washings should be made. Follow with at least five washings with boiling benzene, then with acetone, and finally with alcohol until the filtrate is colorless. Carefully wipe off the sides of the flask and crucible, dry for one hour at 100° C, cool, and weigh. Subtract the weight of the empty crucible and flask and record the difference as total fillers, uncorrected.

¹¹ Collier, Levin, and Scherrer, *Rubber Age and Tire News*, 8, 3, pp. 104-105; 1920.

Add 30 cc of concentrated hydrochloric acid to the tared assay flask and shake until all the antimony sulphide has gone into solution. Filter very slowly 5 cc of this solution at a time through the tared Gooch crucible by means of very gentle suction, and collect the filtrate in a 400 cc beaker. Then wash with boiling water and by use of a "policeman" transfer the entire contents of the flask to the crucible; set aside the Gooch crucible for the determination of the total fillers. (For the determination of total fillers, corrected, follow paragraph 52.) Dilute the filtrate in the beaker to about 250 cc with hot distilled water and pass in hydrogen sulphide until the antimony has been completely precipitated. The antimony may be determined by either of the following methods:

(1) Filter off the antimony sulphide and test the filtrate to see if the precipitation was complete. Wash the precipitate with hydrogen-sulphide water and transfer the precipitate to the filter paper. It is frequently difficult to entirely transfer the antimony sulphide to the filter paper, in which case place 20 cc of concentrated hydrochloric acid in the beaker and set aside temporarily. Transfer the antimony sulphide and the filter paper to a Kjeldahl flask, add 12 to 15 cc of concentrated sulphuric acid, add 5 grams of potassium sulphate, place a funnel in the neck of the flask, and heat until the solution becomes colorless. Wash the funnel and dilute the solution to about 100 cc with water, add 1 to 2 grams of sodium sulphite, transfer the hydrochloric acid in the beaker in which antimony sulphide was precipitated to the Kjeldahl flask, and boil until the sulphur dioxide is all driven out. This may be determined by the use of starch-iodate paper. Dilute to 250 to 275 cc with distilled water, cool to 10 to 15° C, and titrate with permanganate solution until a faint pink color is obtained.

(2) With the aid of a Witt plate prepare a suitable asbestos pad in the bottom of a carbon funnel, filter, and wash as described under (1). Transfer the plate, pad, and precipitate to a 600 cc Erlenmeyer flask by means of a glass rod pushed up through the stem of the funnel. Remove any precipitate adhering to the original beaker or to the funnel by washing with the hydrochloric acid. Wash the beaker and funnel with hot distilled water, dilute the solution to 250 to 275 cc with distilled water, add 12 cc of concentrated sulphuric acid, boil the solution until no test for hydrogen sulphide is obtained with lead acetate paper, cool to

10 to 15° C, and titrate against the standard permanganate as above.

59. Ash Analysis.¹²—The results of ash analysis give only an indication of the fillers that were used, since we can determine only the metallic elements with any degree of certainty, the acid radicals of the compounds having undergone at least partial decomposition. It is recommended when accurate information as to the acid radicals is desired and when antimony and lead are to be determined that the total fillers, uncorrected (see par. 51), be analyzed. The more or less general procedure for ash analysis is as follows: Digest the ash in a casserole with concentrated hydrochloric acid for one-half hour. Dilute with water, filter off the insoluble residue, and set the filtrate aside. Fuse the residue with five parts of sodium carbonate, and add the above filtrate to the fused mass. Then, if necessary, add sufficient hydrochloric acid to make the solution acid. Evaporate the solution to dryness in an evaporating dish, cool, drench with concentrated hydrochloric acid, add 10 cc of water, and digest on the steam bath for 10 minutes. Filter, wash the precipitate with water, and evaporate the filtrate to dryness on the steam bath, extract with hydrochloric acid as above, but with the allowance of only a few minutes, and filter the solution once more through a second and smaller filter. Slowly dry the two papers and their contents, char, and ignite in platinum, finally over the blast for 10 minutes, cool, and weigh. Treat the residue with hydrofluoric acid and a few drops of concentrated sulphuric acid, carefully heat, and finally ignite, cool, and weigh. The loss represents the silica. Analyze the filtrate from the silica in the usual manner, precipitating first with hydrogen sulphide in slightly acid solution, with ammonia in the presence of an excess of ammonium chloride, with ammonium sulphide, with ammonium carbonate, and finally with disodium hydrogen phosphate. The procedure for analyzing the precipitates obtained with these reagents can be found in any good book on quantitative analysis.

(d) *Joint Rubber Insulation Committee Method*¹³

60. Acetone Extract.—Determine as under paragraph 22.

61. Unsaponifiable Material.—Determine as under paragraph 37.

62. Hydrocarbons, A.—Determine as under paragraph 38.

¹² The analysis of silicate and carbonate rocks, by W. F. Hillebrand, Bulletin 700, U. S. Geological Survey.

¹³ Report of the Joint Rubber Insulation Committee, April, 1917.

63. Hydrocarbons, B.—Evaporate the alcohol from the flask containing the alcohol-soluble unsaponifiable material (see par. 61) and 25 cc of carbon tetrachloride and transfer to a separatory funnel. Shake with concentrated sulphuric acid, drain off the discolored acid, and repeat with fresh portions of acid until there is no longer any discoloration. After drawing off all the acid, wash the carbon-tetrachloride solution with repeated portions of water until all traces of acid are removed. Transfer the carbon-tetrachloride solution to a weighed flask, evaporate off the solvent, and dry the flask to constant weight at 95 to 100° C. Cool in a desiccator and weigh.

64. Free Sulphur.—Determine as under paragraph 39.

65. Chloroform Extract.—Determine as under paragraph 23.

66. Alcoholic Soda Extract.—Determine as under paragraph 24.

67. Rubber Hydrocarbons.—To the flask containing the rubber residue from the alcoholic-potash extraction add 25 cc of concentrated hydrochloric acid and sufficient water to make the total volume 150 cc. Heat for one hour at about 100° C, decant the supernatant liquid through a hardened filter paper on a Büchner funnel about 7 cm in diameter, using suction. Wash the residue with 25 cc of hot water and decant. Repeat twice this treatment with water and hydrochloric acid. The rubber should then be white and free from dark specks of undissolved fillers. Add 150 cc of hot water to the flask, heat for 15 to 30 minutes, and decant; repeat this procedure until the filtrate is free from chlorides. Bring all the rubber on the filter paper and suck as dry as possible. Add 25 cc of 95 per cent alcohol to displace any water adhering to the rubber and again suck dry. Transfer the rubber to a tared weighing bottle, dry for one hour at 95 to 100° C, cool in a vacuum desiccator under reduced pressure, and weigh. Repeat the drying for one-half hour periods until constant weight is attained. Call this weight *B*.

68. Take 0.5000 of *B*, calling this *C*, ignite in a porcelain crucible, and when cool weigh the ash, calling this weight *D*.

69. Determine the sulphur in *D* as follows: Add to the residue in the crucible about 10 cc of concentrated nitric acid saturated with bromine, cover with a watch glass, and heat on the steam bath for 15 to 30 minutes. Remove the cover and evaporate to dryness. Add about 2 cc of water and 5 grams of 1:1 potassium nitrate and sodium carbonate. Dry in an oven or on a steam bath and then fuse until all organic matter has been destroyed. When cool, place the crucible in a beaker, cover with about 250 cc of water,

and heat until the melt is dissolved. Filter off from insoluble matter and wash thoroughly. Add 7 to 8 cc of concentrated hydrochloric acid, cover, and heat to boiling. Test for acidity with congo-red paper. Add slowly a slight excess of hot 10 per cent barium-chloride solution. Allow to stand overnight, filter, wash, ignite, weigh the barium sulphate, and calculate to sulphur. (Call this weight *E*.)

70. Take a second portion of 0.5000 gram of *B* (call this *F*) and determine the sulphur (call this *G*) by the same method as prescribed for determining the sulphur in *D*.

71. The weight originally taken for the acetone-extract determination (that is, the two 2-gram portions) shall be called *A*.

72. The rubber hydrocarbons are calculated, using the following formula :

$$100 \frac{B}{A} \left(1 - \frac{G}{F} - \frac{D-E}{C} \right)$$

73. Total sulphur.—Determine as under paragraph 26.

74. Specific Gravity.—Determine as under paragraph 21.

75. Interpretation of Results.—The rubber shall be considered to be the sum of the rubber hydrocarbons, saponifiable acetone extract, unsaponifiable resins, chloroform, and alcoholic-potash extracts, expressed as percentages. If the chloroform extract is over 3 per cent of the rubber so calculated, subtract the excess from the rubber. If the alcoholic potash extract is over 1.8 per cent of the rubber as first calculated, subtract this excess also from the rubber.

76. Statement of Results.—The results of the analysis shall be stated in the following form :

	Per cent
Acetone extract.	
Saponifiable acetone extract.	
Unsaponifiable resins.	
Waxy hydrocarbons.	
Free sulphur.	
Chloroform extract.	
Alcoholic-potash extract.	
Total sulphur.	
Carbon.	
Rubber.	
Color of acetone extract (60 cc volume).	
Fluorescence in acetone extract solution (present or absent).	
Hydrocarbons A (consistency and color).	
Hydrocarbons B (solid or liquid).	
Color of chloroform extract (60 cc volume).	
Specific gravity.	

77. (e) *Notes.*—In the event of any determination not falling within the limits given in the specifications, a check test should be made. It is essential that no material be condemned unless the results on which the recommendation for rejection is made are established beyond reasonable doubt.

78. If the percentage of free sulphur in insulation compounds (see par. 39) is greater than that permitted by specification, the check test may be made according to paragraphs 22 and 25. The time for extraction shall be eight hours.

79. In all sulphur determinations unnecessary excess of acid should be avoided. Barium sulphate is appreciably soluble in hot acid solutions, and the amount so dissolved should be kept as small as possible. Before adding the barium-chloride solution always test for acidity with congo paper. Considerable time can be saved if the contents of the crucible is thoroughly dried in an oven at about 125° C before fusing. Care should be taken to prevent the creeping of the salts over the edge of the crucible. A qualitative test for the presence of barytes can be made on the residue left on the filter paper in the determination of the total sulphur.

80. Whenever the procedure for total fillers is used in order to determine total fillers, every solvent used must have been previously filtered, as there is considerable danger of the introduction of foreign matter from this source. Likewise in the determination of cellulose, extra precautions must be taken to be assured that all reagents are absolutely free from residue.

81. When the procedure for total fillers is followed, the combined filtrates containing cymene, petroleum ether, and benzene can be collected and distilled periodically. The first step of the distillation is carried out on steam bath. The petroleum ether will be recovered at about 50° C. The benzene is recovered as the temperature is raised. Finally the water condenser is replaced by an air condenser and the cymene is distilled out at about 175 to 185° C.

82. When cellulose is determined, the combined acetic anhydride and acetic acid filtrates should be collected and distilled periodically. The distillate can be used for washing in place of the 90 per cent acid called for in the directions. Cymene can probably be substituted for cresol, but as no work has yet been done to justify this change cresol is still used.

83. When a Gooch crucible is used for filtration, care must be taken to prepare the asbestos properly. This should always be

done as follows: The asbestos is cut fine with shears, digested with a 10 per cent caustic-soda solution, washed with water, and then digested with concentrated hydrochloric acid for a few hours on the steam bath. After it has been washed comparatively free from acid by decantation, the asbestos is shaken up with water and the resulting mixture is used in preparing the pads. The Gooch crucibles should be ignited at about 800° C and are then ready for use.

84. If it is found impracticable to run blanks on every bottle of reagents used, the danger of impurities seriously affecting the results should not be lost sight of. It will probably suffice to prepare reagents in large quantities and make tests on each fresh lot. When there is any doubt about the matter, a blank should always be run.

VI. TESTING OF FABRICS

1. NORMAL ATMOSPHERE AND MOISTURE CONTENT

All fabric tests are made under "normal atmospheric conditions;" that is, a relative humidity of 65 at a temperature of 70° F (21° C) after the test specimens have been exposed in this atmosphere.

When it is not practicable to maintain a normal atmosphere, the tests may be performed under existing humidity conditions and the results corrected to the basis of a content of 6 per cent of moisture by multiplying by the following factor:

$$\frac{100}{100 + 7 (\text{percentage of moisture} - 6)}$$

The factor will be less than unity when the per cent moisture is greater than 6, and vice versa.

The moisture content shall be determined from the tensile-test specimens. Weigh the specimens and immediately determine the tensile strength, then place the broken samples (entire) in a ventilated drying oven at 105 to 110° C (221 to 230° F) until the weight is constant. The moisture present at the time of testing shall be calculated on the basis of the dry weight.

2. WEIGHT

Three weight samples of not less than 4 square inches each shall be cut from the fabric in such a manner that they will be representative of the fabric, and exposed in "normal atmosphere" for

at least three hours and then weighed in this atmosphere. The average of the three weights shall be considered to be the weight of the fabric.

3. THREADS PER INCH

The number of threads per inch shall be determined by counting a space of not less than 1 inch in at least five different places in both the warp and the filling directions. The average of the five determinations shall be considered to be the threads per inch or thread count.

4. TENSILE STRENGTH

The tensile strength shall be determined from strips selected as follows: Starting in the center of the test sample cut three strips 6 inches long by $1\frac{1}{4}$ inches wide parallel to and in the direction of the warp and three strips parallel to and in the direction of the filling. These specimens shall be raveled until exactly 1 inch of woven fabric remains by pulling out approximately the same number of threads from each side.

An inclination balance or pendulum type of testing machine of an approved type and capacity shall be used in determining the tensile strength. The distance between the jaws or clamps of the testing machine at the beginning of the test shall be 3 inches and the jaws or clamps shall separate at a uniform rate of 12 inches per minute during the test.

For detailed information concerning the testing of textiles see this Bureau's Circular 41 and Technologic Paper No. 68.

VII. APPENDIX

1. LIST OF SPECIFICATIONS

An important part of this Bureau's work on rubber consists in the development of specifications for the various Government departments. The following list contains those specifications that have been completed:

- Recommended specifications for pneumatic tires, solid tires, and inner tubes. B. S. Circular No. 115.
- Fire hose. B. S. Circular No. 114.
- Rubber tubing.
- Rubber gloves.
- Hospital sheeting—written for the Field Medical Supply Depot, U. S. Army.
- Rubber ring cushions.
- Hot-water bottles.
- Rubber stoppers.
- Rubber jar rings—written for the States Relation Service, Department of Agriculture.

This Bureau cooperated with the War Department Committee for the Standardization of Mechanical Rubber Goods in the preparation of the following:

	War Department number
General specifications for mechanical rubber goods.....	333-1-1
Air brake and signal hose and gaskets.....	333-1-3
Gas hose.....	333-1-2
Dredging sleeves.....	333-1-4
Chemical engine hose.....	333-1-5
Diver's hose.....	333-1-6
Cotton rubber-lined fire hose.....	333-1-7
Gasoline hose.....	333-1-8
Radiator hose.....	333-1-9
Pneumatic hose.....	333-1-10
Steam hose.....	333-1-11
Suction hose.....	333-1-12
Corrugated tender hose.....	333-1-13
Water hose.....	333-1-14
Laboratory tubing.....	333-1-15
Cloth-insertion tubing.....	333-1-16
White machine rubber tubing.....	333-1-17
Cloth-insertion rubber packing.....	333-2-1
Diaphragm packing.....	333-2-2
Red sheet packing.....	333-2-3
Tuck's packing.....	333-2-4
Rubber transmission belting.....	333-3-1
Balata.....	333-3-2
Rubber valves.....	333-1-2
Bumpers.....	333-1-3
Rubber tips for flexible metallic hose.....	333-1-1

2. BIBLIOGRAPHY

This circular is concerned chiefly with the problems connected with the testing of rubber goods. There will be many who are interested in other phases of the rubber industry and for their benefit a partial list of publications is given below.

PUBLICATIONS OF THE BUREAU OF STANDARDS

Scientific Paper No. 174. The determination of total sulphur in india rubber, C. E. Waters and J. B. Tuttle. Also in *J. Ind. Eng. Chem.*, **3**, 734, 1911.

Technologic Paper No. 35. Combustion method for the direct determination of rubber, L. G. Wesson.

Technologic Paper No. 45. A study of some recent methods for the determination of total sulphur in rubber, J. B. Tuttle and A. Isaacs. Also in *J. Wash. Acad.*, **5**, 235-236, 1915; *J. Ind. Eng. Chem.*, **7**, 658-663, 1915.

Technologic Paper No. 64. Determination of barium carbonate and barium sulphate in vulcanized rubber goods, J. B. Tuttle. Also in *J. Ind. Eng. Chem.*, **8**, 324-326, 1916.

Technologic Paper No. 136. Determination of free carbon in rubber goods, A. H. Smith and S. W. Epstein. Also in *J. Ind. Eng. Chem.*, **11**, 33-36, 1919.

Technologic Paper No. 145. Direct determination of india rubber by the nitrosite method, J. B. Tuttle and Louis Yurow. Also in *India Rubber World*, **57**, 17-18, 1917.

Technologic Paper No. 162. Extraction of rubber goods, S. W. Epstein and B. L. Gonyo. *Rubber Age and Tire News*, **6**, 445-447, 1920.

Technologic Paper No. 154. Determination of cellulose in rubber goods, S. W. Epstein and R. L. Moore. Also in *Rubber Age and Tire News*, **6**, 289-293, 1920.

Technologic Paper No. 68. Standardization of automobile fabric testing, Walter S. Lewis and Charles J. Cleary.

Circular No. 41, 3d Edition. Testing of textile materials.

The sampling of rubber goods, J. B. Tuttle, *J. Ind. Eng. Chem.*, **5**, 618, 1913.

An improved extraction apparatus, T. B. Ford, *J. Am. Chem. Soc.*, **34**, 552-553, 1912.

Detection of glue in rubber goods, S. W. Epstein and W. E. Lange, *India Rubber World*, **61**, 216-217, 1920.

Determination of antimony in rubber goods, S. Collier, M. Levin, and J. A. Scherrer, *Rubber Age and Tire News*, **8**, 104-105, 1920; *India Rubber Journal*, **64**, 580, 1921; *Rubber Engineering, Production*, **2**, 6-13, 1921.

An improved method for the determination of total sulphur in rubber goods, *Rubber Age and Tire News*, **9**, 47-48, 1921.

BOOKS

The chemistry of India rubber, by Carl Otto Weber; Charles Griffin & Co. (Ltd.), London; 1902.

Rubber, by Philip Schidrowitz; Methuen & Co. (Ltd.), London; 1911.

Rubber tires, by Henry C. Pearson; The India Rubber Publishing Co., New York; 1906.

Crude rubber and compounding ingredients, by Henry C. Pearson; The India Rubber Publishing Co., New York; 1918.

India rubber laboratory practice, by W. A. Caspari; MacMillan & Co. (Ltd.), London; 1914.

Der kautschuk und seine prüfung, by F. W. Hinrichsen and K. Memmler; S. Hirzel, Leipzig; 1910.

Die analyse des kautschuks, etc., by Rudolf Ditmar; A. Hartleben, Leipzig; 1909.

The manufacture of rubber goods, by Adolf Heil and W. Esch, translation by Edward W. Lewis; Charles Griffin & Co. (Ltd.), London; 1909.

The chemistry of rubber, by B. D. Porritt; D. Van Nostrand Co., New York; 1914.

The chemistry of the rubber industry, by Harold E. Potts; Constable & Co. (Ltd.), London; 1912.

Rubber, its production, chemistry, and synthesis, by A. Dubosc and A. Luttringer; Charles Griffin & Co. (Ltd.), London; 1918.

India rubber and gutta-percha, by T. Seeligmann, G. L. Torrilhon, and H. Falconnet; Scott, Greenwood & Son, London; 1910.

Plantation rubber and testing of rubber, by G. Stafford Whitley; Longmans, Green & Co., London and New York, 1921.

Rubber manufacture, by H. E. Simmons; D. Van Nostrand Co., New York, 1921.

PERIODICALS

Devoted Solely to the Interests of the Rubber Industry

India Rubber World.

The Rubber Age and Tire News.

India Rubber Journal.

Gummi-Zeitung.

Le Caoutchouc et la Gutta Percha.

Having Abstracts or Occasional Articles on Rubber

Journal of Industrial and Engineering Chemistry.

Chemical Abstracts.

Journal of the Society of Chemical Industry.

The Analyst.

Kolloid-Zeitschrift.

3. TABLE OF SPECIFIC GRAVITIES

Materials	Minimum ¹⁴	Maximum ¹⁴	Average ¹⁵	Materials	Minimum ¹⁴	Maximum ¹⁴	Average ¹⁵
Asbestine	2.70	2.82	2.85	Magnesium carbonate	3.00	3.07	
Acetone		.797	.797	Mica	2.80	3.2	
Aluminum silicate	2.61	3.02		Ozocerite	.90	.95	
Aluminum flake	2.56	2.65		Paraffin	.869	.91	
Aniline	1.00	1.03		Paraffin oil	.90		
Antimony, red	2.87			Paraffin wax	.91		
Antimony, golden	2.57	2.90		Palm oil	.94		
Antimony, crimson	3.11	3.70		Petroleum	.89	.90	
Antimony, black	4.80			Pine tar	1.05		
Asphalt	.99			Pitch, roofer's	1.23	1.25	
Asphalt, liquid	.99			Pitch, coal tar	1.28		
Asphalt, Trinidad	1.2			Prussian blue	1.96		
Arsenic, yellow	2.75			Rosin	1.05	1.08	
Balata	1.05			Red oxide	4.82	5.16	
Barytes	4.38	4.92	4.45	Resilio	2.60		
Benzene (benzol)	1.07	1.16	.745	Rubbers:			
Bitumen	1.10			Accra flake	1.02		
Black substitute	1.10			All varieties	.95		
Brown substitute	1.07	1.32		Crepe No. 1, first latex	.913	.92	
Bone black	2.20	2.32		Amber crepe	.92	.928	
Carbon black	1.68	1.89	1.81	Roll brown crepe	.95		
Camphene	.865	.875		Caucho ball	.915	.922	
Castor oil	.958			Cameta	.916	.92	
Candelilla wax	.99			Caoutchouc	.92	.96	
Carnauba wax	.995			Assam	.967		
Ceresin	.918	.922		Borneo	.916		
Chrome green	5.24	5.44		Benguella	.928		
Chloroform	1.52		3.90-5.08	Cameroon	.929		
Carbon tetrachloride	1.61		1.60	Guayule	.975	.976	
China clay	2.2	2.6	2.62	Guayule, extracted	.995		
Cotton	1.47	1.55		Fine Pará	.915	.95	
Cork	.24	1.00		Madagascar	.915		
Cottonseed oil	.922	.93		Mozambique	.939		
Corn oil	.926	.93		Penang	.918		
Coal tar	1.05	1.27		Coarse Pará	.95		
Carbon bisulphide	1.26	1.29		Vulcanized Hevea, hard	.92		
Chrome yellow, light	6.41			Vulcanized Hevea, soft	.92		
Chrome yellow, medium	5.73	5.84		Smoked sheets	.909	.95	
Chrome yellow, deep	5.91	6.08	6.00	Sernamby	.918		
Fuller's earth	1.80	2.70		Sierra Leone	.923		
Fossil flour	2.60			Sapori	.928		
Gasoline, 72 to 75° Bé	.70	.707		Senegal	.929		
Glycerin	1.25	1.30		Singapore	.937		
Glue	1.30			West Indies Islands	.935		
Glass, powdered	2.49			Black caoutchouc	.945		
Graphite	1.95	2.32	2.36	Soapstone	2.23	2.70	
Gutta-percha	.96	1.00		Sulphur chloride	1.69	1.71	
Indian red	4.80	5.25		Sulphur	1.96	2.07	
Infusorial earth	1.66	1.95		Tripoli	1.95	2.25	
Kaolin	2.75			Thiocarbaniide	1.30		
Lampblack	1.53	1.75		Talc	2.00	2.78	2.84
Lead, blue	6.40			Ultramarine blue	2.30	2.40	2.35
Lead, red	8.17	9.00	8.80	Venetian red	1.96	2.07	3.05
Lead chromate	5.65	6.12		Vermillion	7.89	8.10	
Lead sulphate	6.08	7.7		Vaseline	.84	.945	
Lead, white	6.10	6.75	6.81	Wood pulp	1.43	1.46	
Lead, sublimed	6.20	6.30	6.41	White substitute	1.04	1.14	
Litharge	8.9	9.52	9.40	Whiting	2.60	2.72	2.71
Linseed oil	.94			Wax tailings	1.00	1.08	
Lime	2.21	2.28	932-942	Xylidine	.92	.994	
Lithopone	3.60	4.25	4.30	Yellow ochre	6.00		
Magnesia	2.16	3.65		Zinc oxide	5.38	5.60	5.66
Mineral rubbers	1.00	1.06		Zinc sulphide	3.5		
Montan wax	1.04			Zinc sulphate	3.62		
Magnesium carbonate, light	1.74			Zinc carbonate	4.42	4.45	
				Zinc, leaded	5.64		5.95

¹⁴ These results were obtained from a table compiled by H. P. Gurney, of the Boston Belting Co., who obtained them from the work of H. P. Gurney, G. H. Ellinwood, S. Collier, and H. J. Persoon, while working at different factories in the rubber industry; from Landolt-Bernstein, *Physikalisch-chemische Tabellen*; Van Nostrand's Chemical Annual; The chemistry of india rubber, by C. O. Weber; Oil analysis, by Gill; Paints, colors, oils, and varnishes, by Hurst; A. H. King, *The Chemical and Metallurgical Engineering Journal*, June, 1917, and C. S. Redfield, *The Rubber Age*, June 11, 1917.

¹⁵ Taken from "Bulking values and yields of pigments and liquids used in paint and enamel manufacture," by Henry A. Gardner and Harold C. Parkes.

4. DETERMINATION OF THE SPECIFIC GRAVITY, COST PER POUND, AND COST PER CUBIC FOOT OF A RUBBER COMPOUND

Ingredients	Weight	Specific gravity	Relative volumes	Cost
	Pounds			Dollars
Rubber.....	50.0	0.94	53.2	15.00
Zinc oxide.....	35.0	5.60	6.25	3.51
Mineral rubber.....	4.0	1.05	3.81	.12
Litharge.....	8.0	9.40	.85	1.20
Sulphur.....	3.0	2.06	1.46	.03
Totals.....	100.0	65.57	19.86

Density = $\frac{\text{Weight}}{\text{Volume}} = \frac{100.0}{65.57} = 1.525$. It is the universal practice, in the rubber industry, to call this "specific gravity."

Cost per pound = $\frac{\text{Cost}}{\text{Weight (pounds)}} = \frac{\$19.86}{100.0} = \$0.1986$.

Cost per cubic foot = cost per pound \times specific gravity of the compound \times weight per cubic foot of water = $0.1986 \times 1.525 \times 62.30 = \18.87 .



