

Ultrasonic evaluation methods applicable to polymer concrete composites

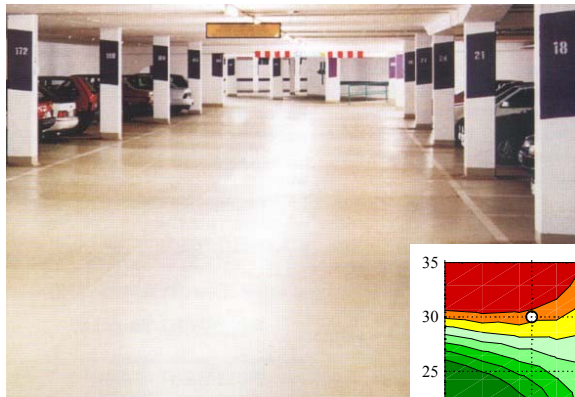

Andrzej Garbacz
Edward J. Garboczi

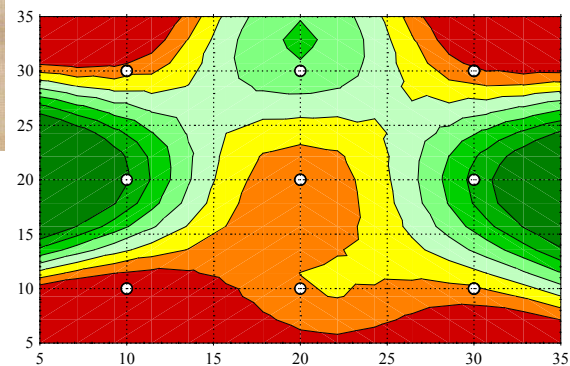

NISTIR 6975

Ultrasonic evaluation methods applicable to polymer concrete composites

Andrzej Garbacz
Warsaw University of Technology
Warsaw, Poland

Edward J. Garboczi
Materials and Construction Research Division
Building and Fire Research Laboratory

April 2003



U.S. DEPARTMENT OF COMMERCE
Donald L. Evans, Secretary
TECHNOLOGY ADMINISTRATION
Phillip J. Bond, Under Secretary of Commerce for Technology
NATIONAL INSTITUTE OF STANDARDS AND TECHNOLOGY
Arden L. Bement, Jr., Director

EXECUTIVE SUMMARY

This publication is the final report on the three-year project entitled "Ultrasonic evaluation methods applicable to polymer concrete composites." The project was sponsored by the M.Skłodowska-Curie US-Polish Joint Fund II. The project was collaboratively carried out by the National Institute of Standards and Technology (NIST), Gaithersburg, MD, USA and the Institute of Construction Engineering and Management (ICEM), Warsaw University of Technology, Warsaw, Poland. Edward J. Garboczi (NIST) and Andrzej Garbacz (ICEM, from Prof. Lech Czarnecki's Building Polymer Composites Group), were the principal investigators.

The main objective of the project was to evaluate the possibility of implementing ultrasonic methods for the nondestructive assessment of polymer composite properties. The two main fields of polymer composite applications, anticorrosion protection of concrete structures (including industrial floors) and polymer concrete pre-cast elements, were both taken into account. The possibility of nondestructive evaluation of the quality of multi-layer repair systems, including adhesion mapping, has arisen as the most interesting result of the project. The design of the experimental program was developed by the principal investigators, and was carried out at the ICEM laboratories. NIST also collaborated in the interpretation of the test results and preparation of the report.

ACKNOWLEDGEMENTS

The authors would like to thank Prof. Lech Czarnecki for inspiration, remarks and discussion during preparation of this report. Marek Łuciuk and Mikołaj Krystosiak have prepared their Master Theses during the realization of this M.Skłodowska-Curie US-Polish Joint Fund II project.

Cover: industrial epoxy concrete floor and an example of adhesion mapping of a polymer concrete on top of portland cement concrete using an ultrasonic pulse velocity method

ABSTRACT

Polymer composites (PC) appear as useful materials for repair and protection of building structures, as well as for manufacturing precast elements. In the case of pre-cast elements, as well as repair materials, the usefulness and durability of polymer composites depend on the selection of the material composition for obtaining the composite with controllable properties. This task is a material design and optimization procedure. For repairs and protective coatings, the main problem is good bonding between PC composites and concrete substrate for the length of time desired. In both cases, there is a need for quality control (verification tests) and diagnostic tests during structural service as well. This is available using destructive or semi-destructive tests. Such a way of testing, however, is expensive and of limited usability due to its destructive character. Therefore, the development of nondestructive assessment methods for polymer composites is an important need. Ultrasonic methods are among the most common nondestructive techniques used in material science and industry. Ultrasonic methods are well-known and standardized towards traditional building materials: metals, cement concrete, and rocks. In the case of polymer concrete composites, ultrasonic methods are at the introductory stage.

The results of the project confirmed the usefulness of ultrasonic methods for nondestructive evaluation of polymer concrete composites in various applications. The pulse velocity method can be used for evaluation of the properties and homogeneity of the pre-cast elements made from polymer concrete as well as for evaluation of adhesion in the multi-layer PC-CC systems (adhesion mapping). The ultrasonic echo method can be used as a complementary method for nondestructive estimation of PC layer thickness.

Results of the project are presented in this report. The appendix contains a list of the eight publications that were presented during international and domestic conferences and published in proceedings and journals. The results are in general accord with worldwide scientific and engineering activities in nondestructive quality control of repair, e.g. Guide for evaluation of concrete structures prior to rehabilitation, ACI 364.1R-94, 2001; the family of European standards 1504: Products and systems for the protection and repair of concrete structure; and activities of RILEM Technical Committees: TC-151 "Adhesion Technology in Concrete Engineering – Physical and Chemical Aspects" and TC-184 IFE "Industrial floors for withstanding harsh environmental attacks, including repair and maintenance".

TABLE OF CONTENTS

1. INTRODUCTION
2. NONDESTRUCTIVE TEST METHODS APPLICABLE TO CONCRETE-LIKE COMPOSITES
3. CHARACTERISTIC OF THE ULTRASONIC TESTING
 - 3.1. Characteristic of the ultrasonic waves
 - 3.2. Attenuation of the ultrasonic wave
 - 3.3. Methods used in the ultrasonic measurement technique
 - 3.4. Application of ultrasonic methods for the concrete testing
4. GENERAL APPROACH FOR ULTRASONIC EVALUATION OF POLYMER CONCRETE COMPOSITES
5. EVALUATION OF TECHNICAL PROPERTIES OF POLYMER CONCRETE ELEMENTS
 - 5.1. Experimental procedure
 - 5.2. Ultrasonic evaluation of selected technical properties of vinyl ester concrete
 - 5.2.1. Materials
 - 5.2.2. Results
 - 5.2.3. Relationship between microstructure and ultrasonic waves propagation
 - 5.3. Ultrasonic estimation of selected properties of epoxy concrete
 - 5.3.1. Material and results
 - 5.3.2. Discussion of results
 - 5.3.3. Analysis of relationship between microstructure and ultrasonic wave propagation
 - 5.4. Conclusions concerning ultrasonic evaluation of elements made from polymer concrete
6. ULTRASONIC EVALUATION OF MULTILAYER REPAIR SYSTEMS
 - 6.1. Approach to evaluation of multi-layer repair systems
 - 6.2. Evaluation of the multi-layer system with ultrasonic echo method
 - 6.2.1. Procedure of the ultrasonic testing
 - 6.2.2. Materials
 - 6.2.3. Determination of adhesion
 - 6.2.4. Results of testing using echo method
 - 6.2.5. Results of testing using echo method
 - 6.3. Evaluation of multi-layer system with pulse velocity method
 - 6.3.1. Ultrasonic test procedure
 - 6.3.2. Materials and testing floor systems
 - 6.3.3. Ultrasonic evaluation of adhesion at boundary conditions
 - 6.3.4. The effect of chemical composition and geometry of polymer coating
 - 6.3.5. Relationship between pull-off strength and ultrasonic parameters
 - 6.3.6. Ultrasonic detection of defects in PC-CC system
 - 6.4. Conclusions concerning the ultrasonic evaluation of the multi-layer PC-CC system
7. SUMMARY AND CONCLUSIONS
8. REFERENCES

ENCLOSURE - List of publications involved with the activity on the project

1. INTRODUCTION

Polymer composites (PC) are useful materials for repair and protection of building structures, as well as for the manufacturing of pre-cast elements. There are various fields of applications for these materials [1-4]:

- repair, maintenance and anti-corrosion protection (protective and decorative coatings) of building structures,
- flooring, mainly industrial floors, but also floors in hospital and school buildings, sport arenas and other community structures,
- polymer concrete precast elements, like manholes, pipes and slabs as well as chemical resistant vessels, e.g. electrolytic cells.

In the case of pre-cast elements and repair materials, the usefulness and durability of polymer composites depend on the selection of the material composition for obtaining composites with controllable properties. This task is a material design and optimization procedure [5,6]. For repairs and protective coatings, the main issue is good bonding between PC composites and cement concrete substrates, including the effect of time. In both cases, there is a need for quality control (verification tests) and diagnostic tests during structural service as well. This is available using destructive or semi-destructive tests, e.g. determination of compressive strength on samples cored from structure or determination of bonding with the pull-off method. Such a way of testing, however, is expensive and of limited usability due to its destructive character as well as because information obtained is only local. Therefore, the development of nondestructive assessment methods for polymer composites is an important need [7,8]. Ultrasonic methods are among the most common nondestructive techniques used in material science and industry [9,10]. Ultrasonic methods are well-known and standardized for traditional building materials, like metals [11], cement concrete [12-14], and rocks [15,16]. In the case of polymer concrete composites, ultrasonic methods are at the introductory stage [17,18].

The aim of the project was analysis of the usability of ultrasonic methods for assessment of PC properties in various applications.

2. NONDESTRUCTIVE TEST METHODS APPLICABLE TO CONCRETE-LIKE COMPOSITES

Nondestructive test (NDT) methods are commonly used for quality control of various construction elements [11]. The development of NDT methods is important from a technical and an economical point of view. Contrary to destructive methods, NDT techniques give information about material properties without deteriorating material microstructure and serviceability. The main advantages of NDT methods are: the possibility of on-site evaluation, repeatability at the same place during structural service, and quick test results.

By comparison to other construction materials like steel, the development of NDT methods for concrete-like composites has progressed at a slower pace because these kind of composites are difficult to test [10]. Concrete is heterogeneous, intrinsically conductive (because the pore solution is an ionic electrolyte), and also usually contains steel reinforcement. For these reasons, NDT techniques used with metals are not easy to implement for concrete and similar composites. Since it is difficult to apply to concrete some of the techniques used with metals, alternative NDT methods have been considered.

Recently, the development of NDT techniques applicable to concrete has become of interest. This has resulted from an increase in quality requirements for concrete in new construction. On the other hand, the percentage of repair and rehabilitation in the total building market has increased. The estimated cost of repair and rehabilitation in the US and Canada during the next 20 years is equal to $\$1 \cdot 10^{12}$ to $\$3 \cdot 10^{12}$ (USD) or about 15 % to 50 % of the total North American building market

[19]. The situation in the Polish building market is similar but is actually closer to the upper percentage limit. The evaluation of structures prior to repair, a proper selection of repair materials, and quality control of the repairs should be done to assure the effectiveness of the repair process [20]. Many institutions are involved with elaboration of repair guidelines [21,22]. This indicates the importance of repair issues. The European Standardization Committee CEN/TC104 has been working on the family of standards EN 1504 under the common title "Products and systems for the protection and repair of concrete structure." The guidelines for structural evaluation prior to the repair and quality control after repair are important part of standards [22]. In 1999, ACI Technical Committee 364 - Rehabilitation has elaborated guidelines for evaluation of concrete structures prior to rehabilitation [23]. In Poland, procedures of concrete structure evaluation are given in the Polish Standard PN-88/B-01807 "Anticorrosion protection of building structures. Concrete and reinforced concrete structures. Evaluation procedures" [24], and in the Guidelines of Building Research Institute 361/99 "Guide for evaluation of safety of reinforced concrete structures" [25]. NDT methods play an important role in evaluating concrete structure and in quality control of repair work. Recently, the RILEM Technical Committee, "Non-destructive evaluation of concrete structures," has been created. The main task of this Committee is an elaboration of the guidelines for NDT evaluation of concrete structures and the promotion of a wider use of NDT techniques in practical applications. The progress in this field has been made in the US. The review of different NDT methods applicable to concrete structures (Table 1) was given in the Report of ACI Technical Committee 228 – Non-Destructive Testing of Concrete [26], in which the capabilities, limitations and potential application of various NDT methods were presented. The ACI Reports ACI 364.1R-94 and ACI 228.2R-98 have been published together in 1999 as "The Concrete Repair Manual."

NDT methods are applied to concrete structures for four main reasons [26]:

- quality control of new structures,
- unexpected problems with new construction,
- evaluation of existing structures, including evaluation prior to repair,
- quality control of concrete repair.

In general, considering the measured parameters, NDT methods can be divided into the following categories [9,10]:

- rebound hammer,
- acoustic methods – stress wave propagation (ultrasound, acoustic emission, impact-echo, etc.),
- radiation methods (X-ray, gamma ray, neutron emission, etc.),
- electromagnetic methods,
- others – e.g. infrared thermography.

Another classification takes into account the aim of nondestructive evaluation. Two main categories can be recognized [10]:

- evaluation of concrete strength and its homogeneity (e.g. rebound hammer, ultrasonic pulse velocity),
- evaluation of structural integrity – detection of various types of defect in concrete, detection and evaluation of steel reinforcement (e.g. visual inspection, stress wave propagation, impact-echo, infrared thermography, radiation methods, electromagnetic methods).

Among various NDT techniques, ultrasonic methods, especially the ultrasonic pulse velocity method, are still commonly used for the evaluation of concrete structures.

Table 1. Nondestructive methods for evaluation of concrete structures [9,10,12,26].

<p>Rebound hammer</p> <p>Scheme of method:</p>  <p>Principle: Measurement of rebound height after striking concrete surface with spring loaded hammer; correlation between rebound number and compressive strength is determined</p>	<p>Example of application:</p> <ul style="list-style-type: none"> - evaluation of homogeneity or consistency of compressive strength of concrete structure, - monitoring strength gain <p>Limitations:</p> <ul style="list-style-type: none"> - evaluation of near-surface properties only, - results depend on surface roughness, - reference curve needed for strength estimation, - rebound number affected by the orientation of the apparatus,
<p>Ultrasonic pulse velocity, UP-V</p> <p>Scheme of method:</p>  <p>Principle: Measurement of a travel time of ultrasonic P wave, over a known path length, calculation of pulse velocity in concrete, regression analysis of relationship between pulse velocity and concrete properties (mainly compressive strength)</p>	<p>Example of application:</p> <ul style="list-style-type: none"> - evaluation of degree of homogeneity of concrete structures, - monitoring strength gain, - determination of dynamic Young modulus if Poisson's ratio and mass density is known, - estimation of concrete strength, - complementary to other tests , <p>Limitations:</p> <ul style="list-style-type: none"> - needs coupling agent, - reference curve needed for strength estimation, - measurements with the transducers at the same side of sample difficult to interpret
<p>Ultrasonic pulse echo, UP-E</p> <p>Scheme of method:</p>  <p>Principle: Propagation of a short pulse of ultrasonic wave; measurement of travel time to boundaries separating materials with different densities and elastic properties; by knowing the wave speed the distance to the reflecting interface is detected</p>	<p>Example of application:</p> <ul style="list-style-type: none"> - method developed to detect delamination, discontinuities, and small cracks, - measurements of slab thickness, - monitoring of polymer adhesive curing, <p>Limitations:</p> <ul style="list-style-type: none"> - needs coupling agent, - heterogeneous nature of concrete and of reinforcement presence result in multitude of echoes, - difficult interpretation of results, - relatively large "null-zone"

Table 1. (cont'd)

<p>Impact-Echo, IE</p>		<p>Example of application:</p>
<p>Scheme of method:</p>  <p>The diagram shows a cross-section of a concrete slab. An impact is applied to the top surface, creating a stress wave that travels downwards. A sensor is positioned on the top surface to detect the wave. The wave reflects off the bottom surface of the slab, creating an echo. The interaction of the incident and reflected waves creates a standing wave pattern within the slab.</p>	<ul style="list-style-type: none"> - defect detection in concrete slabs, like delamination, flaws, large cracks, honeycombing, debonding - measurements of concrete slab thickness, - evaluation of the quality of the bond between overlay and base concrete, - estimation of depth of surface-opening cracks, including water-filled ones 	
<p>Principle: Development of echo method; mechanical, high energy impact used to generate the stress wave; high penetration of concrete, mainly by P wave; frequency analysis of recorded waveform using the fast Fourier transform</p>	<p>Limitations:</p> <ul style="list-style-type: none"> - detection of large defects, relatively deeply located - needs expert for interpretation of results, 	
<p>Spectral Analysis of Surface Waves, SASW</p>		<p>Example of application:</p>
<p>Scheme of method:</p>  <p>The diagram shows a cross-section of a layered concrete slab. An impact is applied to the top surface, generating Rayleigh waves (R waves) that travel along the surface. Two sensors are placed on the top surface to measure the waves. The waves travel through the different layers of the slab, reflecting and refracting at the interfaces.</p>	<ul style="list-style-type: none"> - determination of the stiffness profiles of flexible pavements, - measurement of changes in elastic properties of concrete slabs during curing, - estimate thickness of layers 	
<p>Principle: Analysis of the spectrum of the disperse generalized Rayleigh surface wave in a layered system; the received signal is analyzed to obtain the dependence of phase velocity on the frequency</p>	<p>Limitations:</p> <ul style="list-style-type: none"> - necessity of comparison of the theoretical and experimental dispersion curves - time consuming procedure, - difficulties in interpretation of the results, - requires Poisson's ratio 	
<p>Ground-Penetrating Radar, GPR</p>		<p>Example of application:</p>
<p>Scheme of method:</p>  <p>The diagram shows a cross-section of a layered concrete slab. A sensor is positioned on the top surface, emitting electromagnetic waves downwards. The waves travel through the different layers of the slab, reflecting and refracting at the interfaces. The reflected waves are captured by the sensor and processed to create a waterplot.</p>	<ul style="list-style-type: none"> - delamination detection, - locating reinforcing bars in structures, - measurement of pavement thickness, - measurements of water content of fresh concrete 	
<p>Principle: Non-contact method; method analogous to UP-E techniques, except that pulses of electromagnetic waves are used instead of stress waves, results are registered as a waterplot</p>	<p>Limitations:</p> <ul style="list-style-type: none"> - improper estimation of relative dielectric constant resulted in large error, - needs expert for interpretation of results, - results depends on in-situ conditions: presence of moisture and chlorides in concrete, - expensive equipment 	

Table 1. (cont'd.)

Infrared Thermography , IT	
<p>Scheme of method:</p>  <p>Principle: Measurement of surface temperature differences – thermographic image</p>	<p>Example of application:</p> <ul style="list-style-type: none"> - locating near-surface defects, like delamination and flaws, - short-time period for scanning large surface areas <p>Limitations:</p> <ul style="list-style-type: none"> - needs expert for interpretation of results, - results depends on in-situ conditions (surface quality, wind speed and ambient temperature)
Electro-magnetic (covermeters)	
<p>Scheme of method:</p>  <p>Principle: Interaction between the steel reinforcement and low-frequency electromagnetic fields; two principles are used: magnetic reluctance and eddy currents</p>	<p>Example of application:</p> <ul style="list-style-type: none"> - evaluation of concrete quality (moisture content) - detection of steel bars in concrete, - evaluation of concrete cover around steel bars <p>Limitations:</p> <ul style="list-style-type: none"> - method sensitive to concrete substrate quality (dielectric constant depends on the concrete moisture) - results difficult to interpret
Radioactive (radiometric, radiographic)	
<p>Scheme of method:</p>  <p>Principle: High-energy electromagnetic radiation (X-ray, gamma, neutron); concrete evaluation on the base of changes in detected intensity of radiation; two types of methods according to type of sensor: radiometric (detector) and radiographic (photographic film)</p>	<p>Example of application:</p> <ul style="list-style-type: none"> - detection of steel bars, - detection of defects inside concrete, - detection of low density regions <p>Limitations:</p> <ul style="list-style-type: none"> - limited thickness of tested elements (< 500 mm) - very expensive, - safety training and licensing personnel required

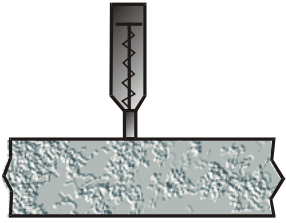
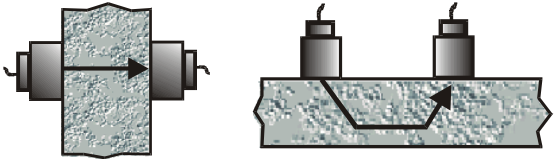
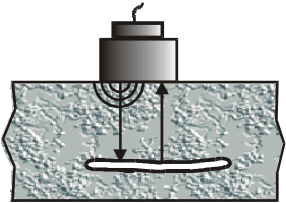
3. CHARACTERISTICS OF ULTRASONIC TESTING

3.1. Characteristics of ultrasonic waves

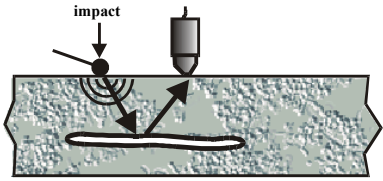
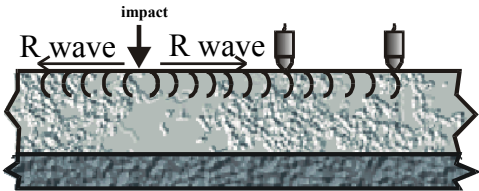
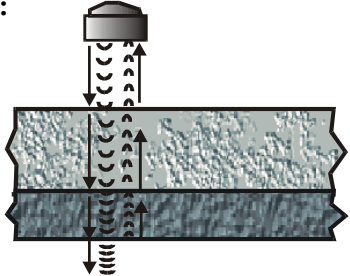
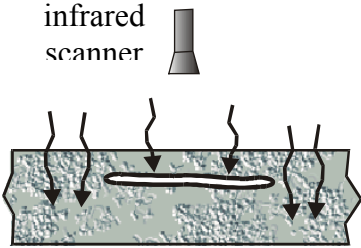
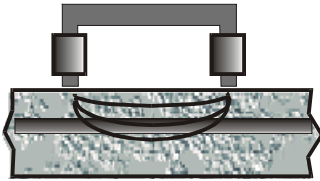
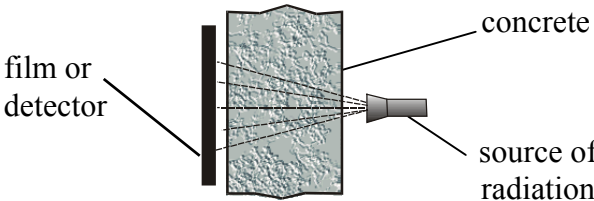
Ultrasonic waves are generally defined as a phenomenon consisting of the wave transmission of a vibratory movement of a medium with above-audible frequency (above 20 kHz). Ultrasonic waves are considered to be elastic waves. Ultrasonic waves are used in two main fields of materials testing:

- ultrasonic flaw detection (detection and characterization of internal defects in a material),
- ultrasonic measurement of the thickness and mechanical properties of a solid (stresses, toughness, elasticity constants), and analysis of liquid properties.

In all the above listed applications of ultrasound, the vibrations of the medium can be described by a sinusoidal wave of small amplitude. This type of vibration can be described using the wave equation:

$$\frac{\partial^2 a}{\partial t^2} = c^2 \cdot \frac{\partial^2 a}{\partial x^2} \quad 1)$$

where: a = instantaneous deflection in m; t = time in s; c = wave propagation velocity in m/s;
 x = position coordinate (path) in m.

The vibrations of the medium are characterized by the following parameters:

- acoustic velocity, v = velocity of vibration of the material particles around the position of equilibrium:

$$v = \frac{da}{dt} = \omega A \cos(\omega t - \varphi) \quad 2)$$

where: a , t are as above; $\omega = 2\pi f$, the angular frequency in rad/s; A = amplitude of deviation from the position of equilibrium in m; φ = angular phase or deviation, at which the vibrating particle reaches the momentary value of the deviation from position of equilibrium, in rad,

- wave period, T = time after which the instantaneous values are repeated,
- wave frequency, f = inverse of the wave period: $f = 1/T$ in Hz,
- wave length, λ = the minimum length between two consecutive vibrating particles of the same phase:

$$\lambda = c \cdot T = \frac{c}{f} \quad 3)$$

In a medium without boundaries, ultrasonic waves are propagated spatially from their source. Neighboring material, vibrating in the same phase, forms the wave surface. The following types of waves are distinguished depending on the shape of the wave front (Fig. 1):

- plane wave – the wave surface is perpendicular to the direction of the wave propagation,
- cylindrical wave – the wave surfaces are coaxial cylinders and the source of the waves is a straight line or a cylinder,
- spherical waves – the wave surfaces are concentric spherical surfaces; the waves are induced by a small size (point) source; deflection of the particle is decreased proportionally to its distance from the source. For large distances from the source, a spherical wave is transformed into a plane wave.

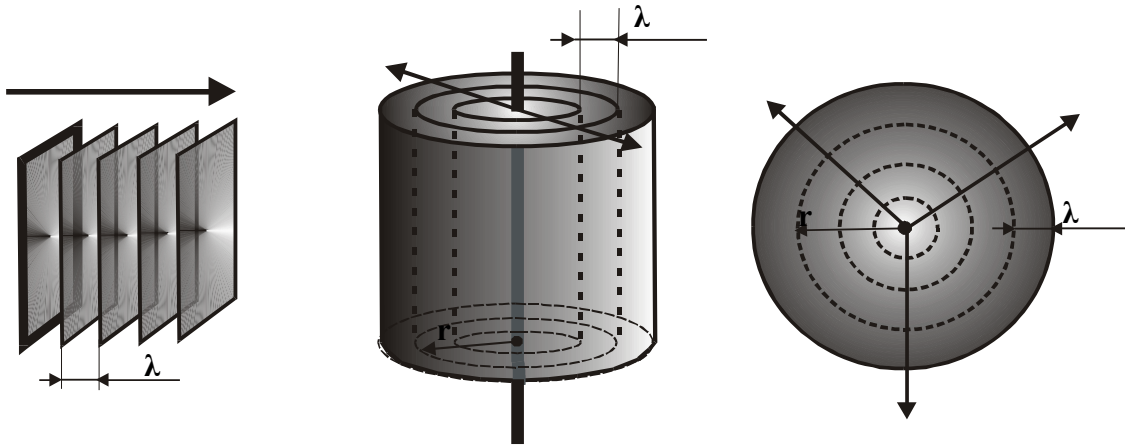

Figure 1. Forms of the wave surface: a) plane wave, b) cylindrical wave, c) spherical wave



Ultrasonic waves differ in the direction of the medium vibration in relation to the wave propagation direction. Three main types of ultrasonic waves are distinguished (see Table 2):

- longitudinal waves: the medium vibrates in rectilinear way, in the direction of the ultrasonic wave propagation,
- transverse wave: the medium particles vibrate only in a direction perpendicular to the direction of wave propagation,
- surface waves (Rayleigh waves): the waves propagate in an interface layer with two directions of the vibrations of the particles: perpendicular and parallel to the direction of the wave propagation,
- plate waves (Lamb waves): these waves propagate in media like plates and bars, one or two dimensions of which are similar to the wave length; two forms of these waves are possible:
 - anti-symmetrical wave (torsional) – the medium particles vibrate along the transversely neutral axis and elliptical movement is done at the surface,
 - symmetrical waves (dilatation) - the medium particles vibrate along the longitudinally neutral axis and elliptical movement is done at the surface.

As it is seen from formulae above, the velocities of the longitudinal, transverse and surface waves do not depend on the frequency f . Therefore, the formulae may be applied for both continuous and impulse waves.

Impulse waves are most often used for concrete testing using the ultrasonic measurement techniques. The velocity of the impulse propagation is characterized by the group velocity, which is the velocity of propagation of the given wave amplitude, and by phase velocity, which is the velocity of propagation of the given phase. In non-dispersive media, the group velocity of the wave is equal to the phase velocity. In dispersive media, the spectrum of the impulse frequency is broadband and therefore the group and phase velocities are different and difficult to measure. In practice, wave impulse propagation is most often characterized by the velocity of the impulse front or by the velocity of the signal (velocity of the given point of the main part of the signal).

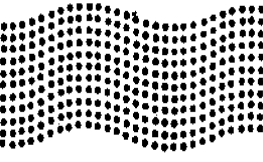
Table 2. Types of stress waves according to the direction of medium particle vibration

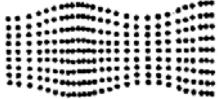
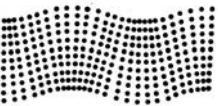
Wave type	Symbol & scheme of medium vibration	Wave velocity *	Remarks
Longitudinal (compressive)	P or L 	a) infinite medium $c_L = \sqrt{\frac{E}{\rho} \cdot \frac{1-\nu}{(1+\nu) \cdot (1-2\nu)}}$ b) bounded medium - plate: $a \gg \lambda, b \ll \lambda$ $c_L = \sqrt{\frac{E}{\rho} \cdot \frac{1}{1-\nu^2}}$ - bar: $a \gg \lambda, b \gg \lambda$ $c_L = \sqrt{\frac{E}{\rho}}$	Waves commonly used in practice. Propagation in solid, liquid and gas medium. Propagation of pure P-wave limited by medium dimensions only – should be large enough in comparison to wave length.
Transverse (shear)	S or T 	$c_T = \sqrt{\frac{G}{\rho}} = \sqrt{\frac{E}{\rho} \cdot \frac{1}{2 \cdot (1+\nu)}}$ $c_T < c_L$	Polarized waves - rotation of wave source causes changes in plane of vibration of medium particles. Propagation in solid media only, whose dimensions are significantly larger than the wave length.
Surface (Rayleigh)	R 	$c_R \approx \frac{0.87 + 1.12\nu}{1 + \nu} \cdot c_T$ $c_R \approx 0,9 \div 0,95 c_T (*?*)$	Waves penetrate medium to a depth close to the wave length; vibration in the perpendicular direction has much higher amplitude than in parallel direction.
Plate (Lamb)	Dilatation, plate wave  Torsional, plate wave 	Velocity of the Lamb waves, c_{Lamb} , depends on the wave frequency and plate thickness $c_R < c_{Lamb} < c_T.$	Influence of frequency on the Lamb wave velocity creates difficulties in application of the Lamb waves in NDT

*E - elastic modulus, Pa , G - shear modulus of elasticity, Pa, ν – Poisson's ratio, ρ – density, kg/m^3 , λ = wavelength

3.2. Attenuation of ultrasonic waves

The energy of an ultrasonic wave travelling through a medium is attenuated depending on the properties of the medium. The reasons are:

- energy absorption, which occurs in every state of matter and is caused by the intrinsic friction of the medium leading to conversion of the mechanical energy into thermal energy,
- reflection, refraction, diffraction and dispersion of the wave; this type of wave attenuation is characteristic particularly for heterogeneous media like metal polycrystals and concrete.

The weakening of the ultrasonic wave is usually characterized by the wave attenuation coefficient α [$\text{dB}\cdot\text{m}^{-1}\cdot\text{Hz}^{-1}$], which determines the change of the acoustic pressure after the wave has traveled a unitary distance through the given medium.

In solids, the loss of energy is related mainly to absorption and dispersion. The attenuation coefficient α is described by the relation:

$$\alpha = \alpha_1 + \alpha_2 \quad 4)$$

where α_1 is the attenuation coefficient that describes how mechanical energy is converted into thermal energy, and α_2 is the attenuation coefficient that describes the decrease of wave energy due to reflections and refractions in various directions.

For a majority of solids, the energy losses connected to the absorption are proportional to the ultrasonic waves frequency, so that the attenuation of longitudinal waves is greater than the attenuation of transverse waves.

In non-homogenous materials, the energy losses caused by dispersion of the ultrasonic wave are more important. The most important parameter is the material grain size D , and the relation between the wave length λ and D is given by the following formulae:

a) $\lambda \gg D$ and $0.016 < D/\lambda < 0.16$ – Rayleigh dispersion

$$\alpha \approx \alpha_1 f + \alpha_2 f^4 \quad 5)$$

where the dispersion coefficient $\alpha_2 \approx D^3$

b) $\lambda \approx D$ and $0.16 < D/\lambda < 1$ – stochastic dispersion

$$\alpha \approx \alpha_1 f + \alpha_2 f^2 \quad 6)$$

where the dispersion coefficient $\alpha_2 \approx D$

c) $\lambda < D$ – diffusion dispersion; attenuation coefficient α is defined by the previous equation and $\alpha_2 \approx 1/D$

d) $\lambda \ll D$ and $D/\lambda > 10$ - absorption of the ultrasonic wave in every grain as well as reflection on the interfacial surfaces; the average attenuation coefficient is defined by the following equation:

$$\alpha \approx \alpha_1 f + \alpha_2 f^2 + \frac{R}{D} \quad 7)$$

where R is the average reflection coefficient for the interfacial surfaces, and the dispersion coefficient $\alpha_2 \approx 1/D$. If R is low, the attenuation is low, too.

3.3. Methods used in the ultrasonic measurement technique

The most often applied methods of ultrasonic testing are the pulse velocity method, the echo method, and the resonance method. Visual and holographic methods, used for direct visualization of the ultrasonic field in the given medium, are of lesser importance.

The ultrasonic pulse velocity method (called also transmission method) is one of the oldest and simplest methods of materials testing. The method consists in the determination of the travel time, over a known path length of the longitudinal ultrasonic wave after its transmission through the tested medium (see Fig. 2). Both the emitting and receiving transducers are usually placed on the opposite sides of the tested sample (coaxially if possible). Other transducer arrangements are also used in concrete testing (Fig. 2b, c). They can be placed on the perpendicular surfaces (Fig.2b) or on the same side of the tested member (Fig.2c).

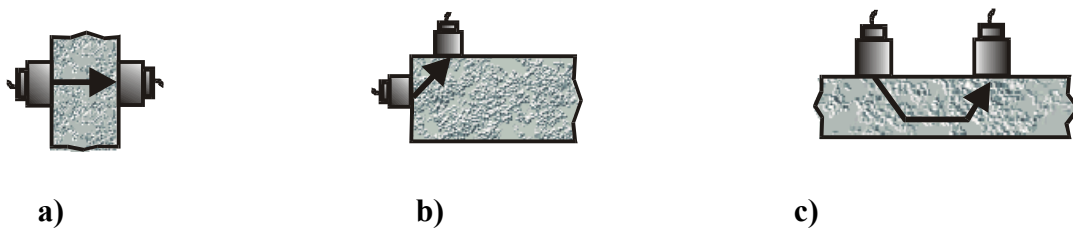

Figure 2. Ultrasonic pulse velocity method: a) direct method, b) semi-direct method, c) indirect (surface) method

The ultrasonic echo method is often used for defect detection in metal members. The method consists in generation of a short impulse of the ultrasonic wave by the transmitting transducer (Fig. 3). After reflection by the material's structural heterogeneity or by the limiting surface, the impulses are recorded by the receiving transducer (dual transmitting-receiving transducers are also available). Part of the ultrasonic wave is reflected by the material defect, returns to the receiving transducers and is recorded as the defect's echo. Another part of the wave passes by the defect and reaches the opposite wall of the tested material, where it is reflected and returns to the receiver with some delay as the bottom echo. The depth of the defect or the reflecting surface is determined on the basis of the travel time of the impulse and the ultrasonic wave velocity. A small grain size of the tested material is necessary for the echo method to be efficient. The grain size should be significantly smaller than the searched-for defects; if not, then any defect echo will be overlapped by the echoes formed by the grain boundaries.



Figure 3. Testing the concrete by ultrasonic echo method: a) transmitting-receiving transducer, b) double transducer

The resonance method consists in the introduction of an ultrasonic wave into the tested medium, which is of the constant thickness g , in such a way that a resonant standing wave, of wavelength λ , will be formed under the condition:

$$g = n \cdot \frac{\lambda}{2} = \frac{nc}{2f} \quad 8)$$

where n = an integer that defines the harmonic number.

Contrary to the echo method, in the resonance method the interference of the incident and reflected waves is observed. A continuous wave is usually emitted in this method. The demonstration of the resonance of the continuous wave requires a large area of contact of the transducer with the tested material. The transducers used usually have a diameter of about 30 mm and should be well pressed against a smooth surface of the material. The main problem is the finding of the resonance frequency for $n = 1$. The other limitation is that practical use of the method is really only possible in the laboratory, not in the field.

3.4. Application of ultrasonic methods for concrete testing

At present, two ultrasonic methods are used for concrete testing: the pulse velocity method and the echo method. These methods enable the evaluation of concrete strength and homogeneity. In a limited range, the ultrasonic pulse velocity method is also applied for determination of the elasticity constants [30,31], detection of crack geometry [30,32], evaluation of the degree of concrete degradation, e.g. deterioration due to freeze-thaw attack. The structure of concrete, as defined by the maximum aggregate size, requires low frequency ultrasonic waves, since the wave length should be larger than the grain size for minimizing losses caused by dispersion. Ultrasonic waves are diffracted by discontinuities smaller than the wave length. Assuming the pulse velocity in concrete, c_L , is 3 km/s to 5 km/s, the wave length, λ , ranges from 75 mm to 125 mm at a frequency of 40 kHz [9]. The maximum diameter of aggregate grains, D , does not usually exceed 32 mm. In this case, the ratio D/λ ranges from 0.25 to 0.41. From eqs. 5-8, it can be concluded that at least Rayleigh and stochastic dispersions occur. As frequency increases, the wave length decreases and becomes close to the grain diameter. This implies that other types of wave dispersion can occur. Therefore, the resolution in the concrete testing is worse than in the case of metals. In practice [27], frequencies from 100 kHz to 1 MHz are used for testing concrete samples or members smaller than 0.5 m. Members larger than 0.5 m require low frequencies below about 100 kHz, and are usually about 40 kHz.

The direct pulse velocity method is most often used to assess concrete structures. The indirect pulse velocity method is used rarely in specific application. Only longitudinal ultrasonic waves are used in practice, because transverse waves are difficult to generate in concrete and are strongly attenuated in this material. The pulse velocity method is used mainly for evaluation of the compressive strength vs. time as well as for evaluation of structural homogeneity.

The common procedure for evaluation of cement concrete properties with the pulse velocity method (Fig. 4) consists in regression analysis of the experimental relationship between the pulse velocity and selected technical properties (mainly compressive strength), leading to development of suitable reference curves (called also calibration curves, correlation curves or ISO-strength curves) [9,10,13]. There are many recommendations and national standards for the ultrasonic evaluation of concrete compressive strength. They define the type of reference concrete as well as the materials parameters that can be varied to develop the reference curve. Komlos et al. [14] have analyzed the standards concerning the rules for ultrasonic testing by the pulse velocity method. In general, three methods of reference curve development can be recognized:

- calibration curve developed for cube concrete specimens with the same composition and cured in the same way as the concrete in the investigated structure (Fig. 4a). The number of specimens needed to develop the curve depends on its universality = range of strength variability; as the universality of the reference curve increases, the number of samples necessary to develop it increases. To develop reference curves for a wide range of strength variability it is recommended to change the quantity of mixing water, the degree of compaction, age of the concrete, the curing or storage conditions, and if necessary, the proportion of fine material and cement content,
- calibration curve experimentally established from samples taken from the structures from zones of different pulse velocity (Fig. 4a); at least three individual transit time measurements should be carried out in each location and cores should be taken from the same location to obtain the compressive strength, the number of cores depends on the concrete volume,
- calibration curve established with inversion procedure (Fig. 4b) using the reference curve for the concrete with similar composition and specimens taken from structures (number of specimens lower than in case (b) and depends on the concrete volume - at least three). This procedure is often used in practice for structures with unknown concrete composition or high age concrete and for structures where possibility of coring is limited. To obtain a recalculated reference curve the inverse coefficient should be determined. The compressive strength is calculated from the following equation:

$$f_c^{ef} = C_i^{exp} f_c^{ref} \quad (9)$$

where: f_c^{ef} = the effective compressive strength of tested concrete, f_c^{ref} = the compressive strength determined from a reference curve on the base of the ultrasonic measurements, C_i^{exp} = the total coefficient of influence obtained from the tests on the cores.

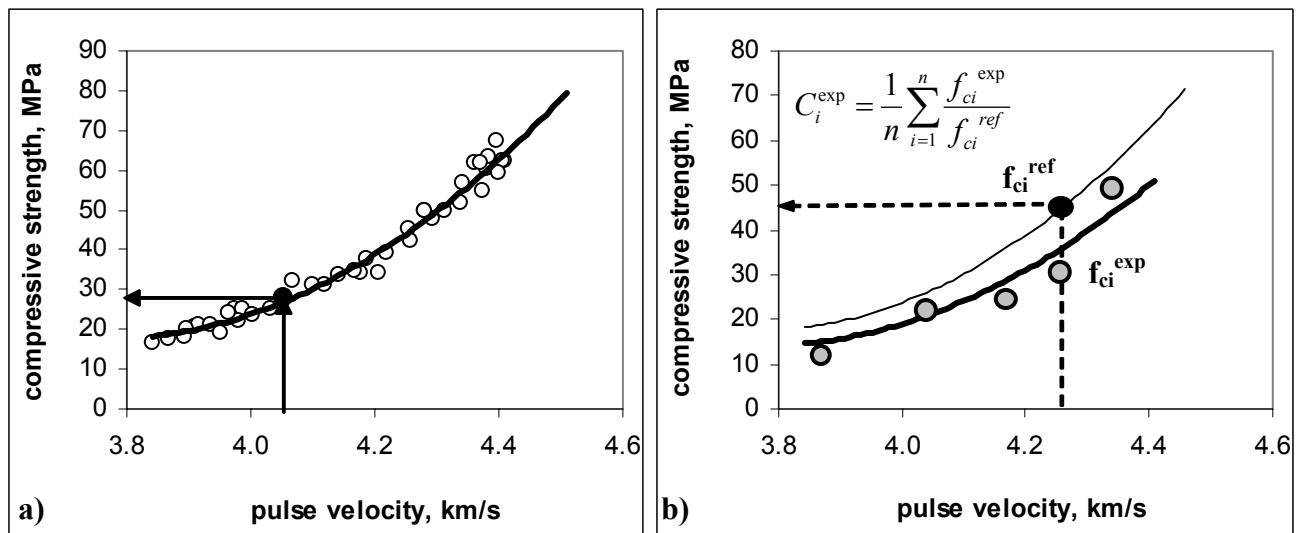

Figure 4. Scheme of reference curve development for a) ultrasonic evaluation of concrete compressive strength on the base of investigation of concrete cube samples with the same composition as that in the structure or on the basis of the investigation of cores taken from the structure; b) ultrasonic evaluation of concrete compressive strength with inverse procedure using reference curve for similar concrete, where C_i^{exp} = the coefficient of influence, $f_{c,i}^{ref}$ = the strength determined from the reference curve from the ultrasonic measurements on specimen i , $f_{c,i}^{exp}$ = the measured strength of specimen i , and n = the number of specimens tested.

Most standards and guidelines recommend two regression equations for description of the relationship between pulse velocity and concrete strength:

- linear : $f_c = a_0 + a_1 c_p$ (10)

- exponential: $f_c = a_0 \exp (a_1 c_p)$ (11)

where: f_c = compressive strength, c_p = longitudinal pulse velocity, and a_0 a_1 are regression coefficients.

However, others types are allowed:

- $f_c = a_0 + a_1 c_p + a_2 c_p^2$ (12)

- $f_c = a_0 c_p^{a_1}$ (13)

where the symbols are the same as in eq. (10)

The measure of the accuracy of strength estimation from a reference curve is the coefficient of standard deviation, C_d :

$$C_d = \left(\frac{1}{n-1} \sum_{i=1}^n \left[\frac{(f_{c,i}^{ref} - f_{c,i}^{exp})}{f_{c,i}^{exp}} \right]^2 \right)^{1/2} \times 100 \% \quad (14)$$

where: $f_{c,i}^{ref}$ = the strength determined from the reference curve from the ultrasonic measurements on specimen i , $f_{c,i}^{exp}$ = the measured strength of specimen i , and n = the number of specimens tested. If C_d is less than 12 %, the estimation of compressive strength with the ultrasonic method is considered satisfactory.

The ultrasonic pulse velocity method is commonly used for compressive strength estimation. However, many authors have stressed that various factors can affect pulse velocity and overshadow changes resulted from strength changes [10,23]. Komlos et al. [14] have also concluded that applications of longitudinal waves for concrete evaluation may be classified in the following way, according to *decreasing* precision of measurement:

- monitoring of how concrete properties change with time,
- control of homogeneity of the structure of concrete (possible disturbances of the signal from the reinforcement),
- estimation of the compressive strength (necessity of calibration),
- determination of the elasticity constants (doubtful as concrete is a heterogeneous composite),
- detection of defects – least attractive of all (possibility of obtaining faulty results with dangerous and expensive consequences).

-

They have also stressed the necessity of enhancing ultrasonic measurement techniques in the following proposed directions:

- using waves others than longitudinal, e.g. surface wave, plate waves,
- using wave parameters other than wave propagation velocity,
- using advanced methods for analysis of the ultrasonic signal.

Recently, many institutions have become focused on the improvement of ultrasonic test methods, e.g. using surface waves and advanced signal processing [35, 36]

The ultrasonic echo method is rarely used for concrete, and mainly only for flaw detection. This method gives lower resolution for concrete compared to metal testing. Impulse duration is long at a frequency of 100 kHz; this leads – in the case of the single transducer in the echo method – to a

long “dead zone”. Double transducers cannot be applied here due to the small directivity of the ultrasonic beams emitted with low frequencies and the possibility of “cross-talk” between them, as well as the reflection of the wave by the surfaces parallel to the beam axis. In the case of the testing of the concrete using the echo method, the obtained results are difficult to interpret due to the multiple echoes caused by material heterogeneity – the presence of coarse aggregate and steel reinforcement. Recently, some work on improving the echo method has been carried out, focused on using ultrasonic waves with higher frequency and a new data processing procedure, the so-called split spectrum processing [39].

The resonance method is mainly used in the laboratory for the determination of dynamic elastic moduli of concrete-like composites [18,40].

4. GENERAL APPROACH TO ULTRASONIC EVALUATION OF POLYMER CONCRETE COMPOSITES

From the engineering point of view, the nondestructive assessment of the properties of polymer composites should be developed for three main fields of PC/PCC application (Fig. 5):

- repair,
- protective coatings (including industrial floors),
- pre-cast elements.

Usually, different procedures for nondestructive evaluation should be used because of different purposes for evaluating PC materials or the systems in which they are used.

NDT evaluation of PC pre-cast elements

Due to the similarity of the geometrical features of the microstructure (Fig. 6) of both cement concrete and polymer concrete, it would seem possible that experience using ultrasonic techniques on cement concrete can be implemented into polymer composites technology for PC pre-cast elements. The ultrasonic pulse velocity can be used for this purpose. This implies that reference curves should be determined for a given type of PC (see Section 3.4). However, the differences in properties should be taken into account, especially differences in elastic properties between cement paste and resin binder, which can affect ultrasonic wave propagation in PC. Ultrasonic wave propagation depends generally on material composition and composite microstructure. In the specific case of polymer concrete composites, the ultrasonic wave propagation is influenced by: type of the binder and filler, content and grain-size distribution of the aggregate, and microfiller content and porosity. The adhesion between resin binder and aggregate is also important. For example, using a wet aggregate can result in a lack of adhesion, and by using coupling agents the adhesion can be increased [41,42].

NDT evaluation of multi-layer systems

As a result of repair and applying anti-corrosion protection to a building structure, a multi-layer system consisting of portland cement concrete (CC) in contact with polymer composite (PC) is produced. In this case, quality control of the repair application is one of the most important purposes for applying NDT methods. These are mainly focused on nondestructive estimation of the system geometry (layer thickness), and detection of flaws, voids and places with lower adhesion [43-46] at the interface zone of the repair material (PC/PCC) and the concrete substrate. Lack of adhesion can be a result of technological error, actual material incompatibility in the PC-CC system, as well as from the change of properties during the service time of the repair, which are termed durability problems.

The nondestructive evaluation of layer thickness, flaws, disbonds, and areas of poor adhesion under the top PC layer (Fig. 7) is a difficult issue and requires a careful selection of the most

suitable NDT methods. The NDT techniques selected should give a possibility for testing the PC-CC system from one side of the structure due to the specific repair system. Two ultrasonic methods can be considered for this purpose: the echo method and the indirect pulse velocity method. Figure 7 illustrates details of this method, which will be discussed in more detail later in this report.

The relation between the specific acoustic impedance of the components of the PC-CC multi-layer system is one of the most important factors influencing ultrasonic wave propagation in particular elements of the system, as well as through the internal interfaces. The heterogeneous nature of both PC and CC, including “cohesion” defects of their microstructure (like voids, porosity, cracks), and the presence of steel reinforcement can additionally complicate the nondestructive assessment of adhesion between PC and CC.

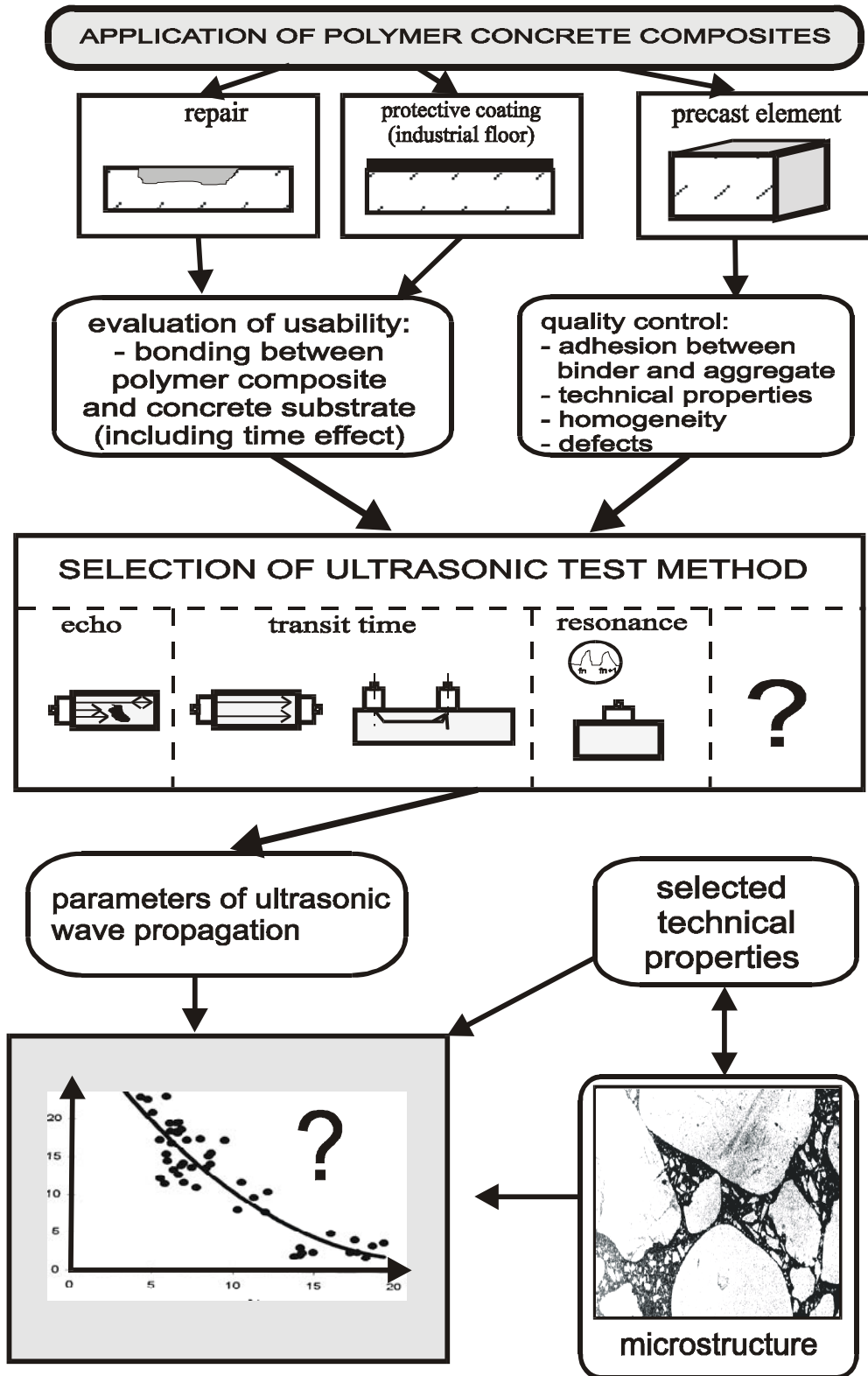

Figure 5. The general concept of the research project for the evaluation of polymer concrete composite properties in various applications using non-destructive ultrasonic methods.

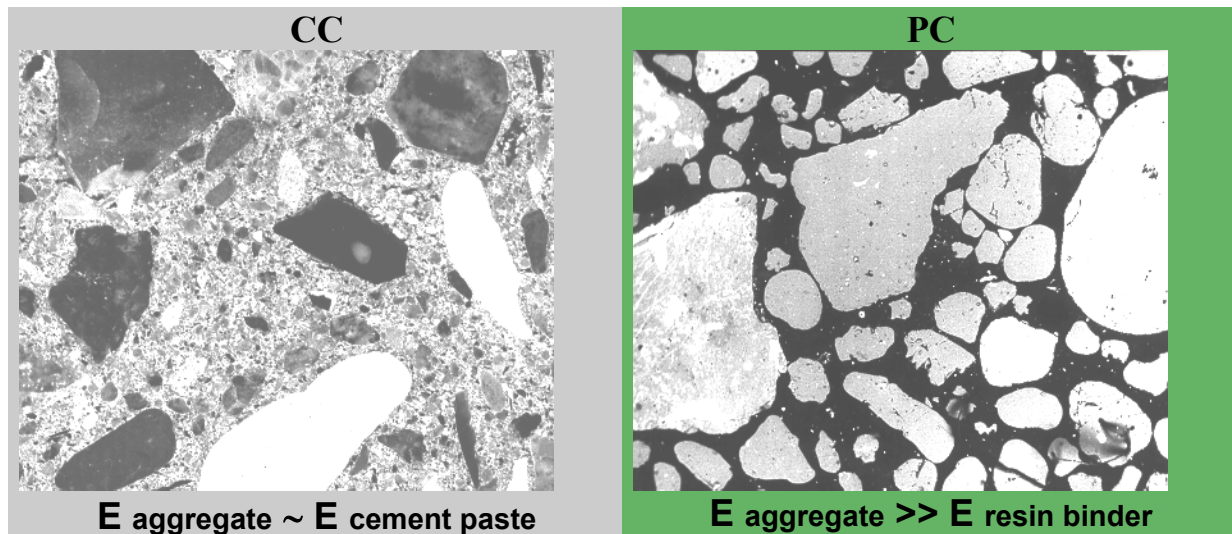
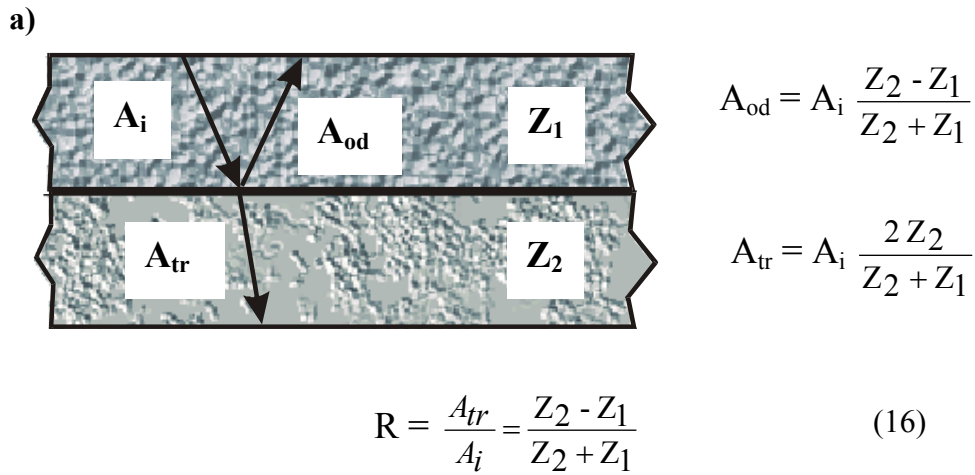

Figure 6. Example of similarity of microstructure geometry of portland cement concrete (CC) and polymer concrete (PC)

Table 3. Approximate value of specific acoustic impedance, Z , for various building materials:
 $Z = \text{density} \times \text{pulse velocity}$

Material	Density (kg/m^3)	Pulse velocity (m/s)	Specific acoustic impedance, Z ($\text{kg/m}^2\text{s}$)
Concrete	2300	3500 to 4500	$(8 \text{ to } 10) \cdot 10^6$
Mortar	2100	3500	$7 \cdot 10^6$
Air	1.2	343	0.411
Water	1000	1480	$1.5 \cdot 10^6$
Soil	1500	500 to 1500	$(1 \text{ to } 3) \cdot 10^6$
Clay	1800	1300	$2 \cdot 10^6$
Sand	1700	1500	$2 \cdot 10^6$
Timber	900	800 to 1200	$(0.7 \text{ to } 1) \cdot 10^6$
Bitumen	1200	500	$1 \cdot 10^6$
Asphalt	1900	2500	$5 \cdot 10^6$
Steel	7800	5900	$4.6 \cdot 10^7$
Granite	2700	5500 to 6100	$(15 \text{ to } 17) \cdot 10^6$



b)

Interface	Reflection coefficient R
Concrete / air	- 0.99
Concrete / water	- 0.71
Concrete / soil	- 0.63
Granite/concrete	- 0.28
Asphalt / concrete	+ 0.29
Concrete / steel	+ 0.67
Bitumen/concrete	+ 0.80

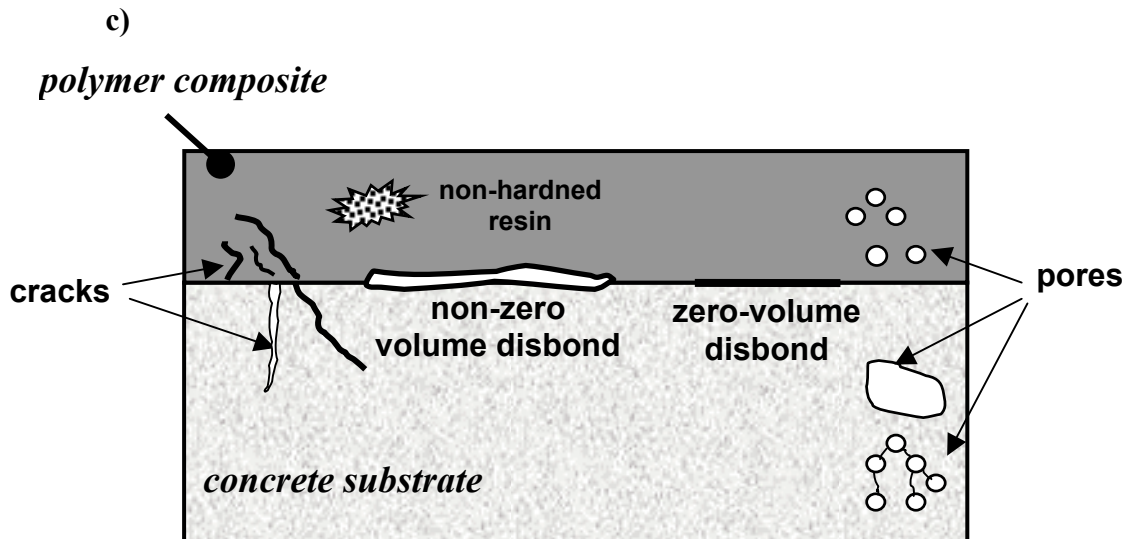

Figure 7. (a) Scheme of determination of reflection coefficient R; (b) R value for common "building interfaces"; Z_1 , Z_2 - acoustic impedance (computed from data in Table 3); (c) sketch of defects in PC-CC system

5. EVALUATION OF TECHNICAL PROPERTIES OF POLYMER CONCRETE ELEMENTS

5.1. Experimental procedure

The assessment of PC precast elements was performed according to the normal procedure for cement concretes (see Section 3.4). In this case, suitable variability of ultrasonic wave velocity and PC properties is the main issue. There are many recommendations and national standards for assessment of cement concrete structure with the pulse velocity method; however, a similar guideline does not exist for PC. On the basis of literature data, as well as the authors' experience, the resin binder content, the content of sand, the micro-filler fraction of aggregate, the porosity, and if necessary, the use of a wet aggregate, can all be varied to develop a reference curve for PC (Fig. 8). In this work, the usefulness of a material optimization approach [6] for suitable variability of PC properties was analyzed.

The surface-transmission pulse velocities in polymer concretes were measured by a commercial concrete tester, using sets of associated transducer pairs. The source pulse frequency was 100 kHz, and the distance between transducers was 80 mm. A petroleum jelly was used as a coupling agent to improve the acoustic contact between the samples and the transducers. The propagation times were measured for all PC samples before mechanical testing, with later calculation of the ultrasonic wave velocities.

The compressive strength, f_c , and flexural strength, f_b , were tested for each sample. The static modulus of elasticity (Young's modulus) was calculated from the load-deflection curve at 50 % of ultimate load. Volume density (total mass divided by total volume) and porosity, which can be treated as bulk material parameters, were determined for characterization of the PC microstructure. The porosity, p , was calculated from the formula: $p=1-(D_v/D_s)$, where the volume density, D_v , and specific density (total mass divided by pore-free volume), D_s , were measured for each sample. Additionally, the dynamic elasticity modulus (see Table 1) was estimated from the following formula: $E_d = D_v v_p^2$, where v_p = longitudinal pulse velocity and D_v = the volume density.

Beam-shaped samples (40 mm x 40 mm x 160 mm) were prepared and used for compressive and bending tests. The ultrasonic measurements and determination of mechanical properties were carried out after 14 d of PC curing.

5.2. Ultrasonic evaluation of selected technical properties of vinylester concrete

5.2.1. Materials

Introductory investigations of the ultrasonic evaluation of vinyl-ester polymer concrete properties were carried out during the preparation of a proposal for the M.Skłodowska-Curie US-PL Fund II [51-53]. An analysis of PC composition effect on ultrasonic wave propagation was one purpose of that investigation. The pulse velocity of ultrasonic waves mainly depends on the elastic properties of the constituent material, the volume density, and the geometry of the structures tested. The geometry effect can be minimized by using standard sample and test procedures. The elastic properties and density are direct results of the material microstructure. The basic elements of polymer concrete structure can be classified, in descending order of the elastic properties, as follows: filler (course aggregate), micro-filler (fine sand), resin binder, and pores (to be thought of as a filler with zero elastic properties). Some factors like the porosity, or low adhesion on an aggregate/binder interface,

can also affect the ultrasonic wave attenuation. On the other hand, increasing the filler and micro-filler content can increase the ultrasonic wave velocity.

GUIDELINES FOR ULTRASONIC ASSESSMENT OF CONCRETE-LIKE COMPOSITE PROPERTIES

Cement concrete: RILEM draft recommendation and many national standards and recommendations	Polymer concrete: None exist
---	--

TYPE OF REFERENCE CONCRETE

CC	PC (proposal)
<ul style="list-style-type: none"> ∇ type of cement ∇ cement content ∇ type (nature) of aggregate ∇ granularity of aggregate ∇ admixture type and content 	<ul style="list-style-type: none"> Δ type of resin binder Δ type (nature) of aggregate Δ binder content ⇒ aggregate to binder ratio by weight Δ granularity of aggregate Δ micro-filler type and content

MATERIAL PARAMETERS WHICH CAN BE VARIED TO DEVELOP ISO-STRENGTH CURVE

CC	PC (proposal)
<ul style="list-style-type: none"> ∇ quantity of mixing water ∇ degree of compaction ∇ age of concrete (3 - 90 days) ∇ curing or storage conditions <p>+ <i>if necessary:</i></p> <ul style="list-style-type: none"> ∇ proportion of fine material (± 8 %) ∇ cement content (± 10 %) 	<ul style="list-style-type: none"> Δ aggregate (A) and resin binder (B) - aggregate to binder ratio by weight ⇒ A/B Δ content of sand fraction of aggregate ⇒ S/A Δ micro-filler content ⇒ M/A Δ porosity <p>+ <i>if necessary:</i></p> <ul style="list-style-type: none"> Δ wet (coarse) aggregate

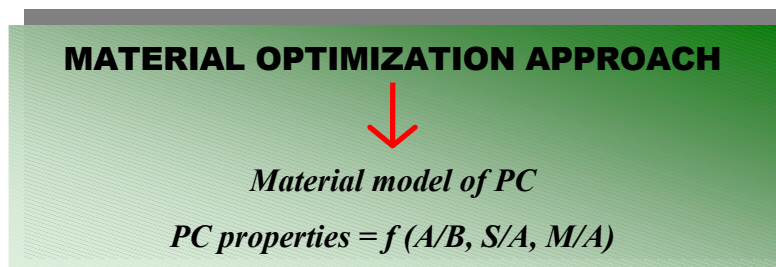

Figure 8. Research approach to evaluation of PC precast element properties

In the present work, eight types of model polymer concretes, differing in structure, were tested. A commercial vinyl-ester resin with low viscosity was used as the binder. A natural multi-size fraction quartz aggregate with grain sizes ranging from 0 mm to 8 mm, was used as the filler. A silica flour (>90 % SiO₂) with a high specific surface area (1800 m²/kg to 2000 m²/kg) was used as the micro-filler. On the basis of previous investigation of various vinyl-ester concretes, the aggregate (A) to resin binder (B) ratio, A/B (by mass), was equal to 8 for the polymer concretes tested. The following eight types of polymer concrete, differing in aggregate composition, were investigated. Each composite used a different size range of aggregates. The table below shows the size fraction of the quartz aggregates used in each material, which were labeled A-H. For composites D-H, the amounts of different aggregates shown are by mass.

• single-fraction composites:

- A: size fraction 0 mm to 2 mm,
- B: size fraction 2 mm to 4 mm,
- C: size fraction 4 mm to 8 mm,

• multi-fraction composites (Fig. 9):

- D: 1/3 (0 to 2) mm + 1/3 (2 to 4) mm + 1/3 (4 to 8) mm,
- E: 50 % (0 to 2) mm + 50 % (2 to 4) mm,
- F: 48 % (0 to 2) mm + 48 % (2 to 4) mm + 4 % silica flour,
- G: 46 % (0 to 2) mm + 46 % (2 to 4) mm + 8 % silica flour,
- H: 44 % (0 to 2) mm + 44 % (2 to 4) mm + 12 % silica flour.

The composition of the PC of types F-H was selected on the basis of the non-continuous sieve curve method, with silica flour included as the micro-filler. Composite E served as the reference composition for composites F-H. The particular types of composite differed in structure. Due to the low workability of the polymer concrete mix when high contents of micro-filler were present, the samples of composite H were characterized by a high irregularity in the micro-filler distribution. The relationship between ultrasonic pulse velocity and mechanical properties for a vinyl-ester concrete, which was representative of industrial precast elements (see Fig. 9f), was analyzed. In this case, the aggregate to resin binder ratio was $A/B = 10$ (by mass). Quartz aggregate with a grain size ranging from 0 mm to 5 mm (using a continuous sieve curve) was used, with silica flour used as the micro-filler. The basic differences between the model and industrial vinyl-ester concrete samples were the grain size distribution of the aggregate and the type of vinyl-ester binder. Six rectangular-shaped samples, 40 mm x 40 mm x 160 mm, were prepared for each type of composite.

5.2.2. Results

Ultrasonic testing with the indirect pulse velocity method on the rectangular samples was compared to tests of ultrasonic wave propagation with the direct method was carried out for representative sample of each vinyl-ester concrete type. The results of these tests showed that the pulse velocity measured with both methods was practically the same, with a ratio of 1.00 ± 0.02 for both the model and the industrial vinyl-ester concretes. This confirmed the usefulness of the indirect pulse velocity method for evaluation of PC properties.

The results of measurements of the parameters of ultrasonic wave propagation (see Table 4) indicated that the propagation time was characterized by a low coefficient of variation C_T , ranging from a low of 0.9 % for composite F to a high of 6.2 % for composite C. The high value of the coefficient of variation for the amplitude, as high as 50 %, made this parameter practically useless for estimation of the technical properties of polymer concrete. On the basis of a statistical analysis (significance level $\alpha=0.05$), it can be concluded that the values of propagation time obtained for the types of composites tested were significantly different and therefore can be used for characterization of the technical properties of concrete. The pulse velocity, v_p , for each sample was calculated, based on the values of the propagation time. The pulse velocity was lower – up to 30 % - for the single-

size-fraction composites (A,B,C) compared to the multi-size-fraction composites (D,E,F,G,H). This result indicates a significant effect of aggregate grain composition, with wider size range resulting in better filling of the volume and with lower porosity. For example, pulse velocities for the single-size-fraction composites, A, B, and C, were lower than for composite D, which consists of all the aggregate size fractions used in A, B, and C. In general, the addition of micro-filler increased the pulse velocity. Only in the case of composite H, which had the highest micro-filler content, the pulse velocity was lower than in the reference composite E (Fig. 10a). In this case, the lower workability of the polymer concrete mix when large amounts of micro-filler was present caused an irregular distribution of the micro-filler and formation of micro-filler agglomeration (Fig. 10b), often with microcracks in the interior of the agglomerates (see Fig.10c). This agglomeration was the probable cause of the significant decrease of pulse velocity for composite H.

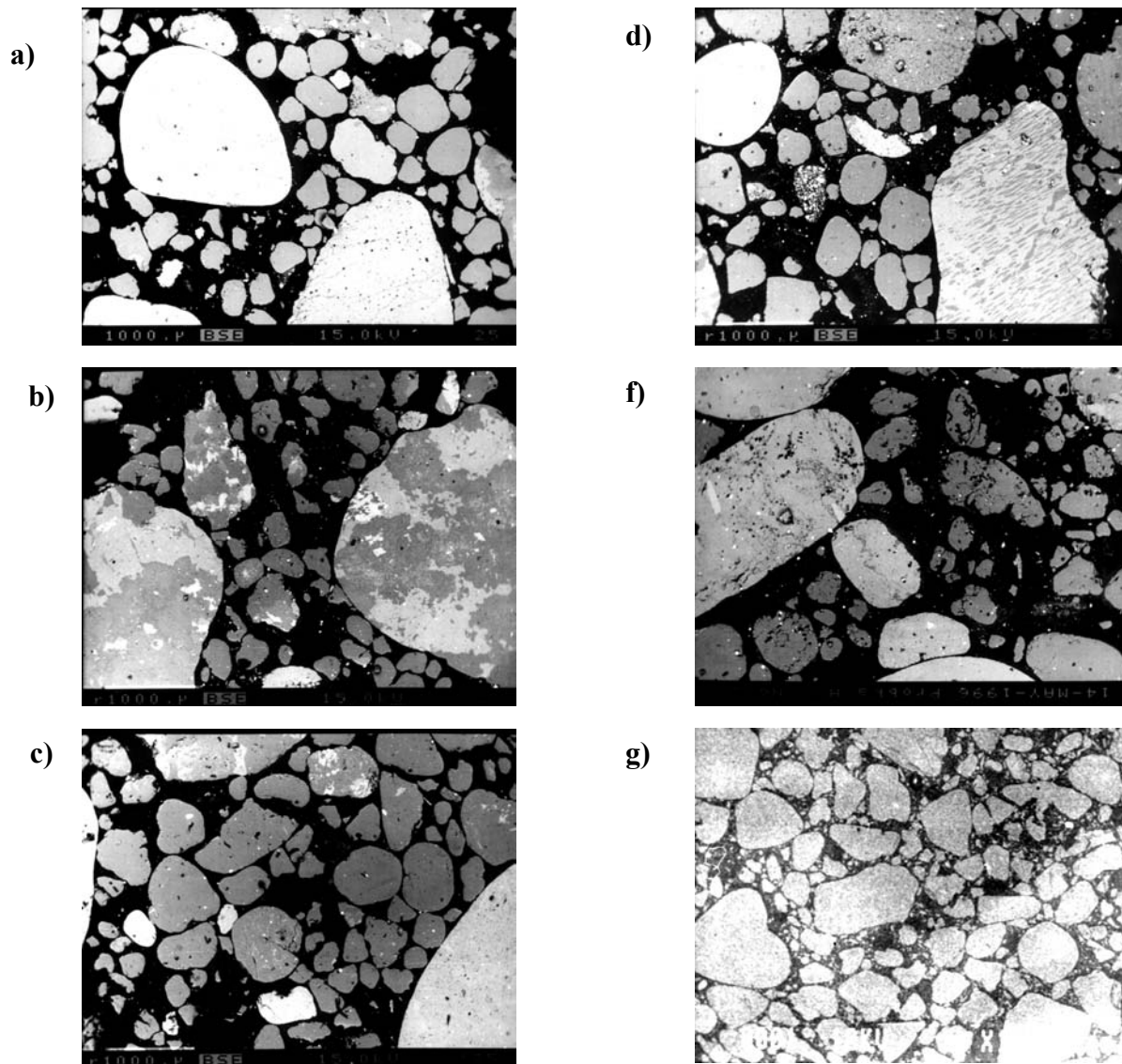

Figure 9: Examples of microstructure of tested vinyl ester concretes (SEM - BSE mode): (a - f) model multi-fractional vinyl ester concretes (types D – H, respectively (magnification. 25x); (g) microstructure of industrial vinyl ester concrete (magnification 13x)

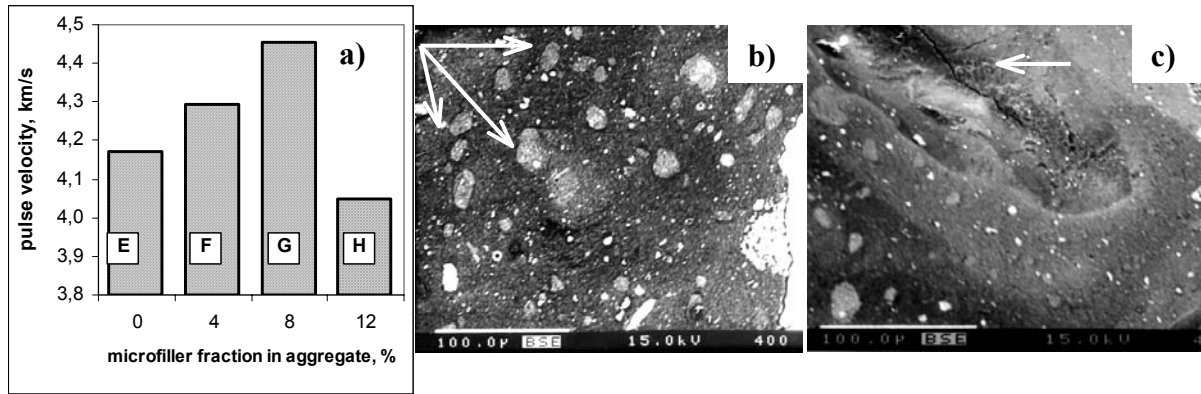

Figure 10. (a) Influence of the micro-filler content on the pulse velocity for composites E-H, (b) example of composite H microstructure with agglomeration of micro-filler, (c) microcracks inside agglomeration.

Table 4. Parameters of ultrasonic wave propagation for vinyl ester concretes tested

Statistical parameter	Composite type							
	A	B	C	D	E	F	G	H
propagation time, μ s								
Mean value, μ m	22.67	23.67	24.77	19.63	19.18	18.63	17.96	19.78
Std.dev., μ m	0.50	0.86	1.52	0.37	0.26	0.15	0.19	0.54
Coeff. of variation, %	2.22	3.66	6.15	1.89	1.36	0.82	1.10	2.73
Amplitude								
Mean value	166.83	212.06	125.28	128.17	123.89	138.83	130.67	130.33
Std..dev.	43.94	45.72	24.30	17.47	10.77	13.37	7.27	8.27
Coeff. of variation, %	26.34	21.56	19.39	13.63	8.69	9.63	5.56	6.34
Mean value of pulse velocity, m/s								
----	3530	3388	3230	4076	4172	4293	4454	4047
Mean value of dynamic elasticity modulus, GPa								
----	25.2	22.2	21.1	37.0	38.0	40.4	43.6	35.6

The technical properties of the model PC composites types used are shown in Table 5. The composites differed in porosity. The highest porosity was observed for the single-fraction composites, greater than 10 %. An increasing width of aggregate size distribution and the addition of

silica flour tended to decrease the porosity down to about 6 % (a porosity of around 5 % is a typical value for polymer concretes).

The different PC structures resulted in different properties. The compressive strength of multi-size-fraction (D-H) composites was about 50 % higher than for single-size-fraction composites (A-C). The addition of micro-filler (composites E - H), in relatively small amounts, did not affected the compressive strength by very much compared to the standard deviations. The lowest values of f_c in the micro-filler group, however, were obtained for composite H. The average compressive strength for composite H was about 30 % lower than that for reference composite E, and were probably due to the high irregularity of the micro-filler distribution. The flexural strength for the microfiller group compared to the other PC types was changed in a relatively smaller degree. However, the non-homogeneous distribution of micro-filler in composite H caused a 45 % lowering of f_b compared to

Table 5. Technical properties of tested vinyl ester concretes

Statistical parameter	Composite type							
	A	B	C	D	E	F	G	H
compressive strength, MPa								
Mean value, MPa	24.8	13.2	13.2	44.2	47.4	48.2	47.4	35.1
Std.dev.,MPa	3.4	1.6	3.7	6.2	2.4	4.2	4.8	2.5
Coeff. of Var., %	13.8	12.0	28.0	14.1	5.1	8.6	9.8	7.1
flexural strength, MPa								
Mean value, MPa	15.7	14.1	11.9	18.5	20.8	22.1	21.5	12.3
Std.dev.,MPa	2.0	2.0	0.5	1.0	1.1	1.1	2.1	1.2
Coeff. of Var., %	12.7	13.9	4.2	5.2	5.5	5.1	9.8	9.7
static elasticity modulus, GPa								
Mean value, GPa	9.6	4.0	2.0	12.8	15.9	18.8	20.4	19.5
Std.dev.,GPa	3.5	1.2	0.1	1.3	1.7	1.5	5.8	2.8
Coeff. of Var., %	36.6	31.4	6.2	9.8	10.8	7.9	1.2	19.5
porosity, %								
Mean value, %	10.9	17.8	14.9	7.0	7.7	5.8	5.8	6.1
Std.dev., %	1.1	1.2	1.7	0.9	0.9	0.6	1.2	1.2
Coeff. of Var., %	9.8	6.5	11.3	12.8	11.9	9.9	20.2	19.2
volume density, kg/m ³								
Mean value, kg/m ³	2018	1932	2025	2224	2184	2191	2196	2176
Std.dev., kg/m ³	30	17	41	12	8	9	8.9	5.4
Coeff. of Var., %	1.5	0.9	2.0	0.5	0.36	0.4	0.4	0.3

the reference composite E, just like in the case of compressive strength. The micro-filler composites also had higher values of elasticity modulus, E_b , than did the non-micro-filler composites. This can be explained by a modification of the resin binder by the micro-filler resulting in higher values of E_b of the binder phase, e.g., the binder phase becomes a polymer micro-mortar. In the case of composite H, a small decrease in the value of E_b was found, although within the standard deviation. Clearly, a non-homogenous micro-filler distribution affects strength more than modulus of elasticity, which is a reasonable result, since strength is much more sensitive to flaw size than is the modulus of elasticity.

5.2.3. Relationship between technical properties and ultrasonic wave propagation

The possibility of application of an ultrasonic method for the non-destructive evaluation of the mechanical properties of PC composites depends upon determining an adequate regression function with a high value of correlation coefficient (close to 1). If good empirical relations are found between ultrasonic pulse velocity, for example, and other properties, then one measurement of pulse velocity can be used to accurately determine many other properties as well. In this work, the relationships (Fig. 11) between pulse velocity, v_p , and the structural parameters p and D_v and the mechanical properties f_c , f_b and E_b were analyzed. The accuracy of fitting by various regression functions was characterized by the value of the coefficient of standard deviation, C_d , calculated from Eq. 14 (see Table 6 for a summary of results). Analysis of the results indicated that in all cases the best fits were obtained using a quadratic polynomial, e.g., the highest regression coefficients and the lowest values of C_d . For both the relationships of porosity and volume density vs. pulse velocity, statistical significance was obtained, denoted by a value of the correlation coefficient $r > 0.90$. As the porosity, p , decreased and volume density, D_v increased, the pulse velocity increased. This result confirms the effect of the PC structure on the propagation of ultrasonic waves. Micro-filler, which is added to PC in order to modify the elastic properties of the resin binder, also increases the pulse velocity. The effect of PC microstructure on PC properties was also confirmed also in the relationships between mechanical

Table 6. Regression functions for pulse velocity and selected technical properties of tested vinyl-ester concretes.

Relationship	Regression function	Correlation coefficient, r	Coeff. of standard deviation C_d , eq. (14)
$p - v_p$	$p = 6.80 v_p^2 - 61.14 v_p + 143.32$	0.91	17.3
$D_p - v_p$	$D_p = -105.39 v_p^2 + 1021.31 v_p - 242.42$	0.90	2.2
$f_c - v_p$	$f_c = -16.13 v_p^2 + 161.43 v_p - 340.22$	0.94	21.4
$f_b - v_p$	$f_b = -2.32 v_p^2 + 25.60 v_p - 46.05$	0.90	9.0
$E_b - v_p$	$E_b = 14.20 v_p - 43.20$	0.94	25.5

properties and pulse velocity. The regression functions obtained for f_c , f_b , and E_b were characterized by a high value of the correlation coefficient ($r > 0.90$). The results of the t-Student test confirmed the statistical significance of the analyzed functions. It should be noted that non-homogeneous

structure (e.g. irregular distribution of micro-filler due to the low workability of PC mix) affects the propagation of ultrasonic waves to a smaller extent than do the mechanical properties of PC.

The regression analysis of the relation between the static, E_b , and the dynamic, E_d , modulus of elasticity showed (Fig. 8f) that this relationship ($\alpha=0.05$) is statistically significant (correlation coefficient $r=0.94$). Similar relations exist for the other composites.

Statistically significant relationships between pulse velocity and compressive and flexural strength were also obtained for representative samples of industrial vinyl-ester concrete (Fig.12). The regression functions obtained for f_c and f_b were characterized by lower correlation coefficients (0.84 and 0.71) in comparison to the corresponding properties of the model concretes. However, the shape of the regression function plot is similar in both cases and the low values of the coefficient of standard deviation, C_d , indicated a reasonable fit to experimental results.

The results obtained confirmed that the pulse velocity method is useful for nondestructive evaluation of polymer concrete properties. However, further investigation should be continued to improve the accuracy of the reference curve.

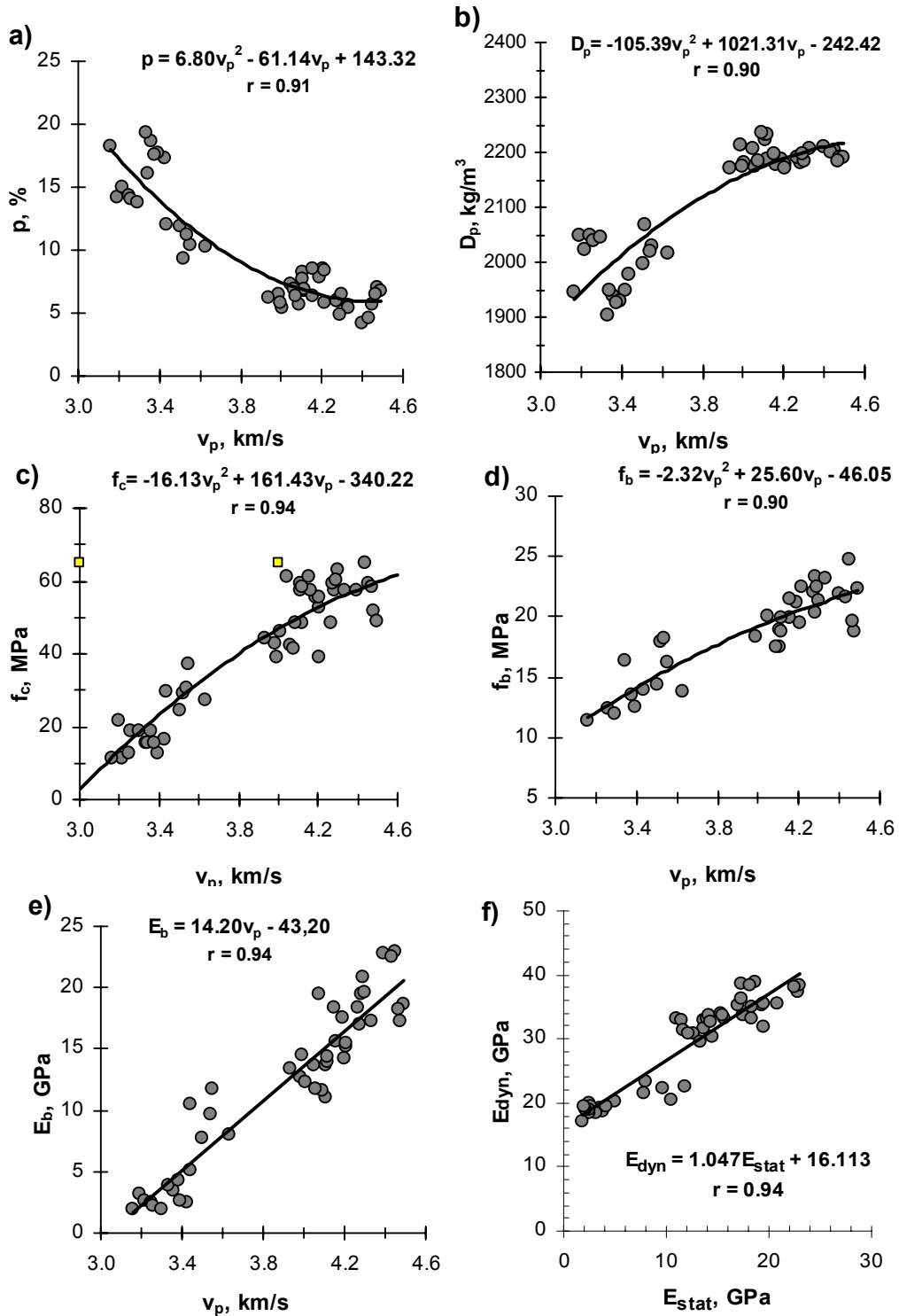

Figure 11. Regression functions describing relationships between the pulse velocity and: (a) porosity, p , (b) volume density, D_v , (c) compressive strength, f_c , (d) flexural strength, f_b , and (e) static elasticity modulus, E_b , for tested model vinyl ester concretes tested. Graph f) shows the dynamic elasticity modulus, E_{dyn} , plotted against the static modulus of elasticity, E_{stat} .

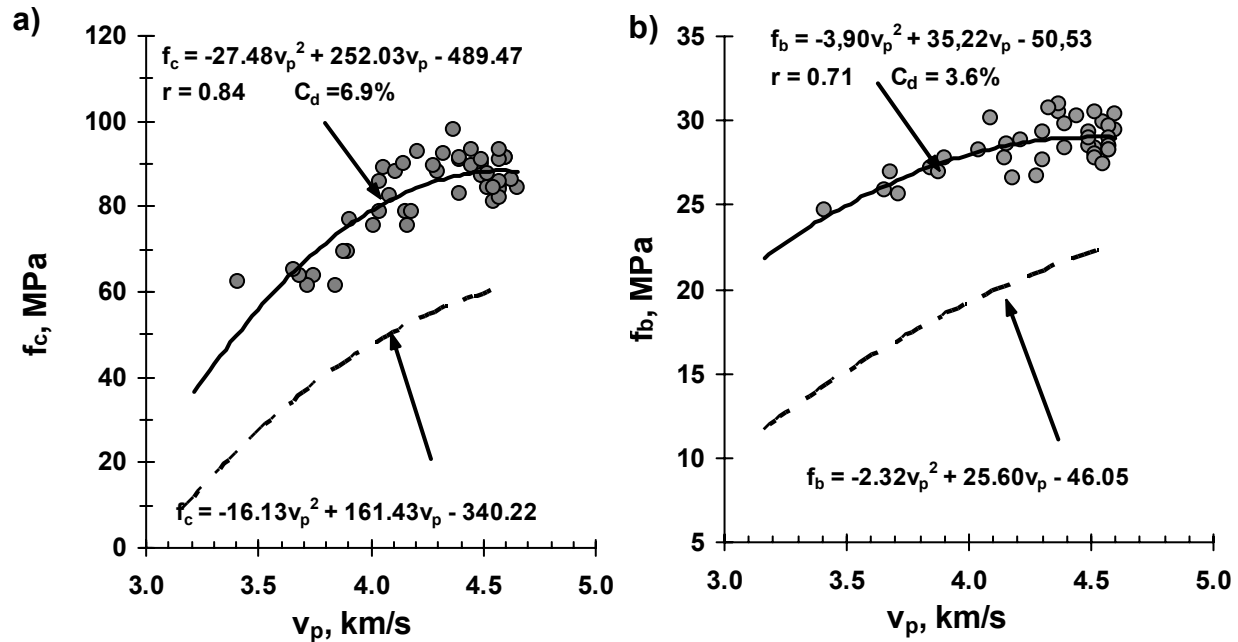

Figure 12. Relationships between pulse velocity, v_p , and: (a) compressive strength, f_c , and (b) flexural strength, f_b , for representative samples of industrial precast elements made from vinyl ester concrete. The dashed line shows the corresponding regression functions for the model vinyl ester concretes, obtained previously (see Table 6).

Additionally, the effect of aggregate moisture content on polymer concrete properties and the pulse velocity was tested. The investigations were carried out for vinyl-ester mortar (A/B = 4 by mass) and vinyl-ester concrete (A/B = 8 by mass) with aggregates of different moisture contents, w_{agg} (amount of water by mass). The results obtained showed that the decrease of interior adhesion (Fig.13) affected both the PC mechanical properties and the pulse velocity (Fig.14). As the moisture level of the aggregates increased, the mechanical properties and the pulse velocity significantly decreased. This indicates that aggregates with different moisture levels can be used for development of the lower region of the reference curve, for low values of the strength and the pulse velocity. In other words, the variation of these properties with aggregate moisture content is statistically significant.

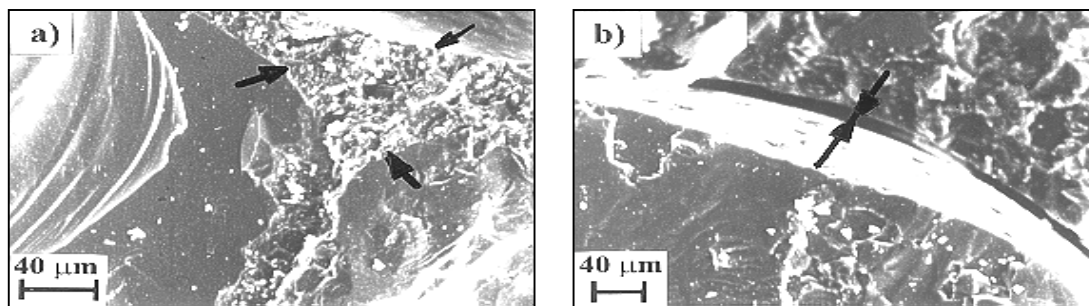

Figure 13. SEM micrographs showing examples of PC microstructure with dry (a) and wet (b) aggregate, which had caused different levels of adhesion.

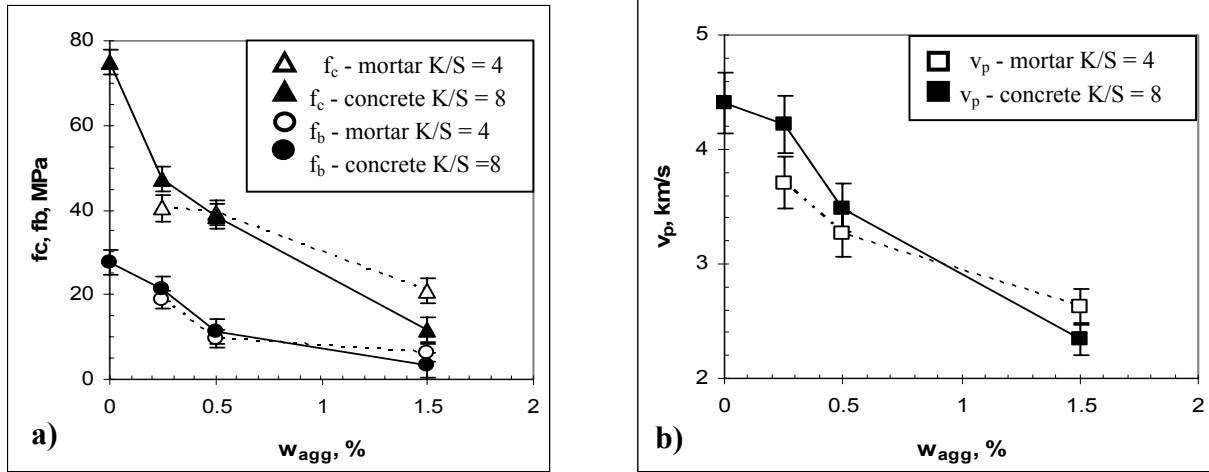

Figure 14. Effect of aggregate moisture content on a) mechanical properties: compressive strength, f_c , and flexural strength, f_b , and b) pulse velocity, v_p , for vinyl-ester mortar and concrete; w_{agg} – water to aggregate ratio by mass. Error bars represent variation over several nominally identical samples.

5.3. Ultrasonic estimation of selected properties of epoxy concrete

5.3.1. Materials and results

The second stage of the experiment was concerned with the ultrasonic evaluation of epoxy concrete with different fractions of resin binder (different A/B ratio). The relation between their properties and the ultrasonic pulse velocity was tested. A commercial epoxy resin was used as a binder. The same natural quartz, with diameters of (0 to 1.5) mm, (1 to 2) mm, and (2 to 5) mm, was used as an aggregate, and the same microsilica was used as a micro-filler. Seven types of epoxy concrete, differing in microstructure and properties, were obtained (Table 7). The material optimization approach was used to formulate the composition of the tested epoxy concretes [54] and to obtain a wide range of variability of both concrete properties and pulse velocity. Beam-shaped samples (40 mm x 40 mm x 160 mm) were prepared and used for compressive and bending tests.

5.3.2. Discussion of results

The relationship between the ultrasonic pulse velocity, v_p , and the mechanical properties f_c and f_b and the structural parameters p , and D_v were analyzed (see Fig.15). Analysis of the results indicated that, just as in the vinyl-ester concretes, the best fits to experimental data were obtained using quadratic polynomial functions (Table 8). For both porosity and volume density vs. pulse velocity, a satisfactory level of statistical significance was obtained. With decreasing p and increasing D_v , pulse velocity increased. The relationships between the mechanical properties and the propagation of the ultrasonic wave were also statistically significant. The regression functions obtained for f_c and f_b were characterized by a high value of the correlation coefficient, $r > 0.93$. In the case of epoxy concretes with a lower A/B ratio, a relatively high effect of micro-filler addition on pulse velocity was observed – for concrete with A/B=9 and M/A=0.18 the pulse velocity was higher and

mechanical properties lower in comparison with concrete with A/B=7 and M/A=0.12. This confirmed the conclusion from the previous investigation of vinyl-ester concrete.

Table 7. Properties of tested epoxy concretes (standard deviation)

Property	Composite:						
	KI	KII	KIII	KIV	KV	KVI	KVII
Composition*, by mass ratios	A/B=14 S/A=0.60 M/A=0.04	A/B=14 S/A=0.60 M/A=0.12	A/B=11 S/A=0.42 M/A=0.04	A/B=11 S/A=0.42 M/A=0.12	A/B=9 S/A=0.41 M/A=0.18	A/B=7 S/A=0.36 M/A=0.04	A/B=7 S/A=0.36 M/A=0.12
Pulse velocity, v_p [m/s]	3883 (23)	3972 (22)	3989 (17)	4189 (19)	4509 (20)	4278 (19)	4405 (26)
Flexural strength, f_b [MPa]	12.2 (0.5)	11.7 (0.8)	13.1 (1.4)	17.5 (1.9)	20.9 (1.1)	19.5 (1.9)	23.8 (0.9)
Compressive strength, f_c [MPa]	27.6 (2.3)	25.1 (0.3)	38.4 (5.3)	52.6 (4.1)	81.5 (4.9)	81.0 (3.2)	86.4 (1.5)
Porosity, p [%]	15.4 (0.5)	13.9 (0.8)	12.2 (0.9)	11.5 (2.9)	5.5 (0.6)	6.4 (0.4)	5.1 (0.8)
Volume density, D_v [kg/m ³]	2115 (8)	2155 (11)	2151 (20)	2207 (49)	2273 (9)	2198 (4)	2234 (5)
* B- binder, A – total aggregate, S – sand, M – micro-filler							

Table 8. Regression functions for pulse velocity and selected technical properties of epoxy concretes tested.

Relationship	Regression function	Correlation coefficient, r	Coeff. of std. dev. C_d , eq.(15)
$p - v_p$	$p = 16.1 v_p^2 - 152.3 v_p + 143.3$	0.95	15.4
$D_p - v_p$	$D_p = -129.6 v_p^2 + 1311.1 v_p - 1014.9$	0.90	1.2
$f_c - v_p$	$f_c = -47.9 v_p^2 + 513.1 v_p - 1248.2$	0.95	19.5
$f_b - v_p$	$f_b = -11.1 v_p^2 + 112.6 v_p - 258.7$	0.93	9.1

In the case of the epoxy concretes, the correlation coefficients obtained were higher and the coefficients of standards deviation lower in comparison to the corresponding coefficients determined for the vinyl-ester concrete (see Fig. 15 and Table 6). This indicates that the material optimization approach (material model of PC) gives the possibility of developing a reference curve for a given PC type with high accuracy and uniform distribution of data points in the range of mechanical properties tested. The basic issue is how big the variation in the PC composition can be to develop the reference curve for the given PC type. It seems that the variation in the micro-filler content is the most important. Figure 16 shows the relationship between PC properties and the pulse velocity for epoxy concretes that differ in the micro-filler content, M/A. This figure indicates that two main types of concrete can be recognized: those with low values of M/A (0.04) and those with high values of M/A (0.12). The results for concrete with the highest M/A=0.18 are close to the PC type with the lowest M/A=0.04. This indicates that the relative variation of micro-filler content (M/A) in

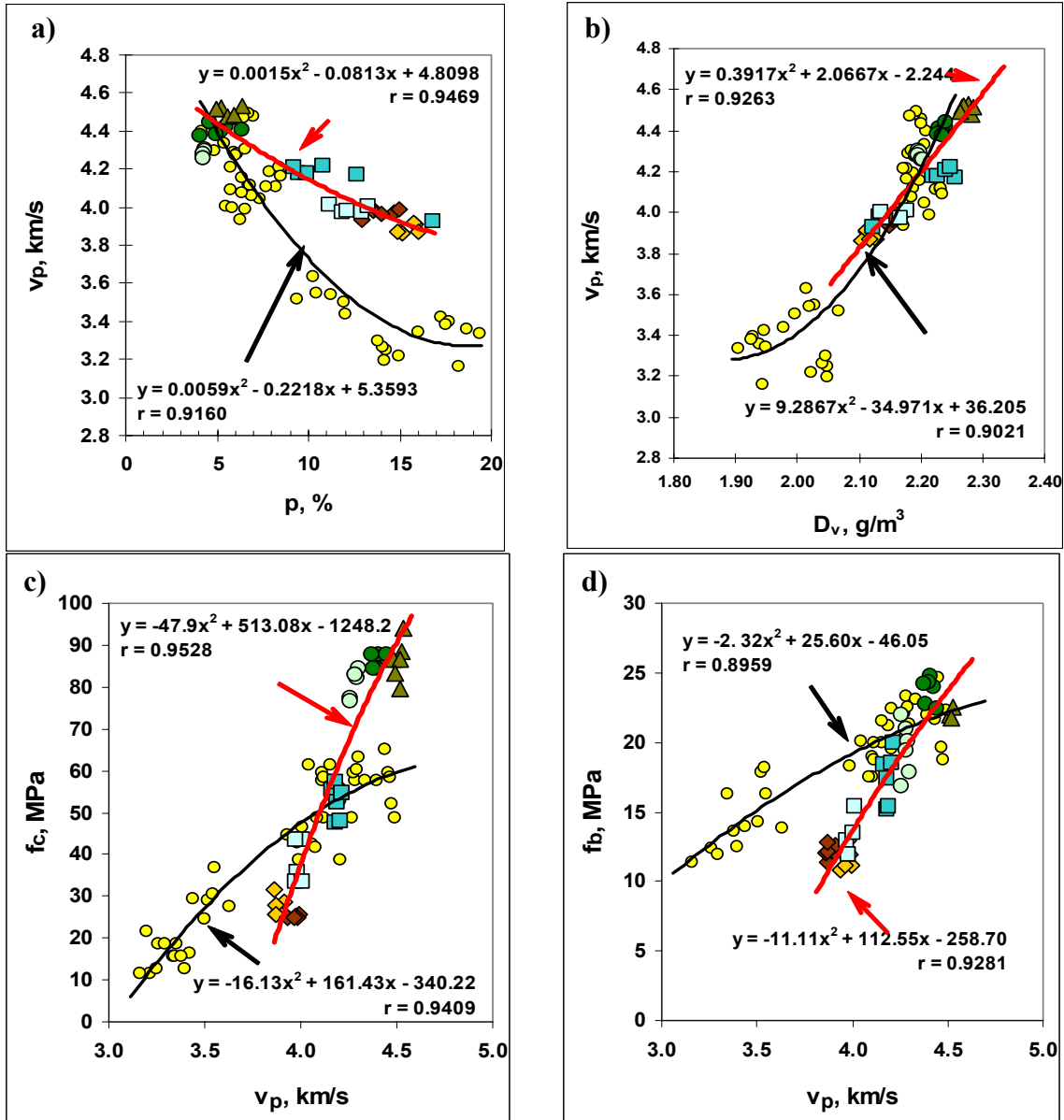

	Epoxy concrete: $D_{max} = 4$ mm							Vinyl-ester concrete
Composition	A/B=14 S/A=0.60 M/A=0.04	A/B=14 S/A=0.60 M/A=0.12	A/B=11 S/A=0.42 M/A=0.04	A/B=11 S/A=0.42 M/A=0.12	A/B=9 S/A=0.41 M/A=0.18	A/B=7 S/A=0.36 M/A=0.04	A/B=7 S/A=0.36 M/A=0.12	A/B=8 $D_{max} = 2-8$ mm
Symbol	◇	◆	□	■	▲	○	●	●

Figure 15. Regression functions describing relationships between pulse velocity and a) porosity, b) volume density, c) compressive strength, and d) flexural strength, for epoxy and vinyl-ester concretes differing in microstructure.

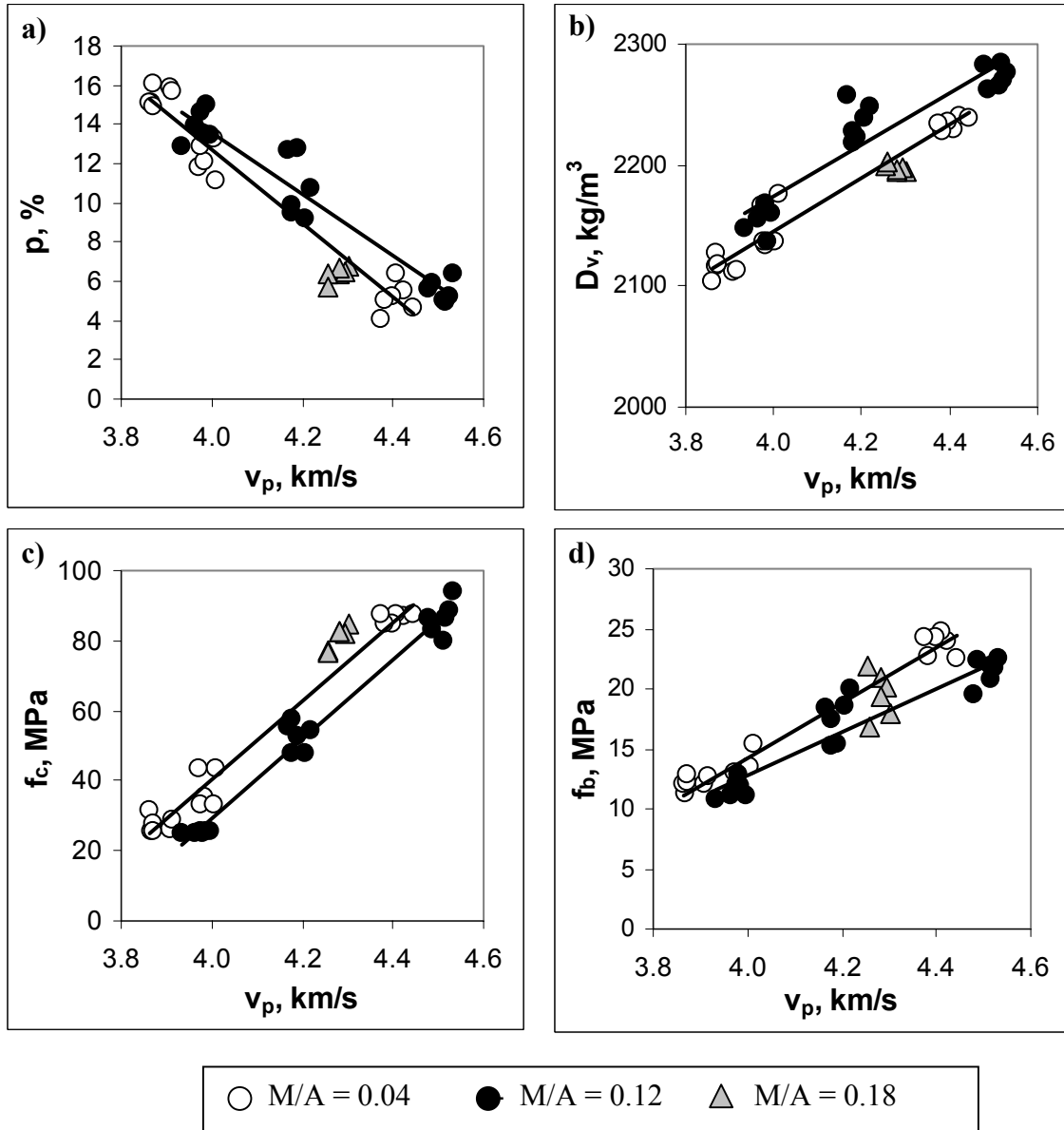

Figure 16. The pulse velocity vs. a) porosity, b) volume density, c) compressive strength, and d) flexural strength, for epoxy concretes with different micro-filler contents, M/A .

composition of the reference PC type should be not too high. On the basis of the results obtained it can be proposed that the variation in M/A should be not higher than ± 0.02 .

5.3.3. Analysis of relationship between microstructure and ultrasonic wave propagation

Fractography, which was used to determine the fracture surface roughness ratio, R_s , was then used for characterization of the microstructure of the epoxy concretes tested (Fig.17). It has been shown [55,56] that the fracture surface roughness ratio, R_s , is an important parameter that can be used to characterize the toughness of materials. This parameter is defined as the true fracture

surface area, S , divided by the apparent projected area, S_0 : $R_s = S/S_0$. In the case of polymer concrete, the topography of the fracture surface depends not only on the composition (resin binder to aggregate ratio, A/B ; porosity and aggregate grain size distribution) but also depends on the adhesion between binder and aggregate [57]. In this case, the R_s parameter can be treated as a factor describing the PC microstructure in a satisfactory way [58]. The relationship between R_s and pulse velocity can be used for the nondestructive estimation of polymer concrete toughness.

The value of R_s was determined (Fig.18) using the method of vertical sections [59,60], for representative samples of each type of epoxy concrete at magnifications of 10x, 25x, 63x, 160x, and 400x (see Table 9).

Table 9. The surface roughness ratio, R_s , for the epoxy concretes tested

Property	Composite:						
	KI	KII	KIII	KIV	KV	KVI	KVII
Composition*, by mass ratio	A/B=14 S/A=0.60 M/A=0.04	A/B=14 S/A=0.60 M/A=0.12	A/B=11 S/A=0.42 M/A=0.04	A/B=11 S/A=0.42 M/A=0.12	A/B=9 S/A=0.41 M/A=0.18	A/B=7 S/A=0.36 M/A=0.04	A/B=7 S/A=0.36 M/A=0.12
Surface fracture ratio, R_s at mag.:							
10x	2.213	2.308	2.324	2.011	1.660	1.607	1.708
25x	2.101	2.357	2.144	1.972	1.598	1.571	1.665
63x	1.985	1.970	1.927	1.869	1.654	1.559	1.685
160x	1.949	1.889	2.093	2.072	1.712	1.851	1.819
400x	1.834	1.743	1.924	1.942	1.819	1.815	1.760
* B- binder, A – aggregate (in total), S – sand, M – micro-filler							

The results obtained indicated that the relationship between the pulse velocity and the fracture surface geometry (Fig.19) depends on the observation level or magnification. The relationship between pulse velocity and R_s is statistically significant up to a magnification of 160x. As the magnification increases, the values of the correlation coefficients decrease. At a magnification of 400x, which starts seeing the length scales at the micro-filler level, the relationship is no longer statistically significant. In this case, binder modification by the micro-filler affects pulse velocity to larger extent than does the purely geometrical features of the microstructure resulting from the composition. This confirmed previous conclusions that to develop the reference curve for a given PC type the variation in micro-filler content should be limited.

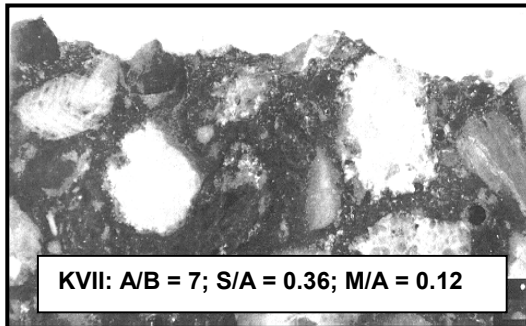
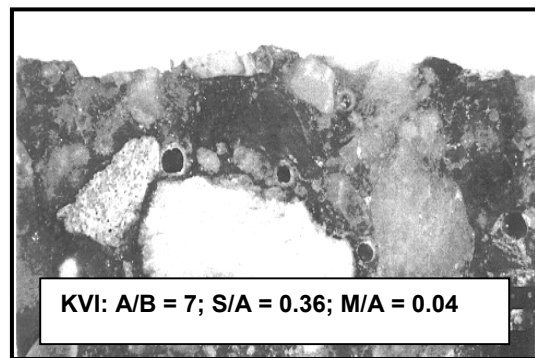
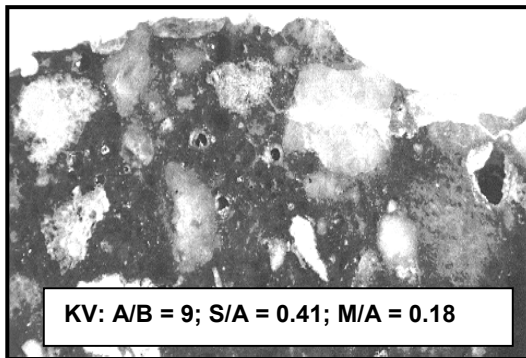
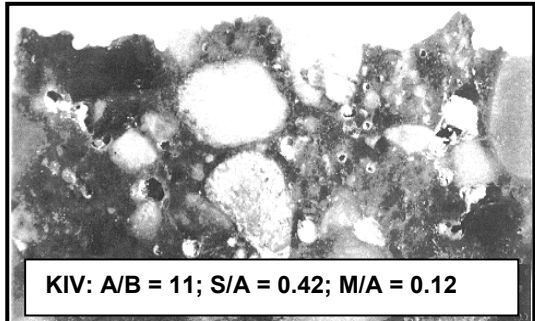
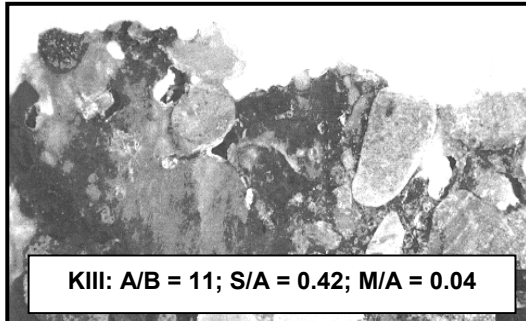
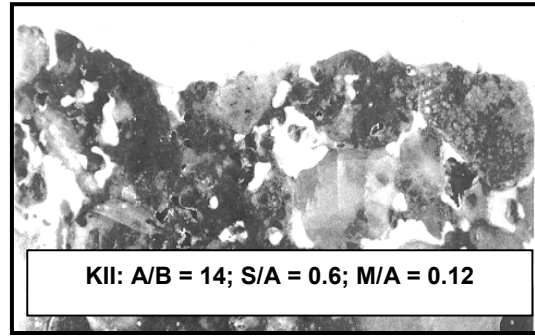
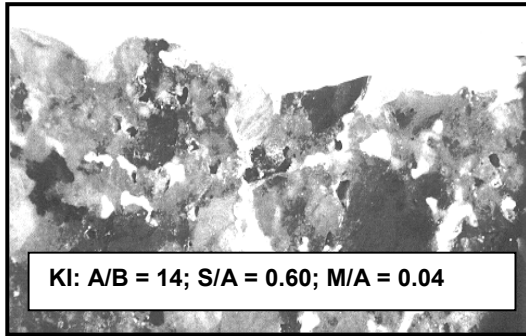

A – aggregate in total (mass);
 B – binder (mass);
 S – sand (mass);
 M- micro-filler (mass)

Figure 17. Examples of microstructures and fracture surface profiles of the epoxy concretes tested. Concrete compositions were designed based on the material model of epoxy concrete [54].

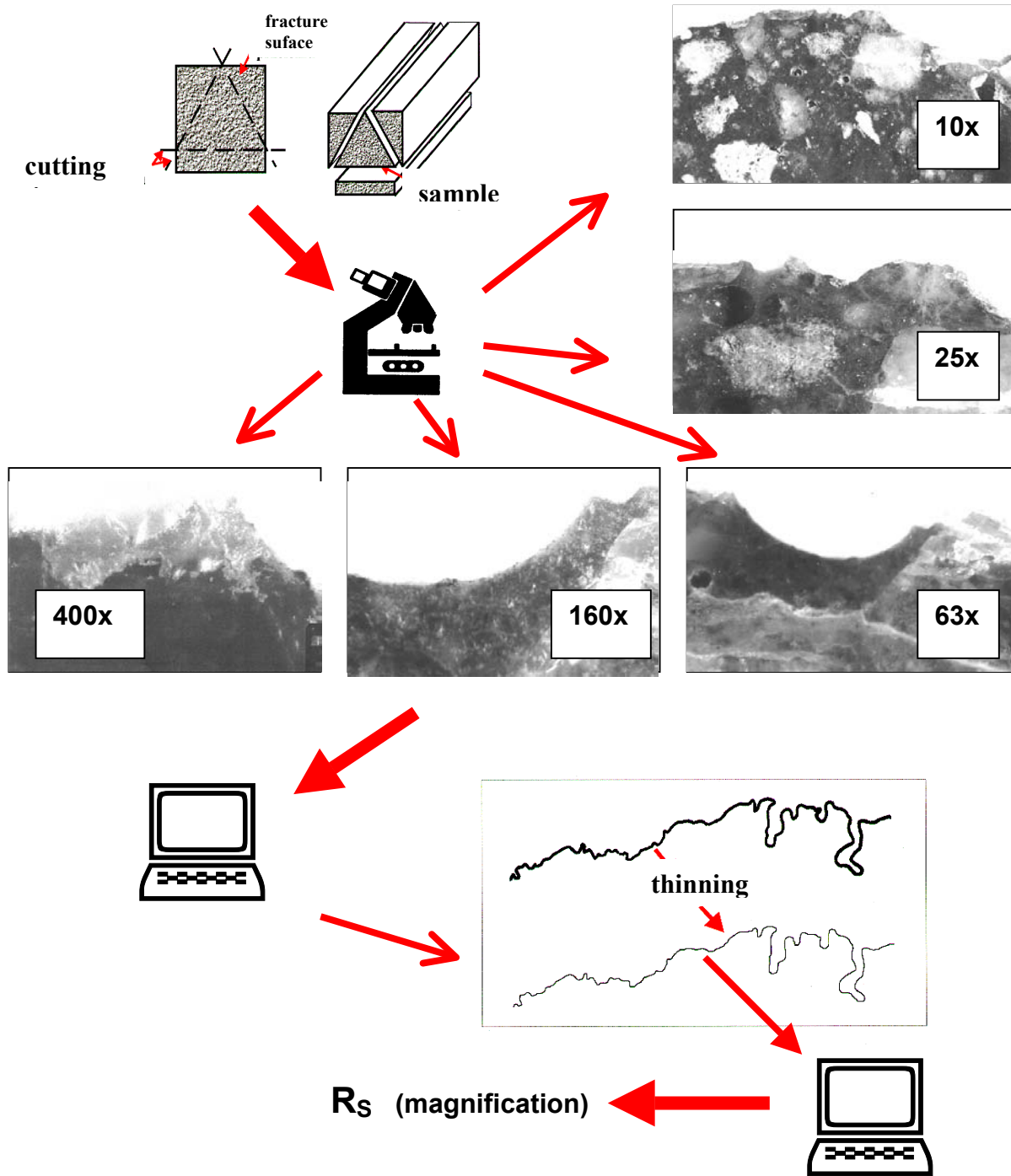

Figure 18. Scheme of determination of fracture surface roughness ratio using vertical section method and image analysis.

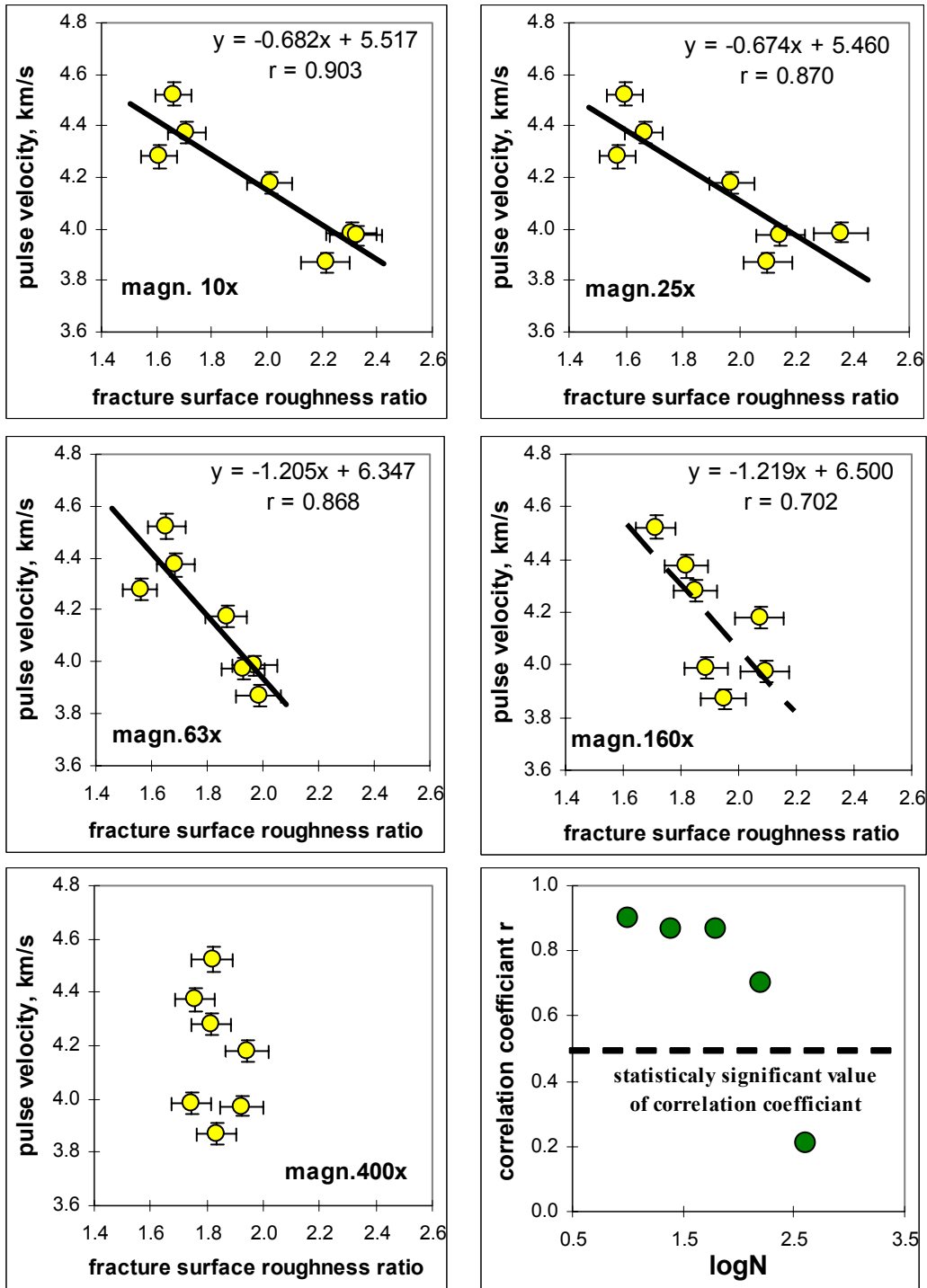

Figure 19. Pulse velocity plotted against surface roughness ratio at different magnifications for epoxy concrete. The correlation coefficient vs. the logarithm base ten of the magnification, N, is also shown.

5.4. Conclusions concerning ultrasonic evaluation of elements made from polymer concrete

On the basis of the results obtained, the following main conclusions about ultrasonic assessment of polymer concrete precast elements can be formulated:

- the regression functions obtained for vinyl-ester and epoxy concretes justify the possibility of applying ultrasonic methods for the nondestructive evaluation of properties of precast elements made from various polymer concretes;
- in engineering practice, a reference curve (ISO-strength curve) should be made for the given type of polymer concrete, taking into account the type of resin binder and the type of aggregate;
- to develop a reference curve for calibration procedures the following parameters can be varied: the aggregate to resin binder ratio, A/B, the sand fraction, S/A, and in a limited range, the micro-filler content, M/A (the variation in M/A should be about 50 %, and the maximum value of M/A should be less than 0.12), and, if necessary, the aggregate moisture content;
- the material optimization approach (material model of polymer concrete) gives the possibility of developing a reference curve for the given PC type with high accuracy and uniform distribution of data points in the tested range of mechanical properties and pulse velocity;
- the pulse velocity, as calculated from the transit time and as the parameter describing the ultrasonic wave propagation in a material, is practically useful for the estimation of PC properties. The amplitude was found to be useless for estimating polymer concrete properties because of the high level of scatter;
- the obtained results indicate the necessity for further investigation in order to increase the accuracy of ultrasonic evaluation of polymer concrete properties using advanced methods of data processing, e.g, fuzzy logic or Bayes's theory [61], or an advanced method of signal analysis [62].

6. ULTRASONIC EVALUATION OF MULTI-LAYER REPAIR SYSTEMS

6.1. Propagation of ultrasonic waves through the medium boundary

Quality control of the efficiency of repair applications is the basic purpose behind the nondestructive evaluation of the multi-layer systems of polymer concrete on top of portland cement concrete (PC-CC) that are created as a result of repair techniques. This quality control is focused mainly on the estimation of the thickness of system elements and the detection of various defects at the PC-CC interface. Echo methods are preferred in this field [10]. Recently, the impact-echo method, which was developed at the National Institute of Standards and Technology and Cornell University, has appeared as the most promising NDT method for the quality assessment of concrete structures [62,63]. However, detection of relatively large and deeply located defects only plus expensive equipment are disadvantages of this method.

The adhesion between PC and CC is a crucial property of a repair system. Quality control of the adhesion level is available using a semi-destructive method, e.g. a pull-off test (Fig. 20). In a new European Standard, ENV 1504, a pull-off strength higher than 1.5 MPa is recommended. The measurement of pull-off strength is usually restricted by contractors to a localized area due to the destructive character of pull-off strength measurement. Therefore, the development of nondestructive assessment methods for evaluation of the adhesion between polymer composites and concrete substrates, and especially a possibility of *mapping* the adhesion level over a wide region, is one of the important needs in the PC repair field.

The complexity of ultrasonic wave propagation through the PC-CC multi-layer system (see Section 4) means that for proper nondestructive evaluation of a multi-layer system the proper selection of investigation method is very important. In general, the usefulness of two ultrasonic methods, the echo method and the indirect pulse velocity method, can be considered.



Figure 20. Example of deteriorated industrial floor and evaluation of adhesion with pull-off test

6.2. Evaluation of the PC - CC system with echo method

6.2.1. Procedure of the ultrasonic testing

The purpose of this stage of research was the evaluation of the possibility of using the ultrasonic echo method for estimating the thickness of industrial resin floors and adhesion levels in the PC-CC system. The investigations were carried out using four commercial transducers* of various frequency characteristics: 0.5LN50, with a frequency of 0.5 MHz, S12HB0.8-3, with a frequency range of 0.8 MHz to 3 MHz, 1V102, with a frequency 1 MHz, and 10V202, operating at a frequency of 10 MHz and having a delay line.

The floor thickness was determined based on the location of the echo from the PC-CC interface and the previously determined velocity of the wave in the floor material. The influence of adhesion differences on the value of the echo amplitude was assumed during analysis of the possibility of using the echo method for evaluation of the adhesion at the PC-CC interface. The amplitude was amplified to a level equal to 0.8 of the maximum amplitude. The value of the amplification was defined to be $W_{0.8H}$. It was assumed that value of $W_{0.8H}$ was a measure of the wave attenuation at the PC-CC interface and corresponded to a measure of the adhesion in the PC-CC system. A commercial ultrasonic gel was applied as the coupling agent. The ultrasonic tests of coatings were carried out after 7 d and 28 days of the curing of the portland cement concrete substrate.

6.2.2. Materials

Tests were performed on samples corresponding to commercial epoxy industrial floors. The polymer coating was placed on the concrete substrate of the B35 class, with sample sizes of 500 mm x 1000 mm x 50 mm. For obtaining various adhesion levels, coatings were placed on concrete substrate having 8 different kinds of surface states: dry, wet, oiled, and with primer (Fig. 21a). The variability of the coating thickness over a sample surface was obtained by a slight inclination of the substrate. Additionally, beam samples from the floor material, 40 mm x 40 mm x 160 mm were prepared for determination of the ultrasonic wave velocity in the tested polymer coating and for calibration of the measurement equipment. The measurements were carried out also for a floor that was disbonded to the concrete substrate. In this case, the polymer coating was applied to a layer of metallic foil and after hardening placed onto a concrete substrate (Fig.21b). This corresponded to a "zero adhesion" state of the PC-CC system.

* Certain commercial equipment is identified in this report in order to adequately specify the experimental procedure. In no case does such identification imply recommendation or endorsement by the National Institute of Standards and Technology, nor does it imply that the equipment used is necessarily the best available for the purpose.

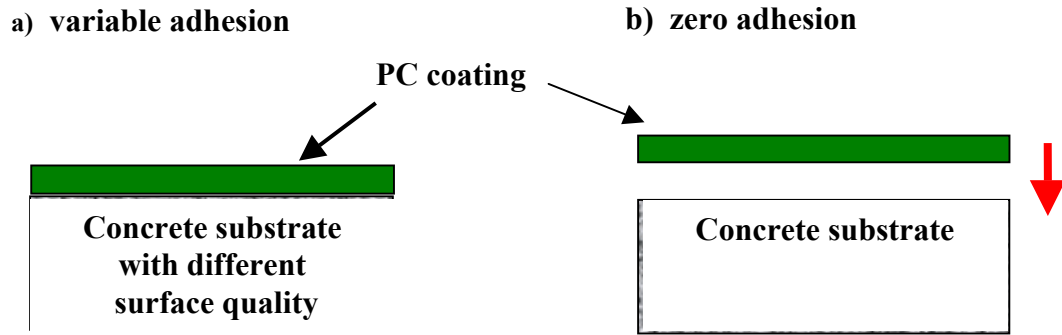

Figure 21. Scheme of ultrasonic evaluation of (a) different adhesion levels and (b) the “zero-adhesion” state.

6.2.3. Determination of adhesion

Adhesion between the polymer coating and the concrete substrate has been characterized by the bond strength in the pull-off test. Steel cylindrical “dollies” of 50 mm diameter were glued to the coating with epoxy glue. The floor layer and concrete substrate were drilled to a depth of 10 mm. The pull-off bond strength was determined using a digital tester after ultrasonic testing was completed.

6.2.4. Results of testing using echo method

The reflection coefficient, R , was determined for the floor and concrete substrate system. For that reason, the density and the ultrasonic pulse velocity for the floor material and concrete substrate were first determined separately. The ultrasonic wave velocity obtained for the epoxy floor was equal to $2650 \text{ m/s} \pm 10 \text{ m/s}$. This value agrees well with literature data [64]. The apparent density of the floor was $1589 \text{ kg/m}^3 \pm 12 \text{ kg/m}^3$. The ultrasonic velocity and density for the concrete substrate were $4100 \text{ m/s} \pm 24 \text{ m/s}$ and $2220 \text{ kg/m}^3 \pm 22 \text{ kg/m}^3$, respectively. Using these values, the acoustic impedances were calculated:

- epoxy floor: $Z_1 = c_p \cdot \rho_p = 4.21 \cdot 10^6 \text{ kg/m}^2\text{s}$
- concrete substrate: $Z_2 = c_b \cdot \rho_b = 9.102 \cdot 10^6 \text{ kg/m}^2\text{s}$

The value of the reflection coefficient for the epoxy floor – concrete substrate system, calculated from eq.16, was then:

$$R = \frac{Z_2 - Z_1}{Z_2 + Z_1} = 0.37 \text{ kg/m}^2\text{s}$$

The value obtained is relatively high (Fig. 7), showing that obtaining information on the floor – concrete interface separation surface using ultrasonic techniques is possible even without complete delamination.

Measurements of the floor thickness using the echo method after 7 days of curing were carried out for checking the usefulness of the transducers for evaluating the state of the PC-CC

interface. Transducers S12HB0.8-3 and 10V202 appeared to be the most useful compared to the other transducers. The echo from the floor – substrate separation interface was visible in the recorded signal (Fig. 22 a, b), but the echo from the bottom of the substrate was not visible. This is favorable for the testing of coatings due to the reduction of disturbing echoes, e.g. from the reinforcement. The remaining transducers were not useful for evaluating the state of the PC-CC system. Transducers 0.5LN50 and 1V102 had too large of a dead zone and the floor signal interfered with the input impulse (Fig. 22 c, d). However, transducer 0.5LN50 recorded the echo from the substrate bottom. Transducers S12HB0.8-3 and 10V202 were selected for further testing.

The floor thickness and amplification coefficient $W_{0,8H}$ were measured in the first stage using the ultrasonic echo method. The tests were performed in 9 uniformly distributed measuring points of every field. Then the pull-off bond strength was determined in 4 places of each field. After detachment of the dollies, the real thickness of the floor was measured in 4 places of each dolly using a Brinell magnifier. Results of these measurements are given in Table 10. The distributions of floor thickness over a given slab, measured directly with the magnifier and estimated by ultrasonic methods, are presented in Fig. 23. In all cases, the thickness distribution was determined using the least squares method of estimation with the same parameters.

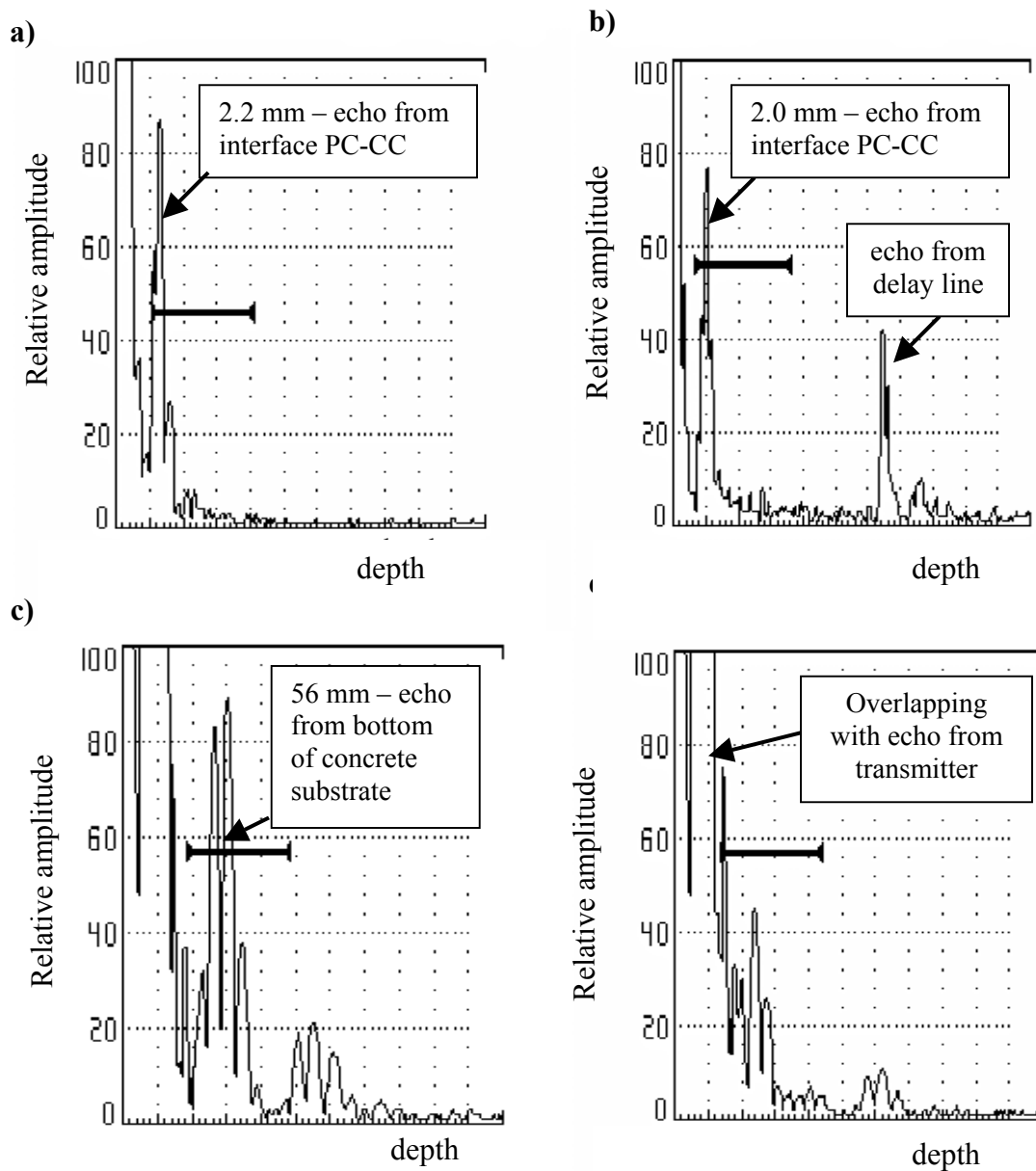

Figure 22. Registered signal (A-scan) after testing the floor system of 2 mm thick layered on concrete substrate with echo method using: a) S12HB0.8-3, b) 10V202, and c) 0.5LN50, 1V102. The signals recorded in (a) and (b) contain echoes from the interface floor - concrete substrate.

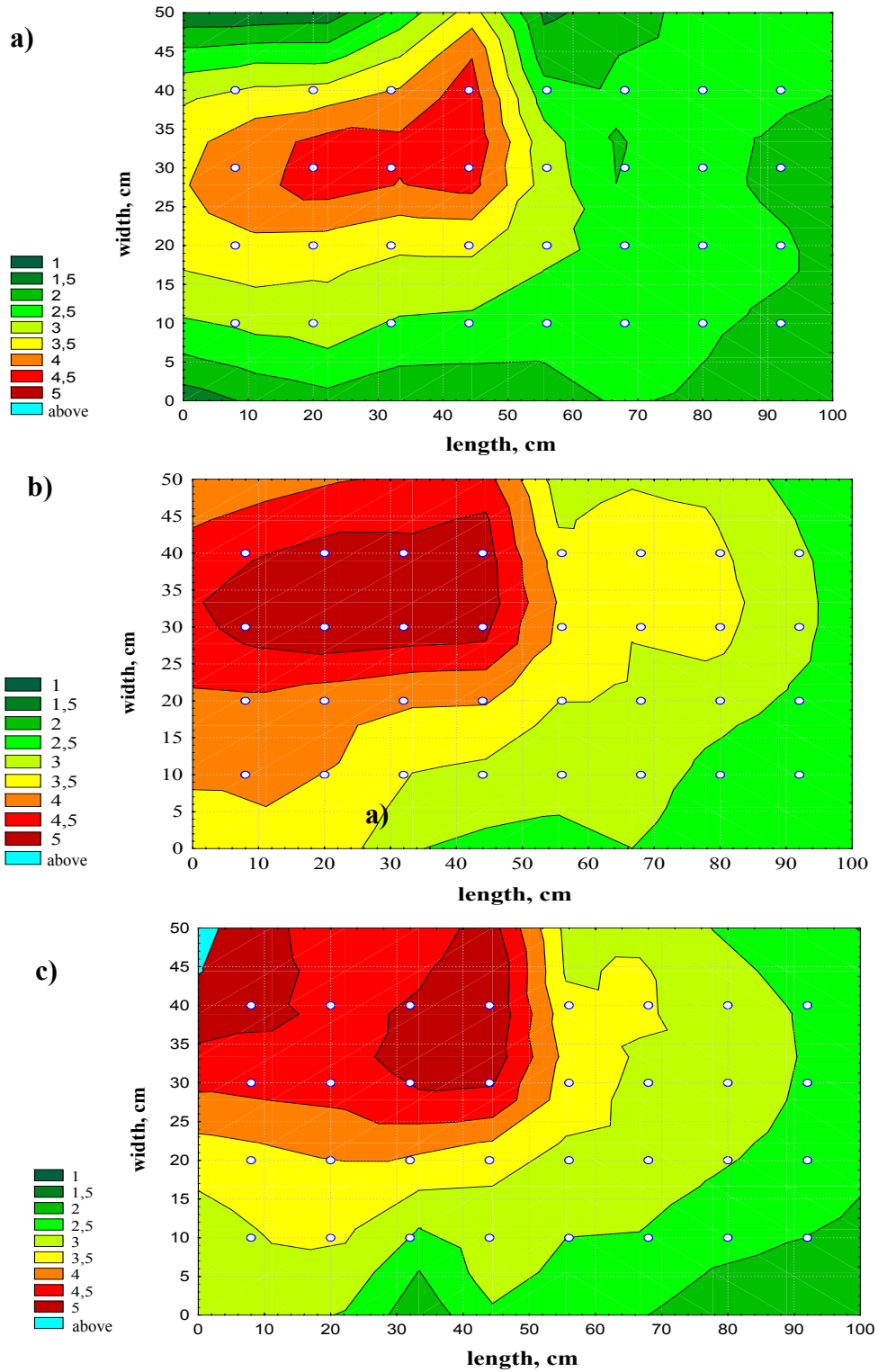

Figure 23. The floor thickness distributions measured with magnifier (a) and estimated with ultrasonic echo method (b,c) for the S12HB0.8-3 and 10V202 transducers, respectively.

Table 10. Results of floor thickness estimation and pull-off strength measurements

Pole	Ultrasonic testing								"true" thickness t, mm		pull-off strength, MPa	
	Transducer S12HB0.8-3				Transducer 10V202							
	Thickness t_{U-E} , mm		Amplification, dB		Thickness t_{U-E} , mm		Amplification, dB		Mean value	Standard deviation	Mean value	Standard deviation
	Mean value	Standard deviation	Mean value	Standard deviation	Mean value	Standard deviation	Mean value	Standard deviation				
After 7 d of hardening												
1	4.14	0.56	48.32	1.81	4.180	0.540	74.100	1.208	-	-	-	-
2	4.57	0.55	51.11	3.37	4.460	0.918	74.080	4.479	-	-	-	-
3	3.04	0.38	49.86	3.08	2.840	0.358	67.620	3.776	-	-	-	-
4	2.69	0.56	48.78	3.43	2.500	0.430	69.040	2.752	-	-	-	-
5	3.37	0.43	51.00	1.99	3.280	0.363	71.100	0.806	-	-	-	-
6	2.92	0.34	47.41	1.70	2.960	0.477	72.013	5.276	-	-	-	-
7	2.73	0.17	48.97	2.64	2.640	0.329	71.060	1.960	-	-	-	-
8	2.17	0.23	47.67	2.57	2.200	0.453	65.720	2.729	-	-	-	-
After 28 d of hardening												
1	4.44	0.60	63.73	2.32	4.080	0.638	86.560	2.482	3.88	0.66	2.87	0.34
2	4.72	0.39	66.11	3.11	4.600	0.696	86.760	3.692	4.21	0.63	0.66	0.52
3	3.10	0.36	63.67	3.21	2.860	0.428	83.340	3.303	2.29	0.48	0.95	0.44
4	2.81	0.61	64.47	3.45	2.440	0.503	81.000	3.156	1.98	0.56	2.75	0.25
5	3.52	0.52	65.21	2.18	3.200	0.424	82.440	2.981	2.96	0.37	0.52	0.11
6	3.24	0.37	60.93	2.46	3.000	0.361	82.960	1.071	2.67	0.38	1.37	0.43
7	2.84	0.22	62.62	3.17	2.540	0.365	79.720	1.221	2.36	0.31	0.96	0.24
8	2.32	0.29	59.67	3.10	2.220	0.377	78.260	2.269	2.07	0.15	0.80	0.21

6.2.5. Discussion of results

The floor thickness distributions presented in Fig. 23 indicated that the ultrasonic measurements with the echo method reproduced the trends in floor thickness very well. However, in comparison to the thickness distribution obtained directly with the Brinell magnifier, the ultrasonic method overestimated the floor thickness by about 0.3 mm to 0.5 mm, depending on the transducer type. The thickness measurement results were statistically analyzed to find a relationship between the thickness as determined with different methods. The floor thickness as estimated by the ultrasonic method after 7 d and 28 d of curing is in very good agreement (correlation coefficients $r > 0.95$) with the "true" thickness (Fig. 24) for both transducers. The thicknesses as estimated by the two transducers are close to each other. This displays the good repeatability of the ultrasonic method. In general, the relationship between thickness measured with magnifier, t , and thickness as estimated with ultrasonic method, t_{U-E} , can be described by a simple linear function:

$$t = A t_{U-E} \quad (17)$$

The correction coefficient A equals 0.88 for the S12HB0.8-3 transducer and 0.90 for the 10V202 transducer. The value of the A coefficient mainly depends on the transducer type, but hardening time and presence of the coupling agent can also affected the estimated value of thickness. It was observed that as the hardening time of the floor increased the A coefficient increased at an approximately constant dosage of coupling agent. This implies that during nondestructive evaluation of floor thickness a suitable correction coefficient should be introduced taking into account the device type, coupling agent used, and hardening time. The results obtained indicated that a value of the "A" coefficient equal to 0.89 is acceptable for both transducers. Surprisingly good results were also obtained for the 10 MHz transducer, which was theoretically more susceptible to ultrasonic wave attenuation than were the lower frequency transducers.

Analysis of the amplification coefficient ($W_{0.8H}$) results showed that a relation between the level of amplification and the pull-off bond strength did not exist (Fig. 25) for both hardening times. The value of attenuation $W_{0.8H}$ for a "zero-adhesion" state of polymer coating (see Fig. 21) was located between the points corresponding to different levels of adhesion. This indicated that evaluation of the adhesion in PC-CC systems with an ultrasonic echo method is difficult because of the high difference between the acoustic impedances of the PC coating and concrete substrate. In the case of the 10V202 transducer (frequency 10 MHz), a statistically significant relation between thickness and amplification was observed. This implies that the differences found in the values of the amplification coefficient $W_{0.8H}$ measured on fields with various adhesion levels may be at least 70 % the result of the differences in the floor thickness (Fig. 26 a). The effect of the floor thickness was less significant in the case of the S12HB0.8-3 transducer (Fig. 26b). A statistical significance with high determination coefficient was obtained for the relationship between attenuation $W_{0.8H}$ and the "true" thickness as measured with the magnifier (Fig. 26c).

The results obtained confirmed that the ultrasonic echo method can be useful for the non-destructive evaluation of the polymer coating floor thickness. However, there is need for further investigation to establish optimal parameters for the ultrasonic measurements, which are mainly the type and the frequency characteristics of the transducers used.

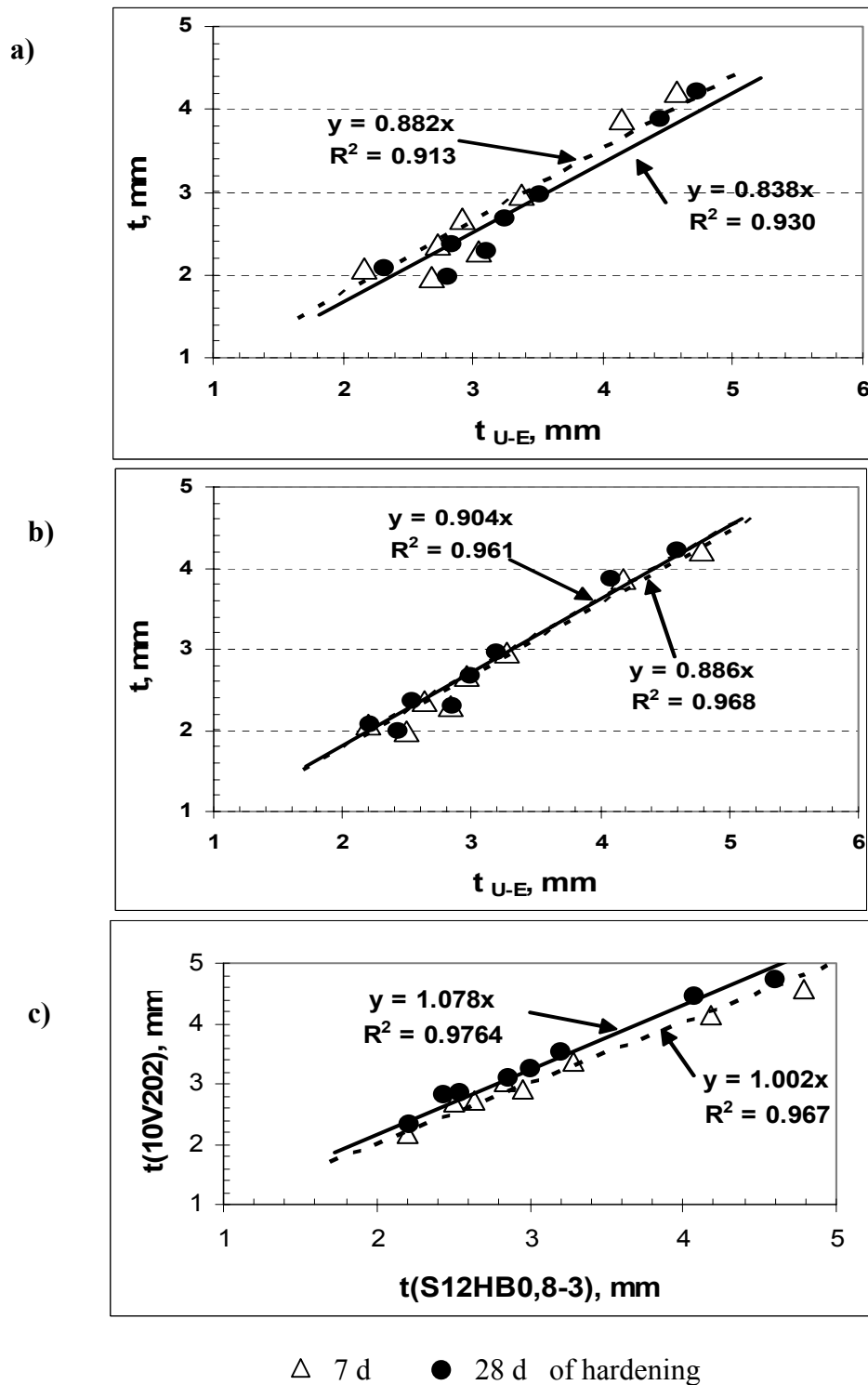

Figure 24. Relationship between "true" value of floor thickness and estimated with ultrasonic echo method using transducer a) S12HB0.8-3, b) 10V202, and c) thickness estimated with both transducers.

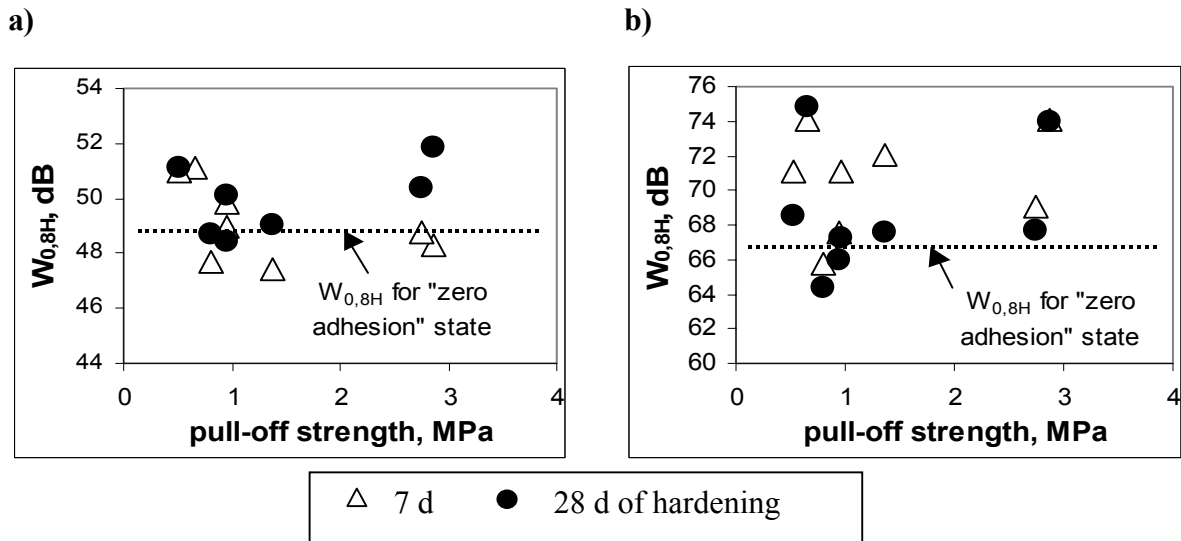

Figure 25. Pull-off strength against amplification $W_{0,8H}$ for tested epoxy floor system with transducers: a) S12HB0.8-3 and b) 10V202

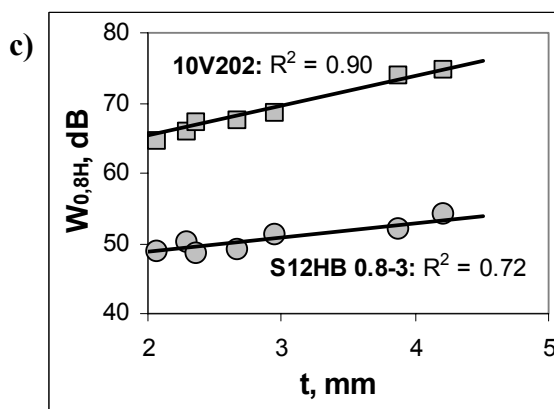
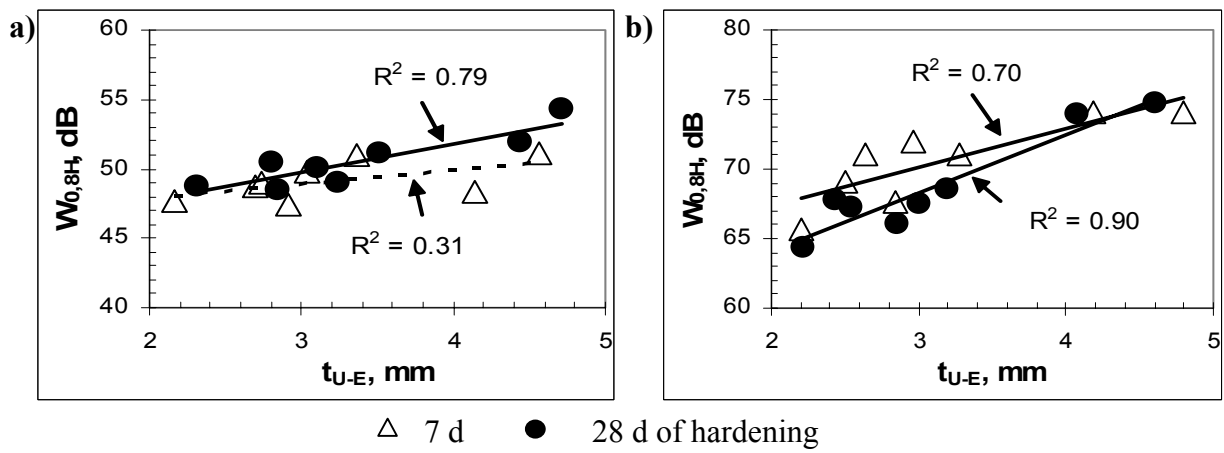

Figure 26. Amplification coefficient $W_{0,8H}$ plotted against the estimated thickness t_{U-E} for epoxy floor systems tested with transducers: a) S12HB0.8-3 and b) 10V202; c) amplification coefficient $W_{0,8H}$ vs. "true" thickness for both transducers after 28 d of floor hardening.

6.3. Evaluation of multi-layer system with pulse velocity method

6.3.1. Ultrasonic test procedure

The ultrasonic evaluation of adhesion in the PC-CC system was carried out using the indirect pulse velocity method. It was assumed that areas with poor adhesion influence the recorded waveforms (Fig. 27) by attenuating the reflections more rapidly. In consequence, the changes in parameters describing the waveform were used to describe the adhesion in the PC-CC system.

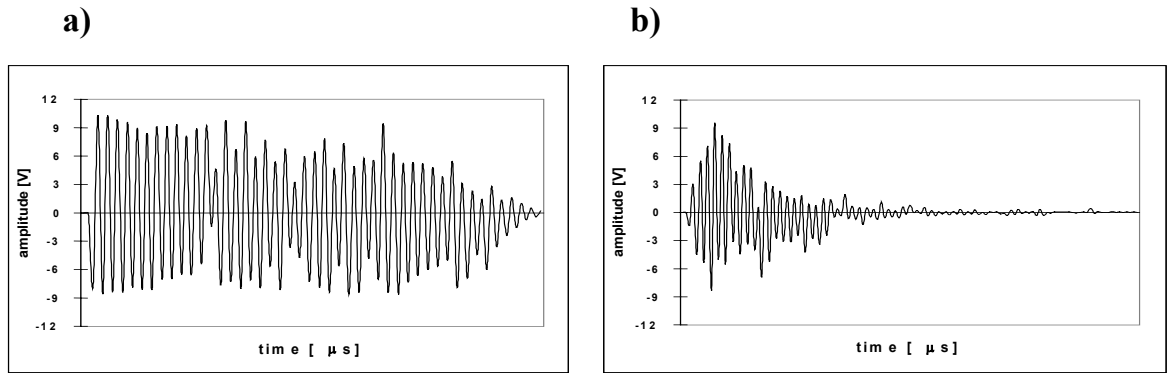

Figure 27. Received ultrasonic pulse for (a) good adhesion and (b) poor adhesion in the PC-CC system.

The investigations were carried out with a commercial concrete tester with sets of associated transducer pairs (Fig. 28). The source pulse frequency of the compressive wave was 100 kHz. The distance between transducers was fixed and equal to 80 mm. A gel was used as a coupling medium to improve acoustic contact between the samples and the transducers. The transmitted wave pulse was transformed into digital signals (sampling period 0.2 μs) by an A/D converter system and then fed into a microcomputer for a waveform analysis. The time versus voltage record was averaged with six previously recorded pulse signals to reduce the effects of random noise and the heterogeneity of the microstructures of both the polymer composites and the concrete substrate. Each ultrasonic pulse was recorded after tester stabilization was indicated. These nondestructive measurements were carried out after 7 d of hardening of each type of coating.

The propagation of ultrasonic waves through the PC-CC system was characterized by the pulse velocity, calculated from the transit time, and by the changes of a mean square value parameter, $MS(t)$, defined in the time domain. The MS value at a given time was calculated from the formula:

$$MS(t) = \frac{\sum_{i=n_o}^{i-n_i} A_i A_i}{(n_i - n_o)} \quad (18)$$

where A_i is the amplitude of the i th-recorded point [V] and n_o is the number of the first point with amplitude different than zero. The plot of the MS value describes the amplitude variance in the time domain and is a representation of the attenuation of the wave pulse. In this work, we assumed that for a sample area of poor adhesion, the MS value would statistically decrease faster than for an area of high adhesion. This assumption is justified by results like those shown in Fig. 27.

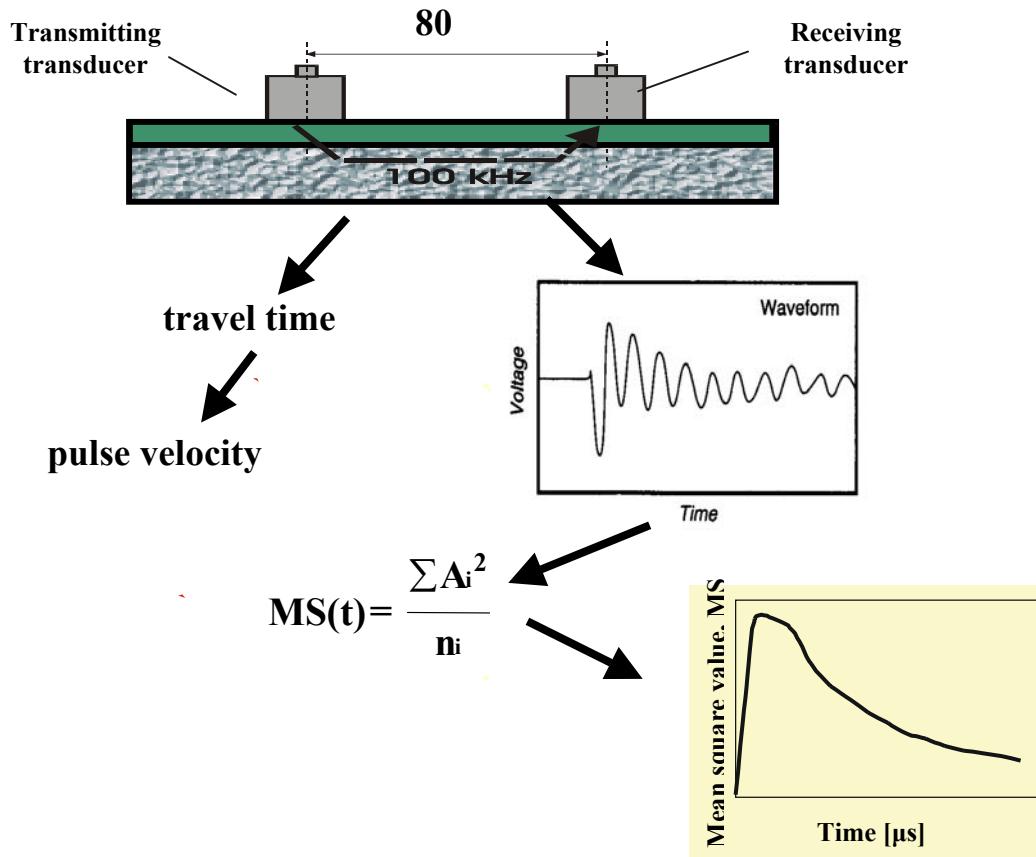

Figure 28. Scheme of ultrasonic procedure for evaluation of adhesion between polymer composites and concrete substrate.

6.3.2. Materials and tested floor systems

The investigations were carried out for the polymer industrial floor systems described in Table 11: epoxy (EP), polyurethane (PUR) and vinyl ester (VE) coatings. All coating systems were layered on a portland cement concrete substrate (B35 class, which has a characteristic compressive strength of 35 MPa), prepared from the same concrete mix. This concrete class was selected to have a relatively strong substrate in order to obtain failure in the PC-CC bond line (adhesive failure mode) and to be close to the real concrete substrate used in the floor industry (concrete with compressive strengths greater than 25 MPa). For the evaluation of the usability of the pulse velocity method for assessment of the adhesion, three experiments were carried out:

- ultrasonic evaluation of adhesion at maximum and minimum adhesion levels,
- analysis of relationship between pull-off strength and ultrasonic parameters,
- ultrasonic detection of defects in the PC-CC system.

Table 11. Chemical composition and pull-off strength of tested polymer coatings (from producer technical data sheets)

Property	Symbol of polymer coating			
	EP-1	EP-2	PUR	VE
Chemical composition	Water dispersion of epoxy resin	Epoxy resin	Polyurethane resin	Vinyl-ester resin
Number of components	2	2	2	1+ 3 (hardening system)
Max. grain size of fine filler, mm	< 0.1	< 0.1	< 0.1	< 0.125
Nominal thickness, mm	0.7 - 3	1 - 5	0.5 - 4	1 - 3
Pull-off strength (concrete substrate: compressive strength > 25MPa)	> 1.5 MPa	> 2.5	> 2	> 1.7

6.3.3. Ultrasonic evaluation of adhesion at boundary conditions

The pulse waveforms were analyzed for two boundary conditions (Fig. 29):

- maximum adhesion (for a given type of polymer coating),
- zero-adhesion (corresponding to delamination).

To simulate delamination the polymer coating was prepared on a metallic foil with an anti-adhesion agent, and next put onto a cement concrete substrate. The investigations were carried out for three commercial floor systems: EP, PUR and VE, of nominal thickness 3 mm and containing a quartz filler (maximum grain diameter $D_{max} < 0.1$ mm).

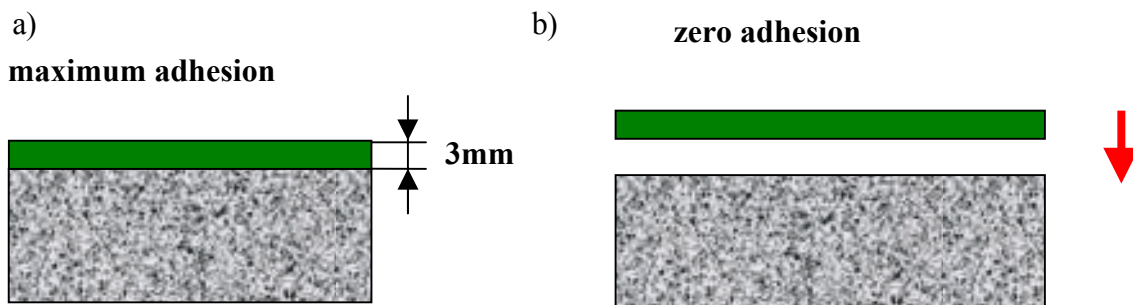
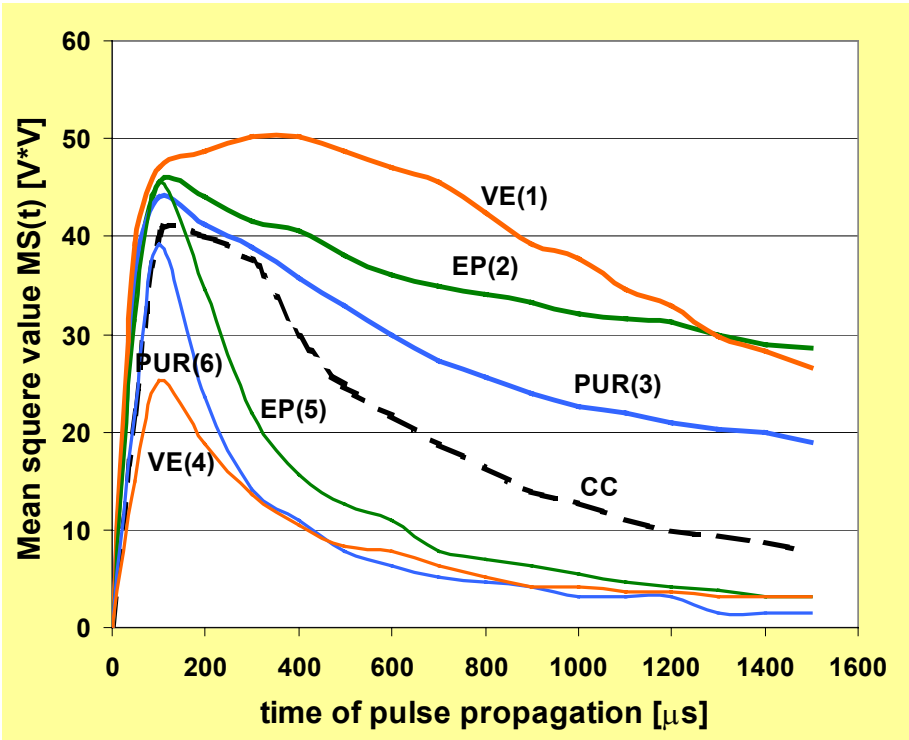

Figure 29. Scheme of ultrasonic evaluation of adhesion for two conditions: (a) maximum adhesion and (b) zero-adhesion.

The average pull-off strength obtained for the EP, VE and PUR coating systems was equal to 3.23 MPa, 3.45 MPa, and 2.10 MPa, respectively. Cohesive failure in the concrete substrate was obtained during the pull-off test for the EP and VE coatings. In the case of the PUR coating, a mixed failure mode (70 % cohesive failure in concrete and 30 % adhesive failure in the

PC-CC bond line) was observed. This confirmed that for the “maximum adhesion” state high adhesion in the PC-CC system was actually developed. On the basis of waveform analysis, the transit time and the MS value (Fig. 30) were selected as useful parameters for further investigations. The amplitude values registered by the tester were not significantly correlated with the adhesion level for all tested systems.

The MS values for coatings with maximum adhesion and zero adhesion were significantly different. The MS plot determined for the concrete substrate without any polymer coating was located between the MS plots for the coatings with maximum adhesion and with zero-adhesion. In the case of the epoxy coating, the pulse velocity for the zero-adhesion state, $v_p = 2623$ m/s, was close to the pulse velocity determined with the direct method, $v_p = 2650$ m/s (see. p.6.2). This result confirmed that the ultrasonic wave penetrated both the polymer coating and the concrete substrate. In the case where delamination was present, the ultrasonic wave traveled only through the polymer coating. The highest difference of the MS value between the maximum adhesion state and the zero adhesion state was observed to fall in the range of 400 μ s to 700 μ s in the time domain. The MS value at 500 μ s in the time domain was used in most of the analysis in this report.



Floor system	Pull-off strength [MPa]	Pulse velocity [km/s] (stand. dev.)	Floor system	Pull-off strength [MPa]	Pulse velocity [km/s] (stand. dev.)
VE(1)	3.45	4.460 (0.032)	VE(4)	-	2.703 (0.012)
EP(2)	3.23	4.460 (0.032)	EP(5)	-	2.623 (0.007)
PUR(3)	2.10	4.420 (0.020)	PUR(6)	-	2.339 (0.010)

CC: pulse velocity 4.908 km/s (stand. dev. 0.030)

Figure 30. The pull-off strength, pulse velocity and MS distribution in the time domain for the tested polymer coating systems.

6.3.4. The effect of chemical composition and geometry of polymer coating

Ultrasonic wave propagation through the PC-CC system [64] was analyzed for each type of floor system and for three thickness values of the polymer coating: 1 mm, 2 mm, and 4 mm. Additionally, the effect of using coarse filler, 0.3 mm to 0.7 mm in size, on wave propagation was tested. This kind of filler is commonly added to improve the abrasion resistance of a polymer coating.

The results obtained indicate that ultrasonic wave propagation through the PC-CC system is affected by the type of resin binder, the presence of coarse filler, and the thickness of the polymer coating. The addition of the coarse filler (Fig. 31) significantly decreased the pulse velocity and the MS value for the EP-1 coating, while for the PUR system this effect was not significant. As the coating thickness increased, the pulse velocity and MS value decreased (Fig. 32). The largest changes were observed for the EP-1 and PUR floor types. In the case of the EP-2 coating, the effect of coating thickness was less significant. The results indicate that for proper ultrasonic evaluation of adhesion in a PC-CC system, a suitable reference curve should be determined, with coating composition and thickness considered as factors affecting the propagation and attenuation of ultrasonic waves. The value of the coating thickness can be verified using the echo method (see p.6.2).

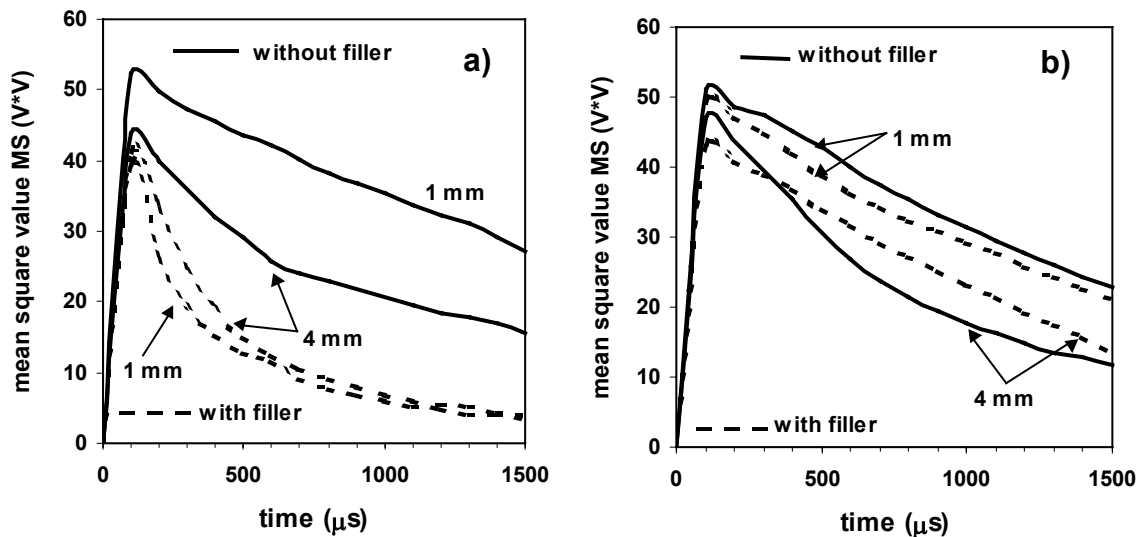

Figure 31. MS value distribution for (a) EP-1 and (b) PUR coatings with and without coarse filler

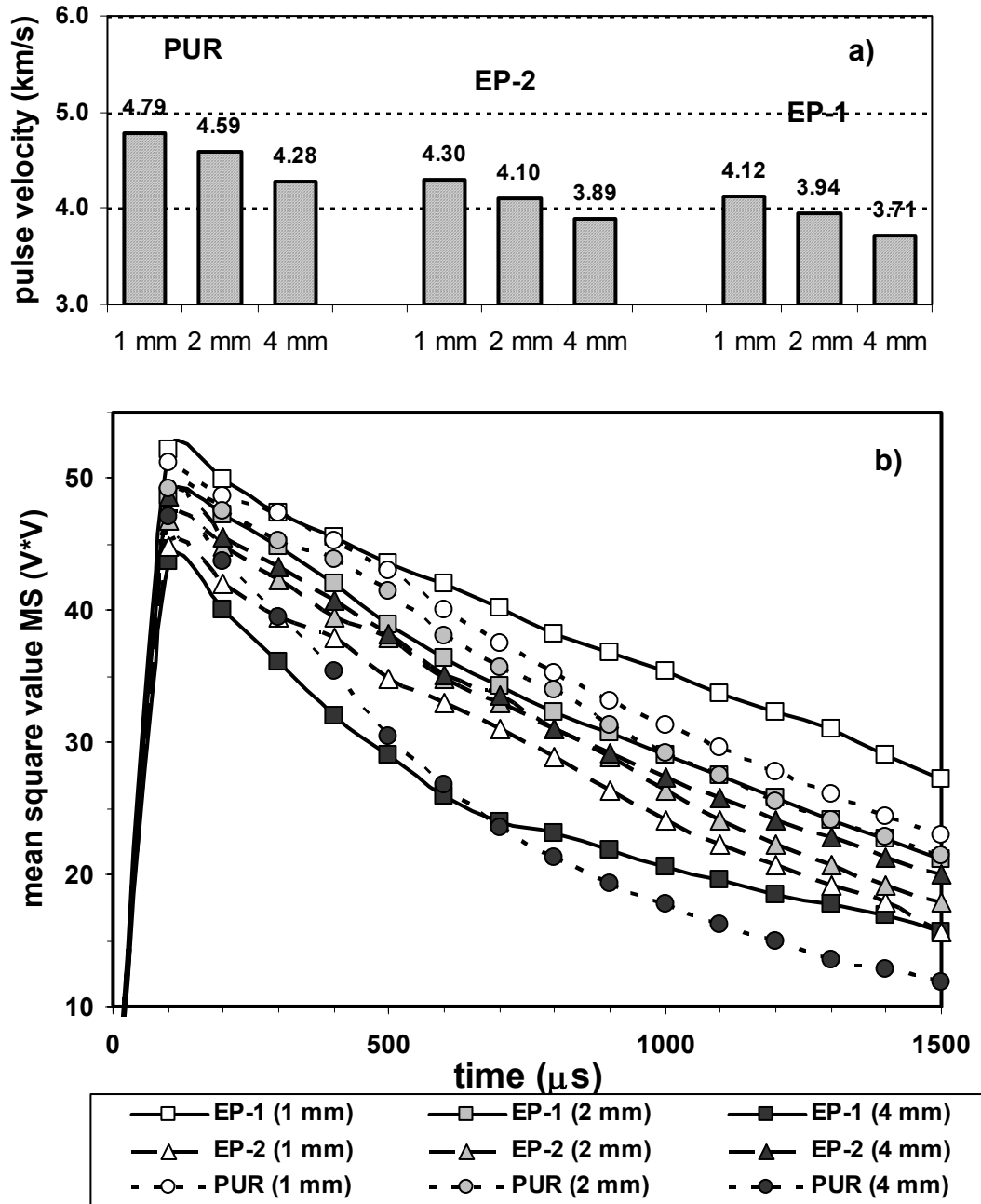

Figure 32. Pulse velocity (a) and MS value distribution (b) for three values of the thickness of the polymer coatings.

6.3.5. Relationship between pull-off strength and ultrasonic parameters

The relationship between the “pull-off” strength and the ultrasonic parameters was tested for four floor system types (Fig. 33): VE (3 mm thickness), EP-1, EP-2 (2 mm thickness), and PUR (0.7 mm thickness). The concrete substrates differed in moisture content, and were prepared with and without primer in order to obtain a continuous range of adhesion in the PC-CC system. Each variant of polymer floor was prepared on a concrete plate of dimension 250 mm x 250 mm x 50 mm. The pull-off test was measured at five different locations and the ultrasonic measurements were tested at fifteen different positions for each floor specimen in order to determine average values. Statistical analysis of the results was next performed to establish the regression function between the “pull-off” strength and the ultrasonic parameters.

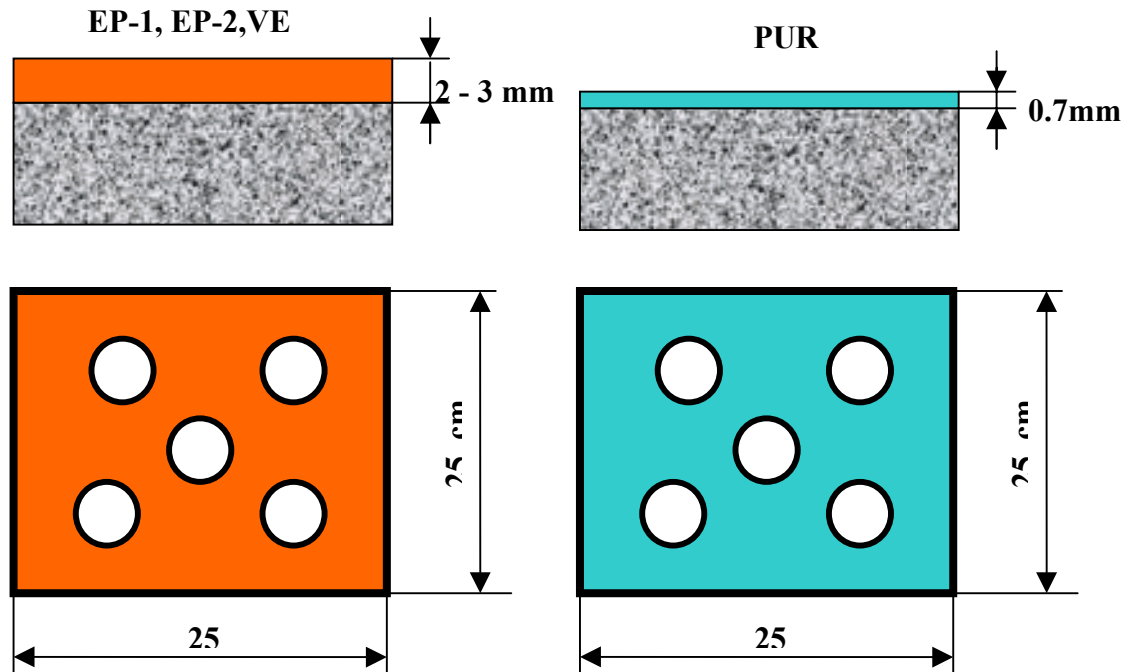

Figure 33. Scheme of ultrasonic evaluation of the relationship between pull-off strength and wave parameters for “thick” VE and “thin” PUR coatings. The concrete substrates differed in moisture content, surface quality, and presence of primer.

For the thick VE coating and the thin PUR coating the pulse velocity (Fig. 34), and the MS value were measured for points corresponding to 500 μ s and 1500 μ s in the time domain (Fig. 35) and were selected as the parameters describing ultrasonic wave propagation and attenuation, respectively. For both coating systems, the relationship between pull-off strength and pulse velocity was characterized by a relatively low correlation coefficient, $r = 0.52$ (VE) and $r = 0.62$ (PUR). Higher correlation coefficients were obtained for the regression functions determined from the MS values. For the VE system, the highest correlation coefficient ($r > 0.86$) was obtained for the relationship MS (500 μ s) vs. time. In the case of the PUR system, the highest correlation coefficient ($r > 0.95$) was obtained for the relationship MS (1500 μ s) vs. time. These results indicated that for evaluation of the adhesion in PC-CC system a suitable reference curve can be determined, with coating thickness considered as a factor that affects the attenuation of the ultrasonic wave.

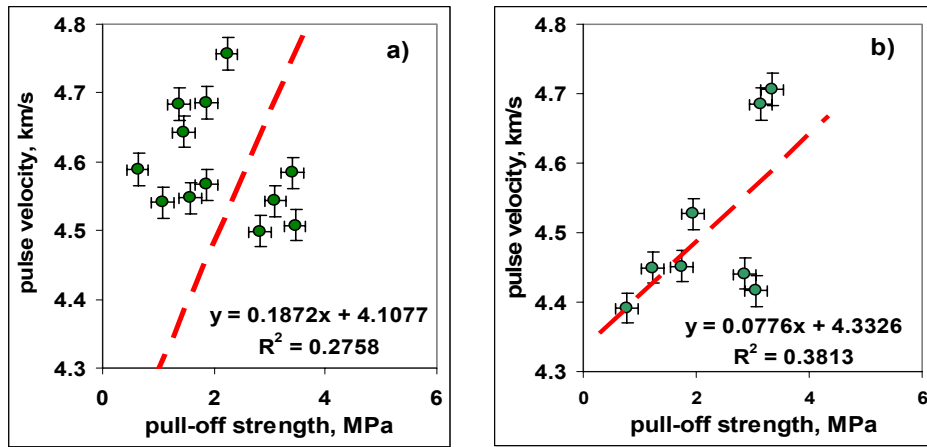

Figure 34. Pulse velocity against pull-off strength for (a) "thick" VE and (b) "thin" PUR coatings

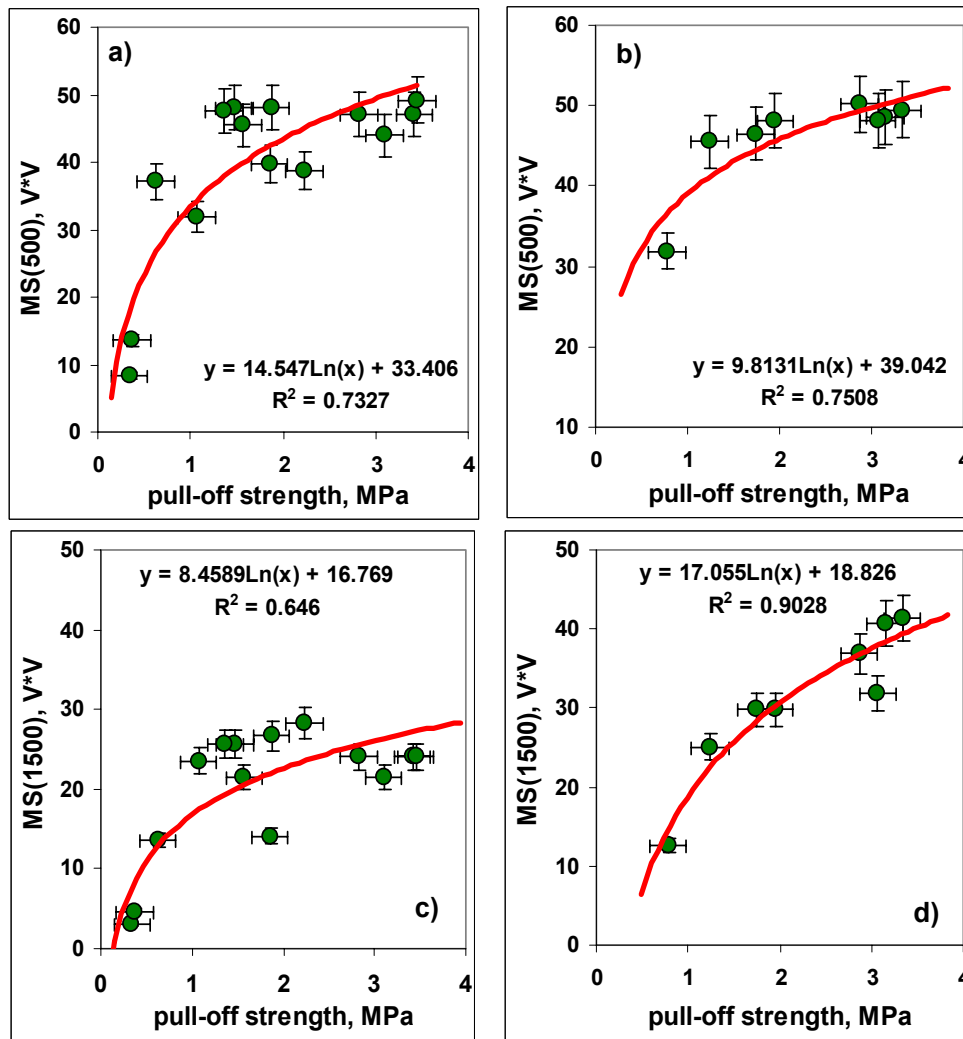

Figure 35. Relationship between mean square value MS and pull-off strength calculated for the VE coating: (a) MS (500 μ s) and (c) MS (1500 μ s), and for the PUR coating: (b) MS (500 μ s) and (d) MS (1500 μ s).

In the case of the EP-1 and EP-2 coatings [64], the pulse velocity was approximately constant (Fig. 36a) for a wide range of the pull-off strength, 1 MPa to 3.5 MPa, and its value was

significantly higher in comparison with the velocity measured for the "zero-adhesion" state. For both epoxy coatings, the relationship: MS (500 μ s) vs. pull-off strength (Fig. 36b) was characterized by a high correlation coefficient value: $r > 0.97$. The relationship of MS (500 μ s) vs. the pull-off strength can be described by the following formula:

$$\text{EP-1:} \quad \text{MS (500 } \mu\text{s)} = -3.43 f_a^2 + 23.17 f_a + 3.58 \quad (19)$$

$$\text{EP-2:} \quad \text{MS (500 } \mu\text{s)} = -2.68 f_a^2 + 18.44 f_a + 8.64 \quad (20)$$

where the MS (500 μ s) value is in V*V and the pull-off strength, f_a , is in MPa.

For all coating systems tested, adhesive or mainly adhesive failure modes were observed up to approximately 2.0 MPa. As the pull-off strength increased above this point, the failure mode approached pure cohesive failure in the concrete substrate. The results obtained indicate that relationships between the pull-off strength and the parameters of ultrasonic wave propagation are valid for only a limited range of pull-off strength. This is a result of the nature of the pull-off test – maximum bond strength corresponds to the tensile strength of the concrete substrate. On the other hand, if the adhesion of the polymer coating to the concrete substrate is high the acoustic coupling is enough to propagate an ultrasonic wave through the PC-CC system. Figures 35 and 36 show that the MS (500 μ s) value attained a maximum when the pull-off strength achieved a maximum value close to the tensile strength of the concrete substrate.

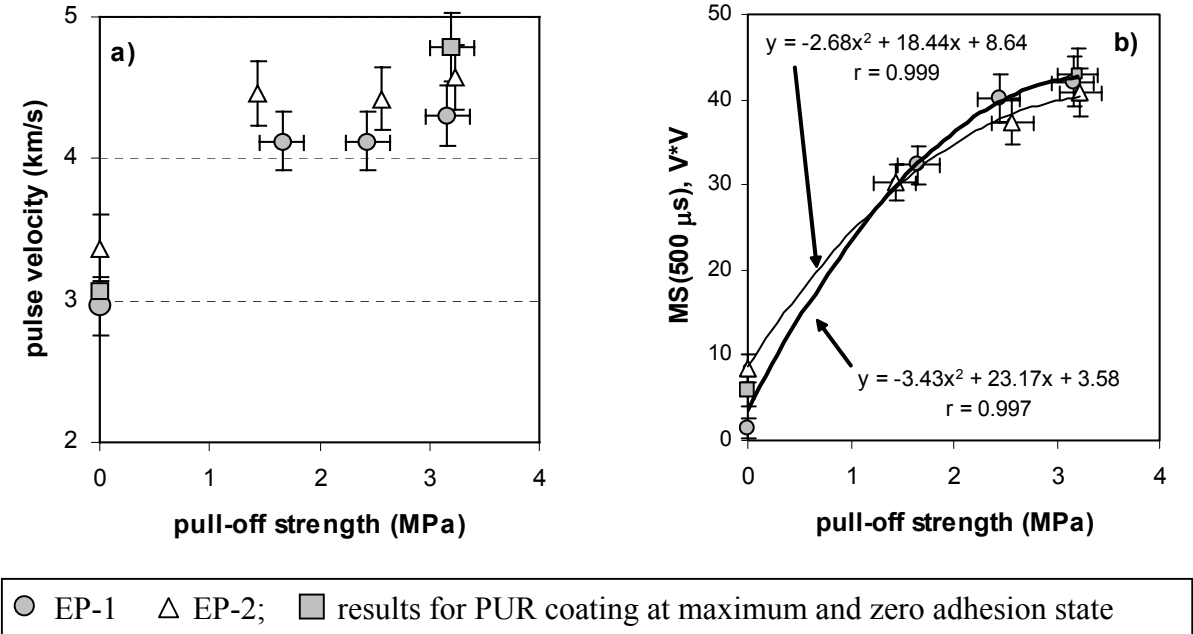

Figure 36. Pulse velocity (a) and MS (500 μ s) value (b) vs. the pull-off strength for the epoxy coatings tested.

6.3.6. Ultrasonic detection of defects in PC-CC system

The possible ultrasonic detection of defects in a PC-CC system was tested for the EP-1 and EP-2 epoxy coatings that had artificial defects introduced at the PC-CC interface. In the first part of experiment, ultrasonic defect detection was performed for floor systems having an unknown relationship between the pull-off strength and various ultrasonic parameters. In second part of the

experiment, an approximate relationship between the pull-off strength and the MS value was used to compute the adhesion mapping.

In the first part of the experiment, the EP-2 epoxy coating (3 mm thick) was layered on a concrete plate having dimensions 600 mm x 30 mm x 50 mm. Artificial defects were prepared in the form of polyethylene thin film sheets of different shape and dimensions, which were put on the concrete substrate under the top coating (Fig. 37). The EP-2 floor sample was divided into a regular grid. At the nodes of this grid, six ultrasonic measurements were carried out in two perpendicular directions. After the ultrasonic measurements were performed, the “pull-off” strength was also measured at the nodes of the grid.

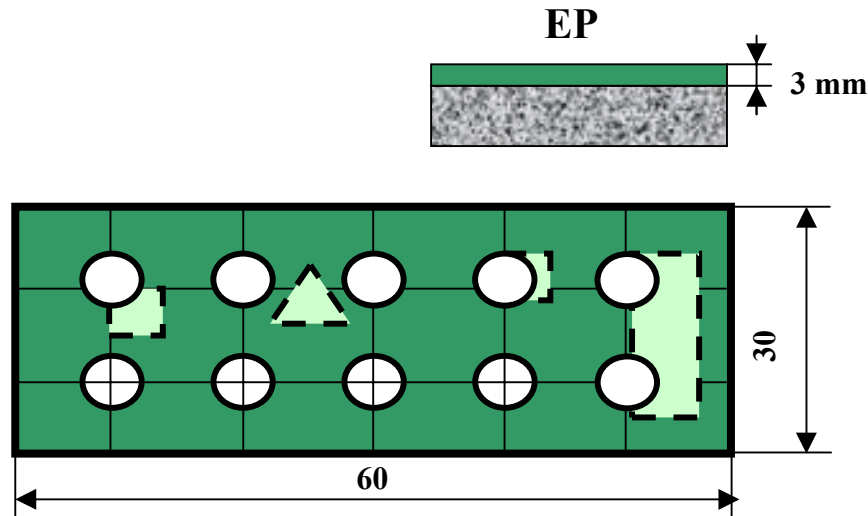

Figure 37. Sample for ultrasonic detection of defects in PC-CC system

The results obtained for the ultrasonic measurements and the pull-off strength at particular nodes of the grid were analyzed next. The results were created in two separate groups of measurement points – one for a low and one for a high value of the pull-off strength. This implies that from a statistical point of view, the plots obtained for pull-off strength vs. pulse velocity (Fig. 38a) and pull-off strength vs. the MS (1500 μ s) value (Fig. 38b) could not be used as reference curves for nondestructive estimation of the pull-off strength. The negative exponential approach to estimation was used to determine the distributions of the measured pull-off strength (Fig. 38c) and the MS (1500 μ s) value (Fig. 38d). In general, the pull-off strength and the MS (1500 μ s) value were decreased in the defect areas. However, the MS value distribution, in contrary to the pull-off strength distribution, indicated the defect presence (coordinates: 200 mm, 200 mm). It was confirmed in the pull-off test. The results obtained indicate that the ultrasonic pulse method can be used for defect detection in PC-CC systems, at least as an introductory test.

The same experiment was carried out for the EP-1 and EP-2 floors [64], for which the relationship between the pull-off strength and MS (500 μ s) value was already established. The EP-1 and EP-2 epoxy coatings (2 mm thick) were layered on concrete substrates of dimensions 400 mm x 400 mm x 50 mm. Artificial defects were prepared in the same way as previously, and the specimens were divided into a regular grid. At the nodes of this grid, eight ultrasonic measurements were carried out in directions inclined at 45° to each other. In selected nodes, the pull-off strength was also determined. The results of the ultrasonic measurements were statistically analyzed. The least squares method of estimation was used to determine the distribution of the MS (500 μ s) value for the EP-1 and EP-2 coatings (Fig. 39). Equations 2 and 3 were used to obtain the corresponding pull-off strength distribution (see the right scale in Fig. 39). A low pull-off strength was obtained

only when a steel dolly was placed completely in the defect area. In general, the experimental pull off strength was higher than 2 MPa, even at the points where steel dollies were partially placed in the defect area. This can lead to overestimation of the pull-off strength. Contrary to the experimental results of the pull-off strength, the MS value distribution properly indicated the presence of defects. The MS (500 μ s) value decreased at defect sites and the corresponding variational coefficient of the MS value increased.

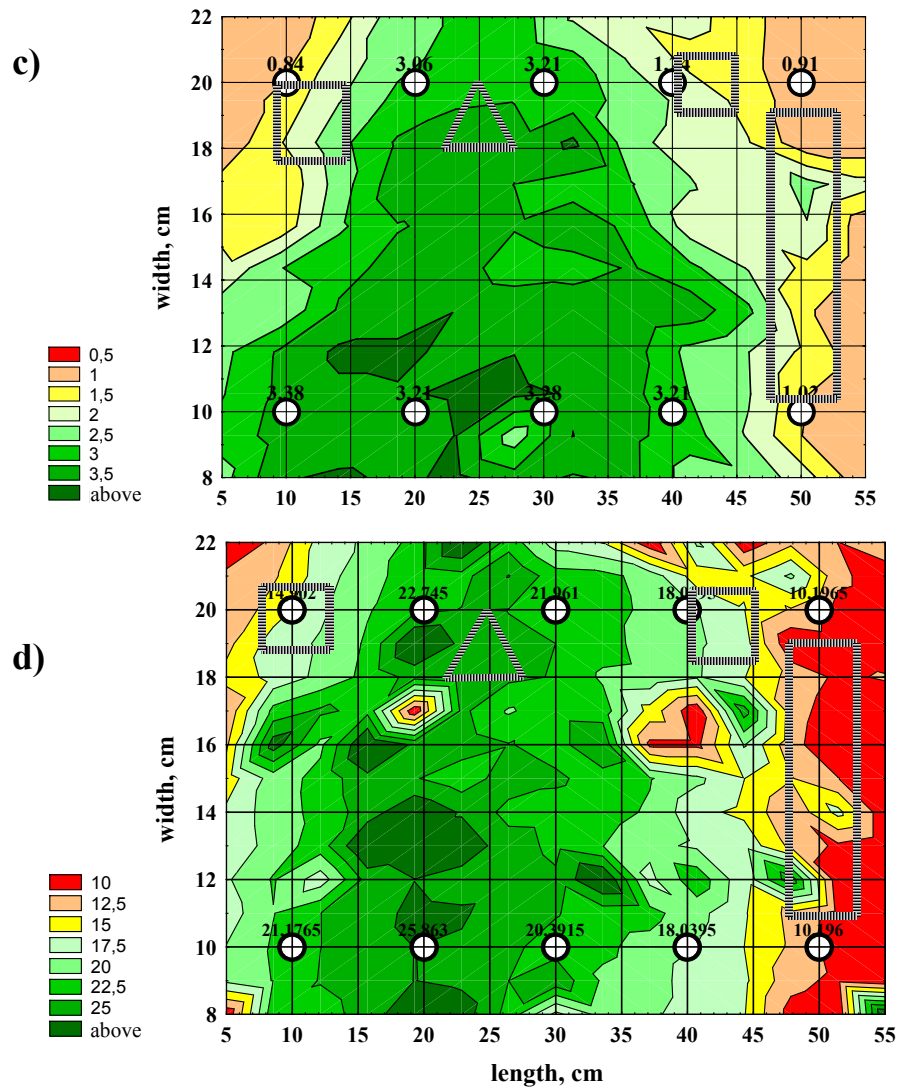
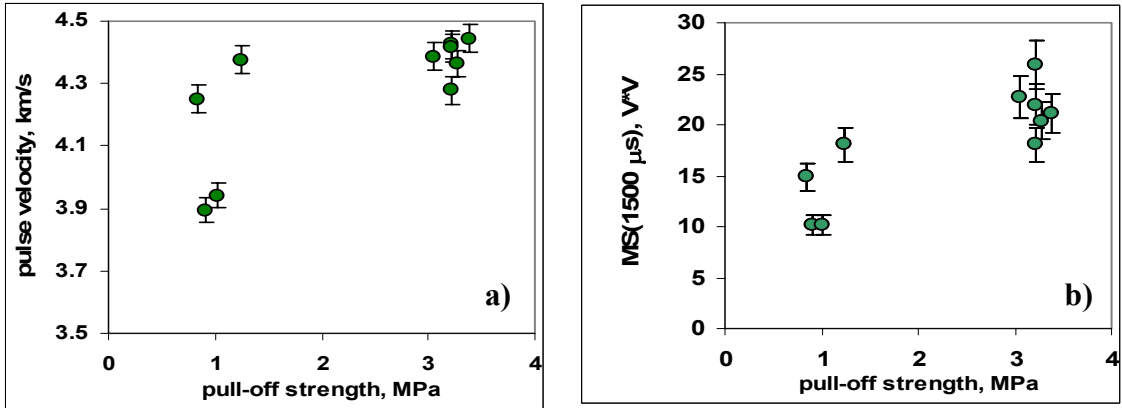

Figure 38. Relationships: pull-off strength vs. (a) pulse velocity, (b) the MS (500 μs) value and the distributions of (c) pull-off strength and (d) the MS (500 μs) value on the PC coating sample with artificial defects.

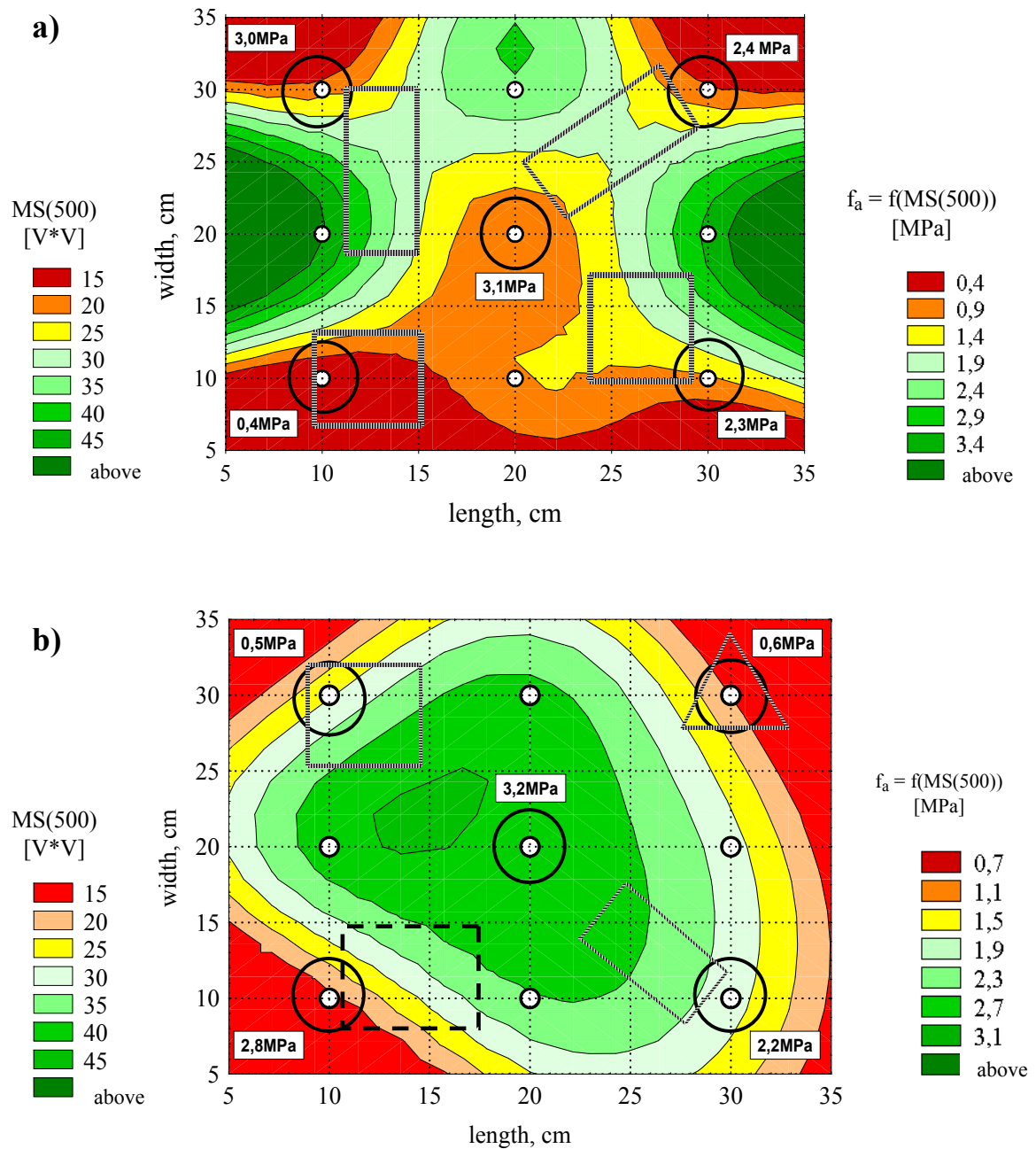

Figure 39. Results of the ultrasonic mapping of the adhesion for (a) EP-1 and (b) EP-2 coatings (2 mm thick) with artificial defects (dotted line contour); on the left the scale for the MS value and on the right the scale for the pull-off strength recalculated using the regression functions (see Fig. 35). The experimental values of the pull-off strength (measured in the solid line circle) are included in the white rectangles.

6.4. Conclusions concerning ultrasonic evaluation of the multi-layer PC-CC system

On the basis of the results obtained and described in this report, the following conclusions about ultrasonic evaluation of the multi-layer PC-CC system, which is created as a result of repair or anticorrosion protection application, are as follows.

1. The ultrasonic echo (U-E) method can be used for nondestructive estimation of the polymer coating thickness. The possibility of defect detection in the PC-CC system with this method needs further investigation and the evaluation of adhesion with this method seems to be less promising.
2. The regression functions obtained for various coating systems justify potential application of the indirect pulse velocity method for nondestructive evaluation of the adhesion between the polymer coating and the concrete substrate, as well as for mapping of the adhesion distribution.
3. A reference adhesion curve should be developed for a given type of polymer coating (including its composition and thickness), for a wide range of adhesion, from the "zero adhesion" state to the maximum adhesion state. On this basis, the following steps for the nondestructive assessment of adhesion between polymer coating and concrete substrate (Fig. 40) can be formulated:
 - (a) selection of measurement points,
 - (b) determination of the $MS(500 \mu s)^{REF}$ value distribution with indirect pulse velocity methods; measurement of $MS(500 \mu s)^{EXP}$ value around the selected points (at least four measurements at each point),
 - (c) evaluation of the coating thickness with ultrasonic-echo method,
 - (d) recalculation of $MS(500 \mu s)^{EXP}$ into $MS(500 \mu s)^{REF}$ for measured coating thickness (eg. on the basis of a suitable regression function or graph $MS(500 \mu s)$ value vs. coating thickness),
 - (e) estimation of adhesion strength from the reference curve: pull-off strength vs. $MS(500 \mu s)^{REF}$.

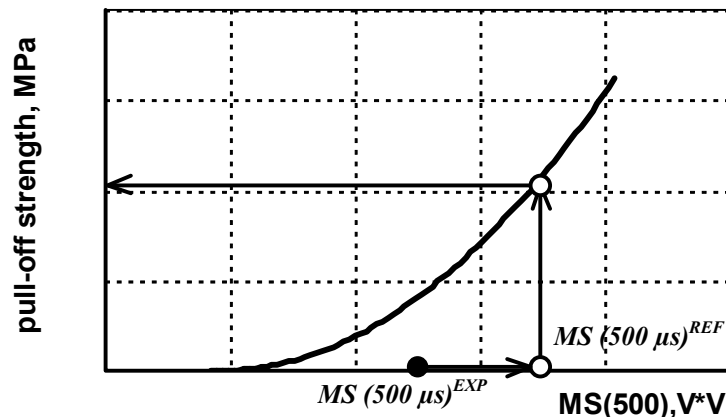

Figure 40. General scheme of ultrasonic evaluation of the adhesion between polymer coating and concrete substrate (description above in text).

4. The relationship between the pull-off strength and the parameters of ultrasonic wave propagation are valid for only limited range of pull-off strength. If the adhesion of the polymer coating to the concrete substrate increases the $MS(500 \mu s)$ value approaches to the maximum for the pull-off strength value close to the tensile strength of the concrete substrate.

5. The results obtained indicate also the need for further investigation to improve the accuracy of the ultrasonic estimation of the adhesion in the PC-CC system using an advanced method of signal analysis (e.g. spectral analysis) or data analysis (e.g. multiple regression).

7. SUMMARY AND CONCLUSIONS

The main goal of the project entitled "Ultrasonic evaluation methods applicable to polymer concrete composites" was the evaluation of the potential of ultrasonic methods for assessment of polymer concrete composite properties. The project was carried out the framework of the M.Skłodowska-Curie US-Polish Joint Fund II. The research task was analyzed taking into account the two main fields of polymer composite application: anticorrosion protection of concrete structures, including industrial floors, and pre-cast elements made from PC. For all these applications, one of the most important issues is quality control (verification tests) and diagnosis tests during structural service. For these purposes, the application of two ultrasonic methods, a pulse velocity method and an echo method, were considered. In the case of pre-cast elements, this work focused on the elaboration of principles of how to evaluate polymer concrete properties with the pulse velocity method. The main goal of the ultrasonic evaluation of a multi-layer PC-CC system created during repair and/or anticorrosion protection was quality control of the repair efficiency, particularly an estimation of layer thickness, detection of defects in the interface region, and mapping of the adhesion between polymer composites and concrete substrate. In this field, the usefulness of the echo method and the indirect pulse velocity method were considered.

The results obtained, in the form of regression functions, confirmed the usefulness of the ultrasonic methods for nondestructive evaluation of polymer composites in various applications. The pulse velocity method can be used for evaluation of the properties and homogeneity of the precast elements made from polymer concrete as well as for evaluation of adhesion in the multi-layer PC-CC systems (the adhesion mapping). The ultrasonic echo method is useful for nondestructive estimation of PC layer thickness.

The project results were presented in scientific journals and at international conferences. Nondestructive evaluation of multi-layer repair systems, including especially adhesion mapping, has appeared as the most interesting possibility. A more detailed report reviewing nondestructive methods applicable to the evaluation of adhesion will be published as a subchapter of the final report of RILEM Technical Committee TC-151 "Adhesion Technology in Concrete Engineering – Physical and Chemical Aspects." The results will be also used during preparation of a book chapter on the nondestructive evaluation of industrial floors. This chapter will be published in the report of the new RILEM Technical Committee, RILEM TC-184 IFE "Industrial floors for withstanding harsh environmental attacks, including repair and maintenance."

8. REFERENCES

1. L.Czarnecki "The status of polymer concrete" *Concrete International Design and Construction* 7, 47, 1985.
2. D.W.Fowler "Current status of polymer concretes in United States" *Proc. of Inter.Congress ICPIC'98, Bologna (Italy)*, 37, 1998.
3. J.T.Dikeou "Structural design of polymer concrete products", *ibid.*, 277.
4. L.Czarnecki, A.Garbacz: "Betony winyloestrowe jako materiał wanien elektrolitycznych", II Ogólnopolskie Sympozium - Kompozyty i Kompozycje Polimerowe, Szczecin (1994), 317-320.
5. L.Czarnecki, A.Garbacz, P.Łukowski, J.R.Clifton, "Polymer Composites for Repairing of Portland Cement Concrete: Compatibility Project", United States Department of Commerce, Report no. NISTIR 6361, Gaithersburg, MD, 1999.
6. J.Clifton, L.Czarnecki, P.Łukowski "Application of material model in optimization of polymer concretes", *Proc. of Inter. ICPIC Congress, Oostende (Belgium)*, 293, 1995.
7. L.Runkiewicz, "Analysis of damages and catastrophes of building structures as a result of corrosion" *Proc.of X Conf. Kontra'96 -Durability of Buildings and protection against corrosion, Zakopane (Poland)*, 237, 1996.
8. R.G.Mathey, J.R.Clifton "Review of nondestructive evaluation methods applicable to construction materials and structures", *NBS Technical Note 1247*, 109, 1988.
9. L.Brunarski, L.Runkiewicz "Podstawy i przykłady stosowania metod nieniszczących w badaniach konstrukcji z betonu," *Wyd. ITB* (1983).
10. Carino N.J., *Nondestructive Test Methods*, *Concrete Construction Engineering Handbook*, ed.E.G.Nawy, CRC Press, 19.1-19.67.
11. J.Deputat "Nondestructive evaluation methods of material properties", *Gamma* (in Polish), Warszawa 1997.
12. Wu, T.-T., "A comprehensive review on wave-based NDT techniques for evaluation of concrete structures", *Proceedings of 14th World Conference on Non Destructive Testing*, New Delhi (1996) 217-222.
13. "Draft recommendation for *in situ* concrete strength determination by combined non-destructive methods", *Mater. and Struct.* 26, 43, 1993.
14. K.Komlos, S.Popovics, T.Nürnberggerova, B.Babal, J.S.Popovits "Ultrasonic pulse velocity test of concrete properties as specified in various standards", *Cement and Concrete Composites*, 357, 1996.
15. B.Christaras, F.Auger, E.Mosse "Determination of the moduli of elasticity of rocks. Comparison of the ultrasonic velocity and mechanical resonance frequency methods with direct static methods", *Mater. and Struct.* 27, 222, 1994.
16. T.Chrzan "Ultrasonic evaluation of properties of rocks and building materials", *OPWr.* (in Polish), *Monografie 35*, Wrocław 1994.
17. B.Marusa "Possibility of application of ultrasonic pulse method in polymer concrete investigation." *Proc. of Conf. Polymer concretes in building* (in Polish), 107, Katowice 1980.
18. S.K.Mantrala, C.Vipulanandan "Nondestructive evaluation of polyester polymer concrete", *ACI Materials Journal*" 92, 660, 1995.
19. Czarnecki L., Emmons P.H., Vaysburd A., "Materiały do napraw w ujęciu holistycznym," *Materiały Budowlane*, 5 (2000), 2-7.
20. Czarnecki L., Vaysburd A.M., Mailvaganam N.P., Emmons P.H., McDonald J.E. "Repair and rehabilitation of structures – Some random thoughts, *Indian Concrete Journal*, 74 (2000) 13-20.
21. Sasse R.H., Czarnecki L., "Naprawy i ochrona konstrukcji betonowych w świetle normy," *EN 1504-10. Materiały Budowlane* 7, 1999, 30-33.

22. L.Czarnecki, "Naprawa konstrukcji żelbetowych w świetle wymagań europejskich," Mat. VI Konferencji Naukowo-Technicznej Problemy Rzeczoznawstwa Budowlanego - Warsztaty Pracy- Cedzyna 2000, 21-34.
23. Guide for evaluation of concrete structures prior to rehabilitation, ACI 364.1R-94, 2001
24. PN-88/B-01807 "Antykorozyjne zabezpieczenia w budownictwie. Konstrukcje betonowe i żelbetowe. Zasady diagnostyki konstrukcji".
25. Instrukcji ITB nr 361/99 "Zasady oceny bezpieczeństwa konstrukcji żelbetowych", Wyd. ITB, Warszawa, 1999.
26. Nondestructive test methos for evaluation of concrete in structures, ACI 228.2R-98, 2001.
27. J.Obraz "Ultrasonics in measurement techniques" (in Polish) , WNT, Warszawa, 1983.
28. PN-74/B-06261 Nieniszczące badania konstrukcji z betonu. Metoda ultradźwiękowa badania wytrzymałości betonu na ściskanie.
29. Instrukcja ITB nr 290 Instrukcja stosowania metody ultradźwiękowej do nieniszczącej kontroli jakości betonu w konstrukcji, ITB, Warszawa (1977).
30. British Standards BS1881: Part 203: 1986: "Testing Concrete Recommendations for measurement of velocity of ultrasonic pulses in concrete".
31. Russian Standard GOST 17624-87 "Concrete - Ultrasonic method for strength determination," cit. after [14].
32. J.Kaszyński "An investigation into the depth in a cracks in a reinforced concrete structures using an ultrasonic method", Proceedings of 15th World Conference on Non Destructive Testing, Roma (2000), pap.357.
33. S.F. Selleck, E.N. Landis, M.L.Peterson, S.P.Shah, J.D.Achenbach "Ultrasonic investigation of concrete with distributed damage," *ACI Materials J.* (1998) 27-36.
34. V.Garnier, G.Cornelup, E.Toppani, M.Leyginie "Non-destructive evaluation of concrete damage by ultrasounds", Proceedings of 15th World Conference on Non Destructive Testing, Roma (2000), pap.402.
35. J.S.Popovics, J.D.Achenbach, W-J. Song "Application of new ultrasound and sound generation methods for testing concrete structures", *Mag. of Concrete Research*, 51 (1999), 35-44.
36. T.Gudra, B.Stawiski "Non-destructive strength characterization of concrete surface waves", *NDT&E International*, 33 (2000), 1-6.
37. Ma Z., Baishya M.C., Cook R.L., "Polymer-Injection/Ultrasonic Pulse-Echo System for Bridge Deck Repair," *Concrete International*, March (1996) 39-41.
38. Weizheng L., Yiyong Y., "Ultrasonic detection of cement concrete pavement thickness", *Proc.14th World Conference on Non Destructive Testing – WCNDT*, New Delhi (1996), 839-842.
39. S.Popovics, N.M.Bilgutay, M.Karaoguz, T.Akgul "High-Frequency ultrasound technique for testing concrete," *ACI Materials Journal*, 97 (2000), 58-64.
40. M.L.Leming, J.M.Nau, J.Fokuda "Nondestructive determination of the dynamic modulus of concrete disks," *ACI Materials Journal*, 95 (1998), 50-57.
41. L.Czarnecki, B.Chmielewska, "The influence of coupling agent on the properties of vinylester mortar." *Proc. of II International RILEM Symposium on Adhesion between Polymers and Concrete ISAP '99*, Dresden (Niemcy), 1999, 57-66.
42. N.Ahn, D.W.Fowler "The effect of metallic monomers on the bond strength of polymer concrete to wet substrates." *Proc. of Inter.Congress ICPIC'98*, Bologna (Italy), 199, 1998.
43. N.J.Delatte, D.W.Fowler, B.F.McCullough, S.F.Grater "Investigating performance of bonded concrete overlays", *J. of Performance of Constructed Facilities*, (5) (1998) 62-70.
44. C.Jaquerod, Ch.Chippis, F.Alou, Y.F.Houst "Nondestructive testing of repair mortars for concrete," *Proc. of the 3rd Int. Colloquium Materials Science and Restoration*, Esslingen (Germany), 872, 1992.

45. K.S.Tan, K.C.Chan, B.S.Wong, L.W.Guan, "Ultrasonic evaluation of cement adhesion in wall tiles", *Cement and Concrete Composites* 18 (1996) 119-124.
46. C.Jaquered, F.Alou, Y.F.Houst "Nondestructive testing of repair mortars for concrete," Proceedings of an International Colloquium 'Material Science and Restoration', Esslingen (1992), 872-888.
47. Czarnecki, L., Głodkowska, W., Wiąckowska, A., "Model of compatibility of polymer composite-cement concrete (PC-CC) system," in Durability of polymer based composite systems for structural application, Proceedings of an International Colloquium, Brussels (1991),484-493.
48. Czarnecki L., Garbacz A., Łukowski P., Clifton J.R, "Polymer Composites for Repairing of Portland Cement Concrete: Compatibility Project. NIST Report (NISTIR 6394)," United States Department of Commerce, National Institute of Standards and Technology, Gaithersburg MD (USA), 1999.
49. O'Connor, D.N., Saiidi, M., "Compatibility of polyester-styrene polymer concrete overlays with Portland cement concrete bridge decks", *ACI Materials J.*, 90 (1993) 59-68.
50. P.Łukowski, "Model of composition-properties relationship" , Ph.D. Thesis, Warsaw 1995.
51. L.Czarnecki, A.Garbacz, M.Łuciuk, "Nondestructive evaluation of mechanical properties of polymer concretes using ultrasonic pulse method", Proc. of the 4th Intern. Colloquium Materials Science and Restoration, Esslingen (Germany), 523, 1996.
52. Czarnecki, A.Garbacz, M.Łuciuk, "Evaluation of selected properties of polymer concrete using ultrasonic method." *Building & Engineering* 10 (in Polish), 514, 1997.
53. A.Garbacz, M.Łuciuk, L.Czarnecki "Usability of ultrasonic method to assess technical properties of polymer concretes" (in Polish), 26th Conference on NDT, Szczyrk (1997), 193-198.
54. L. Czarnecki, P. Łukowski, *Modelling of the polymer concrete properties*, Studies of University of Transport and Communications in Žilina, Civil Engineering, vol. 21, 1998, 21-29.
55. Brandt, A.M., *Cement-based composites: materials, mechanical properties and performance*, E & FN Spon, London, 1995.
56. Underwood, E.E., "Estimating fracture characteristics by quantitative fractography," *J.Metals*, (1986) 106-178.
57. L.Czarnecki, A.Garbacz, J.Kurach "On the characterization of polymer concrete fracture surface", *Cement & Concrete Composites*, 23 (2001) 399-409.
58. B.Chmielewska, Modification of polymer mortars with silane agents, Ph.D.Thesis, Warsaw University of Technology, Warsaw 2000.
59. Baddeley, A.J., Gundersen, H.J.G., Cruz-Orive, L.M., "Estimation of surface area from vertical sections," *J.of Microscopy*, 3 (1986) 259-276.
60. Wojnar, L., *Fraktografia ilościowa. Podstawy i komputerowe wspomaganie badań; Zeszyty naukowe Politechniki Krakowskiej. Seria Mechanika*, 2, Kraków, 1990.
61. L.Brunarski "Diagnostyczne metody badań budowli," XXXVIII Scientific Conference, Krynica (1992), 11-20.
62. M.Sansalone, M., N.J.Carino, "Detecting delamination in concrete slabs with and without overlays using the impact-echo method", *ACI Materials Journal* 86, 1989.
63. Nazarian, S., Baker, M., Crain, K., "Assessing quality of concrete with wave propagation techniques", *ACI Materials J.* (1997) 296-305.

List of publications involved with the activity on the project

1. Czarnecki L., Garbacz A., Łuciuk M.: Ocena wybranych właściwości betonów żywicznych metodą ultradźwiękową (Evaluation of selected technical properties with ultrasonic methods), Building Industry & Engineering (in Polish), 10 (1997), pp.514-516.
2. Garbacz A., Łuciuk M., Czarnecki L.: Przydatność metody ultradźwiękowej do oceny cech technicznych betonów żywicznych (Usability of ultrasonic pulse velocity for assessment of polymer concrete properties), Proc.26th Polish Conference on NDT Techniques, Szczyrk (1997), pp.193-198.
3. Garbacz A., Czarnecki L., Clifton J.R.: "Ultrasonic Methods To Assess Polymer Concrete Properties", Proc. of the IX Inter.Congress "Polymers in Concrete" ICPIC'98, Bologna (Italy), 1998, pp. 761-769.
4. Garbacz A., Czarnecki L., Clifton J.R., "Non-destructive methods to assess adhesion between polymer composite and portland cement concrete," Proc. 2nd Int. RILEM Symposium "Adhesion between polymers and concrete"- ISAP'99, Dresden (1999), pp. 467- 474.
5. Czarnecki L., Garbacz A., Clifton J., "Evaluation of polymer concrete properties with ultrasounds," Concrete & Reinforced Concrete (in Russian), 4 (1999), pp. 29-30.
6. Garbacz A. "Nondestructive assessment of adhesion between polymer composite and concrete substrate," chapter 8.4 in State of the Art. Report of RILEM TC-151 APC, 1999.
7. Garbacz A., Czarnecki L., Garboczi E., "Ultradźwiękowa ocena przyczepności między kompozytem polimerowym a podkładem betonowym, (Ultrasonic evaluation of adhesion between polymer composites and concrete substrate)," Proc. Polish Conf. "Materials in Building Industry" Matbud '2000, Kraków (2000), pp. 99-106.
8. Garbacz A., Czarnecki L., Garboczi E.: "Ultrasonic Assessment of Adhesion between Polymer Composites and Concrete Substrate", in the Proc. of the 10th International Congress Polymers in Concrete - ICPIC 2001, USA.