

A11102 703727

REF

NBS
PUBLICATIONS

NATL INST OF STANDARDS & TECH R.I.C.

7-3076



A11102703727

Jesch, Ramon L./Measurement of shielding
QC100 .U56 NO.87-3076 1987 V19 C.1 NBS-P

MEASUREMENT OF SHIELDING EFFECTIVENESS OF DIFFERENT CABLE AND SHIELDING CONFIGURATIONS BY MODE-STIRRED TECHNIQUES

Ramon L. Jesch

National Bureau of Standards
U.S. Department of Commerce
Boulder, Colorado 80303-3328

October 1987

QC

100

.U56

87-3076

1987

NBSR
QC100
.456
NO 87-3076
1987

NBSIR 87-3076

MEASUREMENT OF SHIELDING EFFECTIVENESS OF DIFFERENT CABLE AND SHIELDING CONFIGURATIONS BY MODE-STIRRED TECHNIQUES

Ramon L. Jesch

Electromagnetic Fields Division
Center for Electronics and Electrical Engineering
National Engineering Laboratory
National Bureau of Standards
Boulder, Colorado 80303-3328

October 1987

Sponsored by
U.S. Army Aviation Systems Command
St. Louis, Missouri 63120



U.S. DEPARTMENT OF COMMERCE, Clarence J. Brown, Acting Secretary

NATIONAL BUREAU OF STANDARDS, Ernest Ambler, Director

CONTENTS

	<u>Page</u>
1. INTRODUCTION.....	1
2. CABLE AND SHIELDING CONFIGURATIONS.....	2
2.1 Cable Configurations.....	2
2.2 Shielding Configurations.....	3
3. MEASUREMENT APPROACH.....	6
3.1 Measurement System.....	6
3.2 Shielding Effectiveness.....	11
4. MEASUREMENTS RESULTS.....	12
4.1 Cable Configurations.....	12
4.2 Shielding Configurations.....	15
5. SUMMARY AND CONCLUSION.....	17
6. ACKNOWLEDGMENTS.....	18
7. REFERENCES.....	18

MEASUREMENT OF SHIELDING EFFECTIVENESS OF DIFFERENT CABLE AND SHIELDING CONFIGURATIONS BY MODE-STIRRED TECHNIQUES

Ramon L. Jesch

Electromagnetic Fields Division
National Bureau of Standards
Boulder, Colorado 80303

The shielding effectiveness of cable configurations having different shielding arrangements and of shielding configurations used to terminate cable shields for helicopter wiring were measured by mode-stirred techniques. The mode-stirred measurements were taken at discrete frequencies between 200 MHz and 6 GHz. In addition, shielding effectiveness data on the shielding configurations were also obtained in a TEM cell down to 1 MHz. A description of the cable and shielding configurations is given along with plots of the measured shielding effectiveness data as a function of frequency.

Key words: cables; connectors; mode-stirred chamber; relative leakage power; shielding effectiveness.

1. INTRODUCTION

In recent years, one major concern with the design and use of coaxial and multicontact connectors and accompanying cable assemblies has been the amount of electromagnetic (EM) energy or radio frequency (rf) leakage entering into the connector/cables that can be tolerated in today's advanced electronic systems. Moreover, these systems have to be designed to withstand the effects of electromagnetic interference (EMI) at operating frequencies from a few megahertz to many gigahertz. To facilitate system design, shielding effectiveness (SE) data are required for cables and connectors that interconnect various components, subassemblies, equipment, and subsystems. The evaluation of SE measurements of cables and connectors has been the subject of a great deal of analysis and research for some time.

To determine the SE of cable configurations having different shielding arrangements, the National Bureau of Standards (NBS), in 1985, undertook a program to conduct a study on standard practices of terminating cable shields for helicopter wiring for the U.S. Army Aviation Systems Command

(AVSCOM). One of the objectives of this program was to determine a suitable technique for measuring the SE of terminated cable shields in order to compare the EMI effects between different cable arrangements. To accomplish this task, an extensive study of SE measurement techniques was conducted in the area of cables and connectors. Prominent among the measurement techniques being surveyed were the triaxial technique [1] which configures the test sample (cable/connector under test) as a segment of transmission line, and the mode-stirred technique [2] which uses a test chamber to expose the test sample to random incident fields. From the study taken [3], the mode-stirred technique was chosen as the most convenient technique to measure the SE of cables and connectors over a wide frequency range above a few hundred megahertz. Toward this end, another mode-stirred chamber was designed and fabricated specifically to accommodate SE measurements of cables and connectors, and cable shield terminations for the AVSCOM task at NBS.

2. CABLE AND SHIELDING CONFIGURATIONS

2.1 Cable Configurations

Figure 1 shows the four different cable configurations that were used to determine and compare the shielding effects of different shielding arrangements. The configurations were fabricated from 1.5 m (4.93 ft) lengths of RG9/U coaxial cable, which has two shields. The cable was modified to produce:

Configuration 1, consisting of the cable center conductor only, with the vinyl jacket and two shields removed from the cable;

Configuration 2, consisting of RG9/U cable retaining one shield only, with the other shield removed;

Configuration 3, consisting of the regular RG9/U cable with two shields;

and

Configuration 4, consisting of the regular RG9/U cable with one more shield added over the cable to give triple shielding.

All four cable configurations were equipped with Type N coaxial connectors.

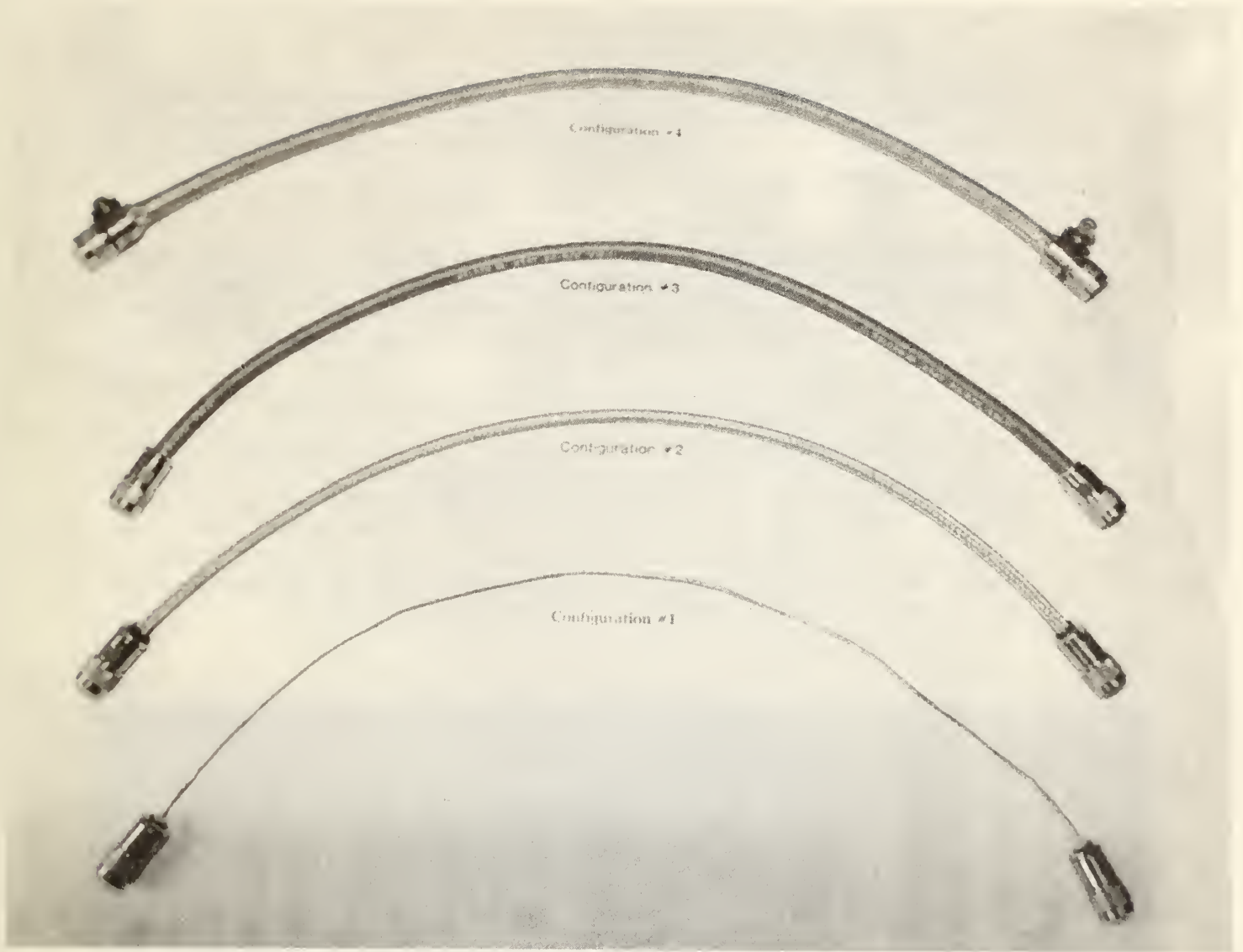

Figure 1. Four different cable configurations.

2.2 Shielding Configurations

General types of shielding configurations that are used for helicopter wiring were discussed with AVSCOM and other knowledgeable personnel. It was decided to narrow down to three basic shielding configurations that should be measured for SE by NBS for the AVSCOM program. These included:

1. **Single Shielded Wire.** The shield is stripped back from one end of the wire approximately 15 cm (6 in) and terminated by means of a solder sleeve and wire that is attached to the connector ground as shown in figure 2.
2. **Twisted Shielded Pair.** The shield is terminated in the same manner as (1) above with one of the conductors attached to the center conductor of the coaxial connector while the other conductor is attached to the connector ground as shown in figure 3.
3. **Multipin Connector/Cable Arrangement.** This arrangement is the most difficult to configure for SE measurements in the mode-stirred chamber. Two harness arrangements were used. One used a single shielded wire arrangement in the harness while the other used a twisted shielded pair arrangement in the harness. Figure 4 shows the single shielded wire arrangement that was measured which is an actual harness assembly from an Army helicopter.

All three shielding configurations were equipped with Type N connectors.

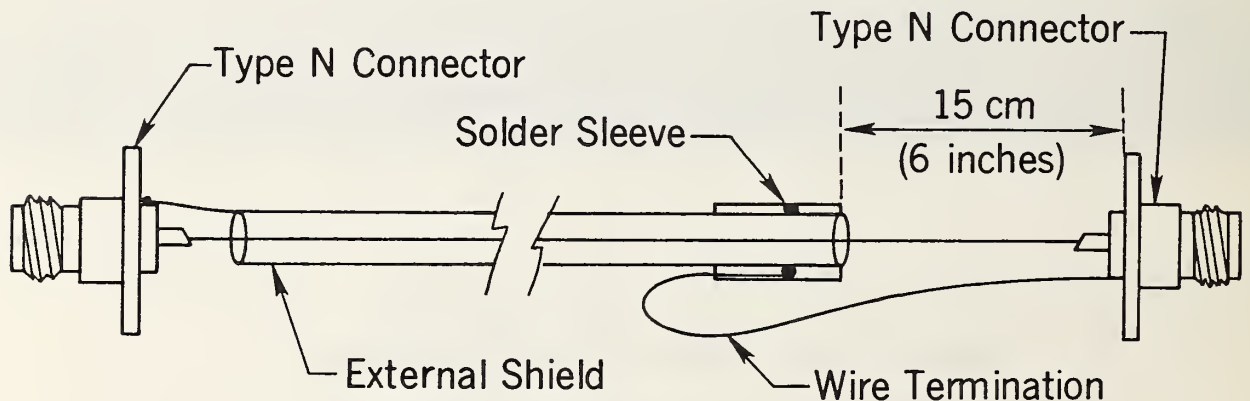

Figure 2. Single shielded wire.

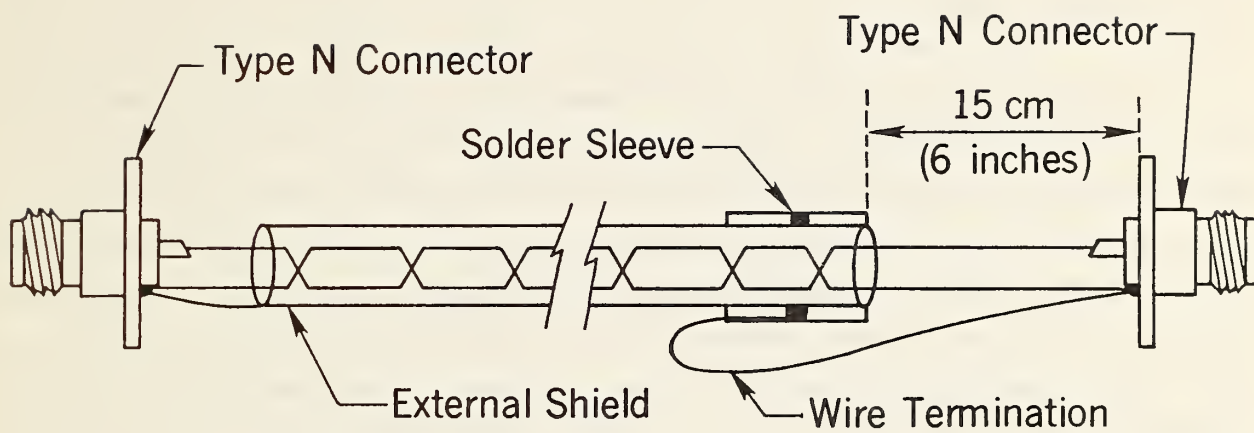

Figure 3. Twisted shielded pair.



Figure 4. Multipin connector/cable arrangement.

3. MEASUREMENT APPROACH

3.1 Measurement System

Two different size reverberation chambers were used for the SE measurements between 200 MHz and 6 GHz. Figure 5 shows a block diagram of the small mode-stirred chamber with shielding configuration and test system that was used for the SE measurements between 1 and 6 GHz. Measurements of the SE of the cable and shielding configurations were made in the small chamber in accordance with Method 3008 of MIL-STD-1344A [4] as required by MIL-C-38999H [5]. The wire antennas were later replaced with ridged-horn antennas and the measurements repeated. The small chamber which has dimensions of 1.165 m x 1.428 m x 1.487 m (3.82 ft x 4.68 ft x 4.88 ft) is essentially a low-loss shielded enclosure that includes an input antenna, a reference antenna and a mode stirrer. The antennas were placed in the chamber in such

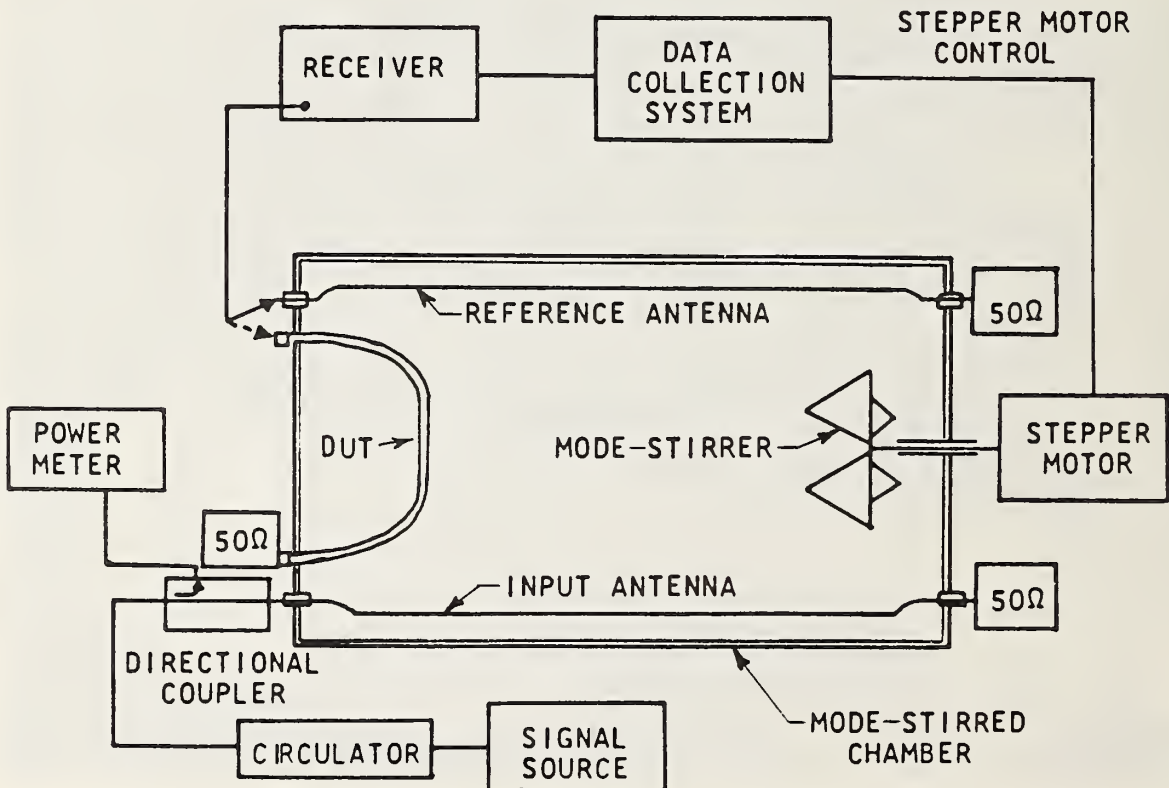

Figure 5. Diagram of small mode-stirred chamber and test system.

a way as to minimize direct coupling from the input (excitation) antenna to the reference (receiving) antenna and from the input antenna to the device under test (DUT). Testing is conducted inside the test chamber whose smallest dimension is at least three wavelengths at the lowest test frequency. This is to assure an ample mode density which is a necessary condition for the validity for the mode-stirred technique [6]. In addition, the minimum distance between the DUT and the chamber walls is at least one wavelength at the lowest test frequency to maintain a uniform electric field throughout the chamber. In order to insure that the shielding configurations (DUT) meet this criterion, each end of the DUT was connected directly to a short section of semi-rigid cable that extended inside the chamber as shown in figure 6. The semi-rigid cables in turn were connected to the bulkhead connectors on the chamber wall.



Figure 6. DUT connected to semi-rigid cables inside the chamber.

Figure 7 is a block diagram of the larger mode-stirred reverberation chamber and measurement system that was used for the SE measurements between 200 MHz and 1 GHz [7]. The dimensions of the chamber are 2.74 m x 3.05 m x 4.57 m (8.99 ft x 10 ft x 15 ft), which allow a lower frequency of approximately 200 MHz. Figure 8 shows the placement of the DUT and the log-periodic antennas inside the large mode-stirred chamber.

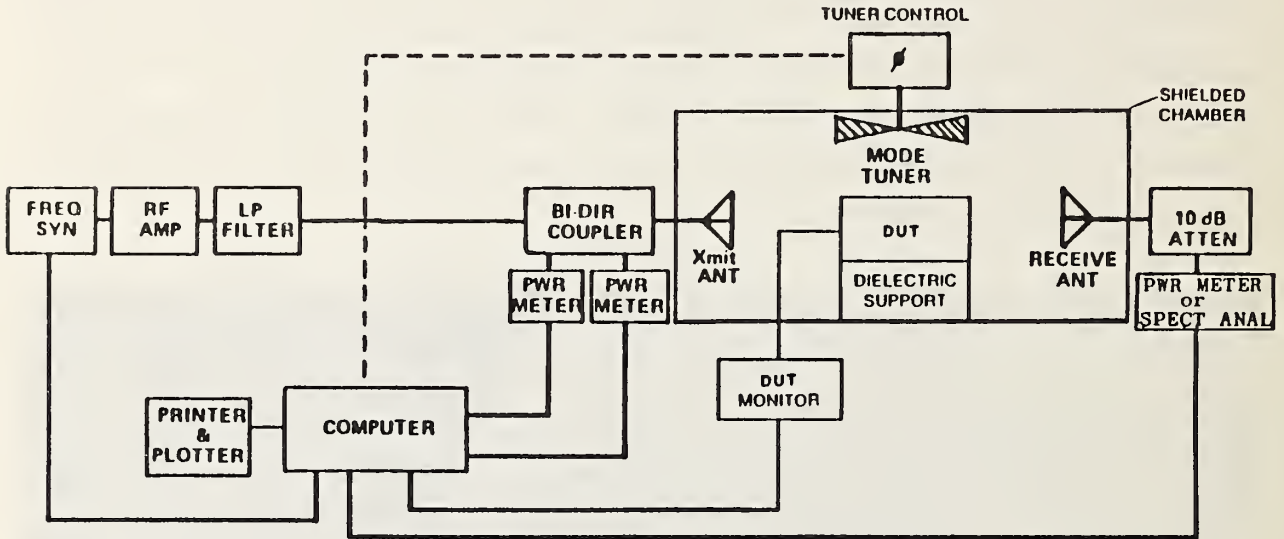

Figure 7. Block diagram of the large mode-stirred chamber and measurement system.

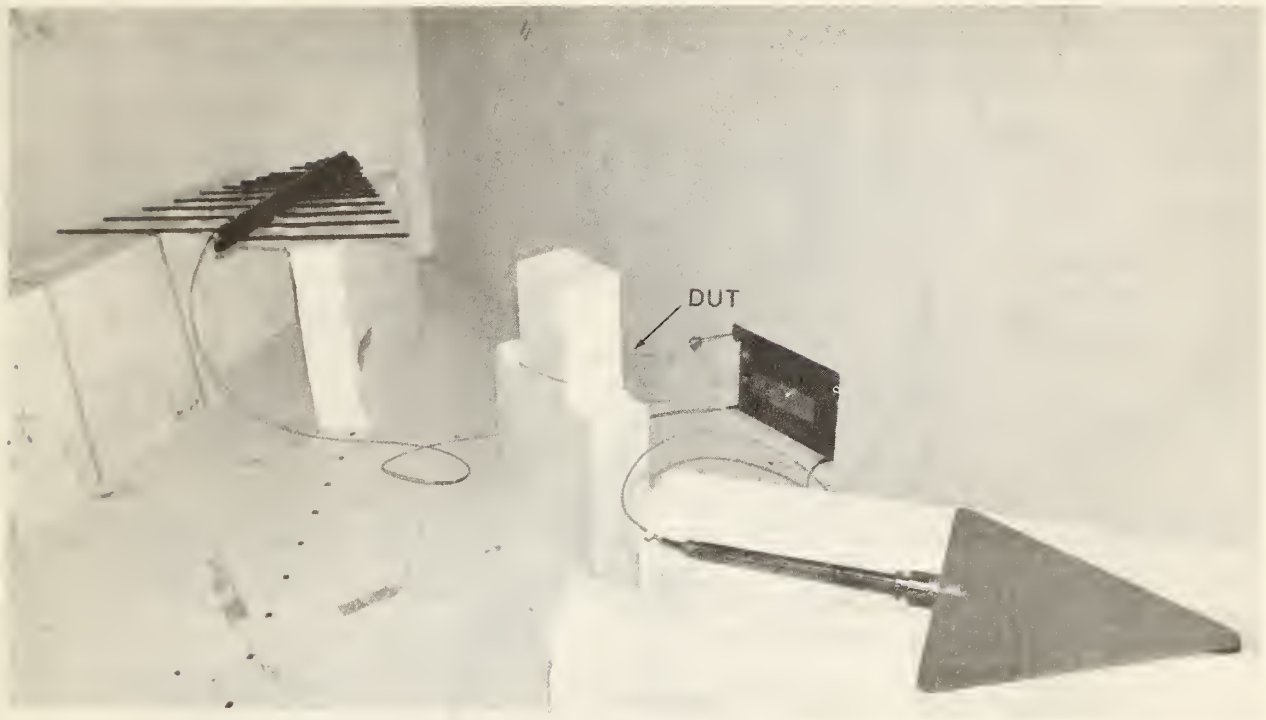

Figure 8. Placement of the DUT and the log periodic antennas inside the large mode-stirred chamber.

Figure 9 is a block diagram of a transverse electromagnetic (TEM) cell that was used for the SE measurements between 1 MHz and 200 MHz. The TEM cell [8] is well known for making susceptibility measurements of electronic equipment for frequencies from dc to 500 MHz but not for SE measurements which require more study and investigation. Some SE measurements of materials; e.g., plastics, conductive laminates, or composites have been conducted with a dual TEM cell [9]. However, for purposes of obtaining several discrete frequencies on the shielding configurations for the AVSCOM program below 200 MHz, it became necessary to use the TEM cell. The design of the TEM cell is based on the concept of an expanded transmission line operated in a TEM mode. The DUT is oriented along the longitudinal axis of the TEM cell to maximize coupling between the DUT and the E and H fields in the region where the DUT is connected to the wall of the TEM cell as shown in figure 10. Moreover, the area of interest for the shielding configurations (DUT) is the region from the connectors back approximately 15 cm (6 in) where the E and H fields are uniform.

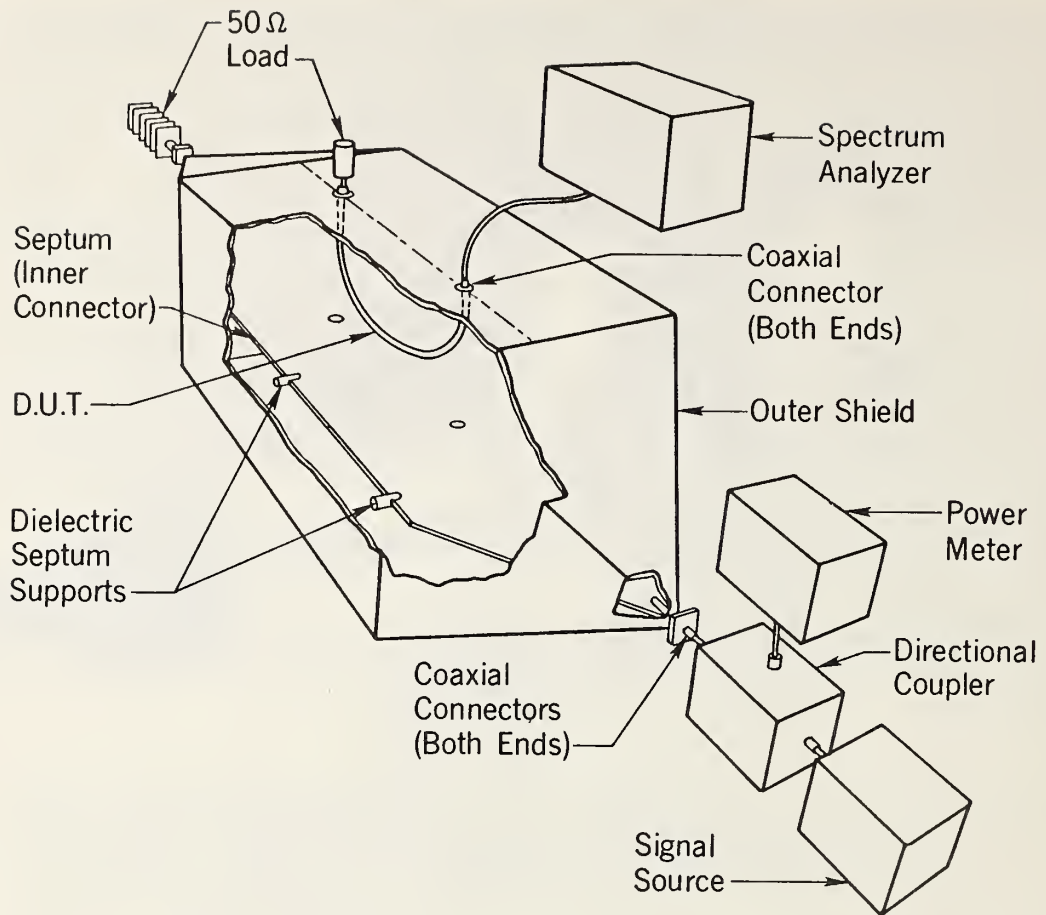

Figure 9. TEM cell and measurement system.

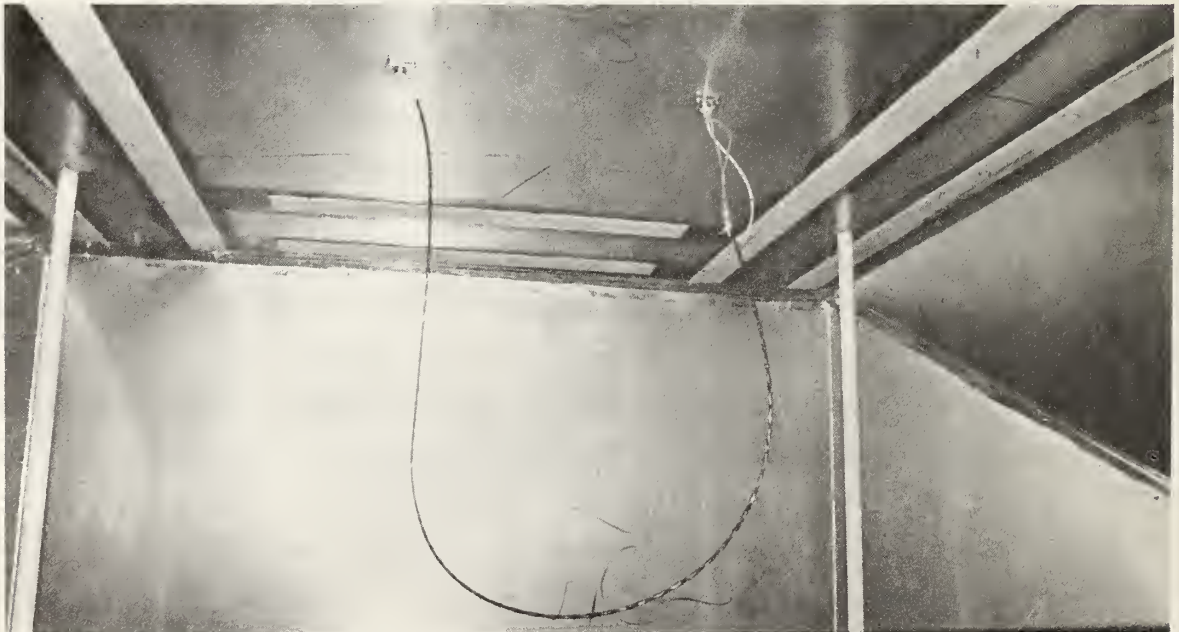

Figure 10. Placement of the DUT inside the TEM cell.

3.2 Shielding Effectiveness

The relative leakage power for determining SE is the of power which leaks into a cable, connector, or other device at a given frequency and is defined by the relationship,

$$SE = 10 \log_{10}(P_1/P_2) \text{ dB}, \quad (1)$$

where

P_1 = total power received by the reference antenna for a given power applied to the input antenna, and

P_2 = total power leaked into the DUT for the same power applied to the input antenna.

To measure the SE of the cable or shielding configurations (DUT) in the mode-stirred chamber, reference conditions are established with the DUT inside the chamber. Energy is injected inside the chamber from a source into the input (excitation) antenna to set up an electric field. The electric field in turn is received and coupled into the reference (receiving) antenna to establish a reference level which is measured as P_1 by the detection system. The objective is to obtain a time average for P_1 due to variations of field strength or power density inside the chamber. Next with the input antenna receiving the same amount of power as before, the detection system is disconnected from the reference antenna and connected directly to the DUT. The output power leaking into the DUT is measured as P_2 . The SE of the DUT is determined using eq (1) by taking the ratio of the averages (P_1 and P_2) over one rotation of the mode stirrer.

The mode-stirred technique uses two operational approaches depending upon the Standing Wave Ratio (SWR) for performing SE measurements inside the chamber. The first approach, mode tuned (used when the input SWR is relatively large in the order of 1.5 or more), steps the mode tuner at selected uniform increments (typically 200 steps or more), permitting measurements of the net input power, power received by the reference antenna, and the

monitored DUT response at each tuner position. This allows corrections to be made for the variations in the chamber's test field resulting from changes in the SWR of the transmitting antenna as a function of the mode tuner position. The second approach, mode stirred (used when the input SWR is below 1.5), was used for the SE measurements which rotates the tuner continuously while sampling the reference antenna received power and DUT response at rates much faster than the tuner revolution rate. Large data samples up to 9,999 can be obtained for a single tuner revolution which takes approximately 3 to 6 minutes per revolution.

For the measurement of SE of the shielding configurations in the TEM cell, energy is fed from a signal source into one port of the TEM cell with the other port terminated into 50 ohms. The electric field is received and coupled into a 1.5 m single conductor wire to establish a reference level which is measured as P_1 by the spectrum analyzer. Next the single conductor wire is replaced by the DUT and with the TEM cell receiving the same amount of power as before, the output power leaking into the DUT is measured as P_2 . The SE of the DUT is determined in the same manner as before by taking the ratio of P_1 to P_2 in eq (1).

4. MEASUREMENT RESULTS

4.1 Cable Configurations

Figures 11-14 show SE data that were obtained on cable configurations 1, 2, 3 and 4 between 600 MHz and 6 GHz using the small mode-stirred chamber. These data were obtained to establish reference conditions with the cable configurations to use as a benchmark for comparing the EMI effectiveness of the AVSCOM shielding configurations. The SE varies considerably between the different cable configurations. For example, the difference in SE between cable configurations 1 and 4 is approximately 100 dB at 1 GHz while the difference between configurations 3 and 4 is about 20 dB.

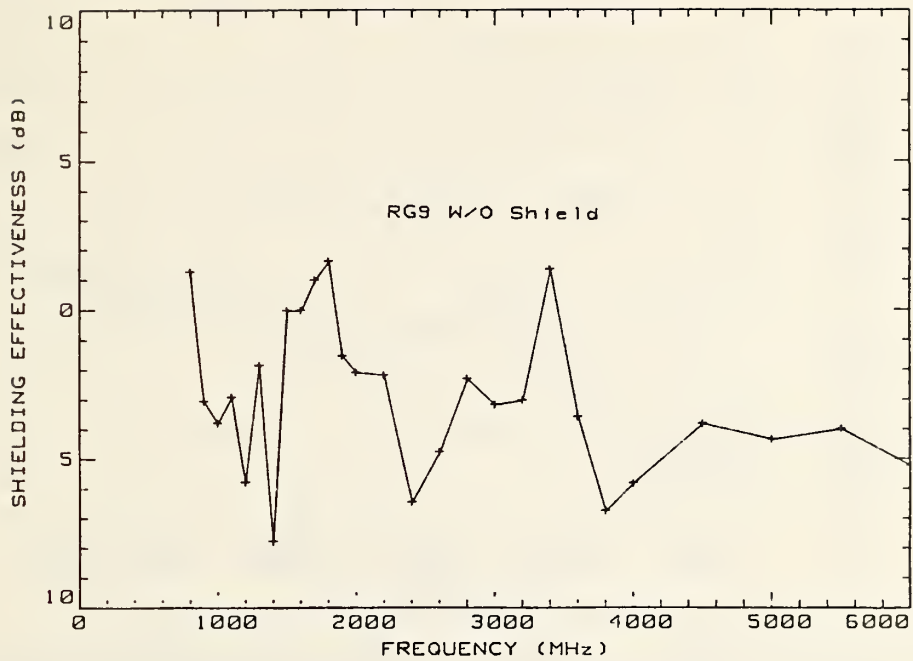

Figure 11. SE of configuration 1 at selected frequencies between 600 and 6000 MHz using the small mode-stirred chamber.

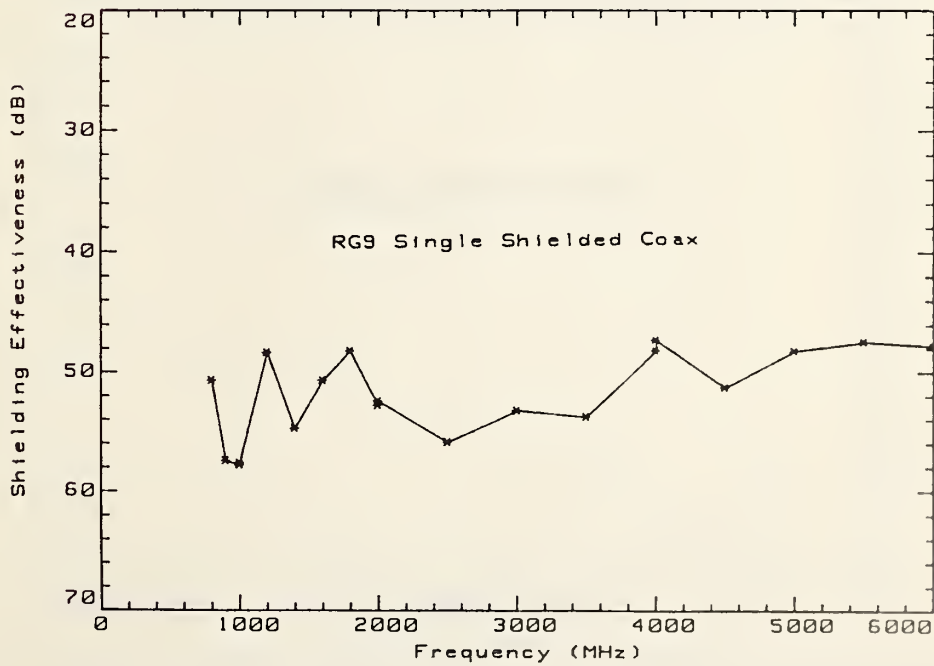

Figure 12. SE of configuration 2 at selected frequencies between 600 and 6000 MHz using the small mode-stirred chamber.

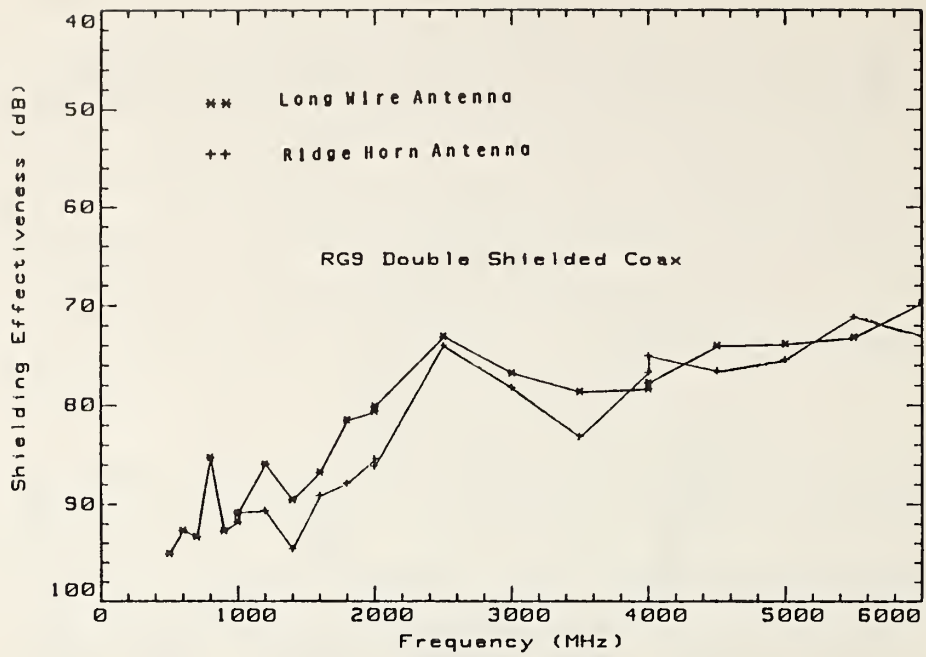

Figure 13. SE of configuration 3 at selected frequencies between 600 and 6000 MHz using the small mode-stirred chamber with both the long wire and ridged-horn antennas.

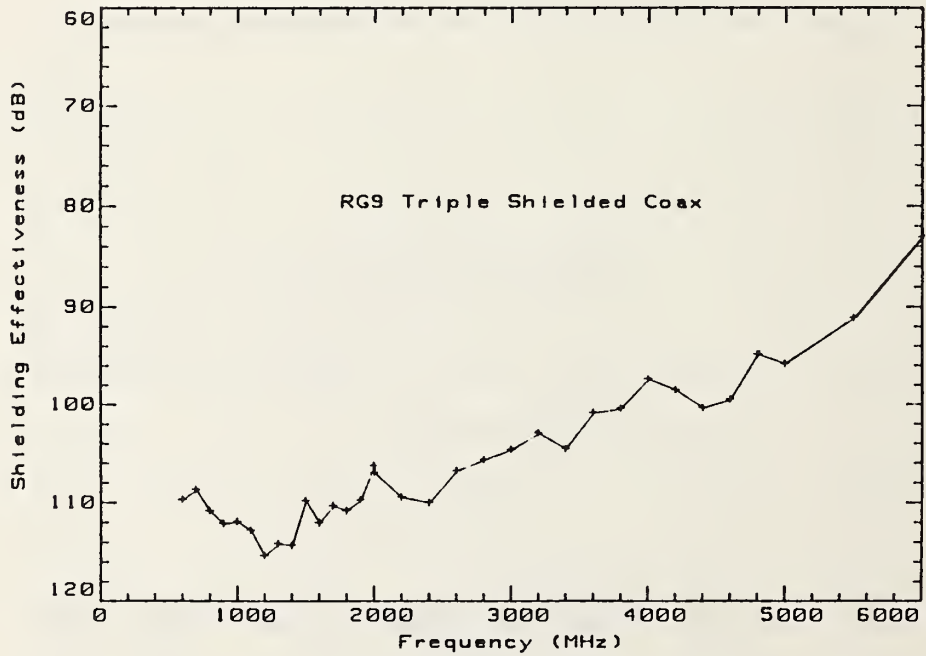

Figure 14. SE of configuration 4 at selected frequencies between 600 and 6000 MHz using the small mode-stirred chamber.

4.2 Shielding Configurations

Figures 15-18 show SE data that were obtained on the shielding configurations 1, 2 and 3 for the AVSCOM program between 1 MHz and 6 GHz using the TEM cell and the mode-stirred chambers. The TEM cell was used for the SE measurements at discrete frequencies of 1, 10, 100 and 200 MHz. The large mode-stirred chamber was used for the SE measurements between 200 MHz and 1 GHz while the small mode-stirred chamber was used for the SE measurements between 1 GHz and 6 GHz. On configuration 3 (multipin connector/cable arrangement), two separate SE measurements were made with the harness assembly which included investigating the SE of the single shielded wire in the harness and the twisted shielded wire in the harness.

Overall, the configurations offer very little shielding from EMI. It appears that the twisted shielded pair offers a bit more shielding (~2 dB at several frequencies) than the single shielded wire.

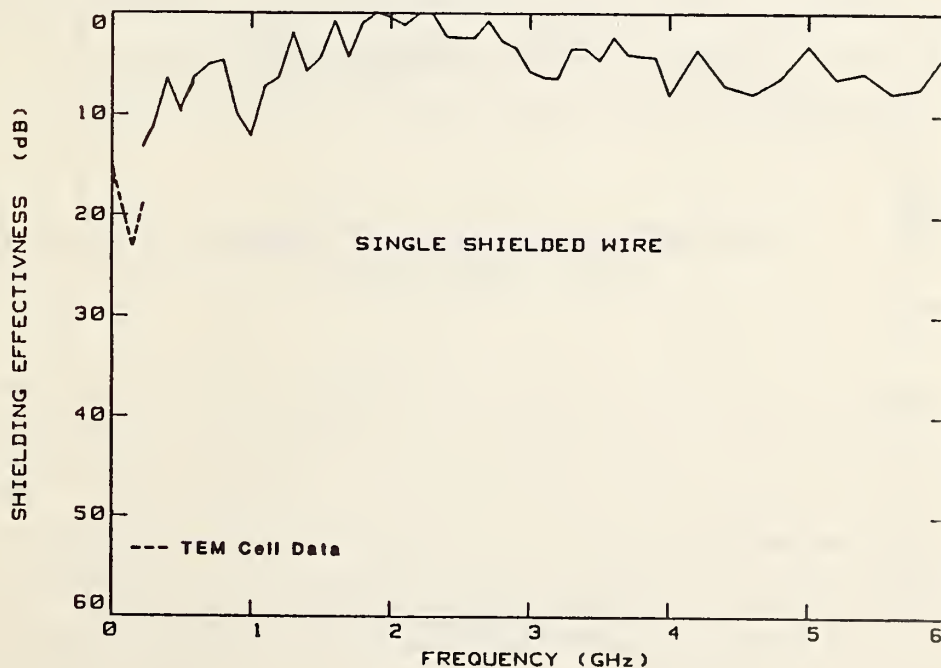

Figure 15. SE of shielding configuration 1 at selected frequencies between 1 MHz and 6 GHz using the TEM cell and the mode-stirred chambers.

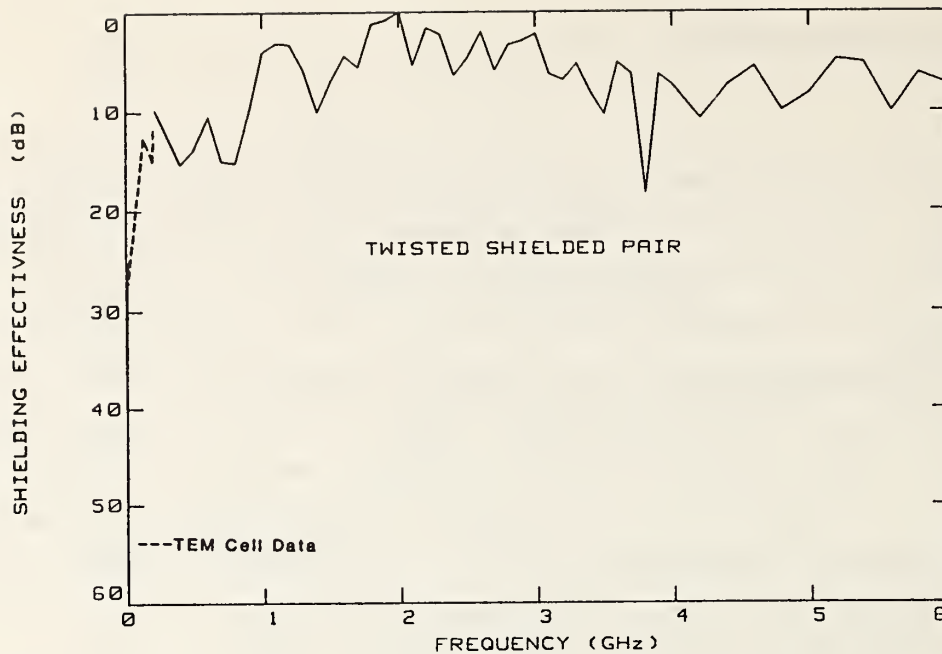

Figure 16. SE of shielding configuration 2 at selected frequencies between 1 MHz and 6 GHz using the TEM cell and the mode-stirred chambers.

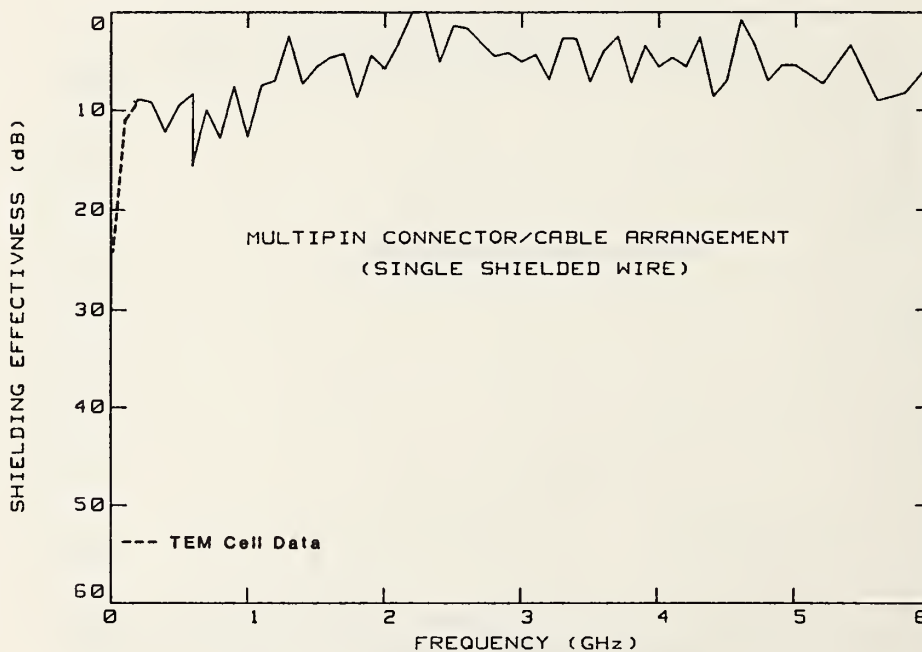

Figure 17. SE of shielding configuration 3 with single shielded wire at selected frequencies between 1 MHz and 6 GHz using the TEM cell and the mode-stirred chambers.

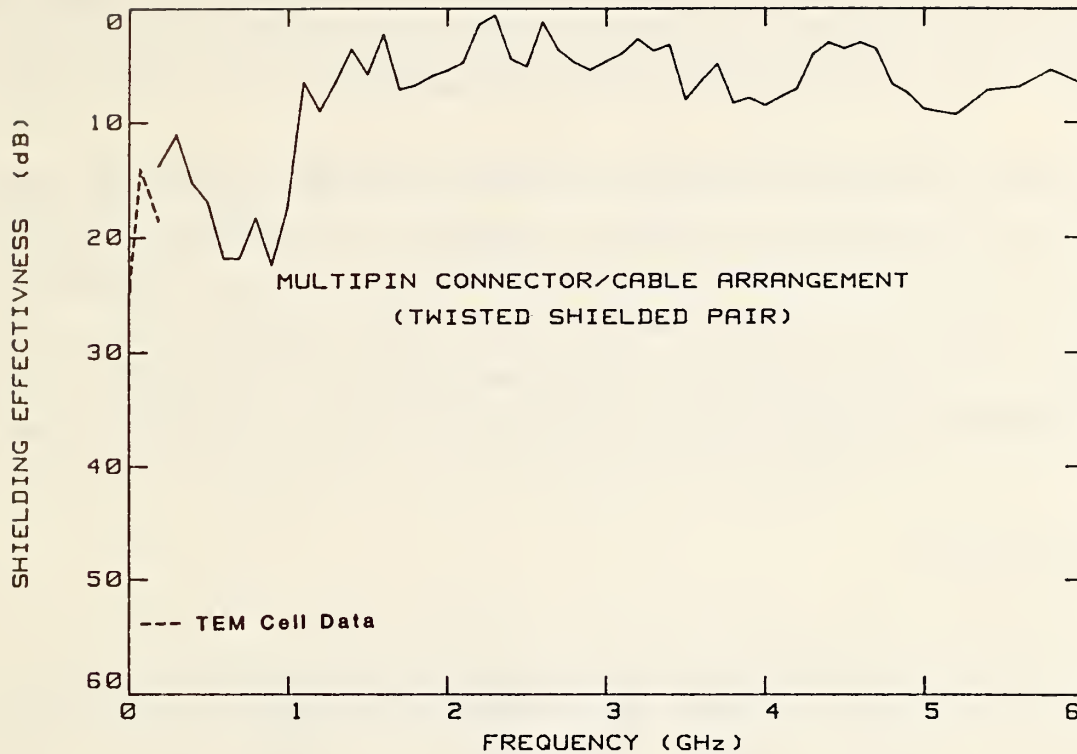

Figure 18. SE of shielding configuration 3 with twisted shielded pair at selected frequencies between 1 MHz and 6 GHz using the TEM cell and the mode-stirred chambers.

5. SUMMARY AND CONCLUSION

Plots of SE were obtained for cable and shielding configurations which allowed the EMI effectiveness of the shielding configurations for the AVSCOM program to be compared with the reference conditions of the cable configurations. The SE measurements of the cable and shielding configurations were measured by mode-stirred techniques. To obtain SE data of the shielding configurations down to 1 MHz, it was necessary to use a TEM cell. It was encouraging that the SE data points measured at 200 MHz using both the TEM cell and the large mode-stirred chamber varied between the shielding configurations by approximately 1 to 8 dB.

The estimated measurement uncertainties for SE of all cable and shielding configurations in the mode-stirred chamber is $\leq \pm 4$ dB [7]. This value is also a good estimate for the shielding configurations for the AVSCOM program that were measured for SE in the TEM cell.

Shields terminated by means of a solder sleeve and wire, daisy chains, and other noncontinuous shielding arrangements do not provide adequate shielding from the surrounding EMI and they allow electronic systems to be exposed to high-level fields. Even at 1 MHz, these shielding configurations offer little protection from EMI. Other measurements of SE on other shielding arrangements and devices need to be determined and the results compared.

6. ACKNOWLEDGMENTS

The author wishes to thank M. Crawford for helpful discussions on measurement techniques and data analysis; and J. Workman for his role in preparing the cable and shielding configurations and making the measurements.

7. REFERENCES

- [1] Zorzy, J.; Muehlberger, R.F. RF leakage characteristics of popular coaxial cables and connectors, 500 Mc to 7.5 Gc. Microwave J., Vol. 4; 1961 November. 80-86.
- [2] Bean, J.L.; Hall, R.A. Electromagnetic susceptibility measurements using a mode-stirred chamber. Proc. IEEE International EMC Symposium; 1978 June 20-22; Atlanta, GA. 143-150.

- [3] Jesch, R.L. A survey of triaxial and mode-stirred techniques for measuring the shielding effectiveness of connectors and cables. Nat. Bur. Stand. (U.S.) NBSIR 86-3060; 1986 October.

- [4] MIL-STD-1344A Appendix A. Design of Mode-Stirred Test Chamber. Method 3008. Shielding Effectiveness of Multicontact Connectors. 1980 September.

- [5] MIL-C-38999H. Military Specification, Connectors, Electrical, Circular, Miniature, High Density, Quick Disconnect, Environment Resistant, Removable Crimp Contacts, and Hermetic Contacts. 1981 February.

- [6] Ma, M.T.; Kanda, M.; Crawford, M.L.; Larsen, E.B. A review of electromagnetic compatibility/interference measurement methodologies. Proc. of the IEEE; 73(3): 388-411; 1985 March.

- [7] Crawford, M.L.; Koepke, G.H. Design, Evaluation, and Use of a Reverberation Chamber for Performing Electromagnetic Susceptibility/Vulnerability Measurements. Nat. Bur. Stand. (U.S.) NBS Tech. Note 1092; 1986 April.

- [8] Crawford, M.L. Generation of Standard EM fields using TEM transmission cells. IEEE Trans. on EMC; EMC-16 (4): 189-195; 1974 November.

- [9] Wilson, P.F.; Ma, M.T. Shielding-effectiveness measurements with a dual TEM cell. IEEE Trans. on EMC; EMC-27 (3): 137-142; 1985 August.

U.S. DEPT. OF COMM. BIBLIOGRAPHIC DATA SHEET <i>(See instructions)</i>	1. PUBLICATION OR REPORT NO. NBSIR 87-3076	2. Performing Organ. Report No.	3. Publication Date October 1987
4. TITLE AND SUBTITLE Measurement of Shielding Effectiveness of Different Cable and Shielding Configurations by Mode-Stirred Techniques			
5. AUTHOR(S) Ramon L. Jesch			
6. PERFORMING ORGANIZATION <i>(If joint or other than NBS, see instructions)</i> NATIONAL BUREAU OF STANDARDS DEPARTMENT OF COMMERCE WASHINGTON, D.C. 20234		7. Contract/Grant No.	8. Type of Report & Period Covered
9. SPONSORING ORGANIZATION NAME AND COMPLETE ADDRESS <i>(Street, City, State, ZIP)</i> U.S. Army Aviation Systems Command St. Louis, Missouri 63120			
10. SUPPLEMENTARY NOTES <input type="checkbox"/> Document describes a computer program; SF-185, FIPS Software Summary, is attached.			
11. ABSTRACT <i>(A 200-word or less factual summary of most significant information. If document includes a significant bibliography or literature survey, mention it here)</i> <p>The shielding effectiveness of cable configurations having different shielding arrangements and of shielding configurations used to terminate cable shields for helicopter wiring were measured by mode-stirred techniques. The mode-stirred measurements were taken at discrete frequencies between 200 MHz and 6 GHz. In addition, shielding effectiveness data on the shielding configurations were also obtained in a TEM cell down to 1 MHz. A description of the cable and shielding configurations is given along with plots of the measured shielding effectiveness data as a function of frequency.</p>			
12. KEY WORDS <i>(Six to twelve entries; alphabetical order; capitalize only proper names; and separate key words by semicolons)</i> cables; connectors; mode-stirred chamber; relative leakage power; shielding effectiveness			
13. AVAILABILITY <input checked="" type="checkbox"/> Unlimited <input type="checkbox"/> For Official Distribution. Do Not Release to NTIS <input type="checkbox"/> Order From Superintendent of Documents, U.S. Government Printing Office, Washington, D.C. 20402. <input checked="" type="checkbox"/> Order From National Technical Information Service (NTIS), Springfield, VA. 22161		14. NO. OF PRINTED PAGES 24 15. Price	

