

NISTIR 8035

Product Data Sheet Ontology

Binyam Abeye
Edward Barkmeyer
Peter Denno

This publication is available free of charge from:
<https://doi.org/10.6028/NIST.IR.8035>

NIST
National Institute of
Standards and Technology
U.S. Department of Commerce

NISTIR 8035

Product Data Sheet Ontology

Binyam Abeye
Edward Barkmeyer
Peter Denno
National Institute of Standards and Technology

This publication is available free of charge from:
<https://doi.org/10.6028/NIST.IR.8035>

December 2014



U.S. Department of Commerce
Penny Pritzker, Secretary

National Institute of Standards and Technology
Willie May, Acting Under Secretary of Commerce for Standards and Technology and Acting Director

NIST

Product Data Sheet Ontology

Authors: Binyam Abeye, Edward Barkmeyer, Peter Denno, NIST

December 5, 2014

Abstract

Data exchange transactions for the engineering, procurement, and operation of process equipment depend heavily on product data sheets. Product data sheets are traditional paper forms that serve as the main method of communicating detailed equipment specifications. There are many standards for the layout and use of product data sheets, but there are still problems with the data exchanges that use them. First, most transactions are still done with the exchange of document images, e.g., scanned product data sheets, which have to be interpreted by humans and transcribed for use in a software tool. Second, the commonly used machine-interpretable forms of product data sheets are created using spreadsheet tools, but there is often disagreement on terminology and on the intended meaning of certain fields. This publication introduces the concept of a Product Data Sheet Ontology covering the types of information included on product data sheets. The ontology is a formal machine-readable terminology that is based on industry standard glossaries of terms and definitions. The paper specifically includes the concepts used in Centrifugal Pump, Pressure Transmitter, and Valve data sheets. The paper depicts the product data sheet concepts and their relationships in diagrams in the Unified Modeling Language (UML) and describes them in detail in text. The UML models are used to generate computer-interpretable ontologies in the Web Ontology Language (OWL) . The text includes the relationships of the ontology elements to industry standards for product data sheet information.

Table of Contents

Table of Contents	i
Table of Figures	viii
1 Introduction.....	1
1.1 Purpose.....	1
1.2 Sources	1
1.3 Form of the specification	2
1.3.1 OWL concepts	2
1.3.2 UML diagrams	3
1.4 Structure of this document.....	5
1.4.1 The ontologies.....	5
1.4.2 Plant items and characterizations.....	6
1.5 Use of the ontology for data specification mapping	6
1.6 Machine-readable form of the ontology	7
2 Ontology: General Product Data Sheet Model	8
2.1 Plant Specifications.....	8
2.1.1 Class: DesignElement	9
2.1.2 Class: ModelType	10
2.1.3 Class: Plant	10
2.1.4 Class: PipingAndInstrumentationDiagram	11
2.1.5 Class: ProcessFlowDiagram	12
2.1.6 Class: Project	12
2.1.7 Class: System	13
2.1.8 Class: SystemModel	14
2.1.9 Class: SystemOperationalDiagram	15
2.1.10 Class: SystemSpecification.....	16
2.2 Plant Items	17
2.2.1 Class: Artefact.....	17
2.2.2 Class: CostProfile	17
2.2.3 Class: Equipment	18
2.2.4 Class: Instrument	18
2.2.5 Enumeration Class: ItemUsage.....	18
2.2.6 Class: LineElement.....	19
2.2.7 Class: Location.....	19
2.2.8 Class: LocationId	19
2.2.9 Class: MaintenanceLevel.....	20
2.2.10 Class: PlantItem	20
2.3 Plant Item Characterization.....	22
2.3.1 Class: ArtefactClass.....	22
2.3.2 Class: CertificationCode	23

2.3.3	Class: EquipmentCharacterization.....	23
2.3.4	Class: InstrumentCharacterization.....	23
2.3.5	Class: ItemCharacterization.....	24
2.3.6	Class: ItemDataStatus.....	26
2.3.7	Class: ItemType.....	26
2.3.8	Class: LineItemCharacterization.....	26
2.3.9	Class: PartCharacterization.....	27
2.3.10	Class: ProductCertification.....	27
2.3.11	Class: SafetyFunctionCode.....	28
2.3.12	Class: SafetyInstrumentedFunction.....	28
2.3.13	Class: SafetyIntegrityLevel.....	29
2.3.14	Class: WettedPart.....	29
2.4	Product Data Sheet Usage.....	30
2.4.1	Class: MeasuredState.....	30
2.4.2	Class: ProductDataSheet.....	31
2.4.3	Class: ProductModel.....	32
2.5	Ports and Connections.....	33
2.5.1	Class: Connection.....	33
2.5.2	Class: ConnectionRating.....	34
2.5.3	Class: ConnectionType.....	34
2.5.4	Class: FluidPort.....	34
2.5.5	Class: Port.....	36
2.5.6	Enumerated Class: FluidRole.....	36
2.5.7	Enumerated Class: PortType.....	36
3	Ontology: Pressure_Transmitter.....	38
3.1	Pressure Transmitters.....	38
3.1.1	Class: CommunicationProtocol.....	39
3.1.2	Class: DetectingInstrument.....	39
3.1.3	Class: ElectricalSystem.....	39
3.1.4	Class: MeasuringDevice.....	40
3.1.5	Class: PressureTransmitter.....	40
3.1.6	Class: ProcessConnectionType.....	42
3.1.7	Class: ProcessInstrument.....	42
3.1.8	Class: SignalSystem.....	43
3.2	Pressure Transmitter Classification.....	44
3.2.1	Class: AbsolutePressureTransmitter.....	44
3.2.2	Class: DifferentialPressureFlowTransmitter.....	44
3.2.3	Class: DifferentialPressureLevelTransmitter.....	45
3.2.4	Class: ElectricalPressureTransmitter.....	45
3.2.5	Class: DifferentialPressureTransmitter.....	45
3.2.6	Class: GagePressureTransmitter.....	45
3.3	Pressure Transmitter Structure.....	46
3.3.1	Class: ANSIFlangeType.....	46

3.3.2	Class: DINFlangeType.....	47
3.3.3	Class: Drain.....	47
3.3.4	Class: Enclosure.....	47
3.3.5	Class: Flange.....	47
3.3.6	Class: FlangeType.....	48
3.3.7	Class: Gasket.....	48
3.3.8	Class: IsolatingDiaphragm.....	49
3.3.9	Class: Manifold.....	49
3.3.10	Class: ManifoldMountingType.....	50
3.3.11	Class: O-Ring.....	50
3.3.12	Class: Vent.....	50
3.3.13	Enumerated Class: InstrumentFlangeMountingType.....	50
4	Ontology: Centrifugal_Pump.....	52
4.1	Pump Taxonomy.....	52
4.1.1	Class: Pump.....	53
4.1.2	Class: AxialFlowPump.....	53
4.1.3	Class: CentrifugalPump.....	53
4.1.4	Class: DirectActingPump.....	54
4.1.5	Class: KineticPump.....	54
4.1.6	Class: MixedFlowPump.....	54
4.1.7	Class: PeripheralTurbinePump.....	55
4.1.8	Class: RadialFlowPump.....	55
4.1.9	Class: ReciprocatingPowerPump.....	55
4.1.10	Class: RegenerativeTurbinePump.....	55
4.1.11	Class: ReversibleCentrifugalPump.....	56
4.1.12	Class: RotaryPump.....	56
4.1.13	Class: RotatingCasingPump.....	56
4.1.14	Class: SeamlessCentrifugalPump.....	56
4.1.15	Class: SideChannelPump.....	57
4.1.16	Class: SpecialEffectPump.....	57
4.1.17	Class: VerticalPump.....	57
4.2	Centrifugal Pump Specification.....	58
4.2.1	Class: Head.....	59
4.2.2	Class: HeadRange.....	60
4.2.3	Class: Pump.....	61
4.2.4	Class: CentrifugalPump.....	61
4.2.5	Class: PumpComplex.....	67
4.2.6	Class: PumpCurve.....	68
4.2.7	Class: PumpUsage.....	68
4.2.8	Enumerated Class: DutyCycle.....	70
4.2.9	Enumerated Class: Orientation.....	70
4.2.10	Enumerated Class: PumpArrangement.....	71
4.2.11	Enumerated Class: RotationDirection.....	71

4.2.12	Enumerated Class: SuctionType	71
4.3	Driver and Coupling Specification	72
4.3.1	Class: CouplingGuardStandard	72
4.3.2	Class: DesignStandard	73
4.3.3	Class: Driver	73
4.3.4	Class: DriverType	74
4.3.5	Class: LateralAnalysisData	75
4.3.6	Class: PumpBaseplate	75
4.3.7	Class: PumpCoupling	76
4.3.8	Class: TorsionalAnalysisData	76
4.3.9	Enumerated Class: BaseplateMounting	77
4.3.10	Enumerated Class: CouplingType	78
4.4	Shaft and Bearings Specification	80
4.4.1	Class: Bearings	80
4.4.2	Class: PumpShaft	81
4.4.3	Class: PumpShaftSeal	82
4.4.4	Class: ShaftSleeve	83
4.4.5	Enumerated Class: BearingStructure	83
4.4.6	Enumerated Class: BearingType	84
4.4.7	Enumerated Class: HousingSealType	84
4.4.8	Enumerated Class: LubricationType	85
4.5	Casing and Impeller Specification	87
4.5.1	Class: CasingCover	87
4.5.2	Class: CasingGasket	87
4.5.3	Class: Impeller	88
4.5.4	Class: PumpCasing	89
4.5.5	Class: WearRing	90
4.5.6	Enumerated Class: CasingMounting	91
4.5.7	Enumerated Class: CasingType	91
4.5.8	Enumerated Class: EnclosureType	92
5	Ontology: Valves	94
5.1	Valve Structure	94
5.1.1	Class: Gasket	95
5.1.2	Class: GasketForm	96
5.1.3	Class: GasketStandard	96
5.1.4	Class: Valve	97
5.1.5	Class: ValveBody	98
5.1.6	Class: ValveBodyType	98
5.1.7	Class: ValveBonnet	99
5.1.8	Class: ValveBonnetGasket	99
5.1.9	Class: ValveBonnetType	99
5.1.10	Class: ValveComponent	100
5.1.11	Class: ValveDesignStandard	100

5.2	Valve Trim	101
5.2.1	Class: Ball	101
5.2.2	Class: Disc	102
5.2.3	Class: HardSeat	102
5.2.4	Class: Plug	102
5.2.5	Class: Rotor	102
5.2.6	Class: SeatTightness	103
5.2.7	Class: SoftSeat	103
5.2.8	Class: TrimCharacteristic	103
5.2.9	Class: ValveClosureMember	104
5.2.10	Class: ValveSeat	104
5.2.11	Class: ValveStem	104
5.2.12	Class: ValveStemSeal	105
5.2.13	Class: ValveTrim	105
5.3	Valve Actuators	107
5.3.1	Class: HydraulicActuator	107
5.3.2	Class: HydraulicValve	108
5.3.3	Class: ManualActuator	108
5.3.4	Class: ManualValve	108
5.3.5	Class: Handwheel	108
5.3.6	Class: Handle	109
5.3.7	Class: MotorActuator	109
5.3.8	Class: MotorValve	109
5.3.9	Class: PneumaticValve	109
5.3.10	Class: PneumaticActuator	110
5.3.11	Class: SolenoidActuator	110
5.3.12	Class: SolenoidValve	110
5.3.13	Class: Spring	110
5.3.14	Class: ValveActuator	111
5.4	Taxonomy by Function	111
5.4.1	Class: CheckValve	111
5.4.2	Class: ControlValve	112
5.4.3	Class: CutoffValve	112
5.4.4	Class: DemandValve	112
5.4.5	Class: ExpansionValve	112
5.4.6	Class: MixingValve	113
5.4.7	Class: PistonValve	113
5.4.8	Class: PressureReducingValve	113
5.4.9	Class: ReliefValve	113
5.4.10	Class: RoutingValve	114
5.5	Taxonomy by Mechanism	114
5.5.1	Class: BallValve	114
5.5.2	Class: ButterflyValve	115
5.5.3	Class: ChokeValve	115

5.5.4	Class: DiaphragmValve	115
5.5.5	Class: DiscValve	116
5.5.6	Class: GateValve	116
5.5.7	Class: GlobeValve	116
5.5.8	Class: KnifeValve	117
5.5.9	Class: NeedleValve	117
5.5.10	Class: PinchValve	117
5.5.11	Class: PlugValve	117
5.5.12	Class: PoppetValve	118
5.5.13	Class: SpoolValve	118
5.5.14	Class: TrumpetValve	118
6	Ontology: Codes	119
6.1	Class: Code	119
6.2	Class: CodeRegistry	120
6.3	Class: Organization	121
6.4	Class: OrganizationId	122
6.5	Datatype: RegistryID	122
6.6	Class: Standard	122
6.7	Class: StandardId	123
7	Ontology: Materials	124
7.1	Class: CompositeMaterial	124
7.2	Class: Fluid	125
7.3	Class: Material	126
7.4	Class: MaterialComponent	127
7.5	Class: MaterialType	127
7.6	Class: ProcessFluidStream	128
7.7	Class: ProcessMaterial	130
7.8	Enumerated Class: FluidType	131
8	Ontology: Quantities	133
8.1	Quantity concepts	133
8.1.1	Class: MeasurementUnit	133
8.1.2	Class: Quantity	134
8.1.3	Class: QuantityKind	135
8.1.4	Class: QuantityRange	135
8.1.5	Class: QuantityValue	136
8.1.6	Class: QuantityValueRange	136
8.2	Quantity kinds	137
8.2.1	Class: AngularVelocity	138
8.2.2	Class: AngularVelocityRange	139
8.2.3	Class: Density	139
8.2.4	Class: Efficiency	139
8.2.5	Class: Energy	139

8.2.6	Class: Flowrate.....	140
8.2.7	Class: FlowrateRange	140
8.2.8	Class: Length	140
8.2.9	Class: LengthRange	141
8.2.10	Class: Mass	141
8.2.11	Class: Power.....	141
8.2.12	Class: Pressure	141
8.2.13	Class: PressureRange	142
8.2.14	Class: SpecificGravity	142
8.2.15	Class: SpecificGravityRange	143
8.2.16	Class: SpecificHeat	143
8.2.17	Class: SpecificHeatRange	143
8.2.18	Class: Temperature	143
8.2.19	Class: TemperatureRange	144
8.2.20	Class: Time	144
8.2.21	Class: Viscosity.....	144
8.2.22	Class: ViscosityRange	145
8.2.23	Class: Voltage	145
8.2.24	Class: Volume.....	145
8.2.25	Class: VolumeRange.....	145
9	Ontology: Shaft Seals	146
9.1	Class: AntiExtrusionRing	147
9.2	Class: Gland.....	147
9.3	Class: LanternRing.....	147
9.4	Class: MechanicalSeal	148
9.5	Class: Packing.....	149
9.6	Class: ShaftSeal	150
9.7	Class: StuffingBox	150
9.8	Enumerated Class: HeatTreatment	151
9.9	Enumerated Class: PackingConstruction.....	152
9.10	Enumerated Class: SealArrangement	154
9.11	Enumerated Class: SealDesign	155
9.12	Enumerated Class: SealFabricationProcess	155
9.13	Enumerated Class: SealOperatingMode	156
9.14	Enumerated Class: SealType	156
10	Profile: ISO-15926.....	159
10.1	Stereotype: RDLclass.....	159
10.2	Stereotype: coInanimatePhysicalObject	159
10.3	Stereotype: coFunctionalObject.....	159
11	Ontology: PDSOntology.....	160
	Bibliography	161

Table of Figures

Figure 1	Example UML diagram	4
Figure 2	Plant specification environment.....	8
Figure 3	Plant Models and Design Elements	9
Figure 4	Plant Items	17
Figure 5	Item characterizations	22
Figure 6	Product Data Sheet Usage.....	30
Figure 7	Ports and Connections.....	33
Figure 8	Pressure Transmitters and Instruments	38
Figure 9	Pressure Transmitter taxonomy	44
Figure 10	Pressure Transmitter structure	46
Figure 11	Pump Classifications.....	52
Figure 12	Overview of the Centrifugal Pump structure	58
Figure 13	Detail of basic Pump elements.....	59
Figure 14	Pump driver and coupling specification	72
Figure 15	Shaft and Bearings data	80
Figure 16	Pump casing and impeller specification	87
Figure 17	Valve structure	94
Figure 18	Valve and Valve Body data	95
Figure 19	Valve Trim Components.....	101
Figure 20	Stem Seals.....	105
Figure 21	Valve Actuators	107
Figure 22	Valves classified by function	111
Figure 23	Valves classified by mechanism	114
Figure 24	Codes and registries	119
Figure 25	Materials	124
Figure 26	Quantities	133
Figure 27	Quantity Kinds.....	138
Figure 28	Quantity Ranges.....	138
Figure 29	Shaft/stem seals.....	146
Figure 30	Overview of the PDS Ontology	160

1 Introduction

1.1 Purpose

Data exchange in any phase of a product life cycle is difficult and time consuming for many reasons, but one of the problems is the differences in how each organization represents requirements. To alleviate this problem, all participants in data exchanges need to share a common view of product requirements. This shared view will allow for faster and easier data exchange that aids in the integration of systems that support the product life cycle. This paper proposes a reference set of concepts for data exchange of product data sheets in general, and for three sample equipment types. The concept set includes the functional and physical properties of Centrifugal Pumps, Pressure Transmitters, and Valves, along with other types of information included in product data sheets for these equipment types.

The concept set is intended to be a common reference for the meanings of fields on equipment product data sheets and for their counterparts in digital information exchange. It is intended that the formal specification of this concept set will be used in specifying software implementations of product data sheet information exchange; but the specification itself is “platform-independent” – it does not specify a programming language or exchange form, because more than one language and exchange form will be used in exchanging the data. The purpose of these specifications is to document the information contained in such product data sheets, not their representation structures.

This specification is similar to industry standard vocabularies, and it draws from such vocabularies, as described below. The main thrust of this document is to demonstrate a common approach to equipment-specific vocabularies, to identify the cross-cutting concepts, and to formalize the reference vocabularies in a standard modeling form that is useful to software developers. NIST will continue to work with standards development organizations and industry to examine mechanisms for using this ontology as a resource for delivering machine readable vocabularies and engineering standards to support model-based engineering.

1.2 Sources

The development of the set of Product Data Sheet conceptual models required the use of several data sources in specifying the classes and their attributes. These sources included industry standards, industry data sheets, and technical literature.

Most of the physical and functional specifications for the descriptions and models of the equipment and product data sheets came from industry and domain standards. These standards aid in creating a common language that most companies in the industry will find familiar. This common understanding lends itself to easier use of the ontology for collaboration in data exchange. Standards used for the terms and definitions in this report include:

- the Hydraulics Institute Engineering Data Exchange specification – HI EDE 50.7 (Hydraulic Institute 2010), denoted as sources by “HI EDE 50.7”
- the cfiXML schemas (Capital Facilities Industry XML (cfiXML.org) 2011), denoted by “cfiXML”
- the Reference Data Libraries associated with ISO 15926 Part 4 (International Organization for Standardization (ISO) 2007) that are maintained by the oil and gas consortium POSC-Caesar (POSC Caesar Association 2013), denoted by “RDL”

Other standards are identified where they are used.

Where the terms and/or definitions in the ontology coincide with the RDL concepts, the model element is associated with an “RDL” class, and the specific Internet Resource Identifiers (URIs) are provided in the text below. Some of the RDL terms and definitions were themselves extracted from other industry standards, as the RDL entry at the given URI indicates.

Data sheets from industry were used in validating and detailing the general concepts and the specifics of different equipment types. These, data sheets provided a practical basis for the formal terms and contractual documents, using terminology that is currently in use in industry.

Technical literature was used to obtain additional attributes of the equipment types. The technical books and papers also provided definitions for properties of the equipment. Another contribution of the technical books is their detailed descriptions of each equipment type. Data sheets normally describe only the properties attributed to the equipment generally, but not the relationships of the properties to the physical equipment components. For example, the wear rings of a Centrifugal Pump are specifically located on the casing and/or impeller. Such information is not always available on data sheets, but is clarified in the technical literature.

The concept set presented here has been reviewed by a few engineering and standardization experts. Further joint work with industry will improve the semantic precision and coverage, and the forms of presentation for specific audiences.

1.3 Form of the specification

The concept set specified in this document is formally captured in the Web Ontology Language (OWL) (World Wide Web Consortium 2012) and depicted in diagrams conforming to the Unified Modeling Language (UML) specification (Object Management Group 2011). Both of these are international standard languages for software applications. The terms used in these models abide by the syntactic limitations of OWL; but they closely resemble the industry terms, and the concept descriptions are in English.

A model in the OWL language is called an *ontology* – a model that is grounded in formal mathematical logic (set theory) and directly usable for automated reasoning by a family of artificial intelligence tools. A UML model is a formal model whose primary purpose is to guide development of software programs and databases.

The models in this document are OWL ontologies, but they are represented in the text in UML diagrams, rather than in any of the standard OWL textual forms, under the assumption that the graphical depiction is easier for readers to comprehend. As a consequence, these ontologies have *both* formal exchange forms – an OWL form and a UML form, making them useful for software tools of several kinds. The two modeling technologies, and the conventions used, are described below.

1.3.1 OWL concepts

OWL is a standard language for capturing the principal concepts in a domain of interest. The most important ideas in the OWL language are *classes*, *properties*, and *individuals*.

The actual things of interest in the domain are *individuals*. Individuals are classified into *Classes* that represent some commonalities among the things. The classes are documented in English, and some of their formal properties – those used in product data sheets – are described formally.

Simple data elements – numbers, character strings, time – are grouped into *Datatypes*, rather than classes. Unfortunately, some of the elements one would think of as “data” – data elements with multiple pieces, like quantity values – are required to be Classes in OWL.

In general, the ontologies do not talk about the individual things; they only refer to classes and datatypes. The actual individual things and data elements will appear in specific uses of the ontology in industry data exchanges. An *Enumerated Class*, however, is a Class for which we can name and describe each of the members, called *NamedIndividuals*. When we define an enumerated class, it has no other members. (The ontology includes a more general idea we call “Code” – a Class for which some authority maintains the list of all the valid members at any given time. Codes are described in section 6.)

Note: In this ontology, many of the *NamedIndividuals* in Enumeration Classes might be considered classes in their own right. For example, a Pump whose ‘usage’ is ‘standby’ might be considered a ‘StandbyPump’. We chose to model these ancillary aspects as *NamedIndividuals* in enumeration classes, rather than as classes, because only their standard names appear as data in product data sheets.

In OWL, the possible relationships between things are called *properties*. *ObjectProperties* are relationships to other things; *dataProperties* are relationships to data elements. A property of either kind is said to have a *domain* – the kinds of things that have the property, usually a Class, and a *range* – the kind of things that the property relates the domain members to, a Class or a Datatype.

A very important OWL concept is the *subClassOf* relationship between Classes. It relates a narrower classification of things to a more general classification of things. “CentrifugalPump (is a) subClassOf Pump” means that everything that is said about members of the more general Pump class is also true of members of the CentrifugalPump class: Every CentrifugalPump is a Pump and has the required and optional properties of a Pump, but not every Pump is a CentrifugalPump. CentrifugalPumps can have properties that other Pumps don’t have.

Some other elements of the OWL language are discussed below, where we have examples of their representation.

1.3.2 UML diagrams

Sets of concepts that are closely related are shown in UML diagrams. UML is a diagramming language that depicts Classes as boxes with partitions, and objectProperties as labeled lines that connect the Class boxes. (In UML, objectProperties are called *associations*.) Figure 1 is an example UML diagram, taken from the text (Figure 4 in section 2.2).

The upper partition of a Class box shows the name of the class and sometimes special characteristics of the class itself. The lower partition of a Class box shows the dataProperties associated with members of the Class, if any. (In UML, these are called *attributes*.) Figure 1 shows five classes: System, Plant, PlantItem, ItemUsage and Location. (A UML Class box can have additional partitions for other software concepts, but we don’t use them.)

Figure 1 shows that each System that is a member of the System class has a dataProperty called ‘id,’ whose value is a character string, and a property called ‘name,’ whose value is a character string. Similarly, a Plant has a plantId, a PlantItem can have a serialNumber, and a Location has a name.

Enumeration classes are a special case. In an enumeration class box, the lower partition is the list of the *NamedIndividuals* that are members. (In UML they are called *enumeration literals*. The UML concept is technically a name, not a named thing.) In Figure 1, the enumeration class ItemUsage has exactly the members: online, standby, reserve, onOrder, and no others.

Some classes and properties are shown in more than one diagram, to make it easier to understand a set of concepts. The dots in the System and PlantItem boxes indicate that some of their modeled dataProperties are not shown in this diagram; they are shown in some other diagram.

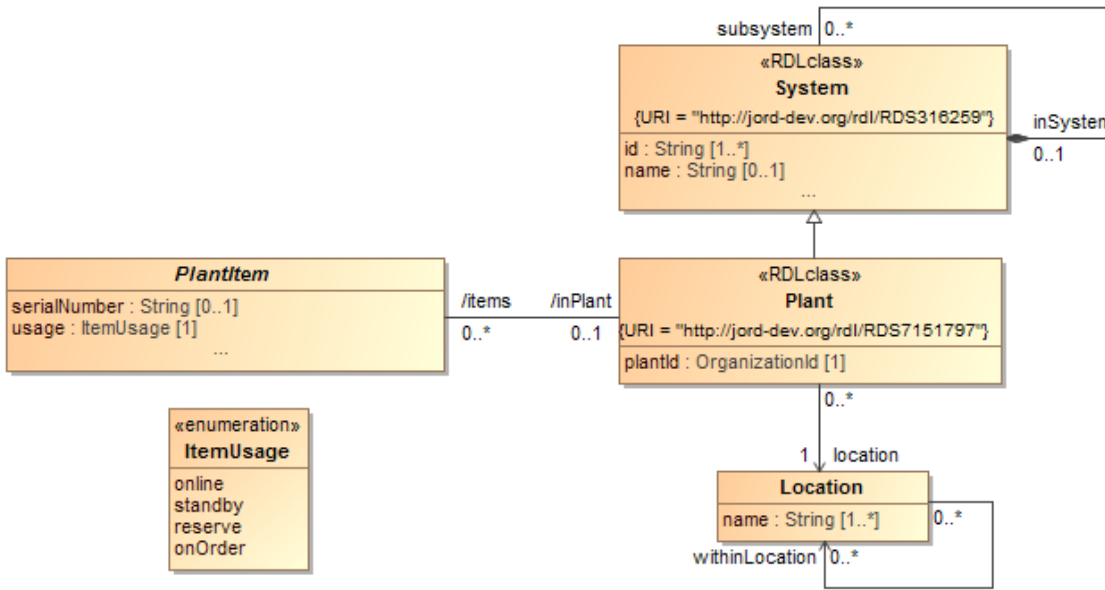

Figure 1 Example UML diagram

A line representing a Property has a name and often an arrowhead near the box representing the kind of thing that is the range of the property. In Figure 1, the property of a Plant that is its location is shown as an arrow that goes from Plant to Location and has the property name ‘location’ on the Location class. The OWL property is Plant.location, the domain is the Plant class, and the range is the Location class.

In Figure 1, the arrow that goes from Location back to Location shows the property Location.withinLocation, whose domain and range are both Locations. It relates one location to another.

Some property lines have names at both ends, and no arrowheads, which means that there is one relationship, but it is seen as a property of each participating class. In Figure 1, we see that a Plant has some set of ‘Plant.items’ that are PlantItems, and a PlantItem can be described as in a Plant, via ‘inPlant’. Similarly, a System can have subsystems, and/or be part of a larger system (‘inSystem’). Two properties that represent the same relationship are said to be *InverseProperties* in OWL.

In OWL, properties are said to have *cardinality constraints*, represented in UML by *multiplicities* – numbers next to the property. The individual cardinality expressions are interpreted as follows:

The cardinality “1” means “exactly one.” The “1” next to the ‘location’ objectProperty means a Plant has exactly one location.

The cardinality “1..*” means “at least one.” The “1..*” (in brackets) next to the id dataProperty means a System has one or more ids.

The cardinality “0..1” means “at most one.” The “0..1” on the ‘inPlant’ property of PlantItem means a PlantItem can be in at most one Plant, but might not be in any Plant.

The multiplicity “0..*” means “any number, zero or more.” The “0..*” on Plant.items means the Plant can have any number of items, possibly none. There is no OWL cardinality constraint, but in UML that is not the meaning of leaving it blank.

The black diamond at the ‘inSystem’ end of the System.subsystem property is a UML convention that means the property is a whole/part relationship. The black diamond appears on the end that is the whole.

In Figure 1, the unnamed arrow with the open head between Plant and System, which UML calls a *generalization*, means that Plant is a subclassOf System (as described above). Every Plant is a System, has at least 1 ‘id’, may have a name, and can have subsystems and other properties of a System.

Finally, the Plant class box shows that the class Plant itself is an “RDLclass” (see Section 10.1) and has a corresponding Uniform Resource Identifier (‘uri’). These are special characteristics of the Plant Class – the model element; they are not characteristics of individual Plants. UML refers to ‘RDLclass’ as a *stereotype* (a specialized model element, in this case a kind of Class), and to the ‘uri’ as a *tag* that associates a value with the model element (a property of the Class itself). In OWL, these are *Annotations* attached to the Class. An annotation has a type name, such as ‘RDLclass’ or ‘uri’, and a value.

1.4 Structure of this document

The remainder of this document specifies the formal concepts in a set of OWL ontologies. In each such ontology, there is a set of Classes that are the principal concepts. These are grouped into closely related concept sets and shown in one or more UML class diagrams.

Each Class description is a separate subsection of the document. It includes any special characteristics of the Class, a statement of the Classes it is a “subClassOf”, if any, and the Properties (dataProperties and objectProperties) that the members of the Class can have. The Properties are themselves documented in detail. Finally, each Class has an “Other Roles” section that shows any relationships to it from other Classes, even though it has no corresponding Property. (Datatypes and Enumerated Classes have only such relationships.)

Some classes and properties are said to have “Aspects”, which are UML ideas that have no OWL equivalent. If a class has “Aspect: abstract,” every member of that class is a member of some modeled subclass of it. A property that has “Aspect: derived” is a combination of some other documented properties. A property that has “Aspect: composite” is a whole/part relationship.

1.4.1 The ontologies

The General Product Data Sheet ontology is a specification for the common concepts in product data sheets and an abbreviated model for the contexts for product data sheets. The Pump, Valve, and Pressure Transmitter ontologies provide the technical details for characterizations of (specifications for) the corresponding plant items. These are supported by standard models for Codes and Quantities, and a simplified model for Materials, including Process Fluids. Each of these ontologies is described in a separate Section of this paper.

Section 2 documents the General Product Data Sheet ontology.

Section 3 documents the Pressure Transmitter ontology.

Section 4 documents the Centrifugal Pump ontology.

Section 5 documents the Valve ontology.

The remaining sections describe common concepts used in the foregoing ontologies. These are grouped into separate ontologies.

Section 6 documents the Codes ontology, a general model of enumerated classes whose members have standard names that are taken from standard “code lists”, rather than explicitly enumerated in the ontology itself. For convenience, that ontology contains the concepts Organization and Standard, which are the sources of code lists.

Section 7 documents the Materials ontology, a high-level abstract model of materials and fluids.

Section 8 documents the Quantities ontology, a basic model of quantity kinds and quantity values.

Section 9 documents the ShaftSeals ontology, a model of shaft and stem characterizations that is used by both the Centrifugal_Pump ontology and the Valves ontology.

Section 10 describes the ISO 15926 Profile, a set of UML stereotypes that are used to show the relationships of the modeled classes to the ISO 15926 Reference Data Libraries (RDL).

Section 11 documents the overall PDSOntology, which just imports all the others into one OWL ontology.

1.4.2 Plant items and characterizations

It is very important to understand that the content of a product data sheet is a characterization of, or specification for, a PlantItem (see 2.2). PlantItems are physical objects, but these ontologies primarily model characterizations of them, called ItemCharacterizations (see 2.3). The characterizations are “classes” in the terms of ISO 15926.

The detailed ontologies in sections 3, 4, and 5 define subclasses of ItemCharacterization, not PlantItem. Nonetheless, those ontologies use the terms for PlantItems and their components (like “Pump” and “Impeller”), but they refer to an ItemCharacterization for the PlantItem at some point in the lifecycle – as it was at a point in time, or as it is required to be. In these ontologies, those terms *do not refer to the physical objects*.

This transference of terminology is common engineering practice, but in engineering, the context of use determines the interpretation. Here, the reader must be aware that this document formally transfers the terms to the ItemCharacterizations, not the PlantItems. In this ontology, “Pump” is not a “class of inanimate physical object,” it is a “class of functional object” (using the terms of ISO 15926).

1.5 Use of the ontology for data specification mapping

The intention of the Product Data Sheet Ontology is to provide a formal basis for standards for electronic data exchanges that convey the information captured in product data sheets. The ontology may be adapted for other purposes as well.

The General Product Data Sheet model aids in representing the nature of a product data sheet and the context of its use, which is crucial for the electronic exchange of data sheets. The supporting models for Code lists, Materials, and Quantities serve as a foundation for describing the values of most of the attributes in a data sheet. Taken together, these models provide the common upper- and lower-level information concepts for product data sheets for various products.

The Pressure Transmitter, Centrifugal Pump, and Valve models serve as an initial set of conceptual models that capture the data elements for specific families of products. These can be extended in future revisions and other specifications.

Finally, the profile that relates the PDS Ontology elements to ISO-15926 Reference Data Library elements helps in fortifying the PDS models with industry standard definitions and in providing a path to one possible set of exchange standards. As industry standard vocabularies for data exchange arise, some similar approach can be used to relate ontologies to those standards.

Mapping the named elements of a data exchange form to the concept set in the reference ontology, makes it possible to relate multiple exchange forms and elements to the same concepts, thus using the ontology as a lingua franca for the intent of various data exchange elements in different standards. The technical problem of specifying such a mapping, however, is not as simple as stereotypes and tags. It requires technologies this paper does not address, but most of those technologies are founded on OWL or UML.

1.6 Machine-readable form of the ontology

The Product Data Sheet Ontology described herein is represented as a set of OWL ontologies in the standard OWL exchange form (OWL/XML) at <https://github.com/USNISTGOV/pdso>.

The general.owl ontology represents the General Product Data Specification concepts described in Section 2.

The pxmitter.owl ontology represents the Pressure Transmitter concepts described in Section 3.

The cpump.owl ontology represents the Centrifugal Pump concepts described in Section 4.

The valves.owl ontology represents the Valves concepts described in Section 5.

The codes.owl ontology represents the Codes and Standards concepts described in Section 6.

The materials.owl ontology represents the Materials concepts described in Section 7.

The quantities.owl ontology represents the Quantities concepts described in Section 8.

The ISO15926.owl ontology provides the OWL Annotation declarations for the ISO 15926 stereotypes and URI values appearing in the text and as OWL annotation axioms in the above ontologies.

The umlanno.owl ontology provides a set of OWL Annotation declarations for UML concepts that are documented in the UML diagrams and in the text but have no clear OWL counterpart. These are also used in OWL annotation axioms in the above ontologies.

The pdsontology.uml file is a UML model in standard exchange form, comprising all of the above ontologies as UML “packages.”

2 Ontology: General Product Data Sheet Model

This section of the model introduces the common concepts surrounding Product Data Sheets, as distinct from their technical content. In particular, this includes the several environments that use product data sheets: plant design and procurement specifications, product catalogs and offerings, and status sheets from as-built and in-use (as-operated) measurements.

Imported Ontologies

This ontology uses the [Codes](#), [Materials](#), and [Quantities](#) ontologies defined below, and is annotated using the [ISO-15926](#) annotations (stereotypes).

2.1 Plant Specifications

This section describes the general properties of Plant specifications, which provide the context for design elements and component requirements. The concepts are depicted in Figure 2 and Figure 3 and described below.

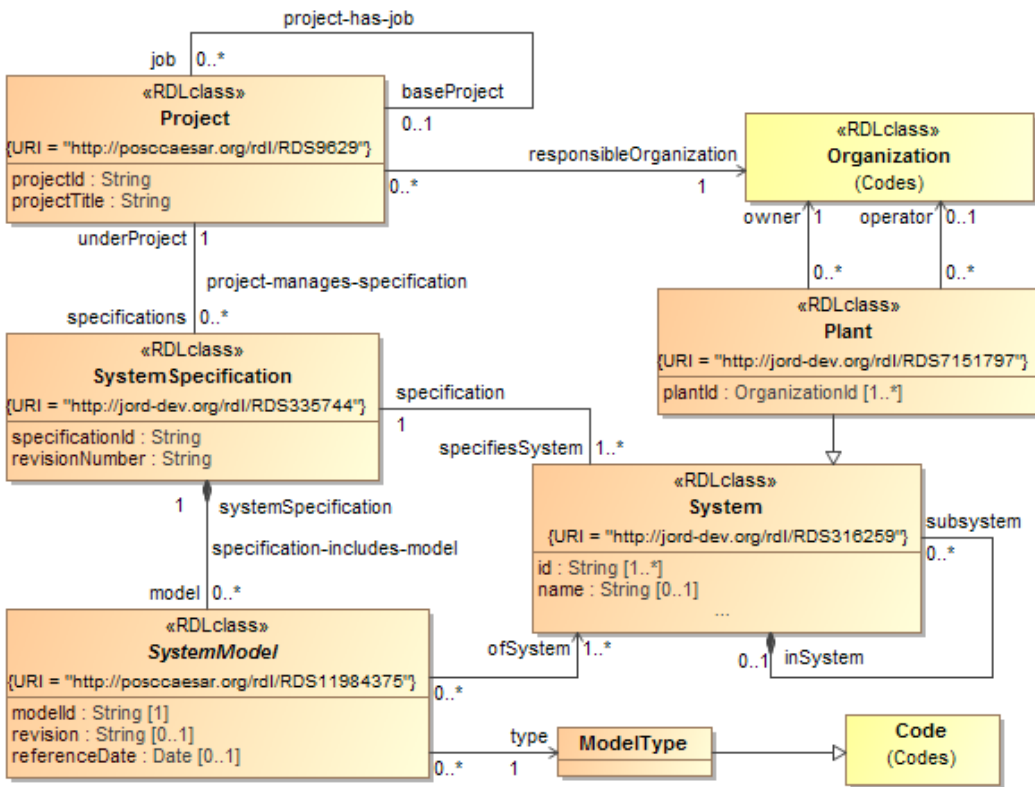

Figure 2 Plant specification environment

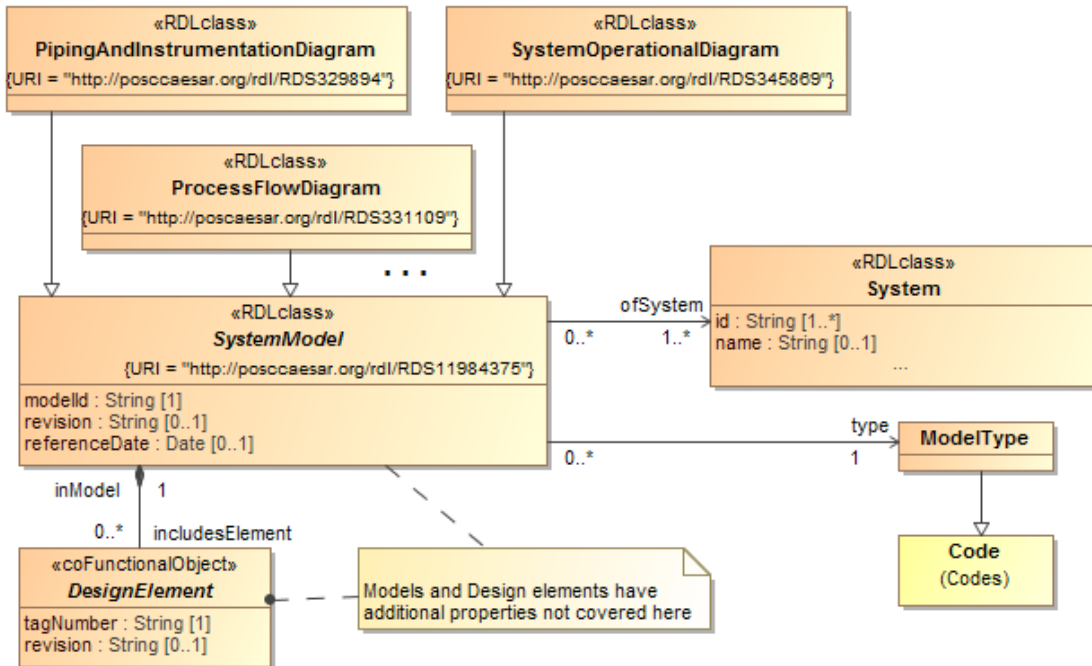

Figure 3 Plant Models and Design Elements

2.1.1 Class: DesignElement

Stereotypes: [ISO-15926:coFunctionalObject](#)

Definition: Design elements are the basic units of an engineering drawing, design or model for a product. The term is used here to refer to the representation of any PlantItem in an engineering model of a Plant or a subsystem of a Plant.

Aspects: abstract

Properties

DataProperty: revision **Type: [OWL:String](#)**

Definition: An identifier for a specific version of the DesignElement, when the design practice makes such a distinction.

In many cases, a SystemModel has a version but the elements in it are all considered to have that version. In other practices, the SystemModel has a version, and each DesignElement has a version that reflects the version of the SystemModel in which that element was last changed. (This enables the reader to determine net change.) A DesignElement 'revision' reflects a change in one or more requirements associated with that element.

Cardinality: at most 1

DataProperty: tagNumber **Type: [OWL:String](#)**

Definition: The identifier for the design element in the formal design specification. For example, the identifier for the element on a piping and instrumentation diagram, or on a circuit diagram.

Cardinality: exactly 1

ObjectProperty: acceptableModel Range: [ProductModel](#)

inverse: [ProductModel](#):satisfiesDesign

Definition: The ProductModels that are known to satisfy the requirements specified for the DesignElement.

Cardinality: unconstrained

ObjectProperty: inModel Range: [SystemModel](#)

inverse: [SystemModel](#):includesElement

Definition: The SystemModel that contains the DesignElement.

Cardinality: exactly 1

ObjectProperty: instance Range: [PlantItem](#)

inverse: [PlantItem](#):realizesDesign

Definition: The physical Artefact that realizes the DesignElement in the system as-built or as-operated.

Cardinality: unconstrained

ObjectProperty: specification Range: [ItemCharacterization](#)

inverse: [ItemCharacterization](#):forElement

Definition: The specifications for the physical Artefact that will fulfill this DesignElement.

Cardinality: exactly 1

Other Roles

none.

2.1.2 Class: ModelType

Definition: A particular category of formal model of a system.

Example: A Process Functional Model for the system.

SubclassOf: [Codes:Code](#)

Properties

none.

Other Roles

From: [SystemModel](#) as type

2.1.3 Class: Plant

Stereotypes: [ISO-15926:RDLclass](#)

Definition: A physical structure (or a planned physical structure) [including the land, buildings, machinery, apparatus and fixtures] that is a system whose purpose is to make products.

Source: RDL (edited), URI = <http://jord-dev.org/rdl/RDS7151797>

SubclassOf: [System](#)

Properties

ObjectProperty: plantId **Type:** [Codes:OrganizationId](#)

Definition: A formal identifier for the Plant, assigned by the Owner.

Cardinality: at least 1

ObjectProperty: items **Range:** [PlantItem](#)

inverse: [PlantItem](#):inPlant

Definition: The PlantItems that are parts of the Plant.

Cardinality: unconstrained

Aspects: derived. A Plant is a System and a System has includedItems (see Figure 4).

ObjectProperty: location **Range:** [Location](#)

Definition: The physical location of the Plant

Note: a Plant conceptually has a single Location, which itself may be part of, or associated with, a larger Location, as a numbered building on a street within a city (see 2.2.7). Because different location schemes are used for different services, however, a Plant may have different Locations that are parts of different hierarchies in different schemes, e.g., GPS versus postal address.

Cardinality: at least 1

ObjectProperty: operator **Range:** [Codes:Organization](#)

Definition: The Organization that has contractual responsibility for operating the plant. This may or may not be the same as the Owner. Also an idle plant need not have any active operating organization.

Cardinality: at most 1

ObjectProperty: owner **Range:** [Codes:Organization](#)

Definition: The Organization that owns the Plant.

Cardinality: exactly 1

Other Roles

none.

2.1.4 Class: PipingAndInstrumentationDiagram

Stereotypes: [ISO-15926:RDLclass](#)

Definition: A diagram showing a schematic representation of a process system, including instrumentation.

Source: RDL, URI = <http://posccaesar.org/rdl/RDS329894>

SubclassOf: [SystemModel](#)

Properties

none.

Other Roles

none.

2.1.5 Class: ProcessFlowDiagram

Stereotypes: [ISO-15926:RDLclass](#)

Definition: A schematic diagram describing the equipment limits and their interconnections, major process control functions, and major stream characteristics, including physical and transport properties, material flows, and energy flows.

Source: RDL, URI = <http://poscaesar.org/rdl/RDS331109>

SubclassOf: [SystemModel](#)

Properties

none.

Other Roles

none.

2.1.6 Class: Project

Stereotypes: [ISO-15926:RDLclass](#)

Definition: Business process consisting of a set of coherent activities intended for a specific purpose and managed as a whole.

Source: RDL, URI = <http://posccaesar.org/rdl/RDS9629>

Properties

DataProperty: projectId **Type: [OWL:String](#)**

Definition: Declared as an instance of a project and has a number as a label.

Source: RDL

Cardinality: exactly 1

DataProperty: projectTitle **Type: [OWL:String](#)**

Definition: The identifier of the project activity.

Source: HI EDE 50.7

Cardinality: exactly 1

ObjectProperty: baseProject **Range: [Project](#)**

inverse: [Project.job](#)

Definition: A larger Project that this Project/Job is part of.

Cardinality: at most 1

ObjectProperty: job **Range: [Project](#)**

inverse: [Project](#).baseProject

Definition: A smaller project or Job that is part of the Project.

Cardinality: unconstrained

ObjectProperty: responsibleOrganization **Range: [Codes:Organization](#)**

Definition: The Organization responsible for executing, or overseeing execution of, the Project.

Cardinality: exactly 1

ObjectProperty: specifications **Range: [SystemSpecification](#)**

inverse: [SystemSpecification](#).underProject

Definition: SystemSpecifications produced by the Project (and thus labeled with the Project id).

Cardinality: unconstrained

Other Roles

none.

2.1.7 Class: System

Stereotypes: [ISO-15926:RDLclass](#)

Definition: A collection of resources (people, machines, materials, software) that is organized for a purpose.

Definition: A functional object that is an assembly of functional objects forming a network to provide a type of service or serving a common purpose.

Source: RDL, URI = <http://jord-dev.org/rdl/RDS316259>

Properties

DataProperty: id **Type: [OWL:String](#)**

Definition: A formal identifier for the (sub) System.

Cardinality: at least 1

DataProperty: name **Type: [OWL:String](#)**

Definition: The common name for the System, if any.

Cardinality: at most 1

ObjectProperty: inSystem **Range: [System](#)**

inverse: [System](#).subsystem

Definition: The next larger system of which the System is a part (if any).

Cardinality: at most 1

ObjectProperty: includedItem **Range: [PlantItem](#)**

inverse: [PlantItem](#):inSystem

Definition: The PlantItem elements that make up the System.

Cardinality: unconstrained

ObjectProperty: specification **Range: [SystemSpecification](#)**

inverse: [SystemSpecification](#):specifiesSystem

Definition: The complete specifications for the System.

Cardinality: exactly 1

ObjectProperty: subsystem **Range: [System](#)**

inverse: [System](#):inSystem

Definition: A part of the System which is a System in its own right, and performs some functions that are part of the System functions.

Cardinality: unconstrained, composite

Other Roles

From: [SystemModel](#) as ofSystem

2.1.8 Class: SystemModel

Stereotypes: [ISO-15926:RDLclass](#)

Definition: A simplified or idealized description or conception of a particular system, situation, or process (often in mathematical terms) that is put forward as a basis for calculations, predictions, or further investigation.

Source: RDL as Model, URI = <http://posccaesar.org/rdl/RDS11984375>

Definition: A specification intended to be used to create an item

Source: RDL as Design

A SystemModel is a formal description of the system at some level of abstraction and from some specific point of view. Such models are typically diagrams with accompanying text. The level and viewpoint for the model determines what is actually captured in the diagram.

Properties

DataProperty: id **Type: [OWL:String](#)**

Definition: The identifier for the SystemModel.

Cardinality: exactly 1

DataProperty: referenceDate **Type: [OWL:DateTime](#)**

Definition: Date of published model.

Cardinality: at most 1

DataProperty: revision **Type: [OWL:String](#)**

Definition: An identification code of a version of the model.

Source: RDL

Cardinality: at most 1

ObjectProperty: author **Range: [Person](#)**

Definition: The person responsible for the SystemModel.

Cardinality: at most 1

ObjectProperty: includesElement **Range: [DesignElement](#)**

inverse: [DesignElement](#):inModel

Definition: The DesignElements that are contained in the SystemModel.

Cardinality: unconstrained, composite

ObjectProperty: ofSystem **Range: [System](#)**

Definition: The system that is modeled by the SystemModel. The model presents an intentionally limited view of the System.

Cardinality: at least 1

ObjectProperty: systemSpecification **Range: [SystemSpecification](#)**

inverse: [SystemSpecification](#):model

Definition: The overall SystemSpecification (and implicitly, the System) for which this SystemModel represents a particular view.

Cardinality: exactly 1

ObjectProperty: type **Range: [ModelType](#)**

Definition: The particular category of formal model of a system that this SystemModel embodies.

Cardinality: exactly 1

Other Roles

none.

2.1.9 Class: SystemOperationalDiagram

Stereotypes: [ISO-15926:RDLclass](#)

Definition: A system diagram representing a particular operational condition.

Source: RDL, URI = <http://posccaesar.org/rdl/RDS345869>

SubclassOf: [SystemModel](#)

Properties

none.

Other Roles

none.

2.1.10 Class: SystemSpecification

Stereotypes: [ISO-15926:RDLclass](#)

Definition: A SystemSpecification is a collection of models of a system, as-is or to-be, that together describe the system at the appropriate formal level of detail needed for some particular interface in the design, construction, and operation of the system. These typically coincide with specific milestones in the lifecycle of the system.

Source: compare to RDL URI = <http://jord-dev.org/rdl/RDS335744>

Properties

DataProperty: revisionNumber **Type:** [OWL:String](#)

Definition: A version identifier for a managed SystemSpecification.

Cardinality: exactly 1

DataProperty: specificationId **Type:** [OWL:String](#)

Definition: The identifier for the system specification that provides the context for the tag number. In many cases, it is a drawing identifier.

Cardinality: exactly 1

ObjectProperty: model **Range:** [SystemModel](#)

inverse: [SystemModel](#):systemSpecification

Definition: The particular SystemModels that capture specific views of the System being specified by the SystemSpecification.

Cardinality: unconstrained, composite

ObjectProperty: specifiesSystem **Range:** [System](#)

inverse: [System](#):specification

Definition: The system(s) that are described by the specification.

Cardinality: at least 1

ObjectProperty: underProject **Range:** [Project](#)

inverse: [Project](#):specifications

Definition: The Project under which, or for which, the SystemSpecification is developed.

Cardinality: exactly 1

Other Roles

none.

2.2 Plant Items

This section defines the base classes and properties for Plant Items – the physical objects that are managed during plant construction and operation. The PlantItem concepts are depicted in Figure 4 and described below.

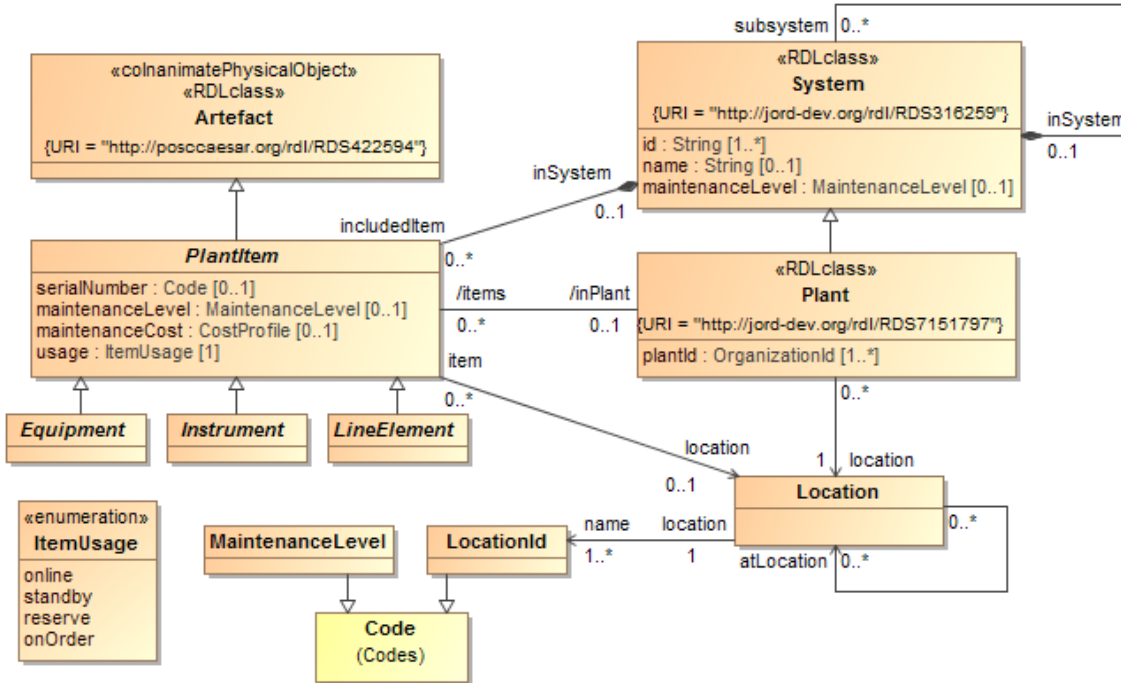

Figure 4 Plant Items

2.2.1 Class: Artefact

Stereotypes: [ISO-15926:RDclass](#), [ISO-15926:coInanimatePhysicalObject](#)

Definition: An inanimate physical object that is made or given shape by man.

Source: RDL, URI = <http://posccaesar.org/rdl/RDS422594>

Properties

none.

Other Roles

none.

2.2.2 Class: CostProfile

Definition: A characterization of the cost of operating or maintaining equipment. This is usually phrased in units of currency/time, where the time can be elapsed time or time in active duty. But it may be more complex if it depends on specific uses of the equipment or on environmental conditions, etc.

Properties

none.

Other Roles

From: [PlantItem](#) as maintenanceCost

2.2.3 Class: Equipment

Definition: An artefact class that contains classes of artefacts or physical resources required for a purpose.

Aspects: abstract

SubclassOf: [PlantItem](#)

Properties

none.

Other Roles

none.

2.2.4 Class: Instrument

Definition: A physical object that detects an aspect of something; records, modifies and/or displays such an aspect or performs a combination of these activities.

Aspects: abstract

SubclassOf: [PlantItem](#)

Properties

none.

Other Roles

none.

2.2.5 Enumeration Class: ItemUsage

Definition: The status of a PlantItem with respect to active duty.

Named Individual Members

Member: online

Definition: The Item plays an active role in an active process system.

Member: standby

Definition: The Item is part of an active process system, but is a standby or backup part of the system that is not normally (or currently) actively used.

Member: reserve

Definition: The item is not part of an active processing system. It is being retained as a readily available replacement.

Note: Lowest-level location identifiers are just locally understood string designations, but many high level location identifiers come from standards and registries.

SubclassOf: [Codes:Code](#)

Properties

none.

Other Roles

From: [Location](#) as name

2.2.9 Class: MaintenanceLevel

Definition: A level of effort assigned to the maintenance of a system or a system component.

A MaintenanceLevel can be as simple as "high, medium, low" or a category in some more complex system based on maintenance management concerns, such as resource levels, skills, or cost categories

SubclassOf: [Codes:Code](#)

Properties

none.

Other Roles

From: [PlantItem](#) as maintenanceLevel

From: [System](#) as maintenanceLevel

2.2.10 Class: PlantItem

Definition: Artefact that is a physical part of a process plant.

Aspects: abstract

SubclassOf: [Artefact](#)

Properties

DataProperty: serialNumber **Type:** [Codes:Code](#)

Definition: A unique code assigned for identification of a single product unit.

Cardinality: at most 1

ObjectProperty: inPlant **Range:** [Plant](#)

inverse: [Plant](#):items

Definition: The Plant that contains the PlantItem, if any.

Cardinality: at most 1

Aspects: derived

ObjectProperty: inSystem **Range: [System](#)**

inverse: [System](#):includedItem

Definition: The System that the PlantItem is part of.

Cardinality: at most 1

ObjectProperty: maintenanceCost **Range: [CostProfile](#)**

Definition: Characterization of the cost of preventive and/or remedial maintenance of the PlantItem. This is usually phrased in units of currency/time, where the time can be elapsed time or time in active duty, but it can be more complex. (See CostProfile.)

Cardinality: at most 1

ObjectProperty: maintenanceLevel **Range: [MaintenanceLevel](#)**

Definition: The level of effort assigned to the maintenance of the PlantItem.

Cardinality: at most 1

ObjectProperty: model **Range: [ProductModel](#)**

Definition: The Product(Model) to which this Artefact (product instance) belongs.

Cardinality: exactly 1

ObjectProperty: ports **Range: [Port](#)**

Definition: The physical ports by which this Plant Item is connected to other physical elements of the plant.

Cardinality: unconstrained

Aspects: abstract, composite

ObjectProperty: realizesDesign **Range: [DesignElement](#)**

inverse: [DesignElement](#):instance

Definition: The DesignElement that this Artefact realizes in the physical system.

Cardinality: at least 1

ObjectProperty: state **Range: [MeasuredState](#)**

inverse: [MeasuredState](#):ofItem

Definition: The measured states of the Plant Item.

Cardinality: unconstrained

ObjectProperty: usage **Range: [ItemUsage](#)**

Definition: The current service usage of the PlantItem, such as online or standby. (See ItemUsage.)

Cardinality: exactly 1

Other Roles

none.

2.3 Plant Item Characterization

During design and build, the actual Plant Items are manipulated only near the end of those phases. Most activities in those phases manipulate descriptions of Plant Items, which we call ItemCharacterizations. An ItemCharacterization is a set of specified properties of a given PlantItem with their values. Figure 5 depicts the overall view of ItemCharacterizations and this section describes them.

Each individual type of PlantItem has its own ItemCharacterization template, and some of those are the content of later sections of this specification.

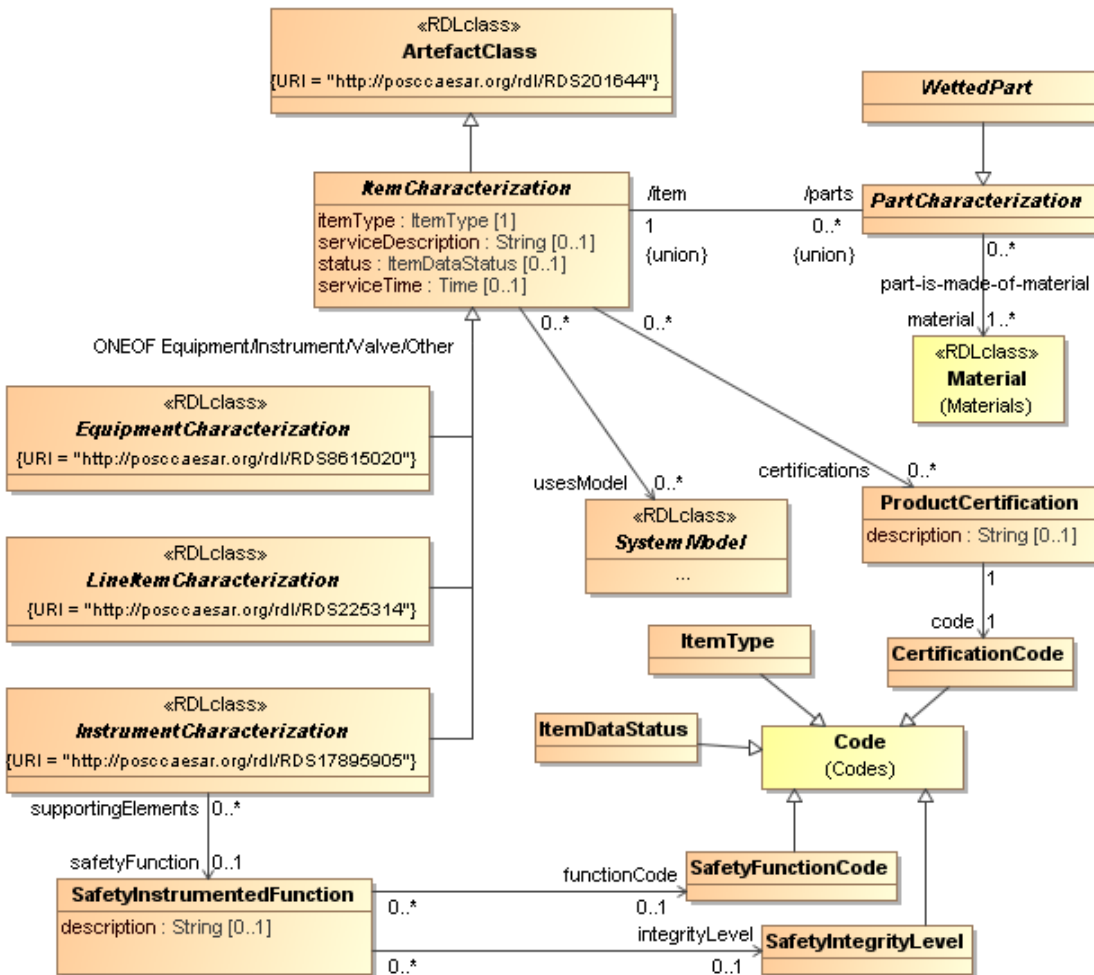

Figure 5 Item characterizations

2.3.1 Class: ArtefactClass

Stereotypes: [ISO-15926:RDLclass](#)

Definition: A class whose members are classes of artefacts.

Source: RDL, URI = <http://posccaesar.org/rdl/RDS201644>

Properties

none.

Other Roles

none.

2.3.2 Class: CertificationCode

Definition: A standard code that designates the specific Certification, its properties, tests, and authorities.

SubclassOf: [Codes:Code](#)

Properties

none.

Other Roles

From: [ProductCertification](#) as code

2.3.3 Class: EquipmentCharacterization

Stereotypes: [ISO-15926:RDLclass](#)

Definition: ItemCharacterization of Equipment items.

Source: Derived from RDL EquipmentClass, URI = <http://posccaesar.org/rdl/RDS8615020>

Aspects: abstract

SubclassOf: [ItemCharacterization](#)

Properties

none.

Other Roles

none.

2.3.4 Class: InstrumentCharacterization

Stereotypes: [ISO-15926:RDLclass](#)

Definition: ItemCharacterization of Instrument items.

Note: The RDL definition (of Instrument Class, URI = <http://posccaesar.org/rdl/RDS17895905>) is a note on its origin

Aspects: abstract

SubclassOf: [ItemCharacterization](#)

Properties

none.

Other Roles

none.

2.3.5 Class: ItemCharacterization

Definition: A description of a system component, or of a product that may be offered as a system component. The description characterizes the component using a set of properties and their values.

ItemCharacterizations are classified in two ways: by what kind of thing is being characterized, and by the role of the characterization.

Characterization roles include:

- specifications for DesignElements, which specify the required characteristics of a system component to-be;
- specifications for ProductModels, which specify the nominal characteristics of a product as-offered;
- MeasuredStates, which specify the measured properties of a physical system component as-is at some point in time.

Characterization kinds mirror the kinds of Artefacts that are system components. Taken from common industry practice, the generic categories include:

- Equipment
- Instrument
- Valve
- Other Line Elements

In addition, the itemType specifies a particular category of component, such as a Centrifugal Pump or a Motor-operated check valve.

Aspects: abstract (every ItemCharacterization is an instance of a subclass that captures the properties of a particular category of product)

SubclassOf: [ArtefactClass](#)

Properties

DataProperty: serviceDescription Type: [OWL:String](#)

Definition: A description intended to describe the purpose of an item.

Source: RDL, URI = <http://posccaesar.org/rdl/RDS338939>

Cardinality: exactly 1

ObjectProperty: certifications Range: [ProductCertification](#)

Definition: The characterized item has, or is required to have, the ProductCertification, i.e., the component must have passed the associated certification process, according to a formal declaration by the appointed authority.

Cardinality: unconstrained

ObjectProperty: connections Range: [Connection](#)

Definition: The conceptual connections between the characterizedItem and the piping system.

Cardinality: unconstrained

Aspects: abstract, composite

ObjectProperty: parts **Range: [PartCharacterization](#)**

inverse: [PartCharacterization](#):item

Definition: The elements of the ItemCharacterization that describe physical parts of the Item being characterized.

Cardinality: unconstrained

Aspects: abstract, derived

ObjectProperty: forElement **Range: [DesignElement](#)**

inverse: [DesignElement](#).specification

Definition: The DesignElements, if any, that include this ItemCharacterization.

Cardinality: unconstrained

ObjectProperty: forProduct **Range: [ProductModel](#)**

inverse: [ProductModel](#).specification

Definition: The ProductModel, if any, for which this ItemCharacterization forms the specifications.

Cardinality: at most 1

ObjectProperty: itemType **Range: [ItemType](#)**

Definition: A specific category of Plant Item, that identifies principal functional or physical features.

Examples: Centrifugal Pump, Motor-operated check valve.

Cardinality: exactly 1

ObjectProperty: safetyFunction **Range: [SafetyInstrumentedFunction](#)**

Definition: safety function which is the purpose of, or forms part of the specifications for, the characterized Instrument.

Cardinality: at most 1

ObjectProperty: status **Type: [ItemDataStatus](#)**

Definition: A Code indicating the source, nature and/or quality of the ItemCharacterization.

Note: ItemCharacterizations are distinguished by what they are associated with, which represent different uses of ProductDataSheets. Each of these has some form of version control: DesignElements and ProductModels have revision numbers, MeasuredStates of actual PlantItems have timestamps. But within the lifecycle, the Design, Build, Operate phases have subordinate phases in which elements of the characterization are refined. The 'status' element supports these lower-level distinctions.

Note: This specification does not support assignment of a status code to individual properties within an ItemCharacterization.

Cardinality: at most 1

Other Roles

From: [ProductDataSheet](#) as content

2.3.6 Class: ItemDataStatus

Definition: A Code indicating the source, nature or quality of an ItemCharacterization.

Examples: Design specified, computed from design spec, estimated from design simulation, product specified, computed from product specification, result of product simulation, actual measurement as installed, actual measurement in operation.

SubclassOf: [Codes:Code](#)

Properties

none.

Other Roles

From: [ItemCharacterization](#) as status

2.3.7 Class: ItemType

Definition: A standard term, or a code from some reference catalog that specifies the kind/category of a PlantItem.

SubclassOf: [Codes:Code](#)

Properties

none.

Other Roles

From: [ItemCharacterization](#) as itemType

2.3.8 Class: LineItemCharacterization

Stereotypes: [ISO-15926:RDLclass](#)

Definition: ItemCharacterization of LineItems

Definition: A process piping equipment class that contains classes of equipment used in or in connection with a piping system.

Source: RDL. URI = <http://posccaesar.org/rdl/RDS225314>

Aspects: abstract

SubclassOf: [ItemCharacterization](#)

Properties

none.

Other Roles

none.

2.3.9 Class: PartCharacterization

Definition: An element of an ItemCharacterization that characterizes a physical part of the items, and corresponds to a physical artefact (part) in the system or product described by the ItemCharacterization.

This class is an abstraction. Each interesting class of part is described separately according to the type of Product being characterized.

Aspects: abstract

Properties

ObjectProperty: item **Range: [ItemCharacterization](#)**

inverse: [ItemCharacterization](#):parts

Definition: The characterization that contains the description of the physical part.

Cardinality: exactly 1

Aspects: abstract, derived

ObjectProperty: material **Range: [Materials:Material](#)**

Definition: The material(s) of which the physical artefacts that correspond to the PartElement are (to be) made.

Cardinality: at least 1

Other Roles

none.

2.3.10 Class: ProductCertification

Definition: A formal certificate granted by a registered product certification body indicating that the specified product has passed a set of performance tests and quality assurance tests, and qualification criteria that are stipulated in contracts, regulations, or specifications ("certification schemes").

Source: ISO/IEC Guide 28 (International Electrotechnical Commission (IEC) 2004)

Properties

DataProperty: description **Type: [OWL:String](#)**

Definition: A text description of the nature, properties, tests, and authorities, for the certification.

Cardinality: at most 1

ObjectProperty: code **Range: [CertificationCode](#)**

Definition: A standard code that designates the specific Certification, its properties, tests, and authorities.

Cardinality: exactly 1

Other Roles

From: [ItemCharacterization](#) as certifications

2.3.11 Class: SafetyFunctionCode

Definition: A code for a class of functional unit whose members are engaged in safety-related activities regarding personnel, environment and material assets.

Source: IEC 61511 (International Electrotechnical Commission (IEC) 2003)

SubclassOf: [Codes:Code](#)

Properties

none.

Other Roles

From: [SafetyInstrumentedFunction](#) as functionCode

2.3.12 Class: SafetyInstrumentedFunction

Definition: A class of functionality involving safety-related activities regarding personnel, environment and material assets. A safety function has a specified safety integrity level which is necessary to achieve functional safety. A safety instrumented function can be either a safety instrumented protection function or a safety instrumented control function. Abbreviated: SIF.

Source: The concept Safety Instrumented Function is formalized in IEC 61508 (International Electrotechnical Commission (IEC) 2010) and is further elaborated for process plants in IEC 61511 (International Electrotechnical Commission (IEC) 2003).

Properties

DataProperty: description **Type: [OWL:String](#)**

Definition: text description of the safety function.

Cardinality: at most 1

ObjectProperty: functionCode **Range: [SafetyFunctionCode](#)**

Definition: A code for a class of functional unit whose members are engaged in safety-related activities regarding personnel, environment and material assets.

Source: IEC 61511

Cardinality: at most 1

ObjectProperty: integrityLevel **Range: [SafetyIntegrityLevel](#)**

Definition: The relative level of risk-reduction that is provided by, or required to be provided by, the safety integrated function.

See IEC 61511

Cardinality: at most 1

Other Roles

From: [ItemCharacterization](#) as safetyFunction

2.3.13 Class: SafetyIntegrityLevel

Definition: A relative level of risk-reduction provided by a control system safety function. abbreviated: SIL. In simple terms, SIL is a measurement of performance for a Safety Instrumented Function (SIF).

Source: The concept Safety Integrity Level is formalized in IEC 61508(International Electrotechnical Commission (IEC) 2010), and four general SILs are defined.

SubclassOf: [Codes:Code](#)

Properties

none.

Other Roles

From: [SafetyInstrumentedFunction](#) as integrityLevel

2.3.14 Class: WettedPart

Definition: The characterization of a part of a PlantItem (pump, valve, instrument, etc.) that makes direct contact with the process fluid. As a consequence, the material of which it is constructed must be able to withstand the characteristics of the process fluid and perform correctly.

The material is typically specified by the builder/owner, based on his knowledge of the process fluid. A recognized material designation (ISO, ASTM, UNS, etc.) is recommended where possible.

Source: HI EDE 50.7

SubclassOf: [PartCharacterization](#)

Aspects: abstract

Properties

none.

Other Roles

none.

2.4 Product Data Sheet Usage

This section relates different usages to Product Data Sheets. A Product Data Sheet is a representation of an ItemCharacterization – a set of specified properties of a given PlantItem and their values. Item Characterizations relate to design elements, product catalog entries, and actual measured properties of plant floor equipment. These concepts are depicted in Figure 6 and described below.

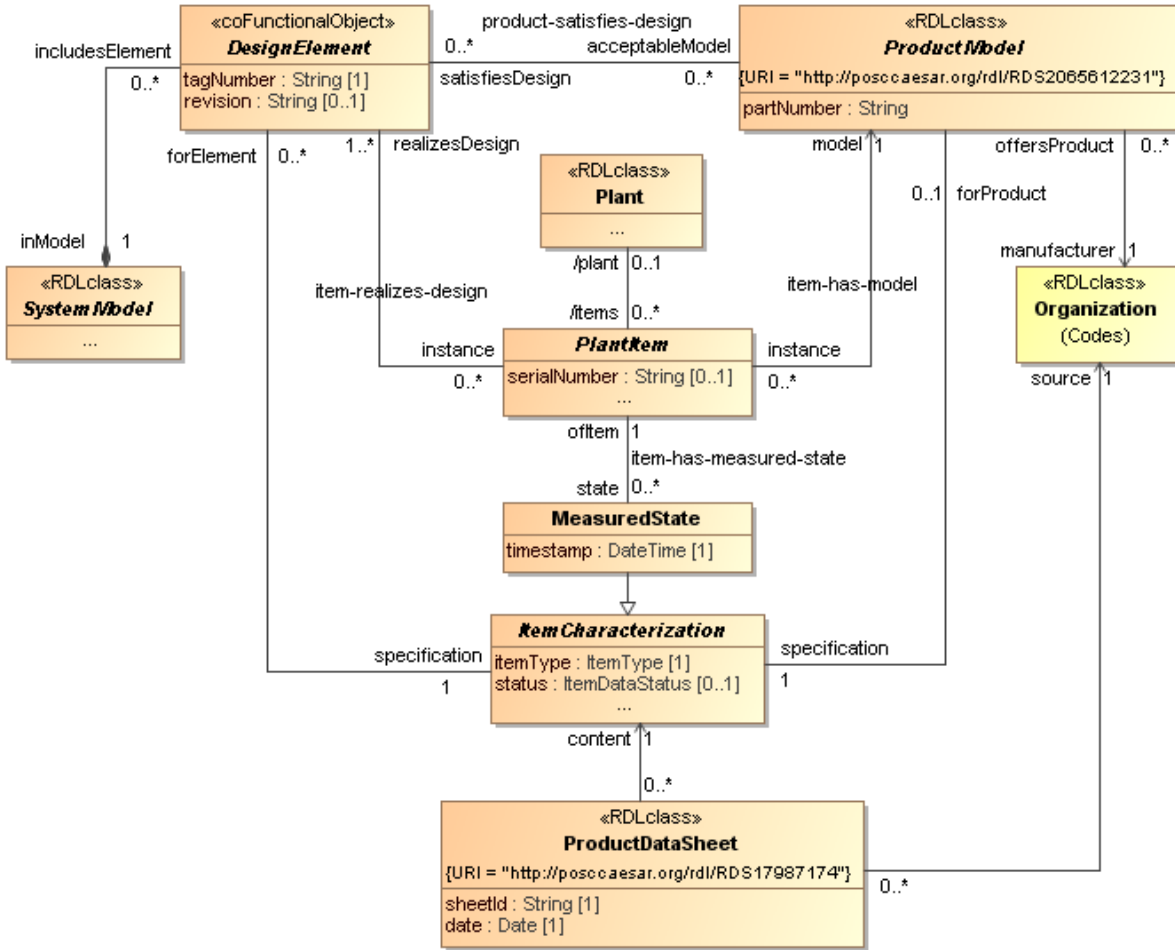

Figure 6 Product Data Sheet Usage

It is very important to understand that the content of a product data sheet is an ItemCharacterization. An ItemCharacterization is a description of a PlantItem at some point in the lifecycle – as it was at a point in time (MeasuredState), or as it is required to be (specification in DesignElement or ProductModel). As in common engineering practice, we may talk about an ItemCharacterization using a term for a kind of PlantItem or Product, but we mean a characterization of it, not the physical object. It is the fact that a product data sheet contains a description that allows it to be used for multiple purposes.

2.4.1 Class: MeasuredState

Definition: A set of measurements of properties of a PlantItem that are made at a specific point in time.

SubclassOf: [ItemCharacterization](#)

Properties

DataProperty: timestamp **Type: [OWL:DateTime](#)**

Definition: The (nominal) Date and Time at which this set of measurements was made.

Cardinality: exactly 1

ObjectProperty: ofItem **Range: [PlantItem](#)**

inverse: [PlantItem](#).state

Definition: The individual Plant Item that this set of measurements characterizes.

Cardinality: exactly 1

Other Roles

none.

2.4.2 Class: ProductDataSheet

Stereotypes: [ISO-15926:RDLclass](#)

Definition: A description of a given Product or component that is a set of defined fields within which information is supplied, to convey specific properties of the Product or component.

Source: RDL, URI = <http://posccaesar.org/rdl/RDS17987174>

Properties

DataProperty: date **Type: [OWL:DateTime](#)**

Definition: The date of issuance, or recording, of the Product Data Sheet.

Cardinality: exactly 1

DataProperty: sheetId **Type: [OWL:String](#)**

Definition: An identification code for a data sheet.

Cardinality: exactly 1

ObjectProperty: content **Range: [ItemCharacterization](#)**

Definition: The ItemCharacterization (a set of properties) that forms the main content of the ProductDataSheet.

Cardinality: exactly 1

ObjectProperty: source **Range: [Codes:Organization](#)**

Definition: The Organization that produced the Product Data Sheet.

Cardinality: exactly 1

Other Roles

none.

2.4.3 Class: ProductModel

Stereotypes: [ISO-15926:RDLclass](#)

Definition: An 'artefact class' whose members are classes of individuals that are the outcome of a manufacturing process.

Source: RDL as Manufactured Product Class, URI = <http://posccaesar.org/rdl/RDS2065612231>

Aspects: abstract

Properties

DataProperty: partNumber **Type:** [OWL:String](#)

Definition: A product code for a version of an artefact. The partNumber should be unique within the catalog of the manufacturer of the ProductModel.

Source: RDL, URI = <http://posccaesar.org/rdl/page/RDS8502722>

Cardinality: exactly 1

ObjectProperty: manufacturer **Range:** [Codes:Organization](#)

Definition: The Organization that manufactures and provides the Product artefacts described by the ProductModel.

Cardinality: exactly 1

ObjectProperty: satisfiesDesign **Range:** [DesignElement](#)

inverse: [DesignElement](#).acceptableModel

Definition: The DesignElements (in a particular model) that Artefacts conforming to the ProductModel could satisfy.

Cardinality: unconstrained

ObjectProperty: specification **Range:** [ItemCharacterization](#)

inverse: [ItemCharacterization](#).forProduct

Definition: The specifications for product Artefacts that are instances of this ProductModel.

Cardinality: exactly 1

Other Roles

From: [PlantItem](#) as model

2.5 Ports and Connections

This section describes the connection concepts, logical and physical, that are common across design elements and product models for equipment, instruments, valves and other line elements. The concepts are depicted in Figure 7 and described below.

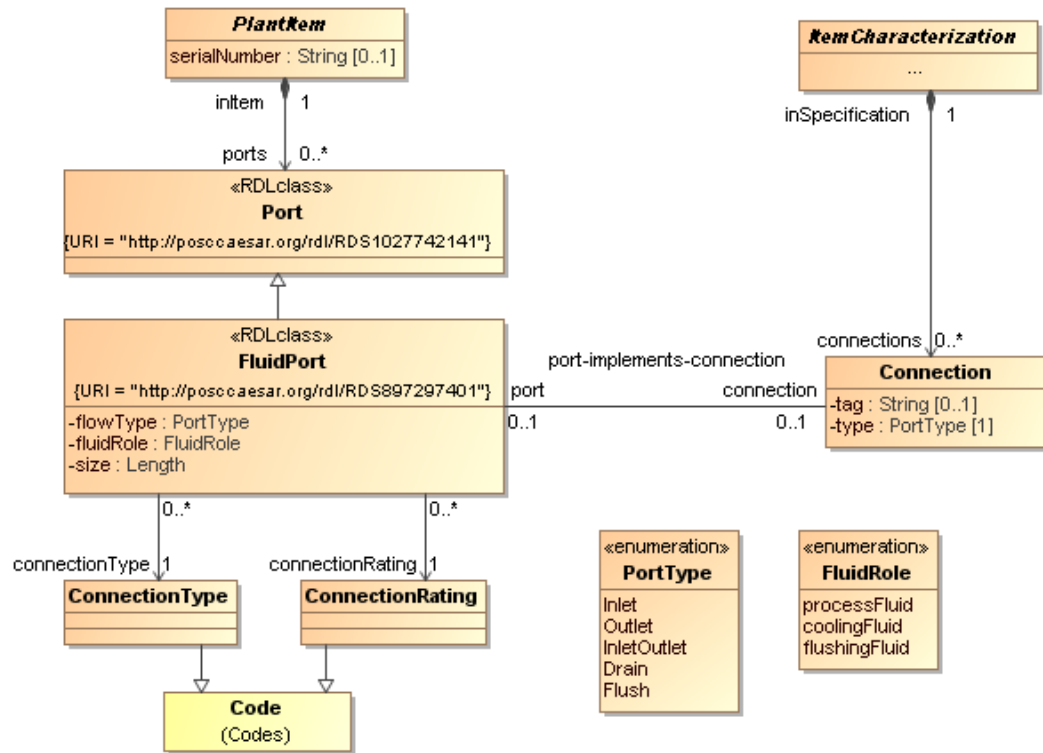

Figure 7 Ports and Connections

2.5.1 Class: Connection

Definition: The (conceptual) connection between the Equipment and the piping system, which is ultimately implemented by some Port on the body or casing of the Equipment.

Properties

DataProperty: tag Type: [OWL:String](#)

Definition: The identifier for the connection in the plant (functional) design.

Cardinality: at most 1

ObjectProperty: type Range: [PortType](#)

Definition: The functional role of the Connection with respect to the valve: inlet, outlet, other.

Cardinality: exactly 1

ObjectProperty: port **Range:** [FluidPort](#)

inverse: [FluidPort](#).connection v

Definition: The physical port (characterization) that implements the connection.

Cardinality: at most 1

Other Roles

From: [ItemCharacterization](#) as connections

2.5.2 Class: ConnectionRating

Definition: Pressure class rating for the connection. Information should include the governing body.

Source: HI EDE 50.7

SubclassOf: [Codes:Code](#)

Properties

none.

Other Roles

From: [FluidPort](#) as connectionRating

2.5.3 Class: ConnectionType

Definition: Type of the physical connector, taken from a standard or catalogue.

Source: HI EDE 50.7

Some common values: 16 AMP (16 AMP sanitary flange), Adapter, Blind, Brodie (manufacturer specific companion flange), Companion, DIN blind flange, DIN threaded flange, DIN flat face flange, DIN weld neck flange, DIN lapped joint flange, Female face – large, Female face – small, FF (Flat Face), Groove, Groove face – large, JIS (Japanese standard), Groove face – small, Lens joint (lens ring flange), LJ (Lapped Joints), Male face – large, Male face – small, O ring, Plate (manufacturer specific), Reducing (threaded flange), RF (Raised Face), RTJ (Ring Joint Face), SO (Slip-On), Split-ring, SW (Socket Welding flange), TandG (Tongue and Groove), Tongue face – large, Tongue face – small, VS (Van Stone flange), WN (Welding Neck)

SubclassOf: [Codes:Code](#)

Properties

none.

Other Roles

From: [FluidPort](#) as connectionType

2.5.4 Class: FluidPort

Stereotypes: [ISO-15926:RDLclass](#)

Definition: An opening in any kind of container or vessel for the entry or egress of substances which behave as fluids, i.e. gases, liquids and fluidized solids.

Source: RDL, URI = <http://posccaesar.org/rdl/RDS897297401>

SubclassOf: [Port](#)

Properties

ObjectProperty: flowType **Range:** [PortType](#)

Definition: The functional role of the Port with respect to the equipment: inlet, outlet, other.

Cardinality: exactly 1

ObjectProperty: fluidRole **Range:** [FluidRole](#)

Definition: The functional purpose of the fluid flowing through the Port.

Examples: process fluid, flushing fluid

Cardinality: exactly 1

ObjectProperty: size **Range:** [Quantities:Length](#)

Definition: The size of the port is usually its diameter.

Cardinality: exactly 1

ObjectProperty: connection **Range:** [Connection](#)

inverse: [Connection](#).port

Definition: The logical connection in the plant design, if any, that is implemented by the physical Port. Logical connections for valves are usually unlabeled, unless the valve is a rotary valve that affects process flow.

Cardinality: at most 1

ObjectProperty: connectionRating **Range:** [ConnectionRating](#)

Definition: Pressure class rating for the physical connection. Information should include the governing body.

Source: HI EDE 50.7

Cardinality: exactly 1

ObjectProperty: connectionType **Range:** [ConnectionType](#)

Definition: The physical structure of the Port connection. This is almost always a reference to an industry standard.

Note: The supplier's catalog always specifies the connection type. Depending on the nature of the equipment and the piping requirements, the owner may specify the type.

Source: HI EDE 50.7

Cardinality: exactly 1

Other Roles

none.

2.5.5 Class: Port

Stereotypes: [ISO-15926:RDLclass](#)

Definition: A device which is a point of interface by which a device communicates with another functional unit or system.

Source: RDL, URI = <http://posccaesar.org/rdl/RDS1027742141>

Definition: A physical element of a device that implements a functional interface (a Connection). A (usually integral) element of a device (PlantItem) that accommodates physical connection and load transference and/or enables the flow of material, power or signals into or out of the device.

Source: ISO 10303-227 (International Organization for Standardization (ISO) 2005)

Properties

none.

Other Roles

From: [PlantItem](#) as ports

2.5.6 Enumerated Class: FluidRole

Definition: The functional purpose of the fluid flowing into (or out of) a Port.

Named Individual Members

Member: processFluid

Definition: The fluid is the ProcessFluid and the Port is directly involved in the process flow.

Member: coolingFluid

Definition: The fluid serves to carry off heat, either through a heat exchanger that is part of the process, or as a means of cooling an Equipment item to maintain proper operating temperature.

Member: flushingFluid

Definition: The fluid serves only to flush the equipment unit when it is not in service.

Other Roles

From: [FluidPort](#) as fluidRole

2.5.7 Enumerated Class: PortType

Definition: Classification of a Port by its relationship to process fluid flow.

Named Individual Members

Member: Inlet

Definition: The port is the/an inlet for process fluid flowing into the equipment, valve, or instrument.

Member: Outlet

Definition: The port is the/an outlet for process fluid flowing out from the equipment, valve, or instrument.

Member: InletOutlet

Definition: The port serves as an inlet or an outlet for process fluid flow. Typically the port is normally an inlet, but it also accommodates backflow.

Member: Drain

Definition: The port is an auxiliary outlet, typically used to drain the equipment for maintenance, or to relieve pressure in exceptional situations.

Member: Flush

Definition: The port is an auxiliary inlet, typically used flood the equipment with a non-process fluid, such as a neutralizer or cleanser, for maintenance purposes.

Other Roles

From: [FluidPort](#) as flowType

From: [Connection](#) as type

3 Ontology: Pressure_Transmitter

This section models the properties of Pressure Transmitters that are commonly captured on product data sheets.

Note: In keeping with common engineering practice, this ontology uses the terms for the physical objects (Instrument and its subclasses and components), but they refer to characterizations of those objects that are developed at some point in the lifecycle. The terms do not really refer to the physical objects (PlantItems) themselves.

Imported Ontologies

This ontology extends the [General Product Data Sheet](#) model above. It uses the [Codes](#), [Materials](#), and [Quantities](#) ontologies defined below, and is annotated using the [ISO-15926](#) annotations (stereotypes). This ontology also uses the [Valves](#) ontology (defined below) for appropriate specification of pipeline connections.

3.1 Pressure Transmitters

This section describes the common properties of instruments and the special properties of Pressure Transmitters. They are shown in Figure 8.

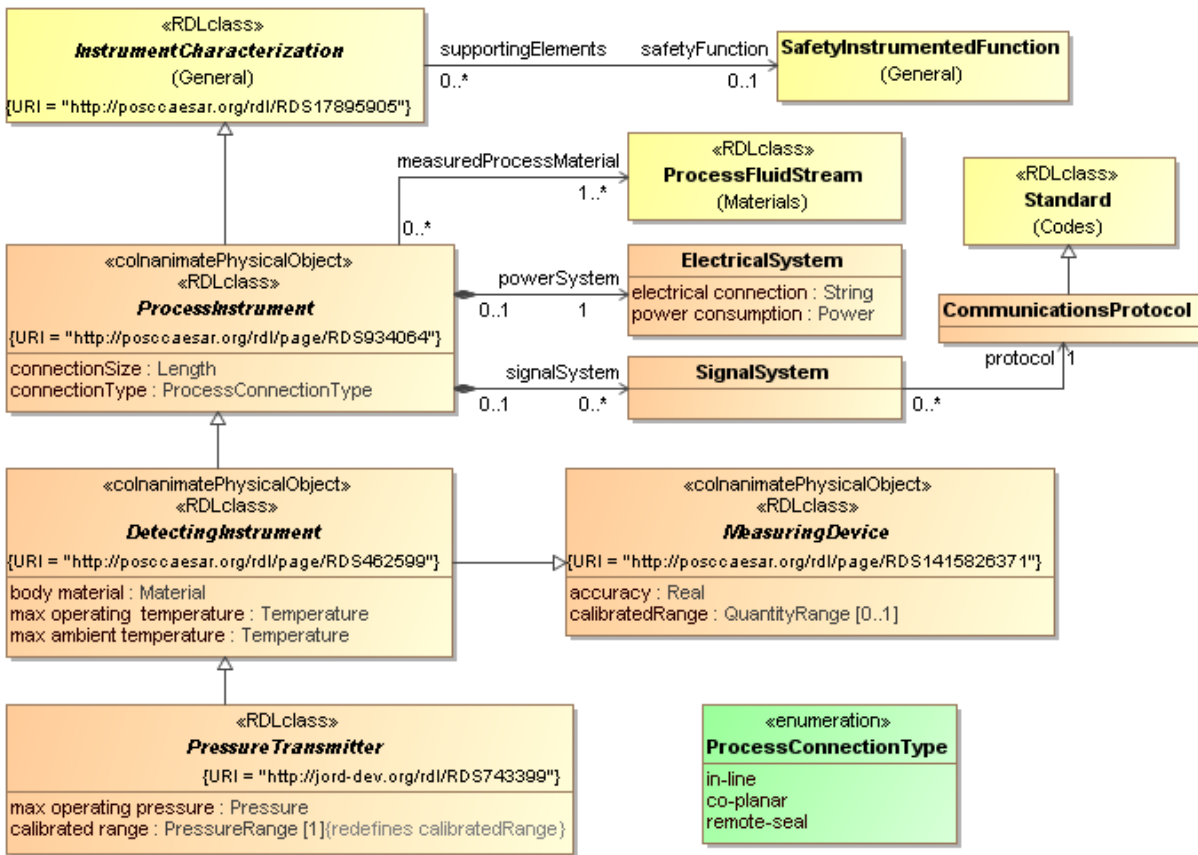

Figure 8 Pressure Transmitters and Instruments

3.1.1 Class: CommunicationProtocol

Definition: A standard specification for signaling conventions that use digital electronic messages.

Both open standards, such as Fieldbus, and proprietary/licensed protocols are commonly used.

SubclassOf: [Codes:Standard](#)

Properties

none.

Other Roles

From: [SignalSystem](#) as protocol

3.1.2 Class: DetectingInstrument

Stereotypes: [ISO-15926:RDLclass](#), [ISO-15926:coInanimatePhysicalObject](#)

Definition: A physical object that detects an aspect of something; records, modifies and/or displays such an aspect or performs a combination of these activities.

Source: RDL, URI = <http://posccaesar.org/rdl/page/RDS462599>

Aspects: abstract

SubclassOf: [MeasuringDevice](#), [ProcessInstrument](#)

Properties

ObjectProperty: body material **Range:** [Materials:Material](#)

Definition: The Material of which the instrument body is constructed.

Cardinality: exactly 1

ObjectProperty: max ambient temperature **Range:** [Quantities:Temperature](#)

Definition: The maximum temperature of the operating environment in which the instrument will function correctly.

Cardinality: exactly 1

ObjectProperty: max operating temperature **Range:** [Quantities:Temperature](#)

Definition: The maximum temperature of the process fluid for which the instrument will function correctly.

Cardinality: exactly 1

3.1.3 Class: ElectricalSystem

Definition: A subsystem whose purpose is to acquire and possibly convert electrical power for a device. It is typically presumed to possess all the electrical power properties of the device.

Properties

DataProperty: electrical connection Type: [OWL:String](#)

Definition: The Port used to make an electrical connection to the system in which the instrument is embedded.

Cardinality: exactly 1

ObjectProperty: power consumption Range: [Quantities:Power](#)

Definition: The nominal power consumption of the instrument.

Cardinality: exactly 1

Other Roles

From: [ProcessInstrument](#) as powerSystem

3.1.4 Class: MeasuringDevice

Stereotypes: [ISO-15926:RDLclass](#), [ISO-15926:coInanimatePhysicalObject](#)

Definition: A 'device' intended for 'measuring'.

Source: RDL, URI = <http://posccaesar.org/rdl/page/RDS1415826371>

For our purposes, a Measuring Device is an instrument or appliance whose purpose is to observe some aspect of a process, of the processing equipment, or of the process material, and convert it to a number, a signal, or an analog display, that has an interpretation as a state or quantity.

Aspects: abstract

Properties

DataProperty: accuracy Type: [OWL:Real](#)

Definition: The relative accuracy of the measurements. The uncertainty is expressed as a percentage of the reported values.

Cardinality: exactly 1

ObjectProperty: calibratedRange Range: [Quantities:QuantityRange](#)

Definition: The range of quantities of the measured kind for which the Device has been calibrated to produce results of a known accuracy.

Cardinality: at most 1

3.1.5 Class: PressureTransmitter

Stereotypes: [ISO-15926:RDLclass](#)

Definition: JORD: a transmitter that is producing a standardized output signal dependent of a received input signal from a pressure element.

Source: RDL, URI = <http://jord-dev.org/rdl/RDS743399>

Aspects: abstract

SubclassOf: [DetectingInstrument](#)

Properties

ObjectProperty: calibrated range **Range:** [Quantities:PressureRange](#)

Definition: The range of operating pressures for which the instrument has been calibrated to guarantee reliable measurement data.

Note: This is a specialization of the calibratedRange property of MeasuringDevice.

Cardinality: exactly 1

ObjectProperty: max operating pressure **Range:** [Quantities:Pressure](#)

Definition: The maximum process fluid pressure that can be measured by the instrument.

Cardinality: exactly 1

ObjectProperty: Oring **Range:** [O-Ring](#)

Definition: O-ring between the instrument and its flange.

Cardinality: at most 1, composite

ObjectProperty: diaphragm **Range:** [IsolatingDiaphragm](#)

Definition: A diaphragm separating the process fluid from the sensing components of the instrument.

Cardinality: exactly 1, composite

ObjectProperty: drain **Range:** [Drain](#)

Definition: A drain valve used in maintenance of the instrument.

Cardinality: exactly 1, composite

ObjectProperty: enclosure **Range:** [Enclosure](#)

Definition: The body enveloping an piece of equipment.

Cardinality: exactly 1, composite

ObjectProperty: flange **Range:** [Flange](#)

Definition: The flange connecting the instrument to the manifold or pipe.

Cardinality: exactly 1, composite

ObjectProperty: gasket **Range:** [Gasket](#)

Definition: A gasket separating the instrument from the process fluid

Cardinality: exactly 1, composite

ObjectProperty: manifold **Range:** [Manifold](#)

Definition: The manifold connecting the pressure transmitter.

Cardinality: exactly 1, composite

ObjectProperty: vent **Range: [Vent](#)**

Definition: A vent used to bleed the instrument or remove sediment deposits.

Cardinality: exactly 1, composite

Other Roles

From: [PDSheets:PXSheet](#) as forPX

3.1.6 Class: ProcessConnectionType

Definition: type of flanged connection between the instrument and the process

Named Individual Members

Member: in-line

Definition: one connection to process fluid

Member: co-planar

Definition: inlet and outlet to process fluid in the flow of the process fluid

Member: remote-seal

Definition: A connection to the process fluid is made with a diaphragm seal (two such seals for differential pressure measurement). A signal is transmitted to the transmitter using capillaries and a transmission fluid.

Other Roles

From: [ProcessInstrument](#) as connectionType

3.1.7 Class: ProcessInstrument

Stereotypes: [ISO-15926:RDLclass](#), [ISO-15926:coInanimatePhysicalObject](#)

Definition: A physical object that detects an aspect of something; records, modifies and/or displays such an aspect or performs a combination of these activities.

Source: RDL, URI = <http://posccaesar.org/rdl/RDS934064>

Aspects: abstract

SubclassOf: [General:InstrumentCharacterization](#)

Properties

ObjectProperty: connectionType **Range: [ProcessConnectionType](#)**

Definition: The method by which the instrument is physically connected to the process stream, for example, NPTF.

Cardinality: exactly 1

ObjectProperty: measuredProcessMaterial **Range: [Materials:ProcessFluidStream](#)**

Definition: The specification for the process fluid that is (to be) measured by the ProcessInstrument, including the range of relevant properties.

Cardinality: at least 1

ObjectProperty: powerSystem **Range: [ElectricalSystem](#)**

Definition: The subsystem that supplies electric power to the ProcessInstrument.

Cardinality: exactly 1, composite

ObjectProperty: signalSystem **Range: [SignalSystem](#)**

Definition: The subsystem that enables communication between the ProcessInstrument and the overall Instrumentation and Control systems.

Cardinality: unconstrained, composite

3.1.8 Class: SignalSystem

Definition: A subsystem whose purpose is to provide communications between a device and other systems, and possibly communications between subsystems of the device. These communications are implemented by signals of some kind (usually electronic), and may include higher-levels of messaging.

Properties

ObjectProperty: protocol **Range: [CommunicationProtocol](#)**

Definition: The standard signaling conventions supported by the SignalSystem.

Cardinality: exactly 1

Other Roles

From: [ProcessInstrument](#) as signalSystem

3.2 Pressure Transmitter Classification

This section provides a taxonomy for Pressure Transmitters. It is depicted in Figure 9, and described in detail below.

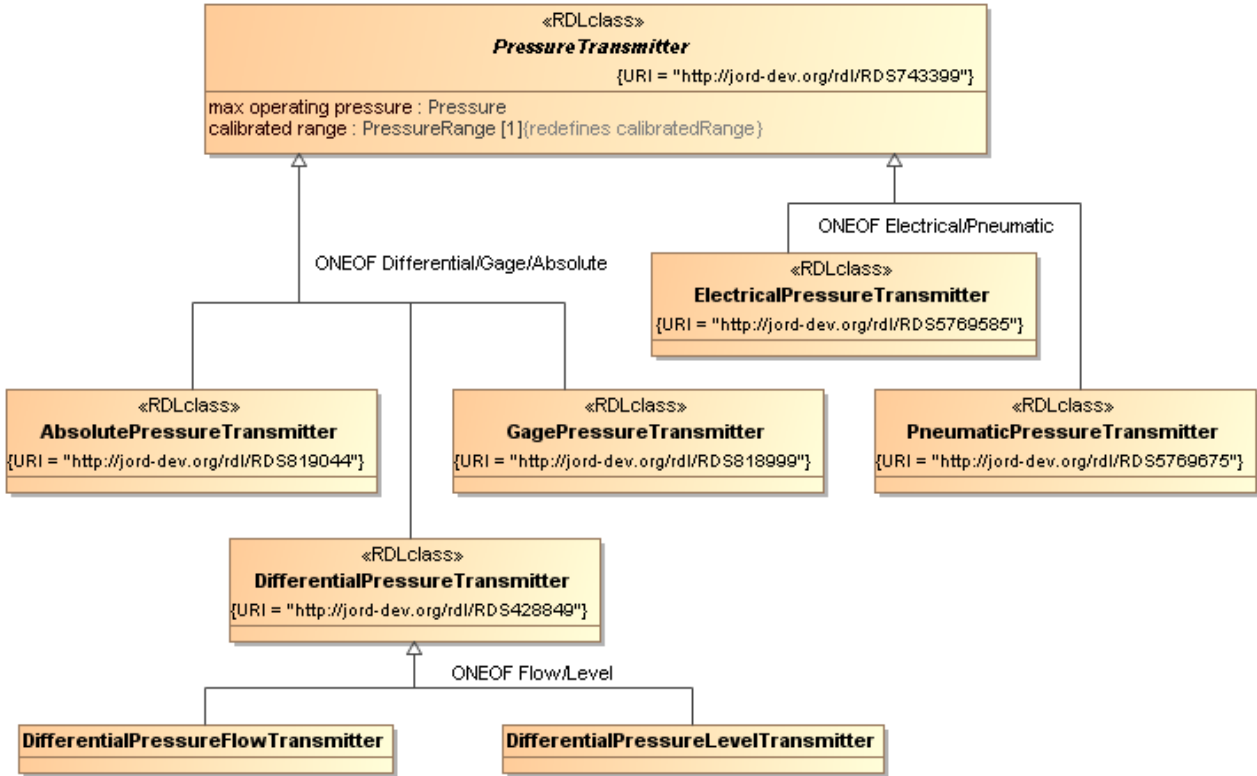

Figure 9 Pressure Transmitter taxonomy

3.2.1 Class: AbsolutePressureTransmitter

Stereotypes: [ISO-15926:RDLclass](#)

Definition: The transmitter generates a standardized output signal representing the actual pressure relative to full vacuum.

Source: RDL, URI = http://jord-dev.org/rdl/RDS819044

SubclassOf: [PressureTransmitter](#)

Properties

none.

3.2.2 Class: DifferentialPressureFlowTransmitter

Definition: A **DifferentialPressureTransmitter** with flow sensing capability.

SubclassOf: [DifferentialPressureTransmitter](#)

Properties

none.

3.2.3 Class: DifferentialPressureLevelTransmitter

Definition: A DifferentialPressureTransmitter with level sensing capability.

SubclassOf: [DifferentialPressureTransmitter](#)

Properties

none.

3.2.4 Class: ElectricalPressureTransmitter

Stereotypes: [ISO-15926:RDLclass](#)

Definition: A pressure transmitter that transmits an electrical signal.

Source: RDL, URI = <http://jord-dev.org/rdl/RDS5769585>

SubclassOf: [PressureTransmitter](#)

Properties

none.

3.2.5 Class: DifferentialPressureTransmitter

Stereotypes: [ISO-15926:RDLclass](#)

Definition: A pressure transmitter that is producing a standardized output signal dependent of a received pressure difference signal.

Source: RDL, URI = <http://jord-dev.org/rdl/RDS428849>

SubclassOf: [PressureTransmitter](#)

Properties

none.

3.2.6 Class: GagePressureTransmitter

Stereotypes: [ISO-15926:RDLclass](#)

Definition: A pressure transmitter that is generating a standardized electrical output signal representing the pressure detected by a pressure gauge.

Source: RDL, URI = <http://jord-dev.org/rdl/RDS818999>

SubclassOf: [PressureTransmitter](#)

Properties

none.

3.3 Pressure Transmitter Structure

This section describes the structural elements of a pressure transmitter. The concepts are depicted in Figure 10 and described below.

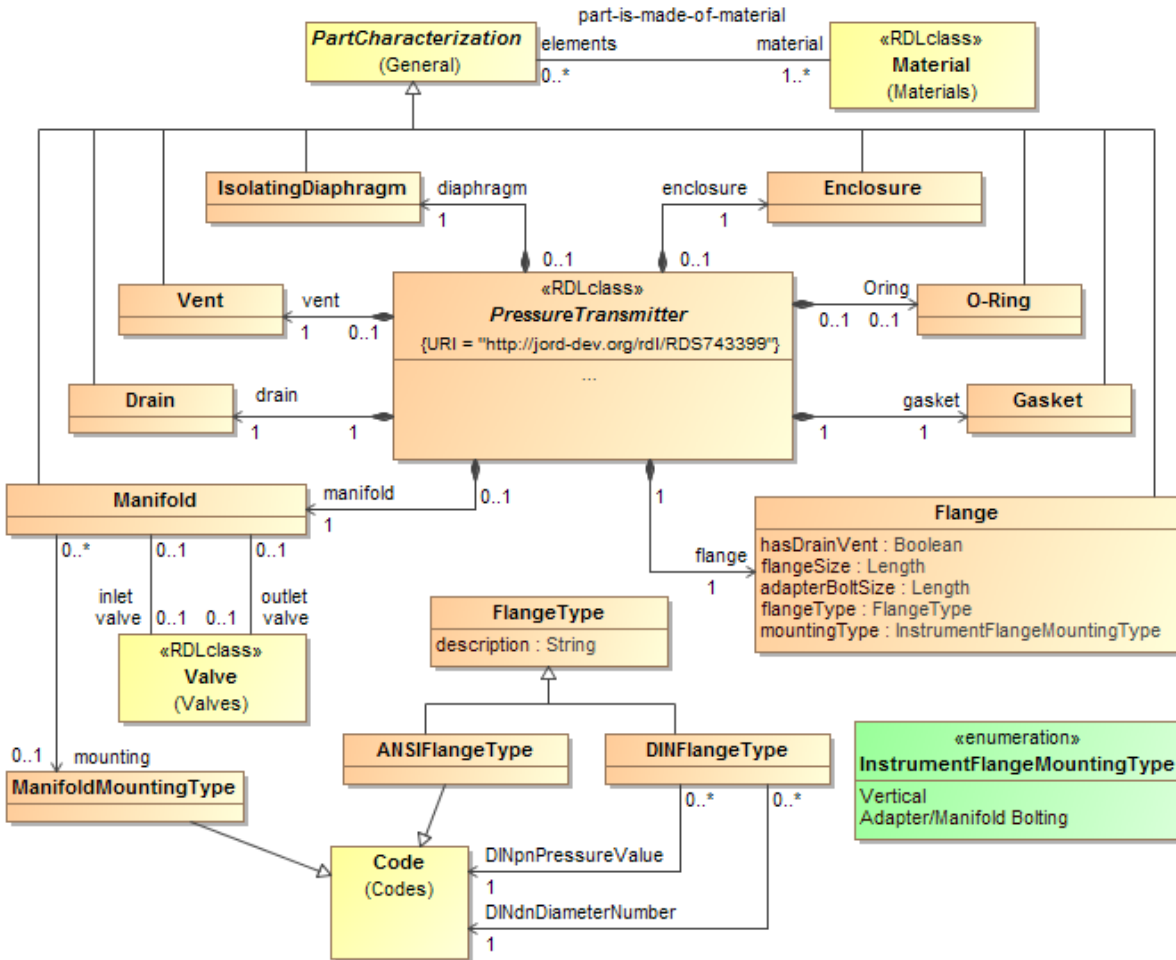

Figure 10 Pressure Transmitter structure

3.3.1 Class: ANSIFlangeType

Definition: A FlangeType that is specified by an American National Standards Institute (ANSI) specification.

SubclassOf: [FlangeType](#)

Properties

ObjectProperty: ANSIFlangeClass Range: [Codes:Code](#)

Definition: ANSI B16.5 flange classification

Note: For these codes the definedByStandard is necessarily ANSI B16.5.

Cardinality: exactly 1

3.3.2 Class: DINFlangeType

Definition: Any DIN flange classification scheme.

SubclassOf: [FlangeType](#)

Properties

ObjectProperty: DINdnDiameterNumber Range: [Codes:Code](#)

Definition: DIN flange diameter code number.

Cardinality: exactly 1

ObjectProperty: DINpnPressureValue Range: [Codes:Code](#)

Definition: DIN flange rated pressure code.

Cardinality: exactly 1

3.3.3 Class: Drain

Definition: A device that allows liquid to leave a container under gravity. Also called a *vent*.

Source: RDL, URI = <http://posccaesar.org/rdl/RDS1330900681>

SubclassOf: [General:PartElement](#)

Properties

none.

Other Roles

From: [PressureTransmitter](#) as drain

3.3.4 Class: Enclosure

Definition: A physical object that separates enclosed physical objects from those outside.

Source: RDL, URI = <http://posccaesar.org/rdl/RDS997405351>

SubclassOf: [General:PartElement](#)

Properties

none.

Other Roles

From: [PressureTransmitter](#) as enclosure

3.3.5 Class: Flange

Definition: An artefact that is intended to connect an instrument sensor to the process and also accommodate vent and drain.

Source: RDL, URI = <http://posccaesar.org/rdl/RDS6650788>

SubclassOf: [General:PartElement](#)

Properties

ObjectProperty: adapterBoltSize Range: [Quantities:Length](#)

Definition: length of adapter bolts.

Cardinality: exactly 1

DataProperty: hasDrainVent Type: [OWL:Boolean](#)

Definition: indicates whether the flange has a drain or vent.

Cardinality: exactly 1

ObjectProperty: flangeSize Range: [Quantities:Length](#)

Definition: The size of the flange.

Cardinality: exactly 1

ObjectProperty: flangeType Range: [FlangeType](#)

Definition: The type of flange used.

Cardinality: exactly 1

ObjectProperty: mountingType Range: [InstrumentFlangeMountingType](#)

Definition: The physical arrangement by which the instrument is mounted on the pipe.

Cardinality: exactly 1

Other Roles

From: [PressureTransmitter](#) as flange

3.3.6 Class: FlangeType

Definition: A description of the flange type of a product, typically a reference to a standard.

Source: RDL, URI = <http://posccaesar.org/rdl/RDS14176724>

Properties

DataProperty: description Type: [OWL:String](#)

Definition: A text description of the characteristics of the FlangeType and its relationship to standards.

Cardinality: exactly 1

Other Roles

From: [Flange](#) as flangeType

3.3.7 Class: Gasket

Definition: A seal that is one or more closed loops of deformable material used between mating surfaces which have only very limited movement relative to each other.

Source: RDL, URI = <http://posccaesar.org/rdl/RDS415394>

SubclassOf: [General:PartElement](#)

Properties

none.

Other Roles

From: [PressureTransmitter](#) as gasket

3.3.8 Class: IsolatingDiaphragm

Definition: A diaphragm that is intended to isolate the process medium from the internal medium at the connection to a process medium.

Source: RDL, URI = <http://posccaesar.org/rdl/RDS429389>

SubclassOf: [General:PartElement](#)

Properties

none.

Other Roles

From: [PressureTransmitter](#) as diaphragm

3.3.9 Class: Manifold

Definition: Typically an arrangement of pipes used to redistribute the flow of a fluid or gas, typically from a single inlet to a number of outlets or vice versa.

Source: RDL, URI = <http://posccaesar.org/rdl/RDS903171211>

SubclassOf: [General:PartElement](#)

Properties

ObjectProperty: inletValve **Range:** [Valves:Valve](#)

Definition: The valve that connects the manifold to the pipeline on the upstream side. This is often a splitter/router valve that feeds multiple internal flow lines in the manifold.

Note: The relevant valve properties (type, max pressure, material, etc.) may be captured as a standard ValveType or as a specific product id chosen by the instrument manufacturer.

ObjectProperty: mounting **Range:** [ManifoldMountingType](#)

Definition: The method of mounting the manifold to the flange.

Source: RDL, URI = <http://posccaesar.org/rdl/RDS9660662>

Cardinality: exactly 1

ObjectProperty: outletValve **Range:** [Valves:Valve](#)

Definition: The valve that connects the manifold to the pipeline on the upstream side. This is often a splitter/router valve that feeds multiple internal flow lines in the manifold.

Note: The relevant valve properties (type, max pressure, material, etc.) may be captured as a standard ValveType or as a specific product id chosen by the instrument manufacturer.

Other Roles

From: [PressureTransmitter](#) as manifold

3.3.10 Class: ManifoldMountingType

Definition: A classification of mounting type methods.

SubclassOf: [Codes:Code](#)

Properties

none.

Other Roles

From: [Manifold](#) as mounting

3.3.11 Class: O-Ring

Definition: A seal ring that has a circular cross section.

SubclassOf: [General:PartElement](#)

Properties

none.

Other Roles

From: [PressureTransmitter](#) as Oring

3.3.12 Class: Vent

Definition: A vented cable or a hole on the side of the device that allows the outside air pressure to be exposed to the negative side of the pressure sensing diaphragm.

Source: (Wikipedia n.d.)

SubclassOf: [General:PartElement](#)

Properties

none.

Other Roles

From: [PressureTransmitter](#) as vent

3.3.13 Enumerated Class: InstrumentFlangeMountingType

Definition: An enumeration of methods of mouting instruments.

Named Individual Members

Member: Vertical

Definition: The instrument is placed above the flange.

Member: Adapter/Manifold Bolting

Definition: a manifold or adapter attaches to the flange.

Other Roles

From: [Flange](#) as mountingType

4 Ontology: Centrifugal_Pump

This ontology models the specific properties of a centrifugal pump and its components, as they may appear in a product data sheet for a design element or in a manufacturer’s specification.

Note: In keeping with common engineering practice, this ontology uses the terms for the physical objects (Pump and its subclasses and components), but they refer to characterizations of those objects that are developed at some point in the lifecycle. The terms do not really refer to the physical objects themselves.

Imported Ontologies

This ontology extends the [General Product Data Sheet](#) model above. It uses the [Codes](#), [Materials](#), [Quantities](#), and [Shaft Seals](#) ontologies defined below, and is annotated using the [ISO-15926](#) annotations (stereotypes).

4.1 Pump Taxonomy

This section provides an overview of pump classification. The concepts are presented in Figure 11 and described in detail below. The source of this taxonomy is the Hydraulic Industries HI EDE 50.7 standard.

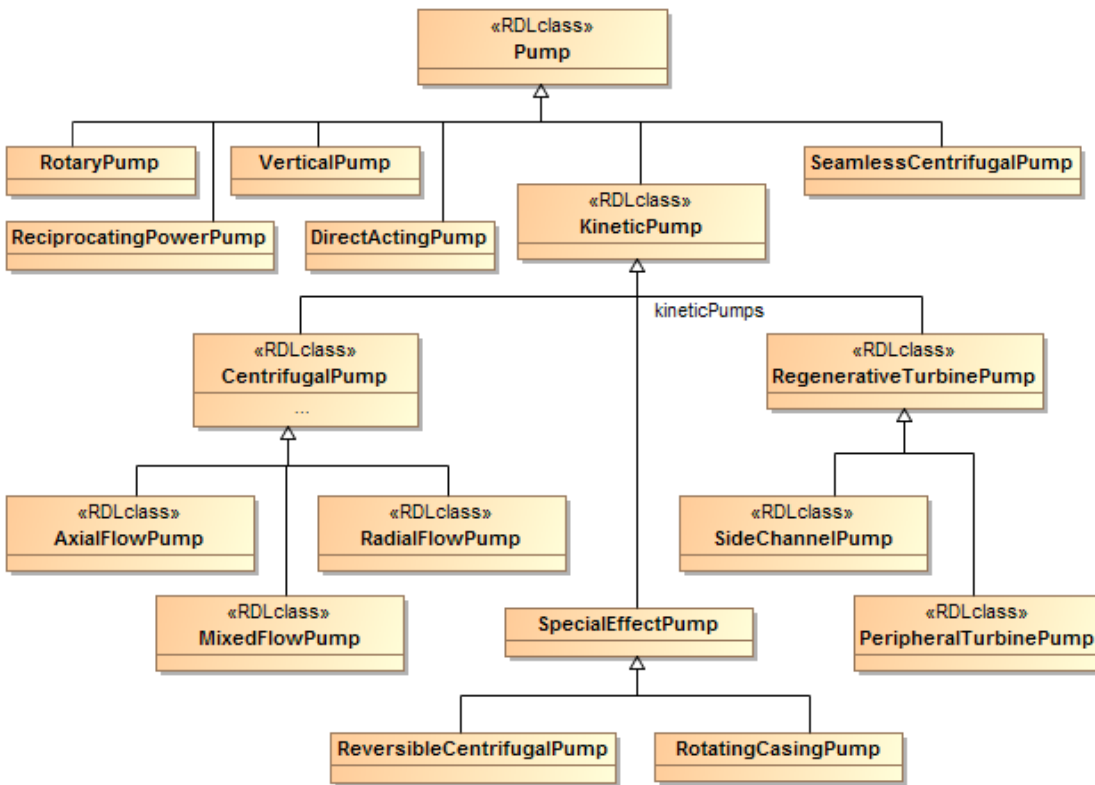

Figure 11 Pump Classifications

4.1.1 Class: Pump

Stereotypes: [ISO-15926:RDLclass](#)

Definition: A physical object that is a driven piece of equipment in which energy is either constantly or periodically added to an amount of pumped liquid in order to increase the pressure required for the process in which the pump is in operation.

Source: RDL, URI = <http://posccaesar.org/rdl/RDS327239>

SubclassOf: [General:EquipmentCharacterization](#)

Properties

ObjectProperty: connections Range: [Connection](#)

Definition: The (conceptual) connections between the Pump and the piping system, which are ultimately implemented by some Port on the casing.

Cardinality: 2 or more, composite

ObjectProperty: inComplex Range: [PumpComplex](#)

inverse: [PumpComplex.pumps](#)

Definition: The PumpComplex, if any, to which this Pump belongs

Cardinality: at most 1

ObjectProperty: pumpedFluid Range: [Materials:Fluid](#)

Definition: The Fluid whose flow is the purpose of the Pump. For most uses of this ontology, that is the ProcessFluidStream.

Cardinality: at least 1

Other Roles

From: [PDSheets:PumpSheet](#) as forPump

4.1.2 Class: AxialFlowPump

Stereotypes: [ISO-15926:RDLclass](#)

Definition: A centrifugal pump that is provided with an axial flow impeller to generate relatively low head at large flows.

Source: RDL, URI = <http://posccaesar.org/rdl/RDS16765074>

SubclassOf: [CentrifugalPump](#)

Properties

none.

4.1.3 Class: CentrifugalPump

Stereotypes: [ISO-15926:RDLclass](#)

Definition: A CentrifugalPump is a Pump whose function it is to raise the pressure of a liquid using kinetic energy.

Source: cfiXML

Definition: A dynamic pump utilizing impellers provided with vanes generating centrifugal force to achieve the required pressure head.

Source: RDL, URI = <http://posccaesar.org/rdl/RDS416834>

SubclassOf: [KineticPump](#)

Properties

The properties of a CentrifugalPump are detailed in 4.2.4.

4.1.4 Class: DirectActingPump

Definition: A reciprocating pump where the pump driver is a piston motor integrally built as part of the pump unit. The piston motor can be driven by compressed gas like steam, air, etc. The pump can be of the double acting or single acting piston, or plunger type.

Source: RDL, URI = <http://posccaesar.org/rdl/page/RDS866834>

SubclassOf: [Pump](#)

Properties

none.

4.1.5 Class: KineticPump

Stereotypes: [ISO-15926:RDLclass](#)

Definition: A kinetic pump imparts velocity energy to the fluid, which is converted to pressure energy upon exiting the pump casing.

Source: (PDHengineer.com 2012)

Definition: A pump that impels fluid by reaction forces from moving or rotating vanes or blades inside a pump casing.

Source: RDL, URI = <http://posccaesar.org/rdl/RDS432584>

SubclassOf: [Pump](#)

Properties

none.

4.1.6 Class: MixedFlowPump

Stereotypes: [ISO-15926:RDLclass](#)

Definition: A centrifugal pump that uses a mixed flow pump impeller.

Source: RDL, URI = <http://posccaesar.org/rdl/RDS409575791>

SubclassOf: [CentrifugalPump](#)

Properties

none.

4.1.7 Class: PeripheralTurbinePump

Stereotypes: [ISO-15926:RDLclass](#)

Definition: a low-capacity high-head type used on heads up to 5400 ft (1645 m) and in capacities up to 150 gpm (34 m³/hr). Turbine pumps are known by several names, such as vortex, periphery and regenerative. Among them are the horizontal-shaft diffuser type and vertical-shaft deep-well centrifugal.

Source: RDL, URI = <http://posccaesar.org/rdl/RDS412376541>, (Roth Pump Company n.d.)

SubclassOf: [RegenerativeTurbinePump](#)

Properties

none.

4.1.8 Class: RadialFlowPump

Stereotypes: [ISO-15926:RDLclass](#)

Definition: A centrifugal pump that uses a radial flow impeller.

Source: RDL, URI = <http://posccaesar.org/rdl/RDS12957061>

SubclassOf: [CentrifugalPump](#)

Properties

none.

4.1.9 Class: ReciprocatingPowerPump

Definition: A reciprocating pump utilising pistons, plungers or diaphragm driven via a crankshaft, connecting rod and crosshead at constant stroke. The pump operates with in- and outlet valves. The pump operates with constant torque and nearly constant capacity (per stroke).

Source: RDL, URI = <http://posccaesar.org/rdl/page/RDS816254>

SubclassOf: [Pump](#)

Properties

none.

4.1.10 Class: RegenerativeTurbinePump

Stereotypes: [ISO-15926:RDLclass](#)

Definition: A turbine that contains a wheel or runner which carries curved vanes or buckets and is supplied with water directed by a number of stationary guide vanes or hit by a high pressure water jet, intended to recover energy and to serve as a driver.

Source: RDL, URI = <http://posccaesar.org/rdl/RDS1083689>

SubclassOf: [KineticPump](#)

Properties

none.

4.1.11 Class: ReversibleCentrifugalPump

Definition: A centrifugal pump capable of rotating in a normal direction while enabling a fluid to flow in a normal direction and rotating in a reverse direction while enabling the fluid to flow in the reverse direction without having its pumping efficiency dropping to a lower level in a reverse rotation mode than in a normal rotation mode.

Source: (Fukazawa and Yokoyama 1985)

SubclassOf: [SpecialEffectPump](#)

Properties

none.

4.1.12 Class: RotaryPump

Definition: A positive displacement pump that consists of a chamber containing gears, cams, screws, vanes, plungers or similar elements actuated by relative rotation of the drive shaft or casing and which has no separate inlet and outlet valves.

Source: RDL, URI = <http://posccaesar.org/rdl/page/RDS420749>

SubclassOf: [Pump](#)

Properties

none.

4.1.13 Class: RotatingCasingPump

Definition: The rotating casing pump is a variation of a rotodynamic design and uses a pitot tube, in lieu of a volute or diffuser, to capture flow and convert velocity energy to pressure. The primary feature of a pitot tube pump that differentiates it from a conventional rotodynamic pump is that it uses a rotating casing instead of an impeller to impart velocity to the pumped liquid.

Source: (Hydraulic Institute n.d.)

SubclassOf: [SpecialEffectPump](#)

Properties

none.

4.1.14 Class: SeamlessCentrifugalPump

Definition: A CentrifugalPump comprising a motor, a pump casing that houses a stator and a rotor assembly, where the rotor assembly surrounds at least a portion of the stator, and a rotatable housing surrounds at least a portion of the pump casing and is operatively connected to the motor.

Source: (Sheehan 1997)

SubclassOf: [Pump](#)

Properties

none.

4.1.15 Class: SideChannelPump

Stereotypes: [ISO-15926:RDLclass](#)

Definition: The Side channel pump is a niche product between the Displacement and the Centrifugal pump that is intended to pump mixtures of air, gases and liquids. When started, the pump begins to work as a Displacement pump, but once the side channels are completely filled with liquid, the pump will work as a Centrifugal pump. Due to the centrifugal effect, the fluid is collected in the outer region of the side channel as well as the wheel cells, where it forms the liquid ring that makes the pump self-priming, while the gas is concentrated on the inside.

Source: RDL, URI = <http://posccaesar.org/rdl/RDS418675451>, (CP Pump Systems n.d.)

SubclassOf: [RegenerativeTurbinePump](#)

Properties

none.

4.1.16 Class: SpecialEffectPump

Definition: These are pumps in which the means of energy addition is still kinetic, the addition of velocity, but that employ effects other than that of the classical centrifugal pump to do so. At present there are six distinct types of special effect pumps: regenerative, partial emission, induced vortex, viscous drag, impact, and reversible.

Source: (Karassik and McGuire 1997)

SubclassOf: [KineticPump](#)

Properties

none.

4.1.17 Class: VerticalPump

Definition: The pump utilizes a unique shaft and bearing support configuration that allows the volute to hang in the sump while the bearings are outside of the sump. This style of pump uses no stuffing box to seal the shaft but instead utilizes a "throttle bushing." A common application for this style of pump is in a parts washer.

Source: RDL, URI = <http://posccaesar.org/rdl/RDS427286061>, (Wikipedia n.d.)

SubclassOf: [Pump](#)

Properties

none.

4.2 Centrifugal Pump Specification

This section provides an overview of the Centrifugal Pump model, as shown in Figure 12, and describes the Pump and Centrifugal Pump classes in detail, as shown in Figure 13.

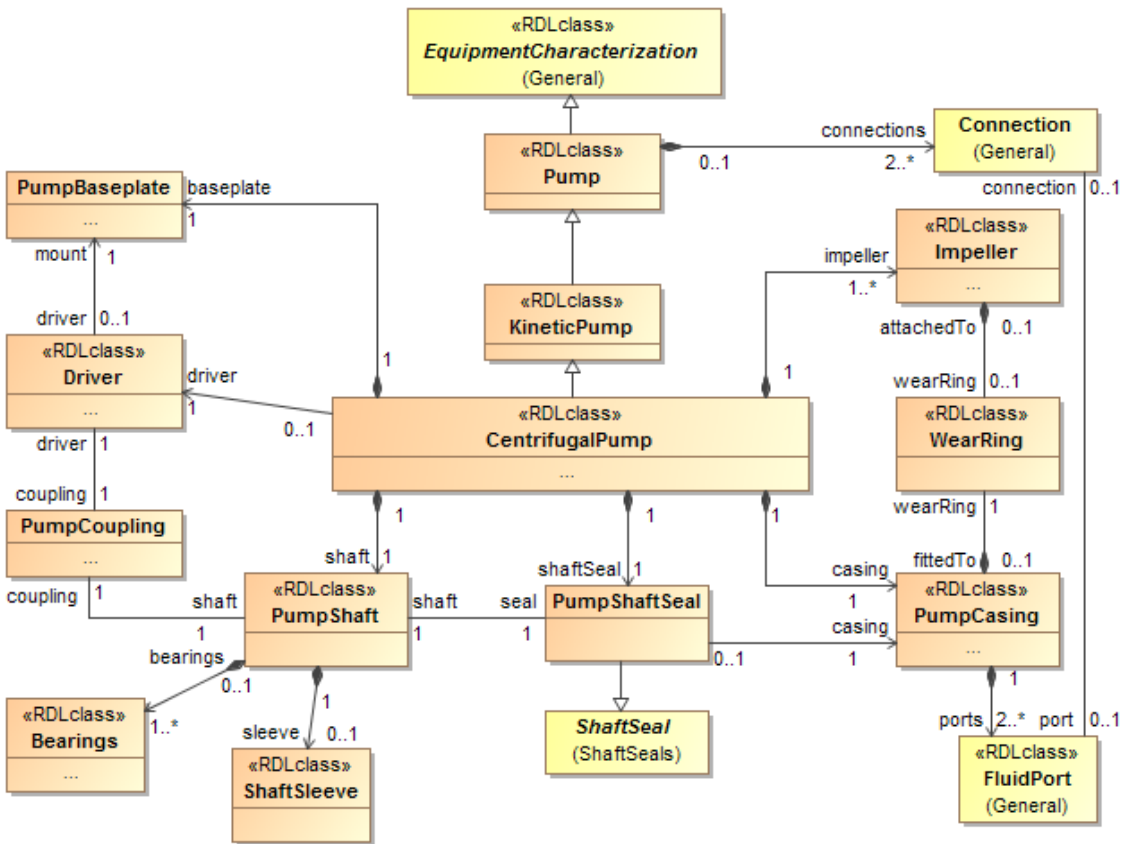

Figure 12 Overview of the Centrifugal Pump structure

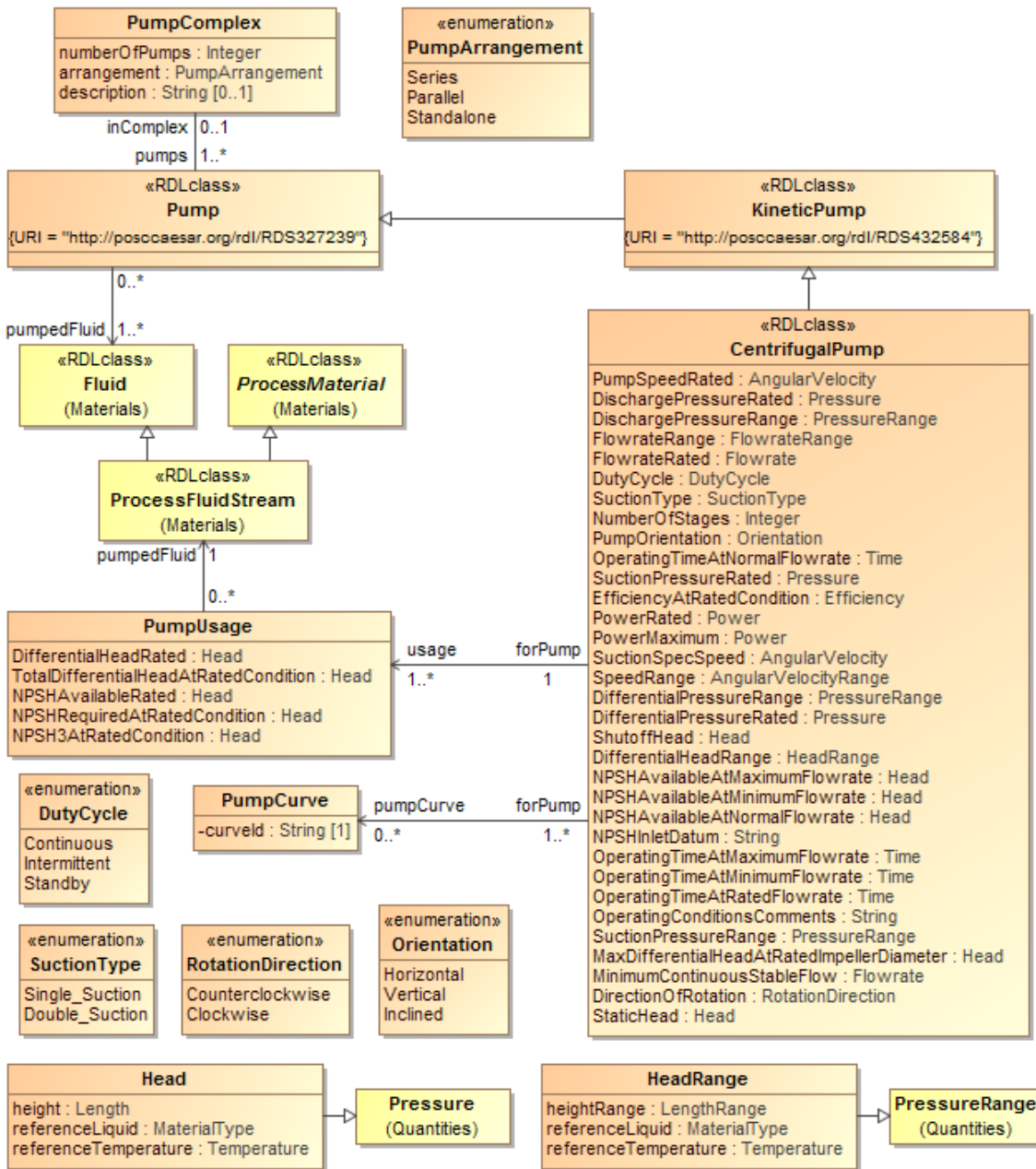

Figure 13 Detail of basic Pump elements

4.2.1 Class: Head

Definition: A Pressure value expressed as the pressure equivalent to that of a given height of a column of a given reference liquid -- usually water or mercury -- at a given temperature. The values are therefore given as: length (of) liquid (material) type at temperature, such as "5 m H2O at 4 C" or "750 mm Hg at 293K."

Note: In practice, Head specifications for a PumpUsage need not specify any value but the height, when the reference liquid and temperature are properties of the ProcessFluidStream.

SubclassOf: [Quantities:Pressure](#).

Properties

ObjectProperty: height **Range:** [Quantities:Length](#)

Definition: The equivalent height of the column of liquid.

Cardinality: exactly 1

ObjectProperty: referenceLiquid **Range:** [Materials:MaterialType](#)

Definition: The reference liquid, usually water or mercury.

Cardinality: exactly 1

ObjectProperty: referenceTemperature **Range:** [Quantities:Temperature](#)

Definition: The reference temperature of the reference liquid.

Cardinality: exactly 1

Other Roles

From: [CentrifugalPump](#) as ShutoffHead

From: [CentrifugalPump](#) as NPSHAvailableAtMaxFlowrate

From: [CentrifugalPump](#) as NPSHAvailableAtMinimumFlowrate

From: [CentrifugalPump](#) as NPSHAvailableAtNormalFlowrate

From: [CentrifugalPump](#) as MaxDifferentialHeadAtRatedImpellerDiameter

From: [PumpUsage](#) as DifferentialHeadRated

From: [PumpUsage](#) as NPSHAvailableRated

From: [PumpUsage](#) as NPSH3AtRatedCondition

From: [PumpUsage](#) as NPSHrAtRatedCondition

From: [PumpUsage](#) as TotalDifferentialHeadAtRatedCondition

4.2.2 Class: HeadRange

Definition: A range of Pressure values expressed as the pressure equivalent to that of a given height of a column of a given reference liquid -- usually water or mercury. The values are therefore given as: length range (of) liquid (material) type at temperature, such as “minimum 6 m, maximum 8 m H2O at 4 C.”

SubclassOf: [Quantities:PressureRange](#) .

Properties

ObjectProperty: height **Range:** [Quantities:LengthRange](#)

Definition: The range of equivalent heights of the column of liquid.

Cardinality: exactly 1

ObjectProperty: referenceLiquid **Range: [Materials:MaterialType](#)**

Definition: The reference liquid, usually water or mercury.

Cardinality: exactly 1

ObjectProperty: referenceTemperature **Range: [Quantities:Temperature](#)**

Definition: The reference temperature of the reference liquid.

Cardinality: exactly 1

Other Roles

From: [CentrifugalPump](#) as DifferentialHeadRange

4.2.3 Class: Pump

Stereotypes: [ISO-15926:RDLclass](#)

Definition: A physical object that is a driven piece of equipment in which energy is either constantly or periodically added to an amount of pumped liquid in order to increase the pressure required for the process in which the pump is in operation.

Source: RDL, URI = <http://posccaesar.org/rdl/RDS327239>

SubclassOf: [General:EquipmentCharacterization](#)

Properties

ObjectProperty: connections **Range: [Connection](#)**

Definition: The (conceptual) connections between the Pump and the piping system, which are ultimately implemented by some Port on the casing.

Cardinality: 2 or more, composite

ObjectProperty: inComplex **Range: [PumpComplex](#)**

inverse: [Pump](#) pumps via: [pump-in-complex](#)

Definition: The complex (set of pumps) to which this Pump belongs.

Cardinality: at most 1

ObjectProperty: pumpedFluid **Range: [Materials:Fluid](#)**

Definition: The characteristics of the primary fluid flowing through the Pump.

Cardinality: at least 1

Other Roles

From: [PDSheets:PumpSheet](#) as forPump

4.2.4 Class: CentrifugalPump

Stereotypes: [ISO-15926:RDLclass](#)

Definition: A CentrifugalPump is a Pump whose function it is to raise the pressure of a liquid using kinetic energy.

Source: cfiXML

Definition: A dynamic pump utilizing impellers provided with vanes generating centrifugal force to achieve the required pressure head.

Source: RDL, URI = <http://posccaesar.org/rdl/RDS416834>

SubclassOf: [KineticPump](#)

Properties

ObjectProperty: DifferentialHeadRange **Range:** [HeadRange](#)

Definition: The minimum and maximum algebraic difference in the same units between the discharge and suction head.

Note: Head is conventionally expressed as pressure exerted by a comparable height of a column of liquid, usually water, and thus the values are Length values coupled with the reference liquid, as “meters of water” or “millimeters of mercury.” In practice, only a Length value may be provided, with the assumption that the reference liquid is water.

Source: HI EDE 50.7

Cardinality: exactly 1

ObjectProperty: DifferentialPressureRange **Range:** [Quantities:PressureRange](#)

Definition: The minimum and maximum algebraic difference in the same pressure units between the discharge and suction pressure.

Source: HI EDE 50.7

Cardinality: exactly 1

ObjectProperty: DifferentialPressureRated **Range:** [Quantities:Pressure](#)

Definition: The algebraic difference in the same pressure units between the discharge and suction pressure at rated conditions, as specified by the purchaser.

Source: HI EDE 50.7

Cardinality: exactly 1

ObjectProperty: DirectionOfRotation **Range:** [RotationDirection](#)

Definition: Direction of the rotation of the shaft view from the coupling end of the pump.

Cardinality: exactly 1

ObjectProperty: DischargePressureRange **Range:** [Quantities:PressureRange](#)

Definition: The discharge pressure measured in pressure units associated with the pump operation at a maximum, minimum, and normal capacity conditions.

Source: HI EDE 50.7

Cardinality: exactly 1

ObjectProperty: DischargePressureRated **Range: [Quantities:Pressure](#)**

Definition: The discharge pressure measured in pressure units associated with the pump operation at rated capacity conditions.

Source: HI EDE 50.7

Cardinality: exactly 1

ObjectProperty: DutyCycle **Range: [DutyCycle](#)**

Definition: A statement of whether the pump will be operated continuously (more than 4 hours per run) or will be cycled on/off (less than 4 hours per run) within an operating day. A more detailed description of the duty cycle including number of hours of operation per day can be described in the "Operating Conditions Comments".

Source: HI EDE 50.7

Cardinality: exactly 1

ObjectProperty: EfficiencyAtRatedCondition **Range: [Quantities:Efficiency](#)**

Definition: The pump efficiency at the rated impeller diameter, the rated flow rate, and the rated speed. Efficiency is defined as the ratio of the energy imparted to the liquid by the pump to the energy input to the pump shaft expressed as a percent.

Source: (Hydraulic Institute 2008)

Cardinality: exactly 1

ObjectProperty: FlowrateRange **Range: [Quantities:FlowrateRange](#)**

Definition: The minimum and maximum volumetric quantity of fluid to be delivered per unit of time, including entrained and dissolved gas.

This value should be used to evaluate the driver brake horsepower selection and the NPSH-available vs. NPSH margin. This is important in variable speed operation.

Source: HI EDE 50.7

Cardinality: exactly 1

ObjectProperty: FlowrateRated **Range: [Quantities:Flowrate](#)**

Definition: Volumetric quantity of fluid required to be delivered per unit of time, including entrained and dissolved gas, at rated conditions of speed, differential pressure, specific gravity, viscosity. This is the purchase contract flow rate that is used to select the pump.

Note that the choice of pump classification and fixed vs. variable speed will affect the relevance of a fixed, rated capacity.

Source: HI EDE 50.7

Cardinality: exactly 1

ObjectProperty: MaxDifferentialHeadAtRatedImpellerDiameter **Range: [Head](#)**

Definition: The maximum difference between the discharge head and the suction head at the rated impeller diameter. This is typically the difference between maximum discharge head and minimum suction head.

Note: This value may be given only as the number that is the algebraic difference, the units being the same as those used for the two head values involved.

Source: HI EDE 50.7

Cardinality: exactly 1

ObjectProperty: MinimumContinuousStableFlow **Range: [Quantities:Flowrate](#)**

Definition: Minimum continuous stable flow (MCSF) is the lowest flow rate at which a centrifugal pump may be operated on a continuous basis without exceeding the design constraints, vibration and/or noise limits of the manufacturer or the equipment specifier.

In setting these limits the customer or manufacturer usually refers to a widely accepted industry standards, such as ANSI, API, ISO, ASME, or in some cases to his own pump specifications.

Source: (Centrifugal-Pump.org n.d.)

Cardinality: exactly 1

ObjectProperty: NPSHAvailableAtMaximumFlowrate **Range: [Head](#)**

Definition: The head available after loss of head due to friction in the flow at the maximum flowrate.

Source: (Wikipedia n.d.)

Cardinality: exactly 1

ObjectProperty: NPSHAvailableAtMinimumFlowrate **Range: [Head](#)**

Definition: The head available after loss of head due to friction in the flow at the minimum flowrate.

Source: (Wikipedia n.d.)

Cardinality: exactly 1

ObjectProperty: NPSHAvailableAtNormalFlowrate **Range: [Head](#)**

Definition: The head available after loss of head due to friction in the flow at the normal/expected flowrate.

Cardinality: exactly 1

ObjectProperty: NPSHInletDatum **Range: [OWL:String](#)**

Definition: The inlet datum reference for the NPSHAvailable rating

See references (Hydraulic Institute 2008), (Hydraulic Institute 2008) for description of inlet datums. When the purchaser specifies the rating, this information is required.

Source: HI EDE 50.7

Cardinality: 0..1

DataProperty: NumberOfStages **Type: [OWL:Integer](#)**

Definition: Number of stages on a common pump shaft indicated by a rotating element and its stationary casing. Multiple stages are typically provided to enable the pump to develop full system pressure.

Source: HI EDE 50.7

Cardinality: exactly 1

DataProperty: OperatingConditionsComments Type: [OWL:String](#)

Definition: Specific conditions about the operating condition that the purchaser wants to clarify.

Cardinality: exactly 1

ObjectProperty: OperatingTimeAtMaximumFlowrate Range: [Quantities:Time](#)

Definition: The maximum amount of time the pump can operate at a max flowrate.

Cardinality: exactly 1

ObjectProperty: OperatingTimeAtMinimumFlowrate Range: [Quantities:Time](#)

Definition: The maximum amount of time the pump can operate at a minimum flowrate.

Cardinality: exactly 1

ObjectProperty: OperatingTimeAtNormalFlowrate Range: [Quantities:Time](#)

Definition: Operating time per year at the Rated Capacity.

Source: HI EDE 50.7

Cardinality: exactly 1

ObjectProperty: OperatingTimeAtRatedFlowrate Range: [Quantities:Time](#)

Definition: The maximum amount of time the pump can operate at a rated flowrate.

Cardinality: exactly 1

ObjectProperty: PowerMaximum Range: [Quantities:Power](#)

Definition: The maximum BHP (shaft input power measured at the pump-to-driver coupling) at any flowrate between zero and maximum, at the rated impeller diameter and the rated speed.

Source: HI EDE 50.7

Cardinality: exactly 1

ObjectProperty: PowerRated Range: [Quantities:Power](#)

Definition: The pump BHP (shaft input power measured at the pump-to-driver coupling) required at the rated impeller diameter, the rated flow rate, and the rated speed.

Source: (Hydraulic Institute 2008).

Cardinality: exactly 1

ObjectProperty: pumpCurve Range: [PumpCurve](#)

Definition: A graph of pump performance as a mathematical function of flowrate and pressure. There may be multiple such curves if the Pump has a choice of Impellers or other components.

Cardinality: unconstrained

ObjectProperty: PumpOrientation Range: [Orientation](#)

Definition: A choice of pump orientation which indicates the pump construction configuration.

Source: HI EDE 50.7

Cardinality: exactly 1

ObjectProperty: PumpSpeedRated **Range: [Quantities:AngularVelocity](#)**

Definition: A rotational speed which is the rotational speed of a rotating machine working at its full load.

Source: RDL, URI = <http://posccaesar.org/rdl/RDS13233604>

Cardinality: exactly 1

ObjectProperty: ShutoffHead **Range: [Head](#)**

Definition: The shut-off head is the Total Head that the pump can deliver at zero flow.

Source: (Pump Fundamentals n.d.)

Cardinality: exactly 1

ObjectProperty: SpeedRange **Range: [Quantities:AngularVelocityRange](#)**

Definition: The maximum recommended rotational speed for the pump type and corresponding pump construction. This is applicable only for variable speed operation.

Values are provided by the pump manufacturer.

Source: HI EDE 50.7

Cardinality: exactly 1

ObjectProperty: SuctionPressureRange **Range: [Quantities:PressureRange](#)**

Definition: The suction pressure in absolute pressure units. This represents the suction pressure associated with max, min, and normal capacity conditions.

Source: HI EDE 50.7

Cardinality: exactly 1

ObjectProperty: SuctionPressureRated **Range: [Quantities:Pressure](#)**

Definition: The rated suction pressure in absolute pressure units. This represents the suction pressure associated with rated capacity conditions. It may or may not be the same as the minimum or maximum suction pressure.

Source: HI EDE 50.7

Cardinality: exactly 1

ObjectProperty: SuctionSpecSpeed **Range: [Quantities:AngularVelocity](#)**

Definition: An index of pump suction operating characteristics determined at the Best Efficiency Point (BEP) rate of flow with the maximum diameter impeller and based on NPSH3.

Source: HI EDE 50.7

NPSH3 is the net positive suction head that results in a 3% loss of head (first stage in a multistage pump). Expressed in Metric units.

Source: (Hydraulic Institute 2008)

Cardinality: exactly 1

ObjectProperty: SuctionType **Range: [SuctionType](#)**

Definition: Either single suction or double suction. Single suction if the liquid enters from one side, double suction if it enters from both sides.

Source: Perry's Handbook (Green and Perry 2007)

Cardinality: exactly 1

ObjectProperty: baseplate **Range: [PumpBaseplate](#)**

Definition: characterization of the pump baseplate.

Cardinality: exactly 1, composite

ObjectProperty: casing **Range: [PumpCasing](#)**

Definition: characterization of the pump casing.

Cardinality: exactly 1, composite

ObjectProperty: driver **Range: [Driver](#)**

Definition: characterization of the pump driver.

Cardinality: exactly 1

ObjectProperty: impeller **Range: [Impeller](#)**

Definition: characterization of the pump impeller.

Cardinality: at least 1, composite

ObjectProperty: shaft **Range: [PumpShaft](#)**

Definition: characterization of the pump shaft.

Cardinality: exactly 1, composite

ObjectProperty: shaftSeal **Range: [PumpShaftSeal](#)**

Definition: characterization of the means by which the pump shaft is prevented from leaking at the point it enters the casing.

Cardinality: exactly 1, composite

4.2.5 Class: PumpComplex

Definition: A collection of pumps that perform a common function. This includes staging arrangements, parallel online arrangements, primary and backup arrangements, etc. It may also describe a group of like pumps that are simultaneously acquired.

Properties

ObjectProperty: arrangement **Range: [PumpArrangement](#)**

Definition: The structural arrangement of the pumps in the PumpComplex.

Cardinality: exactly 1

DataProperty: description Type: [OWL:String](#)

Definition: A description of the PumpComplex that conveys its purpose and structure and the roles of the individual pumps or kinds of pumps.

Cardinality: at most 1

DataProperty: numberOfPumps Type: [OWL:Integer](#)

Definition: Total number of pumps in the complex (or the number of Pumps with the given characterization that will be required).

Cardinality: exactly 1

ObjectProperty: pumps Range: [Pump](#)

inverse: [Pump.inComplex](#)

Definition: The (kinds of) Pumps that are the elements of the PumpComplex.

If the Pump characterization is used for design and acquisition, there may be only one characterization that describes all the pumps in the complex. If the Pump characterization describes the operational status of the PumpComplex, there will be one Pump characterization per actual Pump.

Cardinality: at least 1

4.2.6 Class: PumpCurve

Definition: A description of the interrelationship of pump performance parameters (pressure, flowrate, power) as a mathematical function, represented by a graph of the function.

The diagram is provided by the pump manufacturer to explain the relationship between the head and the flow rate of a pump using various size impellers. The curve may also include efficiency, NPSH required, and power consumption as a function of flow.

Source: (PumpScout n.d.)

Properties

DataProperty: curveld Range: [OWL:String](#)

Definition: An identifier for the PumpCurve, to distinguish it from others in a collection of pump specifications. Also called *curve number*.

Cardinality: exactly 1

Other Roles

From: [CentrifugalPump](#) as pumpCurve

4.2.7 Class: PumpUsage

Definition: Characteristics of a Pump when used to pump a specific ProcessFluid.

Note: Since most pumps are acquired and installed for a specific purpose, they may be used for only one process fluid, but some lines and pumps are used for a family of chemical products. Further, in the petroleum industry, the nature of the crude oil stream and its early refinements can be significantly variable.

SubclassOf: none.

Properties

ObjectProperty: pumpedFluid **Range:** [Materials:ProcessFluidStream](#)

Definition: The process fluid to which the PumpUsage characteristics apply.

Cardinality: exactly 1

ObjectProperty: DifferentialHeadRated **Range:** [Head](#)

Definition: The total discharge head less the total suction head measured relative to any common horizontal datum plane. Total head is the static head plus the velocity head plus the vertical distance from the static head measurement instrument to the datum.

This is the purchase contract differential head that is used to select the pump. Rated conditions are specified by the purchaser.

Source: HI EDE 50.7

Cardinality: exactly 1

ObjectProperty: NPSHAvailableRated **Range:** [Head](#)

Definition: The total suction head of liquid absolute, determined at the inlet datum, typically the centerline of the first stage impeller, minus the absolute vapor pressure of the liquid at the rated capacity and temperature.

Source: HI EDE 50.7

Cardinality: exactly 1

ObjectProperty: NPSHRequiredAtRatedCondition **Range:** [Head](#)

Definition: Net Positive Suction Head Required is the minimum net positive suction pressure required for the pump to prevent cavitation. Since impellers produce low pressure zones at various points along the impeller profile, this will normally be far higher than that required to produce boiling in a static condition and is affected by the specific pump and impeller design.

Source: (Evans 2008)

Cardinality: exactly 1

ObjectProperty: NPSH3AtRatedCondition **Range:** [Head](#)

Definition: net positive suction head that will cause the total head (or first-stage head of multistage pumps) to be reduced by 3 percent.

Source: (Hydraulic Institute n.d.)

Cardinality: exactly 1

ObjectProperty: TotalDifferentialHeadAtRatedCondition **Range:** [Head](#)

Definition: The total discharge head minus the total suction head.

Source: (Bhatia n.d.)

Cardinality: exactly 1

Other Roles

From [CentrifugalPump](#) as usage

4.2.8 Enumerated Class: DutyCycle

Definition: A simple classification of the operational usage of a pump.

Named Individual Members

Source: HI EDE 50.7

Member: Continuous

Definition: When the pump is operated for more than 4 hours per run.

Member: Intermittent

Definition: When the pump is cycled on/off or operated for less than 4 hours per run.

Member: Standby

Definition: When the pump is normally idle, and comes into service only when conditions require it.

Other Roles

From: [CentrifugalPump](#) as DutyCycle

4.2.9 Enumerated Class: Orientation

Definition: The pump construction configuration, in terms of the relationship of the axis of rotation to the baseplate, which relates to the gravitational characteristics of flow through the pump.

Source: HI EDE 50.7

Named Individual Members

Member: Horizontal

Definition: The axis of rotation of the pump shaft is (more or less) parallel to the base plate.

Member: Vertical

Definition: The axis of rotation of the pump shaft is (more or less) perpendicular to the base plate.

Member: Inclined

Definition: The axis of rotation of the pump shaft is neither parallel to, nor perpendicular to, the base plate, but rather at some intermediate angle.

Other Roles

From: [CentrifugalPump](#) as PumpOrientation

From: [Driver](#) as DriverOrientation

4.2.10 Enumerated Class: PumpArrangement

Definition: The connection structure of a set of pumps (ordered together) or a pump complex.

Named Individual Members

Member: Series

Definition: Components connected in series are connected along a single flow path.

Member: Parallel

Definition: Components connected in parallel are connected so the same energy is applied to each component.

Member: Standalone

Definition: Not connected to another pump.

Other Roles

From: [PumpComplex](#) as arrangement

4.2.11 Enumerated Class: RotationDirection

Definition: direction of the rotation of the shaft, viewed from the coupling end of the pump.

Named Individual Members

Member: Counterclockwise

Definition: From the coupling end, the shaft rotates right to left.

Member: Clockwise

Definition: From the coupling end, the shaft rotates left to right.

Other Roles

From: [CentrifugalPump](#) as DirectionOfRotation

4.2.12 Enumerated Class: SuctionType

Definition: Either single suction or double suction, depending on whether the liquid enters from both sides or only one.

Named Individual Members

Source: (Green and Perry 2007)

Member: Single_Suction

Definition: If the liquid enters from one side.

Member: Double_Suction

Definition: If liquid enters from both sides.

From: [CentrifugalPump](#) as SuctionType

4.3 Driver and Coupling Specification

This section describes the driver elements in detail, as shown in Figure 14.

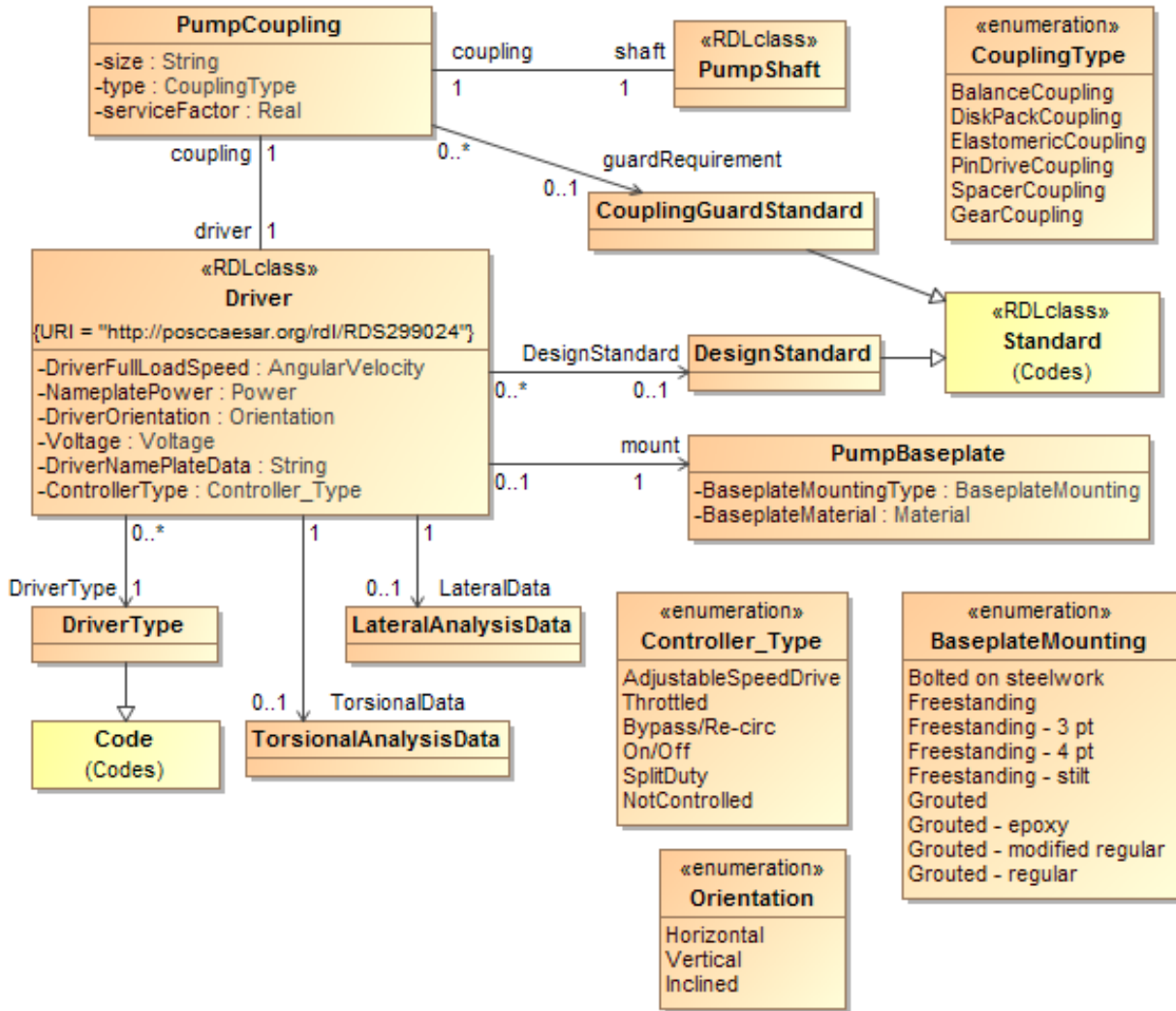

Figure 14 Pump driver and coupling specification

4.3.1 Class: CouplingGuardStandard

Definition: A specification for standard characteristics of the coupling guard.

There are several industry standard specifications, e.g., ASME B15.1, EN 953, ISO 14120, but the specification may also be a manufacturer's proprietary standard.

SubclassOf: [Codes:Standard](#)

Properties

none.

Other Roles

From: [PumpCoupling](#) as guardRequirement

4.3.2 Class: DesignStandard

Definition: A Standard that specifies required structural and operational characteristics of the driver mechanism (for a pump).

Several such standards are commonly in use, e.g., API 610, API 676, ASME B73.1r, ISO 3661, ISO 13709, PIP RESP002.

SubclassOf: [Codes:Standard](#)

Properties

none.

Other Roles

From: [Driver](#) as DesignStandard

4.3.3 Class: Driver

Stereotypes: [ISO-15926:RDLclass](#)

Definition: A physical object that provides rotational or reciprocating energy to driven equipment.

Source: RDL, URI = <http://posccaesar.org/rdl/RDS299024>

Properties

ObjectProperty: DesignStandard **Range:** [DesignStandard](#)

Definition: Applicable published design standard for the driver, with reference to the latest edition unless otherwise noted in the Applicable Driver Standard Comment.

Source: HI EDE 50.7

Cardinality: exactly 1

ObjectProperty: DriverFullLoadSpeed **Range:** [Quantities:AngularVelocity](#)

Definition: The rotational driver speed at full nameplate power loading. The speed can be specified by either the owner or supplier.

Source: HI EDE 50.7

Cardinality: exactly 1

ObjectProperty: DriverOrientation **Range:** [Orientation](#)

Definition: A choice of driver shaft orientation which indicates the driver construction configuration.

Source: HI EDE 50.7

Cardinality: exactly 1

ObjectProperty: DriverType **Range: [DriverType](#)**

Definition: A choice of the driver type as assigned by the owner.

Source: HI EDE 50.7

Cardinality: exactly 1

ObjectProperty: LateralData **Range: [LateralAnalysisData](#)**

Definition: Manufacturer's technical data for lateral analysis of the drive train.

Provided by the driver manufacturer when required.

Source: HI EDE 50.7

Cardinality: at most 1

ObjectProperty: NameplatePower **Range: [Quantities:Power](#)**

Definition: The power rating to appear on the Driver nameplate.

Source: HI EDE 50.7

Cardinality: exactly 1

ObjectProperty: TorsionalData **Range: [TorsionalAnalysisData](#)**

Definition: Manufacturer's technical data for torsional analysis of the drive train

Provided by the driver manufacturer when required.

Source: HI EDE 50.7

Cardinality: at most 1

ObjectProperty: coupling **Range: [PumpCoupling](#)**

inverse: [PumpCoupling](#).driver

Definition: The characteristics of the coupling that links the Driver to the pump shaft.

Cardinality: exactly 1

ObjectProperty: mount **Range: [PumpBaseplate](#)**

Definition: The baseplate structure on which the Driver and the Pump are mounted.

Cardinality: exactly 1

Other Roles

From: [CentrifugalPump](#) as driver

4.3.4 Class: DriverType

Definition: A category of driver, identified by a standard code, or a manufacturer's code.

SubclassOf: [Codes:Code](#)

Properties

none.

Other Roles

From: [Driver](#) as DriverType

4.3.5 Class: LateralAnalysisData

Definition: A collection of detailed technical data for the Driver suitable for performing rotordynamic lateral analysis of the entire Pump drivetrain.

Provided by the driver manufacturer when required.

Source: HI EDE 50.7

SubclassOf: none

Properties

none.

Other Roles

From: [Driver](#) as LateralData

4.3.6 Class: PumpBaseplate

Definition: A Baseplate is an EquipmentItem upon which the driver and the driven equipment items for a RotatingEquipmentItem are mounted. This is a non-wetted part.

Source: cfXML

Properties

ObjectProperty: BaseplateMaterial **Range: [Materials:Material](#)**

Definition: Baseplate material of construction. A recognized material designation (ISO, ASTM, UNS, etc.) is recommended where possible.

Source: HI EDE 50.7

Cardinality: exactly 1

ObjectProperty: BaseplateMountingType **Range: [BaseplateMounting](#)**

Definition: The structure of the baseplate mounting.

Data to be provided by the pump supplier.

Source:(Hydraulic Institute 2008)

Cardinality: exactly 1

Other Roles

From: [CentrifugalPump](#) as baseplate

From: [Driver](#) as mount

4.3.7 Class: PumpCoupling

Definition: The mechanism that connects the pump to the driver and transfers energy from the driver to the pump shaft.

Source: (Ludwig 2001)

Properties

ObjectProperty: guardRequirement **Range: [CouplingGuardStandard](#)**

Definition: The characteristics of the coupling guard, if one is required.

May be specified by either owner or supplier.

Source: HI EDE 50.7

Cardinality: at most 1

DataProperty: serviceFactor **Type: [OWL:Real](#)**

Definition: Coupling manufacturer's service factor, based on selected motor's name plate horsepower.

Source: HI EDE 50.7

Cardinality: exactly 1

ObjectProperty: size **Range: [OWL:String](#)**

Definition: Coupling size, using the coupling manufacturer's nomenclature.

Source: HI EDE 50.7

Cardinality: exactly 1

ObjectProperty: type **Range: [CouplingType](#)**

Definition: The nature of the mechanism for energy transference, taken from a list of standard types.

Cardinality: exactly 1

ObjectProperty: driver **Range: [Driver](#)**

inverse: [Driver](#).coupling

Definition: The characteristics of the Driver that has the motor shaft to which the coupling is attached.

Cardinality: exactly 1

ObjectProperty: shaft **Range: [PumpShaft](#)**

inverse: [PumpShaft](#).coupling

Definition: The characteristics of the PumpShaft to which the coupling is (to be) attached.

Cardinality: exactly 1

4.3.8 Class: TorsionalAnalysisData

Definition: A collection of detailed technical data for the Driver suitable for performing rotordynamic torsional analysis of the entire Pump drivetrain.

Provided by the driver manufacturer when required.

Source: HI EDE 50.7

SubclassOf: none

Properties

none.

Other Roles

From: [Driver](#) as TorsionalData

4.3.9 Enumerated Class: BaseplateMounting

Definition: The structure of the baseplate mounting.

Source:(Hydraulic Institute 2008)

SubclassOf: none

Named Individual Members

Source: HI EDE 50.7

Member: Bolted on steelwork

Definition: The baseplate is physically attached to a structural element of the plant by bolts or other fasteners.

Member: Freestanding

Definition: The baseplate mounting stands directly on the fundament. This designation specifically refers to the case where the baseplate itself makes contact with the fundament.

Member: Freestanding - 3 pt

Definition: The baseplate mounting stands on three legs.

Member: Freestanding - 4 pt

Definition: The baseplate mounting stands on four legs.

Member: Freestanding - stilt

Definition: The baseplate mounting stands on some trestlework.

Member: Grouted

Definition: The baseplate mounting is bound directly to, or into, the fundament by a permanent adhesive.

Member: Grouted - epoxy

Definition: Epoxy grout (meeting ANSI A118.3) is quite different from cementitious grout and epoxy emulsion grout. Made from epoxy resins and a filler powder, the grout is extremely hard, durable, and nearly stain proof.

Source: (Tile Council of North America 2014)

Member: Grouted - modified regular

Definition: Also known as polymer-modified mortar, this is a blend of cement, very finely graded sand, and a water retention compound that allows the cement to properly hydrate.

Source: (Tile Council of North America 2014)

Member: Grouted - regular

Definition: Also known as non-shrink grout, this is a hydraulic [cement grout](#) that produces a big volume that, when hardened under stipulated test conditions, is greater than or equal to the original installed volume; often used as a transfer medium between load-bearing members.

Source: (Wikipedia 2013)

Other Roles

From: [PumpBaseplate](#) as BaseplateMountingType

4.3.10 Enumerated Class: CouplingType

Definition: The nature of the mechanism for energy transference, taken from a list of common types

Named Individual Members

Source: HI EDE 50.7

Member: BalanceCoupling

Definition: Coupling halves connected via stainless steel diaphragms (discs). High speed high torque capability with good dynamic balance. Single coupling will accommodate angular and radial misalignment and fitted in pairs also allows lateral misalignment.

Source: (Beardmore n.d.)

Member: DiskPackCoupling

Definition: Disk pack coupling transmits torque from a driving to a driven bolt tangentially on a common bolt circle. Torque is transmitted between the bolts through a series of thin, stainless steel discs assembled in a pack. Misalignment is accomplished by deforming of the material between the bolts.

Source: (Wikipedia n.d.)

Member: ElastomericCoupling

Definition: A elastomeric flexible element coupling in which elastomeric inserts, often in the form of bushes or wedges, or one single insert, are located between adjacent parts of the driving and driven halves of the coupling and are principally loaded in compression.

Source: RDL

Member: PinDriveCoupling

Definition: A rigid coupling with no recess and spigot and the bolts replaced by pins with rubber bushes. Design allows certain flexibility.

Source: (Beardmore n.d.)

Member: SpacerCoupling

Definition: A cylindrical piece installed between the pump shaft coupling hub and motor shaft coupling hub. It provides enough space to remove the pump mechanical seal when doing maintenance, without moving either the pump body or the driver.

Pump and driver have separate shafts; the pump has an integral bearing housing to absorb all pump thrust loads (axial and radial). With this arrangement the motor may be mounted on a support that is independent of the pump and not structurally connected to the pump frame.

Source: (Wikipedia n.d.), (Hydraulic Institute n.d.)

Member: GearCoupling

Definition: A mechanical device for transmitting torque between two shafts that are not collinear. It consists of a flexible joint fixed to each shaft. The two joints are connected by a third shaft, called the *spindle*.

Source: (Wikipedia n.d.)

A mechanical contact coupling designed to transmit torque and accommodate misalignment and axial displacement by relative rocking and sliding motion between mating internal and external profiled gears.

Source: RDL

Other Roles

From: [PumpCoupling](#) as type

4.4 Shaft and Bearings Specification

This section describes the pump shaft elements in detail, as shown in Figure 15.

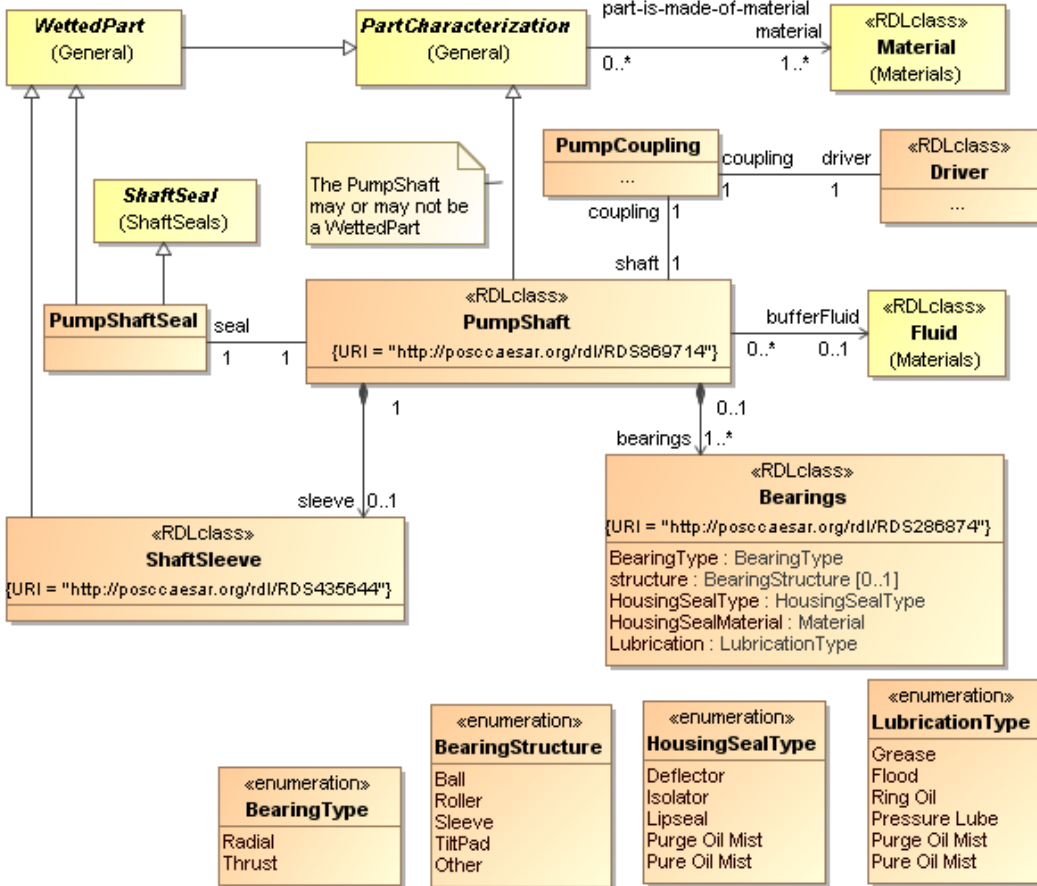

Figure 15 Shaft and Bearings data

4.4.1 Class: Bearings

Stereotypes: [ISO-15926:RDLclass](#)

Definition: A mechanical device that accurately locates a shaft and carries radial and thrust loads.

Note: A proper model of bearings is an elaborate ontology in its own right. This is a simple ontology that calls out a number of Bearing classifications as properties that are represented by a term for the classification in a product data sheet.

Source: (Ludwig 2001), pg. 166

Source: RDL, URI = <http://posccaesar.org/rdl/RDS286874>

Properties

ObjectProperty: BearingType **Range: [BearingType](#)**

Definition: The operating principle on which the bearing(s) supporting axial or thrust loads operate.

This is specified by the manufacturer, but a requirement may be specified the owner, based on preference or operating history.

Source: HI EDE 50.7

Cardinality: exactly 1

ObjectProperty: HousingSealMaterial Range: [Materials:Material](#)

Definition: Bearing housing seal material of construction.

Source: HI EDE 50.7

Cardinality: exactly 1

ObjectProperty: HousingSealType Range: [HousingSealType](#)

Definition: A designation for the type of bearing housing seal.

This is specified by the manufacturer, but the requirement may be specified by the owner/operator, based on preference or operating history.

Source: HI EDE 50.7

Cardinality: exactly 1

ObjectProperty: Lubrication Range: [LubricationType](#)

Definition: A designation of the lubrication system type.

This item can be specified by the owner, but usually by supplier depending on pump design.

Source: HI EDE 50.7

Cardinality: exactly 1

ObjectProperty: structure Range: [BearingStructure](#)

Definition: The physical shape of the structural mechanism that maintains the shaft position and enables free rotation.

This is specified by the manufacturer, and may not be provided.

Source: HI EDE 50.7

Cardinality: at most 1

Other Roles

From: [PumpShaft](#) as bearings

4.4.2 Class: PumpShaft

Stereotypes: [ISO-15926:RDLclass](#)

Definition: An element that transmits power from the driver to the impeller.

Source: RDL, URI = <http://posccaesar.org/rdl/RDS869714>

SubclassOf: [General:PartCharacterization](#)

Note: A PumpShaft may or may not be a WettedPart, depending on whether it has a sleeve, and whether the sleeve insulates the shaft from the process fluid.

Properties

ObjectProperty: bearings **Range: [Bearings](#)**

Definition: specification for the bearings that locate the shaft and allocate radial loads.

Cardinality: at least 1, composite

ObjectProperty: bufferFluid **Range: [Materials:Fluid](#)**

Definition: A Fluid that fills the space between the shaft and the sleeve, and/or between the shaft and a mechanical seal. It serves to lubricate the surfaces in contact, and to prevent flow of the process fluid into the buffer space. Seal barrier or buffer fluids are only required when dual seals are specified.

Source: HI EDE 50.7

Cardinality: at most 1

ObjectProperty: coupling **Range: [PumpCoupling](#)**

inverse: [PumpShaft](#).shaft

Definition: specification for the coupling that links the pump shaft to the driver.

Cardinality: exactly 1

ObjectProperty: seal **Range: [PumpShaftSeal](#)**

inverse: [PumpShaftSeal](#).shaft

Definition: none

Cardinality: exactly 1

ObjectProperty: sleeve **Range: [ShaftSleeve](#)**

Definition: specification for the sleeve, if any, that protects the shaft at the point of contact with the casing and seal.

Cardinality: at most 1, composite

Other Roles

From: [CentrifugalPump](#) as shaft

From: [StuffingBox](#) as shaft

4.4.3 Class: PumpShaftSeal

Definition: A means of throttling the leakage which would otherwise occur at the point of entry of the shaft into the casing.

SubclassOf: [ShaftSeals::ShaftSeal](#), [General::WettedPart](#)

Properties

ObjectProperty: casing **Range: [PumpCasing](#)**

Definition: properties of the pump casing aperture that fits the seal.

Cardinality: exactly 1

Cardinality: exactly 1

ObjectProperty: shaft **Range: [PumpShaft](#)**

inverse: [PumpShaft.seal](#) via: [seal-for-shaft](#)

Definition: characterization of the shaft. The shaft seal seals the aperture between the shaft and the casing.

Cardinality: exactly 1

Other Roles

From: [CentrifugalPump](#) as shaftSeal

4.4.4 Class: ShaftSleeve

Stereotypes: [ISO-15926:RDLclass](#)

Definition: Protects the shaft where it passes through the stuffing box. Usually used in pumps with packing but often eliminated if mechanical seals are employed.

Source: (Ludwig 2001), pg. 166

Source: RDL, URI = <http://posccaesar.org/rdl/RDS435644>

SubclassOf: [General::WettedPart](#)

Properties

none.

Other Roles

From: [PumpShaft](#) as sleeve

4.4.5 Enumerated Class: BearingStructure

Definition: The physical shape of the structural mechanism that maintains the shaft position and enables rotation.

Source: HI EDE 50.7 (as bearing subtype)

Named Individual Members

Member: Ball

Definition: The bearing structure consists of spherical (ball) bearings in a race.

Member: Roller

Definition: The bearing structure consists of cylindrical (roller) bearings between the shaft and the bearing sleeve.

Member: Sleeve

Definition: A sleeve bearing, also called a *plain bearing* or *solid bearing*, is a hollow cylinder (or other bearing surface) within which the rotating shaft slides freely. A shaft sleeve itself may function as a sleeve bearing.

Member: TiltPad

Definition: A tilt pad bearing is a fluid film bearing involving a ring of pads between the bearing sleeve and the rotating shaft that maintains fluid pressure against the rotating shaft. The pads rotate freely on loaded pivots in the sleeve, allowing them to maintain local equilibrium, which improves stability and dissipates heat.

Member: Other

Definition: An unusual bearing structure that is separately described.

Other Roles

From: [Bearings](#) as structure

4.4.6 Enumerated Class: BearingType

Definition: The operating principle on which the bearing(s) supporting the radial loads operate.

This is specified by the manufacturer. Specific requirements may be specified by the owner, based on preference or operating history.

Source: HI EDE 50.7

Named Individual Members**Member: Radial**

Definition: The purpose of a radial bearing is to reduce rotational friction and support loads. This is achieved by using two races to hold the balls and to spread the load through the balls. As the bearing race rotates it causes the balls to rotate. The ball provides for substantially less rolling resistance and coefficient of friction than if two flat surfaces were rotating.

Source: (Boca Bearing 2014)

Member: Thrust

Definition: A thrust bearing is a particular type of rotary rolling-element bearing. Like other bearings they permit rotation between parts, but they are designed to support a predominately axial load.

Source: (Wikipedia 2014)

Other Roles

From: [Bearings](#) as BearingType

4.4.7 Enumerated Class: HousingSealType

Definition: A designation for the type of bearing housing seal.

Source: HI EDE 50.7

Named Individual Members**Member: Deflector**

Definition: A physical object that is a disc mounted on a shaft and intended to deflect oil from coming out of a bearing and to prevent foreign material, like dirt, from entering a bearing.

Source: RDL

Member: Isolator

Definition: Isolator is a barrier for contamination ingress and lubrication retention for bearings installed in pumps, motors, gearboxes, pillow blocks, steam turbines, sleeve-bearing motors, paper machine rolls, and many other types of rotating equipment.

Source: (Inpro-seal 2014)

Member: Lipseal

Definition: A LipSeal uses an elastomeric sealing element, similar to a gland packing. The mechanical element of the construction consists of a sprung main sealing lip which has a point contact with the shaft.

Source: (Wikipedia n.d.)

Member: Purge Oil Mist

Definition: Atomized oil suspended in dry air that is applied to bearing to establish a positive pressure that reduces the entry of solid atmospheric contaminants and water vapor.

Source: (Bloch and Shamim 1998)

Member: Pure Oil Mist

Definition: Oil mist is an aerosol mixture of very small oil droplets (one to five microns) suspended in air with the appearance of smoke. This mist is generated by passing compressed air through a venturi or vortex to siphon oil from a small central reservoir. Pressure of this inlet air is regulated to properly deliver the oil. The initial dry mist generated then flows at 15 to 20 feet/second at distances up to 1,000 feet or more through pipes, tubing and hoses for delivery from headers to rolling elements in pumps, etc., throughout a plant. Mist application varies, depending on delivery fittings.

Source: (Khonsari 2005)

Other Roles

From: [Bearings](#) as HousingSealType

4.4.8 Enumerated Class: LubricationType

Definition: A designation of the lubrication system type. This item can be specified by the owner, but usually by supplier depending on pump design.

Source: HI EDE 50.7

Named Individual Members

Member: Grease

Definition: A compound which is a sticky emulsion made of soap, clay, mineral oil or synthetic substances for the purpose of serving as a lubricant.

Source; RDL

Member: Flood

Definition: A lubrication system where the lubricant (oil) is circulated through the bearing without building up a pressure.

Source: RDL

Member: Ring Oil

Definition: A ring oil lubricator is a lubricator facility where the lubricating function is achieved by a loose metal ring, rotating with the shaft inside the bearing housing, dipping into oil and lifting oil from the reservoir up to the area requiring lubrication.

Source: RDL

Member: Pressure Lube

Definition: An oil lubricated gear coupling which is intended to be lubricated by a periodically changed charge of oil.

Source: RDL

Member: (Pure) Oil Mist

Definition: Oils are applied to rolling element (antifriction) bearings as an oil mist.

Oil mist is an atomized amount of oil carried or suspended in a volume of pressurized dry air. The oil mist, actually a ratio of one volume of oil suspended or carried in 200,000 volumes of clean, dry air, moves in a piping system (header). The point of origin is usually a mixing valve (the oil mist generator), connected to this header. Branch lines often feed oil mist to hundreds of rolling elements in the many pumps and drivers connected to a plant-wide system.

Source: (Khonsari 2005)

Member: Purge Oil Mist

Definition: Oil mist applied to bearings to establish a positive pressure that reduces the entry of solid atmospheric contaminants and water vapor. The oil mist serves as both a lubrication and a seal.

Source: (Bloch and Shamim 1998)

Other Roles

From: [Bearings](#) as Lubrication

4.5 Casing and Impeller Specification

This section describes the pump casing and impeller elements in detail, as shown in Figure 16.

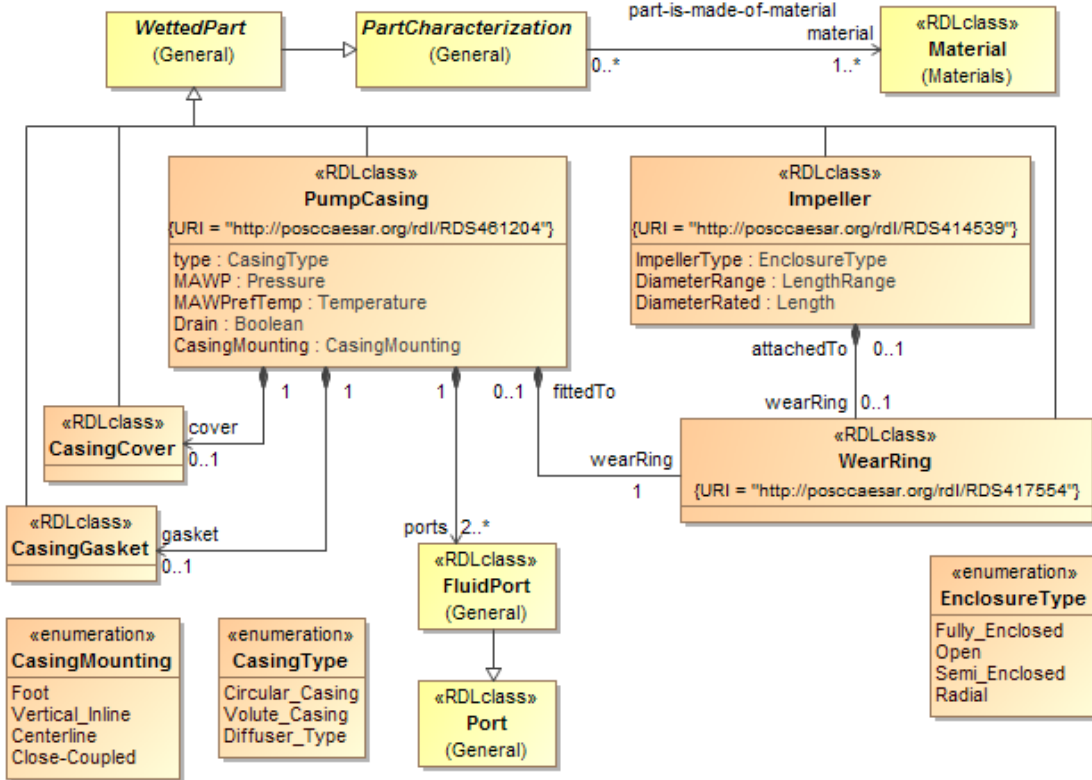

Figure 16 Pump casing and impeller specification

4.5.1 Class: CasingCover

Definition: A cover that is a closure part of a casing.

Source: RDL

SubclassOf: [General::WettedPart](#)

Properties

none.

Other Roles

From: [PumpCasing](#) as cover

4.5.2 Class: CasingGasket

Definition: A gasket that is intended to seal parts of a casing where they are connected.

Source: RDL

SubclassOf: [General::WettedPart](#)

Properties

none.

Other Roles

From: [PumpCasing](#) as gasket

4.5.3 Class: Impeller

Stereotypes: [ISO-15926:RDLclass](#)

Definition: The device that imparts velocity to the liquid, resulting from centrifugal force as the impeller is rotated.

Source: (Ludwig 2001)

An Impeller is a BulkItem and is the mechanical component that imparts kinetic energy to the fluid in a RotatingEquipmentItem.

Source: cfiXML

Source: RDL, URI = <http://posccaesar.org/rdl/RDS414539>

SubclassOf: [General::WettedPart](#)

Properties

ObjectProperty: DiameterRange **Range:** [Quantities:LengthRange](#)

Definition: The range of impeller diameters that can be installed in the selected pump.

Source: HI EDE 50.7

Cardinality: exactly 1

ObjectProperty: DiameterRated **Range:** [Quantities:Length](#)

Definition: The manufacturer's recommended impeller diameter for the selected pump to produce the rated head.

Source: HI EDE 50.7

Cardinality: exactly 1

ObjectProperty: ImpellerType **Range:** [EnclosureType](#)

Definition: Classification of the impeller according to the physical structure that guides the fluid.

Source: industry data sheets

Cardinality: exactly 1

ObjectProperty: wearRing **Range:** [WearRing](#)

inverse: [WearRing](#).attachedTo

Definition: The WearRing that is physically bound to the impeller, if any.

Cardinality: at most 1, composite

Other Roles

From: [CentrifugalPump](#) as impeller

4.5.4 Class: PumpCasing

Stereotypes: [ISO-15926:RDLclass](#)

Definition: Gives direction to the flow from the impeller and converts the velocity energy into pressure energy which is usually measured in feet of head.

Source: (Ludwig 2001), pg. 166

A Casing is a component part of a RotatingEquipmentItem that contains the driven equipment rotating element, e.g., impeller and the process fluid which is being raised in pressure.

Source: cfiXML

Source: RDL, URI = <http://posccaesar.org/rdl/RDS461204>

SubclassOf: [General::WettedPart](#)

Properties

ObjectProperty: CasingMounting Range: [CasingMounting](#)

Definition: The way the pump is designed to be mounted on a fundament.

Source: industry data sheets

Cardinality: exactly 1

DataProperty: Drain Type: [OWL:Boolean](#)

Definition: Provison for controlled removal of pumped fluids from pressurized areas of the pump unit.

Cardinality: exactly 1

ObjectProperty: MAWP Range: [Quantities:Pressure](#)

Definition: Maximum continuous pressure for which the manufacturer has designed the equipment (or any part to which the term is referred) when the equipment is operating under the most adverse operating conditions.

Data is provided by the pump supplier.

Source: (Hydraulic Institute 2008)

Cardinality: exactly 1

ObjectProperty: MAWPrefTemp Range: [Quantities:Temperature](#)

Definition: The reference temperature at which the maximum allowable working pressure for the casing is determined.

Data is provided by the pump supplier.

Source: HI EDE 50.1

Cardinality: exactly 1

ObjectProperty: type **Range: [CasingType](#)**

Definition: The general structural shape of the pump casing.

Cardinality: exactly 1

ObjectProperty: cover **Range: [CasingCover](#)**

Definition: The characteristics of the casing cover, if any.

Cardinality: at most 1, composite

ObjectProperty: gasket **Range: [CasingGasket](#)**

Definition: The gasket between the casing and the impeller.

Cardinality: at most 1, composite

ObjectProperty: ports **Range: [Port](#)**

Definition: characterizations of the Ports for the pump. Almost all physical ports are part of the casing.

Multiplicity: 2..*, composite

ObjectProperty: wearRing **Range: [WearRing](#)**

inverse: [WearRing](#).fittedTo

Definition: The WearRing that is physically bound to, or embedded in, the casing.

Cardinality: exactly 1, composite

Other Roles

From: [CentrifugalPump](#) as casing

From: [StuffingBox](#) as casing

From: [MechanicalSeal](#) as casing

4.5.5 Class: WearRing

Stereotypes: [ISO-15926:RDLclass](#)

Definition: An insulating ring between the impeller end and the casing that keeps internal recirculation down to a minimum. Having these rings as replaceable wearing surfaces permits renewal of clearances to keep pump efficiencies high. On small pump types only one ring is used in the casing; on larger sizes, companion rings are used in the casing and on the impeller.

Source: (Ludwig 2001)

Source: RDL, URI = <http://posccaesar.org/rdl/RDS417554>

SubclassOf: [General::WettedPart](#)

Properties

ObjectProperty: attachedTo **Range: [Impeller](#)**

inverse: [WearRing](#) wear_ring via: [impeller-wear-ring](#)

Definition: The impeller to which the wear ring is physically bound, if any.

Cardinality: at most 1

ObjectProperty: fittedTo **Range: [PumpCasing](#)**

inverse: [WearRing](#) wear_ring via: [casing-wear-ring](#)

Definition: The casing for a wear ring that is physically bound to the casing. If the wear ring is bound to the impeller, this relationship is void.

Cardinality: at most 1

4.5.6 Enumerated Class: CasingMounting

Definition: Classes of pump casings classified after the way a pump casing is designed with regards to how it shall be mounted on to a fundament.

Source: industry data sheet.

Named Individual Members

Member: Foot

Definition: Most ANSI pumps are designed with foot mounted casings. The mounting foot is cast into the casing, and bolts directly to the baseplate.

Source: (EnviroPump and Seal Inc. 2012)

Member: Vertical_Inline

Definition: The pump unit is designed to be installed in the pipeline.

Source: (Patterson Pump Company 1999)

Member: Centerline

Definition: Centerline support simply means that the pump casing is supported at the shaft centerline. This allows thermal expansion growth of the casing to be symmetric from the shaft centerline outwards. Coupling alignment is maintained regardless of the temperature variations.

Source: (EnviroPump and Seal Inc. 2012)

Member: Close-Coupled

Definition: A close-coupled pump has only one shaft and one set of bearings: the motor shaft and bearings. The pump impeller is placed directly onto the motor shaft. Close-coupled pumps require less space and are less expensive than frame-mounted pumps.

Source: (Alaska Government n.d.)

Other Roles

From: [PumpCasing](#) as CasingMounting

4.5.7 Enumerated Class: CasingType

Definition: The general structural shape of a pump casing.

Source: (Green and Perry 2007)

Named Individual Members

Member: Circular_Casing

Definition: Consisting of an annular chamber around the impeller; no attempt is made to overcome the losses that will arise from eddies and shock when the liquid leaving the impeller at relatively high velocities enters this chamber. Such casings are seldom used.

Source: (Green and Perry 2007)

Member: Volute_Casing

Definition: Take the form of a spiral increasing uniformly in cross-sectional area as the outlet is approached. The volute efficiently converts the velocity energy imparted to the liquid by the impeller into pressure energy.

Member: Diffuser_Type

Definition: In this type, guide vanes or diffusers are interposed between the impeller discharge and the casing chamber. Losses are kept to a minimum in a well-designed pump of this type, and improved efficiency is obtained over a wider range of capacities. This construction is often used in multistage high-head pumps.

Source: (Green and Perry 2007)

Other Roles

From: [PumpCasing](#) as type

4.5.8 Enumerated Class: EnclosureType

Definition: A classification of impellers by the physical structure that guides the fluid.

Source: (Ludwig 2001)

Named Individual Members

Member: Fully_Enclosed

Definition: The pumped fluid is captured entirely within the impeller structure from inlet to outlet.

Used for high head, high pressure applications

Member: Open

Definition: The impeller provides only the vanes and depends on the shaft to contain the fluid.

Used for low heads, suspended solids applications, very small flows.

Member: Semi_Enclosed

Definition: The main body of the impeller is enclosed, but it has open vane tips at entrance to break up suspended particles and prevent clogging.

Used for general purpose applications.

Member: Radial

Definition: An open impeller design that does not require close running clearances.

The radial design eliminates the necessity for oversizing to compensate for performance deterioration common to conventional pumps.

Other Roles

From: [Impeller](#) as ImpellerType

5 Ontology: Valves

This section provides a basic ontology for valves. It models the properties of valves that are commonly captured on product data sheets.

Note: In keeping with common engineering practice, this ontology uses the terms for the physical objects (Valve and its subclasses and components), but they refer to characterizations of those objects that are developed at some point in the lifecycle. The terms do not really refer to the physical objects themselves.

Imported Ontologies

This ontology extends the [General Product Data Sheet](#) model above. It uses the [Codes](#), [Materials](#), [Quantities](#), and [Shaft Seals](#) ontologies defined below, and is annotated using the [ISO-15926](#) annotations (stereotypes).

5.1 Valve Structure

This section describes the structural elements that are common to all valves. The concepts are depicted in Figure 17 and described below.

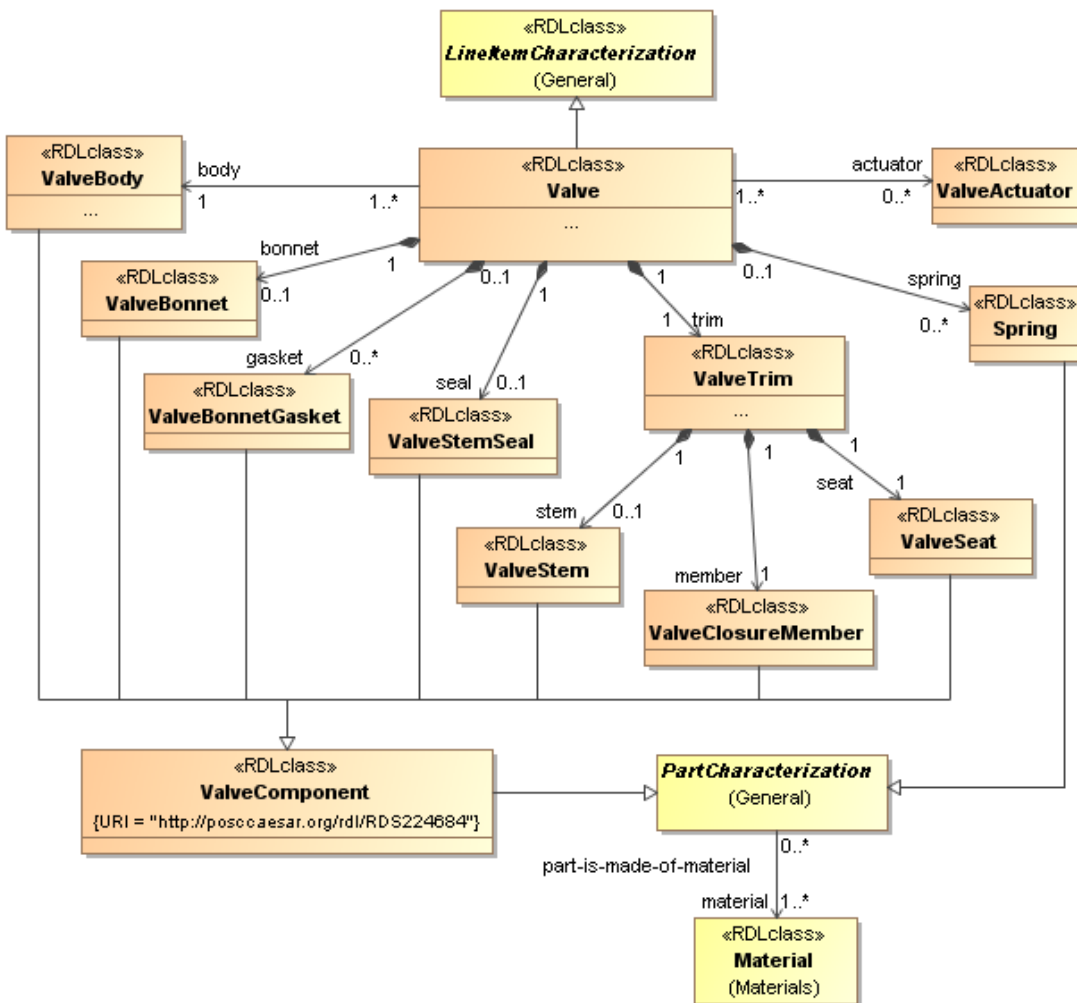

Figure 17 Valve structure

Figure 18 shows the data elements associated with Valves and ValveBodies. Valve Trim components, Seals, and Actuators are discussed in more detail in subsequent sections.

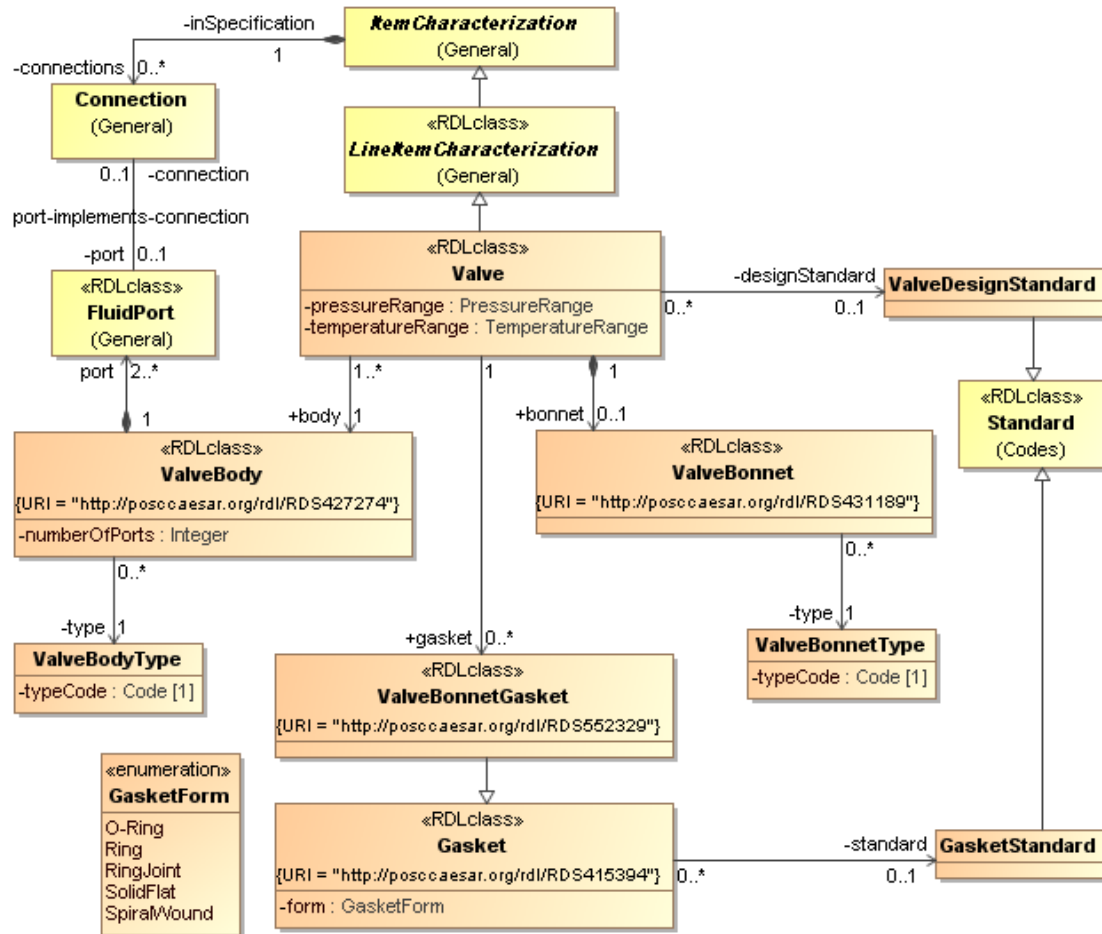

Figure 18 Valve and Valve Body data

5.1.1 Class: Gasket

Definition: A seal that is one or more closed loops of deformable material used between mating surfaces which have only very limited movement relative to each other. a part that prevents leakage at a valve joint, between the bonnet and the body, or between the body ports and the piping The sealing material is deformable in order to effect the sealing between irregularities of the mating surfaces.

Properties

ObjectProperty: form **Range: [GasketForm](#)**

Definition: The general physical form of the Gasket.

Cardinality: exactly 1

ObjectProperty: standard **Range: [GasketStandard](#)**

Definition: The standard to which the Gasket conforms.

Cardinality: at most 1

Other Roles

none.

5.1.2 Class: GasketForm

A general physical structure of a Gasket.

Named Individual Members

Member: O-Ring

Definition: A circular gasket that is a torus, having a rounded cross-section.

Member: Ring

Definition: A circular gasket that has flat (or nearly flat) joining surfaces.

Member: RingJoint

Definition: Ring-joint gaskets are manufactured from a metallic material. The demands on the geometrical accuracy and the surface quality are therefore high. This concerns both the gasket and the sealing section of the flange.

Source: (Kempchen n.d.)

Member: SolidFlat

Definition: A solid, possibly compressible material in sheet form, having a cutout to match the connection opening, and typically more than enough total size to accommodate the flange.

Member: SpiralWound

Definition: A gasket formed by winding a cord-like material around a core, possibly in multiple layers, and compressing the result into a generally toroid shape.

Roles

From: [Gasket](#) as form

5.1.3 Class: GasketStandard

Definition: A standard that specifies the structure and properties of a Gasket.

The following standards are commonly referenced:

- API 600
- API 602
- ASME B16.20

SubclassOf: [Codes::Standard](#)

Properties

none.

Other Roles

From: [Gasket](#) as standard

5.1.4 Class: Valve

Definition: A mechanical device for permitting or interrupting fluid flow, or for altering the volume, rate, pressure, or direction of fluid flow.

SubclassOf: [General::LineItemCharacterization](#)

Properties

ObjectProperty: pressureRange **Range: [Quantities::PressureRange](#)**

Definition: The range of fluid pressure in which the valve is designed to function.

Cardinality: exactly 1

ObjectProperty: temperatureRange **Range: [Quantities::TemperatureRange](#)**

Definition: The range of temperatures in which the valve is designed/required function.

Cardinality: exactly 1

ObjectProperty: actuator **Range: [ValveActuator](#)**

Definition: The mechanism for changing the position of the valve.

Cardinality: unconstrained

ObjectProperty: body **Range: [ValveBody](#)**

Definition: The body of the valve, the vessel that holds the parts that constrict the flow. In some cases a single valve body can incorporate multiple distinct valves.

Cardinality: exactly 1

ObjectProperty: bonnet **Range: [ValveBonnet](#)**

Definition: The part of the valve body that supports the stem and the stem seal.

Cardinality: at most 1, composite

ObjectProperty: designStandard **Range: [ValveDesignStandard](#)**

Definition: reference standard for the overall design and characteristics of the Valve.

Cardinality: at most 1

ObjectProperty: gasket **Range: [ValveBonnetGasket](#)**

Definition: The gaskets that prevent leakage at the valve joints.

Cardinality: unconstrained

ObjectProperty: seal **Range: [StemSeal](#)**

Definition: The seal between the stem and the body.

Cardinality: at most 1, composite

ObjectProperty: spring **Range: [Spring](#)**

Definition: springs used to maintain or restore the position of the valve closure member, as an element of the actuation mechanism.

Cardinality: unconstrained

ObjectProperty: trim **Range: [ValveTrim](#)**

Definition: The internal structure of the Valve.

Cardinality: exactly 1

Other Roles

none.

5.1.5 Class: ValveBody

Definition: A 'pressure vessel' that is the main fluid or pressure containing component of a valve, housing and supporting the working components.

Source: RDL

SubclassOf: [ValveComponent](#)

Properties

DataProperty: numberOfPorts **Type: [OWL:Integer](#)**

Definition: The number of ports on the valve body, at least two.

Cardinality: exactly 1

ObjectProperty: port **Range: [General::FluidPort](#)**

Definition: The physical connections between the valve body and the piping.

A valve always has at least one inlet port and one outlet port. It may have more than one of either.

Cardinality: at least 2, composite

ObjectProperty: type **Range: [ValveBodyType](#)**

Definition: The standard valve body specification to which the ValveBody conforms.

Cardinality: exactly 1

Other Roles

From: [Valve](#) as body

5.1.6 Class: ValveBodyType

Definition: A standard classification of valve bodies.

Properties

ObjectProperty: typeCode **Range:** [Codes::Code](#)

Definition: A code value, taken from a reference standard, for the ValveBodyType.

Cardinality: exactly 1

Other Roles

From: [ValveBody](#) as type

5.1.7 Class: ValveBonnet

Definition: A fluid- or pressure-containing part of a valve body, that supports the stem and its sealing arrangement, and that may accommodate the valve closure member when in the open position.

Source: RDL

SubclassOf: [ValveComponent](#)

Properties

ObjectProperty: type **Range:** [ValveBonnetType](#)

Definition: The standard valve bonnet specification to which the ValveBonnet conforms.

Cardinality: exactly 1

Other Roles

From: [Valve](#) as bonnet

5.1.8 Class: ValveBonnetGasket

Definition: A gasket that is used to seal between a valve body and a valve bonnet.

Source: RDL

SubclassOf: [Gasket](#), [ValveComponent](#)

Properties

none.

Other Roles

From: [Valve](#) as gasket

5.1.9 Class: ValveBonnetType

Definition: A standard classification of valve bonnets.

Properties

ObjectProperty: typeCode **Range:** [Codes::Code](#)

Definition: A code value, taken from a reference standard, for the ValveBonnetType.

Cardinality: exactly 1

Other Roles

From: [ValveBonnet](#) as type

5.1.10 Class: ValveComponent

Definition: (the description of) a physical component of a Valve. This is a specialization of PartCharacterization for Valve-specific components.

SubclassOf: [General::PartCharacterization](#)

Properties

none.

Other Roles

none.

5.1.11 Class: ValveDesignStandard

Definition: A reference standard for structural and behavioral characteristics of a Valve.

SubclassOf: [Codes::Standard](#)

Properties

none.

Other Roles

From: [Valve](#) as designStandard

5.2 Valve Trim

The Valve Trim is the set of valve components that constitute the primary mechanism of the valve – the components of the Valve that jointly constrain, alter or interrupt flow. The basic component types – the closure member, the seat, and (usually) the stem – are present in every valve, but their structure varies widely with the function and mechanism of the valve. Sections 5.4 and 5.5 document the general categories of function and mechanism. This section identifies the common properties that are identified on product data sheets.

Figure 19 shows the principal valve trim components and their properties. These are described below. Note also that all of these are ValveComponents and may have the additional properties common to all valve components.

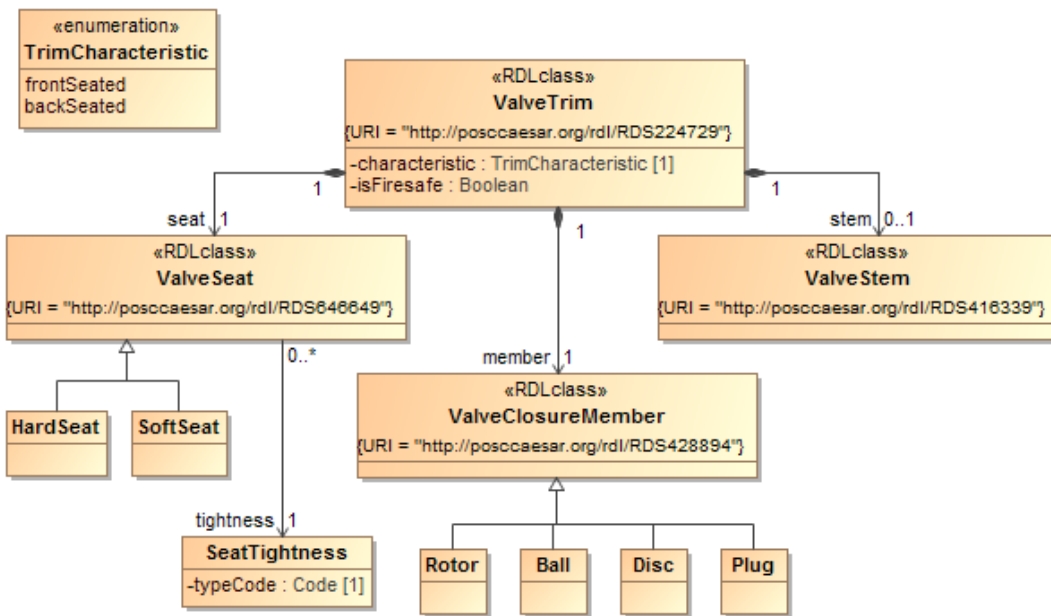

Figure 19 Valve Trim Components

5.2.1 Class: Ball

Definition: A valve closure member that is typically spherical or doubly convex and moves within a cylindrical or similarly shaped valve body to attenuate flow or prevent backflow. In most cases, the position of the ball member is controlled by hydraulic or pneumatic pressure on the face of the ball that is opposite the flow.

SubclassOf: [ValveClosureMember](#)

Properties

none.

Other Roles

none.

5.2.2 Class: Disc

Definition: The general term for valve closure members that are used to attenuate flow. These may be flat, convex or concave discs or cones.

SubclassOf: [ValveClosureMember](#)

Properties

none.

Other Roles

none.

5.2.3 Class: HardSeat

Definition: A seat that is an integral part of the valve body.

SubclassOf: [ValveSeat](#)

Properties

none.

Other Roles

none.

5.2.4 Class: Plug

Definition: A general term for a valve closure member intended primarily for interrupting flow by forming a barrier when fitted into the seat.

SubclassOf: [ValveClosureMember](#)

Properties

none.

Other Roles

none.

5.2.5 Class: Rotor

Definition: A valve member that is rotated in interrupting, routing or constraining flow. A member is not considered a rotor if its rotation is a secondary action, such as preventing backflow or controlling pressure rather than flow.

SubclassOf: [ValveClosureMember](#)

Properties

none.

Other Roles

none.

5.2.6 Class: SeatTightness

Definition: A specification for the tightness of fit between the Valve closure member and the seat, taken from one of several standards for different types of valves.

Properties

ObjectProperty: typeCode **Range: [Codes::Code](#)**

Definition: A code value, taken from a reference standard, for the Seat Tightness.

Cardinality: exactly 1

Other Roles

From: [ValveSeat](#) as tightness

5.2.7 Class: SoftSeat

Definition: A seat that is separate from the valve body proper, usually made of a different material and somehow fitted into the body cavity.

SubclassOf: [ValveSeat](#)

Properties

none.

Other Roles

none.

5.2.8 Class: TrimCharacteristic

Definition: The general structure of the Trim, characterized by the relative position of the Seat and Closure Member as the Stem enters the valve body or bonnet.

Named Individual Members

Member: frontSeated

Definition: Also called *normal seat*. A valve is front seated or normal seat when the member is between the stem and the seat.

Member: backSeated

Definition: Also called *reverse seat*. A valve is reverse seat or back seated when the stem goes through the seat to the member.

Member: stemless

Definition: A stemless valve has no Valve Stem per se. The closure member is activated directly by the actuator or the fluid, usually by hydraulic or pneumatic pressure.

Other Roles

From: [ValveTrim](#) as characteristic

5.2.9 Class: ValveClosureMember

Definition: Often called *valve member*. The moving element that physically interrupts, alters, or constrains the fluid flow through the valve. There are many different kinds of valve closure members. The ones described here are general terms for families of valve member designs.

Source: RDL

SubclassOf: [ValveComponent](#)

Properties

none.

Other Roles

From: [ValveTrim](#) as member

5.2.10 Class: ValveSeat

Definition: The fixed element that participates in interrupting or constraining flow.

Source: RDL

SubclassOf: [ValveComponent](#)

Properties

ObjectProperty: **tightness** Range: [SeatTightness](#)

Definition: The (standard) seat tightness requirement specification to which the ValveSeat conforms.

Cardinality: exactly 1

Other Roles

From: [ValveTrim](#) as seat

5.2.11 Class: ValveStem

Definition: Valve component that transmits motion from the actuator to the valve closure member. The stem and the valve member may be one piece. In some cases the stem and the actuator are one piece.

SubclassOf: [ValveComponent](#)

Properties

none.

Other Roles

From: [ValveTrim](#) as stem

5.2.12 Class: ValveStemSeal

Definition: The stem seal is the mechanism used to prevent leakage of the process fluid at the point where the valve stem enters the valve chamber through the bonnet or the body. Stem seals can be simple or complex, depending largely on the viscosity of the process fluid, the pressure exerted on it, and the amount and direction of movement of the stem that occurs in normal operation.

The possible data specifications for a Stem Seal are specified in the General ProductDataSheet Ontology under Shaft Seal Specification (see Section **Error! Reference source not found.**). Figure 20 shows the relationship of Stem Seals to the Valve.

Source: RDL, URI = <http://posccaesar.org/rdl/RDS720359>

SubclassOf: [ShaftSeals::ShaftSeal](#), [ValveComponent](#)

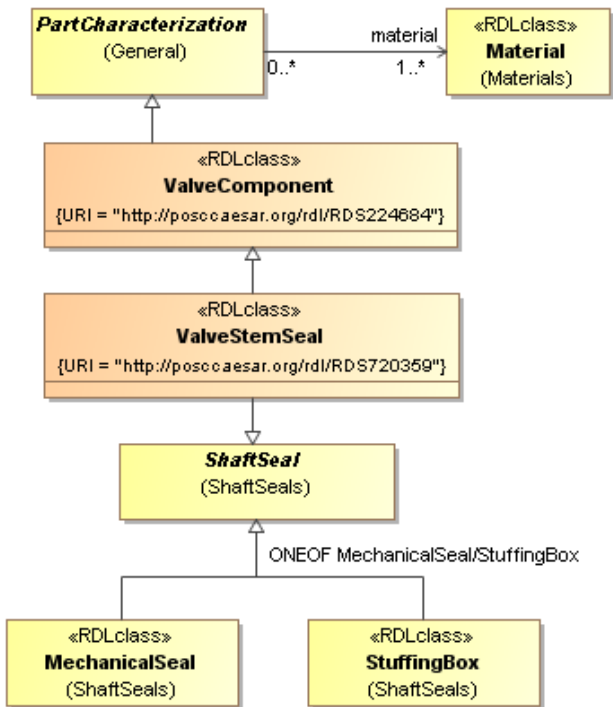

Figure 20 Stem Seals

Properties

none

Other Roles

From: [Valve](#) as seal

5.2.13 Class: ValveTrim

Definition: The components of the Valve that jointly constrain, alter or interrupt flow.

Properties

ObjectProperty: characteristic **Range:** [TrimCharacteristic](#)

Definition: The basic structure of the ValveTrim: does the stem go through the seat (back-seated), or not (front-seated).

Cardinality: exactly 1

DataProperty: isFiresafe **Type:** [OWL:Boolean](#)

Definition: True if the value will continue to function properly unless the surrounding temperatures exceed a reference value (commonly 2000K) for industrial fire temperatures; false if the valve can fail at a lower temperature.

Cardinality: exactly 1

ObjectProperty: member **Range:** [ValveClosureMember](#)

Definition: The specification for the valve (closure) member – the moving element that physically interrupts, alters, or constrains fluid flow through the valve.

Cardinality: exactly 1, composite

ObjectProperty: seat **Range:** [ValveSeat](#)

Definition: The specification for the ValveSeat element of the trim.

Cardinality: exactly 1, composite

ObjectProperty: stem **Range:** [ValveStem](#)

Definition: The specification for the Stem element of the trim, if any.

Cardinality: at most 1, composite

Other Roles

From: [Valve](#) as trim

5.3 Valve Actuators

This section provides a simple overview of valve actuation mechanisms, and a common taxonomy for valves that is based on the actuation mechanism. The actuation mechanisms are almost totally independent of the function and mechanism of the valve. The choice of actuation mechanism is determined partly by the size of the valve mechanism and the operating pressure of the fluid stream, partly by the required accuracy for control, and partly by the nature of the associated control system.

The concepts are depicted in Figure 21 and described below.

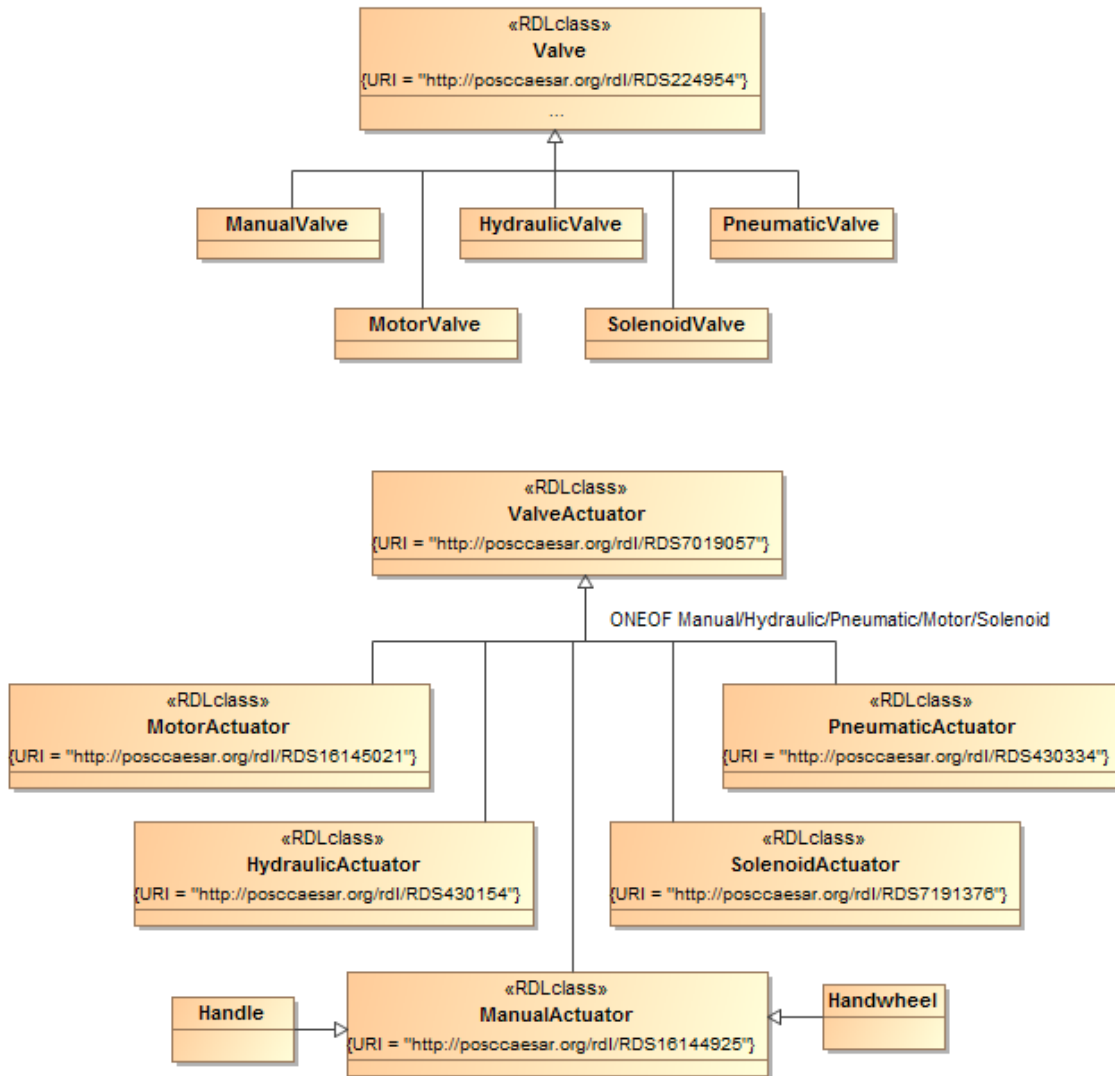

Figure 21 Valve Actuators

5.3.1 Class: HydraulicActuator

Definition: An actuator intended to be operated by hydraulic power.

SubclassOf: [ValveActuator](#)

Properties

none.

Other Roles

none.

5.3.2 Class: HydraulicValve

Definition: A valve that has a hydraulic actuator.

SubclassOf: [Valve](#)

Properties

none.

Other Roles

none.

5.3.3 Class: ManualActuator

Definition: An actuator whose action has to be triggered manually, and usually requires human energy to be applied (with mechanical advantage) to change the position of the valve. In other cases, the manual actuator unlocks a separate mechanism that may use gravity or fluid pressure to change the valve position.

SubclassOf: [ValveActuator](#)

Properties

none.

Other Roles

none.

5.3.4 Class: ManualValve

Definition: A valve that has a manual actuator

SubclassOf: [Valve](#)

Properties

none.

Other Roles

none.

5.3.5 Class: Handwheel

Definition: A manual actuator whose mechanism is primarily a screw.

SubclassOf: [ManualActuator](#)

Properties

none.

Other Roles

none.

5.3.6 Class: Handle

Definition: A manual actuator whose mechanism is primarily a lever.

SubclassOf: [ManualActuator](#)

Properties

none.

Other Roles

none.

5.3.7 Class: MotorActuator

Definition: An actuator powered by a motor.

SubclassOf: [ValveActuator](#)

Properties

none.

Other Roles

none.

5.3.8 Class: MotorValve

Definition: A valve that has a motor actuator.

SubclassOf: [Valve](#)

Properties

none.

Other Roles

none.

5.3.9 Class: PneumaticValve

Definition: A valve that has a pneumatic actuator.

SubclassOf: [Valve](#)

Properties

none.

Other Roles

none.

5.3.10 Class: PneumaticActuator

Definition: An actuator that is intended to be operated by pneumatic power.

SubclassOf: [ValveActuator](#)

Properties

none.

Other Roles

none.

5.3.11 Class: SolenoidActuator

Definition: An electric actuator that uses a continuous duty linear solenoid to convert electrical energy into mechanical power via a plunger with an axial stroke in either a push or pull action.

SubclassOf: [ValveActuator](#)

Properties

none.

Other Roles

none.

5.3.12 Class: SolenoidValve

Definition: A valve that has a solenoid actuator

SubclassOf: [Valve](#)

Properties

none.

Other Roles

none.

5.3.13 Class: Spring

Definition: An 'artefact' that is intended to transmit load and that is not damaged by large deformation.

Source: RDL

SubclassOf: [General::PartCharacterization](#)

Properties

none.

Other Roles

From: [Valve](#) as spring

5.3.14 Class: ValveActuator

Definition: An actuator intended to change and/or maintain the position of the closing member of a valve.

Properties

none.

Other Roles

From: [Valve](#) as actuator

5.4 Taxonomy by Function

This section provides a taxonomy for valves that are classified according to their function. The concepts are depicted in Figure 22 and described below.

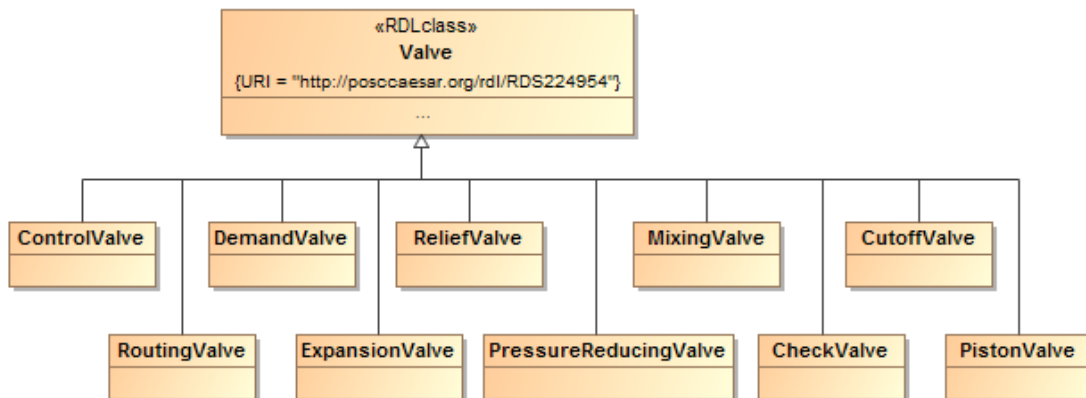

Figure 22 Valves classified by function

5.4.1 Class: CheckValve

Definition: Also called *non-return valve*. A check valve guarantees flow in only one direction, by closing under back pressure from the outlet side when the inlet pressure is not sufficient to maintain flow.

SubclassOf: [Valve](#)

Properties

none.

Other Roles

none.

5.4.2 Class: ControlValve

Definition: *Control valve* is a common term for several kinds of valves. The usual interpretation is a valve that manages flow by varying the size of the chamber, thus increasing or attenuating the flow.

SubclassOf: [Valve](#)

Properties

none.

Other Roles

none.

5.4.3 Class: CutoffValve

Definition: Also a "shutoff" valve. A valve whose function is to interrupt flow entirely, and usually quickly.

SubclassOf: [Valve](#)

Properties

none.

Other Roles

none.

5.4.4 Class: DemandValve

Definition: A valve whose primary purpose is to control input to a process, by opening to allow fluid flow when the pressure on the process side is low, and closing otherwise.

SubclassOf: [Valve](#)

Properties

none.

Other Roles

none.

5.4.5 Class: ExpansionValve

Definition: Thermal expansion valve, used in air conditioning and refrigeration.

SubclassOf: [Valve](#)

Properties

none.

Other Roles

none.

5.4.6 Class: MixingValve

Definition: A valve with multiple inlet ports and (usually) a single outlet port, the purpose being to allow multiple incoming flows to mix in the valve chamber.

SubclassOf: [Valve](#)

Properties

none.

Other Roles

none.

5.4.7 Class: PistonValve

Definition: The function of a PistonValve is to use fluid pressure to produce linear displacement of the valve member, which can then be converted to mechanical energy. The far end of piston displacement creates a relieving flow, and some other energy source is used to return the valve member to a throttling position.

SubclassOf: [Valve](#)

Properties

none.

Other Roles

none.

5.4.8 Class: PressureReducingValve

Definition: A PressureReducing valve has an adjustable chamber or outlet aperture that increases as fluid pressure at the inlet aperture rises, and decreases as pressure at the inlet aperture falls, so as to maintain a constant lower pressure on the outlet side. A pressure reduction valve thus typically has a variable flow rate.

SubclassOf: [Valve](#)

Properties

none.

Other Roles

none.

5.4.9 Class: ReliefValve

Definition: A valve whose primary purpose is to control output from a process, by opening to allow fluid flow when the pressure on the process side exceeds some threshold, and closing otherwise.

SubclassOf: [Valve](#)

Properties

none.

Other Roles

none.

5.4.10 Class: RoutingValve

Definition: A valve with multiple outlet ports and (usually) a single inlet port, the purpose being to direct the incoming flow to one of a choice of continuing processes. The most common routing valves are rotary valves, which select an outlet by angular displacement, and trumpet valves, which select an outlet by linear displacement.

SubclassOf: [Valve](#)

Properties

none.

Other Roles

none.

5.5 Taxonomy by Mechanism

This section provides a taxonomy for valves according to the physical mechanism by which they modify or interrupt flow. While there tends to be strong correlation between the physical mechanisms and the intended functions described above, several of the mechanisms can be used to support more than one of the described functions. The mechanism concepts are depicted in Figure 23 and described below.

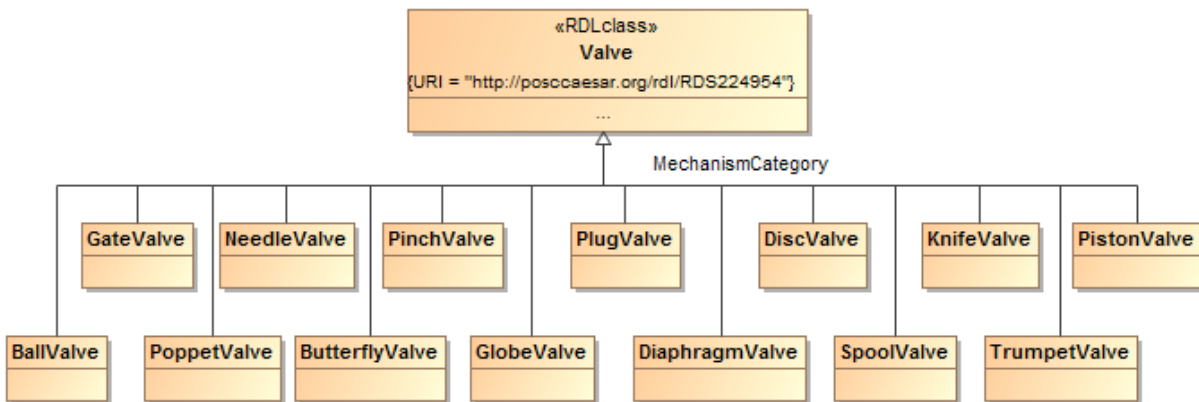

Figure 23 Valves classified by mechanism

5.5.1 Class: BallValve

A Ball valve is stemless. It regulates flow by the position of a spherical or convex closure member whose position is regulated by fluid pressure. A ball valve that is a control valve is usually positioned by hydraulic or pneumatic pressure on the side of the closure member that is opposite the process fluid. A

ball valve that is a check valve moves with the process fluid, forward into a position that does not interfere with flow, or backward into the seat, preventing backflow.

SubclassOf: [Valve](#)

Properties

none.

Other Roles

none.

5.5.2 Class: ButterflyValve

Definition: A Butterfly valve is two gate valves hinged in the middle, one side of which functions as a demand valve the opens into the source flow and the other as a relief valve, and possibly having a rigid or spring-loaded interaction.

SubclassOf: [Valve](#)

Properties

none.

Other Roles

none.

5.5.3 Class: ChokeValve

In general, a choke valve is a type of valve designed to create choked flow in a fluid. The rate of flow through the valve is determined only by the ambient pressure on the upstream side of the valve. (This is a functional classification.)

In fluid engineering contexts, a choke valve is a particular design of valve that raises and lowers a solid cylinder (called a *plug* or *stem*) which is placed around or inside another cylinder that has holes or slots. The design of a choke valve means fluids flowing through the cage are coming from all sides and that the streams of flow (through the holes or slots) collide with each other at the center of the cage cylinder, thereby dissipating the energy of the fluid through "flow impingement."

SubclassOf: [Valve](#)

Properties

none.

Other Roles

none.

5.5.4 Class: DiaphragmValve

Definition: A diaphragm valve has no seat per se. It is rather a set of moving members that create a typically round inlet or outlet with a variable diameter.

SubclassOf: [Valve](#)

Properties

none.

Other Roles

none.

5.5.5 Class: DiscValve

Definition: A Disc valve attenuates or ultimately interrupts flow by compressing a usually flat or convex disc against a relatively flat seat.

SubclassOf: [Valve](#)

Properties

none.

Other Roles

none.

5.5.6 Class: GateValve

Definition: A gate valve is hinged on one side, and functions usually as a relief valve to open under sufficient pressure from the inlet side.

SubclassOf: [Valve](#)

Properties

none.

Other Roles

none.

5.5.7 Class: GlobeValve

A globe valve consists of a movable disk and a stationary ring seat in a generally spherical body with two halves of the body (an inlet chamber and an outlet chamber) being separated by an internal baffle. The baffle has an opening that forms a seat into which a movable plug (disc) can be screwed in to close the valve and regulate flow between the two chambers.

SubclassOf: [Valve](#)

Properties

none.

Other Roles

none.

5.5.8 Class: KnifeValve

Definition: A Knife valve interrupts flow by dropping a blade-shaped member into a slot-shaped seat.

SubclassOf: [Valve](#)

Properties

none.

Other Roles

none.

5.5.9 Class: NeedleValve

Definition: A needle valve is a plug valve in which the member has a small diameter coming to a point. Needle valves produce fine attenuation control, and effective cutoff.

SubclassOf: [Valve](#)

Properties

none.

Other Roles

none.

5.5.10 Class: PinchValve

Definition: A pinch valve attenuates or interrupts flow moving both the closure member and the seat, so that they come together.

SubclassOf: [Valve](#)

Properties

none.

Other Roles

none.

5.5.11 Class: PlugValve

Definition: A Plug valve attenuates or ultimately interrupts flow by having a valve seat that is the chamber and inserting a cone-shaped member into the seat well.

SubclassOf: [Valve](#)

Properties

none.

Other Roles

none.

5.5.12 Class: PoppetValve

A poppet valve (also called a *mushroom valve*) is typically used to control the timing and quantity of gas flows. It consists of a port, usually round or oval, and a tapered plug or disk on the end of the valve stem. The stem guides the plug portion by sliding through a valve guide. The port is either the inlet (intake) or outlet (exhaust) port of the valve and is also the seat of the valve that receives the plug. Unlike many other valve designs, the poppet stem only guides the vertical motion of the disk, which lifts to open the valve and falls to close it. There is no motion of the disk against the seat and therefore no requirement for lubrication. The opening and closing of the poppet valve is assisted by, and in some cases entirely actuated by, pressure differential.

SubclassOf: [Valve](#)

Properties

none.

Other Roles

none.

5.5.13 Class: SpoolValve

Definition: A spool valve is a valve with a cylindrical chamber that functions as the seat, and a cylindrical member that rotates to align or disalign openings in the seat and the member to attenuate or alter the direction of flow.

SubclassOf: [Valve](#)

Properties

none.

Other Roles

none.

5.5.14 Class: TrumpetValve

Definition: A trumpet valve is a valve with a cylindrical chamber that functions as the seat, and a cylindrical member that is displaced linearly to align or disalign openings in the seat and the member to attenuate or alter the direction of flow.

SubclassOf: [Valve](#)

Properties

none.

Other Roles

none.

6 Ontology: Codes

The Codes model is a general model of datatypes whose values are taken from standard “code lists,” rather than explicitly enumerated in the UML/OWL model per se.

Each code list is a set of verbatim character string values specified by some standard, or specified by some active registry that keeps the current list of admissible values and their meanings.

So each Code value properly consists of two parts: the string value of the code itself, and the identification of the standard or registry that defines the Code value. In some cases of actual use, the specification for the data property whose value is the Code value will specify the standard or registry, and thus permit the standard/registry identifier to be omitted from the Code representation.

This ontology also introduces the concepts Organization and Standard, which are important to Codes, and used elsewhere in this paper.

This model is depicted in Figure 24 and described below.

A detailed proper model of Codes and Code registries is contained in ISO 11179 “Metadata registries.”

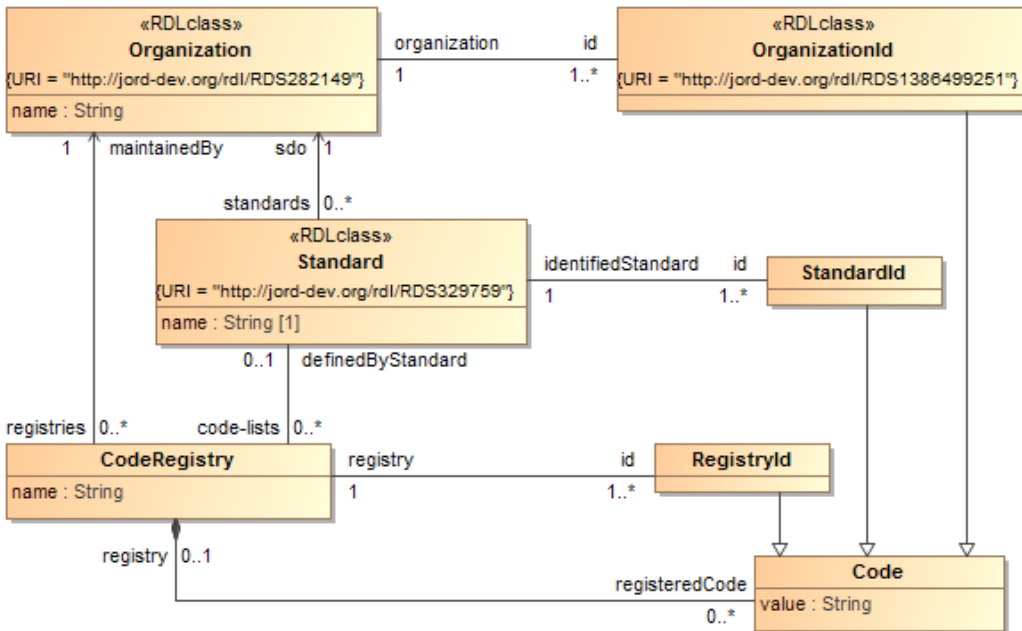

Figure 24 Codes and registries

6.1 Class: Code

Definition: A term for some specific thing, or kind of thing, that is defined by a standard or by an industrial registry that specifies the acceptable terms for things of that kind. A Code is a value taken from a standard "code list."

For example, a metal alloy Code is an identifier for a particular metal alloy. In the case of common metals and alloys that are widely available, the code terms are specified by a standard chemical/metals industry registry. Specialized alloys are usually identified by the metals producer and his product code.

An Internationalized Resource Identifier can also be seen as representing a Code, in which the "locator part" is the RegistryId and the "local part" ("suffix") is the Code value.

Properties

DataProperty: value **Type: [OWL:String](#)**

Definition: The code value per se – the unique identifier for the thing, that is defined in the standard or registry.

Cardinality: exactly 1

DataProperty: registryId **Type: [RegistryID](#)**

Definition: The identifier for the Standard or Registry that standardizes the list of codes to which this code belongs.

Cardinality: exactly 1

Other Roles

From: [Valves:ValveBodyType](#) as typeCode

From: [Valves:ValveBonnetType](#) as typeCode

From: [Valves:SeatTightness](#) as typeCode

From: [CodeRegistry](#) as registeredCode

6.2 Class: CodeRegistry

Definition: The standard, publication, or database that contains and maintains one or more standard "code lists."

Example: The Dunn & Bradstreet registry of business organizations.

Properties

DataProperty: name **Type: [OWL:String](#)**

Definition: The official formal name of the standard or registry.

Cardinality: exactly 1

ObjectProperty: definedByStandard **Range: [Standard](#)**

inverse: [Standard](#):code-lists

Definition: The standard, if any, in which the CodeRegistry (code-list) is specified. In some cases, the purpose of the standard is to define the registry, and some representation of the identifier for the standard is the identifier for the registry.

Cardinality: at most 1

DataProperty: id **Type: [RegistryID](#)**

Definition: The standard identifier for the registry that contains the code. This is itself often a code from a code list used by a particular industry domain to identify reference standards and code list repositories. A given registry can have multiple such identifiers in different code lists for different industries.

Example: In many industry usages, the Dunn & Bradstreet registry is designated "DUNS." In the United Nations CEFAC registry of code registries, the Dunn & Bradstreet registry is designated by code "16."

Cardinality: at least 1

Aspects: inverse functional property

ObjectProperty: maintainedBy **Range: [Organization](#)**

Definition: The organization that maintains the registry.

Cardinality: exactly 1

ObjectProperty: registeredCode **Range: [Code](#)**

Definition: The values in the "code list" in the registry.

Cardinality: unconstrained, composite

Other Roles

none.

6.3 Class: Organization

Stereotypes: [ISO-15926:RDLclass](#)

Definition: An [individual] that is composed of temporal parts of people and other assets, and are organised with a particular purpose.

Note: Company, government, and project team are subclasses of Organization.

Source: RDL

Properties

DataProperty: name **Type: [OWL:String](#)**

Definition: An organization name string.

Source: RDL

Cardinality: exactly 1

ObjectProperty: id **Range: [OrganizationId](#)**

inverse: [OrganizationId](#):organization

Definition: An organization identifier string, usually associated with some registry.

Source: RDL, URI = <http://jord-dev.org/rdl/RDS282149>

Cardinality: at least 1

Other Roles

From: [General:ProductModel](#) as manufacturer

From: [General:Project](#) as responsibleOrganization

From: [General:ProductDataSheet](#) as source

From: [General:Plant](#) as owner

From: [General:Plant](#) as operator

From: [CodeRegistry](#) as maintainedBy

From: [Standard](#) as sdo

6.4 Class: OrganizationId

Stereotypes: [ISO-15926:RDLclass](#)

Definition: An 'identifier' and a 'formatted string' [a Code] that identifies an organization.

Source: RDL, URI = <http://jord-dev.org/rdl/RDS1386499251>

SubclassOf: [Code](#)

Properties

ObjectProperty: organization Range: [Organization](#)

inverse: [Organization](#):id

Definition: The organization to which the OrganizationId refers.

Cardinality: exactly 1

Other Roles

From: [General:Plant](#) as id

6.5 Datatype: RegistryID

Definition: A sequence of characters that uniquely identifies a code registry. It may be the name or acronym for a standard publication, the URI for a web-based registry, or a code in some catalog of registries.

SubclassOf: [OWL:String](#)

Roles

From: [Code](#) as registryId

From: [CodeRegistry](#) as id

6.6 Class: Standard

Stereotypes: [ISO-15926:RDLclass](#)

Definition: A published specification that is adopted by industry convention and that specifies the required structure of an object or the proper conduct of an industry practice.

Source: RDL, URI = <http://jord-dev.org/rdl/RDS329759>

Properties

DataProperty: name Type: [OWL:String](#)

Definition: The formal title for the standard.

Cardinality: exactly 1

ObjectProperty: code-lists **Range: [CodeRegistry](#)**

inverse: [CodeRegistry](#):definedByStandard

Definition: The set of code lists defined by or in the Standard.

Cardinality: unconstrained

ObjectProperty: id **Range: [StandardId](#)**

inverse: [StandardId](#):identifiedStandard

Definition: A formal identifier for the standard, in the form of a registered code.

Cardinality: at least 1

ObjectProperty: sdo **Range: [Organization](#)**

Definition: The Standards Development Organization (SDO) that is responsible for publication and maintenance of the standard.

Cardinality: exactly 1

Other Roles

none.

6.7 Class: StandardId

Definition: An identifier that uniquely identifies a published industry standard. The value is typically the code or publication number for the standard in the catalog of the SDO, and the registryId is a short designation for the SDO, such as "ISO" or "API."

SubclassOf: [Code](#)

Properties

ObjectProperty: identifiedStandard **Range: [Standard](#)**

inverse: [Standard](#):id

Definition: The industry standard that the StandardId identifies.

Cardinality: exactly 1

Other Roles

none.

7 Ontology: Materials

The Materials package is a high-level abstract model of materials and fluids. The concepts are shown in Figure 25 and described in detail below.

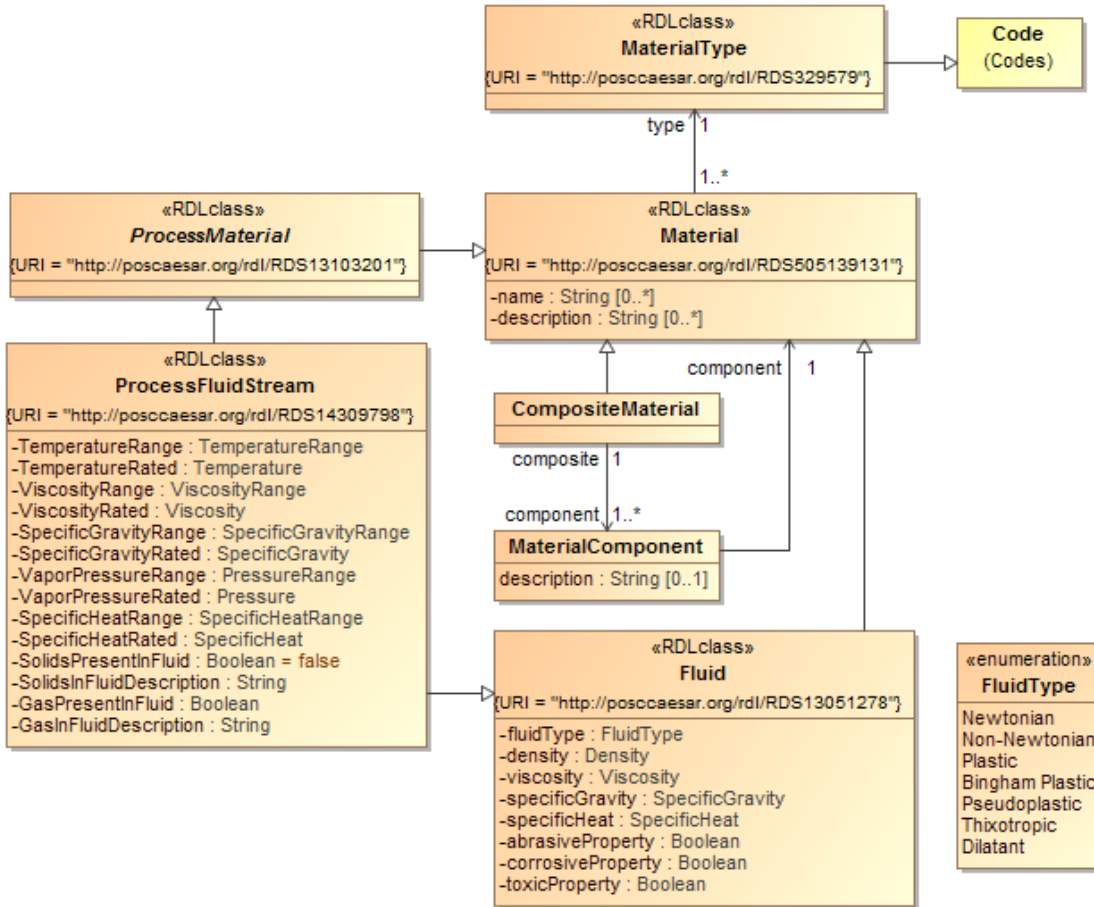

Figure 25 Materials

7.1 Class: CompositeMaterial

Definition: A Material that is a composite of other Materials.

Note: It is only important to model a Material as composite when its composition is important.

SubclassOf: [Material](#)

Properties

ObjectProperty: component Range: [MaterialComponent](#)

Definition: The relationship between the composite material and one of its component materials.

Cardinality: at least 1

Other Roles

none

7.2 Class: Fluid

Definition: Any liquid or gas that cannot sustain a shearing force when at rest and that undergoes a continuous change in shape (see flow) when subjected to such a stress. Compressed fluids exert an outward pressure that is perpendicular to the walls of their containers.

Source: (Merriam-Webster 2014)

Definition: A substance that is capable of flowing and that changes shape at a steady rate when acted on by a force that tends to change its shape.

Source: RDL, URI = <http://posccaesar.org/rdl/RDS13051278>

SubclassOf: [Material](#)

Properties

DataProperty: abrasiveProperty Type: [OWL:Boolean](#)

Definition: True if the fluid flow can damage equipment by mechanical means; else false.

Cardinality: exactly 1

DataProperty: corrosiveProperty Type: [OWL:Boolean](#)

Definition: True if the fluid flow can damage equipment by chemical means; else false.

Cardinality: exactly 1

ObjectProperty: density Range: [Quantities:Density](#)

Definition: density of the Fluid at a reference temperature and pressure.

Out of context, the reference is standard temperature and pressure, i.e., 20 C and 1 atmosphere.

Cardinality: exactly 1

ObjectProperty: fluidType Range: [FluidType](#)

Definition: Pumped fluid characteristic based on pick list choices.

Source: HI EDE 50.7

Cardinality: exactly 1

ObjectProperty: specificGravity Range: [Quantities:SpecificGravity](#)

Definition: specific gravity of the Fluid at a reference temperature and pressure.

Out of context, the reference is standard temperature and pressure, i.e., 20 C and 1 atmosphere.

Cardinality: exactly 1

ObjectProperty: specificHeat Range: [Quantities:SpecificHeat](#)

Definition: specific heat of the Fluid at a reference pressure.

Out of context, the reference pressure is 1 atmosphere.

Cardinality: exactly 1

DataProperty: toxicProperty **Type: [OWL:Boolean](#)**

Definition: True if Acute or chronic exposure to the fluid can cause physical harm to humans.

Note: Any toxic material has an associated Materials Safety Data Sheet (MSDS) that specifies risk, required handling, and required protection for persons and possibly equipment. The owner of a material is required to provide the MSDS information.

Cardinality: exactly 1

ObjectProperty: viscosity **Range: [Quantities:Viscosity](#)**

Definition: viscosity of the Fluid at a reference temperature and pressure.

Out of context, the reference is standard temperature and pressure, i.e., 20 C and 1 atmosphere.

Cardinality: exactly 1

Other Roles

From: [Centrifugal Pump:PumpShaft](#) as bufferFluid

From: [Centrifugal Pump:Pump](#) as pumpedFluid

7.3 Class: Material

Definition: Any substance, but particularly a substance of which things of interest consist or are made.

Source: RDL, URI = <http://posccaesar.org/rdl/RDS505139131>

Properties

DataProperty: description **Type: [OWL:String](#)**

Definition: A general description of the Material, which may call out its special properties, non-quantifiable properties, or primary uses.

Cardinality: unconstrained

DataProperty: name **Type: [OWL:String](#)**

Definition: The common name for the Material.

Cardinality: unconstrained

ObjectProperty: type **Range: [MaterialType](#)**

Definition: A name or code that indicates the physical form and chemical nature of the Material, providing sufficient information about its properties to determine its suitability for the intended use.

Source: RDL, URI = <http://posccaesar.org/rdl/RDS329579>

Cardinality: exactly 1

Other Roles

From [MaterialComponent](#) as component
From: [Instruments:DetectingInstrument](#) as body material
From: [Centrifugal_Pump:PumpShaft](#) as ShaftMaterial
From: [Centrifugal_Pump:Packing](#) as PackingMaterial
From: [Centrifugal_Pump:Gland](#) as GlandMaterial
From: [Centrifugal_Pump:ShaftSleeve](#) as SleeveMaterial
From: [Centrifugal_Pump:Bearings](#) as HousingSealMaterial
From: [Centrifugal_Pump:Port](#) as nozzleMaterial
From: [Centrifugal_Pump:PumpBaseplate](#) as BaseplateMaterial
From: [General:PartElement](#) as material

7.4 Class: MaterialComponent

Definition: The relationship between the composite material and one of its component materials; the characterization of the component Material as a component of the CompositeMaterial.

SubclassOf: none

Properties

ObjectProperty: component **Range:** [Material](#)

Definition: The Material that is this component of the CompositeMaterial.

Cardinality: exactly 1

DataProperty: description **Type:** [OWL:String](#)

Definition: important properties of the component Material as a component of the CompositeMaterial.

Note: This is a stand-in for a proper model of the important properties of the relationship, such as the amount or concentration of the component material in the composite material. Such properties are not addressed in detail in this specification.

Cardinality: at most 1

Other Roles

From [CompositeMaterial](#) as component

7.5 Class: MaterialType

Definition: A specification that describes the applicable materials.

Source: RDL, URI = <http://posccaesar.org/rdl/RDS329579>

SubclassOf: [Codes:Code](#)

Properties

none.

Other Roles

From: [Material](#) as type

7.6 Class: ProcessFluidStream

Stereotypes: [ISO-15926:RDLclass](#)

Definition: A fluid stream that is a ProcessMaterial for some process.

Source: JORD RDL as Process Item Fluid Stream

Note: ProcessFluidStream characterizes the state of the fluid being processed at some specific point in the process. It usually describes the (expected and possible) states of the fluid at the inlet to the train/line element that is the physical realization of that point in the process.

Note: The characteristics of the ProcessFluidStream are almost always provided by the plant owner/operator.

SubclassOf: [ProcessMaterial](#), [Fluid](#)

Properties

DataProperty: GasInFluidDescription **Type:** [OWL:String](#)

Definition: Text field describing the gas materials per unit weight of pumped fluid, the gas concentration by volume, the characteristics of solution and dissolution of the gas, and other relevant characteristics of the gas.

Cardinality: exactly 1

DataProperty: GasPresentInFluid **Type:** [OWL:Boolean](#)

Definition: Indicates whether gases are present in the fluid (Y/N). If Yes, describe the characteristics of the gases in the "Gases in Fluid Description."

Cardinality: exactly 1

DataProperty: SolidsInFluidDescription **Type:** [OWL:String](#)

Definition: Text field describing the solid materials per unit weight of pumped fluid, the solids concentration by volume, the minimum and maximum particle size or sphere size of the solid, the friability/attrition, the solids hardness, or other relevant characteristics of the solids.

Source: HI EDE 50.7

Cardinality: exactly 1

DataProperty: SolidsPresentInFluid **Type:** [OWL:Boolean](#)

Definition: Indicates whether solids are present in the fluid (Y/N). If solids are present, detailed characteristics of the solids are described in the "Solids in Fluid Description."

Source: HI EDE 50.7

Cardinality: exactly 1

ObjectProperty: SpecificGravityRange Range: [Quantities:SpecificGravityRange](#)

Definition: The range of specific gravities of the ProcessFluid over the given Temperature and pressure range, where the nominal value is at the nominal temperature and pressure.

Cardinality: exactly 1

ObjectProperty: SpecificGravityRated Range: [Quantities:SpecificGravity](#)

Definition: Specific gravity at the rated temperature.

Source: HI EDE 50.7

Cardinality: exactly 1

ObjectProperty: SpecificHeatRange Range: [Quantities:SpecificHeatRange](#)

Definition: The range of specific heat of the process fluid over the specified range of temperatures and pressures.

Source: HI EDE 50.7

Cardinality: exactly 1

ObjectProperty: SpecificHeatRated Range: [Quantities:SpecificHeat](#)

Definition: The specific heat of the process fluid at the rated temperature and pressure.

Source: HI EDE 50.7

Cardinality: exactly 1

ObjectProperty: TemperatureRange Range: [Quantities:TemperatureRange](#)

Definition: The range of fluid temperatures to which the processing equipment may be exposed.

This information is provided by the owner/operator.

Source: HI EDE 50.7

Cardinality: exactly 1

ObjectProperty: TemperatureRated Range: [Quantities:Temperature](#)

Definition: The fluid temperature that corresponds with the rated conditions used to select the processing equipment. Other rated fluid properties such as specific gravity, vapor pressure, and viscosity are determined at this temperature.

Source: HI EDE 50.7

Cardinality: exactly 1

ObjectProperty: VaporPressureRange Range: [Quantities:PressureRange](#)

Definition: Over the specified range of temperatures, the range of absolute pressures at which the liquid and its vapor are in equilibrium.

This information is provided by the owner/operator.

Source: HI EDE 50.7, taken from HI 3.3.9 (Hydraulic Institute 2008)

Source: RDL, URI = <http://posccaesar.org/rdl/RDS14309798>

Cardinality: exactly 1

ObjectProperty: VaporPressureRated **Range: [Quantities:Pressure](#)**

Definition: At the rated temperature, the absolute pressure at which the liquid and its vapor are in equilibrium.

This information is provided by the owner/operator.

Source: HI EDE 50.7, taken from HI 3.3.9 (Hydraulic Institute 2008)

Cardinality: exactly 1

ObjectProperty: ViscosityRange **Range: [Quantities:ViscosityRange](#)**

Definition: The range of viscosities of the fluid over the given TemperatureRange, with the nominalViscosity at the nominalTemperature. Note: For non-Newtonian fluids, an apparent viscosity is provided that often depends on the rate of shear.

This information is provided by the owner/operator.

Source: HI EDE 50.7

Cardinality: exactly 1

ObjectProperty: ViscosityRated **Range: [Quantities:Viscosity](#)**

Definition: The fluid viscosity that corresponds with the rated conditions used to select the processing equipment.

Source: HI EDE 50.7

Cardinality: exactly 1

Other Roles

From: [Instruments:ProcessInstrument](#) as measuredProcessMaterial

7.7 Class: ProcessMaterial

Stereotypes: [ISO-15926:RDLclass](#)

Definition: A/the material being processed through a process or the supporting system, usually with the intent of yielding some product. Technically a ProcessMaterial is a role of the actual Material, but many of the specified characteristics of a ProcessMaterial depend on the model for the process that the material undergoes.

Source: RDL, URI = <http://posccaesar.org/rdl/RDS13103201>

Aspects: abstract

SubclassOf: [Material](#)

Properties

none.

7.8 Enumerated Class: FluidType

Definition: The behavior pattern for fluid viscosity relative to temperature, pressure, stress and shear.

Source: HI EDE 50.7

Named Individual Members

Member: Newtonian

Definition: Any fluid such that the viscous stresses that arise from its flow, at every point, are proportional to the local strain rate (the rate of change of its deformation over time).

Source: (Batchelor 2000)

Member: Non-Newtonian

Definition: A fluid whose viscosity is variable, based on applied stress or force.

Note: Behavior of Newtonian fluids like water can be described exclusively by temperature and pressure. The physical behavior of a non-Newtonian fluid depends on the forces acting on it from second to second.

Source: (Batchelor 2000)

Member: Bingham Plastic

Definition: A Bingham plastic is a viscoplastic material that behaves as a rigid body at low stresses but flows as a viscous fluid at high stress.

Source: (Wikipedia n.d.)

Member: Pseudoplastic

Definition: Also called a *shear thinning fluid*. A material where the viscosity decreases with increasing shear rate, such as polymer solutions and emulsions, coating dispersions, paints, adhesives, varnishes and resins.

Source: (Specialty Graphic Imaging Association (SGIA) n.d.)

Member: Thixotropic

Definition: Certain gels or fluids that are thick (viscous) under normal conditions flow (become thin, less viscous) over time when shaken, agitated, or otherwise stressed.

Source: (Wikipedia n.d.)

Member: Plastic

Definition: fluids where flow does not occur until a critical shear stress (yield stress) is exceeded.

Source: (Specialty Graphic Imaging Association (SGIA) n.d.)

Member: Dilatant

Definition: A substance whose viscosity increases with rate of shear. Dilatant fluids are solid or highly viscous when stirred, and fluid when undisturbed.

Source: (Wikipedia n.d.)

Other Roles

From: [Fluid](#) as fluidType

8 Ontology: Quantities

The Quantities model is a basic model of quantities and quantity values. It is a simplification of the model given in section 1 of the International Vocabulary of Metrology (International Bureau of Weights and Measures (BIPM) 2012).

The basic idea is that a Quantity is an abstraction of measurements of some property of some thing. A QuantityKind is a category of such measurements in which all members of the same category can be compared to one another. Systems of quantities define certain QuantityKinds as “base quantities” and others as “derived quantities” that can be expressed in terms of base quantities.

Each modeled subclass of Quantity in this model is a QuantityKind that is used in describing some specified or measured aspects of the process and its equipment.

A QuantityValue is a representation of a Quantity as a reference “unit” quantity and the ratio of the Quantity in question to that unit quantity. Standard reference unit quantities exist, and are called *standard units of measure*.” The same Quantity can be expressed as different ratios to different units.

So, a quantity specification for a property of a DesignElement is phrased as a QuantityValue, and in some cases may specify the required reference unit. Experience teaches that assuming that “industry custom” will define the intended reference unit is a very risky practice.

8.1 Quantity concepts

This section describes the fundamental elements of the Quantities model, which are depicted in QuantitiesFigure 26

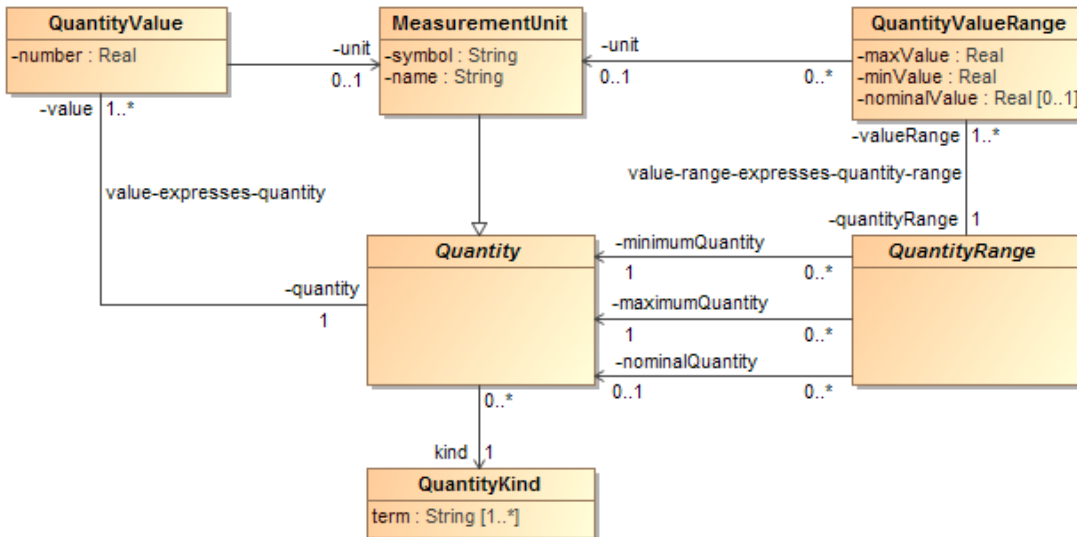

Figure 26 Quantities

8.1.1 Class: MeasurementUnit

Definition: real scalar quantity, defined and adopted by convention, with which any other quantity of the same kind can be compared to express the ratio of the two quantities as a number.

Source: International vocabulary of metrology (VIM) (International Bureau of Weights and Measures (BIPM) 2012)

SubclassOf: [Quantity](#)

Properties

DataProperty: name **Type:** [OWL:String](#)

Definition: Name of unit.

Cardinality: exactly 1

DataProperty: symbol **Type:** [OWL:String](#)

Definition: Symbol of the unit.

Cardinality: exactly 1

Other Roles

From: [QuantityValue](#) as unit

From: [QuantityValueRange](#) as unit

8.1.2 Class: Quantity

Definition: property of a phenomenon, body, or substance, where the property has a magnitude that can be expressed as a number and a reference. Also the abstraction of the measured property that is considered to be the same across many individual things, such as a Length of 1 meter.

A quantity is expressed by a QuantityValue. Quantity is an abstract class: Every actual quantity is an instance of some specific subclass of Quantity.

Source: International vocabulary of metrology (VIM) (International Bureau of Weights and Measures (BIPM) 2012)

Aspects: abstract

Properties

ObjectProperty: kind **Range:** [QuantityKind](#)

Definition: The kind of quantity that the Quantity represents.

Cardinality: exactly 1

ObjectProperty: value **Range:** [QuantityValue](#)

inverse: [Quantity](#) quantity via: [value-expresses-quantity](#)

Definition: expression of the Quantity as a ratio of the Quantity to a reference MeasurementUnit.

Cardinality: at least 1

Other Roles

From: [QuantityRange](#) as maximumQuantity

From: [QuantityRange](#) as minimumQuantity

From: [QuantityRange](#) as nominalQuantity

8.1.3 Class: QuantityKind

Definition: that aspect of quantities that makes them comparable to one another. Any two quantities of the same quantity kind can be compared. Two quantities of different kinds cannot be compared.

Note: Therefore, each QuantityKind is itself a subtype of Quantity. However, not every subtype of quantity is a QuantityKind. The QuantityKinds are those that distinguish comparabilities. For example, Length and Velocity are QuantityKinds, but Air Speed is the same QuantityKind as Velocity.

Source: International Vocabulary of metrology (VIM): "kind of quantity" (International Bureau of Weights and Measures (BIPM) 2012)

Properties

DataProperty: term **Type: [OWL:String](#)**

Definition: A term that denotes the quantity kind. The quantity kinds defined in the International System of Quantities have standard terms.

Cardinality: at least 1

Other Roles

From: [Quantity](#) as kind

8.1.4 Class: QuantityRange

Definition: A specification for a range of Quantities of a particular kind as the range of values for some property. It refers to any and all quantities of that kind that are greater than a minimum quantity and less than a maximum quantity. A QuantityRange may also include a “nominal Quantity” that refers to the expected value for the property in normal use.

A QuantityRange can be used in two ways:

- A QuantityRange can specify a range of property values that a qualifying thing must support and/or has been tested to support. In this sense, it represents the range of behaviors of a system that the qualifying thing is part of. The nominal quantity then expresses the expected normal behavior of the system, which can be used in choosing an optimal thing, or an optimal configuration of the thing, to meet the specifications.
- Alternatively, a QuantityRange can specify an upper and lower bound on a tolerated property of the thing, requiring only that the actual property of the thing fall within those bounds.

Aspects: abstract. Like Quantity, every usage of a QuantityRange is of a specific kind of Quantity.

Properties

ObjectProperty: maximumQuantity **Range: [Quantity](#)**

Definition: The specification for the largest (maximum) Quantity that is within the QuantityRange. The ratio of each Quantity that is in the QuantityRange to this Quantity is less than or equal to 1.

Cardinality: exactly 1

ObjectProperty: minimumQuantity **Range: [Quantity](#)**

Definition: The specification for the smallest (minimum) Quantity that is within the QuantityRange. The ratio of each Quantity that is in the QuantityRange to this Quantity is greater than or equal to 1.

Cardinality: exactly 1

ObjectProperty: nominalQuantity **Range: [Quantity](#)**

Definition: The specification for the typical or expected Quantity, whose lower and upper bounds are specified by the QuantityRange.

Cardinality: at most 1

ObjectProperty: valueRange **Range: [QuantityValueRange](#)**

inverse: [QuantityValueRange](#).quantityRange

Definition: An expression of the QuantityRange as a range of multipliers for a reference MeasurementUnit. A QuantityRange is almost always expressed as a QuantityValueRange.

Cardinality: at least 1

Other Roles

From: [Instruments:MeasuringDevice](#) as calibratedRange

8.1.5 Class: QuantityValue

Definition: number and reference [unit] together expressing the magnitude of a quantity a characterization of the Quantity by a numeric value that is the ratio of the quantity to some reference quantity. The reference quantity is called the *unit of measure* or *measurement unit*, since it is the quantity whose ratio to the reference quantity is 1.

Source: International Vocabulary of metrology (VIM) (International Bureau of Weights and Measures (BIPM) 2012)

Properties

DataProperty: number **Type: [OWL:Real](#)**

Definition: The ratio of the Quantity to the Measurement Unit.

Cardinality: exactly 1

ObjectProperty: quantity **Range: [Quantity](#)**

inverse: [QuantityValue](#) value via: [value-expresses-quantity](#)

Definition: The Quantity that is expressed by the QuantityValue.

Cardinality: exactly 1

ObjectProperty: unit **Range: [MeasurementUnit](#)**

Definition: The reference unit for the QuantityValue.

Cardinality: at most 1

8.1.6 Class: QuantityValueRange

Definition: The characterization of a QuantityRange in terms of multiples of a given MeasurementUnit.

Properties

DataProperty: maxValue Type: [OWL:Real](#)

Definition: The ratio of the maximumQuantity of the QuantityRange to the unit of the QuantityValueRange.

Cardinality: exactly 1

DataProperty: minValue Type: [OWL:Real](#)

Definition: The ratio of the minimumQuantity of the QuantityRange to the unit of the QuantityValueRange.

Cardinality: exactly 1

DataProperty: nominalValue Type: [OWL:Real](#)

Definition: The ratio of the nominalQuantity of the QuantityRange, if any, to the unit of the QuantityValueRange.

Cardinality: at most 1

ObjectProperty: quantityRange Range: [QuantityRange](#)

inverse: [QuantityValueRange](#) valueRange via: [value-range-expresses-quantity-range](#)

Definition: The QuantityRange that the QuantityValueRange specifies.

Cardinality: exactly 1

ObjectProperty: unit Range: [MeasurementUnit](#)

Definition: The reference unit for the QuantityValueRange. All of the values for the QuantityValueRange are multiples of this MeasurementUnit.

Cardinality: at most 1

8.2 Quantity kinds

The principal subtypes of Quantity are referred to as “kinds of quantity” or “quantity kinds” in ISO 80000 – the reference international standard for quantities and measurements. There is a very large number of distinct quantity kinds, and there are formal systems for defining quantity kinds and the corresponding measurement units. This specification does not address those concepts.

All quantities of the same kind (subclass) are comparable, no matter what they measure. Quantities of different kinds (subclasses) are not comparable.

This section only identifies the quantity kinds that are used in the current version of the Product Data Sheet ontology. They are shown in Figure 27. (Figure 28 shows the corresponding QuantityRange classes.) Others can be added as needed, pending a standard OWL model for quantities.

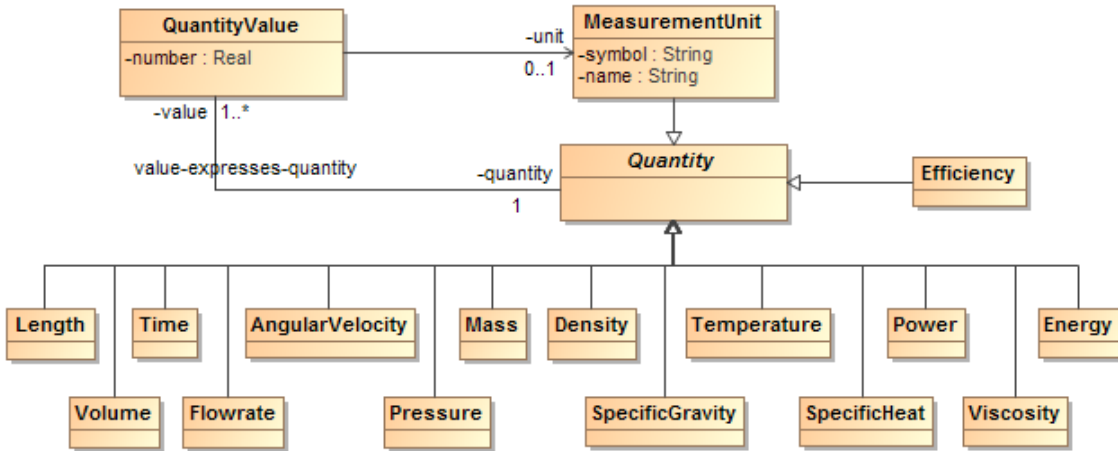

Figure 27 Quantity Kinds

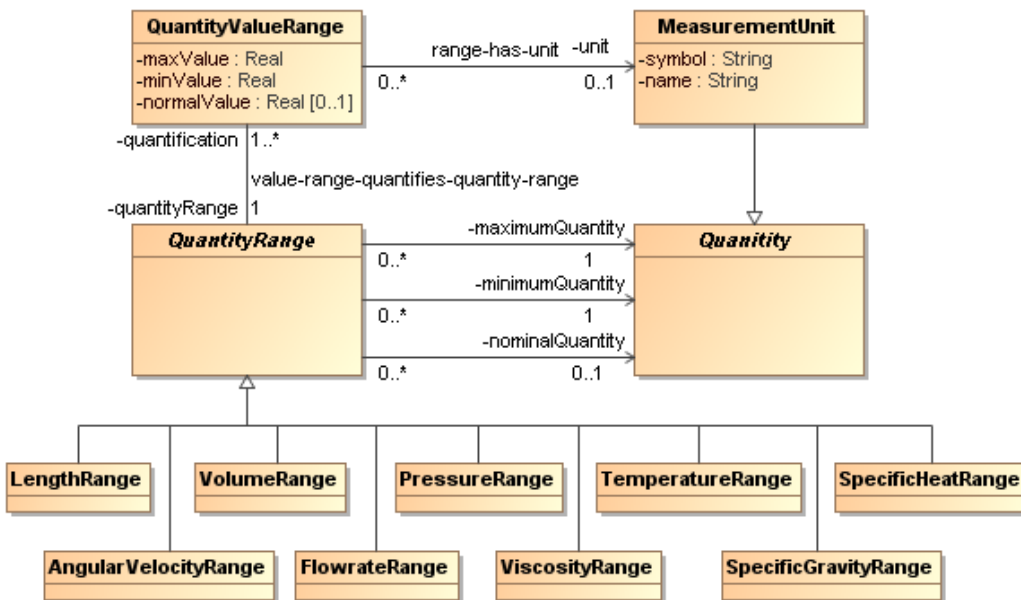

Figure 28 Quantity Ranges

8.2.1 Class: AngularVelocity

Definition: The ratio of angular displacement to time of displacement for a rotating object. By convention, angular displacement is given in full rotations (360-degree displacements) over time.

SubclassOf: [Quantity](#)

Properties

none.

Other Roles

From: [Centrifugal_Pump:CentrifugalPump](#) as PumpSpeedRated

From: [Centrifugal_Pump:CentrifugalPump](#) as SuctionSpecSpeed

From: [Centrifugal_Pump:Driver](#) as DriverFullLoadSpeed

8.2.2 Class: AngularVelocityRange

Definition: A QuantityRange of AngularVelocity quantities.

SubclassOf: [QuantityRange](#)

Properties

none.

Other Roles

From: [Centrifugal_Pump:CentrifugalPump](#) as SpeedRange

8.2.3 Class: Density

Definition: The ratio of mass to volume of a substance.

SubclassOf: [Quantity](#)

Properties

none.

Other Roles

From: [Materials:Fluid](#) as density

8.2.4 Class: Efficiency

Definition: The ratio of the energy consumed by an action or function to the energy produced as useful output of a particular type.

SubclassOf: [Quantity](#)

Properties

none.

Other Roles

From: [Centrifugal_Pump:CentrifugalPump](#) as EfficiencyAtRatedCondition

8.2.5 Class: Energy

Definition: force applied over distance (kinetic energy), or the potential for applying force over a distance (potential energy).

SubclassOf: [Quantity](#)

Properties

none.

8.2.6 Class: Flowrate

Definition: The ratio of the volume of a flow to time.

SubclassOf: [Quantity](#)

Properties

none.

Other Roles

From: [Centrifugal_Pump:CentrifugalPump](#) as FlowrateRated

From: [Centrifugal_Pump:CentrifugalPump](#) as MinContinuousStableFlow

8.2.7 Class: FlowrateRange

Definition: A QuantityRange of Flowrate quantities.

SubclassOf: [QuantityRange](#)

Properties

none.

Other Roles

From: [Centrifugal_Pump:CentrifugalPump](#) as FlowrateRange

8.2.8 Class: Length

Definition: A quantification of linear displacement. The "length" Quantity in the International System of Quantities (SI).

SubclassOf: [Quantity](#)

Properties

none.

Other Roles

From: [Instruments:Flange](#) as flangeSize

From: [Instruments:Flange](#) as adapterBoltSize

From: [Instruments:ProcessInstrument](#) as connectionSize

From: [Centrifugal_Pump:Head](#) as height

From: [Centrifugal_Pump:PumpCoupling](#) as size

From: [Centrifugal_Pump:Impeller](#) as DiameterRated

From: [Centrifugal_Pump:Port](#) as size

From: [Valves:FluidPort](#) as size

8.2.9 Class: LengthRange

Definition: A QuantityRange of Length quantities.

SubclassOf: [QuantityRange](#)

Properties

none.

Other Roles

From: [Centrifugal Pump:HeadRange](#) as heightFrom: [Centrifugal Pump:Impeller](#) as DiameterRange

8.2.10 Class: Mass

Definition: The amount of substance in a physical object. The "mass" Quantity in the International System of Quantities (SI).

SubclassOf: [Quantity](#)

Properties

none.

8.2.11 Class: Power

Definition: The ratio of the energy produced or consumed by a device or action to the time of production or consumption.

SubclassOf: [Quantity](#)

Properties

none.

Other Roles

From: [Instruments:ElectricalSystem](#) as power consumption

From: [Centrifugal Pump:CentrifugalPump](#) as PowerRated

From: [Centrifugal Pump:CentrifugalPump](#) as PowerMax

From: [Centrifugal Pump:Driver](#) as NameplatePower

8.2.12 Class: Pressure

Definition: The ratio of force delivered to an area of a substance

Note: QuantityValues that represent Pressure may be given in Pressure units, or in what appear to be Length units. The latter represent the pressure exerted by a column of fluid of that height, but they are incomplete without a designation of the fluid. That is, "mm Hg" (millimeters of mercury) or "m H₂O" (meters of water) are proper pressure units, whereas the length units alone are not. In practice, the reference liquid may be separately identified and only the length unit symbol may appear. Such representation conventions must not be confused with the proper identification of the unit.

SubclassOf: [Quantity](#)

Properties

none.

Other Roles

From: [Instruments:PressureTransmitter](#) as max operating pressure

From: [Centrifugal_Pump:CentrifugalPump](#) as DischargePressureRated

From: [Centrifugal_Pump:CentrifugalPump](#) as SuctionPressureRated

From: [Centrifugal_Pump:CentrifugalPump](#) as DifferentialPressureRated

From: [Centrifugal_Pump:PumpCasing](#) as MAWP

From: [Centrifugal_Pump:StuffingBox](#) as Pressure

From: [Materials:ProcessFluidStream](#) as VaporPressureRated

8.2.13 Class: PressureRange

Definition: A QuantityRange of Pressure quantities.

SubclassOf: [QuantityRange](#)

Properties

none.

Other Roles

From: [Instruments:PressureTransmitter](#) as calibrated range

From: [Centrifugal_Pump:CentrifugalPump](#) as DischargePressureRange

From: [Centrifugal_Pump:CentrifugalPump](#) as DifferentialPressureRange

From: [Centrifugal_Pump:CentrifugalPump](#) as SuctionPressureRange

From: [Materials:ProcessFluidStream](#) as VaporPressureRange

8.2.14 Class: SpecificGravity

Definition: Specific gravity of a substance is the dimensionless ratio of the specific weight (the mass of a unit volume) of the substance to the specific weight of water at standard temperature and pressure. The mass of a unit volume of the substance may, of course, depend on the temperature and pressure conditions under which the substance is measured. The reference specific weight of water is invariant.

SubclassOf: [Quantity](#)

Properties

none.

Other Roles

From: [Materials:Fluid](#) as specificGravity

From: [Materials:ProcessFluidStream](#) as SpecificGravityRated

8.2.15 Class: SpecificGravityRange

Definition: A QuantityRange of SpecificGravity quantities.

SubclassOf: [QuantityRange](#)

Properties

none.

Other Roles

From: [Materials:ProcessFluidStream](#) as SpecificGravityRange

8.2.16 Class: SpecificHeat

Definition: The amount of heat transferred to raise a unit mass of a substance 1 degree in temperature at a given temperature and constant pressure. Typical Units are kJ/(kg • degC).

SubclassOf: [Quantity](#)

Properties

none.

Other Roles

From: [Materials:Fluid](#) as specificHeat

From: [Materials:ProcessFluidStream](#) as SpecificHeatRated

8.2.17 Class: SpecificHeatRange

Definition: A QuantityRange of SpecificHeat quantities.

SubclassOf: [QuantityRange](#)

Properties

none.

Other Roles

From: [Materials:ProcessFluidStream](#) as SpecificHeatRange

8.2.18 Class: Temperature

Definition: The "temperature" Quantity in the International System of Quantities (SI).

SubclassOf: [Quantity](#)

Properties

none.

Other Roles

From: [Instruments:DetectingInstrument](#) as max operating temperature

From: [Instruments:DetectingInstrument](#) as max ambient temperature

From: [Centrifugal_Pump:PumpCasing](#) as MAWPrefTemp

From: [Materials:ProcessFluidStream](#) as TemperatureRated

8.2.19 Class: TemperatureRange

Definition: A QuantityRange of Temperature quantities.

SubclassOf: [QuantityRange](#)

Properties

none.

Other Roles

From: [Materials:ProcessFluidStream](#) as TemperatureRange

8.2.20 Class: Time

Definition: The "time" Quantity in the International System of Quantities (SI). An amount of time, a duration, as distinct from a point in time.

SubclassOf: [Quantity](#)

Properties

none.

Other Roles

From: [Centrifugal_Pump:CentrifugalPump](#) as OperatingTimeAtNormalFlowrate

From: [Centrifugal_Pump:CentrifugalPump](#) as OperatingTimeAtMaxFlowrate

From: [Centrifugal_Pump:CentrifugalPump](#) as OperatingTimeAtMinFlowrate

From: [Centrifugal_Pump:CentrifugalPump](#) as OperatingTimeAtRatedFlowrate

8.2.21 Class: Viscosity

Definition: Fluid viscosity is the measure of the tendency of the fluid to resist internal shearing forces which are required to produce flow, at a reference temperature.

Viscosity may be described in kinematic viscosity units.

Source: HI 3.3.5 (Hydraulic Institute 2008)

SubclassOf: [Quantity](#)

Properties

none.

Other Roles

From: [Materials:Fluid](#) as viscosity

From: [Materials:ProcessFluidStream](#) as ViscosityRated

8.2.22 Class: ViscosityRange

Definition: A QuantityRange of Viscosity quantities.

SubclassOf: [QuantityRange](#)

Properties

none.

Other Roles

From: [Materials:ProcessFluidStream](#) as ViscosityRange

8.2.23 Class: Voltage

Definition: The electric potential difference between two points, or the difference in electric potential energy of a unit charge transported between two points

SubclassOf: [Quantity](#)

Properties

none.

8.2.24 Class: Volume

Definition: An amount of three-dimensional space, expressed as a product of three lengths.

SubclassOf: [Quantity](#)

Properties

none.

8.2.25 Class: VolumeRange

Definition: A QuantityRange of Volume quantities.

SubclassOf: [QuantityRange](#)

Properties

none.

9 Ontology: Shaft Seals

This ontology is technically a “module,” intended for inclusion in the descriptions of equipment and instruments that have fixed or moving shafts or stems in the process fluid stream. It extends the [WettedPart](#) concept in the [General Product Data Sheet](#) ontology above.

This module describes the two forms of seal used to prevent leakage between the shaft or stem and the outside of the body or casing. The sealing mechanism is typically called a *stuffing box* when a packing structure is used. Any alternative mechanism is called a *mechanical seal*. The detailed model is shown in Figure 29.

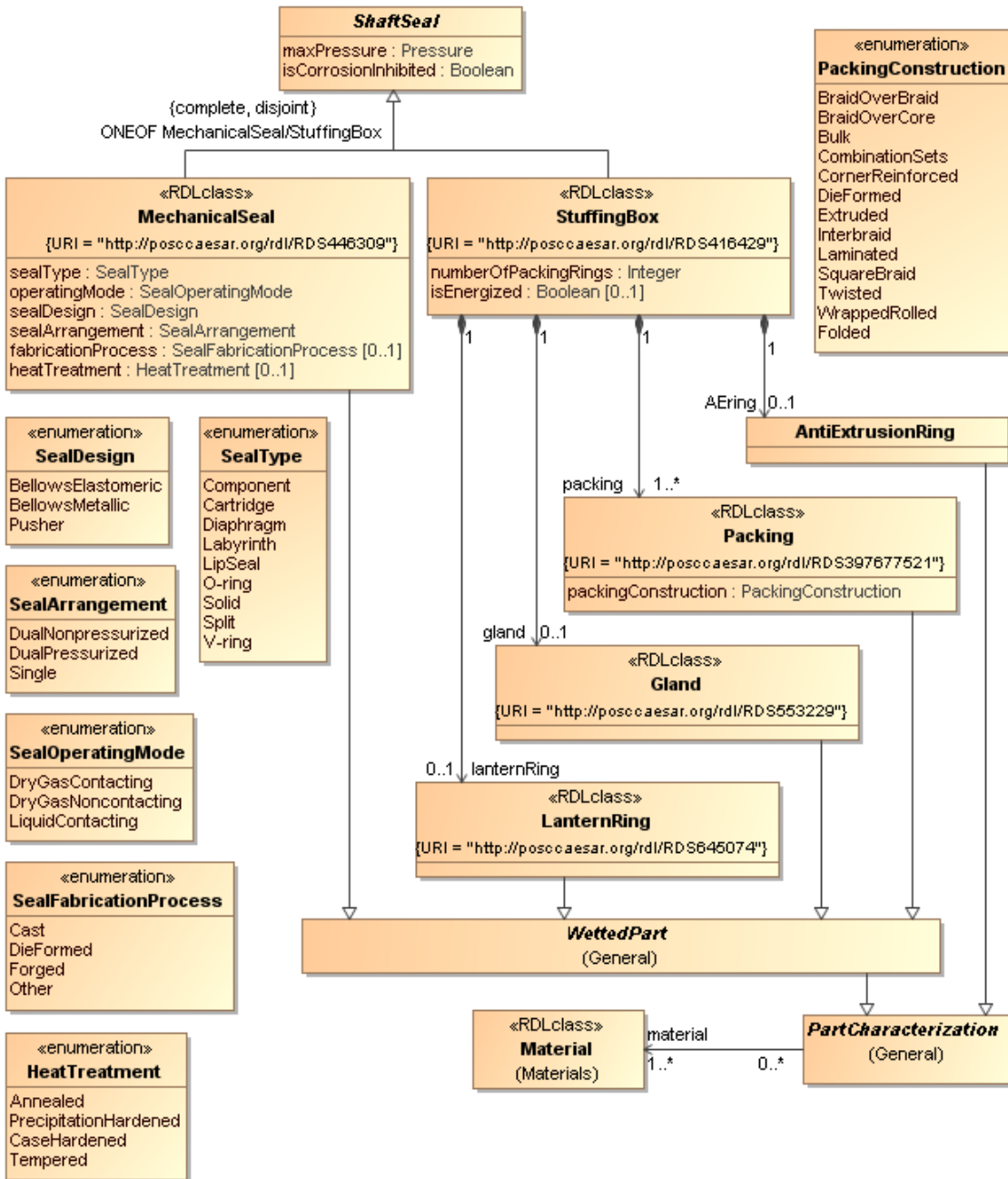

Figure 29 Shaft/stem seals

Note: The enumerated classes shown above represent the detailed “pick lists” that are used in specifying the values of ShaftSeal properties. The values are here modeled as Named Individuals, but they might be considered subclasses of seals in their own right.

The seal construction types that apply to pump shafts, which are constantly rotating, and those that apply to valve stems, which are for the most part intermittently or rarely rotated, have only some overlap, but all of the common options for both are included.

9.1 Class: AntiExtrusionRing

Definition: An optional element of a valve stuffing box that prevents the packing from being forced out between the bonnet and the stem when the valve is actuated. Depending on the design of the stuffing box, the the anti-extrusion ring may or may not be a wetted part.

SubclassOf: [General::PartCharacterization](#)

Properties

none.

Other Roles

From: [StuffingBox](#) as AERING

9.2 Class: Gland

Stereotypes: [ISO-15926:RDLclass](#)

Definition: A part of the stuffing box whose function is to position the packing and adjust the packing pressure.

Source: (Ludwig 2001)

Definition: A physical object that is applied to compress packing rings in a stuffing box.

Source: RDL, URI = <http://posccaesar.org/rdl/RDS553229>

Note: In a Valve, the most common form of Gland is the "gland nut" or "bonnet nut." The whole Stuffing Box may also be referred to as the "gland", but we use the narrower interpretation.

SubclassOf: [General::WettedPart](#)

Properties

none

Other Roles

From: [StuffingBox](#) as gland

9.3 Class: LanternRing

Stereotypes: [ISO-15926:RDLclass](#)

Definition: A ring made out of metallic or synthetic material that forms a chamber between upper and lower sets of compression packings in a stuffing box. A port from the bonnet connected with the lantern ring may have several functions: e.g., an injection chamber for a gland seal.

Source: RDL, URI = <http://posccaesar.org/rdl/RDS645074>

SubclassOf: [General::WettedPart](#)

Properties

none.

Other Roles

From: [StuffingBox](#) as lanternRing

9.4 Class: MechanicalSeal

Stereotypes: [ISO-15926:RDLclass](#)

Definition: A seal that comprises a set of one or more rotating and stationary seal faces, together with auxiliary hardware, usually separated by a film of fluid, that is intended to reduce flow loss around a rotating shaft to an acceptable level.

Source: ISO 15926 RDL, URI = <http://posccaesar.org/rdl/RDS446309>

SubclassOf: [ShaftSeal](#), [General::WettedPart](#)

Properties

ObjectProperty: fabricationProcess **Range:** [SealFabricationProcess](#)

Definition: The manufacturing process used to create the Seal. Together with heat treatment, this affects the tightness and deformation of the seal under pressure.

Cardinality: at most 1

ObjectProperty: heatTreatment **Range:** [HeatTreatment](#)

Definition: The heat treatment used in fabricating the mechanical seal, if any.

Cardinality: at most 1

ObjectProperty: operatingMode **Range:** [SealOperatingMode](#)

Definition: categorization of the mechanical seal with respect to internal lubrication.

Provided by the manufacturer. The owner can indicate a preference.

Source: HI EDE 50.7

Cardinality: exactly 1

ObjectProperty: sealArrangement **Range:** [SealArrangement](#)

Definition: categorization of the mechanical seal based on how it is sprung.

Provided by the manufacturer. The owner can indicate a preference.

Source: HI EDE 50.7

Cardinality: exactly 1

ObjectProperty: sealDesign **Range: [SealDesign](#)**

Definition: categorization of the mechanical seal based on its activation mechanism.

Provided by the manufacturer. The owner can indicate a preference.

Source: HI EDE 50.7

Cardinality: exactly 1

ObjectProperty: sealType **Range: [SealType](#)**

Definition: categorization of the mechanical seal based on the structure of the seal.

Provided by the manufacturer. It can be specified by the owner, based on knowledge of the process fluid or site conditions, usually in consultation with the supplier.

Source: HI EDE 50.7

Cardinality: exactly 1

Other Roles

none.

9.5 Class: Packing

Stereotypes: [ISO-15926:RDLclass](#)

Definition: A deformable material that is compressed into the junction between the shaft or stem and the body or casing by the gland to prevent leakage. In the case of a valve, a bonnet (a part separable from the body) may form the base for the seal.

Source: derived from multiple definitions in (Ludwig 2001) and RDL,
URI = <http://posccaesar.org/rdl/RDS397677521>

SubclassOf: [General::WettedPart](#)

Properties

ObjectProperty: packingConstruction **Range: [PackingConstruction](#)**

Definition: Structure of the packing.

Usually specified by the manufacturer, but the owner can specify the construction, based on process knowledge.

Source: HI EDE 50.7

Cardinality: exactly 1

Other Roles

From: [StuffingBox](#) as packing

9.6 Class: ShaftSeal

Definition: A means of throttling the leakage which would otherwise occur at the point of entry of a shaft or stem into the casing/body of the device. Shaft seals are of two basic kinds:

- a packing assembly or ‘stuffing box’, which seals by compressing a packing material between the shaft and the body
- a mechanical seal, which seals by using a mechanical device involving a spring or elastomer to prevent leakage

Aspects: abstract. Every ShaftSeal is either a MechanicalSeal or a StuffingBox.

Properties

DataProperty: isCorrosionInhibited **Type: [OWL::Boolean](#)**

Definition: true if the Seal is made of or treated with a substance that resists corrosion; else false.

Note: Corrosion inhibitors depend on the fluid flowing through the PlantItem. The model of corrosion inhibition is out of scope of the Product Data Sheet ontology.

Cardinality: exactly 1

ObjectProperty: maxPressure **Range: [Quantities:Pressure](#)**

Definition: The maximum fluid/gas pressure the seal is designed to withstand without leakage

Cardinality: exactly 1

Other Roles

none.

9.7 Class: StuffingBox

Stereotypes: [ISO-15926:RDLclass](#)

Definition: A means of throttling the leakage which would otherwise occur at the point of entry of the shaft into the body or casing. Usually not a separate part, but rather made up of a group of small details. Sometimes called a *gland*, properly a *gland seal*.

Source: (Ludwig 2001) and RDL, URI = <http://posccaesar.org/rdl/RDS416429>

In a pump, a seal that utilizes several coils of woven material pressed lightly against the rotating shaft to provide a minimal leakage path between the shaft and casing.

Source: ISO 15926 RDL

In a valve, a seal that uses several coils of woven material pressed tightly between components to seal the valve shaft/stem penetration through the valve body or bonnet.

Source: Wikipedia

Also RDL Packing Assembly, URI = <http://posccaesar.org/rdl/RDS11160125>, defined as: An artefact involved in a connection where packing is the main component

SubclassOf: [ShaftSeal](#)

Properties

DataProperty: isEnergized **Type: [OWL::Boolean](#)**

Definition: true if the compression mechanism that effects the seal is dynamically controlled (actuated by valve or pump control); false if the packing compression is static (like a gland nut).

Cardinality: at most 1

DataProperty: numberOfPackingRings **Type: [OWL:Integer](#)**

Definition: Number of rings of packing in the stuffing box.

Specified by the manufacturer.

Source: HI EDE 50.7

Cardinality: exactly 1

ObjectProperty: AERing **Range: [AntiExtrusionRing](#)**

Definition: The Anti-Extrusion rings included in the stuffing box, if any.

Cardinality: at most 1,composite

ObjectProperty: gland **Range: [Gland](#)**

Definition: characterization of the gland, if any, that is part of the stuffing box.

Cardinality: at most 1,composite

ObjectProperty: lanternRing **Range: [LanternRing](#)**

Definition: The characteristics of the Lantern Ring, if any, that is part of the Stuffing Box assembly.

Note: It often suffices to indicate whether or not there is one.

Cardinality: at most 1,composite

ObjectProperty: packing **Range: [Packing](#)**

Definition: characterization of the packing elements that are part of the stuffing box. The seal structure can involve multiple layers of packing, with different characteristics.

Cardinality: at least 1,composite

Other Roles

none

9.8 Enumerated Class: HeatTreatment

Definition: Heat treating is a group of industrial and metalworking processes used to alter the physical, and sometimes chemical, properties of a material. Heat treatment involves the use of heating or chilling, normally to extreme temperatures, to achieve a desired result such as hardening or softening of a material.

Named Individual Members

Member: Annealed

Definition: A heat treatment that alters a material to increase its ductility and to make it more workable.

Member: PrecipitationHardened

Definition: Precipitation hardening, also called *age hardening*, is a heat treatment technique that relies on changes in solid solubility with temperature to add fine particles of an impurity to a metal alloy, thus altering the crystal structure of the cooled metal. Precipitation hardening is used to increase the yield strength of malleable materials at high temperatures.

Member: CaseHardened

Definition: Case hardening or surface hardening is the process of hardening the surface of a metal object while allowing the metal deeper underneath to remain soft, thus forming a thin layer of harder metal (called the “case”) at the surface. For steel or iron with low carbon content, which has poor to no hardenability of its own, the case hardening process involves infusing additional carbon into the case.

Member: Tempered

Definition: Tempering is a process of heat treating, which is used to increase the toughness of iron-based alloys. Tempering is usually performed after hardening, to reduce some of the excess hardness, and is done by heating the metal to a much lower temperature than was used for hardening, maintaining the temperature to achieve a desired effect and then quickly cooling the material to increase toughness.

Other Roles

From: [MechanicalSeal](#) as heatTreatment

9.9 Enumerated Class: PackingConstruction

Definition: The structure and composition of the Packing, the way in which the packing material is formed to accomplish the seal, while minimizing friction on the rotating shaft.

Source: RDL, URI = <http://posccaesar.org/rdl/RDS11160125>

Note: The list below (from HI EDE 50.7) may not be comprehensive.

Named Individual Members

Member: BraidOverBraid

Definition: The braid-over-braid type of packing has a circular cross section. The center is sometimes composed of lead wires, which give strength to the packing and give the packing better shape-holding characteristics. The lead wires are covered with a braided jacket, which in turn is covered with another braided jacket. It is for this reason that the braid-over-braid type of packing is sometimes referred to as a jacket-over-jacket. This type of packing is also impregnated with lubricants.

Source: (Brumbach 2013)

Member: BraidOverCore

Definition: Round-braiding layers of yarns or wires over a core produces braid-over-core products. A core may be made from extruded plastic compounds, rubber, twisted yarns, or braided materials.

Member: Bulk

Definition: The packing material is loose particles or an amorphous elastomer, and is held within the stuffing box by the combination of the shaft, the gland or rings, and the casing.

Member: CombinationSets

Definition: packing that is a combination of e-PTFE and Graphite materials, braided or layered.

Source: (Girao and Guenther 2012)

Member: CornerReinforced

Definition: A type of ring packing with a corner reinforcement that fits the body or casing entrance to better distribute the load at the joint and prevent extrusion of the packing.

Source: (Muyskens 2011)

Member: DieFormed

Definition: A type of ring packing, in which the ring cross-section is created by a specially shaped die or mold.

Member: Extruded

Definition: A wire packing that implies the application of an extrusion coating. Extrusion coating is the coating of a molten web of synthetic resin onto a substrate material.

Source: (Wikipedia 2013)

Member: Interbraid

Definition: A combination of wires and/or fibres that are braided together in one or more layers to create a desired combination of strength and compressibility.

Member: Laminated

Definition: A braided wire or fibre packing that is coated with a polymer to minimize wear, or to prevent or minimize decomposition by chemical or mechanical action of the fluid.

Member: SquareBraid

Definition: Square Braid is also known as plaited braid. Yarns of various materials are processed on equipment where strands pass over and under strands running in the same direction. Resulting packings are usually supplied in square cross section but rectangular sizes can be also made in this method. The packing is usually soft and can carry a large percentage of lubricant. Square braided packings are not as harmful to equipment as wire braids and are generally used for high speed rotary services at relatively low pressures.

Source: (GHX Industrial 2013)

Member: Twisted

Definition: Twisted Packings are constructed of yarns of various materials, twisted together or around a core to obtain the desired size. One size of packing can be used for several stuffing box sizes, because of its twisted construction. Strands from a larger size can be untwisted and removed so that the remaining packing will fit a smaller size stuffing box. When metallic materials are used in the packing, they can be

made to resist high temperatures and pressures, to resist the penetration of fluids, and to conform to the irregularities of worn equipment.

Source: (GHX Industrial 2013)

Member: WrappedRolled

Definition: Packing material that is taped around the shaft in multiple thin layers, constructed of some synthetic material with a low-friction surface, or graphite, or a fine fibre that is lubricated. Commonly used on valve stems and other shafts that are not constantly rotating in service.

Member: Folded

Definition: Packing that is formed by folding a flexible sheet material into plies, and wrapping the folded sheet around the shaft. The sheet material itself can be multiple layers of different materials. Folded packing is often compressed by a sleeve.

Roles

From: [Packing](#) as PackingConstruction

9.10 Enumerated Class: SealArrangement

Definition: general categorization of mechanical seal based on whether it is sprung from one side (single) or both sides (dual), and in the latter case, whether it has an internal pumping ring to circulate the buffer fluid.

Named Individual Members

Note: In the RDL, these are subclasses of Seal, but they have no documented special properties.

Member: DualNonpressurized

Definition: A dual mechanical seal without a internal pumping ring between the seals. The circulation of buffer fluid is taken care of by an external system.

Source: RDL

Member: DualPressurized

Definition: A dual mechanical seal where a pumping ring is mounted between the two seals to boost the circulation of buffer fluid.

Source: RDL

Member: Single

Definition: A mechanical seal where the mating ring is pressed against the primary ring by the force from a single coil spring.

Source: RDL

Other Roles

From: [MechanicalSeal](#) as SealArrangement

9.11 Enumerated Class: SealDesign

Definition: general categorization of mechanical seals, based on their activation mechanism

Named Individual Members

Member: BellowsElastomeric

Definition: A mechanical seal utilizing a bellows made of a flexible elastomer to act both as pusher spring and to provide secondary sealing. The bellows compresses or extends as needed to maintain contact, while maintaining a solid elastomeric barrier between the seat ring and the casing/body.

Source: RDL

Member: BellowsMetallic

Definition: A mechanical seal utilizing flexible metallic bellows to act both as pusher spring and to provide secondary sealing.

A mechanical seal comprising a shaft ring that rotates with the shaft and a seat ring that is sprung by a metal bellows to maintain constant metal-to-metal pressure at the surfaces of the rings, sealing the shaft. The bellows compresses or extends as needed, while maintaining a solid metal barrier between the seat ring and the casing/body.

Source: RDL

Member: Pusher

Definition: A mechanical seal in which a secondary seal is pushed along the shaft or shaft sleeve to compensate for face wear.

Source: RDL

Other Roles

From: [MechanicalSeal](#) as SealDesign

9.12 Enumerated Class: SealFabricationProcess

Definition: The category of manufacturing process used to fabricate stem and shaft seals. The process affects deformability and brittleness.

Named Individual Members

Member: Cast

Definition: A manufacturing process in which a liquid material is usually poured into a mold that contains a hollow cavity of the desired shape, and then allowed to solidify.

Member: DieFormed

Definition: A manufacturing process in which the part is created by forcing a sheet of material around an incompressible "die" (or "form") using a press.

Member: Forged

Definition: A manufacturing process involving the shaping of metal using localized compressive forces. Forging is often classified according to the temperature at which it is performed: "cold", "warm", or "hot" forging.

Member: Other

Definition: none

Other Roles

From: [MechanicalSeal](#) as fabricationProcess

9.13 Enumerated Class: SealOperatingMode

Definition: general categorization of mechanical seals, based on whether they have internal lubrication or not.

Named Individual Members**Member: DryGasContacting**

Definition: A mechanical seal that is a main or back-up seal operating without liquid lubrication between its faces.

Source: RDL

Member: DryGasNoncontacting

Definition: A dry-running mechanical face seal that consists of a mating (rotating) ring and a primary (stationary) ring. When operating, grooves in the rotating ring generate a fluid-dynamic force causing the stationary ring to separate and create a gap between the two rings. Dry gas seals are mechanical seals but use other chemicals and functions so that they do not contaminate a process.

Source: (Wikipedia 2013)

Member: LiquidContacting

Definition: A mechanical seal by which the sealing medium is a liquid that forms a thin liquid film between the seal faces intended to prevent heat of friction.

Source: RDL

Other Roles

From: [MechanicalSeal](#) as OperatingMode

9.14 Enumerated Class: SealType

Definition: General categorization of mechanical seals for pump shafts, valve stems, and immersed instruments, based on the structure of the seal.

SubclassOf: none.

Named Individual Members

Member: Component

Definition: A component seal is one where each part of the seal must be assembled on the pump individually, requiring an accurate operating length, accurate center of the stationary face, protection of the seal faces, and protection of the elastomers.

Source: (Mackay 2004)

Member: Cartridge

Definition: A mechanical seal that is preassembled for sliding onto a shaft and bolting to a face.

Source: RDL

Member: Diaphragm

Definition: A diaphragm seal is a flexible membrane that seals and isolates an enclosure, allowing pressure effects to cross the barrier but not the material being contained.

Diaphragm seals are commonly used to protect pressure sensors from the fluid whose pressure is being measured.

Member: Labyrinth

Definition: A type of mechanical seal that provides a tortuous path to help prevent leakage. A labyrinth seal may be composed of many grooves that press tightly inside another axle, or inside a hole, so that the fluid has to pass through a long and difficult path to escape. Labyrinth seals on rotating shafts provide non-contact sealing action by controlling the passage of fluid through a variety of chambers by centrifugal motion, as well as by the formation of controlled fluid vortices.

Source: (Wikipedia n.d.)

Member: LipSeal

Definition: Technically not a MechanicalSeal, a LipSeal uses an elastomeric sealing element, similar to a gland packing. The mechanical element of the construction consists of a sprung main sealing lip which has a point contact with the shaft.

Source: (Wikipedia n.d.)

Member: O-ring

Definition: A mechanical gasket in the shape of a torus; it is a loop of elastomer with a round cross-section, designed to be seated in a groove and compressed during assembly between two or more parts, creating a seal at the interface. Also called a *toric joint*.

Member: Solid

Definition: A formed elastomeric material compressed between the valve stem and a sleeve that is fitted into the valve body. Primarily used on screw stems, allowing the elastomer to compress tightly around the threads.

Member: Split

Definition: A mechanical seal where the wearing parts or the whole seal can be split to make it possible to change parts without dismounting the whole machine.

Source: RDL

Member: V-ring

Definition: A V-ring seal is a one-piece flexible elastomeric seal that is mounted on a shaft (usually stretch-fit over the shaft) and seals axially against a counterface (a surface at right angles to the shaft) and normally rotates with the shaft. It is so called because the cross section is roughly V-shaped.

Other Roles

From: [MechanicalSeal](#) as SealType

From: [StructuredSeal](#) as type

10 Profile: ISO-15926

This section describes the UML Profile for ISO 15926. It provides a set of annotations for the OWL classes as depicted in UML.

It currently consists of only three annotations, the most important of which is RDLClass.

10.1 Stereotype: RDLclass

Based on: Classifier

Definition: The application of this stereotype indicates that the Class is, or corresponds to, a Reference Data Library (RDL) class in ISO 15926 Part 4 (International Organization for Standardization (ISO) 2007) and its further developments.

The significance of an RDL Class is that it has a standard URI that is assigned by one of the industry organizations maintaining the Reference Data Libraries. The stereotype attaches a UML *Tag property* called “URI” to the class, and for each such class, the proper URI value is assigned to that Tag.

Tags

Tag: URI **Type:** OWL:String

Definition: The standard Uniform Resource Identifier (URI) assigned to the Class by the industry organization maintaining the Reference Data Library.

Cardinality: exactly 1

10.2 Stereotype: colnanimatePhysicalObject

Based on: Class

Definition: The application of this stereotype indicates that the Class is a “Class of Inanimate Physical Object” per ISO 15926 Part 2 (International Organization for Standardization (ISO) 2003). That is, the instances of this class are physical things.

10.3 Stereotype: coFunctionalObject

Based on: Class

Definition: The application of this stereotype indicates that the Class is “Class of Functional Object” per ISO 15926 Part 2 (International Organization for Standardization (ISO) 2003).

ISO-15926-2 says this of `class_of_functional_object`:

A `class_of_functional_object` is a class that indicates the function or purpose of an object.

EXAMPLE Pump, valve, and car are examples of `class_of_inanimate_physical_object`. Particular models of pump, valve, car, etc are instances of `class_of_functional_object` that are specializations of these instances of `class_of_inanimate_physical_object`.

In general, we understand `class_of_functional_object` to refer to classes whose instances are specifications or designs for physical objects, rather than physical objects.

11 Ontology: PDSOntology

The PDSOntology is simply an OWL ontology that imports all of the ontologies that specialize ItemCharacterization in the General Product Data Sheet ontology – Pressure_Transmitter, Centrifugal_Pump, Valves. By extension, it includes all of the ontologies documented in this paper.

Figure 30 shows the content of the PDSOntology.

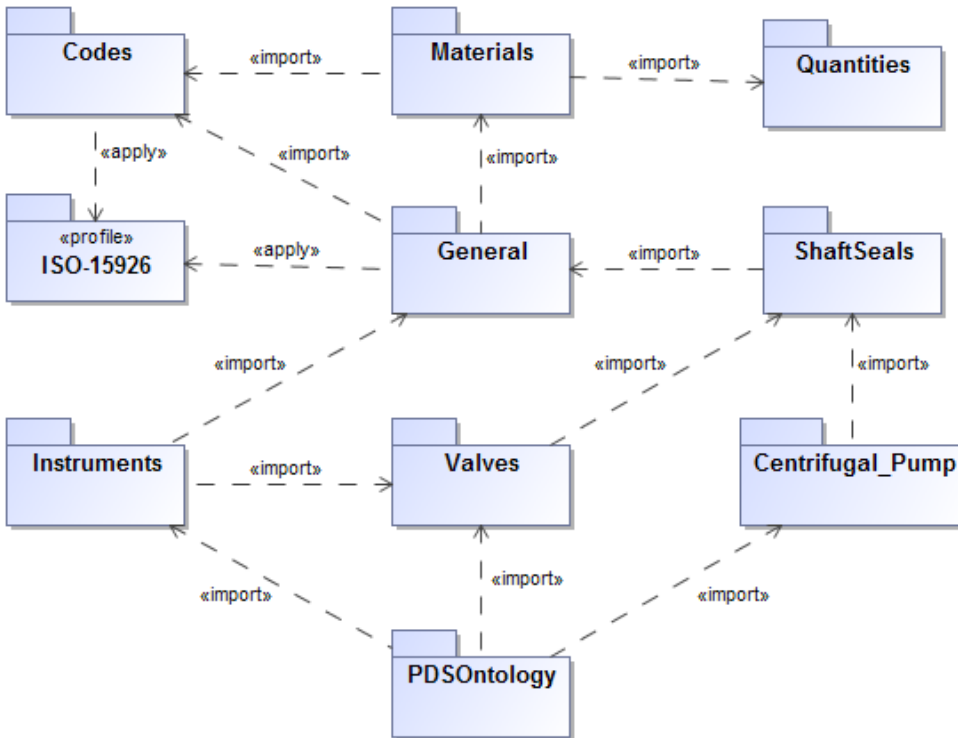

Figure 30 Overview of the PDS Ontology

Note: The above diagram only shows the module hierarchy. Each ontology implicitly imports all of the ontologies it “inherits” through the hierarchy.

Bibliography

- Alaska Government. *Introduction to Pumping Systems*. n.d. <http://dec.alaska.gov/water/opcert/Docs/Chapter6.pdf> (accessed January 2014).
- Batchelor, G.K. *An Introduction to Fluid Dynamics*. Cambridge: Cambridge University Press, 2000.
- Beardmore, Roy. *Coupling type*. n.d. http://roymechx.co.uk/Useful_Tables/Drive/Drive_Couplings.html (accessed January 2014).
- Bhatia, A. "HVAC Pump Characteristics and Energy Efficiency." *CED Engineering.com*. n.d. <http://www.cedengineering.com/upload/HVAC%20Pump%20Characteristics.pdf> (accessed September 2013).
- Bloch, Heinz P., and Abdus Shamim. *Oil Mist Lubrication: Practical Applications*. New York: Fairmont Press, 1998.
- Boca Bearing. *Radial Bearing*. 2014. <http://www.bocabearings.com/bearing-types/radial-bearings> (accessed January 2014).
- Brumbach, Michael E. and Clade, Jeffrey A. *Industrial Maintenance, 2nd Ed*. Cengage Learning, 2013.
- Capital Facilities Industry XML (cfiXML.org). "Schema Releases - Latest approved public release 4.0." *cfiXML.org*. June 29, 2011. <http://www.cfixml.org/frame.html#latestPR> (accessed September 2013).
- Centrifugal-Pump.org. "Minimum continuous stable flow." *Centrifugal-Pump.org*. n.d. http://centrifugal-pump.org/flow_stable.html (accessed September 2013).
- CP Pump Systems. "Side-channel pumps." *C-P Pump Systems*. n.d. <http://www.cp-pumps.com/en/products/technical-features/working-principles/side-channel-pump.html> (accessed January 2014).
- EnviroPump and Seal Inc. *Center-line Mount Casing*. 2012. http://enviopumpandseal.com/index.php?option=com_content&view=article&id=88:center-line-mount-casing&catid=63:technical-data&Itemid=80 (accessed January 2014).
- Evans, Joseph. "Net Positive Suction Head: NPSHR and NPSHA." *Pumps&Systems -- pump-zone.com*. May 2008. <http://www.pump-zone.com/topics/net-positive-suction-head-npsrh-and-npsa> (accessed January 2014).
- Fukazawa, T, and S Yokoyama. "United States Patent 4,676,714." *USPTO Full Text and Image Database*. December 31, 1985. access via: <http://www.google.com/patents/US4676714> (accessed January 2014).
- GHX Industrial. *Braided Packing*. 2013. <http://www.ghxinc.com/ProductsServices/Packing/Braided.htm> (accessed January 2014).
- Girao, Carlos D, and Keith Guenther. "Evaluation of Stuffing Box Forces Associated With the Thermal Expansion of e-PTFE and Graphite Packing Sets." *ASME 2012 Pressure Vessels and Piping Conference*. Toronto: ASME, 2012. 167-173.
- Green, Don, and Robert Perry. *Perry's Chemical Engineers' Handbook, Eighth Edition*. New York: McGraw-Hill Professional, 2007.
- Hydraulic Institute. *About Pumps*. n.d. http://www.pumps.org/content_detail_pumps.aspx?id=1768 (accessed September 2013).
- . *HI 50.7-2010, Standard for Electronic Data Exchange for Pumping Equipment*. Parsippany, NJ: Hydraulic Institute, 2010.

- *Rotary Pumps (ANSI/HI 3.1-3.5)*. Parsippany, NJ: Hydraulic Institute, 2008.
- *Rotodynamic (Centrifugal) Pumps for Nomenclature and Definitions (ANSI/HI 1.1-1.2)*. Parsippany NJ: Hydraulic Institute, 2008.
- *Rotodynamic (Vertical) Nomenclature (ANSI/HI 2.1-2.2)*. Parsippany, NJ: Hydraulic Institute, 2008.
- Inpro-seal. *Permanent Bearing Protection: The Original Bearing Isolator*. 2014. http://www.inpro-seal.com/en_US/system-and-bearing-protection/permanent-bearing-protection/ (accessed January 2014).
- International Bureau of Weights and Measures (BIPM). *International vocabulary of metrology -- basic and general concepts and associated terms (VIM), edition 3*. Geneva: International Bureau of Weights and Measures, 2012.
- International Electrotechnical Commission (IEC). *IEC 61508, Functional safety of electrical/electronic/programmable electronic safety-related systems -- Part 4 Definitions and abbreviations*. Geneva: International Electrotechnical Commission, 2010.
- International Electrotechnical Commission (IEC). *IEC 61511-1, Functional safety – Safety instrumented systems for the process industry sector – Part 1: Framework, definitions, system, hardware and software requirements*. Geneva: International Electrotechnical Commission, 2003.
- International Electrotechnical Commission (IEC). *ISO/IEC Guide 28 Ed. 2: Conformity assessment -- Guidance on a third-party certification system for products*. Geneva: International Electrotechnical Commission, 2004.
- International Organization for Standardization (ISO). *ISO 10303-227: Industrial automation systems and integration -- Product data representation and exchange -- Part 227: Application protocol: Plant spatial configuration*. Geneva: International Organization for Standardization, 2005.
- *ISO 15926-2:2003, Industrial automation systems and integration -- Integration of life-cycle data for process plants including oil and gas production facilities -- Part 2: Data model*. Geneva: International Organization for Standardization, 2003.
- *ISO/TS 15926-4:2007, Industrial automation systems and integration -- Integration of life-cycle data for process plants including oil and gas production facilities -- Part 4: Initial reference data*. Geneva: International Organization for Standardization, 2007.
- Karassik, Igor J, and Terry McGuire. "Special Effect Pumps." In *Centrifugal Pumps*, 352-366. Springer US, 1997.
- Kempchen. "Ring-Joints RTJ." n.d. http://www.specs.co.kr/eng/skin/downloadfile/sealing_products/GASKET/METALLIC/Ring%20Joints%20RTJ.pdf (accessed January 2014).
- Khonsari, M. and Booser, E. "Guidelines for Oil Mist Lubrication." *Machinery Lubrication*, September 2005.
- Ludwig, Ernest E. *Applied Process Design for Chemical and Petrochemical Plants, Third Edition*. Houston: Gulf Professional Publishing, 2001.
- Mackay, Ross C. *The Practical Pumping Handbook*. Elsevier, 2004.
- Merriam-Webster. "fluid." *Merriam-Webster Online*. 2014. <http://www.merriam-webster.com/dictionary/fluid> (accessed January 2014).
- Muyskens, David B. Corner reinforcement. United States of America Patent US20110278310 A1. November 17, 2011.

- Object Management Group. "Unified Modeling Language (UML)." 2011.
<http://www.omg.org/spec/UML/2.4.1/> (accessed September 2013).
- Patterson Pump Company. "Patterson Operation & Maintenance Manual for Vertical Inline Pumps." Toccoa, 1999.
- PDHengineer.com. "Pumps - Types and Selection." *PDHengineer.com*. 2012.
<http://www.pdhengineer.com/catalog/preview/M-1001.pdf> (accessed January 2014).
- POSC Caesar Association. "Reference Data Services." *POSC Caesar Association*. November 22, 2013.
<https://www.posccaesar.org/wiki/Rds> (accessed January 2014).
- Pump Fundamentals. *PUMP AND PUMP SYSTEM GLOSSARY*. n.d.
http://www.pumpfundamentals.com/pump_glossary.htm (accessed September 2013).
- PumpSchool. "Understanding Net Positive Suction Head." *PUMPSCHOOL.COM*. 2007.
<http://www.pumpschool.com/applications/NPSH.pdf> (accessed September 2013).
- PumpScout. *20 pump industry terms you should know*. n.d. <http://www.pumpscout.com/articles-scout-guide/20-pump-industry-terms-you-should-know-aid64.html> (accessed September 2013).
- Roth Pump Company. "Little Pump – Big Head." *Roth Pump Company*. n.d.
<http://www.rothpump.com/regenerative-turbine-pump-little-pump-big-head.html> (accessed January 2014).
- Sheehan, K. "United States Patent 5,857,842." *USPTO Full-Text and Image Database*. June 16, 1997.
 access via: <http://www.google.com/patents/US5857842> (accessed January 2014).
- Specialty Graphic Imaging Association (SGIA). *GLOSSARY of Specialty Printing & Imaging Technologies*. n.d. http://www.sgia.org/training_and_education/glossary/Pp.cfm (accessed September 2013).
- Tile Council of North America. *Epoxy Grout*. 2014. <https://www.tcnatile.com/faqs/37-epoxy-grout.html#faq26> (accessed January 2014).
- . *Polymer-Modified Mortar*. 2014. <https://www.tcnatile.com/faqs/66-polymer-modified-mortar.html> (accessed January 2014).
- T-MAG Pumps. "What is an Industrial Pump?" *T-Mag Mag Drive Pumps*. n.d.
<http://www.tmagpumps.com/what-is-an-industrial-pump> (accessed January 2014).
- Wikipedia. *Bingham plastic*. n.d. (accessed September 2013).
- . "Centrifugal Pump." *Wikipedia*. n.d.
http://en.wikipedia.org/wiki/Centrifugal_pump#Vertical_centrifugal_pumps (accessed January 2014).
- . *Coupling*. n.d. http://en.wikipedia.org/wiki/Gear_coupling#Gear (accessed September 2013).
- . *Dilatant*. n.d. <http://en.wikipedia.org/wiki/Dilatant> (accessed September 2013).
- . *Disc coupling*. n.d. (accessed September 2013).
- . *Dry gas seal*. July 2013. http://en.wikipedia.org/wiki/Dry_gas_seal (accessed January 2014).
- . *Extrusion Coating*. December 24, 2013. http://en.wikipedia.org/wiki/Extrusion_coating (accessed January 2014).
- . *Labyrinth Seal*. n.d. http://en.wikipedia.org/wiki/Labyrinth_seal (accessed January 2014).
- . *Non-shrink grout*. June 19, 2013. http://en.wikipedia.org/wiki/Non-shrink_grout (accessed January 2014).

- *NPSH*. n.d. <http://en.wikipedia.org/wiki/NPSH> (accessed September 2013).
 - "Pressure measurement." *Wikipedia*. n.d. http://en.wikipedia.org/wiki/Pressure_measurement (accessed January 2014).
 - *Radial shaft seal*. n.d. http://en.wikipedia.org/wiki/Radial_shaft_seal (accessed January 2014).
 - *Spacer coupling*. n.d. http://en.wikipedia.org/wiki/Spacer_coupling (accessed September 2013).
 - *Stuffing box*. n.d. http://en.wikipedia.org/wiki/Stuffing_box (accessed September 2013).
 - *Thixotropy*. n.d. <http://en.wikipedia.org/wiki/Thixotropy> (accessed September 2013).
 - *Thrust bearing*. January 6, 2014. http://en.wikipedia.org/wiki/Thrust_bearing (accessed January 2014).
- World Wide Web Consortium. "OWL 2 Web Ontology Language Structural Specification and Functional-Style Syntax (Second Edition)." 2012. <http://www.w3.org/TR/owl2-syntax/> (accessed September 2013).