

NAT'L INST. OF STAND & TECH



A11106 059146

**NBSIR 86-3331**

# **HVACSIM<sup>+</sup> Building Systems and Equipment Simulation Program: Building Loads Calculation**

---

**Reference**

**NBS  
PUBLICATIONS**

Cheol Park  
Daniel R. Clark  
George E. Kelly

U.S. DEPARTMENT OF COMMERCE  
National Bureau of Standards  
National Engineering Laboratory  
Center for Building Technology  
Building Equipment Division  
Gaithersburg, MD 20899

February 1986

QC

100

.U56

86-3331

1986

**Buildings and Community Systems  
Department of Energy  
Engineering Laboratory  
Department of Defense**



NBSIR 86-3331

• • •

**HVACSIM<sup>+</sup> BUILDING SYSTEMS AND  
EQUIPMENT SIMULATION PROGRAM:  
BUILDING LOADS CALCULATION**

---

OC  
100  
456  
86-3331  
1986

Cheol Park  
Daniel R. Clark  
George E. Kelly

U.S. DEPARTMENT OF COMMERCE  
National Bureau of Standards  
National Engineering Laboratory  
Center for Building Technology  
Building Equipment Division  
Gaithersburg, MD 20899

February 1986

Sponsored by:  
Office of Buildings and Community Systems  
U.S. Department of Energy

Naval Civil Engineering Laboratory  
U.S. Department of Defense



---

**U.S. DEPARTMENT OF COMMERCE, Malcolm Baldrige, *Secretary***  
**NATIONAL BUREAU OF STANDARDS, Ernest Ambler, *Director***



## ABSTRACT

A non-proprietary building system simulation program called HVACSIM<sup>+</sup>, which stands for HVAC SIMulation PLUS other systems, has been developed at the National Bureau of Standards (NBS) in an effort to understand the dynamic interactions between a building shell, an HVAC system, and building controls. HVACSIM<sup>+</sup> consists of a main simulation program, a library of HVAC system component models, a building shell model, and interactive front end input data generation programs.

The main simulation program employs a hierarchical, modular approach and advanced equation solving techniques to perform dynamic simulations of building/HVAC/control systems. In the building shell model, a fixed time step selected by the user is employed, while a variable time step approach is used in the HVAC and control systems portion of a simulation and the zone model.

This report presents the overall architecture of the HVACSIM<sup>+</sup> program, algorithms used in the main simulation program, a brief discussion of the numerical methods used in solving a system of non-linear simultaneous equations, integrating stiff ordinary differential equations and interpolating data and descriptions of the building shell and zone models. Conduction transfer functions, weather data, and simulation procedure are also described. This report is the third document, which describes the building model, supplied with HVACSIM<sup>+</sup>.

Key words: building dynamics; building simulation; building system modeling; computer simulation programs; control dynamics; dynamic modeling of building systems; dynamic performance of building systems; dynamic simulations; HVAC system simulations; HVACSIM<sup>+</sup>

## ACKNOWLEDGEMENTS

The authors are indebted to the Building Systems Division, U.S. Department of Energy, and the Naval Civil Engineering Laboratory, U.S. Department of Defense, for funding this project, and gratefully acknowledge Dr. C. Ray Hill for his original work of the main simulation program, MODSIM, during a year at NBS as a research associate, Mr. George N. Walton for his helpful suggestions, and Mr. William B. May, who directed the development of the front end program HVACGEN and provided hardware and software support for this project. Valuable contributions in developing HVACSIM<sup>+</sup> were made by Mr. Scott Hildebrand, Mr. David Harris, Mr. Chris Rasmussen, and Mr. Juan Lopez, who were visiting workers at NBS. The authors thank Mrs. Janet I. Clark for typing this report.

## DISCLAIMER

The program described in this report is furnished by the government and is accepted and used by any recipient with the express understanding that the United States Government makes no warranty, expressed or implied, concerning the accuracy, completeness, reliability, usability, or suitability for any particular purpose of the information and data contained in this program or furnished in connection therewith, and the United States shall be under no liability whatsoever to any person by reason of any use made thereof. This program belongs to the government. Therefore, the recipient further agrees not to assert any proprietary rights therein or to represent this program to anyone as other than a government program.

## TABLE OF CONTENTS

ABSTRACT.....	iii
ACKNOWLEDGMENTS.....	iv
DISCLAIMER.....	iv
LIST OF FIGURES.....	vii
1. INTRODUCTION.....	1
2. ARCHITECTURE OF HVACSIM <sup>+</sup> .....	3
3. MODULAR SIMULATION PROGRAM, MODSIM.....	8
3.1 Hierarchical, Modular Approach.....	8
3.2 Controls of State Variables and Blocks.....	10
3.3 Hybrid Simulation Time Steps.....	11
3.4 Time Dependent Boundary Conditions.....	12
4. NUMERICAL METHODS USED IN MODSIM.....	14
4.1 Nonlinear Equation Solver.....	14
4.2 Integration of Stiff Ordinary Differential Equations.....	17
4.3 Interpolation of Data.....	23
5. BUILDING LOADS CALCULATION.....	25
5.1 TYPE 50: Zone Envelope.....	27
5.2 TYPE 51: Building Surface.....	31
5.3 TYPE 52: Zone Model.....	39
5.4 TYPE 53: Weather Input.....	46
6. UTILITY ROUTINES FOR BUILDING LOADS CALCULATION.....	48
6.1 Properties of Moist Air.....	48
6.2 Air Exchange Rate.....	49
6.3 MRT View Factors.....	49
6.4 Heat Transfer Coefficients.....	50
7. CONDUCTION TRANSFER FUNCTION CALCULATION.....	53
7.1 Overview of CTFGEN.....	53
7.2 Heat Conduction of a Multilayered Construct.....	54
7.3 Response Factors.....	58
7.4 Conduction Transfer Functions.....	61

8.	WEATHER DATA.....	64
8.1	Weather Tape Reading Routine.....	64
8.2	Weather Data File Generation.....	65
9.	SIMULATION PROCEDURE.....	73
9.1	Preprocessing - Input Data Generation.....	73
9.2	Simulation.....	76
9.3	Postprocessing - Output Data Analysis.....	76
10.	REFERENCES.....	77
APPENDIX A:	Short Descriptions of Functions and Subroutines in HVACSIM <sup>+</sup> .....	81
APPENDIX B:	Worksheets for Data Entry for Type 50, 51, 52, and 53....	94
APPENDIX C:	Example 1 - One-Zone Building Model.....	98
APPENDIX D:	Example 2 - Three-Zone Building Model.....	150



## LIST OF FIGURES

Figure 1	Flow diagram of programs and data files of HVACSIM <sup>+</sup> .....	4
Figure 2	The structure of MODSIM.....	6
Figure 3	Hierarchical simulation setup.....	9
Figure 4	Simplified flow diagram for the iterative procedure in solving simultaneous, nonlinear equations.....	18
Figure 5	Simplified flow chart of the algorithm for integration of stiff ordinary differential equations.....	22
Figure 6	A multilayer construct.....	57



## 1. INTRODUCTION

Computer simulations have been a popular means of analyzing building energy use. Compared with experimental investigations, computer simulations do not require installation of various expensive instruments. Simple changes in input data to a simulation model can evaluate their impacts on the model.

In an effort to carry out simulation studies involving the dynamic interactions between a building shell, an HVAC system, and building controls, a non-proprietary building system simulation program called HVACSIM<sup>+</sup> has been developed at the National Bureau of Standards (NBS). The program HVACSIM<sup>+</sup>, which stands for HVAC SIMulation PLUS other systems, is capable of modeling the HVAC (heating, ventilation, and air-conditioning) system plus HVAC controls, the building shell, the heating/cooling plant, and energy management and control systems (EMCS) algorithms. Although the current version of the HVACSIM<sup>+</sup> has not implemented the EMCS algorithms yet, these may be added by a user interested in such applications, and familiar with Fortran programming.

The HVACSIM<sup>+</sup> consists of a main simulation program, a library of HVAC system components models, a building shell model, and interactive front end data generation programs. The main program is called MODSIM and employs a hierarchical, modular approach and advanced equation solving techniques to perform dynamic simulations of building/HVAC/control systems. The modular approach is based upon the methodology used in the TRNSYS program [1]. In the building shell model, a fixed (but user selectable) time step method is used, while a variable time step approach is employed in the HVAC and control

systems portion and the zone model. This hybrid time step method is believed to be unique in the building systems programs.

The HVACSIM<sup>+</sup> program has been developed primarily as a research tool for whole building system studies. Flexibility of the HVACSIM<sup>+</sup> allows the simulation of HVAC components, control systems, the building shell, or any combination. The program is written in ANSI Standard Fortran 77. Fully structured programming makes the code relatively easy for programmers to understand and maintain.

Some important features of HVACSIM<sup>+</sup> were previously introduced [2,3] and the results of some case studies were published [4,5]. A general overview of HVACSIM<sup>+</sup> was also presented [6]. Documentation for HVACSIM<sup>+</sup> consists primarily of three publications: a Reference Manual [7], a Users Guide [8], and this report. The building loads calculation routines are relatively recent additions to HVACSIM<sup>+</sup>, and as such are not described in the Reference Manual or the Users Guide. This report serves as reference manual and users guide for the building load portions of HVACSIM<sup>+</sup>. In addition, mathematical details of the numerical methods used in HVACSIM<sup>+</sup> are presented. Sample simulations for building load calculations are appended.

## 2. ARCHITECTURE OF HVACSIM<sup>+</sup>

The various portions of HVACSIM<sup>+</sup> can be divided into three categories: preprocessing, simulation, and postprocessing. Prior to performing a simulation, the data files for a particular building system simulation must be provided. This can be accomplished using programs in the preprocessing group. After a simulation, evaluation of outputs from the simulation is made using the postprocessing program.

Figure 1 shows a flow diagram of programs and data files comprising HVACSIM<sup>+</sup>. During the preprocessing, a work file for simulation is created by the interactive front end program, HVAOGEN [8]. This work file is then converted into the model definition file by the program SLIMCON. The model definition file has the format which the main program MODSIM requires. The work file can be edited interactively by the HVAOGEN program. In generating the simulation work file, HVAOGEN employs a data file containing component model information.

When a building shell is involved in a simulation, data files of weather conditions and conduction transfer functions for multilayered constructs must also be created. The program RDTAPE reads a weather tape (SOLMET, TMY, TRY, or WYEC tape) or equivalent and selects a portion of the weather data that is of interest. The selected weather data is transformed into the proper input form for MODSIM by the program CRWDTA. If a weather tape is not available or information from a weather tape is missing, the CRWDTA program produces a design day weather data file.

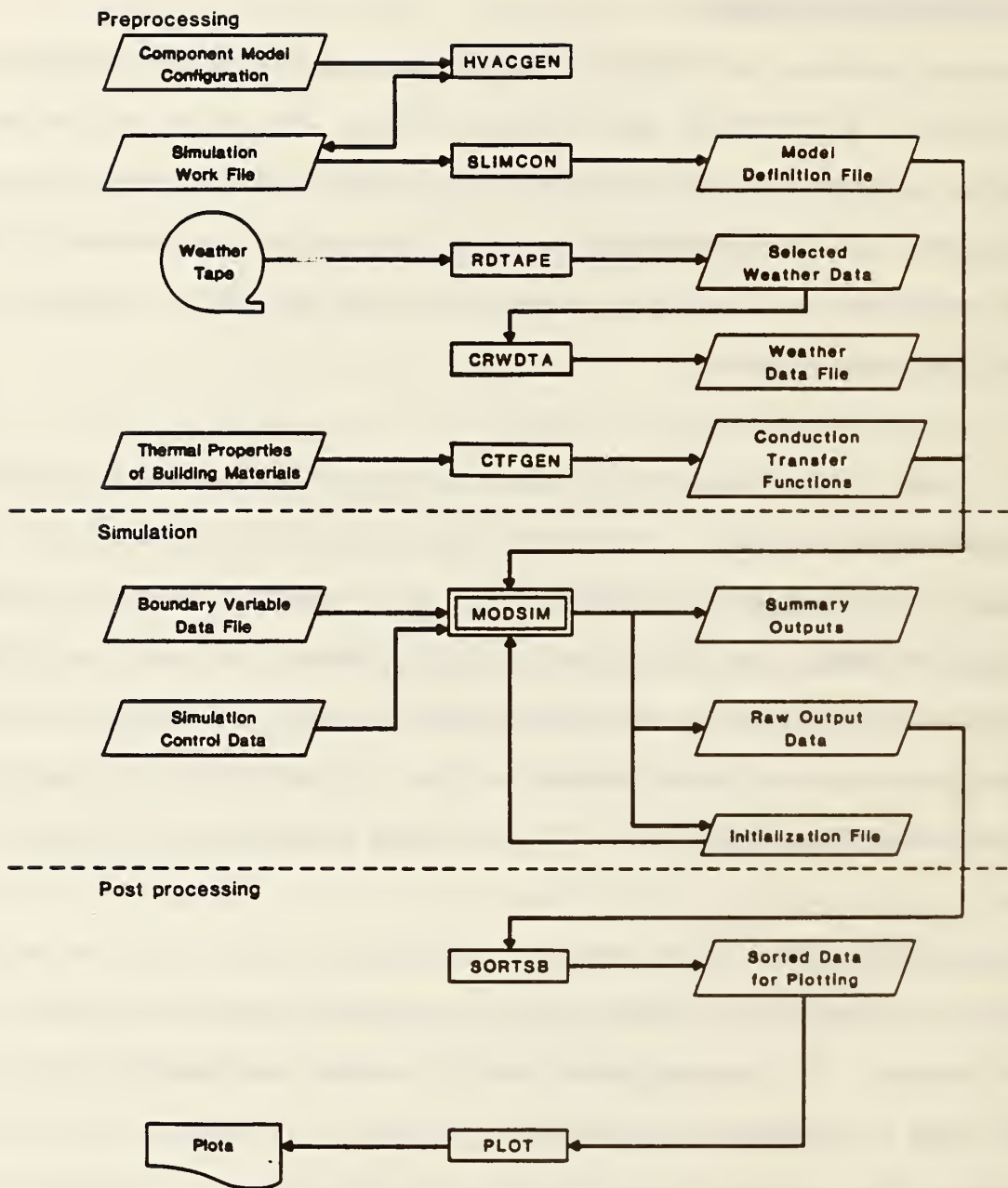

Figure 1. Flow diagram of programs and data files of HVACSIM<sup>+</sup>

The conduction transfer functions of multilayered building constructs are generated by the CTFGEN program. Except for the front end routines of CTFGEN the main routines in CTFGEN are taken from the TARP program by Walton [9]. The thermal properties of building materials (thickness, thermal conductivity, density, specific heat, and thermal resistance) can be entered into the data bank by using CTFGEN and multilayered constructs can be formed interactively.

The MODSIM program is the heart of HVACSIM<sup>†</sup>. As shown in Figure 2, the MODSIM program consists of a main drive program and many subprograms for input/output operation, block and state variable status control, integration of stiff ordinary differential equations, solving of a system of simultaneous non-linear algebraic equations, component models of HVAC, controls, building model, and supporting utility.

The simulation program, MODSIM, calls the model definition, conduction transfer functions, weather, and boundary data files. The boundary data file can be created with a conventional editor. The state variables associated with this boundary data file are assigned when HVACGEN generates the work file for a particular simulation.

During the execution of MODSIM, simulation control input data can be entered interactively on a terminal. After a successful simulation, three data files are generated. These are the summary, raw output, and initialization data files. After renaming the initialization file as the input file to MODSIM, a

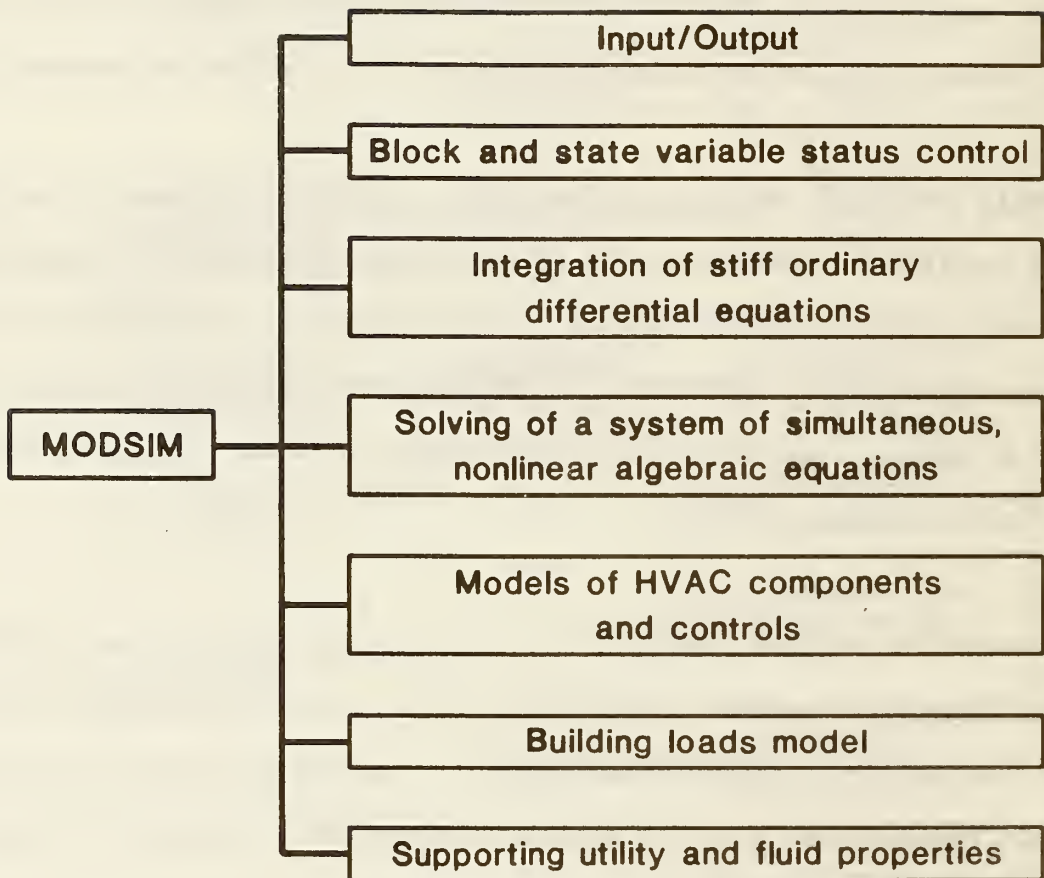

Figure 2. The structure of MODSIM



new simulation can be performed starting from the point where the previous simulation ended.

Postprocessing is necessary if graphical presentation of the raw outputs is desired. The program, SORTSB, sorts the raw output data. The outputs of these programs may then be used for plotting with a user-supplied graphic routine.

It should be noted that the architecture of HVACSIM<sup>+</sup> had been changed after the overview paper [6] was presented.

### 3. MODULAR SIMULATION PROGRAM, MODSIM

MODSIM stands for MODular SIMulation. Many ideas for the design of MODSIM came from the TRNSYS program, which was developed at the University of Wisconsin Solar Energy Laboratory [1]. The original MODSIM was first written in Fortran IV by Hill [3]. Since then, MODSIM has been rewritten in structured Fortran 77 and modified significantly. Important features of the current MODSIM program are described below.

#### 3.1 Hierarchical, Modular Approach

A hierarchical simulation setup data file (model definition file) is employed by MODSIM during a simulation. The hierarchical structure comprises superblocks, blocks, and units. As illustrated in Figure 3, a number of units (or a single unit) form a block, and a number of blocks (or a single block) make up a superblock. Superblocks (or a single superblock) comprise a simulation. Figure 3 shows a setup involving 8 units, 4 blocks, and 2 superblocks. Depending upon the status of the state variables in a block or superblock, a system of equations in a block or in a superblock are solved simultaneously. The coupling of superblocks is done weakly through the state variables. In the interest of economy the whole simulation made up of superblocks is not solved simultaneously.

Using a modular approach, a UNIT in MODSIM represents a component model of a HVAC system, controls, or a building shell component. Each physical component is modeled in the subroutine TYPE $n$ , where  $n$  is the index number of the type

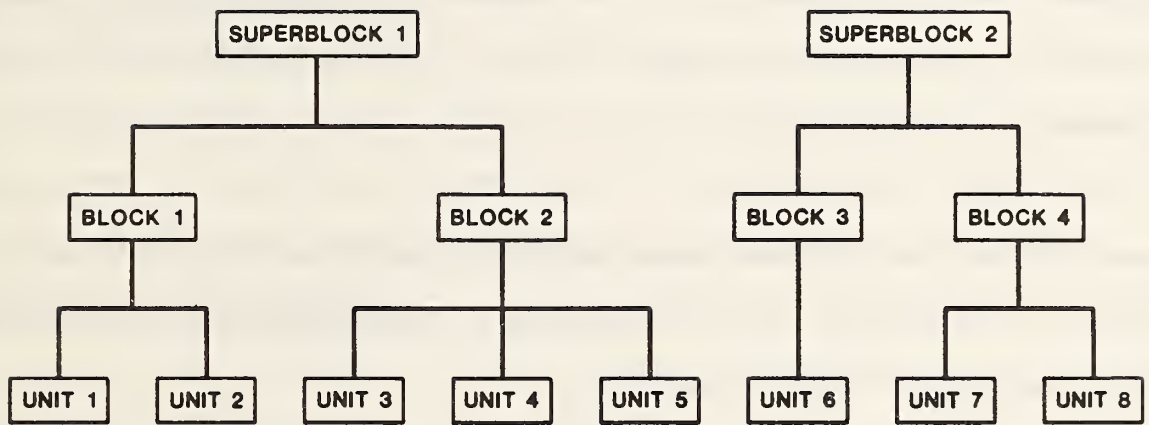

Figure 3. Hierarchical simulation setup

assigned to the specific component. More than one unit can call the same TYPE $n$  subroutine if the same component model is used more than once. For example, if UNIT 2 and UNIT 4 in Figure 3 represent two different fans in the HVAC system, the same TYPE1 subroutine for a fan ( $n=1$ ) can be used in the simulation. Each subroutine of component model has inputs, outputs, parameters, and a workspace vector for saving intermediate results. The component model configuration data file, which is an input file to the HVAAGEN program, contains information on the numbers of inputs, outputs, parameters, elements in the saved workspace vector, and a description of the inputs, outputs, and parameters.

Each UNIT has its distinct index number for input and output variables, and values of parameters. This information is transmitted to the corresponding TYPE $n$  subroutine through arguments.

This hierarchical, modular approach provides great flexibility in setting up a simulation model. The actual breakdown of a building system into blocks and superblocks is left to the user and depends upon the nature of the system and the type of interactions among its various components. Proper 'blocking' produces good simulation results and reduces computational time. Improper 'blocking' of a simulation model can result in a poor simulation.

### 3.2 Controls of State Variables and Blocks

During a simulation, a large portion of time is spent in solving the system of simultaneous equations. Reduction of the number of equations solved

simultaneously in a block or a superblock can result in considerable computational savings. In MODSIM, when some of the state variables reach steady state, these variables are removed from the system of state variables that are solved simultaneously, and put aside (or 'frozen') until deviations from the steady-state values are encountered. The criterion for freezing a variable is chosen as

$$\left| x_{n+1} - x_n \right| \leq \frac{1}{2} \left[ e_r \left| x_{n+1} \right| + e_a \right], \quad (3.1)$$

where  $x_{n+1}$  and  $x_n$  are the state variables at the current and the previous time, and  $e_r$  and  $e_a$  are the relative and the absolute error tolerance, respectively. These error tolerances must be specified when the simulation work file is created using HVACGEN.

Similarly, a block can be inactivated (or frozen) if all the input variables to the block are frozen. A block is marked active as soon as one of its block inputs becomes unfrozen. When a block is frozen, it is no longer necessary to monitor the frozen state variables in the block.

### 3.3 Hybrid Simulation Time Steps

The MODSIM program incorporates two different types of time steps. One of them is a fixed time step, and the other is a variable time step. The building shell model uses a user-selected fixed time interval because the building shell model needs the conduction transfer functions of building constructs which are calculated on the basis of uniformly distributed time

sampling. In addition, weather data is usually provided on the hourly basis. Variable time steps are used for all other component models.

This multi-time step approach has its advantage in saving computation time. Many component models for HVAC and controls systems involve ordinary differential equations. When the system is unsteady, a large time step invites numerical instability. To prevent this instability, small time intervals are necessary at an initial startup of a simulation or during a period when sudden change occurs. After the system becomes stabilized, the use of short time step is no longer needed and is wasteful.

Each superblock in a simulation is an independent subsystem in the sense that it proceeds forward in time independently. The variable time step is determined for each superblock, excluding the superblock for the building shell, by the integration routine used to solve the systems of differential equations. The largest time step allowed in a superblock is, however, limited to the fixed time step used in the building shell model.

### 3.4 Time Dependent Boundary Conditions

A state variable which is external to the system being simulated can be designated as a boundary variable when the simulation work file is generated. The boundary variables may be constant or time dependent. Data at the boundary variables are stored in the boundary data file and read as the simulation progresses. Time intervals in this data file are not required to

be equal, since a third order Lagrangian interpolation method is used. Sometimes a change in a boundary variable may be discontinuous (e.g., set point change). In such cases, the integration routine of differential equations is reset at the time of discontinuity to bring the simulation time step to a minimum value. This kind of reset condition is signaled by including in the boundary data file two different data values of a boundary variable at a given time.

#### 4. NUMERICAL METHODS IN MODSIM

The numerical methods employed in the MODSIM program involve techniques for solving systems of simultaneous nonlinear algebraic equations, integrating stiff ordinary differential equations, and interpolating data sampled in either a fixed period or variable time intervals. A large number of subprograms in the MODSIM are related to these numerical algorithms.

##### 4.1 Nonlinear Equation Solver

The subroutine SNSQ with its associate subprograms is used in MODSIM. This routine is a part of the mathematical software package SNLSE in the CMLIB package, NBS [10], and was coded by Hiebert at Sandia National Laboratories by combining the HYBRD and HYBRDJ in the MINPACK code developed by Argonne National Laboratories [11]. The method used in the SNSQ program is based on Powell's hybrid method [12]. Minor modifications were made to the SNSQ routine to achieve better simulations with HVACSIM<sup>+</sup>.

A brief mathematical description of the SNSQ routine is presented following closely the approach used in the paper by Hiebert [11].

The system of nonlinear equations can be written in vector form as

$$\underline{f}(\underline{x}) = \underline{0} \quad (4.1)$$

where

$$\underline{f} = [f_1, f_2, \dots, f_n]^T, \quad \underline{x} = [x_1, x_2, \dots, x_n]^T \quad (4.2)$$

Expanding  $\underline{f}$  in a Taylor series, and neglecting the high order terms, the



linearized, approximate system becomes

$$\underline{f}(\underline{x}^*) \approx \underline{f}(\underline{x}^k) + J(\underline{x}^k) (\underline{x}^* - \underline{x}^k) \quad (4.3)$$

where  $J(\underline{x}^k)$  is a Jacobian evaluated at  $\underline{x}^k$ .

If  $\underline{x}^*$  is the solution vector of the system, then

$$\underline{f}(\underline{x}^*) = 0.$$

The general iteration equation for given  $\underline{x}^k$  near  $\underline{x}^*$  becomes

$$\underline{x}^{k+1} = \underline{x}^k - J^{-1}(\underline{x}^k) \underline{f}(\underline{x}^k). \quad (4.4)$$

The Newton step of the nonlinear system,  $\Delta \underline{x}$ , can be expressed as

$$\Delta \underline{x} = \underline{x}^{k+1} - \underline{x}^k = -J^{-1}(\underline{x}^k) \underline{f}(\underline{x}^k) \quad (4.5)$$

In efforts to reduce the number of calculations involved with this approach, a quasi-Newton method is used in SNSQ. This method approximates the Jacobian using the Broyden's rank-one update [13] instead of calculating the full Jacobian at each iteration. The Jacobian is calculated at the starting point by either the user-supplied subroutine or a forward-difference approximation, but it is not recalculated until the rank-one method fails to give satisfactory progress. If  $B_k$  is the approximation of the Jacobian at the  $k$ th iteration, then the updated Jacobian [14] is

$$B_{k+1} = B_k - (B_k \underline{q}_k - \underline{v}_k) \underline{q}_k^T / \underline{q}_k^T \underline{q}_k, \quad (4.6)$$

where  $\underline{q}_k = \underline{x}^{k+1} - \underline{x}^k$ ,  $\underline{v}_k = \underline{f}(\underline{x}^{k+1}) - \underline{f}(\underline{x}^k)$ , and  $\underline{q}_k^T$  is the transpose of  $\underline{q}_k$ . In the SNSQ routine, the inverse Broyden update is employed. With the inverse Broyden update method, the inverse of the approximate Jacobian,  $B_k^{-1}$  is stored and updated at each iteration.

The local convergence of the quasi-Newton method is superlinear, and required arithmetic operation per iteration is only  $O(n^2)$ , while the number of function evaluations per iteration is also only  $n$ . The shortcoming of the quasi-Newton method is that a good initial guess must be made for successful convergence. To improve this property, Powell [12] suggested a hybrid method.

The hybrid step is a combination of the quasi-Newton and gradient step. The gradient step is chosen to minimize the Euclidean norm of the residuals. The Gauss-Newton [15] and the steepest scaled gradient steps are actually incorporated in the SNSQ routine. The convergence test is successful so that  $\underline{x}^k$  is a solution vector if the following condition is satisfied:

$$||d_k (\underline{x}^{k+1} - \underline{x}^k)|| \leq e_t ||d_1 \underline{x}^k|| \quad (4.7)$$

or if  $\underline{f}(\underline{x}) = 0$ . In the above equation,  $d_k$  is the diagonal component of the transformed Jacobian matrix using QR-factorization,  $e_t$  is the error tolerance usually specified by the user, and the double bars denote the norms. In HVACSIM<sup>+</sup>, the value of  $e_t$  is specified when the model definition file is created by the HVACGEN front-end program. Although the square-root of the machine precision [16] is recommended for the value of  $e_t$  in the SNSQ routine, the choice of the value depends upon the particular simulation setup and its initial values. As a rule of thumb,  $e_t$  may be greater than or equal to the sum of  $e_r$  and  $e_a$ .

The block/superblock structures, defined when a simulation setup is made, also strongly influence the convergence characteristics. Even though the use of hybrid step improves the convergence properties, making a good guess for

initial conditions is very important to ensure a successful simulation.

As an example, Figure 4 shows the simplified flow diagram for the iterative procedure when  $x_1$  and  $x_2$  are solved simultaneously and  $x_3$  and  $x_4$  remain constant at a time step. In the TYPE subroutines for two units in a block,  $x_1'$  and  $x_2'$  are determined using the function  $F_1$  and  $F_2$ , respectively. Residual functions can be written as

$$\begin{aligned} f_1(x_1, x_2, x_3, x_4) &= x_1' - x_1 = F_1(x_2, x_3) - x_1 \\ f_2(x_1, x_2, x_3, x_4) &= x_2' - x_2 = F_2(x_1, x_4) - x_2 \end{aligned} \quad (4.8)$$

These function vectors,  $f_1$  and  $f_2$ , and state variables,  $x_i$ , are entered into the equation solver. When the convergence criterion as given by equation (4.7) is met, the iteration ceases, and the solutions  $x_1^*$  and  $x_2^*$  satisfy  $f_1 = f_2 = 0$ . After the solutions are obtained, the simulation time is increased by  $h$ , which is either variable time step or fixed.

#### 4.2 Integration of Stiff Ordinary Differential Equations

The use of variable time step and variable order integration techniques to solve sets of differential equations can reduce the amount of computer time required for dynamic simulations significantly. The algorithm employed is the one developed by Brayton, Gustavson and Hachtel [17]. This is an extension of the famous Gear algorithm called DIFSUB [18], which uses the backward differential formulas associated with Nordsieck's method [19].

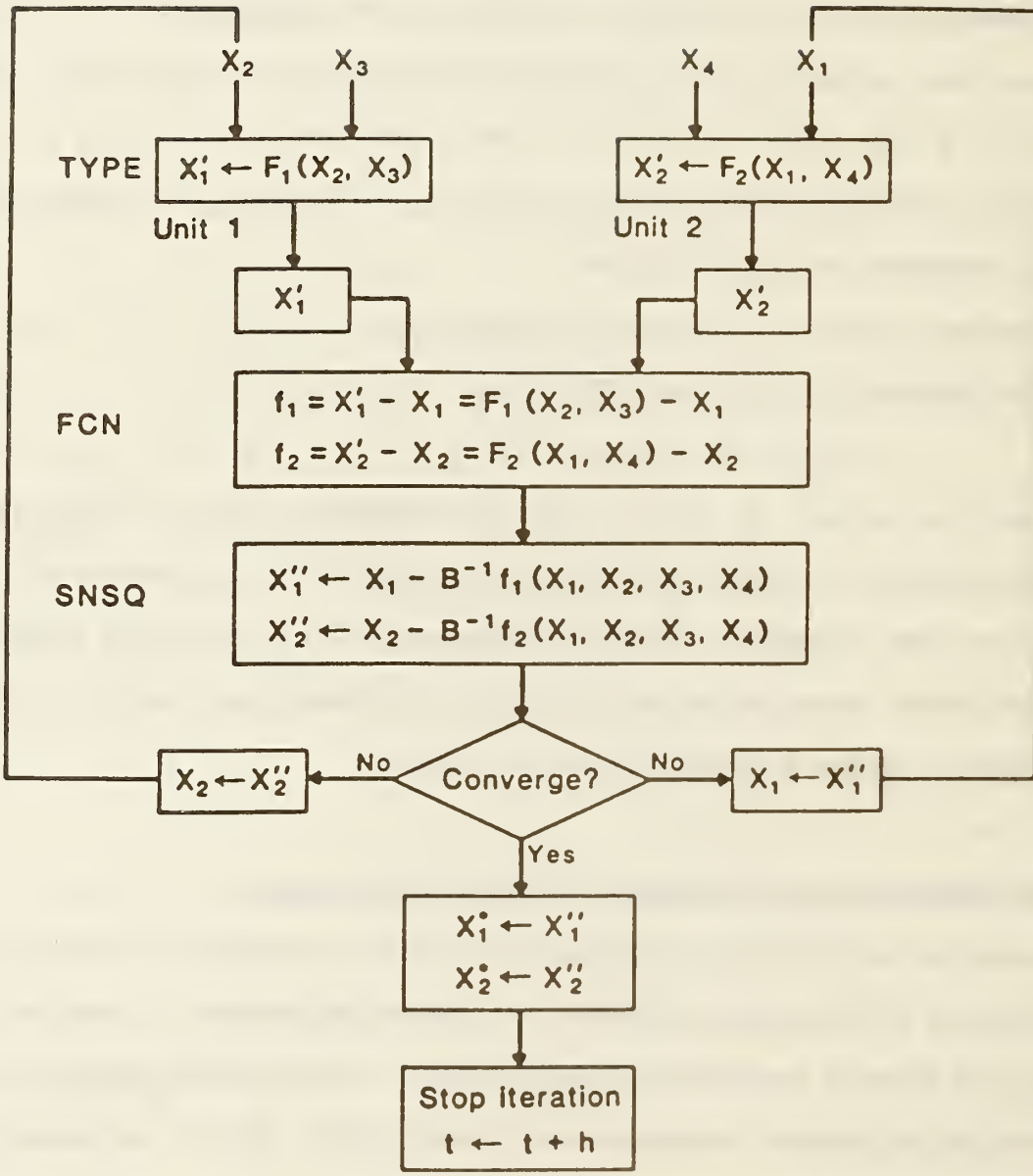

Figure 4. Simplified flow diagram for the iterative procedure in solving simultaneous, nonlinear equations

The discussion which follows will be highlighted information of the method by Brayton, et al [17]. Because a higher order ordinary differential equation can be transformed into a system of first-order differential equations, only integration of first order differential equations will be addressed.

A system of implicit differential algebraic equations can be expressed as

$$\underline{f}(\underline{x}, \dot{\underline{x}}, t) = 0 \quad (4.9)$$

where  $\underline{x}$  is a state variable vector which is a function of time,  $t$ ,  $\dot{\underline{x}}$  is a derivative of  $\underline{x}$ . If the solution vector  $\underline{x}(t)$  of equation (4.9) had been obtained at previous discrete times,  $t=t_n$ ,  $t=t_{n-1}$ , ..., and  $t=t_{n+1-k}$ , then the solution  $\underline{x}_{n+1}$  at the current time,  $t=t_{n+1}$ , satisfies

$$\underline{f}(\underline{x}_{n+1}, \dot{\underline{x}}_{n+1}, t_{n+1}) = 0 \quad (4.10)$$

For stiff equations, the backward differentiation formula (BDF) approximates the present value  $\dot{\underline{x}}_{n+1}$  at  $t=t_{n+1}$  in terms of  $\underline{x}_{n+1}$ , and the  $k$  past values  $\underline{x}_n, \underline{x}_{n-1}, \dots, \underline{x}_{n-k+1}$ . The  $k$ -th order backward differentiation formula is

$$\dot{\underline{x}}_{n+1} = -\frac{1}{h} \sum_{i=0}^k a_i \underline{x}_{n+1-i}, \quad (4.11)$$

where  $a_i$  are constants and  $h$  is the present step size ( $t_{n+1}-t_n$ ). Setting  $\underline{g}(\underline{x}_{n+1}) = \dot{\underline{x}}_{n+1}$ , and substituting equation (4.11) into equation (4.10) yields a set of nonlinear algebraic equations of  $\underline{x}_{n+1}$  at time  $t_{n+1}$ . This system of

nonlinear equations can be solved by a nonlinear equation solver. In the MODSIM program, the previously described SNSQ routine is employed to solve the equations.

At the beginning of simulation, the initial values of  $\underline{x}_0$  at  $t=0$  is used with order  $k=1$  for  $\underline{x}_1$ . Knowing  $\underline{x}_0$  and  $\underline{x}_1$ , the new value  $\underline{x}_2$  is computed using  $k \leq 2$ , and so on. The maximum order of  $k$  has been limited to 6 since the order  $k$  seldom exceeds 6 in most applications.

As discussed already, the Newton method requires a reasonably good guess for the initial iteration. The predicted value of  $\underline{x}_{n+1}$  for the initial guess is formulated using the same regressor expression in equation (4.11).

$$\underline{x}_{n+1}^P = \sum_{i=1}^{k+1} \gamma_i \underline{x}_{n+1-i} \quad (4.12)$$

where  $\gamma_i$  are constants.

For the  $k$ -th order backward differential formula, the local truncation error is given by

$$e_{tr} = E_k + O(h^{k+2}) \quad (4.13)$$

where

$$E_k = \frac{h}{t_{n+1} - t_{n-k}} (\underline{x}_{n+1} - \underline{x}_{n+1}^P) \quad (4.14)$$

and the term  $O(h^{k+2})$  represents higher-order terms in the step size of degrees

greater than or equal to  $k+2$ .

Although the algorithm for computation of  $\alpha_1$  and  $\gamma_1$  presented by Brayton, et al. is very complex, it was coded in MODSIM to improve computational efficiency. Chua and Lin [20] explained the variable step-size, variable-order algorithm in a much easier way to follow.

Figure 5 shows a simplified flow chart of the algorithm for integration of stiff ordinary differential equations which is implemented in MODSIM. In the TYPE subroutine, the derivative of state variable  $x$  at time  $t = t_{n+1}$  is calculated. The difference between the derivative  $\dot{x}_{n+1}$  and the value of backward differential formula as formulated in equation (4.11) is denoted as  $g$ . The residual function is, in fact, a nonlinear algebraic equation given by

$$g = G(x_{n+1}) + \frac{1}{h} \sum_{i=0}^k \alpha_i x_{n+1-i} \quad (4.15)$$

When  $x_{n+1}$  is the solution of equation (4.15),  $g$  is zero. To find the solution at the present time, numerical iteration using the SNSQ routine is performed and convergence is checked. If the solution is converged close to the real solution, the iteration is terminated and the truncation error of backward differential formula is computed and the order  $k$  and the step are determined. The selected step and order are rejected if the truncation error is too large. The strategy of selecting the order and step with the MODSIM is based on the

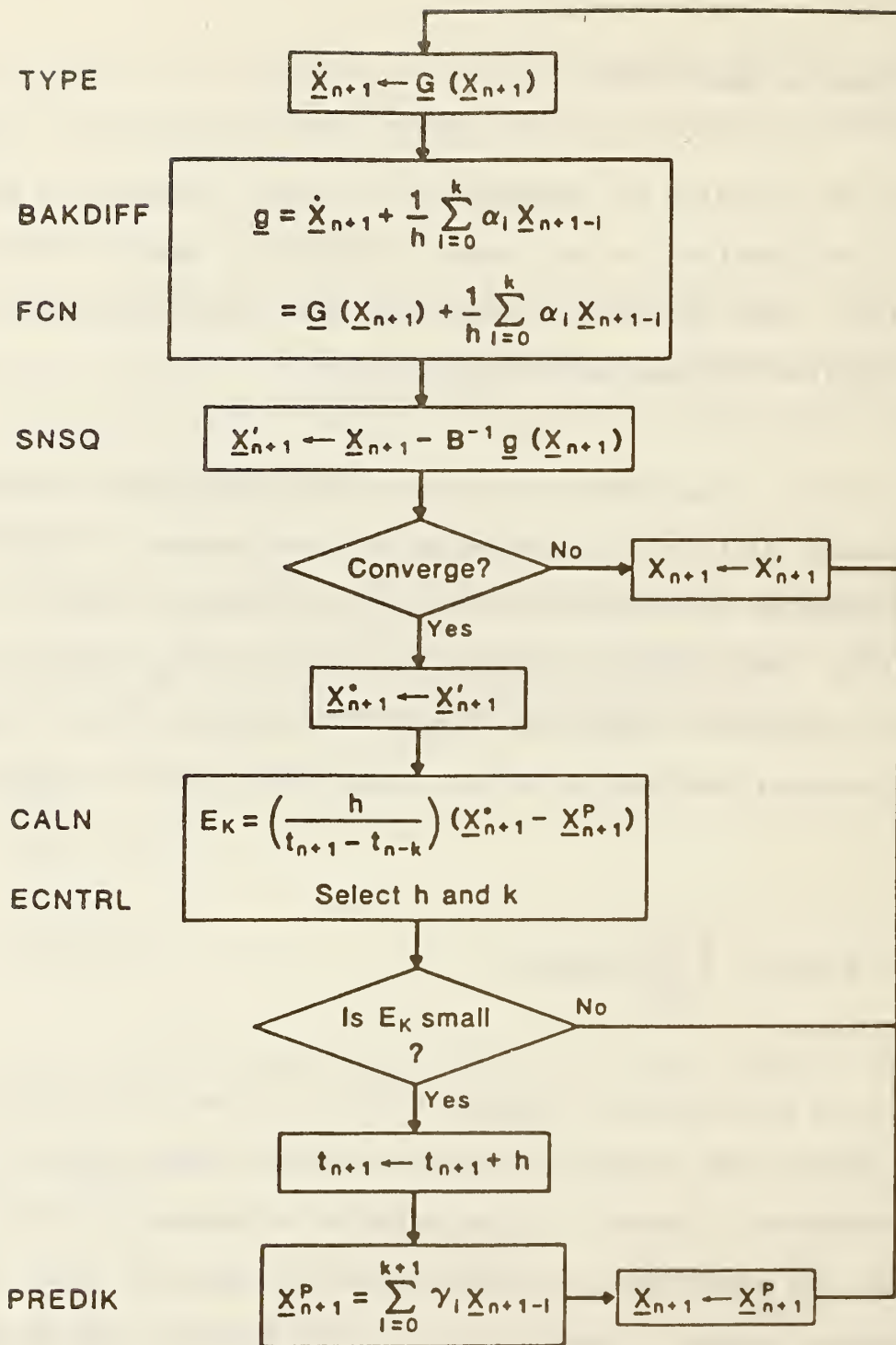

Figure 5. Simplified flow chart of the algorithm for integration of stiff ordinary differential equations



condition

$$E_k \leq \frac{3h(e_r |x_{n+1}| + e_a)}{t_f - t_i} \quad (4.16)$$

where  $t_i$  and  $t_f$  are the initial and final time considered in the integration using the backward differential formula. The time interval,  $t_f - t_i$ , must be provided as one of input values prior to simulation. This quantity is specified during the time when the simulation work file is generated.

### 4.3 Interpolation of Data

Lagrangian and spline interpolation techniques are used in the MODSIM program. Interpolation of data points for the time dependent boundary variables is made by using the 3rd order Lagrangian interpolation:

$$x(t) = \sum_{i=0}^4 \left[ \prod_{\substack{j=1 \\ i \neq j}}^4 \left( \frac{t - t_j}{t_i - t_j} \right) \right] x_i \quad (4.17)$$

where  $x(t)$  is the interpolated state variable at time  $t$ , and  $x_i = x(t_i)$ .

For interpolating the hourly weather data, the computer program of the cubic spline interpolation by Ferziger [21] was implemented in MODSIM. The interpolation formula is

$$x(t) = \frac{x(t_i)(t_{i+1} - t)}{6} \left[ \frac{(t_{i+1} - t)^2}{h_i} - h_i \right] + \frac{x(t_{i+1})(t - t_i)}{6} \left[ \frac{(t - t_i)^2}{h_i} - h_i \right] \\ + \frac{y_i(t_{i+1} - t)}{h_i} + \frac{y_{i+1}(t - t_i)}{h_i}, \quad t_i - t_{i+1} \quad (4.18)$$

where  $y_i = x(t_i)$  for  $i=1, 2, \dots, n$ , and  $h_i = t_{i+1} - t_i$ . The second derivatives  $x''(t_i)$  and  $x''(t_{i+1})$  for  $i=2, 3, \dots, n-1$  are found using the following set of equations for the second derivatives of  $x(t)$  at nodes

$$h_{i-1}x''(t_{i-1}) + 2(h_{i-1} + h_i) x''(t_i) + h_i x''(t_{i+1}) \quad (4.19)$$

$$= 6 \left[ \frac{y_{i+1} - y_i}{h_i} - \frac{y_i - y_{i-1}}{h_{i-1}} \right], \quad i=2, 3, \dots, n-1$$

The coefficients of these sets of equations form a tridiagonal matrix, and the system can be solved for  $x''(t_i)$ ,  $i=2, 3, \dots, n-1$  by using the Gaussian elimination method.

Two additional equations are determined from the end conditions. Ferziger's code uses the cantiler condition where

$$x''(t_1) = \lambda x''(t_2) \text{ and } x''(t_n) = \lambda x''(t_{n-1}), \quad (4.20)$$

and  $\lambda \in [0, 1]$ .

In the MODSIM, 24 points of each component weather data (temperature, pressure, etc.) are read once each day, and the second derivatives of the variable are calculated using the set of equations as shown in equation (4.19). At a given time during the day, the interpolated value is evaluated using equation (4.20) with  $\lambda = 1$ .

## 5. BUILDING LOADS CALCULATION

In HVACSIM<sup>+</sup>, a building shell model and a building zone model are used for building thermal loads determination. These models were developed based on Kusuda [22] and Walton [9]. Previously the building shell model contained the zone model [6]. In this report, these models are distinguished. The building shell model utilizes a user-selected fixed time interval, while the zone model uses variable time intervals.

Models for building loads calculation include the effects of different kinds of building shell materials, air temperatures, the moisture content of the air, lighting, equipment, occupancy schedule, solar radiation, wind velocity, orientations of the exterior building surfaces, and the effect of shadowing. Since there are so many factors involved, some simplifying assumptions had to be made. The major assumptions in the current HVACSIM<sup>+</sup> program include:

- (1) Uniform temperature distributions on a building surface (one dimensional heat transfer across a wall)
- (2) Uniform ground temperature distribution
- (3) No effects of wind direction, rain, and snow

The approach taken uses the standard response factor method to calculate the conductive heat transfer rates through the building shell. The conduction transfer functions are computed once and stored prior to a simulation. The same time interval used in the calculation of conduction transfer functions of building constructs is applied as the period during which the conductive heat

fluxes through the building surfaces are assumed to be invariant.

Primary routines for the building load determination are those dealing with the calculation of building surface temperatures and zone loads. Walls and zones are treated as component models, and are coded as TYPE $n$  subroutines. Because of the use of the fixed time step, the units representing building surfaces must be in a superblock which is separate from those containing units which use a variable time step.

The zone model calculates indoor air dry-bulb temperature and humidity ratio on a variable time step basis and takes into account the dynamic operation of the HVAC system and its controls, and thermal loads.

The building shell model contains three TYPE subroutines (TYPE50, TYPE51, and TYPE53), and the building zone model is designated as TYPE52. In the following sections, details of these TYPE subroutines are described.

## 5.1 TYPE50: ZONE ENVELOPE

### General Description

This subroutine combines information generated by the TYPE51 building surface model. Convective heat gain from building surfaces and mean radiant temperature are computed. Since this routine is a part of the building shell model, it must be in a superblock which takes a user-selected, fixed time step.

### Nomenclature

$A_{s,j}$	area of the j-th building wall surface ( $m^2$ )
$h_{is,c,j}$	convective heat transfer coefficient of the j-th building inner surface ( $W/m^2K$ )
$h_{is,r,j}$	radiative heat transfer coefficient of the j-th building inner surface ( $W/m^2K$ )
$I_{sol,j}$	total solar radiation influx ( $W/m^2$ )
$N_s$	number of wall surfaces in a zone (-)
$\dot{q}_{sl,r}$	short wave radiant heat flux from the sun and the lights ( $W/m^2$ )
$\dot{Q}_{sw,r}$	short wave (visible) radiant heat gain from lights (W)
$\dot{Q}_{lw,r}$	long wave (infrared) radiant heat gain from people and equipment (W)
$\dot{Q}_{wall}$	convective heat flow rate from building surfaces in a zone (W)
$T_i$	zone air dry-bulb temperature (C)
$T_{is,j}$	surface temperature of the j-th inner wall (C)

$T_{mr}$	zone mean radiant temperature (C)
$S_{c,j}$	shading coefficient of the j-th building wall (-)
$\alpha_{is,j}$	short wave absorptance of the j-th inner wall (-)
$\tau_{s,j}$	transmittance of the j-th wall (-)

### Mathematical Description

Short wave radiant heat fluxes from the sun and the lights in a zone are evaluated by using the following expressions:

$$\dot{q}_{s1,r} = \frac{\sum_{j=1}^{N_s} A_{s,j} \tau_{s,j} S_{c,j} I_{sol,j} + \dot{Q}_{sw,r}}{\sum_{j=1}^{N_s} A_{s,j} (\alpha_{is,j} + \tau_{s,j})} \quad (5.1)$$

Convective heat flow rate across the air film between the zone air and interior surface of the building shell is given by

$$\dot{Q}_{wall} = \sum_{j=1}^{N_s} h_{is,c,j} A_{s,j} (T_{is,j} - T_i) \quad (5.2)$$

The expression of mean radiation temperature is obtained from

$$T_{mr} = \frac{\sum_{j=1}^{N_s} h_{is,r,j} A_{s,j} T_{is,j} + \dot{Q}_{lw,r}}{\sum_{j=1}^{N_s} h_{is,r,j} A_{s,j}} \quad (5.3)$$

## Configuration

<u>Inputs</u>		<u>Description</u>
1	$T_i$	zone air dry-bulb temperature (C)
2	$\dot{Q}_{sw,r}$	short wave radiant heat gain from lights (kW)
3	$\dot{Q}_{lw,r}$	long wave radiant heat gain from people and equipment (kW)
4	$T_{is,1}$	surface temperature of the 1st inner wall (C)
5	$T_{is,2}$	surface temperature of the 2nd inner wall (C)
6	$T_{is,3}$	surface temperature of the 3rd inner wall (C)
7	$T_{is,4}$	surface temperature of the 4th inner wall (C)
8	$T_{is,5}$	surface temperature of the 5th inner wall (C)
9	$T_{is,6}$	surface temperature of the 6th inner wall (C)
10	$T_{is,7}$	surface temperature of the 7th inner wall (C)
11	$T_{is,8}$	surface temperature of the 8th inner wall (C)
12	$T_{is,9}$	surface temperature of the 9th inner wall (C)
13	$T_{is,10}$	surface temperature of the 10th inner wall (C)

<u>Outputs</u>		<u>Description</u>
1	$T_{mr}$	mean radiant temperature (C)
2	$\dot{Q}_{wall}$	convective heat gain from building surfaces (kW)

<u>Parameters</u>		<u>Description</u>
1	IZN	identification number of zone (-), $1 \leq IZN \leq MAXZN$
2	$N_s$	number of building surfaces in a zone (-), $1 \leq N_s \leq MAXNS$

Note that variables which are not identified as inputs, outputs, or parameters, but used in the TYPE50 subroutine, appear in COMMON blocks. It should be noted that the unit for heat flow rates is kW for inputs and outputs, although the unit of W is used in the mathematical description.

In the current version of HVACSIM<sup>+</sup>, MAXZN = 6, and MAXNS = 10.



## 5.2 TYPE51: BUILDING SURFACE

### General Description

This subroutine computes outer and inner surface temperatures of a building surface construct, and determines average solar flux on the outer surface. Because this TYPE51 subroutine is a part of the building shell model, it must be in a superblock which takes a user-selected, fixed time interval.

### Nomenclature

$f_{sg}$	angle factor between ground and surface (-)
$f_{ss}$	angle factor between sky and surface (-)
$g_r$	ground reflectivity (-)
$h_{is,c,j}$	convective heat transfer coefficient of the j-th building inner surface ( $W/m^2K$ )
$h_{is,r,j}$	radiative heat transfer coefficient of the j-th building inner surface ( $W/m^2K$ )
$h_{os,j}$	convective plus radiative heat transfer coefficient of the j-th building outer surface ( $W/m^2K$ )
$I_b$	direct normal solar beam radiation ( $W/m^2$ )
$I_g$	ground reflective radiation ( $W/m^2$ )
$I_h$	total horizontal solar radiation ( $W/m^2$ )
$I_{sol,j}$	average solar radiation influx on the j-th surface ( $W/m^2$ )
$I_s$	diffuse (sky) solar radiation ( $W/m^2$ )
$N_f$	order of conduction transfer function calculation (-)
$N_t$	number of conduction transfer function terms (-)
$\dot{q}_{i,j,n}$	current conductive heat flux at the inner surface ( $W/m^2$ )

$\dot{q}_{o,j,n}$	current conductive heat flux at the outer surface ( $W/m^2$ )
$q'_{i,j}$	conductive heat flux at the inside of the j-th surface at the present time due to past temperature history
$q'_{o,j}$	conductive heat flux at the outside of the j-th surface at the present time ( $W/m^2$ )
$\dot{q}_{sl,r}$	short wave radiation heat flux from the sun and lights ( $W/m^2$ )
$\dot{q}_{sol,o,j}$	solar heat flux on the outside surface of the j-th construct ( $W/m^2$ )
$R_{k,j}$	flux term related to overall conductance (-)
$S_d$	fraction of shadowed area to total exposed surface area (-)
$T_i$	zone air dry-bulb temperature (C)
$T_{is,j}$	inside surface temperature of the j-th construct (C)
$T_{mr}$	mean radiant temperature (C)
$T_o$	outside air dry-bulb temperature (C)
$T_{os,j}$	outside surface temperature of the j-th construct (C)
$U_j$	overall conductance ( $W/m^2K$ )
$V_w$	wind speed (m/s)
$X_{m,j}$	X-component of conduction transfer function at the m time steps ago ( $W/m^2K$ )
$Y_{m,j}$	Y-component of conduction transfer function at the m time steps ago ( $W/m^2K$ )
$Z_{m,j}$	Z-component of conduction transfer function at the m time steps ago ( $W/m^2K$ )
$X_{o,j}$	X-component of conduction transfer function at the present time ( $W/m^2K$ )

$Y_{o,j}$	Y-component of conduction transfer function at the present time ( $W/m^2K$ )
$Z_{o,j}$	Z-component of conduction transfer function at the present time ( $W/m^2K$ )
$\alpha_{is,j}$	radiation absorptance of the j-th inner surface (-)
$\alpha_{os,j}$	radiation absorptance of the j-th outer surface (-)
$\beta$	solar altitude angle (degrees)
$\gamma$	tilt angle (degrees)
$\theta$	solar beam incident angle (degrees)
$\xi$	surface azimuth angle (degrees)
$\phi$	solar azimuth angle from south (degrees)

### Mathematical Description

Conductive heat flow through a multilayered construct has been solved successfully by the response factor method, in which the surface temperature of each homogeneous layer is represented by a series of pulse functions. Based on the response factor method, conduction transfer functions are calculated for a multilayered wall. A heat balance at the j-th interior surface is used to determine the interior surface temperature by [9]:

$$T_{is,j} = \frac{h_{is,c,j}T_i + h_{is,r,j}T_{mr} + \alpha_{is,j} \dot{q}_{sl,r} + \dot{q}'_{i,j} + Y_{o,j}T_{os,j}}{h_{is,c,j} + h_{is,r,j} + Z_{o,j}} \quad (5.4)$$

The current conductive heat flux at the inner surface is

$$\dot{q}_{i,j,n} = Y_{o,j} T_{os,j} - Z_{o,j} T_{is,j} + \dot{q}'_{i,j} \quad (5.5)$$

where

$$\dot{q}'_{i,j} = \sum_{m=1}^{N_t} Y_{m,j} T_{os,j,n-m} - \sum_{m=1}^{N_t} Z_{m,j} T_{is,j,n-m} + \sum_{k=1}^{N_f} R_{k,j} \dot{q}_{i,j,n-k} \quad (5.6)$$

In the equations above, the subscript  $n$  is the current time, while  $m$  denotes the past time. Note that the time interval is fixed. The flux,  $R_{k,j}$ , is related to the overall conductance,  $U_j$ , as

$$U_j(1 - \sum_{k=1}^{N_f} R_{k,j}) = \sum_{m=0}^{N_t} X_{m,j} = \sum_{m=0}^{N_t} Y_{m,j} = \sum_{m=0}^{N_t} Z_{m,j} \quad (5.7)$$

The values of  $R_{k,j}$  and  $U_j$  as well as  $X_{m,j}$ ,  $Y_{m,j}$  and  $Z_{m,j}$  are computed by the CTFGEN program.

On the outside surface, which is exposed to sunlight (IEXPOS=2), the outer surface temperature can be computed by:

$$T_{os,j} = \frac{h_{os,j} T_o + \dot{q}_{sol,o,j} + \dot{q}'_{o,j} + f_{1,j} f_{2,j}}{h_{os,j} + X_{o,j} - f_{1,j} Y_{o,j}} \quad (5.8)$$

where

$$f_{i,j} = \frac{Y_{o,j}}{h_{is,c,j} + h_{is,r,j} + Z_{o,j}}$$

$$f_{2,j} = h_{is,c,j} T_i + h_{is,r,j} T_{mr} + a_{is,j} \dot{q}_{sl,r} + \dot{q}'_{i,j}$$

$$\dot{q}_{sol,o,j} = a_{os,j} I_{sol,j} \quad (5.9)$$

The current conductive heat flux at the outer surface is

$$\dot{q}_{o,j,n} = Y_{o,j} T_{is,j} - X_{o,j} T_{os,j} + \dot{q}'_{o,j} \quad (5.10)$$

where

$$\dot{q}'_{o,j} = \sum_{m=1}^{N_t} Y_{m,j} T_{is,j,n-m} - \sum_{m=1}^{N_t} X_{m,j} T_{os,j,n-m} + \sum_{k=1}^{N_f} R_{k,j} \dot{q}_{o,j,n-k} \quad (5.11)$$

When the outside surface is exposed to another zone or to ground (IEXPOS=1), the outside surface temperature is equal to the inside surface temperature in another zone for the same construct or to the ground temperature ( $T_{os,j} = T_{osinf,j}$ ).

If a massive wall, which represents thermal mass, is within a zone (IEXPOS=0), both the inside and the outside surface temperatures are considered to be equal. The following expression can be used.

$$T_{is,j} = T_{os,j} = \frac{h_{is,c,j} T_i + h_{is,r,j} T_{mr} + \dot{q}_{sl,r} + \dot{q}'_{i,j}}{h_{is,c,j} + h_{is,r,j} + Z_{o,j} - Y_{o,j}} \quad (5.12)$$

Solar fluxes on the interior and exterior surfaces are evaluated based on either solar data from a weather tape or computation. When a surface has a surface azimuth angle,  $\xi$ , which is the angle from the south to the projection of normal to the surface onto the horizontal plane in clockwise direction, and a tilt angle,  $\tau$ , which is the angle between the normal to the surface and the

normal to the horizontal plane, the cosine of incident angle of the sun's rays is expressed by

$$\cos\theta = \cos\beta \cos(\theta - \zeta) \sin\gamma + \sin\beta \cos\gamma \quad (5.13)$$

where  $\theta$ ,  $\theta$ , and  $\beta$  are the incident angle, the solar azimuth angle from the south, and the solar altitude angle, respectively.

Defining the angle factor between ground and surface,  $f_{sg}$ , and that between sky and surface,  $f_{ss}$ , as

$$f_{sg} = 0.5 (1 - \cos\gamma) \quad (5.14)$$

$$f_{ss} = 0.5 (1 + \cos\gamma) \quad (5.15)$$

the average solar radiation influx,  $I_{sol,j}$ , on the  $j$ -th surface is given by

$$I_{sol,j} = I_b (1 - S_d) \cos\theta + I_s f_{ss} + I_g f_{sg} \quad (5.16)$$

where  $I_b$ ,  $I_s$ , and  $I_g$  are direct, diffusive, and ground reflective radiation.  $S_d$  is the shaded fraction of exposed outer surface.

The ground reflective radiation is dependent on ground reflection,  $g_r$ , and total solar radiation on a horizontal surface,  $I_h$ .

$$I_g = g_r I_h \quad (5.17)$$

### Configuration

<u>Inputs</u>	<u>Description</u>
1 $T_i$	zone air dry-bulb temperature (C)
2 $T_{mr}$	mean radiant temperature (C)
3 $T_{osinf,j}$	outer surface temperature of unexposed surface (C)

4  $S_d$  shaded fraction of exposed outer surface (-),  $0 \leq S_d \leq 1$

<u>Outputs</u>	<u>Description</u>
1 $T_{is,j}$	inner surface temperature (C)
2 $I_{sol,j}$	average solar radiation influx on the outer surface ( $W/m^2$ )

<u>Parameters</u>	<u>Descriptions</u>
1 IZN	identification number of zone (-), $1 \leq IZN \leq MAXZN$
2 j	identification number of surface (-), $1 \leq j \leq MAXNS$
3 IEXPOS	0 if the wall construct is inside the zone 1 if the wall construct is between zones or exposed to ground 2 if the wall construct is exposed to sunlight
4 ISTR	identification number of construct (-), $1 \leq ISTR \leq MAXSTR$
5 $A_{s,j}$	surface area ( $m^2$ )
6 $\xi$	surface azimuth angle, measured from south to the projection of normal to the surface onto the horizontal plane in clockwise direction (degrees), $0 \leq \xi \leq 360$
7 $\gamma$	tilt angle of the surface, measured from the normal to the surface to the normal to the horizontal plane (degrees), $0 \leq \gamma \leq 180$ $\gamma = 0$ for flat roof $\gamma = 180$ for floor
8 $g_r$	ground reflectivity (-), $0 \leq g_r \leq 1$
9 IROFS	outside surface roughness index (-), $1 \leq IROFS \leq 6$ 1 --- stucco

2 --- brick, rough plaster

3 --- concrete

4 --- clear pine

5 --- smooth plaster

6 --- glass, paint or pine

- 10  $\alpha_{os,j}$  solar absorptance of the outer surface (-),  $0 \leq \alpha_{os,j} \leq 1$
- 11  $\alpha_{is,j}$  short wave absorptance of the inner surface (-),  $0 \leq \alpha_{is,j} \leq 1$
- 12  $\epsilon_j$  emissivity of the inner surface (-),  $0 \leq \epsilon_j \leq 1$
- 13  $\tau_{s,j}$  transmittance of the glass window (-),  $0 \leq \tau_{s,j} \leq 1$
- $\tau_{s,j} = 0$  for opaque wall
- 14  $S_c$  shading coefficient of glass window (-),  $0 \leq S_c \leq 1$
- $S_c = 0$  for opaque wall

Note that variables which are not identified as inputs, outputs, or parameters, but are used in the TYPE51 subroutine, appear in COMMON blocks.

In the current version of HVACSIM<sup>+</sup>, MAXZN = 6, MAXNS = 10, and MAXSTR = 10.



### 5.3 TYPE52: ZONE MODEL

#### General Description

In this TYPE52 subroutine, zone air temperature and humidity ratio are computed based on zone loads. Most of the zone loads except convective heat gain from building surfaces are internally determined in this subroutine. In fact, this zone model belongs to the building shell model. However, the zone model must be treated differently when the model definition file is created by HVACGEN because the zone model uses variable time steps.

#### Nomenclature

$C_{air}$	thermal capacitance of air (kJ/K)
$C_{fur}$	effective thermal capacitance of furnishing (kJ/K)
$C_{p,i}$	specific heat of zone air (kJ/kgK)
$C_{p,o}$	specific heat of outdoor air (kJ/kgK)
$C_{p,s}$	specific heat of supply air (kJ/kgK)
$e_m$	air mass multiplier for moisture capacitance of zone (-)
$f_c$	ratio of convective heat to total sensible heat from lights (-)
$f_{lw}$	ratio of long wave radiative heat to total sensible heat from lights (-)
$f_{sw}$	ratio of short wave radiative heat to total sensible heat from lights (-)
$h_{fg}$	latent heat of vaporization of water (kJ/kg)
$I_{air}$	air exchange rate (1/h)
$\dot{m}_{infl}$	mass flow rate due to infiltration (kg/s)

$\dot{m}_s$	mass flow rate of supply air (kg/s)
$N_p$	number of people in the zone (-)
$\dot{Q}_{equip,c}$	convective heat gain from equipment (kW)
$\dot{Q}_{equip,lat}$	latent heat gain from equipment (kW)
$\dot{Q}_{equip,r}$	radiant heat gain from equipment (kW)
$\dot{Q}_{infl}$	sensible heat gain or loss due to infiltration (kW)
$\dot{Q}_{light,c}$	convective heat gain from lighting (kW)
$\dot{Q}_{light,r,w}$	long wave radiative heat gain from lighting (kW)
$\dot{Q}_{lw,r}$	long wave radiative heat gain in the zone (kW)
$\dot{Q}_{people,c}$	convective heat gain from people (kW)
$\dot{Q}_{people,lat}$	latent heat gain from people (kW)
$\dot{Q}_{people,r}$	radiative heat gain from people (kW)
$\dot{Q}_s$	sensible heat gain by supply air (kW)
$\dot{Q}_{sw,r}$	short wave radiative heat gain (kW)
$\dot{Q}_{wall}$	convective heat gain from building zone surfaces (kW)
$r_e$	ratio of radiative heat to total sensible heat from equipment (-)
$r_p$	ratio of radiative heat to total sensible heat from people (-)
$T_i$	zone air dry-bulb temperature (C)
$T_o$	outdoor air dry-bulb temperature (C)
$T_s$	supply air dry-bulb temperature (C)
$U_e$	equipment utilization coefficient (-)
$U_{light}$	lighting utilization coefficient (-)
$V_i$	volume of zone air (interior space of zone) (m <sup>3</sup> )

$W_{e,lat}$	latent heat gain from equipment (kW)
$W_{e,s}$	sensible heat gain from equipment (kW)
$W_i$	humidity ratio of zone air (-)
$W_{light}$	sensible heat gain from lights (kW)
$W_o$	humidity ratio of outside air (-)
$W_{p,lat}$	latent heat gain from a person (kW)
$W_{p,s}$	sensible heat gain from a person (kW)
$W_s$	humidity ratio of supply air (-)
$\rho_i$	density of zone air (kg/m <sup>3</sup> )
$\rho_{infl}$	density of infiltrated air (kg/m <sup>3</sup> )

### Mathematical Description

Convective heat gains from people occupying the zone, from equipment such as typewriters, computers, coffee pots, copying machine, etc. and from lights are:

$$\dot{Q}_{people,c} = (1 - \tau_p) N_p W_{p,s} \quad (5.18)$$

$$\dot{Q}_{equip,c} = (1 - \tau_e) U_e W_{e,s} \quad (5.19)$$

$$\dot{Q}_{light,c} = f_c U_{light} W_{light} \quad (5.20)$$

Latent heat gains from people and equipment are also considered, while moisture absorptance and desorption by the building structure and interior furnishings are not explicitly included in the building zone model.

$$\dot{Q}_{people,lat} = N_p W_{p,lat} \quad (5.21)$$

$$\dot{Q}_{equip,lat} = U_e W_{e,lat} \quad (5.22)$$

Long wave radiant heat gains from people, equipment, and lights, along with the radiative heat from building surfaces are used to obtain mean radiant temperature of the zone. The use of mean radiant temperature is much simpler than using detailed radiant heat-exchange between walls. Short wave radiation due to lights and the sun are not directly involved in the computation of the mean radiation temperature.

Long wave radiative heat gains from people, equipment, and lights, are

$$\dot{Q}_{\text{people},r} = r_p N_p W_p',s \quad (5.23)$$

$$\dot{Q}_{\text{equip},r} = r_e U_e W_e,s \quad (5.24)$$

$$\dot{Q}_{\text{light},r,1w} = f_{1w} U_{\text{light}} W_{\text{light}} \quad (5.25)$$

Total long wave radiative heat gains are expressed as the sum of the above equations:

$$\dot{Q}_{1w,r} = \dot{Q}_{\text{people},r} + \dot{Q}_{\text{equip},r} + \dot{Q}_{\text{light},r,1w} \quad (5.26)$$

Short wave radiant heat gain from lighting is

$$\dot{Q}_{\text{sw},r} = f_{\text{sw}} U_{\text{light}} W_{\text{light}} \quad (5.27)$$

Sensible heat gain or loss due to infiltration is given by

$$\dot{Q}_{\text{infl}} = \rho_{\text{infl}} V_i I_{\text{air}} (C_{p,o} T_o - C_{p,i} T_i) \quad (5.28)$$

The zone air temperature is obtained using

$$(C_{\text{fur}} + C_{\text{air}}) \frac{dT_i}{dt} = \dot{Q}_s + \dot{Q}_{\text{infl}} + \dot{Q}_{\text{wall}} + \dot{Q}_{\text{light},c} + \dot{Q}_{\text{people},c} + \dot{Q}_{\text{equip},c} \quad (5.29)$$

Heat flow rate from building surfaces is computed by the shell model (TYPE50 and TYPE51).

The heat gain by supply air is expressed as

$$\dot{Q}_s = C_{p,s} \dot{m}_s (T_s - T_i) \quad (5.30)$$

Zone air humidity is calculated from the zone air moisture balance equation.

In terms of humidity ratio,  $W$ , the moisture content of zone air is expressed.

$$\rho_i V_i e_m \frac{dW_i}{dt} = (\dot{Q}_{\text{people,lat}} + \dot{Q}_{\text{equip,lat}}) / h_{fg} \quad (5.31)$$

$$+ \dot{m}_{\text{infl}} (W_o - W_i) + \dot{m}_s (W_s - W_i)$$

where  $h_{fg}$  is latent heat of vaporization of water, which can be obtained from the fluid property library, and  $e_m$  is an air mass multiplier for moisture capacitance of zone. Outdoor humidity ratio,  $W_o$ , comes from weather data.

### Configuration

<u>Inputs</u>	<u>Description</u>
1 $P_{i,g}$	gauge pressure of zone air (kPa)
2 $T_i$	zone air dry-bulb temperature (C)
3 $W_i$	humidity ratio of zone air (-)
4 $P_{s,g}$	gauge pressure of supply air (kPa)
5 $\dot{m}_s$	mass flow rate of supply air (kg/s)

6	$T_s$	supply air dry-bulb temperature (C)
7	$W_s$	humidity ratio of supply air (-)
8	$\dot{Q}_{wall}$	convective heat flow rate from building surfaces (kW)
9	$N_p$	number of persons in the zone (-)
10	$U_e$	equipment utilization coefficient (-), $0 \leq U_e \leq 1$
11	$U_{light}$	lighting utilization coefficient (-), $0 \leq U_{light} \leq 1$

<u>Outputs</u>	<u>Description</u>	
1	$T_i$	zone air dry-bulb temperature (C)
2	$W_i$	humidity ratio of zone air (C)
3	$\dot{Q}_{sw,r}$	short wave (visible) radiant internal gain from lights (kW)
4	$\dot{Q}_{lw,r}$	long wave (thermal) radiant internal gain from people, equipment, and lights (kW)

<u>Parameters</u>	<u>Descriptions</u>	
1	$IZN$	identification number of zone (-), $1 \leq IZN \leq MAXZN$
2	$C_{fur}$	effective thermal capacitance of furnishing (kJ/K)
3	$e_m$	air mass multiplier for moisture capacitance of zone (-)
4	$V_i$	volume of zone air (interior space of zone) ( $m^3$ )
5	$I_{s,air}$	standard air exchange rate (1/h)
6	$W_{p,s}$	sensible heat gain from a person (kW)
7	$W_{p,lat}$	latent heat gain from a person (kW)
8	$W_{light}$	heat gain due to lighting in the zone (kW)
9	LIGHT	type of lighting

1 for fluorescent lights

2 for incandescent lights

- 10  $W_{e,s}$  sensible heat gain due to equipment (kW)
- 11  $W_{e,lat}$  latent heat gain due to equipment (kW)
- 12  $r_e$  ratio of radiative heat to total sensible heat from  
equipment (-),  $0 \leq r_e < 1$

Note that the following constant values are assigned in the DATA statement in  
the TYPE 52 subroutine:

$$r_p = 0.7$$

for fluorescent lights,  $f_c = 0.6$ ,  $f_{lw} = 0.2$ , and  $f_{sw} = 0.2$

for incandescent lights,  $f_c = 0.1$ ,  $f_{lw} = 0.8$ , and  $f_{sw} = 0.1$

## 5.4 TYPE53: WEATHER INPUT

### General Description

This TYPE53 subroutine places weather data read by the RDENV subroutine into the state vector. The inputs are really just for mnemonic purposes. The parameters are the indices of the variables. Input indices should always equal parameter values. This routine does nothing when the building shell model is not used, and is optional when the building shell model is used. One unit per simulation is sufficient, and it is recommended that the unit using the TYPE53 subroutine should be placed in the same superblock where the building shell portion is modeled (TYPE50 and TYPE51).

### Configuration

<u>Inputs</u>	<u>Description</u>
1 $T_o$	outdoor air temperature (C)
2 $W_o$	outdoor air humidity ratio (-)
3 $P_o$	barometric pressure (kPa)
4 $I_b$	direct normal solar beam radiation ( $W/m^2$ )
5 $I_s$	diffuse (sky) solar radiation ( $W/m^2$ )
6 $I_h$	total horizontal solar radiation ( $W/m^2$ )

### Outputs                      Description

none



<u>Parameters</u>	<u>Description</u>
1 NTOA	index for $T_0$
2 NWOA	index for $W_0$
3 NPOA	index for $P_0$
4 NDN	index for $I_b$
5 NSKY	index for $I_s$
6 NHOR	index for $I_h$

## 6. UTILITY ROUTINES FOR BUILDING LOADS CALCULATION

The TYPE subroutines for building loads determination require routines for property of moist air, heat transfer coefficients, view factors, and air exchange rate. In addition, the building shell model needs weather data and conduction transfer functions of building constructs as mentioned previously (see Figure 1).

### 6.1 Properties of Moist Air

When humidity ratio of moist air,  $W_i$  is given, the specific heat of air,  $C_p$ , can be obtained from [23]

$$C_p = 1 + 1.805 W \text{ (kJ/kgK)} \quad (6.1)$$

The density of moist air,  $\rho$ , can be computed by

$$\rho = \rho_{\text{dry}} (1+W) = \left[ \frac{P - P_w}{R_a (T+273)} \right] (1+W) \quad (\text{kg/m}^3) \quad (6.2)$$

where  $W$  is humidity ratio,  $R_a$  is the gas constant for dry air (=0.287055 kJ/kgK),  $P$  is atmospheric pressure, and  $P_w$  is the vapor pressure which is given by

$$P_w = \frac{WP}{W + 0.62198} \text{ (kPa)} \quad (6.3)$$

Humidity ratio at saturation state can be determined from

$$W_{\text{sat}} = \frac{0.62198}{P - P_{\text{sw}}} \text{ (-)} \quad (6.4)$$

where  $P_{sw}$  is saturated vapor pressure (kPa) and can be computed by [24]

$$P_{sw} = 3.376 \text{ EXP} \left[ 15.463 - \frac{7284}{1.8T + 424} \right] \text{ (kPa)} \quad (6.5)$$

The function CP contains the expressions for moist air.

## 6.2 Air Exchange Rate

The air exchange rate is calculated using wind speed, and the dry-bulb temperature difference between indoor and outdoor air [25].

$$I_{air} = I_{s,air} [0.15 + (0.013)(2.2369) V_w + (0.005)(1.8) |T_o - T_i|] / 0.695 \quad (6.6)$$

where  $I_{s,air}$  and  $V_w$  are standard air exchange rate (1/h), and wind speed (m/s) respectively. Standard air exchange can be chosen one of the following values:

- Living space - 1.5 for leaky building
  - 1.0 for standard building
  - 0.5 for moderately tight building
- Attic space - 20.0 for mechanical ventilation
  - 6.0 for natural ventilation
- Crawl space - 3.0

The air exchange rate expression is in the CP function.

## 6.3 MRT View Factors

Radiation exchange between zone surfaces is obtained by using the mean radiant temperature network (MRTN) method introduced by Carroll [26]. Surfaces interact with a mean radiant temperature instead of directly with each other.

Because of it, the number of interactions is reduced from  $n^2$  to  $n$ . The MRT network method includes a factor called 'MRT view factor' which is expressed by

$$F_j = \frac{1}{1 - \frac{A_{s,j} F_j}{\sum_{k=1}^{N_s} A_{s,k} F_k}}, \quad j=1,2,\dots,N_s \quad (6.7)$$

where  $A_{s,j}$  is the  $j$ -th surface area ( $m^2$ ), and  $N_s$  is the number of surfaces in the zone. This equation is solved iteratively. Maximum number of iterations is assigned to be 100 in DATA statement of the VIEW subroutine. The subroutine VIEW was written to compute the view factors based on the TARP package. The VIEW subroutine is called at the beginning of simulation, and the calculated view factors are stored for succeeding computations.

#### 6.4 Heat Transfer Coefficients

The convective heat transfer coefficient of the  $j$ -th inner surface is obtained from one of the following expressions [9]:

$$h_{is,c,j} = \frac{9.482 |T_i - T_{is,j}|^{0.333}}{7.238 - |\cos\gamma|} \quad \text{if } T_{is,j} \geq T_i \quad (6.8)$$

$$h_{is,c,j} = \frac{1.810 |T_i - T_{is,j}|^{0.333}}{1.382 + |\cos\gamma|} \quad \text{if } T_{is,j} \leq T_i \quad (6.9)$$

where  $\gamma$  denotes the tilt angle of the surface from horizontal plane. The unit of heat transfer coefficients is watts/m<sup>2</sup>K.

Using view factors of surfaces which enclose the zone (see equation (6.7)), the radiant heat transfer coefficients are computed. For the j-th surface, the coefficient is

$$h_{is,r,j} = \frac{4\sigma(T_{is,j} + 273)}{\frac{1}{F_j} + \frac{1-\epsilon_j}{\epsilon_j}} \quad (6.10)$$

where  $\sigma$  is Stephan-Boltzmann's constant ( $=5.670 \times 10^{-8}$  watts/m<sup>2</sup>K<sup>4</sup>),  $F_j$  the view factor, and  $\epsilon_j$  the emissivity.

The convective plus radiative heat transfer coefficient,  $h_{os,j}$ , is given in a simple expression as a function of wind speed,  $V_w$ (m/s).

$$h_{os,j} = a_0 + a_1 V_w + a_2 V_w^2 \quad (6.11)$$

in which  $a_0$ ,  $a_1$ , and  $a_2$  are coefficients which can be determined by the surface roughness index. Walton provided the values of these coefficients with respect to roughness index in his TARP reference manual [9]. The wind speed is the reported value without modification for surface height or orientation.

<u>IROFS</u>	$a_0$	$a_1$	$a_2$
1	11.58	5.894	0.0
2	12.49	4.065	0.028
3	10.79	4.192	0.0
4	8.23	4.000	-0.057
5	10.22	3.100	0.0
6	8.23	3.330	-0.036

The function HISCf contains expressions for heat transfer coefficients.

## 7. CONDUCTION TRANSFER FUNCTION CALCULATION

Conduction transfer functions of walls, floors, roofs, and windows are required by the TYPE51 subroutine for a building shell modeling. The subroutine also needs a term related to conductive heat fluxes on both external and internal surfaces of constructs. The CTFGEN program calculates the conduction transfer functions and the flux transfer functions. In this section, the overview of CTFGEN and the methodology employed in CTFGEN for computing conduction transfer functions will be described.

### 7.1 Overview of CTFGEN

The CTFGEN program consists of two portions: the front end and the main routines. In the front end portion, inputs and output operations are handled, and in the main routine, conduction transfer functions and flux transfer functions are determined. Thermal properties of building materials (thickness, thermal conductivity, density, specific heat, and thermal resistance) are stored in a sequential access data file (THERM.DAT). By using CTFGEN, thermal properties of additional building materials can be added in the data file. User selected building materials can be composed to form a multilayered building construct (sometimes called construction), after selecting necessary thermal property data from a temporary, direct access file, which contains the same information in the sequential access file.

The main calculation routine was originated from TARP, (slightly modified from BLAST) and its calculation procedure is as follows:

- (1) Determine the upper and lower bounds for searching roots (poles) for residue calculation and determine the roots (SEARCH)
- (2) Calculate derivative matrices and total construct matrices, and obtain residue elements for non-zero poles (DER, MATRIX)
- (3) Calculate zero residue elements (ZERORE)
- (4) Compute response factors and determine high order conduction transfer functions (RFCOMP)
- (5) Check convergence. If not converged, reduce the increment for searching and go to step (1)
- (6) Calculate flux transfer functions

Since a discussion of the calculation procedure involves a lengthy mathematical description, only important expressions will be reviewed in this report. Further detailed information may be found in references [27, 28].

## 7.2 Heat Conduction of a Multilayered Construct

Equation for heat conduction for a one-dimensional heat flow in a homogeneous layer of building material is given by

$$k \frac{\partial^2 T(x, t)}{\partial x^2} = \rho C_p \frac{\partial T(x, t)}{\partial t} \quad (7.1)$$

where  $T(x, t)$  is the temperature  $k$ ,  $\rho$ , and  $C_p$  are thermal conductivity, density, and specific heat, respectively. The heat flux through the slab is

$$q(x, t) = -k \frac{\partial T(x, t)}{\partial x} \quad (7.2)$$



Assuming that  $k$ ,  $\rho$ , and  $C_p$  are constant and  $T(x,0)=0$ , and applying Laplace transform on the above equations, ordinary differential equations in terms of  $x$  and Laplace parameter  $s$  are obtained.

$$\frac{d^2 T(x, s)}{dx^2} = \frac{s}{\alpha} T(x, s) \quad (7.3)$$

and

$$q(x, s) = -k \frac{dT(x, s)}{dx} \quad (7.4)$$

where  $\alpha$  is thermal diffusivity defined by  $k/\rho C_p$ . Imposing boundary conditions on equations (7.3) and (7.4) such that

$T_1(s) = T(0, s)$ ,  $T_2(s) = T(\ell, s)$ ,  $q_1(s) = q(0, s)$ , and  $q_2(s) = q(\ell, s)$ , where  $\ell$  is the thickness of the construct, a matrix expression is obtained.

$$\begin{bmatrix} T_1(s) \\ q_1(s) \end{bmatrix} = \begin{bmatrix} A(s) & B(s) \\ C(s) & D(s) \end{bmatrix} \begin{bmatrix} T_2(s) \\ q_2(s) \end{bmatrix} \quad (7.5)$$

where  $A(s) = \cosh(\ell\sqrt{\frac{s}{\alpha}})$

$$B(s) = \frac{1}{k} \sqrt{\frac{\alpha}{s}} \sinh(\ell\sqrt{\frac{s}{\alpha}})$$

$$C(s) = k \sqrt{\frac{s}{\alpha}} \sinh(\ell\sqrt{\frac{s}{\alpha}})$$

$$D(s) = \cosh(\ell\sqrt{\frac{s}{\alpha}})$$

Since a multilayered construct also has the same form of transfer matrix .

(transmission matrix) as the single-layered construct, the total construct matrix for n layers becomes

$$\begin{bmatrix} A(s) & B(s) \\ C(s) & D(s) \end{bmatrix} = \begin{bmatrix} A_1(s) & B_1(s) \\ C_1(s) & D_1(s) \end{bmatrix} \cdots \begin{bmatrix} A_n(s) & B_n(s) \\ C_n(s) & D_n(s) \end{bmatrix} \quad (7.6)$$

Equations (7.5) and (7.6) are coded in the subroutine MATRIX.

When the j-th layer of a multilayered construct has very low thermal capacitance, the transfer matrix of the j-th layer yields

$$\lim_{C_j \rightarrow 0} \begin{bmatrix} A_j(s) & B_j(s) \\ C_j(s) & D_j(s) \end{bmatrix} = \begin{bmatrix} 1 & \frac{\rho_j}{k_j} \\ 0 & 1 \end{bmatrix} \quad (7.7)$$

Heat flux equations on the outer (j=1) and inner (j=n+1) surfaces of the multilayered construct can be expressed as

$$\begin{bmatrix} q_o(s) \\ q_i(s) \end{bmatrix} = \begin{bmatrix} \frac{D(s)}{B(s)} & -\frac{1}{B(s)} \\ \frac{1}{B(s)} & -\frac{A(s)}{B(s)} \end{bmatrix} \begin{bmatrix} T_o(s) \\ T_i(s) \end{bmatrix} \quad (7.8)$$

where  $T_o(s) = T_1(s)$  and  $T_i(s) = T_{n+1}(s)$ .

With the sign convention for heat fluxes in the TARP program, the heat flux leaving the surface has a positive sense, as shown in Figure 6. Using this convention, equation (7.8) can be rewritten as

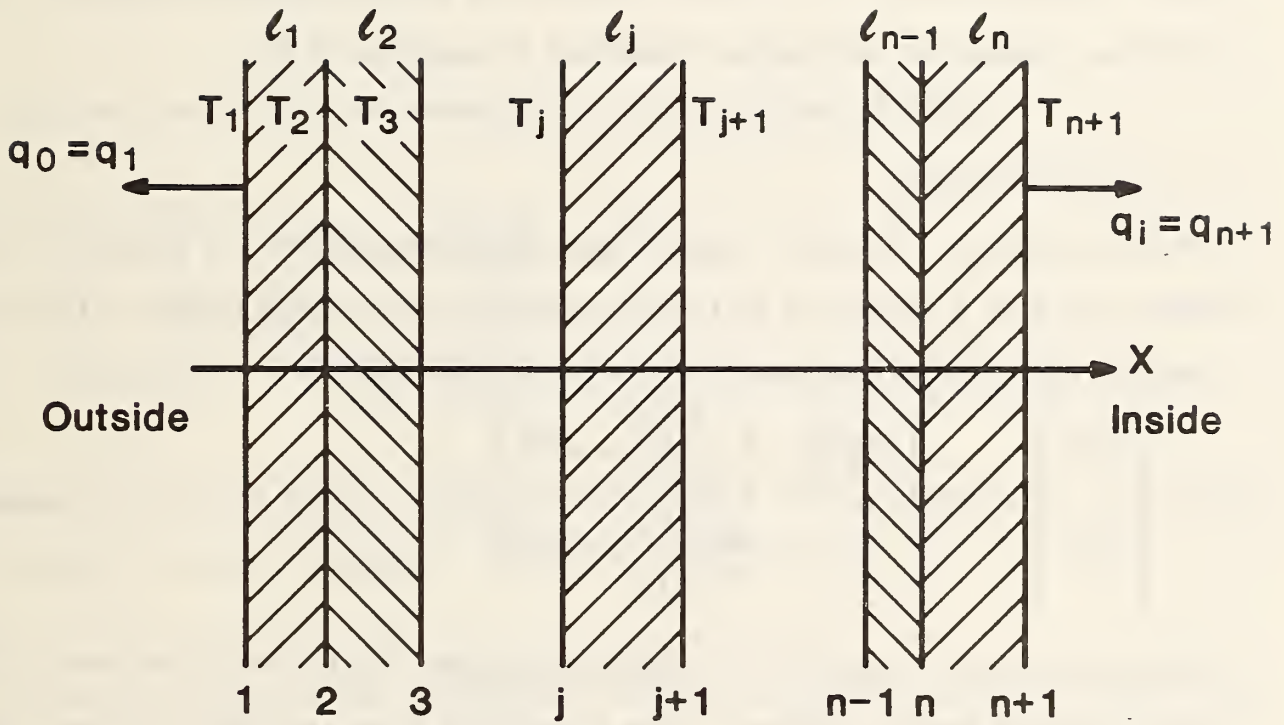

Figure 6. A multilayer construct

$$\begin{bmatrix} q_o(s) \\ q_i(s) \end{bmatrix} = \begin{bmatrix} -\frac{D(s)}{B(s)} & \frac{1}{B(s)} \\ \frac{1}{B(s)} & -\frac{A(s)}{B(s)} \end{bmatrix} \begin{bmatrix} T_o(s) \\ T_i(s) \end{bmatrix} \quad (7.9)$$

Heat flux equations in the time domain can be obtained by applying the inversion theorem of the Laplace transform to equation (7.9).

### 7.3 Response Factors

Assuming that the boundary temperature functions,  $T_i(t)$  and  $T_o(t)$ , can be represented by a series of pulse functions with a uniform time interval, equation (7.9) can be written as

$$\begin{bmatrix} q_o(s) \\ q_i(s) \end{bmatrix} = P(s) \begin{bmatrix} -\frac{D(s)}{B(s)} & \frac{1}{B(s)} \\ \frac{1}{B(s)} & -\frac{A(s)}{B(s)} \end{bmatrix} \begin{bmatrix} T_{o, t-m}(s) \\ T_{i, t-m}(s) \end{bmatrix} \quad (7.10)$$

where  $m=0,1,2,\dots,\infty$ , and  $P(s)$  is a pulse function in Laplace transform. The subscript  $t-m$  denotes the past time lagging  $m\delta$  from the current time. The variable  $\delta$  is sample time.

If the pulse function is represented by a triangular pulse with base of  $2\delta$  and unit height, and if response factors are defined as follows:

$$\text{external response factor: } \bar{X}_m = L^{-1} \left[ P(s) \frac{D(s)}{B(s)} \right]_{m=0,1,2,\dots} \quad (7.11)$$

$$\text{cross response factor: } \bar{Y}_m = L^{-1} \left[ P(s) \frac{1}{B(s)} \right]_{m=0,1,2\dots} \quad (7.12)$$

$$\text{internal response factor: } \bar{Z}_m = L^{-1} \left[ P(s) \frac{A(s)}{B(s)} \right]_{m=0,1,2\dots} \quad (7.13)$$

then the heat fluxes can be expressed in terms of response factors.

$$\begin{bmatrix} q_o(t) \\ q_i(t) \end{bmatrix} = \sum_{m=0}^{\infty} \begin{bmatrix} -\bar{X}_m & \bar{Y}_m \\ \bar{Y}_m & -\bar{Z}_m \end{bmatrix} \begin{bmatrix} T_{o,t-m}(t) \\ T_{i,t-m}(t) \end{bmatrix} \quad (7.14)$$

Kusuda [27] and Hittle [28] described well the procedure for computing response factors in detail.

The general formula for inverting a Laplace transformed expression  $q(s)$  based on Cauchy's residue theorem is given by

$$q(t) = \frac{1}{2\pi i} \oint_C q(s) e^{st} ds = \sum_j \text{Res}(a_j) \quad (7.15)$$

where  $t$  is time, and  $a_j$  is the  $j$ -th pole which is a root determined by setting the denominator of  $q(s)e^{st}$  to be zero, i.e.,  $B(s)=0$ .

A modified false position method is implemented for finding roots of an algebraic equation, and coded in the ILLINI subroutine. Improved root search

technique associated with the false position method was also used as suggested by Hittle and Bishop [29] in the subroutine SEARCH.

Generalized equation for response factors with roots  $\beta_j$  ( $j=1,2,\dots,\infty$ ) is

$$\bar{F}_m = (-1)^m a_m \left[ \frac{b_m R(s)}{B(s)} + \frac{R'(s)}{\delta B(s)} - \frac{R(s) B'(s)}{\delta [B(s)]^2} \right]_{s=0} \quad (7.16)$$

$$+ \sum_{j=1}^{\infty} \frac{R(s) e^{-(m+1)\delta\beta_j^2} (1 - c_m e^{\delta\beta_j^2})^2}{\delta\beta_j^4 B'(s)} \Big|_{s=-\beta_j^2}$$

where  $R'(s)$  and  $B'(s)$  are derivatives of  $R(s)$  and  $B(s)$ .

	$a_m$	$b_m$	$c_m$
$m=0$	1	1	0
$m=1$	1	0	2
$m>1$	0	0	1

$\bar{F}_m$	$R(s)$	$R'(s)$
$\bar{X}_m$	$D(s)$	$D'(s)$
$\bar{Y}_m$	1	0
$\bar{Z}_m$	$A(s)$	$A'(s)$

Total derivatives of  $A(s)$ ,  $B(s)$ , and  $D(s)$  are evaluated by differentiating the total construct matrix with respect to Laplace parameter  $s$ .

$$\begin{bmatrix} A'(s) & B'(s) \\ C'(s) & D'(s) \end{bmatrix} = \frac{d}{ds} \begin{bmatrix} A(s) & B(s) \\ C(s) & D(s) \end{bmatrix} \quad (7.17)$$

The subroutine DER computes the derivatives and the residue for non-zero poles,  $\beta_j^2$ , which is shown as the second term of equation (7.16). A portion of zero residue ( $s=0$ ) is calculated in the ZERORE subroutine, and its result is combined with that by the DER subroutine to form equation (7.16) in the subroutine RFCOMP.

An important property of response factors is

$$\left| \sum_{m=0}^{\infty} \bar{X}_m \right| = \left| \sum_{m=0}^{\infty} \bar{Y}_m \right| = \left| \sum_{m=0}^{\infty} \bar{Z}_m \right| = U \quad (7.18)$$

where U is the overall conductance represented by

$$U = \frac{1}{\sum_{i=1}^n \frac{\ell_i}{k_i}} = \frac{1}{\sum_{i=1}^n r_i} \quad (7.19)$$

$r_i$  is the thermal resistance of the  $i$ -th layer.

#### 7.4 Conduction Transfer Functions

As seen in equation (7.16), response factors when  $m > 1$  have the same form.

$$\bar{F}_m = \sum_{j=1}^{\infty} g_j \lambda_j^{m+1}, \quad m > 1 \quad (7.20)$$

$$\text{where } \lambda_j = e^{-\delta\beta_j^2} \text{ and } g_j = \frac{R(s) (1 - e^{\delta\beta_j^2})^2}{\delta\beta_j^4 B'(s)} \Big|_{s = -\beta_j^2}$$

The subscript  $j$  is the index of the roots of  $B(s)=0$ , all of which are located on the negative real axis.

Based on equation (7.20), conduction transfer functions (CTF) are defined such that for  $j$ -th order

$$F_{j,0} = \bar{F}_0 \quad (7.21)$$

$$F_{j,m} = F_{j-1,m} - \lambda_j F_{j-1,m-1} \quad (7.22)$$

For internal, cross, and external conduction transfer functions,  $F_{j,m}$  is replaced by  $X_{j,m}$ ,  $Y_{j,m}$ , and  $Z_{j,m}$ , respectively. Calculation of high order conduction transfer functions continues starting from the first order ( $j=1$ ) until the following condition is met:

$$|1 - H_{k,m}| < \epsilon \quad (m=1,2,\dots), \quad (7.23)$$

where

$$H_{k,m} = \frac{\sum_{j=1}^k F_{j,m}}{k \prod_{j=1}^k (1 - \lambda_j)}$$

and  $\epsilon$  is a small number.

When the convergence condition is satisfied, the resulting order is  $k$ . In



CTFGEN, the maximum order chosen is 5.

After computing CTF using equation (7.22), these CTF are again adjusted.

$$\begin{aligned}
 X_m &= X_{k,m}/H_{k,m} \\
 Y_m &= Y_{k,m}/H_{k,m} \\
 Z_m &= Z_{k,m}/H_{k,m}
 \end{aligned}
 \tag{7.24}$$

The  $X_m$ ,  $Y_m$ , and  $Z_m$  for  $m=1,2,\dots$  are calculated for each construct and stored in an output data file (CTFDATA.DAT).

Conductive heat flux equation incorporating with CTF are then represented by

$$q_i(t) = \sum_{m=0}^{N_t} Y_m T_{o,t-m} - \sum_{m=0}^{N_t} Z_m T_{i,t-m} + \sum_{j=1}^{N_f} R_j q_{i,t-j}
 \tag{7.25}$$

$$q_o(t) = \sum_{m=0}^{N_t} Y_m T_{i,t-m} - \sum_{m=0}^{N_t} X_m T_{o,t-m} = \sum_{j=1}^{N_f} R_j q_{o,t-j}
 \tag{7.26}$$

where  $R_j$  is the flux-related variable (flux transfer function). For  $N_f=5$ , Peavy [30] presented  $R_j$  values in terms of  $\lambda_j$ . See the subroutine RFCOMP. Calculated values of  $R_j$  are also stored in the output data file to be called by the TYPE51 subroutine.

## 8. WEATHER DATA

When a simulation involves building thermal loads, weather data are required by MODSIM. The subroutine RDENV in MODSIM expects to read outside air dry-bulb temperature, humidity ratio, barometric pressure, wind speed, direct normal solar beam radiation, sky diffuse radiation, and total horizontal solar radiation for each hour. The hourly weather data are interpolated for a fraction of an hour by using the spline interpolating routine which was explained in the section 4.3.

The program RDTAPE reads a weather tape (see Figure 1) and writes the selected weather data on an output data file (WTPOUT.DAT). The weather data in the file are transformed into the proper input format required by RDENV by the program CRWDTA. If a weather tape or equivalent is not available or some information from a weather tape is missing, CRWDTA generates artificial data to fill missing portions.

### 8.1 Weather Tape Reading Routine

The program RDTAPE requires inputs for the type of weather tape, the weather station identification number, and the beginning and ending dates of selected weather information. The conventional data is converted into Julian day and positioning a tape is performed based on the Julian day.

Since, for simplicity, the effects of rain, snow, and wind direction are not considered in the current version of HVACSIM<sup>+</sup>, the subroutines for reading

tapes were simplified accordingly. RDTAPE is capable to read four kinds of tapes: 'NOAA SOLMET,' 'NOAA Typical Meteorological Year (TMY),' 'NOAA Test Reference Year (TRY),' and 'Weather Year for Energy Calculation (WYEC),' tapes. Most of the subroutines in RDTAPE are based on BLAST [31] and TARP.

## 8.2 Weather Data File Generation

The program CRWDTA allows several options. It can read the output of RDTAPE and rewrite the information in the format required by RDENV, dividing total horizontal solar radiation values into beam and diffuse components if necessary. Alternatively, it can generate smooth 'design day' solar radiation and temperature data for a clear or cloudy sky design day. The latitude, longitude, and time zone data must be entered at the beginning of data file generation by CRWDTA. The output data file of CRWDTA (WEATHER.DAT) contains month, day, hour, dry-bulb temperature (C), humidity ratio (-), barometric pressure (kPa), wind speed (m/s), direct beam solar radiation ( $W/m^2$ ), sky diffusive radiation ( $W/m^2$ ), and total horizontal radiation ( $W/m^2$ ).

If information on direct beam or sky diffuse radiation is missing from a weather tape (e.g., WYEC tape), the direct and diffuse radiation values are computed by the subroutine WTPINP in the CRWDTA program. In order to use the correlation, equation of time, E, declination angle,  $\delta$ , extraterrestrial normal radiation intensity,  $G_{o,n}$ , are calculated using equations presented by Duffie and Beckman [32].

$$E = \frac{1}{60} [9.87 \sin(2B) - 7.53 \cos(B) - 1.5 \sin(B)] (h) \quad (8.1)$$

$$\delta = 23.45 \sin [2\pi(284+n)/365] \quad (\text{degrees}) \quad (8.2)$$

$$G_{o,n} = 1367 [1+0.033 \cos (2\pi n/365)] \quad (\text{W/m}^2) \quad (8.3)$$

where  $B = 2\pi(n-81)/364$

$n$  is the day of year,  $1 \leq n \leq 365$

Sunrise time,  $t_{sr}$ , and sunset time,  $t_{ss}$ , are

$$t_{sr} = \left( \frac{\text{LONG}}{15} - \text{TZN} \right) - E + 12 \left( 1 - \frac{\omega_s}{\pi} \right) \quad (8.4)$$

$$t_{ss} = \left( \frac{\text{LONG}}{15} - \text{TZN} \right) - E + 12 \left( 1 + \frac{\omega_s}{\pi} \right) \quad (8.5)$$

In the above equation, LONG is longitude angle in degrees, and  $\omega_s$  sunset hour angle given by

$$\omega_s = \cos^{-1} [-\tan(L)\tan(\delta)] \quad (8.6)$$

where  $L$  is latitude angle in degrees. Time zone number, TZN, in the United States for standard time is 4 = Atlantic, 5 = Eastern, 6 = Central, 7 = Mountain, or 8 = Pacific.

When total horizontal radiation,  $I_h$ , is zero, direct beam and diffuse radiation values are also zero. The following discussion refers only to hours

with non-zero  $I_h$ .

Since solar radiation data are generally integrated energy or average power over a period of an hour, the program uses the solar hour angle half an hour ago to represent the average solar position for the hour. Exceptions occur for the two hours each day which include sunrise or sunset. In these cases, only time interval after sunrise and before sunset is considered. Denoting  $\omega_1$  and  $\omega_2$  as solar hour angle at the beginning time and the ending time, respectively, for the  $i$ -th hour of the day, these hour angle expressions are

$$\omega_1 = \frac{\pi}{12} [\max(t_{i-1}, t_{sr}) - 12 + E + \text{TZN}] - \frac{\pi}{180} \text{LONG} \quad (8.7)$$

$$\omega_2 = \frac{\pi}{12} [\min(t_i, t_{ss}) - 12 + E + \text{TZN}] - \frac{\pi}{180} \text{LONG} \quad (8.8)$$

The cosine of the solar zenith angle,  $Z$ , is calculated using the average of  $\omega_1$  and  $\omega_2$ .

$$\cos(Z) = \sin(\delta) \sin(L) + \cos(\delta) \cos(L) \cos[(\omega_1 + \omega_2)/2] \quad (8.9)$$

Extraterrestrial horizontal radiation,  $I_0$ , is a time averaged value for an hour from  $\omega_1$  to  $\omega_2$ .

$$I_o = \frac{12}{\pi} G_{o,n} \left\{ \cos(L) \cos(\delta) [\sin(\omega_2) - \sin(\omega_1)] + (\omega_2 - \omega_1) \sin(L) \sin(\delta) \right\} \quad (8.10)$$

If direct beam radiation,  $I_b$ , is known and diffuse radiation,  $I_s$ , is missing, the value of  $I_s$  is obtained from

$$I_s = I_h - I_b \cos(Z) \quad (8.11)$$

If  $I_s$  is known while  $I_b$  is not given,  $I_b$  is computed from

$$I_b = (I_h - I_s) / \cos(Z) \quad (8.12)$$

When both  $I_s$  and  $I_b$  are unknown, the estimation of  $I_s$  is made using the hourly diffuse correlation of Erbs, Klein, and Duffie [33].

$$\frac{I_s}{I_h} = 1.0 - 0.09 k_T \text{ for } 0 < k_T \leq 0.22 \quad (8.13)$$

$$= 0.9511 - 0.1604 k_T + 4.388 k_T^2 - 16.638 k_T^3 + 12.336 k_T^4$$

for  $0.22 < k_T \leq 0.80$

$$= 0.165 \text{ for } 0.80 < k_T \leq 1.0$$

where  $k_T$  is the hourly clearness index given by

$$k_T = I_h / I_o \quad (8.14)$$

With  $I_s$  obtained by equation (8.13),  $I_b$  is calculated using equation (8.12).

The weather tapes mentioned previously do not give humidity ratio but dew point temperature. The humidity ratio is determined using the dew point temperature. Refer to section 6.1 and the function WF.

The program CRWDTA generates smooth artificial design day weather data if a weather tape or equivalent data file is not available. Clear or cloudy sky design day data can be created after entering input data: initial day and month, number of days for which weather calculation will be made, barometric pressure, wind speed, relative humidity, minimum and maximum dry-bulb temperatures.

To create cloudy sky design day data (ISFLAG =3), a fixed value of daily clearness index,  $\bar{k}_T$ , must be given. With this  $\bar{k}_T$ , hourly clearness index,  $k_T$ , at the  $i$ -th hour of day can be calculated from the following relation:

$$k_T = \bar{k}_T \left\{ a + b \cos[(\omega_1 + \omega_2)/2] \right\} \quad (8.15)$$

where  $a = 0.409 + 0.5016 \sin(\omega_s - \pi/3)$

$b = 0.6609 - 0.4767 \sin(\omega_s - \pi/3)$

Total horizontal radiation,  $I_h$ , is then obtained.

$$I_h = k_T I_o \quad (8.16)$$

Knowing  $I_h$ , equations (8.11) and (8.12) give the values of  $I_s$  and  $I_b$ . See the subroutine SOLAR.

Clear sky design day data (ISFLAG=2) is generated by the subroutine SOLAR in CRWDTA. CRWDTA implements all three methods presented by Machler and Iqbal [34]. The method used by the program depends upon user's responses to questions asked when clear sky data generation is requested. Horizontal visibility, geographic correction factor, and precipitable water are involved.

Method 1 is the simplest method, which is a modification of the ASHRAE clear sky irradiation algorithm. When horizontal visibility is zero, the method 1 is used.

$$I_b = k_A A_m e^{-\alpha B_m} \quad (8.16)$$

$$I_s = C_m I_h \quad (8.17)$$

where  $A_m$ ,  $B_m$ , and  $C_m$  are apparent solar constant, exponential attenuation coefficient, and diffuse fraction factor, respectively. These are sets of twelve constants, one for each month. Machler and Iqbal presented modified values of  $A_m$ ,  $B_m$ , and  $C_m$ . The variable  $\alpha$  is defined by

$$\alpha = (P/P_0) / \cos(Z) \quad (8.18)$$



in which  $P$ ,  $P_0$  and  $Z$  are barometric pressure, standard atmospheric pressure (=101.3kPa) and zenith angle, respectively.

The correction factor for regional variation,  $k_A$ , is 'clearness number' listed in ASHRAE Handbook (e.g., 1981 Fundamentals, p. 27.8) [35].

Method 2 uses horizontal visibility at ground level as a parameter of atmospheric turbidity. If horizontal visibility is not zero, but precipitable atmospheric moisture is zero, the method 2 is used.

$$I_b = G_{o,n} \tau_a (0.775)^{f(0.5)} \quad (8.19)$$

$$I_s = I_b (0.1 + 0.3/VIS) \quad (8.20)$$

where  $f(x)$  is defined by  $a^x$  (i.e.,  $f(0.5)=a^{0.5}$ ),  $VIS$  is horizontal visibility at ground level in km, and  $\tau_a$  is atmospheric transmittance.

$$\tau_a = (1 - 1.13 VIS^{-0.57})^{f(0.85)} \quad (8.21)$$

Method 3 is applied to modify the equation for  $I_b$ , if a non-zero value for precipitable water is given.

$$I_b = G_{o,n} \tau_a (0.775)^{f(0.5)} (1.0223 - 0.00149M)^{f(0.27)} \quad (8.22)$$

where  $M$  is the precipitable water in mm.

Approximated dry-bulb temperature calculation is made using empirical values shown in the table of ASHRAE Handbook [35] for summertime. For the  $i$ -th hour,

$$T_i = T_{\max} - (T_{\max} - T_{\min}) \rho_i / 100 \quad (8.23)$$

where  $T_{\max}$ ,  $T_{\min}$ , and  $\rho_i$  are design day maximum, minimum temperatures, and percentage of the daily range as empirical values. This temperature calculation is coded in the subroutine DB. Note that equation (8.23) is not valid for wintertime. Calculation procedure for wintertime temperature has not been implemented in CRWDTA.

Assuming constant relative humidity for a day, hourly humidity ratio is computed using the expressions in ASHRAE Handbook p. 6.4. The subroutine HUMIDY determines the hourly humidity ratio.

## 9. SIMULATION PROCEDURE

Generally, a computer simulation using HVACSIM+ involves three steps: preprocessing, simulation, and postprocessing.

### 9.1 Preprocessing - Input Data Generation

#### (1) Creation of Simulation Work File

The building load and the system component portions are considered as separate parts. The type description file (TYPAR.DAT) must be accessible by both HVAOGEN and SLIMCON. See the Reference Manual [7] and the Users Guide [8] for details.

#### -----Building Load Component Portion-----

- (i) Draw a sketch of the building to be simulated and divide the building shell into a number of zones as necessary.
- (ii) Make block diagrams for the building load components and assign a UNIT number to each component along with the proper TYPE number.
- (iii) Fill out all the required information on the worksheets, which are appended in APPENDIX B, for the building load components: TYPE50, TYPE51, TYPE52, and TYPE53.
- (iv) Execute the HVAOGEN program. During the execution, enter necessary data which was prepared on the worksheets. Note that one of SUPERBLOCKS is reserved only for the zone envelope (TYPE50), the building surface (TYPE51), and the weather input (TYPE53). Zone

models (TYPE52) should reside in the other SUPERBLOCK or SUPERBLOCKS which may also contain the system component models.

----- System Component Portion -----

- (i) Draw a sketch of the building system to be simulated.
- (ii) Make block diagrams for system components which serve the zones, and assign a UNIT number to each component with a proper TYPE number.
- (iii) Fill out all the required information on the worksheets, which are appended in APPENDIX in reference [8], for the system components.
- (iv) Execute the HVACGEN program. Enter necessary information and edit the simulation work file if needed.

(2) Creation of Model Definition File

After creating the simulation work file, the SLIMCON program can generate the model definition file (MODELDEF.DAT) for the MODSIM program from the simulation work file. Since it is very difficult to make any changes in the model definition file, any changes should be made in the simulation work file instead.

(3) Creation of Boundary Variable File

Any explicitly defined, indexed input or output variables in TYPEN subroutines can be boundary variables.

- (i) Edit the simulation work file to declare the boundary variables using the HVACGEN program.
- (ii) Make a boundary data file (BOUNDARY.DAT) using a user's editing program. The first column of the boundary variable data file must

contain values of time (Time intervals need not be equal). For step changes, two sequential records should be entered having the same value of time but different values of a boundary variable.

#### (4) Creation of Conduction Transfer Function File

- (i) Find out what kind materials are used to form the building envelope element ( wall, roof, ceiling, floor, partition, or window).
- (ii) Search the thermal property data bank of building materials (THERM.DAT) whether required data are available. If not, obtain thermal property data from other sources.
- (iii) Execute the CTFGEN program interactively to add thermal property data and/or obtain conduction transfer functions of the specific constructs. When a construct has very low thermal capacitance ( $C_p \approx 0$ ), the value of thermal resistance must be specified. The output file of CTFGEN (CTFDATA.DAT) will be used by the RDENV subroutine of the MODSIM program.

#### (5) Creation of Weather Data File

- (i) Execute the RDTAPE program interactively to read weather information from a weather tape or equivalent.
- (ii) Using the output file of the RDTAPE program (WTPOUT.DAT), execute the CRWDTA program to create the weather data file (WEATHER.DAT) for the subroutine RDENV of the MODSIM program. If no weather tape data is accessible or for simplicity it is not desired to use a weather tape for simplicity, an artificial weather data file can be generated by the CRWDTA program.

## 9.2 Simulation

### (1) Allocation of Output Files

The output files of the MODSIM program, MODSUM.DAT, MODOUT.DAT, and INITOUT.DAT, are automatically allocated on the computer disk storage spaces by the Fortran77 OPEN statements in the MODSIM.

### (2) Execution of MODSIM

A simulation is performed by MODSIM using previously created data files. During the execution, some of the data can be monitored on the screen of a computer terminal. With the building model, a simulation involves two steps of execution. The first step is the initialization run for temperature and flux histories for computation of conductive heat transfer rates for a given period of time, usually 24 hours. The second step is the actual simulation.

### (3) Continuation of Simulation

At the end of each run of MODSIM for a given period, the output file, INITOUT.DAT, is created. This file has all of the data which are needed to continue the simulation at the next time period. However, INITOUT.DAT must be renamed as INITIN.DAT before the next, continuing simulation is begun. Otherwise no continuation of the simulation is made.

## 9.3 Postprocessing - Output Data Analysis

Execution of the SORTSB program produces a sorted data file for a specific SUPERBLOCK from the MODOUT.DAT file. This step is necessary to generate an input file for a user-supplied plotting routine, if more than one SUPERBLOCK is associated.

## 10. REFERENCES

- [1] Klein, S.A., et al., 'TRNSYS, A Transient System Simulation Program,' Report 38-12, University of Wisconsin, Dec. 1983.
- [2] Kelly, G.E., Park, C., Clark, D.R., and May, W.B., 'HVACSIM<sup>+</sup>, A Dynamic Building/HVAC/Control Systems Simulation Program,' Proc. of Workshop on HVAC Controls Modeling and Simulation, Georgia Inst. of Tech., Atlanta, GA, Feb. 2-3, 1984.
- [3] Hill, C.R., 'Simulation Techniques for Building Systems,' Proc. of Workshop on HVAC Controls Modeling and Simulation, Georgia Inst. of Tech., Atlanta, GA, Feb. 2-3, 1984.
- [4] Hill, C.R., 'Simulation of a Multizone Air Handler,' ASHRAE Trans., Vol. 91, Part 1, 1985.
- [5] Clark, D.R., Hurley, C.W., and Hill, C.R., 'Dynamic Models for HVAC System Components,' ASHRAE Trans. Vol. 91, Part 1, 1985.
- [6] Park, C., Clark, D.R., and Kelly, G.E., 'An Overview of HVACSIM<sup>+</sup>, A Dynamic Building/HVAC/Control Systems Simulation Program,' the 1st Annual Building Energy Simulation Conference, Seattle, WA, August 21-22, 1985.
- [7] Clark, D.R., 'HVACSIM<sup>+</sup> Building Systems and Equipment Simulation Program Reference Manual,' NBSIR 84-2996, National Bureau of Standards, Jan. 1985.
- [8] Clark, D.R., and May, W.B., Jr., 'HVACSIM<sup>+</sup> Building Systems and Equipment Simulation Program Users Guide,' NBSIR 85-3243, National Bureau of Standards, Sept. 1985.

- [9] Walton, G.N., 'Thermal Analysis Research Program Reference Manual,' NBSIR 83-2655, National Bureau of Standards, March 1983.
- [10] NBS 'Guide to Available Mathematical Software (GAMS),' Center for Applied Math., National Bureau of Standards, Oct. 1981
- [11] Hiebert, K.L., 'An Evaluation of Mathematical Software that Solves Systems of Nonlinear Equations,' ACM Trans. Math. Software, Vol. 8, No. 1, March 1982, pp. 5-20.
- [12] Powell, M.J.D., 'A Hybrid Method for Nonlinear Equations,' in Numerical Methods for Nonlinear Algebraic Equations, P. Rabinowitz, Ed., Gordon and Breach, London, 1970.
- [13] Broyden, C.G., 'A Class of Methods for Solving Nonlinear Simultaneous Equations,' Math. Comp., Vol. 19, 1965, pp. 577-593.
- [14] Ralston, A. and Rabinowitz, P., A First Course in Numerical Analysis, McGraw-Hill, 1978.
- [15] Dennis, J.E. and Schnabel, R.B., Numerical Methods for Unconstrained Optimization and Nonlinear Equations, Prentice-Hall, 1983.
- [16] Fox, P.A., Hall, A.D., and Schryer, N.L., 'Algorithm 528 Framework for a Portable Library [Z],' ACM Trans. on Math. Software, Vol. 4, No. 2, June 1978, pp. 177-188.
- [17] Brayton, R.K., Gustavson, F.G., and Hachtel, G.D., 'A New Efficient Algorithm for Solving Differential - Algebraic Systems Using Implicit Backward Differential Formulas,' Proc. IEEE, Vol. 60, No. 1, Jan. 1972, pp. 98-108.
- [18] Gear, C.W., 'The Automatic Integration of Ordinary Differential Equations,' Comm. ACM, Vol. 14, March 1971, pp. 176-179.



- [19] Nordsieck, A., 'On Numerical Integration of Ordinary Differential Equations,' Math. Comp., Vol. 16, 1962, pp. 22-49.
- [20] Chua, L.O., and Lin, P., Computer-Aided Analysis of Electronic Circuits, Prentice-Hall, 1975.
- [21] Ferziger, J.H., Numerical Methods for Engineering Application, John Wiley, 1981.
- [22] Kusuda, T., 'NBSLD, The Computer Program for Heating and Cooling Loads in Building,' BSS 69, National Bureau of Standards, July 1976.
- [23] Threlkeld, J.L., Thermal Environmental Engineering, 2nd ed., Prentice-Hall, 1970.
- [24] Brokaw, R.S., 'Calculation of Flue Losses for High-Efficiency Furnaces and Appliances,' ASHRAE J., Jan. 1979, pp.49-51.
- [25] Kusuda, T. and Saitch, T., 'Simplified Analysis Calculations for Residential Applications,' NBSIR 80-1961, National Bureau of Standards, July 1980.
- [26] Carroll, J.A., 'A Comparison of Radiant Interchange Algorithms,' ASME/SSEA Conf., April 1981.
- [27] Kusuda, T., 'Thermal Response Factors for Multilayer Structures of Various Heat Conduction Systems,' ASHRAE Trans., Vol. 75, 1969, pp. 246-270.
- [28] Hittle, D.C., 'Calculating Building Heating and Cooling Loads Using the Frequency Response of Multilayered Slabs,' Report CERL-TM-E-169, Construction Engineering Research Lab, 1981.

- [29] Hittle, D.C., and Bishop, R., 'An Improved Root-Finding Procedure for Use in Calculating Transient Heat Flow Through Multilayered Slabs,' Int. J. Heat and Mass Transfer, Vol. 26, No. 11, 1983, pp. 1685-1693.
- [30] Peavy, B.A., 'A Note on Response Factors and Conduction Transfer Functions,' ASHRAE Trans., Vol. 84, 1978, pp. 688-690.
- [31] Hittle, D.C., 'The Building Loads Analysis and System Thermodynamics (BLAST) Program, Version 2.0: User Manual,' Tech. Rep. E-153, Construction Engineering Research Laboratory, 1979.
- [32] Duffie, J.A. and Beckman, W.A., Solar Engineering of Thermal Processes, John Wiley, 1980.
- [33] Erbs, D.G., Klein, S.A., and Duffie, J.A., 'Estimation of Diffuse Radiation Fraction for Hourly, Daily, and Monthly Average Global Radiation,' Solar Energy Laboratory, University of Wisconsin, Madison, 1981.
- [34] Machler, M.A., and Iqbal, M. 'A Modification of the ASHRAE Clear Sky Irradiation Model,' ASHRAE Trans. Vol. 91, 1985.
- [35] ASHRAE, 1981 Fundamentals Handbook, ASHRAE, 1981.

=====

APPENDIX A: Short Descriptions of Functions and Subroutines in HVACSIM+

=====

(1) Primary Program of HVACSIM+

\* Main Program

( File : MODSIM5 )

MODSIM - Modular simulation program

\* Input/Output

( File : MODINOS )

BLOCK DATA - Assignment of logical unit numbers to files, setting numerical values of typical properties of air and water, and giving label names

BOUNDS - Reading of time-dependent boundary variables, and interpolating them using the 3rd order Lagrangian interpolation

INDATA - Entering input data for a simulation on the console

OPNFIL - Opening of input and output files

RCONF - Reading of the model definition and the initialization files

REPORT - Generation of the report file at equal intervals

SUMARY - Writing of a summary of configuration of simulation

VLAB - Returning labels and numbers

\* Block and State Variable Status Control

( File : MODBLK5 )

ASEMBL - Assembling of BLOCK inputs and outputs

BACTIV - Control of BLOCK activity

FRZVAR - Variable freezing

INPUTS - Assignment of state variables to inputs of UNIT

INSCAN - Scanning the inputs of SUPERBLOCKs to detect changes larger than the error tolerance

- INTLIZ - Initialization of the simulation
- OUTPUT - Storing of outputs from UNIT
- RESTAT - Resetting of outputs of a BLOCK for unfrozen variables
- UNFREZ - Checking for frozen variables

\* Integration of Stiff Ordinary Differential Equations

( File : MODBDF5 )

- BAKDIF - Calculation of derivatives using backward difference formulars
- CALN - Computation of the minimum time step
- ECNTRL - Calculation of truncation errors and determination of time step and integration order
- IPERM - Permutation of vectors
- NORDER - Increasing or decreasing the order of integration
- PREDIK - Calculation of predicted values for the next time step
- RESET - Resetting the differential equation integrator
- SAVECO - Saving and replacing coefficients
- UPDATE - Updating coefficients for BAKDIF and PREDIK

\* Routines needed for Solving a System of Equations

( File : MODEQT5 )

- BLOCK - Calculation of a new state vector by calling a BLOCK
- FNC - Calculation of the residual functions for a BLOCK
- SUPERB - Calculation of a new state vector by calling a SUPERBLOCK
- SUPFNC - Calculation of the residual functions for a SUPERBLOCK

( File : SELECT5 )

- SELECT - Calling TYPE<sub>n</sub> subtoutines

\* Nonlinear Algebraic Equation Solver

( File : SNSQA )

- SNSQ - Finding a zero of a system of nonlinear functions
- SNSQ1 - The same as SNSQ but called by the BLOCK subroutine
- SNSQ2 - The abbreviated version of SNSQ

( File : SNSQB )

- DOGLEG - Determination of the convex combination  $x$  of the Gauss-Newton and scaled gradient directions
- ENORM - Calculation of the Euclidean norm of  $x$
- QFORM - Accumulation of orthogonal matrix  $Q$  from the computed QR factorization
- QRFAC - QR factorization of a matrix using Householder transformations
- R1MPYQ - Computation of  $A*Q$  for a given matrix  $A$
- R1UPDT - Determination of an orthogonal matrix  $Q$

( File : SNSQC )

- FDJAC1 - A forward difference approximation to the Jacobian matrix. Called by SNSQ.
- FDJAC2 - The same as FDJAC1 except argument. Called by SNSQ1 and SNSQ2.
- R1MACH - Machine-dependent constants for the local computer environment

\* Models of HVAC Components and Controls

( File : TYPES )

- TYPE1 - Fan and pump model
- TYPE2 - Conduit (duct or pipe)
- TYPE3 - Inlet conduit (duct or pipe)
- TYPE4 - Flow merge
- TYPE5 - Damper or valve
- TYPE6 - Flow split
- TYPE7 - Temperature sensor
- TYPE8 - Proportional-Integral controller

- TYPE9 - Linear valve with pneumatic actuator
- TYPE10 - Hot water coil model
- TYPE11 - Hot water to air heating coil
- TYPE12 - Cooling or dehumidifying coil
- TYPE13 - Three-way valve model
- TYPE14 - Evaporative humidifier
- TYPE15 - Room model with constant zone loads
- TYPE16 - Sticky proportional controller
- TYPE17 - Mixing dampers and merge
- TYPE18 - Plenum
- TYPE19 - Flow balance control
- TYPE20 - High/low limit controller
- TYPE21 - Clamped split
- TYPE22 - Steam spray humidifier
- TYPE23 - Steam nozzle
- TYPE24 - Ideal gas nozzle
- TYPE25 - Steam to air heating coil
- TYPE26 - Control signal inverter
- TYPE27 - Moist air flow merge
- TYPE28 - Constant flow resistance
- TYPE29 - Inlet constant flow resistance

\* Building Loads Model components

( File : TYPESB )

- TYPE50 - Zone envelope (Building Shell)
- TYPE51 - Building surface (Building Shell)
- TYPE52 - Zone model

TYPE53 - Weather input (Building Shell)

\* Supporting Utility for System Components

( File : UTILITY )

HYSTER - Hysterisis of actuators

DELAY - Transport delays in ducting components

SUFED - Coefficients for the polynomial of the efficiency of heat exchanger fin

BESI - Modified Bessel function

BESK - K Bessel function

POLFIT - Polynomial fitting

\* Supporting Utility for Building Load Components

( File : UTILITYB )

CP - Specific heat of moist air, vapor pressure, air exchange rate, and humidity ratio at saturated state

HISCF - Computation of convective heat transfer coefficient of the inner surface to the zone air, convective plus radiative heat transfer coefficient of the outer surface, and radiative heat transfer coefficient of the inner surface

VIEW - View factors using MRT network method

( File : RDENV )

RDENV - Reading of weather data and conduction transfer functions. Interpolation of hourly data using the spline interpolation.

SPLINE - The second derivatives for the spline interpolation

SPEVAL - Interpolation by using the cubic spline method

\* Steam and Liquid Water Properties

( File : WATPR )

TSATS - Saturation temperature of steam vs. pressure

PSATS - Saturation pressure of steam vs. temperature

- VSATS - Saturation specific volume of steam vs. temperature and pressure
- VSATW - Saturation specific volume of water vs. saturation temperature
- HSATW - Saturation enthalpy of liquid water vs. saturation temperature
- HFG - Latent heat of vaporization of water vs. saturation temperature
- HSATS - Enthalpy of saturated steam vs. saturation temperature
- SSATW - Saturation entropy of liquid water vs. saturation temperature
- SSATS - Entropy of saturated steam vs. saturation temperature
- VS - Specific volume of superheated steam vs. pressure and temperature
- HS - Enthalpy of superheated steam vs. pressure and temperature
- SS - Entropy of superheated steam vs. pressure and temperature
- TPSS - Temperature of steam vs. pressure and entropy
- CPS - Specific heat of steam at constant pressure vs. temperature
- CVS - Specific heat of steam at constant volume vs. specific volume and temperature
- VISSV - Dynamic viscosity of saturated vapor vs. pressure
- VISSPH - Dynamic viscosity of superheated steam vs. temperature
- STEAMK - Thermal conductivity of superheated steam vs. temperature
- WRHO - Density of water vs. temperature
- WMU - Viscosity of water vs. temperature
- WK - Thermal conductivity vs. temperature
- WCP - Specific heat of water vs. temperature

\* Air Properties

( File : AIRPR )

- CPCVA - Specific heats of air at constant pressure and volume, and speed of sound in air



- HA - Enthalpy of air vs. temperature
- PHIA - Entropy of air vs. temperature
- TPHIA - Temperature of air vs. entropy
- VISCA - Dynamic viscosity of air vs. temperature
- AKA - Thermal conductivity of air vs. temperature

\* Refrigerant Properties

( File : REFRIGPR )

- REFRIG - BLOCK DATA for coefficients of refrigerant equations
- PSAT - Saturation pressure of refrigerant vs. temperature
- TSAT - Saturation temperature of refrigerant vs. saturation pressure
- TVSAT - Saturation temperature of refrigerant vs. saturation specific volume
- PGAS - Pressure of refrigerant vs. specific volume and temperature
- VGAS - Specific volume of refrigerant vs. pressure and temperature
- HGAS - Enthalpy of refrigerant vs. pressure, specific volume, and temperature
- SGAS - Entropy of refrigerant vs. specific volume and temperature
- HPS - Enthalpy of refrigerant vs. pressure and entropy
- TPH - Temperature of refrigerant vs. pressure and enthalpy
- TVH - Temperature of refrigerant vs. specific volume and enthalpy
- DHLAT - Latent heat of vaporization of refrigerant vs. pressure, specific volume, and temperature
- RHOLIQ - Density of refrigerant vs. temperature
- CV - Specific heat of refrigerant at constant volume vs. specific volume and temperature
- CPCV - Specific heats of refrigerant at constant volume and pressure, and speed of sound in refrigerant vs. specific volume and temperature

## (2) Conduction Transfer Function Calculation

( File : CTFGEN )

- CTF - Main program to create the CTF data file (CTFDATA.DAT)
- THERMP - Adding new data of thermal properties of building materials in the thermal property data file (THERM.DAT)
- BANKTP - Making a temporary direct access file of the thermal property data
- DER - Calculation of the total construct and total derivative matrices, and determination of residue elements for a non-zero root
- DUMPRF - Printing description of conductive layers, values of roots, conduction transfer functions, and flux transfer functions
- ERROR - Printing error messages
- ILLINI - Computation of roots in the interval using modified false position method
- INITRF - Calling subroutines related to calculation of conduction transfer functions
- MATRIX - Evaluation of the conduction matrix for a multilayered slab
- ROOMP - Computation of conduction transfer and flux transfer functions for multilayered constructs
- SEARCH - Determination of the upper and lower bounds within which a root must exist.
- ZERORE - Calculation of zero residue elements

## (3) Weather Data

\* Weather Tape Reading

( File : RDTAPE )

- RDTAPE - Main program to read weather tapes
- RDWTP - Positioning and checking weather tapes
- RDSOLM - Reading of a NOAA SOLMET tape
- RDTMY - Reading of a NOAA Typical Meteorological Year (TMY) tape

- RDTRY - Reading of a NOAA Test Reference Year (TRY) tape
- RDWYEC - Reading of Weather Year for Energy Calculations (WYEC) tape
- WRTFIL - Writing output data (WTPOUT.DAT)
- JDS - Evaluation of Julian date

\* Weather Data File Generation

( File : CRWDTA )

- CRWDTA - Main program to create the weather data file
- WTPINP - Reading the output file of the RDTAPE program and computation of solar radiation data which are missed in the weather tape
- WF - Humidity ratio vs. dew point temperature and pressure
- SOLAR - Generation of artificial weather data of solar radiation
- DB - Design day outdoor air dry-bulb temperature for summer
- HUMIDY - Humidity ratio assuming constant relative humidity
- COPYFL - Writing outputs on the weather data file (WEATHER.DAT)

(4) Front-End Program for Handling a Simulation Work File

\* Main Module

( File : HVAOGEN1 )

- HVAOGE - Main program of the HVAOGEN program
- INFORM - BLOCK DATA containing the types of data and COMMON BLOCK information
- DATAIN - Verification of input information
- COPMOD - Input data processor
- CHECK - Checking whether the parsed word is a number
- REWORD - Checking whether the input is reserved word
- REMAIN - Control of transfer to the requested module
- HOLDIT - Producing a pause for acknowledgment of error display

- SCROLL - Making a screen display paused when the screen is full
- OKAY - Checking whether an existing value is acceptable
- RITE - Displaying of console messages and menu
- PROMPT - Providing the index labels corresponding to category numbers

\* Create Module

( File : HVAOGEN2 )

- CREATE - Control of transfer to the proper routine for create mode
- CRUNIT - Creating a UNIT to be used in a work file
- CRBLK - Creating a BLOCK to be used in a work file
- CRSUP - Creating a SUPERBLOCK to be used in a work file
- CRSIM - Calling CRSIM1, CRSIM2, CRSIM3, and CRSIM4 for SIMULATION setup
- CRSIM1 - Entering the simulation title, and error tolerances
- CRSIM2 - Entering initial values of state variables
- CRSIM3 - Entering boundary information
- CRSIM4 - Entering the information of reported variables
- RECRT - Calling a proper module according to the entry of reserved words (ABORT, HELP, VIEW, EDIT, and TYPES )
- TYPES - Listing the TYPEs available in the TYPAR.DAT file

\* File Control Module

( File : HVAOGEN3 )

- FSAVE - Calling the routine for saving the created file for UNIT, BLOCK, SUPERBLOCK, or SIMULATION setup
- READIN - Selecting the module for reading a file based on the file extension
- OPNFIL - Entering the file name and opening the file
- RDUNT - Reading the file of UNIT with the extension UNT
- RDBLK - Reading the file of BLOCK with the extension BLK

- RDSIM - Reading the file of SIMULATION setup with the extension SIM
- SAVUNT - Writing information to the UNIT file
- SAVBLK - Writing information to the BLOCK file
- SAVSUP - Writing information to the SUPERBLOCK file
- SAVSIM - Writing information to the SIMULATION file
- TYPEIN - Creating a direct access file for TYPAR.DAT at the first call, and reading the information from the direct access file.

\* View Module

( File : HVAOGEN4 )

- VIEW - Control of transfer to the proper routine for view mode
- VEWUNT - Viewing the inputs, outputs, and parameters for the UNIT
- VEWBLK - Viewing the information for the BLOCK
- VEWSIM - Providing the menu for different view options
- STRUCT - Viewing of the structure of the SIMULATION setup
- VARVAL - Viewing of the initial values of state variables for inputs in the SIUMULATION
- BOUND - Viewing of the boundary information for the SIMULATION
- RPTVAR - Viewing of the reported variables in the SIMULATION
- ERROR - Viewing of the error tolerances, and the freezing and scan options in the SIMULATION
- REVEW - Directing to either HELP or ABORT mode
- VEWALL - Viewing of all information in the SIMULATION

\* Edit and Help Module

( File : HVAOGEN5 )

- EDIT - Control of transfer to the proper routine for edit mode
- EDUNT - Editing the information in the UNIT
- EDSIM - Editing the information in the SIMULATION

- EDITL - Editing the title
- EDSTR - Calling the routines for editing the structure
- EDVAL - Editing the initial values of state variables
- EDBND - Calling the routines for editing the boundary information
- INSERT - Entering the index of a boundary variable to the SIMULATION
- DELETE - Deleting the index of a boundary variable from the SIMULATION
- EDREP - Calling the routines for editing the information of reported variables
- PRCHNG - Editing the reporting interval
- RPINRT - Entering the index of a reported variable to the SIMULATION
- RPDELT - Deleting the index of a reported variable from the SIMULATION
- EDERR - Editing the error tolerances and the freezing and scan options
- REEDT - Calling the help module
- REEDIT - Calling the help module (similar to REEDT)

( File : HVAOGEN6 )

- INSSIM - Calling the routine for inserting or replacing UNIT or BLOCK
- INSUNT - Inserting a UNIT in the SIMULATION
- INSCHK - Giving the number of UNITs in the BLOCK
- INSBLK - Inserting a BLOCK in the SIMULATION
- INCK2 - Giving the information of SUPERBLOCK and UNIT to the subroutine INSBLK
- RECALC - Recalculation of the new position of the variables in the state vector after an insertion
- TYPINF - Getting information of the input and output category indexes from the TYPAR.DAT file
- REBND - Calculation of the new position in the state vector of the boundary variables
- REPERT - Calculation of the new position in the state vector of the reported variables

- DELSIM - Calling the routine for deleting a UNIT or BLOCK from a SIMULATION
- DELUNT - Deleting a UNIT from the SIMULATION setup
- DELBLK - Deleting a BLOCK from the SIMULATION setup
- DELCHK - Checking the UNIT number to be deleted
- DELCK2 - Checking the BLOCK number to be deleted
- REPSIM - Calling the routine for replacing a UNIT in the SIUMULATION
- REPUNT - Replacing a UNIT in the SIMULATION
- HELP - Description of available commands in the HVACGEN program
- EXTBLK - Saving the information in the BLOCK of the SIMULATION file in a BLOCK file

#### (5) Model Definition File Generation

(File : SLIMCON )

- SIMCON - Main program of the SLIMCON program to generate a model definition file (MODELDEF.DAT) using a simulation work file with the extension SIM
- FILEOP - Opening the input and output files
- TYPAR - Getting information from the TYPAR.DAT file
- REPORT - Displaying the configuration parameters along with the maximum values assigned
- VARCHK - Checking whether any of the time-dependent boundary variables are solved simultaneously
- OUTCHK - Checking if two or more outputs are assigned to a single state variable
- TDBVIS - Finding the largest number of time-dependent boundary variables in any one SUPERBLOCK

#### (6) Sorting the Raw Data File

( File : SORTSB )

- SORTSB - Program to sort the raw output data file (MODOUT.DAT) for each SUPERBLOCK to create a data file which can be used as an input data file to a user-supplied plotting routine





\*\*\*\*\*

TYPE 51 BUILDING SURFACE

UNIT=

INPUTS:

TIA: Indoor air dry-bulb temperature (C) -----T  
TMR: Mean radiant temperature (C) -----T  
TOSINF: Outer surface temperature of unexposed wall(C)-----T  
FSHADW: Shaded fraction of exposed outer surface (-) -----C

OUTPUTS:

TIS: Inner surface temperature (C) -----T  
SOLINT: Integrated solar flux incident on surface (W/m2) ---Q

PARAMETERS:

1 IZN: Identification number of zone -----  
2 ID: Identification number of surface -----  
3 IEXPSO: 0=W/in zone, 1=betw. zones, 2=exposed to sun (-) ---  
4 ISTR: Identification number of the construct -----  
5 AS: Surface area (m2) -----  
6 ORIENT: Azimuth angle between normal to surface & south ----  
7 TILT: Tilt angle : flat roof=0, floor=180 (degree) -----  
8 GRF: Ground reflectivity (-) -----  
9 IROFS: Outer surface roughness index [1,6] (-) -----  
10 ABSOS: Solar absorptance of the outer surface (-) -----  
11 ABSIS: Short wave absorptance of the inner surface -----  
12 EMITIS: Emissivity of the inner surface (-) -----  
13 TRANSM: Transmittance of the glass window (-) -----  
14 SC: Shading coefficient of the glass window (-) -----

NOTE: If outer surface is exposed to outside air (IEXPOS=2),  
the index of TOSINF may be the same index of TIS.

The orientation angle of an west facing surface is 90  
degrees, while an east facing surface is 270 degrees.

The surface roughness index, IROFS, is defined as follows:

IROFS = 1 Stucco  
2 Brick, rough plaster  
3 Concrete  
4 Clear pine  
5 Smooth plaster  
6 Glass, paint on pine

\*\*\*\*\*

TYPE 52 ZONE MODEL

UNIT=

INPUTS:

PIAG: Gage pressure of zone air (kPa) -----P  
TIA: Zone air dry-bulb temperature (C) -----T  
WIA: Humidity ratio of zone air (-) -----H  
PSAG: Gage pressure of supply air (kPa) -----P  
MSA: Mass flow rate of supply air (kg/s) -----M  
TSA: Supply air dry-bulb temperature (C) -----T  
WSA: Humidity ratio of supply air (-) -----H  
QWALL: Convective heat gain from building surfaces (kW) ---Q  
NUMPEP: Number of people (occupant in the zone) -----C  
UTCEQP: Equipment utilization coeff. (-) -----C  
UTCLIT: Lighting utilization coeff. (-) -----C

OUTPUTS:

TIA: Zone air dry-bulb temperature [diff. eq.] (C) -----T  
WIA: Humidity ratio of zone air [diff. eq.] -----H  
QISW: Internal (short wave) radiant gain from lights(kW)--Q  
QILW: Internal (long wave) radiant gain (kW) -----Q

PARAMETER:

1 IZN: Identification number of zone -----  
2 CFUR: Effective thermal capacitance of furnishing (kJ/K) -  
3 EFFMIA: Air mass multiplier for zone moisture capacitance --  
4 VOLUME: Volume of zone air (interior space of zone) (m3) ---  
5 SAIREX: Std air exchange rate (0.5=tight,1.0=std,1.5=leaky)-  
6 WPEPS: Sensible heat gain from a person (kW) -----  
7 WPEPL: Latent heat gain from a person (kW) -----  
8 WLIT: Heat gain due to lighting in the zone (kW) -----  
9 LIGHT: 1 = Fluorescent, 2 = Incandescent -----  
10 WEQPS: Sensible heat gain due to equipment (kW) -----  
11 WEQPL: Latent heat gain due to equipment (kW) -----  
12 REQP: Radiative to sensible heat from equipment (-)-----

\*\*\*\*\*

TYPE 53 WEATHER INPUT

UNIT=

INPUTS:

TAMB: Ambient (outdoor) air temperature (C)-----T  
HUMRAT: Outdoor air humidity ratio (-) -----H  
PBAR: Barometric pressure (kPa) -----P  
IDN: Direct normal solar radiation (W/m2) -----Q  
ISKY: Diffuse (sky) solar radiation (W/m2) -----Q  
IHOR: Total horizontal solar radiation (W/m2) -----Q

OUTPUTS: none

PARAMETERS:

- 1 Index for ambient temperature (e.g. 5 if TAMB= T5) -----
- 2 Index for outdoor air humidity ratio -----
- 3 Index for barometric pressure -----
- 4 Index for direct normal solar radiation -----
- 5 Index for diffuse (sky) solar radiation -----
- 6 Index for total horizontal solar radiation -----

=====

APPENDIX C: Example 1 One-zone Building Model

=====

A single-zone building model is simulated in this example, following the Simulation Procedure outlined in Chapter 9 of this report. The purpose of the example is to demonstrate how to use HVACSIM+ with the building loads model described in this report (see Figure 1). No system component is connected to the zone and no boundary variable is considered. Artificially generated weather data is used. Screen images of I/O operation during the executions of programs and all related data files are presented. Different results from the outputs of this example are anticipated when a computer with different values of machine precisions from those used in this example. See the function R1MACH in the file SNSQC.

The machine precisions used are:

R1MACH(1) = 5.3976E-79  
R1MACH(2) = 7.2370E+75  
R1MACH(3) = 5.9605E-8  
R1MACH(4) = 9.5367E-7

A. Preprocessing - Input Data Generation

(1) Creation of Simulation Work File

As shown in Figure C-1, the example model is an office module located on a floor (other than the top or ground floor) of a multi-story building. The building surfaces faced to the south are exposed to the sun, while other surfaces are unexposed, interior surfaces.

Figure C-2 is a simplified block diagram which shows the input-output connections of UNITS. Since UNIT 9 (Weather Input) has no direct connection to any UNIT, it is not shown here.

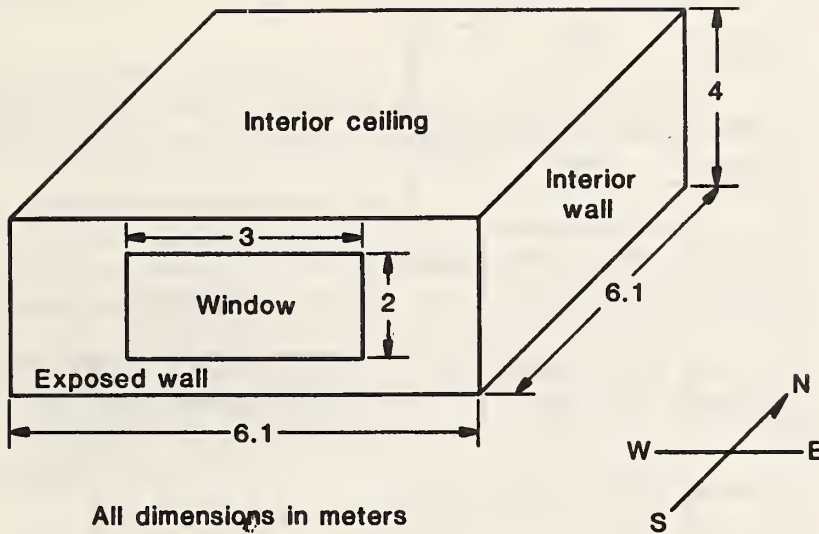

All dimensions in meters

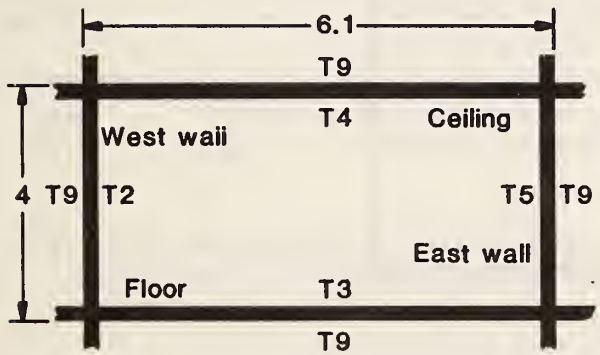

VIEW FROM THE SOUTH

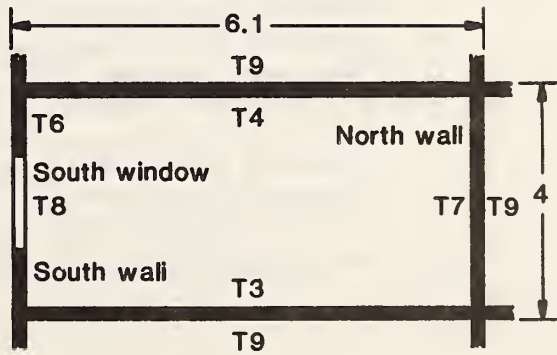

VIEW FROM THE EAST

Figure C-1. A single-zone model

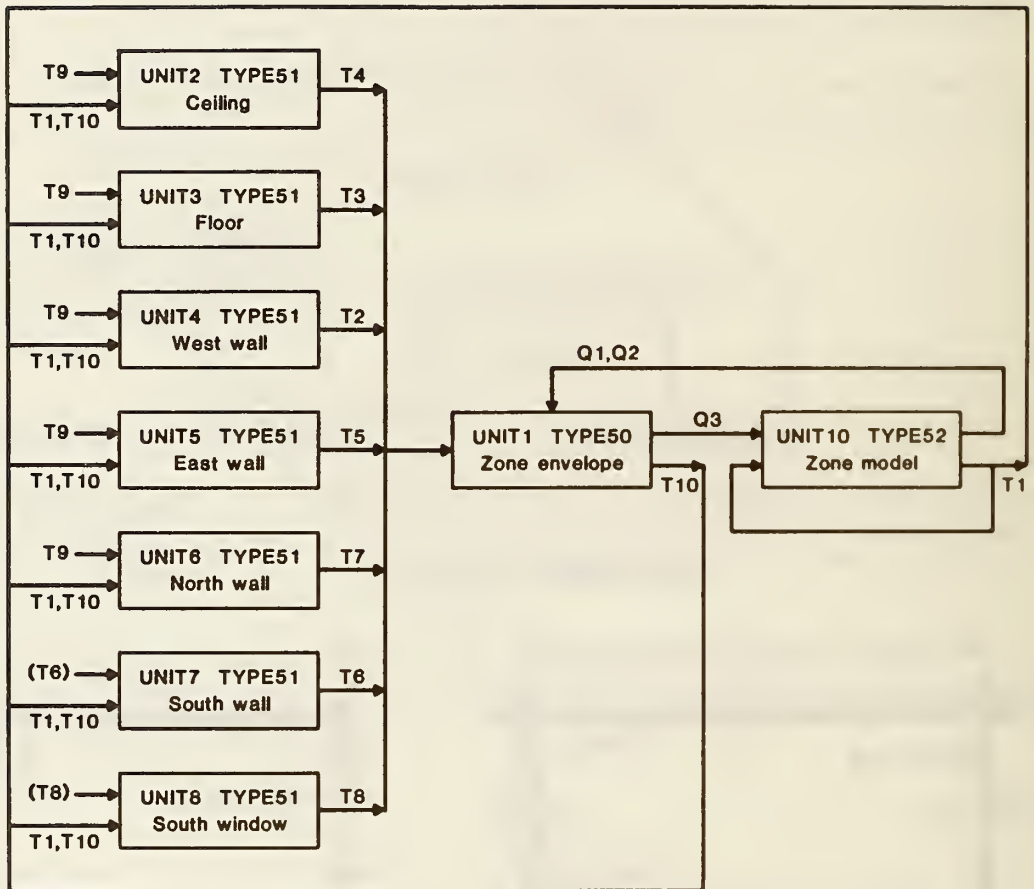

Figure C-2. Block diagram of the single-zone model



\*\*\*\*\*

TYPE 51 BUILDING SURFACE *ceiling* UNIT= 2

INPUTS:

TIA: Indoor air dry-bulb temperature (C) -----T 1  
TMR: Mean radiant temperature (C) -----T 10  
TOSINF: Outer surface temperature of unexposed wall(C)-----T 9  
FSHADW: Shaded fraction of exposed outer surface (-) -----C 5

OUTPUTS:

TIS: Inner surface temperature (C) -----T 4  
SOLINT: Integrated solar flux incident on surface (W/m2) ---Q 0

PARAMETERS:

1 IZN: Identification number of zone ----- 1  
2 ID: Identification number of surface ----- 1  
3 IEXPSO: 0=W/in zone, 1=betw. zones, 2=exposed to sun (-) --- 1  
4 ISTR: Identification number of the construct ----- 1  
5 AS: Surface area (m2) ----- 37.21  
6 ORIENT: Azimuth angle between normal to surface & south ---- 0  
7 TILT: Tilt angle : flat roof=0, floor=180 (degree) ----- 0  
8 GRF: Ground reflectivity (-) ----- 0  
9 IROFS: Outer surface roughness index [1,6] (-) ----- 0  
10 ABSOS: Solar absorptance of the outer surface (-) ----- 0  
11 ABSIS: Short wave absorptance of the inner surface ----- 0.6  
12 EMITIS: Emissivity of the inner surface (-) ----- 0.9  
13 TRANSM: Transmittance of the glass window (-) ----- 0  
14 SC: Shading coefficient of the glass window (-) ----- 0

NOTE: If outer surface is exposed to outside air (IEXPOS=2),  
the index of TOSINF may be the same index of TIS.

The orientation angle of an west facing surface is 90  
degrees, while an east facing surface is 270 degrees.

The surface roughness index, IROFS, is defined as follows:

IROFS = 1 Stucco  
2 Brick, rough plaster  
3 Concrete  
4 Clear pine  
5 Smooth plaster  
6 Glass, paint on pine



\*\*\*\*\*

TYPE 51 BUILDING SURFACE *Floor* UNIT=3

INPUTS:

TIA: Indoor air dry-bulb temperature (C) -----T1  
 TMR: Mean radiant temperature (C) -----T10  
 TOSINF: Outer surface temperature of unexposed wall(C)-----T9  
 FSHADW: Shaded fraction of exposed outer surface (-) -----C5

OUTPUTS:

TIS: Inner surface temperature (C) -----T3  
 SOLINT: Integrated solar flux incident on surface (W/m2) ---Q0

PARAMETERS:

1 IZN: Identification number of zone ----- 1  
 2 ID: Identification number of surface ----- 2  
 3 IEXPSO: 0=W/in zone, 1=betw. zones, 2=exposed to sun (-) --- 1  
 4 ISTR: Identification number of the construct ----- 2  
 5 AS: Surface area (m2) ----- 37.21  
 6 ORIENT: Azimuth angle between normal to surface & south ---- 0  
 7 TILT: Tilt angle : flat roof=0, floor=180 (degree) ----- 180  
 8 GRF: Ground reflectivity (-) ----- 0  
 9 IROFS: Outer surface roughness index [1,6] (-) ----- 0  
 10 ABSOS: Solar absorptance of the outer surface (-) ----- 0  
 11 ABSIS: Short wave absorptance of the inner surface ----- 0.6  
 12 EMITIS: Emissivity of the inner surface (-) ----- 0.9  
 13 TRANSM: Transmittance of the glass window (-) ----- 0  
 14 SC: Shading coefficient of the glass window (-) ----- 0

NOTE: If outer surface is exposed to outside air (IEXPOS=2), the index of TOSINF may be the same index of TIS.

The orientation angle of an west facing surface is 90 degrees, while an east facing surface is 270 degrees.

The surface roughness index, IROFS, is defined as follows:

- IROFS = 1 Stucco
- 2 Brick, rough plaster
- 3 Concrete
- 4 Clear pine
- 5 Smooth plaster
- 6 Glass, paint on pine

\*\*\*\*\*

TYPE 51 BUILDING SURFACE *West Wall* UNIT= 4

INPUTS:

TIA: Indoor air dry-bulb temperature (C) -----T 1  
TMR: Mean radiant temperature (C) -----T 10  
TOSINF: Outer surface temperature of unexposed wall(C)-----T 9  
FSHADW: Shaded fraction of exposed outer surface (-) -----C 5

OUTPUTS:

TIS: Inner surface temperature (C) -----T 2  
SOLINT: Integrated solar flux incident on surface (W/m2) ---Q 0

PARAMETERS:

1 IZN: Identification number of zone ----- 1  
2 ID: Identification number of surface ----- 3  
3 IEXPSO: 0=W/in zone, 1=betw. zones, 2=exposed to sun (-) --- 1  
4 ISTR: Identification number of the construct ----- 3  
5 AS: Surface area (m2) ----- 24.4  
6 ORIENT: Azimuth angle between normal to surface & south ---- 90  
7 TILT: Tilt angle : flat roof=0, floor=180 (degree) ----- 90  
8 GRF: Ground reflectivity (-) ----- 0  
9 IROFS: Outer surface roughness index [1,6] (-) ----- 0  
10 ABSOS: Solar absorptance of the outer surface (-) ----- 0  
11 ABSIS: Short wave absorptance of the inner surface ----- 0.6  
12 EMITIS: Emissivity of the inner surface (-) ----- 0.9  
13 TRANSM: Transmittance of the glass window (-) ----- 0  
14 SC: Shading coefficient of the glass window (-) ----- 0

NOTE: If outer surface is exposed to outside air (IEXPOS=2),  
the index of TOSINF may be the same index of TIS.

The orientation angle of an west facing surface is 90  
degrees, while an east facing surface is 270 degrees.

The surface roughness index, IROFS, is defined as follows:

IROFS = 1 Stucco  
2 Brick, rough plaster  
3 Concrete  
4 Clear pine  
5 Smooth plaster  
6 Glass, paint on pine

\*\*\*\*\*

TYPE 51 BUILDING SURFACE *East Wall* UNIT= 5

INPUTS:

TIA: Indoor air dry-bulb temperature (C) -----T 1  
TMR: Mean radiant temperature (C) -----T 10  
TOSINF: Outer surface temperature of unexposed wall(C)-----T 9  
FSHADW: Shaded fraction of exposed outer surface (-) -----C 5

OUTPUTS:

TIS: Inner surface temperature (C) -----T 5  
SOLINT: Integrated solar flux incident on surface (W/m2) ---Q 0

PARAMETERS:

1 IZN: Identification number of zone ----- 1  
2 ID: Identification number of surface ----- 4  
3 IEXPSO: 0=W/in zone, 1=betw. zones, 2=exposed to sun (-) --- 1  
4 ISTR: Identification number of the construct ----- 3  
5 AS: Surface area (m2) ----- 24.4  
6 ORIENT: Azimuth angle between normal to surface & south ---- 270  
7 TILT: Tilt angle : flat roof=0, floor=180 (degree) ----- 90  
8 GRF: Ground reflectivity (-) ----- 0  
9 IROFS: Outer surface roughness index [1,6] (-) ----- 0  
10 ABSOS: Solar absorptance of the outer surface (-) ----- 0  
11 ABSIS: Short wave absorptance of the inner surface ----- 0.6  
12 EMITIS: Emissivity of the inner surface (-) ----- 0.9  
13 TRANSM: Transmittance of the glass window (-) ----- 0  
14 SC: Shading coefficient of the glass window (-) ----- 0

NOTE: If outer surface is exposed to outside air (IEXPOS=2),  
the index of TOSINF may be the same index of TIS.

The orientation angle of an west facing surface is 90  
degrees, while an east facing surface is 270 degrees.

The surface roughness index, IROFS, is defined as follows:

- IROFS = 1 Stucco
- 2 Brick, rough plaster
- 3 Concrete
- 4 Clear pine
- 5 Smooth plaster
- 6 Glass, paint on pine

\*\*\*\*\*

TYPE 51 BUILDING SURFACE *North Wall* UNIT= 6

INPUTS:

TIA: Indoor air dry-bulb temperature (C) -----T 1  
TMR: Mean radiant temperature (C) -----T 10  
TOSINF: Outer surface temperature of unexposed wall(C)-----T 9  
FSHADW: Shaded fraction of exposed outer surface (-) -----C 5

OUTPUTS:

TIS: Inner surface temperature (C) -----T 7  
SOLINT: Integrated solar flux incident on surface (W/m2) ---Q 0

PARAMETERS:

1 IZN: Identification number of zone ----- 1  
2 ID: Identification number of surface ----- 5  
3 IEXPSO: 0=W/in zone, 1=betw. zones, 2=exposed to sun (-) --- 1  
4 ISTR: Identification number of the construct ----- 3  
5 AS: Surface area (m2) ----- 24.4  
6 ORIENT: Azimuth angle between normal to surface & south ---- 180  
7 TILT: Tilt angle : flat roof=0, floor=180 (degree) ----- 90  
8 GRF: Ground reflectivity (-) ----- 0  
9 IROFS: Outer surface roughness index [1,6] (-) ----- 0  
10 ABSOS: Solar absorptance of the outer surface (-) ----- 0  
11 ABSIS: Short wave absorptance of the inner surface ----- 0.6  
12 EMITIS: Emissivity of the inner surface (-) ----- 0.9  
13 TRANSM: Transmittance of the glass window (-) ----- 0  
14 SC: Shading coefficient of the glass window (-) ----- 0

NOTE: If outer surface is exposed to outside air (IEXPOS=2),  
the index of TOSINF may be the same index of TIS.

The orientation angle of an west facing surface is 90  
degrees, while an east facing surface is 270 degrees.

The surface roughness index, IROFS, is defined as follows:

IROFS = 1 Stucco  
2 Brick, rough plaster  
3 Concrete  
4 Clear pine  
5 Smooth plaster  
6 Glass, paint on pine

\*\*\*\*\*

TYPE 51 BUILDING SURFACE *South Wall* UNIT= 7

INPUTS:

TIA: Indoor air dry-bulb temperature (C) -----T 1  
TMR: Mean radiant temperature (C) -----T 10  
TOSINF: Outer surface temperature of unexposed wall(C)-----T 6  
FSHADW: Shaded fraction of exposed outer surface (-) -----C 4

OUTPUTS:

TIS: Inner surface temperature (C) -----T 6  
SOLINT: Integrated solar flux incident on surface (W/m2) ---Q 5

PARAMETERS:

1 IZN: Identification number of zone ----- 1  
2 ID: Identification number of surface ----- 6  
3 IEXPSO: 0=W/in zone, 1=betw. zones, 2=exposed to sun (-) --- 2  
4 ISTR: Identification number of the construct ----- 4  
5 AS: Surface area (m2) ----- 18.4  
6 ORIENT: Azimuth angle between normal to surface & south ---- 0  
7 TILT: Tilt angle : flat roof=0, floor=180 (degree) ----- 90  
8 GRF: Ground reflectivity (-) ----- 0.2  
9 IROFS: Outer surface roughness index [1,6] (-) ----- 2  
10 ABSOS: Solar absorptance of the outer surface (-) ----- 0.6  
11 ABSIS: Short wave absorptance of the inner surface ----- 0.6  
12 EMITIS: Emissivity of the inner surface (-) ----- 0.9  
13 TRANSM: Transmittance of the glass window (-) ----- 0  
14 SC: Shading coefficient of the glass window (-) ----- 0

NOTE: If outer surface is exposed to outside air (IEXPOS=2),  
the index of TOSINF may be the same index of TIS.

The orientation angle of an west facing surface is 90  
degrees, while an east facing surface is 270 degrees.

The surface roughness index, IROFS, is defined as follows:

IROFS = 1 Stucco  
2 Brick, rough plaster  
3 Concrete  
4 Clear pine  
5 Smooth plaster  
6 Glass, paint on pine

\*\*\*\*\*

TYPE 51 BUILDING SURFACE *South Window* UNIT= *g*

INPUTS:

TIA: Indoor air dry-bulb temperature (C) -----T *1*  
 TMR: Mean radiant temperature (C) -----T *10*  
 TOSINF: Outer surface temperature of unexposed wall(C)-----T *g*  
 FSHADW: Shaded fraction of exposed outer surface (-) -----C *4*

OUTPUTS:

TIS: Inner surface temperature (C) -----T *g*  
 SOLINT: Integrated solar flux incident on surface (W/m2) ---Q *4*

PARAMETERS:

1 IZN: Identification number of zone ----- 1  
 2 ID: Identification number of surface ----- 7  
 3 IEXPSO: 0=W/in zone, 1=betw. zones, 2=exposed to sun (-) --- 2  
 4 ISTR: Identification number of the construct ----- 5  
 5 AS: Surface area (m2) ----- 6.0  
 6 ORIENT: Azimuth angle between normal to surface & south --- 0  
 7 TILT: Tilt angle : flat roof=0, floor=180 (degree) ----- 90  
 8 GRF: Ground reflectivity (-) ----- 0.2  
 9 IROFS: Outer surface roughness index [1,6] (-) ----- 6  
 10 ABSOS: Solar absorptance of the outer surface (-) ----- 0  
 11 ABSIS: Short wave absorptance of the inner surface ----- 0  
 12 EMITIS: Emissivity of the inner surface (-) ----- 0  
 13 TRANSM: Transmittance of the glass window (-) ----- 0.95  
 14 SC: Shading coefficient of the glass window (-) ----- 0.85

NOTE: If outer surface is exposed to outside air (IEXPOS=2), the index of TOSINF may be the same index of TIS.

The orientation angle of an west facing surface is 90 degrees, while an east facing surface is 270 degrees.

The surface roughness index, IROFS, is defined as follows:

- IROFS = 1 Stucco
- 2 Brick, rough plaster
- 3 Concrete
- 4 Clear pine
- 5 Smooth plaster
- 6 Glass, paint on pine

\*\*\*\*\*

TYPE 53 WEATHER INPUT

UNIT= 9

INPUTS:

TAMB: Ambient (outdoor) air temperature (C)-----T/2  
HUMRAT: Outdoor air humidity ratio (-) -----H3  
PBAR: Barometric pressure (kPa) -----P3  
IDN: Direct normal solar radiation (W/m2) -----Q6  
ISKY: Diffuse (sky) solar radiation (W/m2) -----Q7  
IHOR: Total horizontal solar radiation (W/m2) -----Q8

OUTPUTS: none

PARAMETERS:

1 Index for ambient temperature (e.g. 5 if TAMB= T5) -----/2  
2 Index for outdoor air humidity ratio ----- 3  
3 Index for barometric pressure ----- 3  
4 Index for direct normal solar radiation ----- 6  
5 Index for diffuse (sky) solar radiation ----- 7  
6 Index for total horizontal solar radiation ----- 8

\*\*\*\*\*

TYPE 52 ZONE MODEL

UNIT= 10

INPUTS:

PIAG: Gage pressure of zone air (kPa) -----P /  
 TIA: Zone air dry-bulb temperature (C) -----T /  
 WIA: Humidity ratio of zone air (-) -----H /  
 PSAG: Gage pressure of supply air (kPa) -----P 2  
 MSA: Mass flow rate of supply air (kg/s) -----M /  
 TSA: Supply air dry-bulb temperature (C) -----T //  
 WSA: Humidity ratio of supply air (-) -----H 2  
 QWALL: Convective heat gain from building surfaces (kW) ---Q 3  
 NUMPEP: Number of people (occupant in the zone) -----C /  
 UTCEQP: Equipment utilization coeff. (-) -----C 2  
 UTCLIT: Lighting utilization coeff. (-) -----C 3

OUTPUTS:

TIA: Zone air dry-bulb temperature [diff. eq.] (C) -----T /  
 WIA: Humidity ratio of zone air [diff. eq.] -----H /  
 QISW: Internal (short wave) radiant gain from lights(kW)--Q /  
 QILW: Internal (long wave) radiant gain (kW) -----Q 2

PARAMETER:

1 IZN: Identification number of zone ----- 1  
 2 CFUR: Effective thermal capacitance of furnishing (kJ/K) - 200  
 3 EFFMIA: Air mass multiplier for zone moisture capacitance -- 4  
 4 VOLUME: Volume of zone air (interior space of zone) (m3) --- 148.84  
 5 SAIREX: Std air exchange rate (0.5=tight,1.0=std,1.5=leaky)- 1.0  
 6 WPEPS: Sensible heat gain from a person (kW) ----- 0.07176  
 7 WPEPL: Latent heat gain from a person (kW) ----- 0.0454  
 8 WLIT: Heat gain due to lighting in the zone (kW) ----- 0.2  
 9 LIGHT: 1 = Fluorescent, 2 = Incandescent ----- 1  
 10 WEQPS: Sensible heat gain due to equipment (kW) ----- 0.15  
 11 WEQPL: Latent heat gain due to equipment (kW) ----- 0.02  
 12 REQ: Radiative to sensible heat from equipment (-)----- 0.3



-----  
 \* Initial Conditions of State Variables  
 -----

P1	Zone air pressure, gage	0.0 kPa
P2	Supply air pressure, gage	0.0 kPa
P3	Barometric pressure of ambient air	101.3 kPa
M1	Supply air mass flow rate	0.0 kg/s
T1	Zone air dry-bulb temperature	20.0 C
T2	Inner surface temperature of west wall	20.0 C
T3	Inner surface temperature of floor	20.0 C
T4	Inner surface temperature of ceiling	20.0 C
T5	Inner surface temperature of east wall	20.0 C
T6	Inner surface temperature of south wall	20.0 C
T7	Inner surface temperature of north wall	20.0 C
T8	Inner surface temperature of south window	20.0 C
T9	Outer surface temperature of unexposed surfaces	20.0 C
T10	Mean radiant temperature	20.0 C
T11	Supply air dry-bulb temperature	20.0 C
T12	Ambient temperature	20.0 C
C1	Number of people	1.0
C2	Equipment utilization coefficient	1.0
C3	Light utilization coefficient	1.0
C4	Shaded fraction of exposed outer surface	0.0
C5	Shaded fraction of unexposed surfaces	1.0
Q1	Short wave radiant heat gain	0.0 kW
Q2	Long wave radiant heat gain	0.0 kW
Q3	Convective heat gain from building surfaces	0.0 kW
Q4	Average solar radiation influx of window	0.0 kW
Q5	Average solar radiation influx of exposed wall	0.0 kW
Q6	Direct solar radiation	0.0 kW
Q7	Diffuse solar radiation	0.0 kW
Q8	Total horizontal solar radiation	0.0 kW
H1	Zone air humidity ratio	0.0074
H2	Supply air humidity ratio	0.0074
H3	Ambient air humidity ratio	0.0074

-----  
\* Execution of HVACGEN  
-----

HVACGEN - Simulation GENERation Program  
Version 1.8 (08-16 1985)

Choose from the list below:

CReate (SiMulation,BlOck,UNit)

EDit (SiMulation,UNit)

ViEw (SiMulation,BlOck,UNit)

HEIp

ENd

Selection ?

VI SI ONEZONE

reading from work file....

INITIALIZING TYPES INFORMATION...

What part of the simulation would you like to view:

All the simulation information (for documentation)

Structure (superblock,block, and unit information)

Variable initial values

Error tolerances, variable scan and freeze options

Boundary variables

REported variables

COntinue with the previous menu

AL

ONE ZONE MODEL

SUPERBLOCK 1

BLOCK 1

UNIT 1	TYPE 50 - ZONE ENVELOPE
UNIT 2	TYPE 51 - BUILDING SURFACE
UNIT 3	TYPE 51 - BUILDING SURFACE
UNIT 4	TYPE 51 - BUILDING SURFACE
UNIT 5	TYPE 51 - BUILDING SURFACE
UNIT 6	TYPE 51 - BUILDING SURFACE
UNIT 7	TYPE 51 - BUILDING SURFACE
UNIT 8	TYPE 51 - BUILDING SURFACE

BLOCK 2

UNIT 9	TYPE 53 - WEATHER INPUT
--------	-------------------------

UNIT 1 TYPE 50  
ZONE ENVELOPE

## 1 INPUTS:

TEMPERATURE	1 - TIA:	Zone air dry-bulb temperature
POWER	1 - QISW:	Internal (short wave) radiant gain
POWER	2 - QILW:	Internal (long wave) radiant gain
TEMPERATURE	2 - TIS(1):	Inner surface temperature
TEMPERATURE	3 - TIS(2):	Inner surface temperature
TEMPERATURE	4 - TIS(3):	Inner surface temperature
TEMPERATURE	5 - TIS(4):	Inner surface temperature
TEMPERATURE	6 - TIS(5):	Inner surface temperature
TEMPERATURE	7 - TIS(6):	Inner surface temperature
TEMPERATURE	8 - TIS(7):	Inner surface temperature
TEMPERATURE	8 - TIS(8):	Inner surface temperature
TEMPERATURE	8 - TIS(9):	Inner surface temperature
TEMPERATURE	8 - TIS(10):	Inner surface temperature

## 2 OUTPUTS:

TEMPERATURE	10 - TMR:	Mean radiant temperature
POWER	3 - QWALL:	Convective heat gain from surfaces

## 3 PARAMETERS:

1.00000	IZN:	Identification number of zone
7.00000	NS:	Number of surfaces of zone

UNIT 2 TYPE 51  
BUILDING SURFACE

## 1 INPUTS:

TEMPERATURE	1 - TIA:	Indoor air dry-bulb temperature
TEMPERATURE	10 - TMR:	Mean radiant temperature
TEMPERATURE	9 - TOSINF:	Outer surface temp. of unexposed wall
CONTROL	5 - FSHADW:	Shaded fraction of exposed surface

## 2 OUTPUTS:

TEMPERATURE	4 - TIS:	Inner surface temperature
POWER	0 - SOLINT:	Integrated solar influx on surface

## 3 PARAMETERS:

1.00000	IZN:	Identification number of zone
1.00000	ID:	Identification number of surface
1.00000	IEXPOS:	0=W/in zone, 1=betw.zones, 2=exposed to sun
1.00000	ISTR:	Identification number of the construct
37.2100	AS:	Surface area (m2)
0.000000	ORIENT:	Azimuth angle of normal to surface & south
0.000000	TILT:	Tilt angle: flat roof=0, floor=180 (degree)
0.000000	GRF:	Ground reflectivity (-)
0.000000	IROFS:	Outer surface roughness index: 1=stucco,...
0.000000	ABSOS:	Solar absorptance of outer surface (-)
0.600000	ABSIS:	Short wave absorptance of inner surface(-)
0.900000	EMITIS:	Emissivity of the inner surface (-)
0.000000	TRANSM:	Transmittance of the glass window (-)
0.000000	SC:	Shading coeff. of the glass window (-)

-----  
UNIT 3 TYPE 51  
BUILDING SURFACE

1 INPUTS:  
TEMPERATURE 1 - TIA: Indoor air dry-bulb temperature  
TEMPERATURE 10 - TMR: Mean radiant temperature  
TEMPERATURE 9 - TOSINF: Outer surface temp. of unexposed wall  
CONTROL 5 - FSHADW: Shaded fraction of exposed surface

2 OUTPUTS:  
TEMPERATURE 3 - TIS: Inner surface temperature  
POWER 0 - SOLINT: Integrated solar influx on surface

3 PARAMETERS:  
1.00000 IZN: Identification number of zone  
2.00000 ID: Identification number of surface  
1.00000 IEXPOS: 0=W/in zone, 1=betw.zones, 2=exposed to sun  
2.00000 ISTR: Identification number of the construct  
37.2100 AS: Surface area (m2)  
0.000000 ORIENT: Azimuth angle of normal to surface & south  
180.000 TILT: Tilt angle: flat roof=0, floor=180 (degree)  
0.000000 GRF: Ground reflectivity (-)  
0.000000 IROFS: Outer surface roughness index: 1=stucco,...  
0.000000 ABSOS: Solar absorptance of outer surface (-)  
0.600000 ABSIS: Short wave absorptance of inner surface(-)  
0.900000 EMITIS: Emissivity of the inner surface (-)  
0.000000 TRANSM: Transmittance of the glass window (-)  
0.000000 SC: Shading coeff. of the glass window (-)

-----

UNIT 4 TYPE 51  
BUILDING SURFACE

1 INPUTS:  
TEMPERATURE 1 - TIA: Indoor air dry-bulb temperature  
TEMPERATURE 10 - TMR: Mean radiant temperature  
TEMPERATURE 9 - TOSINF: Outer surface temp. of unexposed wall  
CONTROL 5 - FSHADW: Shaded fraction of exposed surface

2 OUTPUTS:  
TEMPERATURE 2 - TIS: Inner surface temperature  
POWER 0 - SOLINT: Integrated solar influx on surface

3 PARAMETERS:  
1.00000 IZN: Identification number of zone  
3.00000 ID: Identification number of surface  
1.00000 IEXPOS: 0=W/in zone, 1=betw.zones, 2=exposed to sun  
3.00000 ISTR: Identification number of the construct  
24.4000 AS: Surface area (m2)  
90.0000 ORIENT: Azimuth angle of normal to surface & south  
90.0000 TILT: Tilt angle: flat roof=0, floor=180 (degree)  
0.000000 GRF: Ground reflectivity (-)  
0.000000 IROFS: Outer surface roughness index: 1=stucco,...  
0.000000 ABSOS: Solar absorptance of outer surface (-)  
0.600000 ABSIS: Short wave absorptance of inner surface(-)  
0.900000 EMITIS: Emissivity of the inner surface (-)  
0.000000 TRANSM: Transmittance of the glass window (-)  
0.000000 SC: Shading coeff. of the glass window (-)

UNIT 5 TYPE 51  
BUILDING SURFACE

1 INPUTS:  
TEMPERATURE 1 - TIA: Indoor air dry-bulb temperature  
TEMPERATURE 10 - TMR: Mean radiant temperature  
TEMPERATURE 9 - TOSINF: Outer surface temp. of unexposed wall  
CONTROL 5 - FSHADW: Shaded fraction of exposed surface

2 OUTPUTS:  
TEMPERATURE 5 - TIS: Inner surface temperature  
POWER 0 - SOLINT: Integrated solar influx on surface

3 PARAMETERS:  
1.00000 IZN: Identification number of zone  
4.00000 ID: Identification number of surface  
1.00000 IEXPOS: 0=W/in zone, 1=betw.zones, 2=exposed to sun  
3.00000 ISTR: Identification number of the construct  
24.4000 AS: Surface area (m2)  
270.000 ORIENT: Azimuth angle of normal to surface & south  
90.0000 TILT: Tilt angle: flat roof=0, floor=180 (degree)  
0.000000 GRF: Ground reflectivity (-)  
0.000000 IROFS: Outer surface roughness index: 1=stucco,...  
0.000000 ABSOS: Solar absorptance of outer surface (-)  
0.600000 ABSIS: Short wave absorptance of inner surface(-)  
0.900000 EMITIS: Emissivity of the inner surface (-)  
0.000000 TRANSM: Transmittance of the glass window (-)  
0.000000 SC: Shading coeff. of the glass window (-)

UNIT 6 TYPE 51  
BUILDING SURFACE

1 INPUTS:  
TEMPERATURE 1 - TIA: Indoor air dry-bulb temperature  
TEMPERATURE 10 - TMR: Mean radiant temperature  
TEMPERATURE 9 - TOSINF: Outer surface temp. of unexposed wall  
CONTROL 5 - FSHADW: Shaded fraction of exposed surface

2 OUTPUTS:  
TEMPERATURE 7 - TIS: Inner surface temperature  
POWER 0 - SOLINT: Integrated solar influx on surface

3 PARAMETERS:  
1.00000 IZN: Identification number of zone  
5.00000 ID: Identification number of surface  
1.00000 IEXPOS: 0=W/in zone, 1=betw.zones, 2=exposed to sun  
3.00000 ISTR: Identification number of the construct  
24.4000 AS: Surface area (m2)  
180.000 ORIENT: Azimuth angle of normal to surface & south  
90.0000 TILT: Tilt angle: flat roof=0, floor=180 (degree)  
0.000000 GRF: Ground reflectivity (-)  
0.000000 IROFS: Outer surface roughness index: 1=stucco,...  
0.000000 ABSOS: Solar absorptance of outer surface (-)  
0.600000 ABSIS: Short wave absorptance of inner surface(-)  
0.900000 EMITIS: Emissivity of the inner surface (-)  
0.000000 TRANSM: Transmittance of the glass window (-)  
0.000000 SC: Shading coeff. of the glass window (-)

UNIT 7 TYPE 51  
BUILDING SURFACE

1 INPUTS:  
 TEMPERATURE 1 - TIA: Indoor air dry-bulb temperature  
 TEMPERATURE 10 - TMR: Mean radiant temperature  
 TEMPERATURE 6 - TOSINF: Outer surface temp. of unexposed wall  
 CONTROL 4 - FSHADW: Shaded fraction of exposed surface

2 OUTPUTS:  
 TEMPERATURE 6 - TIS: Inner surface temperature  
 POWER 5 - SOLINT: Integrated solar influx on surface

3 PARAMETERS:  
 1.00000 IZN: Identification number of zone  
 6.00000 ID: Identification number of surface  
 2.00000 IEXPOS: 0=W/in zone, 1=betw.zones, 2=exposed to sun  
 4.00000 ISTR: Identification number of the construct  
 18.4000 AS: Surface area (m2)  
 0.000000 ORIENT: Azimuth angle of normal to surface & south  
 90.0000 TILT: Tilt angle: flat roof=0, floor=180 (degree)  
 0.200000 GRF: Ground reflectivity (-)  
 2.00000 IROFS: Outer surface roughness index: 1=stucco, ...  
 0.600000 ABSOS: Solar absorptance of outer surface (-)  
 0.600000 ABSIS: Short wave absorptance of inner surface (-)  
 0.900000 EMITIS: Emissivity of the inner surface (-)  
 0.000000 TRANSM: Transmittance of the glass window (-)  
 0.000000 SC: Shading coeff. of the glass window (-)

UNIT 8 TYPE 51  
BUILDING SURFACE

1 INPUTS:  
 TEMPERATURE 1 - TIA: Indoor air dry-bulb temperature  
 TEMPERATURE 10 - TMR: Mean radiant temperature  
 TEMPERATURE 8 - TOSINF: Outer surface temp. of unexposed wall  
 CONTROL 4 - FSHADW: Shaded fraction of exposed surface

2 OUTPUTS:  
 TEMPERATURE 8 - TIS: Inner surface temperature  
 POWER 4 - SOLINT: Integrated solar influx on surface

3 PARAMETERS:  
 1.00000 IZN: Identification number of zone  
 7.00000 ID: Identification number of surface  
 2.00000 IEXPOS: 0=W/in zone, 1=betw.zones, 2=exposed to sun  
 5.00000 ISTR: Identification number of the construct  
 6.00000 AS: Surface area (m2)  
 0.000000 ORIENT: Azimuth angle of normal to surface & south  
 90.0000 TILT: Tilt angle: flat roof=0, floor=180 (degree)  
 0.200000 GRF: Ground reflectivity (-)  
 6.00000 IROFS: Outer surface roughness index: 1=stucco, .  
 0.000000 ABSOS: Solar absorptance of outer surface (-)  
 0.000000 ABSIS: Short wave absorptance of inner surface (-)  
 0.000000 EMITIS: Emissivity of the inner surface (-)  
 0.950000 TRANSM: Transmittance of the glass window (-)  
 0.850000 SC: Shading coeff. of the glass window (-)

UNIT 9 TYPE 53

WEATHER INPUT

1 INPUTS:  
TEMPERATURE 12 - TAMB: Ambient (outdoor) air temperature (C)  
ABS. HUMIDITY 3 - HUMRAT: Outdoor air humidity ratio (-)  
PRESSURE 3 - PBAR: Barometric pressure (kPa)  
POWER 6 - IDN: Direct normal solar radiation (W/m2)  
POWER 7 - ISKY: Diffuse (sky) solar radiation (W/m2)  
POWER 8 - IHOR: Total horizontal solar radiation (W/m2)

2 OUTPUTS:

3 PARAMETERS:  
12.0000 Index for ambient temperature (e.g. 5 if TAMB=T5)  
3.00000 Index for outdoor air humidity ratio  
3.00000 Index for barometric pressure  
6.00000 Index for direct normal solar radiation  
7.00000 Index for diffuse (sky) solar radiation  
8.00000 Index for total horizontal solar radiation

UNIT 10 TYPE 52

ZONE MODEL

1 INPUTS:  
PRESSURE 1 - PIAG: Gage pressure of zone air  
TEMPERATURE 1 - TIA: Zone air dry-bulb temperature  
ABS. HUMIDITY 1 - WIA: Humidity ratio of zone air  
PRESSURE 2 - PSAG: Gage pressure of supply air  
FLOW 1 - MSA: Mass flow rate of supply air  
TEMPERATURE 11 - TSA: Supply air dry-bulb temperature  
ABS. HUMIDITY 2 - WSA: Humidity ratio of supply air  
POWER 3 - QWALL: Convective heat gain from surfaces  
CONTROL 1 - NUMPEP: Number of people (occupant in the zone)  
CONTROL 2 - UTCEQP: Equipment utilization coefficient  
CONTROL 3 - UTCLIT: Lighting utilization coefficient

2 OUTPUTS:

TEMPERATURE 1 - TIA: Zone air dry-bulb temp. [diff. eq.]  
ABS. HUMIDITY 1 - WIA: Humidity ratio of zone air [diff. eq.]  
POWER 1 - QISW: Internal (short wave) radiant gain  
POWER 2 - QILW: Internal (long wave) radiant gain

3 PARAMETERS:

1.00000 IZN: Identification number of zone  
200.000 CFUR: Effective capacitance of furnishings (kJ/K)  
4.00000 EFFMIA: Multiplier for zone moisture capacitance(-)  
148.840 VOLUME: Volume of zone air (interior space) (m3)  
1.00000 SAIREX: Standard air exchange rate (1/h)  
0.717600E-01 WPEPS: Sensible heat gain from a person (kW)  
0.454000E-01 WPEPL: Latent heat gain from a person (kW)  
0.200000 WLIT: Heat gain due to lighting in the zone (kW)  
1.00000 LIGHT: 1 = Fluorescent, 2 = Incandescent (-)  
0.150000 WEQPS: Sensible heat gain due to equipment (kW)  
0.200000E-01 WEQPL: Latent heat gain due to equipment (kW)  
0.300000 REQP: Radiative to sensible heat from equipment(-)

Initial Variable Values:

PRESSURE	1 ->	0.000000	(kPa)
PRESSURE	2 ->	0.000000	(kPa)
PRESSURE	3 ->	101.300	(kPa)
FLOW	1 ->	0.000000	(kg/s)
TEMPERATURE	1 ->	20.0000	(C)
TEMPERATURE	2 ->	20.0000	(C)
TEMPERATURE	3 ->	20.0000	(C)
TEMPERATURE	4 ->	20.0000	(C)
TEMPERATURE	5 ->	20.0000	(C)
TEMPERATURE	6 ->	20.0000	(C)
TEMPERATURE	7 ->	20.0000	(C)
TEMPERATURE	8 ->	20.0000	(C)
TEMPERATURE	9 ->	20.0000	(C)
TEMPERATURE	10 ->	20.0000	(C)
TEMPERATURE	11 ->	20.0000	(C)
TEMPERATURE	12 ->	20.0000	(C)
CONTROL	1 ->	1.00000	(-)
CONTROL	2 ->	1.00000	(-)
CONTROL	3 ->	1.00000	(-)
CONTROL	4 ->	0.000000	(-)
CONTROL	5 ->	1.00000	(-)
POWER	1 ->	0.000000	(kW)
POWER	2 ->	0.000000	(kW)
POWER	3 ->	0.000000	(kW)
POWER	4 ->	0.000000	(kW)
POWER	5 ->	0.000000	(kW)
POWER	6 ->	0.000000	(kW)
POWER	7 ->	0.000000	(kW)
POWER	8 ->	0.000000	(kW)
ABS. HUMIDITY	1 ->	0.740000E-02	(kg(water)/kg(air))
ABS. HUMIDITY	2 ->	0.740000E-02	(kg(water)/kg(air))
ABS. HUMIDITY	3 ->	0.740000E-02	(kg(water)/kg(air))

-----  
Simulation Error Tolerances:

1	RTOLX=	0.100000E-03	ATOLX=	0.100000E-04
	XTOL=	0.200000E-03	TTIME=	1.00000

SUPERBLOCK 1

2 FREEZE OPTION 0 SCAN OPTION 0

SUPERBLOCK 2

3 FREEZE OPTION 0 SCAN OPTION 0

-----  
The following are Boundary Variables in the simulation:

-----  
The following are the reported variables:

SUPERBLOCK 1	REPORTING INTERVAL	3600.00
TEMPERATURE	2	
TEMPERATURE	3	
TEMPERATURE	4	
TEMPERATURE	5	
TEMPERATURE	6	
TEMPERATURE	7	
TEMPERATURE	8	



TEMPERATURE 10  
 TEMPERATURE 12  
 POWER 3  
 POWER 6  
 POWER 7  
 POWER 8

SUPERBLOCK 2 REPORTING INTERVAL 3600.00  
 TEMPERATURE 1  
 ABS. HUMIDITY 1

Selection ?

END  
 STOP

-----  
 \* File: ONEZONE.SIM (Simulation Work File)  
 -----

ONE ZONE MODEL

```

2
0.100000E-03 0.100000E-04 0.200000E-03 0.100000E+01
2
8
1 50
1 1 2 2 3 4 5 6 7 8 8 8 8
10 3
0.100000E+01 0.700000E+01
2 51
1 10 9 5
4 0
0.100000E+01 0.100000E+01 0.100000E+01 0.100000E+01 0.372100E+02
0.000000E+00 0.000000E+00 0.000000E+00 0.000000E+00 0.000000E+00
0.600000E+00 0.900000E+00 0.000000E+00 0.000000E+00
3 51
1 10 9 5
3 0
0.100000E+01 0.200000E+01 0.100000E+01 0.200000E+01 0.372100E+02
0.000000E+00 0.180000E+03 0.000000E+00 0.000000E+00 0.000000E+00
0.600000E+00 0.900000E+00 0.000000E+00 0.000000E+00
4 51
1 10 9 5
2 0
0.100000E+01 0.300000E+01 0.100000E+01 0.300000E+01 0.244000E+02
0.900000E+02 0.900000E+02 0.000000E+00 0.000000E+00 0.000000E+00
0.600000E+00 0.900000E+00 0.000000E+00 0.000000E+00
5 51
1 10 9 5
5 0
0.100000E+01 0.400000E+01 0.100000E+01 0.300000E+01 0.244000E+02
0.270000E+03 0.900000E+02 0.000000E+00 0.000000E+00 0.000000E+00
0.600000E+00 0.900000E+00 0.000000E+00 0.000000E+00
6 51
1 10 9 5
7 0
0.100000E+01 0.500000E+01 0.100000E+01 0.300000E+01 0.244000E+02
0.180000E+03 0.900000E+02 0.000000E+00 0.000000E+00 0.000000E+00
0.600000E+00 0.900000E+00 0.000000E+00 0.000000E+00
7 51
1 10 6 4

```

```

6 5
0.100000E+01 0.600000E+01 0.200000E+01 0.400000E+01 0.184000E+02
0.000000E+00 0.900000E+02 0.200000E+00 0.200000E+01 0.600000E+00
0.600000E+00 0.900000E+00 0.000000E+00 0.000000E+00
8 51
1 10 8 4
8 4
0.100000E+01 0.700000E+01 0.200000E+01 0.500000E+01 0.600000E+01
0.000000E+00 0.900000E+02 0.200000E+00 0.600000E+01 0.000000E+00
0.000000E+00 0.000000E+00 0.950000E+00 0.850000E+00
1
9 53
12 3 3 6 7 8

0.120000E+02 0.300000E+01 0.300000E+01 0.600000E+01 0.700000E+01
0.800000E+01
1
1
10 52
1 1 1 2 1 11 2 3 1 2 3
1 1 1 2
0.100000E+01 0.200000E+03 0.400000E+01 0.148840E+03 0.100000E+01
0.717600E-01 0.454000E-01 0.200000E+00 0.100000E+01 0.150000E+00
0.200000E-01 0.300000E+00
0.000000E+00 0.000000E+00 0.101300E+03 0.000000E+00 0.200000E+02
0.200000E+02 0.200000E+02 0.200000E+02 0.200000E+02 0.200000E+02
0.200000E+02 0.200000E+02 0.200000E+02 0.200000E+02 0.200000E+02
0.200000E+02 0.100000E+01 0.100000E+01 0.100000E+01 0.000000E+00
0.100000E+01 0.000000E+00 0.000000E+00 0.000000E+00 0.000000E+00
0.000000E+00 0.000000E+00 0.000000E+00 0.000000E+00 0.000000E+00
0.740000E-02 0.740000E-02
0

13 0.360000E+04
6 7 8 9 10 11 12 14 16 24 27 28 29
3 3 3 3 3 3 3 3 3 3 7 7 7 7
2 3 4 5 6 7 8 10 12 3 6 7 8
2 0.360000E+04
5 30
3 8
1 1
0 0
0 0
*****OLD****WORK****FILE****ENDS****HERE*****
2 3 10
2 1
3 1 12 5 0 0 8 3
32
13 2

```

(2) Creation of Model Definition File

-----  
\* Execution of SLIMCON  
-----

Simulation Work File to Model Definition File Converter  
Version 2.1 (November 13, 1984)

Enter the simulation filename (Up to 8 characters) or carriage return to end.

ONEZONE

2	superblocks in the simulation	MAXIMUM = 10 ( 20.0%)
3	blocks in the simulation	MAXIMUM = 50 ( 6.0%)
2	differential equations in the simulation	MAXIMUM = 50 ( 4.0%)
399	saved variables in the simulation	MAXIMUM =6000 ( 6.7%)
10	units in the simulation	MAXIMUM = 200 ( 5.0%)
8	units in a single block	MAXIMUM = 20 ( 40.0%)
2	differential equations in one unit	MAXIMUM = 10 ( 20.0%)
13	inputs or outputs in a single unit	MAXIMUM = 20 ( 65.0%)
14	parameters in a single unit	MAXIMUM = 30 ( 46.7%)
2	blocks in the largest superblock	MAXIMUM = 10 ( 20.0%)
2	differential equations in one superblock	MAXIMUM = 20 ( 10.0%)
32	state variables in the simulation	MAXIMUM = 600 ( 5.3%)
14	inputs or outputs in a single block	MAXIMUM = 50 ( 28.0%)
118	unit parameters in the simulation	MAXIMUM =1000 ( 11.8%)
8	simultaneous equations in a single block	MAXIMUM = 30 ( 26.7%)
0	simultaneous equations in one superblock	MAXIMUM = 20 ( 0.0%)
0	time dependent boundary variables	MAXIMUM = 30 ( 0.0%)
0	boundary conditions in one superblock	MAXIMUM = 20 ( 0.0%)
13	reported variables in one superblock	MAXIMUM = 30 ( 43.3%)

Model Definition File Complete

-----  
\* File: ONEZONE.DAT ==> MODELDEF.DAT (Model Definition File)  
-----

ONE ZONE MODEL

```
32  2
 2  1
0.000000E+00  0.000000E+00  0.101300E+03  0.000000E+00  0.200000E+02
0.200000E+02  0.200000E+02  0.200000E+02  0.200000E+02  0.200000E+02
0.200000E+02  0.200000E+02  0.200000E+02  0.200000E+02  0.200000E+02
0.200000E+02  0.100000E+01  0.100000E+01  0.100000E+01  0.000000E+00
0.100000E+01  0.000000E+00  0.000000E+00  0.000000E+00  0.000000E+00
0.000000E+00  0.000000E+00  0.000000E+00  0.000000E+00  0.740000E-02
0.740000E-02  0.740000E-02
0  3  4  16  -1  -1  21  29
8  1  1
0  0
8  0  2
1  2
3
1  2  3  4  5  6  7  8
9
10
50 51 51 51 51 51 51 51 53 52
13 4  4  4  4  4  4  4  6  11
5 22 23  6  7  8  9 10 11 12 12 12 12
5 14 13 21
```



0.800000E+01 0.100000E+01 0.200000E+03 0.400000E+01 0.148840E+03  
0.100000E+01 0.717600E-01 0.454000E-01 0.200000E+00 0.100000E+01  
0.150000E+00 0.200000E-01 0.300000E+00

0

13 2

0.360000E+04 0.360000E+04

6 7 8 9 10 11 12 14 16 24 27 28 29

3 3 3 3 3 3 3 3 3 7 7 7 7

2 3 4 5 6 7 8 10 12 3 6 7 8

5 30

3 8

1 1

0.100000E-03 0.100000E-04 0.200000E-03 0.100000E+01

0 0

0 0

(3) Creation of Boundary Variable File

No file for boundary variables is created in this example.

(4) Creation of Conduction Transfer Function File

-----  
\* Composition of constructs  
-----

CONSTRUCT #1 (Ceiling)

(Outside)		
Layer 1	Acoustic tile	(47): [material I.D. # in THERM.DAT file]
2	Ceiling air space	(46)
3	Concrete, 4-in.	(36)
4	Vinyle tile, 3/32-in.	(48)*

(Inside)

\* Data for vinyle tile should be added to THERM.DAT file.

Vinyle tile L=0.002 m, k=0.27 W/mK,  $\rho = 1552.2$  kg/m<sup>3</sup>, Cp=1.004 KJ/kg-K

CONSTRUCT #2 (Floor)

(Outside)		
Layer 1	Vinyle tile, 3/32-in.	(48)*
2	Concrete, 4-in.	(36)
3	Ceiling air space	(46)
4	Acoustic tile	(47)

(Inside)

CONSTRUCT #3 (Interior Walls)

(Outside)		
Layer 1	Plaster, 3/4-in.	(43)
2	Air space	(8)
3	Plaster, 3/4-in.	(43)

(Inside)

CONSTRUCT #4 (Exposed Wall)

(Outside)

Layer 1	Face Brick, 4-in.	(2)
2	Fiberglass insulation, R-11	(10)
3	Air space	(8)
4	Plaster, 3/4-in.	(43)

(Inside)

CONSTRUCT #5 (Exposed Glass Window)

(Outside)

Layer 1	Glass, 3/32-in.	(49)*
2	Air space	(8)
3	Glass, 3/32-in.	(49)*

(Inside)

Data for glass: L=k=Cp=0 R=0.26 m2-K/W

\* Execution of CTFGEN

Enter your choice:

- \*\*\*\*\*
- A => Add thermal property data to the construction materials database (THERM.DAT)
- B => Print the contents of the data file THERM.DAT to Logical Unit 6
- C => Create a CTF data file
- D => Change time interval in an existing CTF data file
- E => END

A

```
*****
*
* YOU ARE NOW ADDING THERMAL PROPERTY DATA *
* INTO THE EXISTING FILE (THERM.DAT) *
* PLEASE ENTER YOUR DATA WITH CARE. *
* METRIC UNITS MUST BE USED. *
*
*****
```

Enter the name of the construction material (up to 60 characters)

Vinyle tile

Thickness (meters) =

0.002

Conductivity (W/m.C) =

0.27

Density (kg/m\*\*3) =

1552.2

Specific heat (kJ/kg.C) =

```

1.004
  Thermal resistance (m**2.C/W) =
0
  IDATA=48 LENGTH=2.0E-03 COND=0.27
  DENS=1552.2 SPHT=1.004 RVAL=0.0
Do you want to continue? <N>
y
  Enter the name of the construction material
  (up to 60 characters)
Glass
  Thickness (meters) =
0
  Conductivity (W/m.C) =
0
  Density (kg/m**3) =
0
  Specific heat (kJ/kg.C) =
0
  Thermal resistance (m**2.C/W) =
0.26
  IDATA=49 LENGTH=0.0 COND=0.0
  DENS=0.0 SPHT=0.0 RVAL=0.26
Do you want to continue? <N>

-- END OF ADDITION ---
          Enter your choice:
*****
A => Add thermal property data to the construction
      materials database (THERM.DAT)
B => Print the contents of the data file THERM.DAT
      to Logical Unit 6
C => Create a CTF data file
D => Change time interval in an existing CTF data file
E => END
C
  Enter the name of the CTF Definition File,
  or carriage return for default name: CTFINPUT.DAT

  Enter the name of the CTF Output File,
  or carriage return for default name: CTFDATA.DAT

What kind of output do you want?
0 ==> for a very simple output,
1 ==> for a less simple output,
2 ==> for detailed output or
3 ==> for root search
0
What is the time interval for CTF calculation in s ?
900
THIS CONSTRUCT ID NUMBER (ISTR) IS 1
How many layers in this construct? (max. = 10 )
4
  Enter the layer ID numbers with most outer layer first
47,46,36,48
ISTR: 1
NCTF: 4  NORD: 2
UVAL: 0.969606
CTFX: 2.99057, -3.713, 1.10035, -6.3286E-02, -3 55439E-05
CTFY: 9.44398E-03, 0.163193, 0.132975, 8.93878E-03, 5 09487E-05
CTFZ: 9.21826, -13.4813, 4.86344, -0.28575, -8 8593E-05

```



CTFQ: 0.735784, -6.02473E-02

Do you want to continue? <N>

Y

THIS CONSTRUCT ID NUMBER (ISTR) IS 2

How many layers in this construct? (max. = 10 )

4

Enter the layer ID numbers with most outer layer first

48,36,46,47

ISTR: 2

NCTF: 4 NORD: 2

UVAL: 0.969606

CTFX: 9.21826, -13.4813, 4.86344, -0.28575, -8.8593E-05

CTFY: 9.44398E-03, 0.163193, 0.132975, 8.93878E-03, 5.09487E-05

CTFZ: 2.99057, -3.713, 1.10035, -6.3286E-02, -3.55439E-05

CTFQ: 0.735784, -6.02473E-02

Do you want to continue? <N>

Y

THIS CONSTRUCT ID NUMBER (ISTR) IS 3

How many layers in this construct? (max. = 10 )

3

Enter the layer ID numbers with most outer layer first

43,8,43

ISTR: 3

NCTF: 1 NORD: 1

UVAL: 4.71099

CTFX: 11.6962, -6.9852

CTFY: 3.82101, 0.88995

CTFZ: 11.6962, -6.9852

CTFQ: 6.21576E-06

Do you want to continue? <N>

Y

THIS CONSTRUCT ID NUMBER (ISTR) IS 4

How many layers in this construct? (max. = 10 )

4

Enter the layer ID numbers with most outer layer first

2,10,8,43

ISTR: 4

NCTF: 3 NORD: 2

UVAL: 0.691656

CTFX: 31.2398, -37.7555, 6.8351, -3.14559E-02

CTFY: 3.03452E-02, 0.199088, 5.80254E-02, 5.05029E-04

CTFZ: 8.55491, -12.8833, 4.6573, -4.09825E-02

CTFQ: 0.588904, -5.24332E-03

Do you want to continue? <N>

Y

THIS CONSTRUCT ID NUMBER (ISTR) IS 5

How many layers in this construct? (max. = 10 )

3

Enter the layer ID numbers with most outer layer first

49,8,49

LAYER	L	K	CP	D	R	RC
Glass	0.000	0.000	0.000	0.000	0.260	0.000
Air Space	0.000	0.000	0.000	0.000	0.160	0.000
Glass	0.000	0.000	0.000	0.000	0.260	0.000

SUMRC = 0.00000 CND = 1.47059 TINC = 900.00

NUMBER OF ROOTS = 7; SEARCH INCREMENT = 0.020026

N	ROOT
1	0.024607256
2	0.072309779
3	0.111355003
4	0.120292539
5	0.136468904
6	0.169175402
7	0.216991657

NUMBER OF RESPONSE FACTORS = 3; ORDER = 2

N	O 0	O 1	O 2	O 3	O 4	O 5
0	31.239817	31.239817	31.239817	31.239817	31.239817	31.239817
1	-19.358236	-37.473015	-37.755497	-37.755942	-37.756010	-37.756012
2	-4.728849	6.496254	6.835099	6.835637	6.835720	6.835722
3	-2.714793	0.027286	-0.031456	0.000000	0.000000	0.000000
0	0.030345	0.030345	0.030345	0.030345	0.030345	0.030345
1	0.216958	0.199362	0.199088	0.199087	0.199087	0.199087
2	0.185634	0.059828	0.058025	0.058023	0.058022	0.058022
3	0.108688	0.001046	0.000505	0.000000	0.000000	0.000000
0	8.554926	8.554926	8.554926	8.554926	8.554926	8.554926
1	-7.845255	-12.805930	-12.883287	-12.883409	-12.883428	-12.883428
2	-0.007653	4.541511	4.657307	4.657491	4.657519	4.657520
3	-0.004354	0.000083	-0.040983	0.000000	0.000000	0.000000
2	0.588904	-0.005243	0.000000	0.000000	0.000000	0.000000

\*\* SEVERE RESPONSE FACTORS NOT COMPUTED (RESPNS)

ISTR: 5  
 NCTF: 0 NORD: 0  
 UVAL: 1.47059  
 CTFX: 1.47059  
 CTFY: 1.47059  
 CTFZ: 1.47059  
 CTFQ:

Do you want to continue? <N>

N  
 STOP ----- END OF CTF RUN -----

-----  
 \* File: THERM.DAT ( Thermal Property Data Bank for Building Materials )  
 -----

1	Stucco/asbestos cement/wood siding plaster, 25.4-mm (1-in.)					
0.0254	0.692	1858.	0.233	0.036	47.2	A1
2	Facebrick (dense concrete), 101.6-mm (4-in.)					
0.1016	1.298	2082.	0.256	0.078	211.4	A2
3	Steel siding (aluminum or other lightweight cladding)					
0.0015	44.99	7689.	0.116	0.000	11.7	A3
4	Slag, membrane, 12.7-mm (0.5-in.)					
0.0127	1.143	881.	0.465	0.011	11.2	A4
5	Felt, 9.5-mm (0.375-in.)					
0.0095	0.190	1121.	0.465	0.050	10.6	A5
6	Finish					
0.0127	0.415	1249.	0.302	0.031	15.9	A6
7	Facebrick, 101.6-mm (4-in.)					
0.1016	1.332	2002.	0.256	0.076	203.1	A7
8	Air Space Resistance					
0.0000	0.000	0.	0.000	0.160	0.	B1

9	Insulation, 25.4-mm (1-in.)					
0.0254	0.043	32.	0.233	0.585	0.8	B2
10	Insulation, 50.8-mm (2-in.)					
0.0508	0.043	32.	0.233	1.176	1.6	B3
11	Insulation, 76.2-mm (3-in.)					
0.0762	0.043	32.	0.233	1.766	2.4	B4
12	Insulation, 25.4-mm (1-in.)					
0.0254	0.043	91.	0.233	0.586	2.3	B5
13	Insulation, 50.8-mm (2-in.)					
0.0508	0.043	91.	0.233	1.176	4.6	B6
14	Wood, 25.4-mm (1-in.)					
0.0254	0.116	592.	0.699	0.209	15.0	B7
15	Wood, 63.5-mm (2.5-in.)					
0.0635	0.116	592.	0.699	0.525	37.6	B8
16	Wood, 101.6-mm (4-in.)					
0.1016	0.116	592.	0.699	0.838	60.0	B9
17	Wood, 50.8-mm (2-in.)					
0.0508	0.116	592.	0.699	0.421	30.2	B10
18	Wood, 76.2-mm (3-in.)					
0.0762	0.116	592.	0.699	0.631	45.2	B11
19	Insulation, 76.2-mm (3-in.)					
0.0762	0.043	91.	0.233	1.761	6.9	B12
20	Insulation, 101.6-mm (4-in.)					
0.1016	0.043	91.	0.233	2.346	9.3	B13
21	Insulation, 127.0-mm (5-in.)					
0.1270	0.043	91.	0.233	2.934	11.6	B14
22	Insulation, 152.4-mm (6-in.)					
0.1524	0.043	91.	0.233	3.520	13.9	B15
23	Clay tile, 101.6-mm (4-in.)					
0.1016	0.571	1121.	0.233	0.178	113.7	C1
24	Concrete block, l.w., 101.6-mm (4-in.)					
0.1016	0.381	608.	0.233	0.266	62.0	C2
25	Concrete block, h.w., 101.6-mm (4-in.)					
0.1016	0.813	977.	0.233	0.125	99.1	C3
26	Common brick, 101.6-mm (4-in.)					
0.1016	0.727	1922.	0.233	0.139	195.3	C4
27	Concrete, l.w., 101.6-mm (4-in.)					
0.1016	1.730	2242.	0.233	0.059	227.5	C5
28	Clay tile, 203.2-mm (8-in.)					
0.2032	0.571	1121.	0.233	0.356	227.9	C6
29	Concrete block, l.w., 203.2-mm (8-in.)					
0.2032	0.571	608.	0.233	0.356	124.0	C7
30	Concrete block, h.w., 203.2-mm (8-in.)					
0.2032	1.038	977.	0.233	0.195	198.7	C8
31	Common brick, 203.2-mm (8-in.)					
0.2032	0.727	1922.	0.233	0.280	390.6	C9
32	Concrete, h.w., 203.2-mm (8-in.)					
0.2032	1.730	2242.	0.233	0.117	455.9	C10
33	Concrete, h.w., 304.8-mm (12-in.)					
0.3048	1.730	2242.	0.233	0.176	683.5	C11
34	Concrete, h.w., 50.8-mm (2-in.)					
0.0508	1.730	2242.	0.233	0.029	114.2	C12
35	Concrete, h.w., 152.4-mm (6-in.)					
0.1524	1.730	2242.	0.233	0.088	341.7	C13
36	Concrete, l.w., 101.6-mm (4-in.)					
0.1016	0.173	640.	0.233	0.586	64.9	C14
37	Concrete, l.w., 152.4-mm (6-in.)					
0.1524	0.173	640.	0.233	0.088	97.6	C15
38	Concrete, l.w., 203.2-mm (8-in.)					
0.2032	0.173	640.	0.233	1.174	130.3	C16

```

39 Concrete block (filled insulation), l.w., 203.2-mm (8-in.)
0.2032 0.138 288. 0.233 1.584 58.6 C17
40 Concrete block (filled insulation), l.w., 203.2-mm (8-in.)
0.2032 0.588 849. 0.233 0.348 172.8 C18
41 Concrete block (filled insulation), l.w., 304.8-mm (12-in.)
0.3048 0.138 304. 0.233 2.376 92.8 C19
42 Concrete block (filled insulation), l.w., 304.8-mm (12-in.)
0.3048 0.675 897. 0.233 0.456 273.4 C20
43 Plaster/gypsum/similar finishing layer, 19.0-mm (0.75-in.)
0.0190 0.727 1601. 0.233 0.026 30.5 E1
44 Slag or stone, 12.7-mm (0.5-in.)
0.0127 1.436 881. 0.465 0.009 11.2 E2
45 Felt & membrane, 9.5-mm (0.375-in.)
0.0095 0.190 1121. 0.465 0.050 10.7 E3
46 Ceiling air space
0.0000 0.000 0. 0.000 0.176 0.0 E4
47 Acoustic tile
0.0159 0.061 480. 0.233 0.315 9.2 E5
48 Vinyl tile
0.0020 0.270 1552. 1.004 0.000 3.1 XXX
49 Glass
0.0000 0.000 0. 0.000 0.260 0.0 XXX

```

-----  
\* File: CTFDATA.DAT (Conduction Transfer Function File)  
-----

```

900.000
 1  4  2  0.969606
 2.99057 -3.71300 1.10035 -0.632860E-01 -0.355439E-04
0.944398E-02 0.163193 0.132975 0.893878E-02 0.509487E-04
 9.21826 -13.4813 4.86344 -0.285750 -0.885930E-04
0.735784 -0.602473E-01
 2  4  2  0.969606
 9.21826 -13.4813 4.86344 -0.285750 -0.885930E-04
0.944398E-02 0.163193 0.132975 0.893878E-02 0.509487E-04
 2.99057 -3.71300 1.10035 -0.632860E-01 -0.355439E-04
0.735784 -0.602473E-01
 3  1  1  4.71099
11.6962 -6.98520
 3.82101 0.889950
11.6962 -6.98520
0.621576E-05
 4  3  2  0.691656
31.2398 -37.7555 6.83510 -0.314559E-01
0.303452E-01 0.199088 0.580254E-01 0.505029E-03
 8.55491 -12.8833 4.65730 -0.409825E-01
0.588904 -0.524332E-02
 5  0  1  1.47059
 1.47059
 1.47059
 1.47059
0.000000

```

-----  
\* File: CTFINPUT.DAT (CTF Input Data File)  
-----

```

900.000
 4  47  46  36  48
 4  48  36  46  47

```

3 43 8 43  
4 2 10 8 43  
3 49 8 49

(5) Creation of Weather Data File

-----  
\* Execution of CRWDTA  
-----

\*\*\*\*\*  
\*  
\*           CREATING A WEATHER DATA FILE           \*  
\*  
\*\*\*\*\*

Enter LATITUDE, LONGITUDE, and TIME ZONE:  
38.85  
77.03  
5

Enter one of the following:

- 1 - to process the weather data in file WTPOUT.DAT  
    (previously read from weather tape by program RDTAPE)
- 2 - to generate clear sky design data
- 3 - to generate cloudy sky design data

2

Enter output file name (up to 12 characters)  
or carriage return for default name: WEATHER.DAT

Enter initial day and month, and number of days  
for which weather calculations will be made:

7,7,2

Enter pressure (kPa), wind speed (m/s), and  
relative humidity (from 0.0 to 1.0):

101.3,0,0.8

Enter minimum and maximum temperatures:

20,30

Enter visibility (km); if value unknown use 0:

0

Enter geographic correction factor

[ASHRAE Fund. 1981, p.27.8]; if value unknown use 1:

1

STOP ---- END OF CREATING WEATHER FILE -----

-----  
\* File: WEATHER.DAT  
-----

7	7	38.85	77.03	5.00	2				
7	7	0.0	21.8000	0.0133	101.3000	0.0000	0.0000	0.0000	
7	7	1.0	21.3000	0.0128	101.3000	0.0000	0.0000	0.0000	
7	7	2.0	20.8000	0.0124	101.3000	0.0000	0.0000	0.0000	
7	7	3.0	20.4000	0.0121	101.3000	0.0000	0.0000	0.0000	
7	7	4.0	20.1000	0.0119	101.3000	0.0000	0.0000	0.0000	
7	7	5.0	20.0000	0.0118	101.3000	0.0000	0.0000	0.0000	
7	7	6.0	20.2000	0.0120	101.3000	0.0000	194.7809	26.8798	4
7	7	7.0	20.7000	0.0124	101.3000	0.0000	582.1411	80.3355	25
7	7	8.0	21.6000	0.0131	101.3000	0.0000	741.2583	102.2937	45
7	7	9.0	22.9000	0.0142	101.3000	0.0000	819.7222	113.1217	64
7	7	10.0	24.4000	0.0156	101.3000	0.0000	862.7646	119.0615	79
7	7	11.0	26.1000	0.0173	101.3000	0.0000	886.6650	122.3598	91
7	7	12.0	27.7000	0.0190	101.3000	0.0000	898.1992	123.9515	97
7	7	13.0	28.9000	0.0205	101.3000	0.0000	900.1130	124.2156	98
7	7	14.0	29.7000	0.0215	101.3000	0.0000	892.8298	123.2105	94
7	7	15.0	30.0000	0.0218	101.3000	0.0000	874.6892	120.7071	85

7	7	16.0	29.7000	0.0215	101.3000	0.0000	840.9761	116.0547	71
7	7	17.0	29.0000	0.0206	101.3000	0.0000	780.5696	107.7186	53
7	7	18.0	27.9000	0.0193	101.3000	0.0000	664.8452	91.7486	34
7	7	19.0	26.6000	0.0178	101.3000	0.0000	403.6780	55.7076	13
7	7	20.0	25.3000	0.0165	101.3000	0.0000	19.7814	2.7298	
7	7	21.0	24.2000	0.0154	101.3000	0.0000	0.0000	0.0000	
7	7	22.0	23.2000	0.0145	101.3000	0.0000	0.0000	0.0000	
7	7	23.0	22.4000	0.0138	101.3000	0.0000	0.0000	0.0000	
7	7	24.0	21.8000	0.0133	101.3000	0.0000	0.0000	0.0000	
7	8	1.0	21.3000	0.0128	101.3000	0.0000	0.0000	0.0000	
7	8	2.0	20.8000	0.0124	101.3000	0.0000	0.0000	0.0000	
7	8	3.0	20.4000	0.0121	101.3000	0.0000	0.0000	0.0000	
7	8	4.0	20.1000	0.0119	101.3000	0.0000	0.0000	0.0000	
7	8	5.0	20.0000	0.0118	101.3000	0.0000	0.0000	0.0000	
7	8	6.0	20.2000	0.0120	101.3000	0.0000	189.4358	26.1422	4
7	8	7.0	20.7000	0.0124	101.3000	0.0000	580.1868	80.0658	25
7	8	8.0	21.6000	0.0131	101.3000	0.0000	740.4182	102.1777	45
7	8	9.0	22.9000	0.0142	101.3000	0.0000	819.2832	113.0611	64
7	8	10.0	24.4000	0.0156	101.3000	0.0000	862.5037	119.0255	79
7	8	11.0	26.1000	0.0173	101.3000	0.0000	886.4949	122.3363	90
7	8	12.0	27.7000	0.0190	101.3000	0.0000	898.0789	123.9349	97
7	8	13.0	28.9000	0.0205	101.3000	0.0000	900.0195	124.2027	98
7	8	14.0	29.7000	0.0215	101.3000	0.0000	892.7478	123.1992	94
7	8	15.0	30.0000	0.0218	101.3000	0.0000	874.6021	120.6951	85
7	8	16.0	29.7000	0.0215	101.3000	0.0000	840.8579	116.0384	71
7	8	17.0	29.0000	0.0206	101.3000	0.0000	780.3618	107.6899	53
7	8	18.0	27.9000	0.0193	101.3000	0.0000	664.3657	91.6825	33
7	8	19.0	26.6000	0.0178	101.3000	0.0000	402.1970	55.5032	13
7	8	20.0	25.3000	0.0165	101.3000	0.0000	19.1445	2.6419	
7	8	21.0	24.2000	0.0154	101.3000	0.0000	0.0000	0.0000	
7	8	22.0	23.2000	0.0145	101.3000	0.0000	0.0000	0.0000	
7	8	23.0	22.4000	0.0138	101.3000	0.0000	0.0000	0.0000	
7	8	24.0	21.8000	0.0133	101.3000	0.0000	0.0000	0.0000	

NOTE: Data in columns from 1 to 80 are only shown here.

B. Simulation

(1) Allocation of Output Files

The output files of the MODSIM program are automatically allocated. Default file names are MODSUM.DAT, MODOUT.DAT, and INITOUT.DAT.

(2) Execution of MODSIM for Initialization

```
*****
*
*      MODSIM      Version 5.0      *
*
*****
```

Enter MINIMUM TIME STEP, MAXIMUM TIME STEP, and SIMULATION STOPPING TIME:  
1,1000,86400

Is the Building Shell Model used? <N>

Y

Will the Initialization File be called? <N>

N

Simulate Building Shell ONLY? <N>

Y

Only the superblock containing the building model will be called.

What is the INDEX NUMBER of the SUPERBLOCK for the Building Shell?

1

ISSHEL =1

Enter the time of day (in hours after midnight)  
at which the simulation is to begin

0

Use default file names for all files? <Y/N> <Y>

Do you want Diagnostic Information to be written <N>?

Would you like to monitor the Simulation on Screen? <N>

Y

Enter the INDEX NUMBER of the SUPERBLOCK to monitor  
or zero (0) to monitor all superblocks.

0

--During the simulation, up to five State Variables can be viewed--  
Enter the NUMBER of STATE VARIABLES to be viewed.

5

1 = PRES  
2 = FLOW  
3 = TEMP  
4 = CTRL  
5 = RVPS  
6 = ENRC  
7 = POWR  
8 = AHUM

Enter the CATEGORY NUMBER (above) and INDEX NUMBER  
for each of the 5 variables to be viewed.

3,1

3,2

3,3

3,4

3,10

----- SIMULATION BEGINS -----



-- FIRST WEATHER DATA SET HAS BEEN READ

SB 1:	TIME =1.0	NTIME =1	TSTEP =1.0	PSTEP=1000.0	
	20.0000	20.1286	20.1634	20.0601	20.1227
SB 2:	TIME =1.0	NTIME =2	TSTEP =1.0	PSTEP=5.37683	
	20.0007	20.1206	20.1634	20.0601	20.1227
SB 1:	TIME =990.0	NTIME =3	TSTEP =899.0	PSTEP=1000.0	
	20.0007	20.1753	20.3496	20.2146	20.3603
SB 1:	TIME =1800.0	NTIME =4	TSTEP =900.0	PSTEP=1000.0	
	20.0007	20.2086	20.3931	20.2058	20.4106
SB 1:	TIME =2700.0	NTIME =5	TSTEP =900.0	PSTEP=1000.0	
	20.0007	20.2298	20.4062	20.3219	20.4387
SB 1:	TIME =3600.0	NTIME =6	TSTEP =900.0	PSTEP=1000.0	
	20.0007	20.2432	20.4121	20.3429	20.4557
SB 1:	TIME =4500.0	NTIME =7	TSTEP =900.0	PSTEP=1000.0	
	20.0007	20.2516	20.4156	20.3566	20.4666
SB 1:	TIME =5400.0	NTIME =8	TSTEP =900.0	PSTEP=1000.0	
	20.0007	20.2570	20.4178	20.3662	20.4736
SB 1:	TIME =6300.0	NTIME =9	TSTEP =900.0	PSTEP=1000.0	
	20.0007	20.2604	20.4193	20.3733	20.4780
SB 1:	TIME =7200.0	NTIME =10	TSTEP =900.0	PSTEP=1000.0	
	20.0007	20.2625	20.4201	20.3784	20.4806
SB 1:	TIME =8100.0	NTIME =11	TSTEP =900.0	PSTEP=1000.0	
	20.0007	20.2637	20.4204	20.3822	20.4819
SB 1:	TIME =9000.0	NTIME =12	TSTEP =900.0	PSTEP=1000.0	
	20.0007	20.2642	20.4202	20.3848	20.4821

----- ( OUTPUTS FROM TIME=9900 TO 80100 ARE DELETED ) -----

SB 1:	TIME =81000.0	NTIME =92	TSTEP =900.0	PSTEP=1000.0	
	20.0007	20.4094	20.6504	20.6317	20.7577
SB 1:	TIME =81900.0	NTIME =93	TSTEP =900.0	PSTEP=1000.0	
	20.0007	20.3949	20.6269	20.6050	20.7303
SB 1:	TIME =82800.0	NTIME =94	TSTEP =900.0	PSTEP=1000.0	
	20.0007	20.3820	20.6061	20.5819	20.7060
SB 1:	TIME =83700.0	NTIME =95	TSTEP =900.0	PSTEP=1000.0	
	20.0007	20.3706	20.5877	20.5618	20.6843
SB 1:	TIME =84600.0	NTIME =96	TSTEP =900.0	PSTEP=1000.0	
	20.0007	20.3604	20.5713	20.5441	20.6648
SB 1:	TIME =85500.0	NTIME =97	TSTEP =900.0	PSTEP=1000.0	
	20.0007	20.3512	20.5566	20.5285	20.6472
SB 1:	TIME =86400.0	NTIME =98	TSTEP =900.0	PSTEP=1000.0	
	20.0007	20.3429	20.5433	20.5147	20.6313

----- INITIALIZATION FILE HAS BEEN WRITTEN -----

STOP -----END OF SIMULATION -----

-----  
\* File: MODSUM.DAT (for the initialization run)  
-----

\*\*\*\*\* PROGRAM MODSIM \*\*\*\*\*  
a MODular SIMulation program

ONE ZONE MODEL

2 SUPERBLOCKS            3 BLOCKS            10 UNITS

32 STATE VARIABLES:

3 PRES      1 FLOW      12 TEMP      5 CTRL      8 POWR      3 AHUM

INITIAL STATE VECTOR:

PRES:  
 0.000000      0.000000      101.300

FLOW:  
 0.000000

TEMP:  
 20.0000      20.0000      20.0000      20.0000      20.0000  
 20.0000      20.0000      20.0000      20.0000      20.0000  
 20.0000      20.0000

CTRL:  
 1.00000      1.00000      1.00000      0.000000      1.00000

POWR:  
 0.000000      0.000000      0.000000      0.000000      0.000000  
 0.000000      0.000000      0.000000

AHUM:  
 7.399999E-03    7.399999E-03    7.399999E-03

0 TIME DEPENDENT BOUNDARY VARIABLES:

ERROR TOLERANCES: RTOLX, ATOLX, XTOL, TTIME:  
 1.00000E-04    1.00000E-05    2.00000E-04    1.0000

\*\*\*\*\* SUPERBLOCK 1 \*\*\*\*\*

SUPERBLOCK SIMULTANEOUS EQUATION UNFREEZING OPTION, IFZOPT = 0  
 SUPERBLOCK INPUT SCAN OPTION, INSOPT = 0

13 REPORTED VARIABLES:

TEMP 2    TEMP 3    TEMP 4    TEMP 5    TEMP 6    TEMP 7    TEMP 8    TEMP10  
 TEMP12    POWR 3    POWR 6    POWR 7    POWR 8

0 SIMULTANEOUS EQUATIONS; VARIABLES:

\*\*\*\*\* BLOCK 1 \*\*\*\*\*

8 SIMULTANEOUS EQUATIONS; VARIABLES:

TEMP 4    TEMP 3    TEMP 2    TEMP 5    TEMP 7    TEMP 6    TEMP 8    TEMP10

UNIT 1    TYPE 50

13 INPUTS:

TEMP 1    POWR 1    POWR 2    TEMP 2    TEMP 3    TEMP 4    TEMP 5    TEMP 6  
 TEMP 7    TEMP 8    TEMP 8    TEMP 8    TEMP 8

2 OUTPUTS:

TEMP10    POWR 3

PARAMETERS:

1.0000      7.0000

UNIT 2    TYPE 51

4 INPUTS:

TEMP 1    TEMP10    TEMP 9    CTRL 5

2 OUTPUTS:  
TEMP 4 NULL 0

PARAMETERS:

1.0000	1.0000	1.0000	1.0000	37.210
0.00000	0.00000	0.00000	0.00000	0.00000
0.60000	0.90000	0.00000	0.00000	

UNIT 3 TYPE 51

4 INPUTS:

TEMP 1 TEMP10 TEMP 9 CTRL 5

2 OUTPUTS:

TEMP 3 NULL 0

PARAMETERS:

1.0000	2.0000	1.0000	2.0000	37.210
0.00000	180.00	0.00000	0.00000	0.00000
0.60000	0.90000	0.00000	0.00000	

UNIT 4 TYPE 51

4 INPUTS:

TEMP 1 TEMP10 TEMP 9 CTRL 5

2 OUTPUTS:

TEMP 2 NULL 0

PARAMETERS:

1.0000	3.0000	1.0000	3.0000	24.400
90.000	90.000	0.00000	0.00000	0.00000
0.60000	0.90000	0.00000	0.00000	

UNIT 5 TYPE 51

4 INPUTS:

TEMP 1 TEMP10 TEMP 9 CTRL 5

2 OUTPUTS:

TEMP 5 NULL 0

PARAMETERS:

1.0000	4.0000	1.0000	3.0000	24.400
270.00	90.000	0.00000	0.00000	0.00000
0.60000	0.90000	0.00000	0.00000	

UNIT 6 TYPE 51

4 INPUTS:

TEMP 1 TEMP10 TEMP 9 CTRL 5

2 OUTPUTS:

TEMP 7 NULL 0

PARAMETERS:

1.0000	5.0000	1.0000	3.0000	24.400
180.00	90.000	0.00000	0.00000	0.00000
0.60000	0.90000	0.00000	0.00000	

UNIT 7 TYPE 51

4 INPUTS:

TEMP 1 TEMP10 TEMP 6 CTRL 4

2 OUTPUTS:

TEMP 6 POWR 5

PARAMETERS:

1.0000	6.0000	2.0000	4.0000	18.400
0.00000	90.000	0.20000	2.0000	0.60000
0.60000	0.90000	0.00000	0.00000	

UNIT 8 TYPE 51

4 INPUTS:

TEMP 1 TEMP10 TEMP 8 CTRL 4

2 OUTPUTS:

TEMP 8 POWR 4

PARAMETERS:

1.0000	7.0000	2.0000	5.0000	6.0000
0.00000	90.000	0.20000	6.0000	0.00000
0.00000	0.00000	0.95000	0.85000	

\*\*\*\*\* BLOCK 2 \*\*\*\*\*

0 SIMULTANEOUS EQUATIONS; VARIABLES:

UNIT 9 TYPE 53

6 INPUTS:

TEMP12 AHUM 3 PRES 3 POWR 6 POWR 7 POWR 8

0 OUTPUTS:

PARAMETERS:

12.000	3.0000	3.0000	6.0000	7.0000
8.0000				

\*\*\*\*\* SUPERBLOCK 2 \*\*\*\*\*

SUPERBLOCK SIMULTANEOUS EQUATION UNFREEZING OPTION, IFZOPT = 0

SUPERBLOCK INPUT SCAN OPTION, INSOPT = 0

2 REPORTED VARIABLES:

TEMP 1 AHUM 1

0 SIMULTANEOUS EQUATIONS; VARIABLES:

\*\*\*\*\* BLOCK 3 \*\*\*\*\*

2 SIMULTANEOUS EQUATIONS; VARIABLES:

TEMP 1 AHUM 1

UNIT 10 TYPE 52

11 INPUTS:

PRES 1 TEMP 1 AHUM 1 PRES 2 FLOW 1 TEMP11 AHUM 2 POWR 3

CTRL 1 CTRL 2 CTRL 3

4 OUTPUTS:

TEMP 1 AHUM 1 POWR 1 POWR 2

PARAMETERS:

1.0000	200.00	4.0000	148.84	1.0000
7.17600E-02	4.54000E-02	0.20000	1.0000	0.15000
2.00000E-02	0.30000			

-----  
 TMIN = 1.000 TMAX = 1000.000 TSTOP = 86400.000  
 -----

BUILDING SHELL MODEL IN SUPERBLOCK 1:  
 CONSTANT TIME STEP TSHLL = 900.00

WEATHER DATA: LATITUDE = 38.850 LONGITUDE = 77.030  
 STARTING DATE: 7 JUL.  
 SOURCE: CLEAR SKY DESIGN DAY METHOD

\*\*\*\*\* SUPERBLOCK 1 \*\*\*\*\*

TIME= 3600.00

TEMP 2	TEMP 3	TEMP 4	TEMP 5	TEMP 6	TEMP 7	TEMP 8	TEMP10
20.2	20.4	20.3	20.2	20.4	20.2	20.5	20.5
TEMP12	POWR 3	POWR 6	POWR 7	POWR 8			
21.3	4.711E-02	0.000	0.000	0.000			

\*\*\*\*\* SUPERBLOCK 1 \*\*\*\*\*

TIME= 7200.00

TEMP 2	TEMP 3	TEMP 4	TEMP 5	TEMP 6	TEMP 7	TEMP 8	TEMP10
20.3	20.4	20.4	20.3	20.5	20.3	20.5	20.5
TEMP12	POWR 3	POWR 6	POWR 7	POWR 8			
20.8	5.145E-02	0.000	0.000	0.000			

\*\*\*\*\* SUPERBLOCK 1 \*\*\*\*\*

TIME= 10800.00

TEMP 2	TEMP 3	TEMP 4	TEMP 5	TEMP 6	TEMP 7	TEMP 8	TEMP10
20.3	20.4	20.4	20.3	20.5	20.3	20.4	20.5
TEMP12	POWR 3	POWR 6	POWR 7	POWR 8			
20.4	5.097E-02	0.000	0.000	0.000			

----- ( OUTPUTS FROM TIME=14400 TO 79200 ARE DELETED) -----

\*\*\*\*\* SUPERBLOCK 1 \*\*\*\*\*

TIME= 82800.00

TEMP 2	TEMP 3	TEMP 4	TEMP 5	TEMP 6	TEMP 7	TEMP 8	TEMP10
20.4	20.6	20.6	20.4	21.1	20.4	20.8	20.7
TEMP12	POWR 3	POWR 6	POWR 7	POWR 8			
22.4	9.917E-02	0.000	0.000	0.000			

\*\*\*\*\* SUPERBLOCK 1 \*\*\*\*\*

TIME= 86400.00

TEMP 2	TEMP 3	TEMP 4	TEMP 5	TEMP 6	TEMP 7	TEMP 8	TEMP10
20.3	20.5	20.5	20.3	20.9	20.3	20.7	20.6





1

ISSHEL =1

Enter the time of day (in hours after midnight)  
at which the simulation is to begin

0

Use default file names for all files? (Y/N) <Y>

N

Enter the name of the Model Definition File,  
or Carriage Return for default name: MODELDEF.DAT

Enter the name of the Boundary Variable File,  
or Carriage Return for default name: BOUNDARY.DAT

Enter the name of the Initial State File,  
or Carriage Return for default name: INITIN.DAT

Enter the name of the Final State File,  
or Carriage Return for default name: INITOUT.DAT

Enter the name of the Output Data File,  
or Carriage Return for default name: MODOUT.DAT

Enter the name of the Simulation Summary File,  
or Carriage Return for default name: MODSUM.DAT  
MODSUM2.DAT

Enter the name of the CTF File,  
or Carriage Return for default name: CTFDATA.DAT

Enter the name of the Weather Data File,  
or Carriage Return for default name: WEATHER.DAT

Do you want Diagnostic Information to be written (N)?

N

Would you like to monitor the Simulation on Screen? (N)

N

```
----- SIMULATION BEGINS -----  
-- FIRST WEATHER DATA SET HAS BEEN READ  
----- INITIALIZATION FILE HAS BEEN WRITTEN -----  
STOP -----END OF SIMULATION -----
```

-----  
\* File: MODSUM2.DAT (for the second run)  
-----

```
***** PROGRAM MODSIM *****  
a MODular SIMulation program
```

ONE ZONE MODEL

2 SUPERBLOCKS            3 BLOCKS            10 UNITS

32 STATE VARIABLES:

3 PRES    1 FLOW    12 TEMP    5 CTRL    8 POWR    3 AHUM

INITIAL STATE VECTOR:

PRES:

0.000000            0.000000            101.300

FLOW:



0.000000

TEMP:

20.0007	20.3429	20.5433	20.5147	20.3472
20.9149	20.3471	20.7106	20.0000	20.6313
20.0000	21.8000			

CTRL:

1.00000	1.00000	1.00000	0.000000	1.00000
---------	---------	---------	----------	---------

POWR:

4.000000E-02	0.135232	8.252382E-02	0.000000	0.000000
0.000000	0.000000	0.000000		

AHUM:

7.400133E-03	7.399999E-03	1.330000E-02		
--------------	--------------	--------------	--	--

0 TIME DEPENDENT BOUNDARY VARIABLES:

ERROR TOLERANCES: RTOLX, ATOLX, XTOL, TTIME:

1.00000E-04	1.00000E-05	2.00000E-04	1.0000
-------------	-------------	-------------	--------

-----  
TMIN = 1.000 TMAX = 1000.000 TSTOP = 172800.000  
-----

BUILDING SHELL MODEL IN SUPERBLOCK 1:

CONSTANT TIME STEP TSHLL = 900.00

WEATHER DATA: LATITUDE = 38.850 LONGITUDE = 77.030

STARTING DATE: 7 JUL.

SOURCE: CLEAR SKY DESIGN DAY METHOD

\*\*\*\*\* SUPERBLOCK 1 \*\*\*\*\*

TIME= 3600.00

TEMP 2	TEMP 3	TEMP 4	TEMP 5	TEMP 6	TEMP 7	TEMP 8	TEMP10
20.7	21.0	20.9	20.7	21.3	20.7	21.1	21.0
TEMP12	POWR 3	POWR 4	POWR 7	POWR 8			
21.3	-0.183	0.000	0.000	0.000			

\*\*\*\*\* SUPERBLOCK 2 \*\*\*\*\*

TIME= 3600.00

TEMP 1	AHUM 1
21.9	7.831E-03

\*\*\*\*\* SUPERBLOCK 1 \*\*\*\*\*

TIME= 7200.00

TEMP 2	TEMP 3	TEMP 4	TEMP 5	TEMP 6	TEMP 7	TEMP 8	TEMP10
20.8	21.2	21.1	20.8	21.4	20.8	21.2	21.2
TEMP12	POWR 3	POWR 4	POWR 7	POWR 8			
20.8	-0.224	0.000	0.000	0.000			

\*\*\*\*\* SUPERBLOCK 2 \*\*\*\*\*

TIME= 7200.00

TEMP 1	AHUM 1
22.1	8.223E-03

----- (OUTPUTS FROM TIME=10800 TO 169200 ARE DELETED) -----

\*\*\*\*\* SUPERBLOCK 1 \*\*\*\*\*

TIME= 172800.00

TEMP 2	TEMP 3	TEMP 4	TEMP 5	TEMP 6	TEMP 7	TEMP 8	TEMP10
21.1	21.7	21.7	21.2	22.1	21.2	21.8	21.6
TEMP12	POWR 3	POWR 6	POWR 7	POWR 8			
21.8	-0.258	0.000	0.000	0.000			

\*\*\*\*\* SUPERBLOCK 2 \*\*\*\*\*

TIME= 172800.00

TEMP 1	AHUM 1
22.6	1.820E-02

-----  
 \* File: MODOUT.DAT (for the second run)  
 -----

SUPERBLOCK 1	1.00				
20.2917	20.5139	20.5405	20.2846	21.1066	
20.2843	21.0060	21.2797	21.8000	8.404082E-02	
0.000000	0.000000	0.000000			
SUPERBLOCK 2	1.00				
20.0016	7.400267E-03				
SUPERBLOCK 2	5.00				
20.0054	7.400803E-03				
SUPERBLOCK 2	13.00				
20.0128	7.401876E-03				
SUPERBLOCK 2	29.00				
20.0277	7.404022E-03				
SUPERBLOCK 2	61.00				
20.0574	7.408317E-03				
SUPERBLOCK 2	125.00				
20.1168	7.416867E-03				
SUPERBLOCK 2	253.00				
20.2349	7.433806E-03				
SUPERBLOCK 2	509.00				
20.4688	7.467050E-03				
SUPERBLOCK 1	900.00				
20.5530	20.9868	20.8029	20.5515	21.2674	
20.5513	21.2203	20.6367	21.6776	1.849874E-03	
0.000000	0.000000	0.000000			
SUPERBLOCK 2	1021.00				
20.8193	7.531371E-03				
SUPERBLOCK 1	1800.00				
20.5248	20.7980	20.7678	20.5321	21.1843	
20.5319	20.9597	20.8542	21.5535	-1.177248E-02	
0.000000	0.000000	0.000000			
SUPERBLOCK 2	2021.00				
21.4451	7.649470E-03				
SUPERBLOCK 1	2700.00				
20.5797	20.8906	20.8064	20.5900	21.1941	
20.5897	21.0495	20.9111	21.4276	-0.116937	
0.000000	0.000000	0.000000			
SUPERBLOCK 2	3021.00				
21.7804	7.765420E-03				
SUPERBLOCK 1	3600.00				
20.6530	21.0056	20.8754	20.6659	21.2501	
20.6655	21.1431	20.9923	21.3000	-0.182925	
0.000000	0.000000	0.000000			

SUPERBLOCK 2	4021.00				
21.9328	7.879067E-03				
SUPERBLOCK 1	4500.00				
20.7129	21.0866	20.9417	20.7276	21.3079	
20.7271	21.1954	21.0578	21.1710	-0.207124	
0.000000	0.000000	0.000000			
SUPERBLOCK 2	5021.00				
22.0143	7.990129E-03				
SUPERBLOCK 1	5400.00				
20.7564	21.1417	20.9970	20.7721	21.3539	
20.7715	21.2228	21.1055	21.0429	-0.216749	
0.000000	0.000000	0.000000			
SUPERBLOCK 2	6021.00				
22.0642	8.098528E-03				
SUPERBLOCK 1	6300.00				
20.7868	21.1799	21.0412	20.8031	21.3862	
20.8026	21.2357	21.1394	20.9184	-0.221382	
0.000000	0.000000	0.000000			
SUPERBLOCK 2	7021.00				
22.0962	8.204252E-03				
SUPERBLOCK 1	7200.00				
20.8078	21.2065	21.0757	20.8246	21.4067	
20.8240	21.2395	21.1629	20.8000	-0.223380	
0.000000	0.000000	0.000000			
SUPERBLOCK 2	8021.00				
22.1167	8.307319E-03				
SUPERBLOCK 1	8100.00				
20.8220	21.2247	21.1021	20.8391	21.4177	
20.8384	21.2374	21.1788	20.6898	-0.225273	
0.000000	0.000000	0.000000			
SUPERBLOCK 1	9000.00				
20.8295	21.2332	21.1203	20.8466	21.4193	
20.8460	21.2272	21.1866	20.5871	-0.223120	
0.000000	0.000000	0.000000			
SUPERBLOCK 2	9021.00				
22.1346	8.407805E-03				

----- (OUTPUTS FROM TIME=9900 TO 171000 ARE DELETED) -----

SUPERBLOCK 2	171021.00				
22.7579	1.824518E-02				
SUPERBLOCK 1	171900.00				
21.1762	21.7274	21.7091	21.2018	22.2095	
21.2008	21.8538	21.6709	21.9322	-0.263855	
0.000000	0.000000	0.000000			
SUPERBLOCK 2	172021.00				
22.6839	1.822144E-02				
SUPERBLOCK 1	172800.00				
21.1395	21.6742	21.6508	21.1642	22.1230	
21.1632	21.7881	21.6196	21.8000	-0.257617	
0.000000	0.000000	0.000000			
SUPERBLOCK 2	172800.00				
22.6373	1.820225E-02				

C. Postprocessing - Output Data Analysis

-----  
\* Execution of SORTSB  
-----

Enter input file name

MODOUT.DAT

Enter output file name

SORTSB.DAT

Superblock # ?

1

SUPERBLOCK 1	1.00			
20.2917	20.5139	20.5405	20.2846	21.1066
20.2843	21.0060	21.2797	21.8000	8.404082E-02
0.000000	0.000000	0.000000		

SUPERBLOCK 2	1.00			
20.0016	7.400267E-03			

SUPERBLOCK 2	5.00			
Number of seconds per unit time?				

3600

Extract another superblock? <N>

N

STOP ---- END OF SORTSB ----

-----  
\* File: SORTSB.DAT (for SUPERBLOCK #1)  
-----

0.277778E-03	20.2917	20.5139	20.5405	20.2846
21.1066	20.2843	21.0060	21.2797	21.8000
0.840408E-01	0.000000	0.000000	0.000000	
0.250000	20.5530	20.9868	20.8029	20.5515
21.2674	20.5513	21.2203	20.6367	21.6776
0.184987E-02	0.000000	0.000000	0.000000	
0.500000	20.5248	20.7980	20.7678	20.5321
21.1843	20.5319	20.9597	20.8542	21.5535
-0.117725E-01	0.000000	0.000000	0.000000	
0.750000	20.5797	20.8906	20.8064	20.5900
21.1941	20.5897	21.0495	20.9111	21.4276
-0.116937	0.000000	0.000000	0.000000	
1.000000	20.6530	21.0056	20.8754	20.6659
21.2501	20.6655	21.1431	20.9923	21.3000
-0.182925	0.000000	0.000000	0.000000	
1.250000	20.7129	21.0866	20.9417	20.7276
21.3079	20.7271	21.1954	21.0578	21.1710
-0.207124	0.000000	0.000000	0.000000	
1.500000	20.7564	21.1417	20.9970	20.7721
21.3539	20.7715	21.2228	21.1055	21.0429
-0.216749	0.000000	0.000000	0.000000	
1.750000	20.7868	21.1799	21.0412	20.8031
21.3862	20.8026	21.2357	21.1394	20.9184
-0.221382	0.000000	0.000000	0.000000	

----- (OUTPUTS FROM TIME=2.00 HOUR TO 45.75 HOUR ARE DELETED) -----

46.0000	21.5826	22.2978	22.3858	21.6182
23.1710	21.6167	22.5207	22.2371	23.2000
-0.300409	0.000000	0.000000	0.000000	
46.2500	21.4953	22.1766	22.2449	21.5297
22.9737	21.5273	22.3873	22.1180	22.9789
-0.291503	0.000000	0.000000	0.000000	
46.5000	21.4200	22.0715	22.1218	21.4517
22.8010	21.4504	22.2689	22.0144	22.7725
-0.283895	0.000000	0.000000	0.000000	
46.7500	21.3547	21.9798	22.0139	21.3847
22.6490	21.3835	22.1632	21.9239	22.5798
-0.277311	0.000000	0.000000	0.000000	
47.0000	21.2977	21.8994	21.9193	21.3263
22.5147	21.3251	22.0486	21.8445	22.4000
-0.271551	0.000000	0.000000	0.000000	
47.2500	21.2476	21.8284	21.8340	21.2750
22.3954	21.2739	21.9836	21.7744	22.2322
-0.266488	0.000000	0.000000	0.000000	
47.5000	21.2160	21.7894	21.7731	21.2427
22.3032	21.2416	21.9335	21.7279	22.0762
-0.281198	0.000000	0.000000	0.000000	
47.7500	21.1762	21.7274	21.7091	21.2018
22.2095	21.2008	21.8538	21.6709	21.9322
-0.263855	0.000000	0.000000	0.000000	
48.0000	21.1395	21.6742	21.6508	21.1642
22.1230	21.1632	21.7801	21.6196	21.8000
-0.257617	0.000000	0.000000	0.000000	

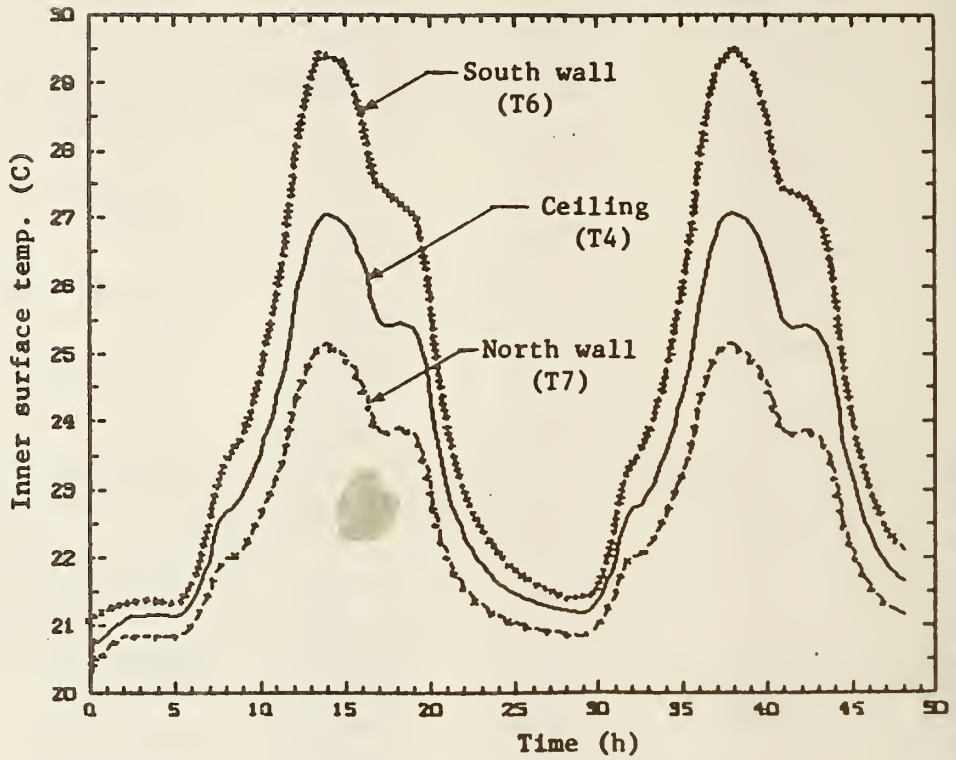

Figure C-3. Inner surface temperatures of the single-zone model

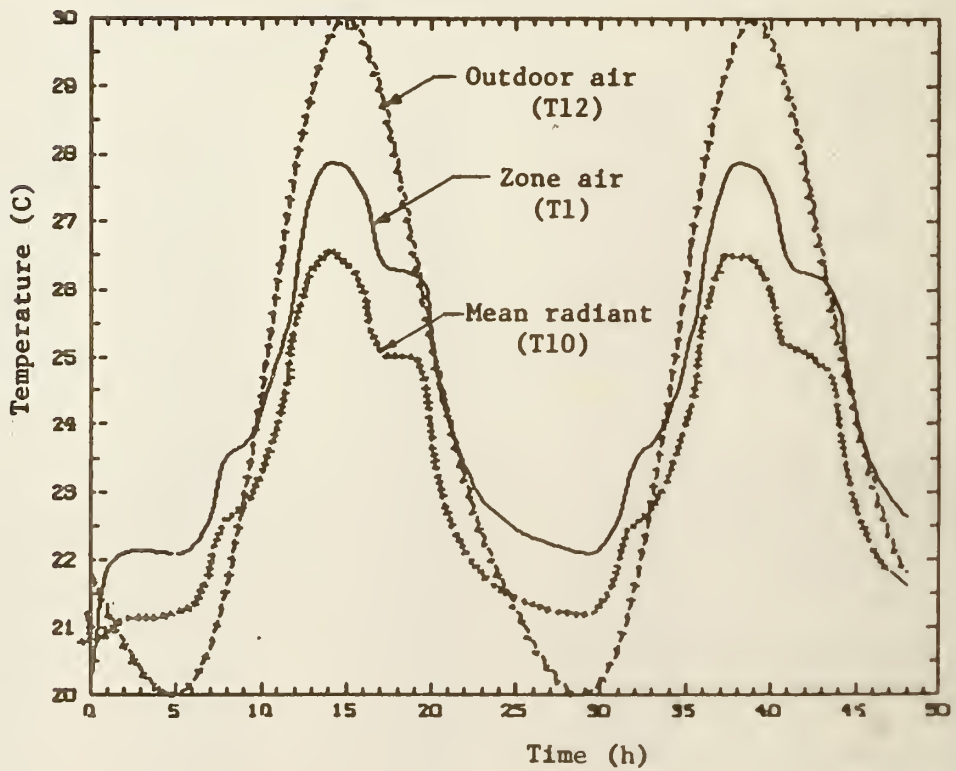

Figure C-4. Outdoor air, zone air, and mean radiant temperatures of the single-zone model

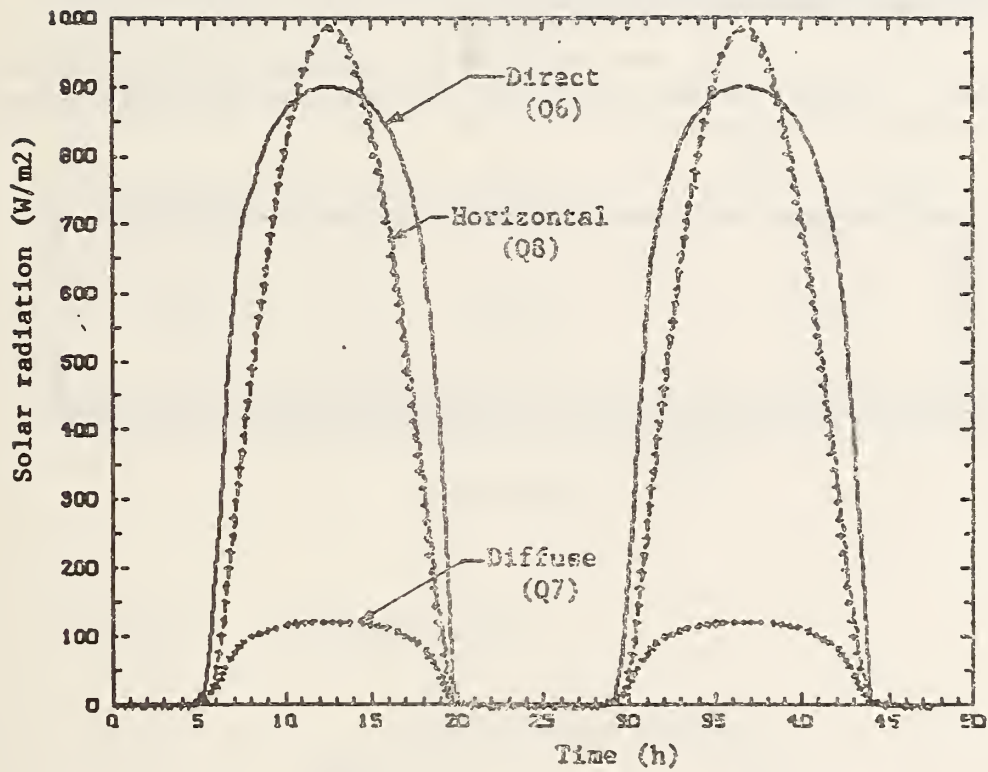

Figure C-5. Artificially generated solar radiation influxes

=====

APPENDIX D: Example 2 Three-zone Building Model

=====

A three-zone building model is simulated in this example, following the Simulation Procedure outlined in Chapter 9 of this report. The purpose of the example is to demonstrate how to use HVACSIM+ with a multizone building model. Selected data files are listed. The weather data file is created by using the weather tape information. The inlet temperature of the inlet duct is selected as a boundary variable. The machine precisions used in this example are the same as those used in Example 1.

A. Preprocessing - Input Data Generation

(1) Creation of Simulation Work File

As shown in Figure D-1, the example model is a single-story building with three zones. A simple system (inlet duct-fan-duct) is connected to one of zones, Zone 3 (see Figure D-2).



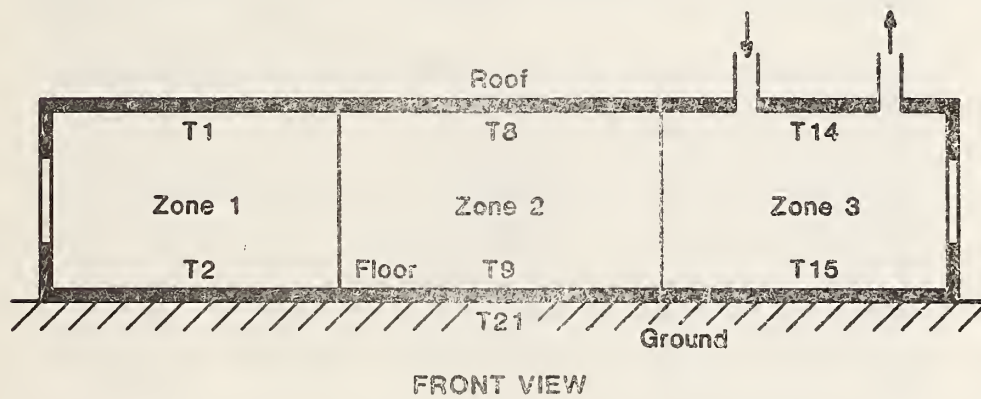
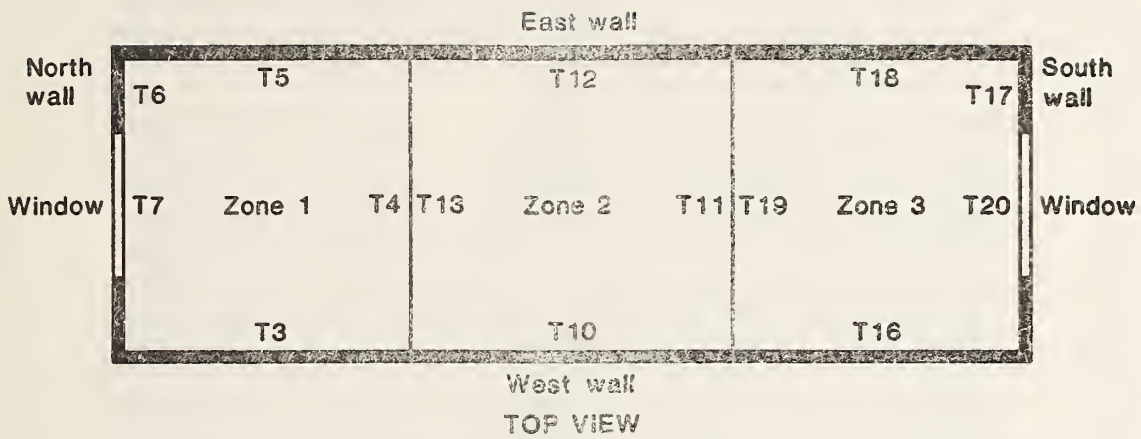

Figure D-1. A three-zone model

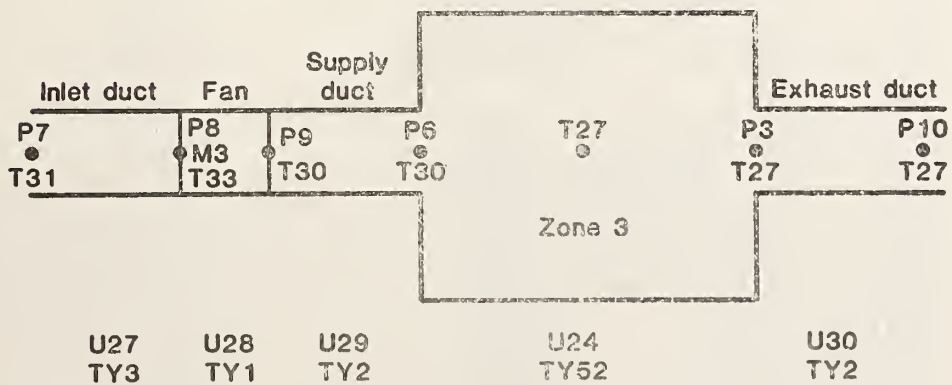

Figure D-2. A simple system (fan and ducts) for Zone 3

-----  
 \* Initial Conditions of State Variables  
 -----

P1	Zone air pressure, gage (IZN=1)	0.0 kPa
P2	Zone air pressure, gage (IZN=2)	0.0 kPa
P3	Zone air pressure, gage (IZN=3)	0.3 kPa
P4	Supply air pressure, gage (IZN=1)	0.0 kPa
P5	Supply air pressure, gage (IZN=2)	0.0 kPa
P6	Supply air pressure, gage (IZN=3)	0.5 kPa
P7	Inlet pressure of the inlet duct	0.0 kPa
P8	Outlet pressure of the inlet duct	-0.8 kPa
P9	Outlet pressure of the fan	1.0 kPa
P10	Outlet pressure of the exhaust duct	-0.5 kPa
P11	Outdoor air barometric pressure	0.0 kPa
M1	Supply air mass flow rate (IZN=1)	0.0 kg/s
M2	Supply air mass flow rate (IZN=2)	0.0 kg/s
M3	Supply air mass flow rate (IZN=3)	2.5 kg/s
T1	Inner surface temp. of roof (IZN=1)	20.0 C
T2	Inner surface temp. of floor	20.0 C
T3	Inner surface temp. of west wall	20.0 C
T4	Inner surface temp. of south wall	20.0 C
T5	Inner surface temp. of east wall	20.0 C
T6	Inner surface temp. of north wall	20.0 C
T7	Inner surface temp. of north window	20.0 C
T8	Inner surface temp. of roof (IZN=2)	20.0 C
T9	Inner surface temp. of floor	20.0 C
T10	Inner surface temp. of west wall	20.0 C
T11	Inner surface temp. of south wall	20.0 C
T12	Inner surface temp. of east wall	20.0 C
T13	Inner surface temp. of north wall	20.0 C
T14	Inner surface temp. of roof (IZN=3)	20.0 C
T15	Inner surface temp. of floor	20.0 C
T16	Inner surface temp. of west wall	20.0 C
T17	Inner surface temp. of south wall	20.0 C
T18	Inner surface temp. of east wall	20.0 C
T19	Inner surface temp. of north wall	20.0 C
T20	Inner surface temp. of south window	20.0 C
T21	Ground temp.	15.0 C
T22	Mean radiant temperature (IZN=1)	20.0 C
T23	Mean radiant temperature (IZN=2)	20.0 C
T24	Mean radiant temperature (IZN=3)	20.0 C
T25	Zone air dry-bulb temp. (IZN=1)	20.0 C
T26	Zone air dry-bulb temp. (IZN=2)	20.0 C
T27	Zone air dry-bulb temp. (IZN=3)	20.0 C
T28	Supply air temp. (IZN=1)	20.0 C
T29	Supply air temp. (IZN=2)	20.0 C
T30	Supply air temp. (IZN=3)	20.0 C
T31	Inlet air temp. of the inlet duct (B.C.)	20.0 C
T32	Outdoor air dry-bulb temp.	20.0 C
T33	Outlet air temp. of the inlet duct	20.0 C
C1	Number of people (IZN=1)	1.0
C2	Equipment utilization coefficient	1.0
C3	Light utilization coefficient	1.0
C4	Shaded fraction of outer surface	0.0
C5	Number of people (IZN=2)	1.0

C6	Equipment utilization coefficient	1.0
C7	Light utilization coefficient	1.0
C8	Shaded fraction of outer surface	0.0
C9	Number of people (IZN=3)	1.0
C10	Equipment utilization coefficient	1.0
C11	Light utilization coefficient	1.0
C12	Shaded fraction of outer surface	0.0
R1	Fan rotational speed	60.0 rev/s
Q1	Convective heat gain from surfaces (IZN=1)	0.0 kW
Q2	Short wave radiant heat gain	0.0 kW
Q3	Long wave radiant heat gain	0.0 kW
Q4	Convective heat gain from surfaces (IZN=2)	0.0 kW
Q5	Short wave radiant heat gain	0.0 kW
Q6	Long wave radiant heat gain	0.0 kW
Q7	Convective heat gain from surfaces (IZN=3)	0.0 kW
Q8	Short wave radiant heat gain	0.0 kW
Q9	Long wave radiant heat gain	0.0 kW
Q10	Fan power consumption	0.0 kW
Q11	Direct solar radiation	0.0 kW
Q12	Diffuse solar radiation	0.0 kW
Q13	Total horizontal solar radiation	0.0 kW
H1	Zone air humidity ratio (IZN=1)	0.0074
H2	Zone air humidity ratio (IZN=2)	0.0074
H3	Zone air humidity ratio (IZN=3)	0.0074
H4	Supply air humidity ratio (IZN=1)	0.0074
H5	Supply air humidity ratio (IZN=2)	0.0074
H6	Supply air humidity ratio (IZN=3)	0.0074
H7	Outdoor air humidity ratio	0.0

-----  
\* Execution of HVACGEN  
-----

HVACGEN - Simulation GENERation Program  
Version 1.8 (08-16 1985)

Choose from the list below:

CReate (Simulation,BLock,UNit)

EDit (Simulation,UNit)

VView (Simulation,BLock,UNit)

HElp

ENd

Selection ?

VI

View a:

Simulation

Block

UNit

Enter Selection

S1

Enter the filename (Maximum of 8 characters)

THRIZONE

reading from work file....

INITIALIZING TYPES INFORMATION...

What part of the simulation would you like to view:

ALL the simulation information (for documentation)

SStructure (superblock,block, and unit Information)

VVariable initial values

ERror tolerances, variable scan and freeze options

BBoundary variables

REported variables

COntinue with the previous menu

AL

THREE ZONE BUILDING MODEL --A SINGLE STORY BUILDING

SUPERBLOCK 1

  BLOCK 1

    UNIT 1

      TYPE 50 - ZONE ENVELOPE

UNIT 2 TYPE 51 - BUILDING SURFACE  
 UNIT 3 TYPE 51 - BUILDING SURFACE  
 UNIT 4 TYPE 51 - BUILDING SURFACE  
 UNIT 5 TYPE 51 - BUILDING SURFACE  
 UNIT 6 TYPE 51 - BUILDING SURFACE  
 UNIT 7 TYPE 51 - BUILDING SURFACE  
 UNIT 8 TYPE 51 - BUILDING SURFACE

BLOCK 2

UNIT 9 TYPE 50 - ZONE ENVELOPE  
 UNIT 10 TYPE 51 - BUILDING SURFACE  
 UNIT 11 TYPE 51 - BUILDING SURFACE  
 UNIT 12 TYPE 51 - BUILDING SURFACE  
 UNIT 13 TYPE 51 - BUILDING SURFACE  
 UNIT 14 TYPE 51 - BUILDING SURFACE  
 UNIT 15 TYPE 51 - BUILDING SURFACE  
 UNIT 16 TYPE 51 - BUILDING SURFACE

BLOCK 3

UNIT 17 TYPE 50 - ZONE ENVELOPE  
 UNIT 18 TYPE 51 - BUILDING SURFACE  
 UNIT 19 TYPE 51 - BUILDING SURFACE  
 UNIT 20 TYPE 51 - BUILDING SURFACE  
 UNIT 21 TYPE 51 - BUILDING SURFACE  
 UNIT 22 TYPE 51 - BUILDING SURFACE  
 UNIT 23 TYPE 51 - BUILDING SURFACE

BLOCK 4

UNIT 31 TYPE 53 - WEATHER INPUT

SUPERBLOCK 2

BLOCK 5

UNIT 24 TYPE 52 - ZONE MODEL

BLOCK 6

UNIT 25 TYPE 52 - ZONE MODEL

BLOCK 7

UNIT 26 TYPE 52 - ZONE MODEL

BLOCK 8

UNIT 27 TYPE 3 - INLET CONDUIT (DUCT OR PIPE)  
 UNIT 28 TYPE 1 - FAN OR PUMP  
 UNIT 29 TYPE 2 - CONDUIT (DUCT OR PIPE)  
 UNIT 30 TYPE 2 - CONDUIT (DUCT OR PIPE)

UNIT 1 TYPE 50  
 ZONE ENVELOPE

1 INPUTS:

TEMPERATURE 27 - TIA: Zone air dry-bulb temperature  
 POWER 8 - QISW: Internal (short wave) radiant gain  
 POWER 9 - QILW: Internal (long wave) radiant gain  
 TEMPERATURE 14 - TIS(1): Inner surface temperature  
 TEMPERATURE 15 - TIS(2): Inner surface temperature  
 TEMPERATURE 16 - TIS(3): Inner surface temperature  
 TEMPERATURE 17 - TIS(4): Inner surface temperature  
 TEMPERATURE 18 - TIS(5): Inner surface temperature  
 TEMPERATURE 19 - TIS(6): Inner surface temperature  
 TEMPERATURE 20 - TIS(7): Inner surface temperature  
 TEMPERATURE 20 - TIS(8): Inner surface temperature  
 TEMPERATURE 20 - TIS(9): Inner surface temperature  
 TEMPERATURE 20 - TIS(10): Inner surface temperature

2 OUTPUTS:

TEMPERATURE 24 - TMR: Mean radiant temperature  
 POWER 7 - QWALL: Convective heat gain from surfaces

3 PARAMETERS:

3.00000 IZN: Identification number of zone  
 7.00000 NS: Number of surfaces of zone

UNIT 2 TYPE 51  
 BUILDING SURFACE

1 INPUTS:

TEMPERATURE 27 - TIA: Indoor air dry-bulb temperature  
 TEMPERATURE 24 - TMR: Mean radiant temperature  
 TEMPERATURE 14 - TOSINF: Outer surface temp. of unexposed wall  
 CONTROL 12 - FSHADW: Shaded fraction of exposed surface

2 OUTPUTS:

TEMPERATURE 14 - TIS: Inner surface temperature  
 POWER 0 - SOLINT: Integrated solar influx on surface

3 PARAMETERS:

3.00000 IZN: Identification number of zone  
 1.00000 ID: Identification number of surface  
 2.00000 IEXPOS: 0=W/in zone, 1=betw.zones, 2=exposed to sun  
 1.00000 ISTR: Identification number of the construct  
 37.2100 AS: Surface area (m2)  
 0.000000 ORIENT: Azimuth angle of normal to surface & south  
 0.000000 TILT: Tilt angle: flat roof=0, floor=180 (degree)  
 0.200000 GRF: Ground reflectivity (-)  
 1.00000 IROFS: Outer surface roughness index: 1=stucco, ...  
 0.600000 ABSOS: Solar absorptance of outer surface (-)  
 0.650000 ABSIS: Short wave absorptance of inner surface (-)  
 0.900000 EMITIS: Emissivity of the inner surface (-)  
 0.000000 TRANSM: Transmittance of the glass window (-)  
 0.000000 SC: Shading coeff. of the glass window (-)

UNIT 3 TYPE 51  
 BUILDING SURFACE

1 INPUTS:

TEMPERATURE 27 - TIA: Indoor air dry-bulb temperature  
 TEMPERATURE 24 - TMR: Mean radiant temperature  
 TEMPERATURE 21 - TOSINF: Outer surface temp. of unexposed wall  
 CONTROL 12 - FSHADW: Shaded fraction of exposed surface

2 OUTPUTS:

TEMPERATURE 15 - TIS: Inner surface temperature  
 POWER 0 - SOLINT: Integrated solar influx on surface

3 PARAMETERS:

3.00000 IZN: Identification number of zone  
 2.00000 ID: Identification number of surface  
 1.00000 IEXPOS: 0=W/in zone, 1=betw.zones, 2=exposed to sun  
 2.00000 ISTR: Identification number of the construct  
 37.2100 AS: Surface area (m2)  
 0.000000 ORIENT: Azimuth angle of normal to surface & south  
 180.000 TILT: Tilt angle: flat roof=0, floor=180 (degree)  
 0.200000 GRF: Ground reflectivity (-)

0.000000 IROFS: Outer surface roughness index: 1=stucco,...  
 0.000000 ABSOS: Solar absorptance of outer surface (-)  
 0.650000 ABSIS: Short wave absorptance of inner surface(-)  
 0.900000 EMITIS: Emissivity of the inner surface (-)  
 0.000000 TRANSM: Transmittance of the glass window (-)  
 0.000000 SC: Shading coeff. of the glass window (-)

---

UNIT 4 TYPE 51  
BUILDING SURFACE

1 INPUTS:

TEMPERATURE	27 - TIA:	Indoor air dry-bulb temperature
TEMPERATURE	24 - TMR:	Mean radiant temperature
TEMPERATURE	16 - TOSINF:	Outer surface temp. of unexposed wall
CONTROL	12 - FSHADW:	Shaded fraction of exposed surface

2 OUTPUTS:

TEMPERATURE	16 - TIS:	Inner surface temperature
POWER	0 - SOLINT:	Integrated solar influx on surface

3 PARAMETERS:

3.00000	IZN:	Identification number of zone
3.00000	ID:	Identification number of surface
2.00000	IEXPOS:	0=W/in zone, 1=betw.zones, 2=exposed to sun
3.00000	ISTR:	Identification number of the construct
24.4000	AS:	Surface area (m2)
90.0000	ORIENT:	Azimuth angle of normal to surface & south
90.0000	TILT:	Tilt angle: flat roof=0, floor=180 (degree)
0.200000	GRF:	Ground reflectivity (-)
5.00000	IROFS:	Outer surface roughness index: 1=stucco,...
0.400000	ABSOS:	Solar absorptance of outer surface (-)
0.650000	ABSIS:	Short wave absorptance of inner surface(-)
0.900000	EMITIS:	Emissivity of the inner surface (-)
0.000000	TRANSM:	Transmittance of the glass window (-)
0.000000	SC:	Shading coeff. of the glass window (-)

---

UNIT 5 TYPE 51  
BUILDING SURFACE

1 INPUTS:

TEMPERATURE	27 - TIA:	Indoor air dry-bulb temperature
TEMPERATURE	24 - TMR:	Mean radiant temperature
TEMPERATURE	17 - TOSINF:	Outer surface temp. of unexposed wall
CONTROL	12 - FSHADW:	Shaded fraction of exposed surface

2 OUTPUTS:

TEMPERATURE	17 - TIS:	Inner surface temperature
POWER	0 - SOLINT:	Integrated solar influx on surface

3 PARAMETERS:

3.00000	IZN:	Identification number of zone
4.00000	ID:	Identification number of surface
2.00000	IEXPOS:	0=W/in zone, 1=betw.zones, 2=exposed to sun
3.00000	ISTR:	Identification number of the construct
18.4000	AS:	Surface area (m2)
0.000000	ORIENT:	Azimuth angle of normal to surface & south
90.0000	TILT:	Tilt angle: flat roof=0, floor=180 (degree)
0.200000	GRF:	Ground reflectivity (-)

5.00000	IROFS:	Outer surface roughness index: 1=stucco,...
0.400000	ABSOS:	Solar absorptance of outer surface (-)
0.650000	ABSIS:	Short wave absorptance of inner surface(-)
0.900000	EMITIS:	Emissivity of the inner surface (-)
0.000000	TRANSM:	Transmittance of the glass window (-)
0.000000	SC:	Shading coeff. of the glass window (-)

---

UNIT 6 TYPE 51  
BUILDING SURFACE

1	INPUTS:		
	TEMPERATURE	27 - TIA:	Indoor air dry-bulb temperature
	TEMPERATURE	24 - TMR:	Mean radiant temperature
	TEMPERATURE	18 - TOSINF:	Outer surface temp. of unexposed wall
	CONTROL	12 - FSHADW:	Shaded fraction of exposed surface
2	OUTPUTS:		
	TEMPERATURE	18 - TIS:	Inner surface temperature
	POWER	0 - SOLINT:	Integrated solar influx on surface
3	PARAMETERS:		
	3.00000	IZN:	Identification number of zone
	5.00000	ID:	Identification number of surface
	2.00000	IEXPOS:	0=W/in zone, 1=betw.zones, 2=exposed to sun
	3.00000	ISTR:	Identification number of the construct
	24.4000	AS:	Surface area (m2)
	270.000	ORIENT:	Azimuth angle of normal to surface & south
	90.0000	TILT:	Tilt angle: flat roof=0, floor=180 (degree)
	0.200000	GRF:	Ground reflectivity (-)
	5.00000	IROFS:	Outer surface roughness index: 1=stucco,...
	0.400000	ABSOS:	Solar absorptance of outer surface (-)
	0.650000	ABSIS:	Short wave absorptance of inner surface(-)
	0.900000	EMITIS:	Emissivity of the inner surface (-)
	0.000000	TRANSM:	Transmittance of the glass window (-)
	0.000000	SC:	Shading coeff. of the glass window (-)

---

UNIT 7 TYPE 51  
BUILDING SURFACE

1	INPUTS:		
	TEMPERATURE	27 - TIA:	Indoor air dry-bulb temperature
	TEMPERATURE	24 - TMR:	Mean radiant temperature
	TEMPERATURE	11 - TOSINF:	Outer surface temp. of unexposed wall
	CONTROL	12 - FSHADW:	Shaded fraction of exposed surface
2	OUTPUTS:		
	TEMPERATURE	19 - TIS:	Inner surface temperature
	POWER	0 - SOLINT:	Integrated solar influx on surface
3	PARAMETERS:		
	3.00000	IZN:	Identification number of zone
	6.00000	ID:	Identification number of surface
	1.00000	IEXPOS:	0=W/in zone, 1=betw.zones, 2=exposed to sun
	5.00000	ISTR:	Identification number of the construct
	24.4000	AS:	Surface area (m2)
	0.000000	ORIENT:	Azimuth angle of normal to surface & south
	90.0000	TILT:	Tilt angle: flat roof=0, floor=180 (degree)
	0.200000	GRF:	Ground reflectivity (-)



5.00000	IROFS: Outer surface roughness index: 1=stucco,...
0.600000	ABSOS: Solar absorptance of outer surface (-)
0.650000	ABSI: Short wave absorptance of inner surface(-)
0.900000	EMITIS: Emissivity of the inner surface (-)
0.000000	TRANSM: Transmittance of the glass window (-)
0.000000	SC: Shading coeff. of the glass window (-)

---

UNIT 8 TYPE 51  
BUILDING SURFACE

1 INPUTS:

TEMPERATURE	27 - TIA: Indoor air dry-bulb temperature
TEMPERATURE	24 - TMR: Mean radiant temperature
TEMPERATURE	20 - TOSINF: Outer surface temp. of unexposed wall
CONTROL	12 - FSHADW: Shaded fraction of exposed surface

2 OUTPUTS:

TEMPERATURE	20 - TIS: Inner surface temperature
POWER	0 - SOLINT: Integrated solar influx on surface

3 PARAMETERS:

3.00000	IZN: Identification number of zone
7.00000	ID: Identification number of surface
2.00000	IEXPOS: 0=W/in zone, 1=betw.zones, 2=exposed to sun
4.00000	ISTR: Identification number of the construct
6.00000	AS: Surface area (m2)
0.000000	ORIENT: Azimuth angle of normal to surface & south
90.0000	TILT: Tilt angle: flat roof=0, floor=180 (degree)
0.200000	GRF: Ground reflectivity (-)
6.00000	IROFS: Outer surface roughness index: 1=stucco,...
0.000000	ABSOS: Solar absorptance of outer surface (-)
0.000000	ABSI: Short wave absorptance of inner surface(-)
0.000000	EMITIS: Emissivity of the inner surface (-)
0.850000	TRANSM: Transmittance of the glass window (-)
0.800000	SC: Shading coeff. of the glass window (-)

---

UNIT 9 TYPE 50  
ZONE ENVELOPE

1 INPUTS:

TEMPERATURE	25 - TIA: Zone air dry-bulb temperature
POWER	2 - QISW: Internal (short wave) radiant gain
POWER	3 - QILW: Internal (long wave) radiant gain
TEMPERATURE	1 - TIS(1): Inner surface temperature
TEMPERATURE	2 - TIS(2): Inner surface temperature
TEMPERATURE	3 - TIS(3): Inner surface temperature
TEMPERATURE	4 - TIS(4): Inner surface temperature
TEMPERATURE	5 - TIS(5): Inner surface temperature
TEMPERATURE	6 - TIS(6): Inner surface temperature
TEMPERATURE	7 - TIS(7): Inner surface temperature
TEMPERATURE	7 - TIS(8): Inner surface temperature
TEMPERATURE	7 - TIS(9): Inner surface temperature
TEMPERATURE	7 - TIS(10): Inner surface temperature

2 OUTPUTS:

TEMPERATURE	22 - TMR: Mean radiant temperature
POWER	1 - QWALL: Convective heat gain from surfaces

3      PARAMETERS:  
           1.00000      IZN:      Identification number of zone  
           7.00000      NS:      Number of surfaces of zone

---

UNIT 10      TYPE 51  
 BUILDING SURFACE

1      INPUTS:  
           TEMPERATURE      25 - TIA:      Indoor air dry-bulb temperature  
           TEMPERATURE      22 - TMR:      Mean radiant temperature  
           TEMPERATURE      1 - TOSINF: Outer surface temp. of unexposed wall  
           CONTROL            4 - FSHADW: Shaded fraction of exposed surface

2      OUTPUTS:  
           TEMPERATURE      1 - TIS:      Inner surface temperature  
           POWER            0 - SOLINT: Integrated solar influx on surface

3      PARAMETERS:  
           1.00000      IZN:      Identification number of zone  
           1.00000      ID:      Identification number of surface  
           2.00000      IEXPOS: 0=W/in zone, 1=betw.zones, 2=exposed to sun  
           1.00000      ISTR:      Identification number of the construct  
           37.2100      AS:      Surface area (m2)  
           0.000000      ORIENT: Azimuth angle of normal to surface & south  
           0.000000      TILT:      Tilt angle: flat roof=0, floor=180 (degree)  
           0.200000      GRF:      Ground reflectivity (-)  
           1.00000      IROFS:      Outer surface roughness index: 1=stucco, ...  
           0.600000      ABSOS:      Solar absorptance of outer surface (-)  
           0.650000      ABSIS:      Short wave absorptance of inner surface(-)  
           0.900000      EMITIS:      Emissivity of the inner surface (-)  
           0.000000      TRANSM:      Transmittance of the glass window (-)  
           0.000000      SC:      Shading coeff. of the glass window (-)

---

UNIT 11      TYPE 51  
 BUILDING SURFACE

1      INPUTS:  
           TEMPERATURE      25 - TIA:      Indoor air dry-bulb temperature  
           TEMPERATURE      22 - TMR:      Mean radiant temperature  
           TEMPERATURE      21 - TOSINF: Outer surface temp. of unexposed wall  
           CONTROL            4 - FSHADW: Shaded fraction of exposed surface

2      OUTPUTS:  
           TEMPERATURE      2 - TIS:      Inner surface temperature  
           POWER            0 - SOLINT: Integrated solar influx on surface

3      PARAMETERS:  
           1.00000      IZN:      Identification number of zone  
           2.00000      ID:      Identification number of surface  
           1.00000      IEXPOS: 0=W/in zone, 1=betw.zones, 2=exposed to sun  
           2.00000      ISTR:      Identification number of the construct  
           37.2100      AS:      Surface area (m2)  
           0.000000      ORIENT: Azimuth angle of normal to surface & south  
           180.000      TILT:      Tilt angle: flat roof=0, floor=180 (degree)  
           0.000000      GRF:      Ground reflectivity (-)  
           0.000000      IROFS:      Outer surface roughness index: 1=stucco, ...  
           0.000000      ABSOS:      Solar absorptance of outer surface (-)  
           0.650000      ABSIS:      Short wave absorptance of inner surface(-)

0.900000 EMITIS: Emissivity of the inner surface (-)  
 0.000000 TRANSM: Transmittance of the glass window (-)  
 0.000000 SC: Shading coeff. of the glass window (-)

---

UNIT 12 TYPE 51  
 BUILDING SURFACE

1 INPUTS:  
 TEMPERATURE 25 - TIA: Indoor air dry-bulb temperature  
 TEMPERATURE 22 - TMR: Mean radiant temperature  
 TEMPERATURE 3 - TOSINF: Outer surface temp. of unexposed wall  
 CONTROL 4 - FSHADW: Shaded fraction of exposed surface

2 OUTPUTS:  
 TEMPERATURE 3 - TIS: Inner surface temperature  
 POWER 0 - SOLINT: Integrated solar influx on surface

3 PARAMETERS:  
 1.00000 IZN: Identification number of zone  
 3.00000 ID: Identification number of surface  
 2.00000 IEXPOS: 0=W/in zone, 1=betw.zones, 2=exposed to sun  
 3.00000 ISTR: Identification number of the construct  
 24.4000 AS: Surface area (m2)  
 90.0000 ORIENT: Azimuth angle of normal to surface & south  
 90.0000 TILT: Tilt angle: flat roof=0, floor=180 (degree)  
 0.200000 GRF: Ground reflectivity (-)  
 5.00000 IROFS: Outer surface roughness index: 1=stucco,...  
 0.400000 ABSOS: Solar absorptance of outer surface (-)  
 0.650000 ABSIS: Short wave absorptance of inner surface(-)  
 0.900000 EMITIS: Emissivity of the inner surface (-)  
 0.000000 TRANSM: Transmittance of the glass window (-)  
 0.000000 SC: Shading coeff. of the glass window (-)

---

UNIT 13 TYPE 51  
 BUILDING SURFACE

1 INPUTS:  
 TEMPERATURE 25 - TIA: Indoor air dry-bulb temperature  
 TEMPERATURE 22 - TMR: Mean radiant temperature  
 TEMPERATURE 13 - TOSINF: Outer surface temp. of unexposed wall  
 CONTROL 4 - FSHADW: Shaded fraction of exposed surface

2 OUTPUTS:  
 TEMPERATURE 4 - TIS: Inner surface temperature  
 POWER 0 - SOLINT: Integrated solar influx on surface

3 PARAMETERS:  
 1.00000 IZN: Identification number of zone  
 4.00000 ID: Identification number of surface  
 1.00000 IEXPOS: 0=W/in zone, 1=betw.zones, 2=exposed to sun  
 5.00000 ISTR: Identification number of the construct  
 24.4000 AS: Surface area (m2)  
 180.000 ORIENT: Azimuth angle of normal to surface & south  
 90.0000 TILT: Tilt angle: flat roof=0, floor=180 (degree)  
 0.200000 GRF: Ground reflectivity (-)  
 0.000000 IROFS: Outer surface roughness index: 1=stucco,...  
 0.000000 ABSOS: Solar absorptance of outer surface (-)  
 0.650000 ABSIS: Short wave absorptance of inner surface(-)

0.900000 EMITIS: Emissivity of the inner surface (-)  
 0.000000 TRANSM: Transmittance of the glass window (-)  
 0.000000 SC: Shading coeff. of the glass window (-)

-----  
 UNIT 14 TYPE 51  
 BUILDING SURFACE

1 INPUTS:  
 TEMPERATURE 25 - TIA: Indoor air dry-bulb temperature  
 TEMPERATURE 22 - TMR: Mean radiant temperature  
 TEMPERATURE 5 - TOSINF: Outer surface temp. of unexposed wall  
 CONTROL 4 - FSHADW: Shaded fraction of exposed surface

2 OUTPUTS:  
 TEMPERATURE 5 - TIS: Inner surface temperature  
 POWER 0 - SOLINT: Integrated solar influx on surface

3 PARAMETERS:  
 1.00000 IZN: Identification number of zone  
 5.00000 ID: Identification number of surface  
 2.00000 IEXPOS: 0=W/in zone, 1=betw.zones, 2=exposed to sun  
 3.00000 ISTR: Identification number of the construct  
 24.4000 AS: Surface area (m2)  
 270.000 ORIENT: Azimuth angle of normal to surface & south  
 90.0000 TILT: Tilt angle: flat roof=0, floor=180 (degree)  
 0.200000 GRF: Ground reflectivity (-)  
 5.00000 IROFS: Outer surface roughness index: 1=stucco, ...  
 0.400000 ABSOS: Solar absorptance of outer surface (-)  
 0.650000 ABSIS: Short wave absorptance of inner surface(-)  
 0.900000 EMITIS: Emissivity of the inner surface (-)  
 0.000000 TRANSM: Transmittance of the glass window (-)  
 0.000000 SC: Shading coeff. of the glass window (-)

-----  
 UNIT 15 TYPE 51  
 BUILDING SURFACE

1 INPUTS:  
 TEMPERATURE 25 - TIA: Indoor air dry-bulb temperature  
 TEMPERATURE 22 - TMR: Mean radiant temperature  
 TEMPERATURE 6 - TOSINF: Outer surface temp. of unexposed wall  
 CONTROL 4 - FSHADW: Shaded fraction of exposed surface

2 OUTPUTS:  
 TEMPERATURE 6 - TIS: Inner surface temperature  
 POWER 0 - SOLINT: Integrated solar influx on surface

3 PARAMETERS:  
 1.00000 IZN: Identification number of zone  
 6.00000 ID: Identification number of surface  
 2.00000 IEXPOS: 0=W/in zone, 1=betw.zones, 2=exposed to sun  
 3.00000 ISTR: Identification number of the construct  
 18.4000 AS: Surface area (m2)  
 180.000 ORIENT: Azimuth angle of normal to surface & south  
 90.0000 TILT: Tilt angle: flat roof=0, floor=180 (degree)  
 0.200000 GRF: Ground reflectivity (-)  
 5.00000 IROFS: Outer surface roughness index: 1=stucco, ...  
 0.400000 ABSOS: Solar absorptance of outer surface (-)  
 0.650000 ABSIS: Short wave absorptance of inner surface(-)

0.900000 EMITIS: Emissivity of the inner surface (-)  
0.000000 TRANSM: Transmittance of the glass window (-)  
0.000000 SC: Shading coeff. of the glass window (-)

---

UNIT 16 TYPE 51  
BUILDING SURFACE

1 INPUTS:

TEMPERATURE 25 - TIA: Indoor air dry-bulb temperature  
TEMPERATURE 22 - TMR: Mean radiant temperature  
TEMPERATURE 7 - TOSINF: Outer surface temp. of unexposed wall  
CONTROL 4 - FSHADW: Shaded fraction of exposed surface

2 OUTPUTS:

TEMPERATURE 7 - TIS: Inner surface temperature  
POWER 0 - SOLINT: Integrated solar influx on surface

3 PARAMETERS:

1.00000 IZN: Identification number of zone  
7.00000 ID: Identification number of surface  
2.00000 IEXPOS: 0=W/in zone, 1=betw.zones, 2=exposed to sun  
4.00000 ISTR: Identification number of the construct  
6.00000 AS: Surface area (m2)  
180.000 ORIENT: Azimuth angle of normal to surface & south  
90.0000 TILT: Tilt angle: flat roof=0, floor=180 (degree)  
0.200000 GRF: Ground reflectivity (-)  
6.00000 IROFS: Outer surface roughness index: 1=stucco,...  
0.000000 ABSOS: Solar absorptance of outer surface (-)  
0.000000 ABSIS: Short wave absorptance of inner surface(-)  
0.000000 EMITIS: Emissivity of the inner surface (-)  
0.850000 TRANSM: Transmittance of the glass window (-)  
0.800000 SC: Shading coeff. of the glass window (-)

---

UNIT 17 TYPE 50  
 ZONE ENVELOPE

- 1 INPUTS:
- |             |               |                                    |
|-------------|---------------|------------------------------------|
| TEMPERATURE | 26 - TIA:     | Zone air dry-bulb temperature      |
| POWER       | 5 - QISW:     | Internal (short wave) radiant gain |
| POWER       | 6 - QILW:     | Internal (long wave) radiant gain  |
| TEMPERATURE | 8 - TIS(1):   | Inner surface temperature          |
| TEMPERATURE | 9 - TIS(2):   | Inner surface temperature          |
| TEMPERATURE | 10 - TIS(3):  | Inner surface temperature          |
| TEMPERATURE | 11 - TIS(4):  | Inner surface temperature          |
| TEMPERATURE | 12 - TIS(5):  | Inner surface temperature          |
| TEMPERATURE | 13 - TIS(6):  | Inner surface temperature          |
| TEMPERATURE | 13 - TIS(7):  | Inner surface temperature          |
| TEMPERATURE | 13 - TIS(8):  | Inner surface temperature          |
| TEMPERATURE | 13 - TIS(9):  | Inner surface temperature          |
| TEMPERATURE | 13 - TIS(10): | Inner surface temperature          |
- 2 OUTPUTS:
- |             |            |                                    |
|-------------|------------|------------------------------------|
| TEMPERATURE | 23 - TMR:  | Mean radiant temperature           |
| POWER       | 4 - QWALL: | Convective heat gain from surfaces |
- 3 PARAMETERS:
- |         |      |                               |
|---------|------|-------------------------------|
| 2.00000 | IZN: | Identification number of zone |
| 6.00000 | NS:  | Number of surfaces of zone    |
- 

UNIT 18 TYPE 51  
 BUILDING SURFACE

- 1 INPUTS:
- |             |             |                                       |
|-------------|-------------|---------------------------------------|
| TEMPERATURE | 26 - TIA:   | Indoor air dry-bulb temperature       |
| TEMPERATURE | 23 - TMR:   | Mean radiant temperature              |
| TEMPERATURE | 4 - TOSINF: | Outer surface temp. of unexposed wall |
| CONTROL     | 8 - FSHADW: | Shaded fraction of exposed surface    |
- 2 OUTPUTS:
- |             |             |                                    |
|-------------|-------------|------------------------------------|
| TEMPERATURE | 13 - TIS:   | Inner surface temperature          |
| POWER       | 0 - SOLINT: | Integrated solar influx on surface |
- 3 PARAMETERS:
- |          |         |   |
|----------|---------|---|
| 2.00000  | IZN:    | Identification number of zone               |
| 6.00000  | ID:     | Identification number of surface            |
| 1.00000  | IEXPOS: | 0=W/in zone, 1=betw.zones, 2=exposed to sun |
| 5.00000  | ISTR:   | Identification number of the construct      |
| 24.4000  | AS:     | Surface area (m2)                           |
| 0.000000 | ORIENT: | Azimuth angle of normal to surface & south  |
| 90.0000  | TILT:   | Tilt angle: flat roof=0, floor=180 (degree) |
| 0.200000 | GRF:    | Ground reflectivity (-)                     |
| 0.000000 | IROFS:  | Outer surface roughness index: 1=stucco,... |
| 0.000000 | ABSOS:  | Solar absorptance of outer surface (-)      |
| 0.650000 | ABSIS:  | Short wave absorptance of inner surface(-)  |
| 0.900000 | EMITIS: | Emissivity of the inner surface (-)         |
| 0.000000 | TRANSM: | Transmittance of the glass window (-)       |
| 0.000000 | SC:     | Shading coeff. of the glass window (-)      |
-

UNIT 19 TYPE 51  
BUILDING SURFACE

1 INPUTS:  
 TEMPERATURE 26 - TIA: Indoor air dry-bulb temperature  
 TEMPERATURE 23 - TMR: Mean radiant temperature  
 TEMPERATURE 12 - TOSINF: Outer surface temp. of unexposed wall  
 CONTROL 8 - FSHADW: Shaded fraction of exposed surface

2 OUTPUTS:  
 TEMPERATURE 12 - TIS: Inner surface temperature  
 POWER 0 - SOLINT: Integrated solar influx on surface

3 PARAMETERS:  
 2.00000 IZN: Identification number of zone  
 5.00000 ID: Identification number of surface  
 2.00000 IEXPOS: 0=W/in zone, 1=betw.zones, 2=exposed to sun  
 3.00000 ISTR: Identification number of the construct  
 24.4000 AS: Surface area (m2)  
 270.000 ORIENT: Azimuth angle of normal to surface & south  
 90.0000 TILT: Tilt angle: flat roof=0, floor=180 (degree)  
 0.200000 GRF: Ground reflectivity (-)  
 5.00000 IROFS: Outer surface roughness index: 1=stucco,...  
 0.400000 ABSOS: Solar absorptance of outer surface (-)  
 0.650000 ABSIS: Short wave absorptance of inner surface(-)  
 0.900000 EMITIS: Emissivity of the inner surface (-)  
 0.000000 TRANSM: Transmittance of the glass window (-)  
 0.000000 SC: Shading coeff. of the glass window (-)

---

UNIT 20 TYPE 51  
BUILDING SURFACE

1 INPUTS:  
 TEMPERATURE 26 - TIA: Indoor air dry-bulb temperature  
 TEMPERATURE 23 - TMR: Mean radiant temperature  
 TEMPERATURE 19 - TOSINF: Outer surface temp. of unexposed wall  
 CONTROL 8 - FSHADW: Shaded fraction of exposed surface

2 OUTPUTS:  
 TEMPERATURE 11 - TIS: Inner surface temperature  
 POWER 0 - SOLINT: Integrated solar influx on surface

3 PARAMETERS:  
 2.00000 IZN: Identification number of zone  
 4.00000 ID: Identification number of surface  
 1.00000 IEXPOS: 0=W/in zone, 1=betw.zones, 2=exposed to sun  
 5.00000 ISTR: Identification number of the construct  
 24.4000 AS: Surface area (m2)  
 180.000 ORIENT: Azimuth angle of normal to surface & south  
 90.0000 TILT: Tilt angle: flat roof=0, floor=180 (degree)  
 0.000000 GRF: Ground reflectivity (-)  
 0.000000 IROFS: Outer surface roughness index: 1=stucco,...  
 0.000000 ABSOS: Solar absorptance of outer surface (-)  
 0.650000 ABSIS: Short wave absorptance of inner surface(-)  
 0.900000 EMITIS: Emissivity of the inner surface (-)  
 0.000000 TRANSM: Transmittance of the glass window (-)  
 0.000000 SC: Shading coeff. of the glass window (-)

---

UNIT 21 TYPE 51  
BUILDING SURFACE

1 INPUTS:  
 TEMPERATURE 26 - TIA: Indoor air dry-bulb temperature  
 TEMPERATURE 23 - TMR: Mean radiant temperature  
 TEMPERATURE 10 - TOSINF: Outer surface temp. of unexposed wall  
 CONTROL 8 - FSHADW: Shaded fraction of exposed surface

2 OUTPUTS:  
 TEMPERATURE 10 - TIS: Inner surface temperature  
 POWER 0 - SOLINT: Integrated solar influx on surface

3 PARAMETERS:  
 2.00000 IZN: Identification number of zone  
 3.00000 ID: Identification number of surface  
 2.00000 IEXPOS: 0=W/in zone, 1=betw.zones, 2=exposed to sun  
 3.00000 ISTR: Identification number of the construct  
 24.4000 AS: Surface area (m2)  
 90.0000 ORIENT: Azimuth angle of normal to surface & south  
 90.0000 TILT: Tilt angle: flat roof=0, floor=180 (degree)  
 0.200000 GRF: Ground reflectivity (-)  
 5.00000 IROFS: Outer surface roughness index: 1=stucco,...  
 0.400000 ABSOS: Solar absorptance of outer surface (-)  
 0.650000 ABSIS: Short wave absorptance of inner surface(-)  
 0.900000 EMITIS: Emissivity of the inner surface (-)  
 0.000000 TRANSM: Transmittance of the glass window (-)  
 0.000000 SC: Shading coeff. of the glass window (-)

---

UNIT 22 TYPE 51  
BUILDING SURFACE

1 INPUTS:  
 TEMPERATURE 26 - TIA: Indoor air dry-bulb temperature  
 TEMPERATURE 23 - TMR: Mean radiant temperature  
 TEMPERATURE 21 - TOSINF: Outer surface temp. of unexposed wall  
 CONTROL 8 - FSHADW: Shaded fraction of exposed surface

2 OUTPUTS:  
 TEMPERATURE 9 - TIS: Inner surface temperature  
 POWER 0 - SOLINT: Integrated solar influx on surface

3 PARAMETERS:  
 2.00000 IZN: Identification number of zone  
 2.00000 ID: Identification number of surface  
 1.00000 IEXPOS: 0=W/in zone, 1=betw.zones, 2=exposed to sun  
 2.00000 ISTR: Identification number of the construct  
 37.2100 AS: Surface area (m2)  
 0.000000 ORIENT: Azimuth angle of normal to surface & south  
 180.000 TILT: Tilt angle: flat roof=0, floor=180 (degree)  
 0.000000 GRF: Ground reflectivity (-)  
 0.000000 IROFS: Outer surface roughness index: 1=stucco,...  
 0.000000 ABSOS: Solar absorptance of outer surface (-)  
 0.650000 ABSIS: Short wave absorptance of inner surface(-)  
 0.900000 EMITIS: Emissivity of the inner surface (-)  
 0.000000 TRANSM: Transmittance of the glass window (-)  
 0.000000 SC: Shading coeff. of the glass window (-)

---



UNIT 23      TYPE 51  
BUILDING SURFACE

1      INPUTS:  
         TEMPERATURE      26 - TIA:      Indoor air dry-bulb temperature  
         TEMPERATURE      23 - TMR:      Mean radiant temperature  
         TEMPERATURE      8 - TOSINF:   Outer surface temp. of unexposed wall  
         CONTROL            8 - FSHADW:   Shaded fraction of exposed surface

2      OUTPUTS:  
         TEMPERATURE      8 - TIS:      Inner surface temperature  
         POWER              0 - SOLINT:   Integrated solar influx on surface

3      PARAMETERS:  
         2.00000      IZN:      Identification number of zone  
         1.00000      ID:      Identification number of surface  
         2.00000      IEXPOS:   0=W/in zone, 1=betw.zones, 2=exposed to sun  
         1.00000      ISTR:      Identification number of the construct  
         37.2100      AS:      Surface area (m2)  
         0.000000      ORIENT:   Azimuth angle of normal to surface & south  
         0.000000      TILT:      Tilt angle: flat roof=0, floor=180 (degree)  
         0.200000      GRF:      Ground reflectivity (-)  
         1.00000      IROFS:   Outer surface roughness index: 1=stucco,...  
         0.600000      ABSOS:   Solar absorptance of outer surface (-)  
         0.650000      ABSIS:   Short wave absorptance of inner surface(-)  
         0.900000      EMITIS:   Emissivity of the inner surface (-)  
         0.000000      TRANSM:   Transmittance of the glass window (-)  
         0.000000      SC:      Shading coeff. of the glass window (-)

-----

UNIT 31      TYPE 53  
WEATHER INPUT

1      INPUTS:  
         TEMPERATURE      32 - TAMB:      Ambient (outdoor) air temperature (C)  
         ABS. HUMIDITY      7 - HUMRAT:   Outdoor air humidity ratio (-)  
         PRESSURE            11 - PBAR:      Barometric pressure (kPa)  
         POWER              11 - IDN:      Direct normal solar radiation (W/m2)  
         POWER              12 - ISKY:      Diffuse (sky) solar radiation (W/m2)  
         POWER              13 - IHOR:      Total horizontal solar radiation (W/m2)

2      OUTPUTS:

3      PARAMETERS:  
         32.0000      Index for ambient temperature (e.g. 5 if TAMB=T5)  
         7.00000      Index for outdoor air humidity ratio  
         11.0000      Index for barometric pressure  
         11.0000      Index for direct normal solar radiation  
         12.0000      Index for diffuse (sky) solar radiation  
         13.0000      Index for total horizontal solar radiation

-----

UNIT 24      TYPE 52  
ZONE MODEL

1      INPUTS:  
         PRESSURE            3 - PIAG:      Gage pressure of zone air  
         TEMPERATURE      27 - TIA:      Zone air dry-bulb temperature  
         ABS. HUMIDITY      3 - WIA:      Humidity ratio of zone air

PRESSURE	6 - PSAC:	Gage pressure of supply air
FLOW	3 - MSA:	Mass flow rate of supply air
TEMPERATURE	30 - TSA:	Supply air dry-bulb temperature
ABS. HUMIDITY	6 - WSA:	Humidity ratio of supply air
POWER	7 - QWALL:	Convective heat gain from surfaces
CONTROL	9 - NUMPEP:	Number of people (occupant in the zone)
CONTROL	10 - UTCEQP:	Equipment utilization coefficient
CONTROL	11 - UTCLIT:	Lighting utilization coefficient

2 OUTPUTS:

TEMPERATURE	27 - TIA:	Zone air dry-bulb temp. [diff. eq.]
ABS. HUMIDITY	3 - WIA:	Humidity ratio of zone air [diff. eq.]
POWER	8 - QISW:	Internal (short wave) radiant gain
POWER	9 - QILW:	Internal (long wave) radiant gain

3 PARAMETERS:

3.00000	IZN:	Identification number of zone
400.000	CFUR:	Effective capacitance of furnishings (kJ/K)
5.00000	EFFMIA:	Multiplier for zone moisture capacitance(-)
148.840	VOLUME:	Volume of zone air (interior space) (m3)
1.00000	SAIREX:	Standard air exchange rate (1/h)
0.717600E-01	WPEPS:	Sensible heat gain from a person (kW)
0.455000E-01	WPEPL:	Latent heat gain from a person (kW)
0.200000	WLIT:	Heat gain due to lighting in the zone (kW)
2.00000	LIGHT:	1 = Fluorescent, 2 = Incandescent (-)
0.150000	WEQPS:	Sensible heat gain due to equipment (kW)
0.200000E-01	WEQPL:	Latent heat gain due to equipment (kW)
0.300000	REQP:	Radiative to sensible heat from equipment(-)

UNIT 25 TYPE 52  
ZONE MODEL

1 INPUTS:

PRESSURE	1 - PIAC:	Gage pressure of zone air
TEMPERATURE	25 - TIA:	Zone air dry-bulb temperature
ABS. HUMIDITY	1 - WIA:	Humidity ratio of zone air
PRESSURE	4 - PSAC:	Gage pressure of supply air
FLOW	1 - MSA:	Mass flow rate of supply air
TEMPERATURE	28 - TSA:	Supply air dry-bulb temperature
ABS. HUMIDITY	4 - WSA:	Humidity ratio of supply air
POWER	1 - QWALL:	Convective heat gain from surfaces
CONTROL	1 - NUMPEP:	Number of people (occupant in the zone)
CONTROL	2 - UTCEQP:	Equipment utilization coefficient
CONTROL	3 - UTCLIT:	Lighting utilization coefficient

2 OUTPUTS:

TEMPERATURE	25 - TIA:	Zone air dry-bulb temp. [diff. eq.]
ABS. HUMIDITY	1 - WIA:	Humidity ratio of zone air [diff. eq.]
POWER	2 - QISW:	Internal (short wave) radiant gain
POWER	3 - QILW:	Internal (long wave) radiant gain

3 PARAMETERS:

1.00000	IZN:	Identification number of zone
400.000	CFUR:	Effective capacitance of furnishings (kJ/K)
5.00000	EFFMIA:	Multiplier for zone moisture capacitance(-)
148.840	VOLUME:	Volume of zone air (interior space) (m3)
1.00000	SAIREX:	Standard air exchange rate (1/h)
0.717600E-01	WPEPS:	Sensible heat gain from a person (kW)
0.454000E-01	WPEPL:	Latent heat gain from a person (kW)

0.200000 WLIT: Heat gain due to lighting in the zone (kW)  
 2.000000 LIGHT: 1 = Fluorescent, 2 = Incandescent (-)  
 0.150000 WEQPS: Sensible heat gain due to equipment (kW)  
 0.200000E-01 WEQPL: Latent heat gain due to equipment (kW)  
 0.300000 REQP: Radiative to sensible heat from equipment(-)

---

UNIT 26 TYPE 52  
 ZONE MODEL

1 INPUTS:  
 PRESSURE 2 - PIAG: Gage pressure of zone air  
 TEMPERATURE 26 - TIA: Zone air dry-bulb temperature  
 ABS. HUMIDITY 2 - WIA: Humidity ratio of zone air  
 PRESSURE 5 - PSAG: Gage pressure of supply air  
 FLOW 2 - MSA: Mass flow rate of supply air  
 TEMPERATURE 29 - TSA: Supply air dry-bulb temperature  
 ABS. HUMIDITY 5 - WSA: Humidity ratio of supply air  
 POWER 4 - QWALL: Convective heat gain from surfaces  
 CONTROL 5 - NUMPEP: Number of people (occupant in the zone)  
 CONTROL 6 - UTCEQP: Equipment utilization coefficient  
 CONTROL 7 - UTCLIT: Lighting utilization coefficient

2 OUTPUTS:  
 TEMPERATURE 26 - TIA: Zone air dry-bulb temp. [diff. eq.]  
 ABS. HUMIDITY 2 - WIA: Humidity ratio of zone air [diff. eq.]  
 POWER 5 - QISW: Internal (short wave) radiant gain  
 POWER 6 - QILW: Internal (long wave) radiant gain

3 PARAMETERS:  
 2.000000 IZN: Identification number of zone  
 400.000 CFUR: Effective capacitance of furnishings (kJ/K)  
 5.000000 EFFMIA: Multiplier for zone moisture capacitance(-)  
 148.840 VOLUME: Volume of zone air (interior space) (m3)  
 1.000000 SAIREX: Standard air exchange rate (1/h)  
 0.717600E-01 WPEPS: Sensible heat gain from a person (kW)  
 0.454000E-01 WPEPL: Latent heat gain from a person (kW)  
 0.200000 WLIT: Heat gain due to lighting in the zone (kW)  
 2.000000 LIGHT: 1 = Fluorescent, 2 = Incandescent (-)  
 0.150000 WEQPS: Sensible heat gain due to equipment (kW)  
 0.200000E-01 WEQPL: Latent heat gain due to equipment (kW)  
 0.300000 REQP: Radiative to sensible heat from equipment(-)

---

UNIT 27 TYPE 3  
 INLET CONDUIT (DUCT OR PIPE)

1 INPUTS:  
 PRESSURE 7 - INLET FLUID PRESSURE  
 PRESSURE 8 - OUTLET FLUID PRESSURE  
 TEMPERATURE 31 - INLET FLUID TEMPERATURE  
 TEMPERATURE 32 - AMBIENT AIR TEMPERATURE  
 TEMPERATURE 33 - OUTLET FLUID TEMPERATURE (SAME AS FIRST OUTPUT)

2 OUTPUTS:  
 TEMPERATURE 33 - OUTLET FLUID TEMPERATURE (SAME AS FIFTH INPUT)  
 FLOW 3 - FLUID MASS FLOW RATE

3 PARAMETERS:  
 0.000000 INSIDE HEAT TRANSFER COEFFICIENT X AREA (KW/C)

0.000000 OUTSIDE HEAT TRANSFER COEFFICIENT X AREA (KW/C)  
 0.000000 THERMAL CAPACITANCE OF CONDUIT MATERIAL (KJ/C)  
 0.000000 VOLUME (M3)  
 0.125000 FLOW RESISTANCE [0.001/(KG M)]  
 0.000000 HEIGHT OF OUTLET ABOVE INLET (M)  
 1.000000 MODE: 2=WATER, 1=AIR, NEG.=DETAILED, POS.=SIMPLE DYNAMI

---

UNIT 28 TYPE 1  
 FAN OR PUMP

1 INPUTS:  
 FLOW 3 - MASS FLOW RATE OF FLUID  
 PRESSURE 9 - OUTLET PRESSURE  
 RVPS 1 - FAN OR PUMP ROTATIONAL SPEED  
 TEMPERATURE 33 - INLET FLUID TEMPERATURE

2 OUTPUTS:  
 PRESSURE 8 - INLET PRESSURE  
 TEMPERATURE 30 - OUTLET FLUID TEMPERATURE  
 POWER 10 - POWER CONSUMPTION

3 PARAMETERS:  
 3.64000 1ST PRESSURE COEFFICIENT  
 0.801000 2ND PRESSURE COEFFICIENT  
 -0.190000 3RD PRESSURE COEFFICIENT  
 -0.444000E-02 4TH PRESSURE COEFFICIENT  
 0.000000 5TH PRESSURE COEFFICIENT  
 0.000000 1ST EFFICIENCY COEFFICIENT  
 0.564000 2ND EFFICIENCY COEFFICIENT  
 -0.862000E-01 3RD EFFICIENCY COEFFICIENT  
 0.000000 4TH EFFICIENCY COEFFICIENT  
 0.000000 5TH EFFICIENCY COEFFICIENT  
 0.336500 DIAMETER (M)  
 1.000000 MODE: AIR=1, WATER=2

---

UNIT 29 TYPE 2  
 CONDUIT (DUCT OR PIPE)

1 INPUTS:  
 FLOW 3 - FLUID MASS FLOW RATE  
 PRESSURE 6 - OUTLET PRESSURE  
 TEMPERATURE 30 - FLUID INLET TEMPERATURE  
 TEMPERATURE 32 - AMBIENT TEMPERATURE  
 TEMPERATURE 30 - OUTLET FLUID TEMPERATURE (SAME AS FIRST OUTPUT)

2 OUTPUTS:  
 TEMPERATURE 0 - OUTLET FLUID TEMPERATURE (SAME AS FIFTH INPUT)  
 PRESSURE 9 - INLET PRESSURE

3 PARAMETERS:  
 0.000000 INSIDE HEAT TRANSFER COEFFICIENT X AREA (KW/C)  
 0.000000 OUTSIDE HEAT TRANSFER COEFFICIENT X AREA (KW/C)  
 0.000000 THERMAL CAPACITANCE OF CONDUIT MATERIAL (KJ/C)  
 0.000000 VOLUME (M3)  
 0.125000 FLOW RESISTANCE [0.001/(KG M)]  
 0.000000 HEIGHT OF OUTLET ABOVE INLET (M)  
 1.000000 MODE: 2=WATER, 1=AIR, NEG.=DETAILED, POS.=SIMPLE DYNAMI

---

UNIT 30 TYPE 2  
 CONDUIT (DUCT OR PIPE)

1 INPUTS:  
 FLOW 3 - FLUID MASS FLOW RATE  
 PRESSURE 10 - OUTLET PRESSURE  
 TEMPERATURE 27 - FLUID INLET TEMPERATURE  
 TEMPERATURE 32 - AMBIENT TEMPERATURE  
 TEMPERATURE 27 - OUTLET FLUID TEMPERATURE (SAME AS FIRST OUTPUT)

2 OUTPUTS:  
 TEMPERATURE 0 - OUTLET FLUID TEMPERATURE (SAME AS FIFTH INPUT)  
 PRESSURE 3 - INLET PRESSURE

3 PARAMETERS:  
 0.000000 INSIDE HEAT TRANSFER COEFFICIENT X AREA (KW/C)  
 0.000000 OUTSIDE HEAT TRANSFER COEFFICIENT X AREA (KW/C)  
 0.000000 THERMAL CAPACITANCE OF CONDUIT MATERIAL (KJ/C)  
 0.000000 VOLUME (M3)  
 0.125000 FLOW RESISTANCE [0.001/(KG M)]  
 0.000000 HEIGHT OF OUTLET ABOVE INLET (M)  
 1.000000 MODE: 2=WATER, 1=AIR, NEG.=DETAILED, POS.=SIMPLE DYNAMI

-----  
 Initial Variable Values:

PRESSURE	1 -)	0.000000	(kPa)
PRESSURE	2 -)	0.000000	(kPa)
PRESSURE	3 -)	0.300000	(kPa)
PRESSURE	4 -)	0.000000	(kPa)
PRESSURE	5 -)	0.000000	(kPa)
PRESSURE	6 -)	0.500000	(kPa)
PRESSURE	7 -)	0.000000	(kPa)
PRESSURE	8 -)	-0.800000	(kPa)
PRESSURE	9 -)	1.000000	(kPa)
PRESSURE	10 -)	-0.500000	(kPa)
PRESSURE	11 -)	0.000000	(kPa)
FLOW	1 -)	0.000000	(kg/s)
FLOW	2 -)	0.000000	(kg/s)
FLOW	3 -)	2.49683	(kg/s)
TEMPERATURE	1 -)	20.0000	(C)
TEMPERATURE	2 -)	20.0000	(C)
TEMPERATURE	3 -)	20.0000	(C)
TEMPERATURE	4 -)	20.0000	(C)
TEMPERATURE	5 -)	20.0000	(C)
TEMPERATURE	6 -)	20.0000	(C)
TEMPERATURE	7 -)	20.0000	(C)
TEMPERATURE	8 -)	20.0000	(C)
TEMPERATURE	9 -)	20.0000	(C)
TEMPERATURE	10 -)	20.0000	(C)
TEMPERATURE	11 -)	20.0000	(C)
TEMPERATURE	12 -)	20.0000	(C)
TEMPERATURE	13 -)	20.0000	(C)
TEMPERATURE	14 -)	20.0000	(C)
TEMPERATURE	15 -)	20.0000	(C)
TEMPERATURE	16 -)	20.0000	(C)
TEMPERATURE	17 -)	20.0000	(C)
TEMPERATURE	18 -)	20.0000	(C)
TEMPERATURE	19 -)	20.0000	(C)
TEMPERATURE	20 -)	20.0000	(C)

TEMPERATURE	21 ->	15.0000	(C)
TEMPERATURE	22 ->	20.0000	(C)
TEMPERATURE	23 ->	20.0000	(C)
TEMPERATURE	24 ->	20.0000	(C)
TEMPERATURE	25 ->	20.0000	(C)
TEMPERATURE	26 ->	20.0000	(C)
TEMPERATURE	27 ->	20.0000	(C)
TEMPERATURE	28 ->	20.0000	(C)
TEMPERATURE	29 ->	20.0000	(C)
TEMPERATURE	30 ->	20.0000	(C)
TEMPERATURE	31 ->	20.0000	(C)
TEMPERATURE	32 ->	20.0000	(C)
TEMPERATURE	33 ->	20.0000	(C)
CONTROL	1 ->	1.00000	(-)
CONTROL	2 ->	1.00000	(-)
CONTROL	3 ->	1.00000	(-)
CONTROL	4 ->	0.000000	(-)
CONTROL	5 ->	1.00000	(-)
CONTROL	6 ->	1.00000	(-)
CONTROL	7 ->	1.00000	(-)
CONTROL	8 ->	0.000000	(-)
CONTROL	9 ->	1.00000	(-)
CONTROL	10 ->	1.00000	(-)
CONTROL	11 ->	1.00000	(-)
CONTROL	12 ->	0.000000	(-)
RVPS	1 ->	60.0000	(rev/s)
POWER	1 ->	0.000000	(kW)
POWER	2 ->	0.000000	(kW)
POWER	3 ->	0.000000	(kW)
POWER	4 ->	0.000000	(kW)
POWER	5 ->	0.000000	(kW)
POWER	6 ->	0.000000	(kW)
POWER	7 ->	0.000000	(kW)
POWER	8 ->	0.000000	(kW)
POWER	9 ->	0.000000	(kW)
POWER	10 ->	0.000000	(kW)
POWER	11 ->	0.000000	(kW)
POWER	12 ->	0.000000	(kW)
POWER	13 ->	0.000000	(kW)
ABS. HUMIDITY	1 ->	0.740000E-03	(kg(water)/kg(air))
ABS. HUMIDITY	2 ->	0.740000E-03	(kg(water)/kg(air))
ABS. HUMIDITY	3 ->	0.740000E-03	(kg(water)/kg(air))
ABS. HUMIDITY	4 ->	0.740000E-03	(kg(water)/kg(air))
ABS. HUMIDITY	5 ->	0.740000E-03	(kg(water)/kg(air))
ABS. HUMIDITY	6 ->	0.740000E-03	(kg(water)/kg(air))
ABS. HUMIDITY	7 ->	0.000000	(kg(water)/kg(air))

-----  
Simulation Error Tolerances:

1	RTOLX=	0.500000E-02	ATOLX=	0.100000E-05
	XTOL=	0.500000E-03	TTIME=	10.0000

SUPERBLOCK 1

2	FREEZE OPTION 0	SCAN OPTION 0
---	-----------------	---------------

SUPERBLOCK 2

3	FREEZE OPTION 0	SCAN OPTION 0
---	-----------------	---------------

-----  
The following are Boundary Variables in the simulation:

TEMPERATURE 31

-----  
The following are the reported variables:

SUPERBLOCK 1           REPORTING INTERVAL    3600.00

TEMPERATURE        1  
TEMPERATURE        2  
TEMPERATURE        3  
TEMPERATURE        4  
TEMPERATURE        5  
TEMPERATURE        6  
TEMPERATURE        7  
TEMPERATURE        8  
TEMPERATURE       14  
TEMPERATURE       32  
POWER               1  
POWER               4  
POWER               7  
POWER              11  
POWER              12  
POWER              13

SUPERBLOCK 2           REPORTING INTERVAL    3600.00

TEMPERATURE       25  
TEMPERATURE       26  
TEMPERATURE       27  
TEMPERATURE       30  
TEMPERATURE       31  
ABS. HUMIDITY      1  
ABS. HUMIDITY      2  
ABS. HUMIDITY      3

Selection ?

END  
STOP

(2) Creation of Model Definition File

-----  
\* Execution of SLIMCON  
-----

Simulation Work File to Model Definition File Converter

Version 2.1 (November 13, 1984)

Enter the simulation filename (Up to 8 characters) or carriage return to end.

THRIZONE

2	superblocks in the simulation	.....	MAXIMUM = 10 ( 20.0%)
8	blocks in the simulation	.....	MAXIMUM = 50 ( 16.0%)
6	differential equations in the simulation	.....	MAXIMUM = 50 ( 12.0%)
1173	saved variables in the simulation	.....	MAXIMUM = 6000 ( 19.6%)
31	units in the simulation	.....	MAXIMUM = 200 ( 15.5%)
8	units in a single block	.....	MAXIMUM = 20 ( 40.0%)
2	differential equations in one unit	.....	MAXIMUM = 10 ( 20.0%)
13	inputs or outputs in a single unit	.....	MAXIMUM = 20 ( 65.0%)
14	parameters in a single unit	.....	MAXIMUM = 30 ( 46.7%)
4	blocks in the largest superblock	.....	MAXIMUM = 10 ( 40.0%)
6	differential equations in one superblock	.....	MAXIMUM = 20 ( 30.0%)
80	state variables in the simulation	.....	MAXIMUM = 600 ( 13.3%)
14	inputs or outputs in a single block	.....	MAXIMUM = 50 ( 28.0%)
361	unit parameters in the simulation	.....	MAXIMUM = 1000 ( 36.1%)
8	simultaneous equations in a single block	.....	MAXIMUM = 30 ( 26.7%)
1	simultaneous equations in one superblock	.....	MAXIMUM = 20 ( 5.0%)
1	time dependent boundary variables	.....	MAXIMUM = 30 ( 3.3%)
1	boundary conditions in one superblock	.....	MAXIMUM = 20 ( 5.0%)
16	reported variables in one superblock	.....	MAXIMUM = 30 ( 53.3%)



(3) Creation of Boundary Variable File

-----  
\* File: BOUNDARY.DAT  
-----

0	20.0
31800	20.0
32000	20.0
32200	20.0
32400	20.0
32400	15.0
32600	15.0
32800	15.0
33000	15.0
60600	15.0
60800	15.0
61000	15.0
61200	15.0
61200	20.0
61400	20.0
61600	20.0
61800	20.0
118200	20.0
118400	20.0
118600	20.0
118800	20.0
118800	15.0
119000	15.0
119200	15.0
119400	15.0
147000	15.0
147200	15.0
147400	15.0
147600	15.0
147600	20.0
147800	20.0
148000	20.0
148200	20.0
204600	20.0
204800	20.0
205000	20.0
205200	20.0
205200	15.0
205400	15.0
205600	15.0
205800	15.0
233400	15.0
233600	15.0
233800	15.0
234000	15.0
234000	20.0
234200	20.0
234400	20.0
234600	20.0

(4) Creation of Conduction Transfer Function File

-----  
\* Composition of constructs  
-----

CONSTRUCT #1 (Ceiling)

(Outside)

Layer 1	Slag, 1/2-in.	(44): [material I.D. # in THERM.DAT file]
2	Felt, 3/8-in.	(45)
3	Concrete, 4-in.	(36)
4	Insulation, 4-in.	(20)
5	Ceiling air space	(46)
6	Acoustic tile	(47)

(Inside)

CONSTRUCT #2 (Floor)

(Outside)

Layer 1	Concrete, l.w., 4-in.	(36)
2	Vinyle tile, 3.32-in.	(48)

(Inside)

CONSTRUCT #3 (Interior Walls)

Same as Example 1

CONSTRUCT #4 (Exposed Wall)

Same as Example 1

CONSTRUCT #5 (Exposed Glass Window)

Same as Example 1

-----  
 \* Execution of CTFGEN  
 -----

Enter your choice:

- \*\*\*\*\*  
 A => Add thermal property data to the construction materials database (THERM.DAT)  
 B => Print the contents of the data file THERM.DAT to Logical Unit 6  
 C => Create a CTF data file  
 D => Change time interval in an existing CTF data file  
 E => END

C  
 Enter the name of the CTF Definition File,  
 or carriage return for default name: CTFINPUT.DAT

Enter the name of the CTF Output File,  
 or carriage return for default name: CTFDATA.DAT

What kind of output do you want?  
 0 ==> for a very simple output,  
 1 ==> for a less simple output,  
 2 ==> for detailed output or  
 3 ==> for root search

1  
 What is the time interval for CTF calculation in s ?  
 900

THIS CONSTRUCT ID NUMBER (ISTR) IS 1  
 How many layers in this construct? (max. = 10 )

6  
 Enter the layer ID numbers with most outer layer first  
 44,45,36,20,46,47

LAYER	L	K	CP	D	R	RC
Slag or st	0.013	1.436	0.465	881.000	0.009	6.783
Felt & mem	0.010	0.190	0.465	1121.000	0.050	15.735
Concrete,	0.102	0.173	0.233	640.000	0.586	94.328
Insulation	0.102	0.043	0.233	91.000	2.346	71.344
Ceiling ai	0.000	0.000	0.000	0.000	0.176	0.000
Acoustic t	0.016	0.061	0.233	480.000	0.315	21.529

SUMRC = 209.71966 CND = 0.29023 TINC = 900.00

NUMBER OF RESPONSE FACTORS = 6; ORDER = 3

N	O 0	O 1	O 2	O 3	O 4	O 5
0	14.557249	14.557249	14.557249	14.557249	14.557249	14.557249
1	-11.701724	-23.404494	-28.110588	-30.256600	-30.524282	-30.636338
2	-0.807326	8.599849	16.166097	20.310126	20.866491	21.101454
3	-0.404115	0.244905	-2.535270	-4.918456	-5.291923	-5.452545
4	-0.279811	0.045063	-0.034110	0.339636	0.430078	0.470813
5	-0.214535	0.010408	-0.004160	0.000869	-0.005377	-0.008687
6	-0.169705	0.002763	-0.000602	0.000012	0.000000	0.000000

0	0.000001	0.000001	0.000001	0.000001	0.000001	0.000001
1	0.001435	0.001434	0.001433	0.001433	0.001433	0.001433
2	0.015018	0.013864	0.013401	0.013190	0.013163	0.013152
3	0.033322	0.021249	0.016767	0.014791	0.014549	0.014447
4	0.039358	0.012570	0.005701	0.003229	0.002957	0.002845
5	0.036730	0.005089	0.001025	0.000185	0.000126	0.000103
6	0.031329	0.001801	0.000156	0.000005	0.000000	0.000000

0	2.456216	2.456216	2.456216	2.456216	2.456216	2.456216
1	-1.908972	-3.883557	-4.677607	-5.039699	-5.084865	-5.103772
2	-0.143329	1.391319	2.646803	3.336370	3.429041	3.468182
3	-0.047651	0.067573	-0.382215	-0.772404	-0.833754	-0.860149
4	-0.020781	0.017526	-0.004319	0.052027	0.066230	0.072648
5	-0.011357	0.005349	-0.000317	0.000320	-0.000637	-0.001147
6	-0.007443	0.001688	-0.000042	0.000005	0.000000	0.000000

3 1.274614 -0.426060 0.038313 0.000000 0.000000

ISTR: 1

NCTF: 6 NORD: 3

UVAL: 0.290227

CTFX: 14.5573, -30.2568, 20.3102, -4.91848, 0.339638, 8.68591E-04, 1.171E-05

CTFY: 1.18807E-06, 1.43323E-03, 1.31896E-02, 1.47913E-02, 3.22913E-03, 1.8491E-04, 5.0123E-06

CTFZ: 2.45622, -5.03971, 3.33638, -0.772406, 5.2027E-02, 3.19892E-04, 4.97476E-06

CTFQ: 1.27461, -0.42606, 3.83128E-02

Do you want to continue? <N>

Y

THIS CONSTRUCT ID NUMBER (ISTR) IS 2

How many layers in this construct? (max. = 10 )

2

Enter the layer ID numbers with most outer layer first

36,48

LAYER	L	K	CP	D	R	RC
Concrete,	0.102	0.173	0.233	640.000	0.586	94.328
Vinyle til	0.002	0.270	1.004	1552.000	0.000	4.805

SUMRC = 99.13220 CND = 1.68155 TINC = 900.00

NUMBER OF RESPONSE FACTORS = 3; ORDER = 2

N	0 0	0 1	0 2	0 3	0 4	0 5
0	6.041242	6.041242	6.041242	6.041242	6.041242	6.041242
1	-3.530460	-5.812812	-5.936175	-5.937136	-5.937137	-5.937137
2	-0.522149	0.811642	0.930340	0.931285	0.931286	0.931286
3	-0.191197	0.006068	-0.010506	0.000000	0.000000	0.000000
0	0.122326	0.122326	0.122326	0.122326	0.122326	0.122326
1	0.755747	0.709533	0.707035	0.707016	0.707016	0.707016
2	0.493480	0.207962	0.193473	0.193361	0.193360	0.193360
3	0.192747	0.006313	0.002066	0.000000	0.000000	0.000000
0	9.218291	9.218291	9.218291	9.218291	9.218291	9.218291
1	-6.686454	-10.169080	-10.357318	-10.358785	-10.358787	-10.358787
2	-0.535869	1.990241	2.197894	2.199543	2.199544	2.199544
3	-0.195773	0.006676	-0.033965	0.000000	0.000000	0.000000

2 0.398215 -0.007715 0.000000 0.000000 0.000000

ISTR: 2

NCTF: 3 NORD: 2

UVAL: 1.68155

CTFX: 6.04124, -5.93617, 0.93034, -1.05061E-02

CTFY: 0.122326, 0.707036, 0.193473, 2.06644E-03

CTFZ: 9.21829, -10.3573, 2.19789, -3.39653E-02

CTFQ: 0.398215, -7.71461E-03

Do you want to continue? <N>

Y

THIS CONSTRUCT ID NUMBER (ISTR) IS 3

How many layers in this construct? (max. = 10 )

3

Enter the layer ID numbers with most outer layer first

43,8,43

LAYER	L	K	CP	D	R	RC
Plaster/gypsum	0.019	0.727	0.233	1601.000	0.026	13.610
Air Space	0.000	0.000	0.000	0.000	0.160	0.000
Plaster/gypsum	0.019	0.727	0.233	1601.000	0.026	13.610

SUMRC = 27.22012 CND = 4.71099 TINC = 900.00

NUMBER OF RESPONSE FACTORS = 1; ORDER = 1

N	O 0	O 1	O 2	O 3	O 4	O 5
0	11.696103	11.696103	11.696103	0.000000	0.000000	0.000000
1	-6.985093	-6.985166	0.000000	0.000000	0.000000	0.000000
0	3.820999	3.820999	3.820999	0.000000	0.000000	0.000000
1	0.889971	0.889947	0.000000	0.000000	0.000000	0.000000
0	11.696103	11.696103	11.696103	0.000000	0.000000	0.000000
1	-6.985093	-6.985166	0.000000	0.000000	0.000000	0.000000
1	0.000006	0.000000	0.000000	0.000000	0.000000	0.000000

ISTR: 3

NCTF: 1 NORD: 1

UVAL: 4.71099

CTFX: 11.6962, -6.9852

CTFY: 3.82101, 0.88995

CTFZ: 11.6962, -6.9852

CTFQ: 6.21576E-06

Do you want to continue? <N>

Y

THIS CONSTRUCT ID NUMBER (ISTR) IS 4

How many layers in this construct? (max. = 10 )

4

Enter the layer ID numbers with most outer layer first

2,10,8,43

LAYER	L	K	CP	D	R	RC
Facebrick	0.102	1.298	0.256	2082.000	0.078	65.105
Insulation	0.051	0.043	0.233	32.000	1.176	21.154
Air Space	0.000	0.000	0.000	0.000	0.160	0.000
Plaster/gypsum	0.019	0.727	0.233	1601.000	0.026	13.610

SUMRC = 99.86891 CND = 0.69166 TINC = 900.00

NUMBER OF RESPONSE FACTORS = 3; ORDER = 2

N	0 0	0 1	0 2	0 3	0 4	0 5
0	31.239817	31.239817	31.239817	31.239817	31.239817	31.239817
1	-19.358236	-37.473015	-37.755497	-37.755942	-37.756010	-37.756012
2	-4.728849	6.496254	6.835099	6.835637	6.835720	6.835722
3	-2.714793	0.027286	-0.031456	0.000000	0.000000	0.000000
0	0.030345	0.030345	0.030345	0.030345	0.030345	0.030345
1	0.216958	0.199362	0.199088	0.199087	0.199087	0.199087
2	0.185634	0.059828	0.058025	0.058023	0.058022	0.058022
3	0.108688	0.001046	0.000505	0.000000	0.000000	0.000000
0	8.554926	8.554926	8.554926	8.554926	8.554926	8.554926
1	-7.845255	-12.805930	-12.883287	-12.883409	-12.883428	-12.883428
2	-0.007653	4.541511	4.657307	4.657491	4.657519	4.657520
3	-0.004354	0.000083	-0.040983	0.000000	0.000000	0.000000
2	0.588904	-0.005243	0.000000	0.000000	0.000000	0.000000

ISTR: 4

NCTF: 3 NORD: 2

UVAL: 0.691656

CTFX: 31.2398, -37.7555, 6.8351, -3.14559E-02

CTFY: 3.03452E-02, 0.199088, 5.80254E-02, 5.05029E-04

CTFZ: 8.55491, -12.8833, 4.6573, -4.09825E-02

CTFQ: 0.588904, -5.24332E-03

Do you want to continue? (N)

Y

THIS CONSTRUCT ID NUMBER (ISTR) IS 5

How many layers in this construct? (max. = 10 )

3

Enter the layer ID numbers with most outer layer first

49,8,49

LAYER	L	K	CP	D	R	RC
Glass	0.000	0.000	0.000	0.000	0.260	0.000
Air Space	0.000	0.000	0.000	0.000	0.160	0.000
Glass	0.000	0.000	0.000	0.000	0.260	0.000

SUMRC = 0.00000 CND = 1.47059 TINC = 900.00

LAYER	L	K	CP	D	R	RC
Glass	0.000	0.000	0.000	0.000	0.260	0.000
Air Space	0.000	0.000	0.000	0.000	0.160	0.000
Glass	0.000	0.000	0.000	0.000	0.260	0.000

SUMRC = 0.00000 CND = 1.47059 TINC = 900.00

NUMBER OF ROOTS = 7; SEARCH INCREMENT = 0.020026

N	ROOT
1	0.024607256
2	0.072309779
3	0.111355003
4	0.120292539
5	0.136468904
6	0.169175402
7	0.216991657

NUMBER OF RESPONSE FACTORS = 3; ORDER = 2

N	O 0	O 1	O 2	O 3	O 4	O 5
0	31.239817	31.239817	31.239817	31.239817	31.239817	31.239817
1	-19.358236	-37.473015	-37.755497	-37.755942	-37.756010	-37.756012
2	-4.728849	6.496254	6.835099	6.835637	6.835720	6.835722
3	-2.714793	0.027286	-0.031456	0.000000	0.000000	0.000000
0	0.030345	0.030345	0.030345	0.030345	0.030345	0.030345
1	0.216958	0.199362	0.199088	0.199087	0.199087	0.199087
2	0.185634	0.059828	0.058025	0.058023	0.058022	0.058022
3	0.108688	0.001046	0.000505	0.000000	0.000000	0.000000
0	8.554926	8.554926	8.554926	8.554926	8.554926	8.554926
1	-7.845255	-12.805930	-12.883287	-12.883409	-12.883428	-12.883428
2	-0.007653	4.541511	4.657307	4.657491	4.657519	4.657520
3	-0.004354	0.000083	-0.040983	0.000000	0.000000	0.000000
2	0.588904	-0.005243	0.000000	0.000000	0.000000	0.000000

\*\* SEVERE RESPONSE FACTORS NOT COMPUTED (RESPNS)

ISTR: 5

NCTF: 0 NORD: 0

UVAL: 1.47059

CTFX: 1.47059

CTFY: 1.47059

CTFZ: 1.47059

CTFQ:

Do you want to continue? <N>

N  
STOP ----- END OF CTF RUN -----

\* File: CTFDATA.DAT (Conduction Transfer Function File)

```

900.000
1 6 3 0.290227
14.5573 -30.2568 20.3102 -4.91848 0.339638
0.868591E-03 0.117100E-04
0.118807E-05 0.143323E-02 0.131896E-01 0.147913E-01 0.322913E-02
0.184910E-03 0.501230E-05
2.45622 -5.03971 3.33638 -0.772406 0.520270E-01
0.319892E-03 0.497476E-05
1.27461 -0.426060 0.383128E-01
2 3 2 1.68155
6.04124 -5.93617 0.930340 -0.105061E-01
0.122326 0.707036 0.193473 0.206644E-02
9.21829 -10.3573 2.19789 -0.339653E-01
0.398215 -0.771461E-02
3 1 1 4.71099
11.6962 -6.98520
3.82101 0.889950
11.6962 -6.98520
0.621576E-05
4 3 2 0.691656
31.2398 -37.7555 6.83510 -0.314559E-01
0.303452E-01 0.199088 0.580254E-01 0.505029E-03
8.55491 -12.8833 4.65730 -0.409825E-01
0.588904 -0.524332E-02
5 0 1 1.47059

```

1.47059  
1.47059  
1.47059  
0.000000

-----  
\* File: CTFINPUT.DAT (CTF Input Data File)  
-----

900.000  
6 44 45 36 20 46 47  
2 36 48  
3 43 8 43  
4 2 10 8 43  
3 49 8 49





93734073070068160006298800707201600077707000777070007779999	19610707229
93734072070069180005298700706201101302907000777070007779999	19610707239
93734071070069180005298600603201103302606000777060007779999	19610708009
93734070069068230004298500802201101302603089888080007779999	19610708019
93734069068067230005298400501302605988805000777050007779999	19610708029
93734068067066230004298310301302602888803000777030007779999	19610708039
93734067066066250004298310404200400077704000777040007779999	19610708049
93734067066065340004298410400200404716004000777040007770000	19610708050
93734066065065340005298511008200504716010000777100007770035	19610708060
93734068067066340005298610402200802716004000777040007770168	19610708070
93734071068067320005298720601200805301806000777060007770347	19610708080
93734073070068020006298720303201800077703000777030007770502	19610708090
93734076071068020005298720303401900077703000777030007770632	19610708100
93734078071068000000298600302403001716003008888030007770732	19610708110
93734081069062340008298600202405500077702000777020007770784	19610708120
93734081064053320011298600202405500077702000777020007770781	19610708130
93734081065055340010298500200405002716002000777020007770705	19610708140
93734080067059340010298500501404502716003028888050007770591	19610708150
93734079065056340011298500707888800077707000777070007770326	19610708160
93734078064055360011298600702716005988807000777070007770391	19610708170
93734078064055320012298600702716005988807000777070007770247	19610708180
93734074063055320012298900707988800077707000777070007770073	19610708190
93734070060052320012298900701715007988807000777070007770000	19610708200
93734068059052320007299200808988800077708000777080007779999	19610708219
93734067058052320008299300404888800077704000777040007779999	19610708229
93734066059053320009299300303888800077703000777030007779999	19610708239
93734065058053320007299300301708002888803000777030007779999	19610709009
93734064058053320005299300201708001888802000777020007779999	19610709019
93734063057053340006299200000888800077700000777000007779999	19610709029
93734059056054360008299200000077700077700000777000007779999	19610709039
93734059056054360007299300000077700077700000777000007779999	19610709049
93734059056054340006299400000077700077700000777000007770000	19610709050
93734061058055340006299600000077700077700000777000007770060	19610709060
93734066060056360009299700000077700077700000777000007770209	19610709070
93734067061057340008299800000708000077700000777000007770369	19610709080
93734070062057340008299800000077700077700000777000007770518	19610709090
93734072063058360007299900101403300077701000777010007770665	19610709100
93734075065059360006299900303403800077703000777030007770765	19610709110
93734077065058360008299800606405000077706000777060007770822	19610709120
937340770650573600122997008080404800077708000777080007770833	19610709130
93734078065056290009299700606405500077706000777060007770662	19610709140
93734080066057320009299500707405000077707000777070007770556	19610709150
93734077064056020009299500707405000077707000777070007770450	19610709160
93734078064055360009299500503405002708005000777050007770149	19610709170
93734077061050340008299600402405002708004000777040007770190	19610709180
93734075062053340008299700602405004708006000777060007770062	19610709190
93734071060052020007299900808710000077708000777080007770000	19610709200
93734069059052360004300100600504006710006000777060007779999	19610709219
93734070061054320012300200303711000077703000777030007779999	19610709229
93734066058051340010300200303711000077703000777030007779999	19610709239

-----  
\* File: WTPOUT.DAT  
-----

STTN	YR	MO	DAY	HR	DB (C)	DP (C)	P (kPa)	WS (m/s)	CC	IZER (W/m)
93734	1961	7	7	1	21.67	18.3	101.7	2.1	10	-1000.0
93734	1961	7	7	2	20.56	17.8	101.6	2.1	10	-1000.0
93734	1961	7	7	3	20.56	19.4	101.7	3.1	10	-1000.0
93734	1961	7	7	4	20.56	19.4	101.7	0.0	10	-1000.0

93734	1961	7	7	5	20.00	18.9	101.7	3.1	10	-1000.0
93734	1961	7	7	6	20.00	18.9	101.8	2.6	10	-1000.0
93734	1961	7	7	7	19.44	18.9	101.7	2.6	10	-1000.0
93734	1961	7	7	8	20.56	19.4	101.7	2.6	10	-1000.0
93734	1961	7	7	9	20.56	19.4	101.8	0.0	10	-1000.0
93734	1961	7	7	10	20.56	20.0	101.8	5.7	10	-1000.0
93734	1961	7	7	11	21.11	20.0	101.7	5.7	10	-1000.0
93734	1961	7	7	12	21.67	20.0	101.7	3.1	10	-1000.0
93734	1961	7	7	13	22.78	20.0	101.8	4.1	10	-1000.0
93734	1961	7	7	14	23.89	20.0	101.8	3.6	8	-1000.0
93734	1961	7	7	15	23.33	20.0	101.7	4.6	9	-1000.0
93734	1961	7	7	16	23.89	18.9	101.7	3.6	9	-1000.0
93734	1961	7	7	17	23.89	18.9	101.7	3.6	8	-1000.0
93734	1961	7	7	18	23.33	19.4	101.7	4.6	8	-1000.0
93734	1961	7	7	19	22.78	19.4	101.6	4.1	5	-1000.0
93734	1961	7	7	20	21.67	18.3	101.6	2.6	3	-1000.0
93734	1961	7	7	21	21.11	18.9	101.7	2.6	4	-1000.0
93734	1961	7	7	22	20.56	18.9	101.7	2.1	4	-1000.0
93734	1961	7	7	23	20.56	18.9	101.8	2.6	10	-1000.0
93734	1961	7	7	0	20.00	18.3	101.7	2.6	2	-1000.0
93734	1961	7	8	1	20.00	18.3	101.6	1.5	0	-1000.0
93734	1961	7	8	2	19.44	18.3	101.6	0.0	0	-1000.0
93734	1961	7	8	3	19.44	18.3	101.5	0.0	8	-1000.0
93734	1961	7	8	4	19.44	18.3	101.5	0.0	4	-1000.0
93734	1961	7	8	5	19.44	18.3	101.5	2.1	10	-1000.0
93734	1961	7	8	6	19.44	18.3	101.5	2.1	8	-1000.0
93734	1961	7	8	7	20.56	19.4	101.6	2.1	10	-1000.0
93734	1961	7	8	8	22.22	19.4	101.6	0.0	9	-1000.0
93734	1961	7	8	9	23.33	18.9	101.6	2.1	9	-1000.0
93734	1961	7	8	10	22.78	19.4	101.6	3.1	10	-1000.0
93734	1961	7	8	11	24.44	20.0	101.5	2.6	10	-1000.0
93734	1961	7	8	12	24.44	19.4	101.5	2.6	10	-1000.0
93734	1961	7	8	13	25.56	19.4	101.4	3.1	7	-1000.0
93734	1961	7	8	14	26.67	20.0	101.4	4.1	5	-1000.0
93734	1961	7	8	15	27.22	20.6	101.3	3.1	6	-1000.0
93734	1961	7	8	16	26.67	19.4	101.3	3.6	8	-1000.0
93734	1961	7	8	17	26.67	19.4	101.2	3.1	8	-1000.0
93734	1961	7	8	18	26.11	19.4	101.2	4.1	9	-1000.0
93734	1961	7	8	19	25.00	19.4	101.2	3.1	9	-1000.0
93734	1961	7	8	20	23.33	20.0	101.2	3.1	7	-1000.0
93734	1961	7	8	21	22.78	20.0	101.2	3.1	8	-1000.0
93734	1961	7	8	22	22.78	20.0	101.2	3.1	7	-1000.0
93734	1961	7	8	23	22.22	20.6	101.2	2.6	7	-1000.0
93734	1961	7	8	0	21.67	20.6	101.1	2.6	6	-1000.0
93734	1961	7	9	1	21.11	20.0	101.1	2.1	8	-1000.0
93734	1961	7	9	2	20.56	19.4	101.0	2.6	5	-1000.0
93734	1961	7	9	3	20.00	18.9	101.0	2.1	3	-1000.0
93734	1961	7	9	4	19.44	18.9	101.0	2.1	4	-1000.0
93734	1961	7	9	5	19.44	18.3	101.0	2.1	4	-1000.0
93734	1961	7	9	6	18.89	18.3	101.1	2.6	10	-1000.0
93734	1961	7	9	7	20.00	18.9	101.1	2.6	4	-1000.0
93734	1961	7	9	8	21.67	19.4	101.2	2.6	6	-1000.0
93734	1961	7	9	9	22.78	20.0	101.2	3.1	3	-1000.0
93734	1961	7	9	10	24.44	20.0	101.2	2.6	3	-1000.0
93734	1961	7	9	11	25.56	20.0	101.1	0.0	3	-1000.0
93734	1961	7	9	12	27.22	16.7	101.1	4.1	2	-1000.0
93734	1961	7	9	13	27.22	11.7	101.1	5.7	2	-1000.0
93734	1961	7	9	14	27.22	12.8	101.1	5.1	2	-1000.0
93734	1961	7	9	15	26.67	15.0	101.1	5.1	5	-1000.0
93734	1961	7	9	16	26.11	13.3	101.1	5.7	7	-1000.0

93734	1961	7	9	17	25.56	12.8	101.1	5.7	7	-1000.0
93734	1961	7	9	18	25.56	12.8	101.1	6.2	7	-1000.0
93734	1961	7	9	19	23.33	12.8	101.2	6.2	7	-1000.0
93734	1961	7	9	20	21.11	11.1	101.2	6.2	7	-1000.0
93734	1961	7	9	21	20.00	11.1	101.3	3.6	8	-1000.0
93734	1961	7	9	22	19.44	11.1	101.4	4.1	4	-1000.0
93734	1961	7	9	23	18.89	11.7	101.4	4.6	3	-1000.0
93734	1961	7	9	0	18.33	11.7	101.4	3.6	3	-1000.0

NOTE: Data in the columns greater than 80 are truncated.

-----  
 \* Execution of CRWDTA  
 -----

```

*****
*
*          CREATING A WEATHER DATA FILE          *
*
*****
  
```

Enter LATITUDE, LONGITUDE, and TIME ZONE:

38.85

77.03

5

Enter one of the following:

- 1 - to process the weather data in file WTPOUT.DAT  
(previously read from weather tape by program RDTAPE)
- 2 - to generate clear sky design data
- 3 - to generate cloudy sky design data

1

Enter output file name (up to 12 characters)  
 or carriage return for default name: WEATHER.DAT

STOP ---- END OF CREATING WEATHER FILE -----

-----  
 File: WEATHER.DAT  
 -----

7	7	38.85	77.03	5.00	1					
7	7	0.0	20.0000	-0.6220	101.7000	2.6000	0.0000	0.0000		
7	7	1.0	21.6700	-0.6220	101.7000	2.1000	0.0000	0.0000		
7	7	2.0	20.5600	-0.6220	101.6000	2.1000	0.0000	0.0000		
7	7	3.0	20.5600	-0.6220	101.7000	3.1000	0.0000	0.0000		
7	7	4.0	20.5600	-0.6220	101.7000	0.0000	0.0000	0.0000		
7	7	5.0	20.0000	-0.6220	101.7000	3.1000	0.0000	0.0000		
7	7	6.0	20.0000	-0.6220	101.8000	2.6000	0.1969	5.7888		
7	7	7.0	19.4400	-0.6220	101.7000	2.6000	0.7688	31.1430	3	
7	7	8.0	20.5600	-0.6220	101.7000	2.6000	0.1449	22.0106	2	
7	7	9.0	20.5600	-0.6220	101.8000	0.0000	0.1269	27.8079	2	
7	7	10.0	20.5600	-0.6220	101.8000	5.7000	0.4839	65.8495	6	
7	7	11.0	21.1100	-0.6220	101.7000	5.7000	2.3168	161.7803	16	
7	7	12.0	21.6700	-0.6220	101.7000	3.1000	22.0643	360.2322	38	
7	7	13.0	22.7800	-0.6220	101.8000	4.1000	107.1346	429.5686	53	
7	7	14.0	23.8900	-0.6220	101.8000	3.6000	147.1323	413.1729	54	
7	7	15.0	23.3300	-0.6220	101.7000	4.6000	378.0356	315.3931	63	
7	7	16.0	23.8900	-0.6220	101.7000	3.6000	769.6187	138.2964	68	
7	7	17.0	23.8900	-0.6220	101.7000	3.6000	181.6750	245.9064	34	
7	7	18.0	23.3300	-0.6220	101.7000	4.6000	115.4136	168.2981	21	

7	7	19.0	22.7800	-0.6220	101.6000	4.1000	6.6053	55.7066	5
7	7	20.0	21.6700	-0.6220	101.6000	2.6000	0.0000	0.0000	
7	7	21.0	21.1100	-0.6220	101.7000	2.6000	0.0000	0.0000	
7	7	22.0	20.5600	-0.6220	101.7000	2.1000	0.0000	0.0000	
7	7	23.0	20.5600	-0.6220	101.8000	2.6000	0.0000	0.0000	
7	7	24.0	20.0000	-0.6220	101.7000	2.6000	0.0000	0.0000	
7	8	1.0	20.0000	-0.6220	101.6000	1.5000	0.0000	0.0000	
7	8	2.0	19.4400	-0.6220	101.6000	0.0000	0.0000	0.0000	
7	8	3.0	19.4400	-0.6220	101.5000	0.0000	0.0000	0.0000	
7	8	4.0	19.4400	-0.6220	101.5000	0.0000	0.0000	0.0000	
7	8	5.0	19.4400	-0.6220	101.5000	2.1000	0.0000	0.0000	
7	8	6.0	19.4400	-0.6220	101.5000	2.1000	0.5209	9.2447	
7	8	7.0	20.5600	-0.6220	101.6000	2.1000	4.9306	77.5720	7
7	8	8.0	22.2200	-0.6220	101.6000	0.0000	28.4925	188.5826	20
7	8	9.0	23.3300	-0.6220	101.6000	2.1000	197.4422	285.1067	41
7	8	10.0	22.7800	-0.6220	101.6000	3.1000	191.8022	347.8713	49
7	8	11.0	24.4400	-0.6220	101.5000	2.6000	262.0825	376.1016	60
7	8	12.0	24.4400	-0.6220	101.5000	2.6000	237.6303	408.2700	63
7	8	13.0	25.5600	-0.6220	101.4000	3.1000	741.7134	197.3627	90
7	8	14.0	26.6700	-0.6220	101.4000	4.1000	15.9343	331.6353	34
7	8	15.0	27.2200	-0.6220	101.3000	3.1000	300.4958	341.8843	59
7	8	16.0	26.6700	-0.6220	101.3000	3.6000	394.5117	262.8533	54
7	8	17.0	26.6700	-0.6220	101.2000	3.1000	415.3787	199.4689	42
7	8	18.0	26.1100	-0.6220	101.2000	4.1000	211.0219	164.0207	24
7	8	19.0	25.0000	-0.6220	101.2000	3.1000	4.9064	49.0572	4
7	8	20.0	23.3300	-0.6220	101.2000	3.1000	0.0000	0.0000	
7	8	21.0	22.7800	-0.6220	101.2000	3.1000	0.0000	0.0000	
7	8	22.0	22.7800	-0.6220	101.2000	3.1000	0.0000	0.0000	
7	8	23.0	22.2200	-0.6220	101.2000	2.6000	0.0000	0.0000	
7	8	24.0	21.6700	-0.6220	101.1000	2.6000	0.0000	0.0000	
7	9	1.0	21.1100	-0.6220	101.1000	2.1000	0.0000	0.0000	
7	9	2.0	20.5600	-0.6220	101.0000	2.6000	0.0000	0.0000	
7	9	3.0	20.0000	-0.6220	101.0000	2.1000	0.0000	0.0000	
7	9	4.0	19.4400	-0.6220	101.0000	2.1000	0.0000	0.0000	
7	9	5.0	19.4400	-0.6220	101.0000	2.1000	0.0000	0.0000	
7	9	6.0	18.8900	-0.6220	101.1000	2.6000	18.3946	38.7504	4
7	9	7.0	20.0000	-0.6220	101.1000	2.6000	235.8925	126.3230	19
7	9	8.0	21.6700	-0.6220	101.2000	2.6000	549.5164	141.5620	40
7	9	9.0	22.7800	-0.6220	101.2000	3.1000	664.4600	155.3863	58
7	9	10.0	24.4400	-0.6220	101.2000	2.6000	721.2656	168.6929	73
7	9	11.0	25.5600	-0.6220	101.1000	0.0000	759.7915	176.3566	85
7	9	12.0	27.2200	-0.6220	101.1000	4.1000	766.8362	185.3893	91
7	9	13.0	27.2200	-0.6220	101.1000	5.7000	742.5952	196.9268	90
7	9	14.0	27.2200	-0.6220	101.1000	5.1000	638.1118	233.0332	81
7	9	15.0	26.6700	-0.6220	101.1000	5.1000	504.5327	265.9695	68
7	9	16.0	26.1100	-0.6220	101.1000	5.7000	89.4878	315.3828	37
7	9	17.0	25.5600	-0.6220	101.1000	5.7000	504.6819	175.9864	45
7	9	18.0	25.5600	-0.6220	101.1000	6.2000	401.5051	137.2548	28
7	9	19.0	23.3300	-0.6220	101.2000	6.2000	41.8718	77.0723	8
7	9	20.0	21.1100	-0.6220	101.2000	6.2000	0.0000	0.0000	
7	9	21.0	20.0000	-0.6220	101.3000	3.6000	0.0000	0.0000	
7	9	22.0	19.4400	-0.6220	101.4000	4.1000	0.0000	0.0000	
7	9	23.0	18.8900	-0.6220	101.4000	4.6000	0.0000	0.0000	
7	9	24.0	18.3300	-0.6220	101.4000	3.6000	0.0000	0.0000	

NOTE: Data in the columns greater than 80 are truncated.

B. Simulation

(1) Allocation of Output Files

Default names of the output files are MODSUM.DAT, MODOUT.DAT, and INITOUT.DAT.

(2) Execution of MODSIM for Initialization

Minimum time step, maximum time step, and simulation stopping time are 1, 1000, and 86400 seconds, respectively.

(3) Continuation of Simulation

-----  
\* Execution of MODSIM for Simulation using the Initialization File  
-----

```
*****  
*                                     *  
*           MODSIM           Version 5.0           *  
*                                     *  
*****
```

Enter MINIMUM TIME STEP, MAXIMUM TIME STEP, and SIMULATION STOPPING TIME  
1,1000,259200

Is the Building Shell Model used? (N)

Y

Will the Initialization File be called? (N)

Y

What is the INDEX NUMBER of the SUPERBLOCK for the Building Shell?

1

ISSHEL =1

Enter the time of day (in hours after midnight)  
at which the simulation is to begin

0

Use default file names for all files? (Y/N) (Y)

Do you want Diagnostic Information to be written (N)?

Would you like to monitor the Simulation on Screen? (N)

```
----- SIMULATION BEGINS -----  
-- FIRST WEATHER DATA SET HAS BEEN READ  
----- INITIALIZATION FILE HAS BEEN WRITTEN -----  
STOP -----END OF SIMULATION -----
```

-----  
\* File: MODOUT.DAT (for the second run)  
-----

SUPERBLOCK 1	1.00			
20.3338	18.7336	20.2245	20.2587	20 2350
20.2348	20.3646	20.3782	20 3393	20 0000
2.392979E-02	2.222411E-02	2.281072E-02	0.000000	0 000000
0.000000				

SUPERBLOCK 2	1.00				
20.0006	20.0006	20.0190	22.1665	20.0000	
7.400326E-04	7.400326E-04	7.400324E-04			
SUPERBLOCK 2	3.00				
20.0012	20.0012	20.0379	22.1665	20.0000	
7.400652E-04	7.400652E-04	7.400645E-04			
SUPERBLOCK 2	361.00				
20.1085	20.1074	21.3665	22.1665	20.0000	
7.458397E-04	7.458394E-04	7.428809E-04			
SUPERBLOCK 1	900.00				
20.2759	19.0246	20.2807	20.2373	20.2915	
20.2914	20.3087	20.2832	20.5286	20.7815	
2.963960E-03	-1.935803E-03	-0.251706	0.000000	0.000000	
0.000000					
SUPERBLOCK 2	1030.00				
20.2914	20.2848	21.9241	22.1665	20.0000	
7.564859E-04	7.564828E-04	7.447517E-04			
SUPERBLOCK 1	1800.00				
20.3788	19.1844	20.4744	20.3599	20.4871	
20.4858	20.3460	20.3776	20.8428	21.3204	
8.122213E-04	-5.813498E-03	-0.318652	0.000000	0.000000	
0.000000					
SUPERBLOCK 2	2030.00				
20.5684	20.5509	22.0615	22.1665	20.0000	
7.722455E-04	7.722310E-04	7.456099E-04			
SUPERBLOCK 1	2700.00				
20.5417	19.3457	20.7105	20.5468	20.7238	
20.7221	20.4563	20.5410	21.0963	21.6165	
-1.365668E-02	-1.414384E-02	-0.274801	0.000000	0.000000	
0.000000					
SUPERBLOCK 2	3030.00				
20.8199	20.8021	22.1027	22.1665	20.0000	
7.880400E-04	7.880139E-04	7.459365E-04			
SUPERBLOCK 1	3600.00				
20.7171	19.5224	20.9170	20.7383	20.9268	
20.9277	20.6030	20.7128	21.2837	21.6700	
-3.207046E-02	-1.868834E-02	-0.226565	0.000000	0.000000	
0.000000					
SUPERBLOCK 2	4030.00				
21.0320	21.0371	22.1258	22.1665	20.0000	
8.040539E-04	8.040317E-04	7.460907E-04			
SUPERBLOCK 1	4500.00				
20.8678	19.6788	21.0512	20.8912	21.0556	
21.0583	20.7467	20.8577	21.4103	21.4980	
-4.560097E-02	-1.715894E-02	-0.196922	0.000000	0.000000	
0.000000					
SUPERBLOCK 2	5030.00				
21.2083	21.2612	22.1383	22.1665	20.0000	
8.203641E-04	8.203788E-04	7.461554E-04			
SUPERBLOCK 1	5400.00				
20.9771	19.8039	21.1038	21.0048	21.1012	
21.1027	20.8734	20.9925	21.4787	21.1868	
-6.460547E-02	-6.795895E-02	-0.185209	0.000000	0.000000	
0.000000					
SUPERBLOCK 2	6030.00				
21.3388	21.3847	22.1425	22.1665	20.0000	
8.363114E-04	8.363035E-04	7.461291E-04			
SUPERBLOCK 1	6300.00				
21.0412	19.8925	21.0877	21.0771	21.0774	
21.0786	20.9682	21.0801	21.4985	20.9396	

-8.624774E-02	-8.800596E-02	-0.187045	0.000000	0.000000
0.000000				
SUPERBLOCK 2	7030.00			
21.4201	21.4618	22.1407	22.1665	20.0000
8.513825E-04	8.513539E-04	7.459873E-04		
SUPERBLOCK 1	7200.00			
21.0646	19.9451	21.0291	21.1050	21.0119
21.0139	21.0245	21.1266	21.4826	20.5600
-0.106536	-0.104631	-0.197710	0.000000	0.000000
0.000000				
SUPERBLOCK 2	8030.00			
21.4587	21.5024	22.1354	22.1665	20.0000
8.651502E-04	8.651000E-04	7.457146E-04		
SUPERBLOCK 1	8100.00			
21.0615	19.9696	20.9622	21.1058	20.9397
20.9433	21.0477	21.1442	21.4495	20.4258
-0.121632	-0.116654	-0.210883	0.000000	0.000000
0.000000				
SUPERBLOCK 1	9000.00			
21.0460	19.9751	20.9115	21.0928	20.8857
20.8906	21.0481	21.1434	21.4171	20.4137
-0.127826	-0.120037	-0.223062	0.000000	0.000000
0.000000				
SUPERBLOCK 2	9030.00			
21.4581	21.5134	22.1255	22.1665	20.0000
8.775999E-04	8.775219E-04	7.454029E-04		

----- (OUTPUTS FROM TIME=9900 TO 251796 ARE DELETED) -----

SUPERBLOCK 1	252000.00			
21.9522	20.9661	21.2759	21.9833	21.2252
21.2573	22.1396	22.0591	21.3677	19.4400
-0.263559	-0.238100	-0.265956	0.000000	0.000000
0.000000				
SUPERBLOCK 2	252796.00			
22.3498	22.3719	22.0977	22.1665	20.0000
1.271887E-03	1.306680E-03	7.443607E-04		
SUPERBLOCK 1	252900.00			
21.6665	20.7074	21.0275	21.7072	20.9788
21.0090	21.8346	21.8050	21.2637	19.3084
-0.247862	-0.225442	-0.291922	0.000000	0.000000
0.000000				
SUPERBLOCK 2	253796.00			
22.0627	22.1211	22.0852	22.1665	20.0000
1.270476E-03	1.304380E-03	7.441964E-04		
SUPERBLOCK 1	253800.00			
21.4073	20.4740	20.7989	21.4561	20.7517
20.7804	21.5584	21.5725	21.1705	19.1715
-0.234484	-0.214536	-0.316101	0.000000	0.000000
0.000000				
SUPERBLOCK 1	254700.00			
21.2307	20.3158	20.6300	21.3117	20.5824
20.6115	21.3537	21.4194	21.0885	19.0314
-0.285258	-0.255413	-0.341664	0.000000	0.000000
0.000000				
SUPERBLOCK 2	254796.00			
21.7180	21.8235	22.0655	22.1665	20.0000
1.268979E-03	1.301975E-03	7.440925E-04		
SUPERBLOCK 1	255600.00			
21.0173	20.1295	20.4385	21.0954	20.3922



20.4205	21.1365	21.2273	21.0109	18.8900
-0.241197	-0.220511	-0.359827	0.000000	0.000000
0.000000				
SUPERBLOCK 2 255796.00				
21.4541	21.5897	22.0548	22.1665	20.0000
1.267662E-03	1.299750E-03	7.440553E-04		
SUPERBLOCK 1 256500.00				
20.8110	19.9485	20.2499	20.8892	20.2050
20.2323	20.9246	21.0394	20.9373	18.7490
-0.220682	-0.203429	-0.380644	0.000000	0.000000
0.000000				
SUPERBLOCK 2 256796.00				
21.2297	21.3887	22.0451	22.1665	20.0000
1.266833E-03	1.298028E-03	7.440895E-04		
SUPERBLOCK 1 257400.00				
20.6175	19.7789	20.0705	20.6980	20.0268
20.0533	20.7238	20.8625	20.8683	18.6086
-0.208762	-0.193080	-0.400627	0.000000	0.000000
0.000000				
SUPERBLOCK 2 257796.00				
21.0301	21.2090	22.0363	22.1665	20.0000
1.266805E-03	1.297132E-03	7.441971E-04		
SUPERBLOCK 1 258300.00				
20.4375	19.6212	19.9016	20.5214	19.8589
19.8849	20.5357	20.6978	20.8033	18.4689
-0.200604	-0.185770	-0.419944	0.000000	0.000000
0.000000				
SUPERBLOCK 2 258796.00				
20.8491	21.0461	22.0282	22.1665	20.0000
1.267894E-03	1.297383E-03	7.443784E-04		
SUPERBLOCK 1 259200.00				
20.2705	19.4752	19.7435	20.3584	19.7015
19.7271	20.3605	20.5448	20.7424	18.3300
-0.194380	-0.180170	-0.438363	0.000000	0.000000
0.000000				
SUPERBLOCK 2 259200.00				
20.7811	20.9849	22.0223	22.1665	20.0000
1.268553E-03	1.297710E-03	7.444688E-04		

### C. Postprocessing - Output Data Analysis

Execution of SORTSB program and plotting using the output of SORTSB.

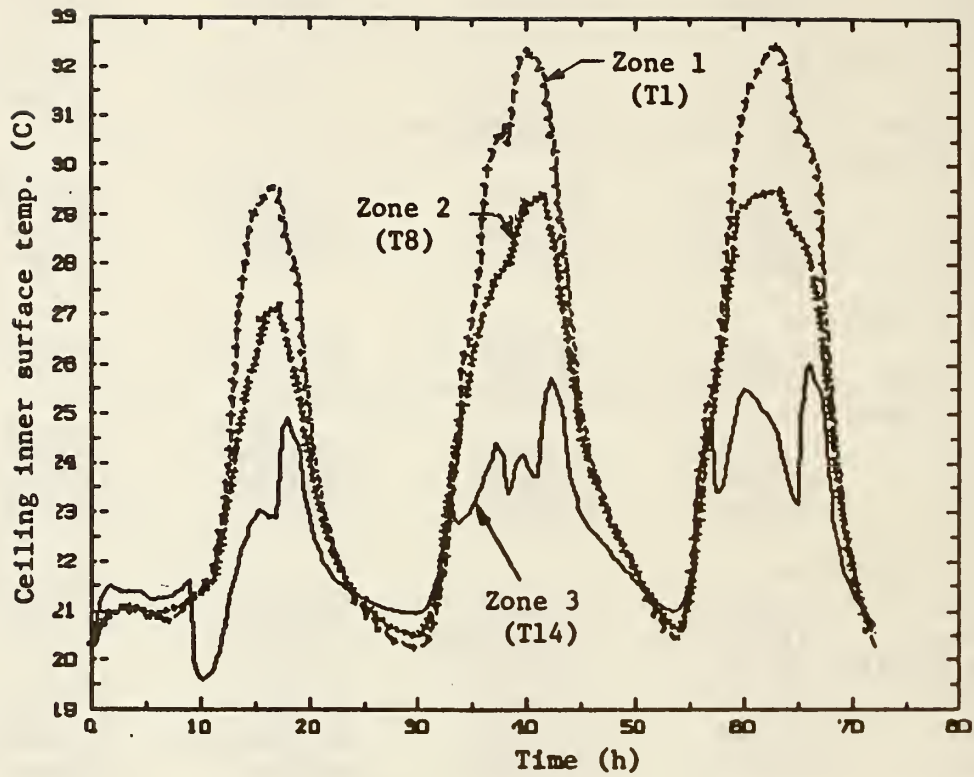

Figure D-3. Ceiling inner surface temperatures of the three-zone model

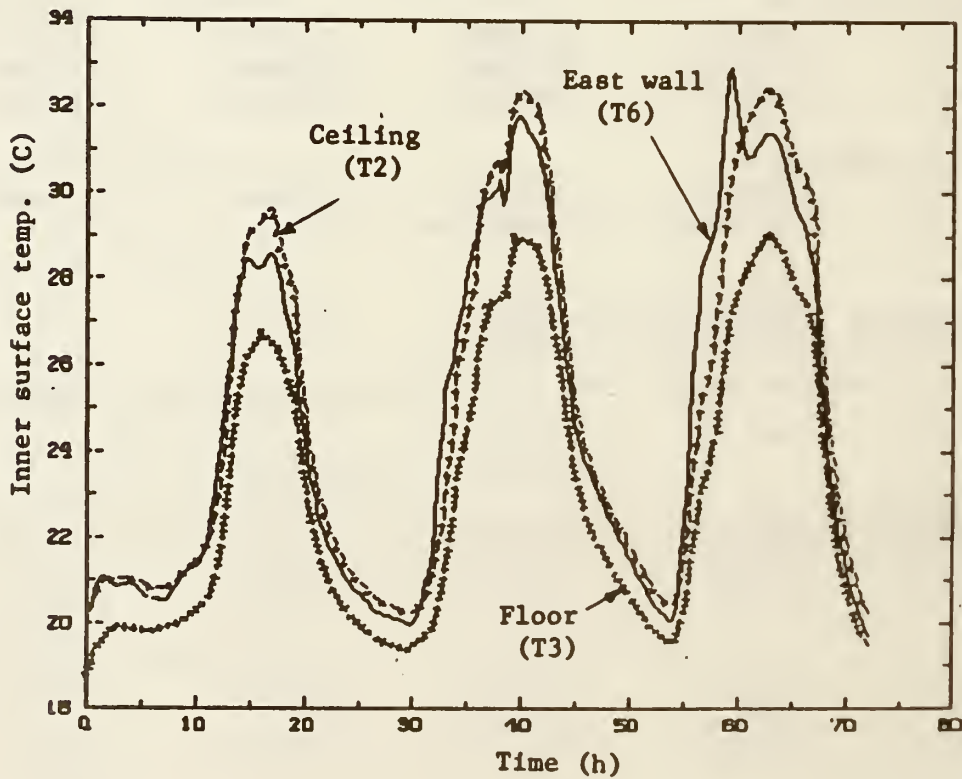

Figure D-4. Inner surface temperatures of the selected building surfaces in Zone 1.

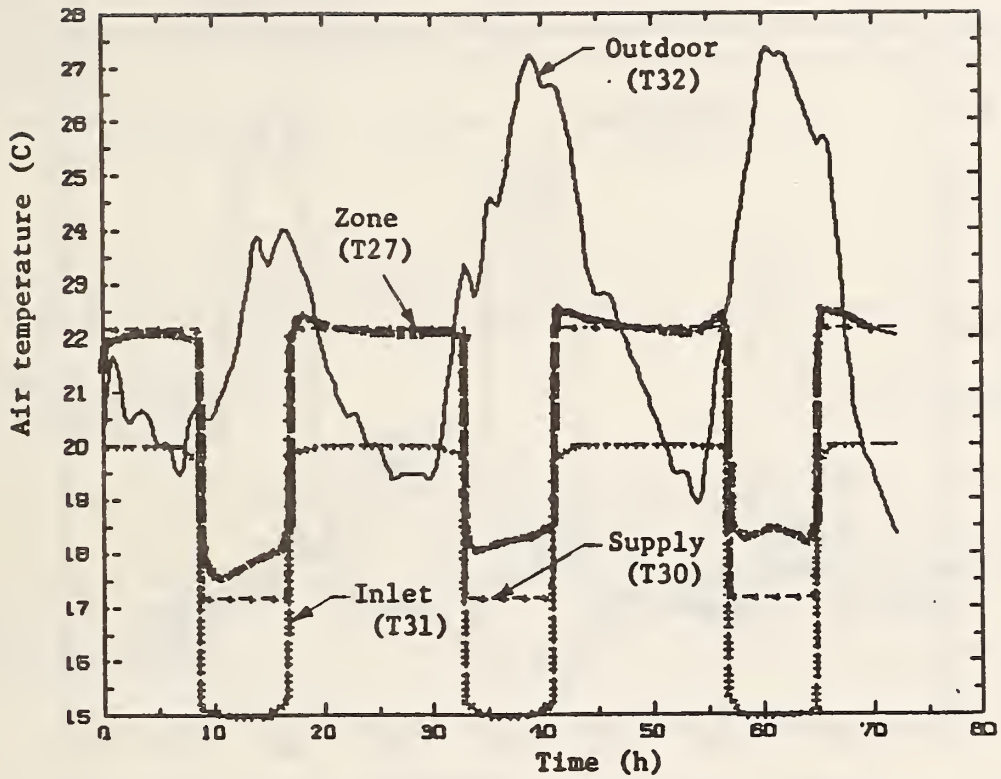

Figure D-5. Outdoor, zone, supply, and inlet air temperatures in Zone 3

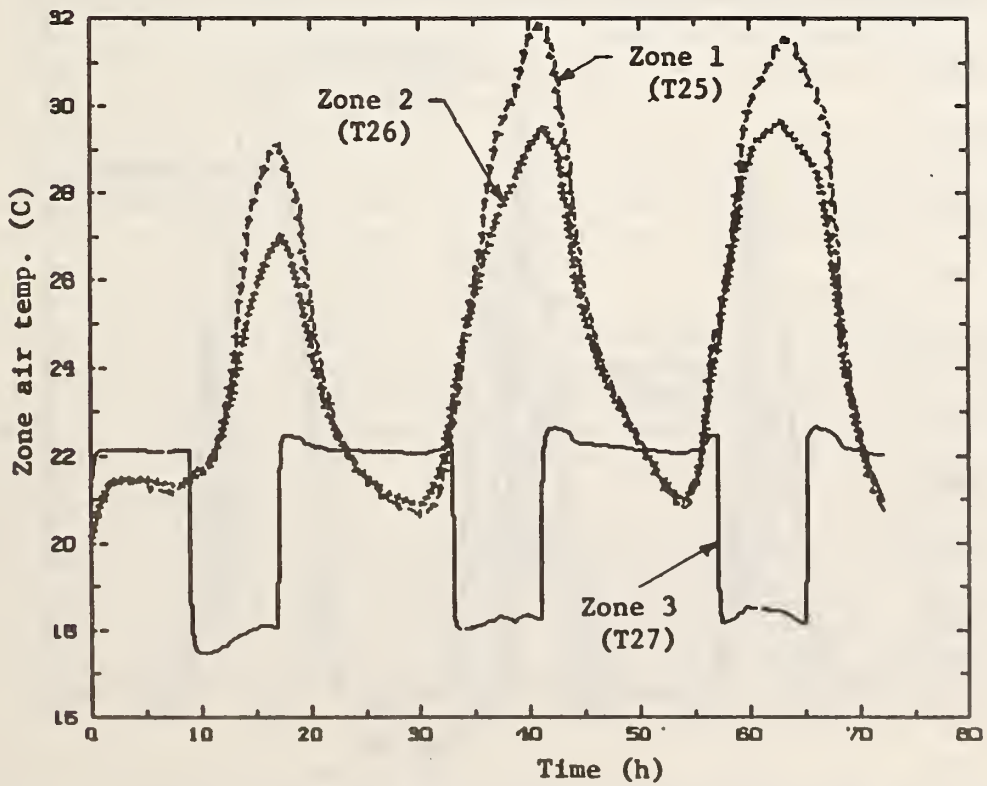

Figure D-6. Zone air temperatures in the three-zone model

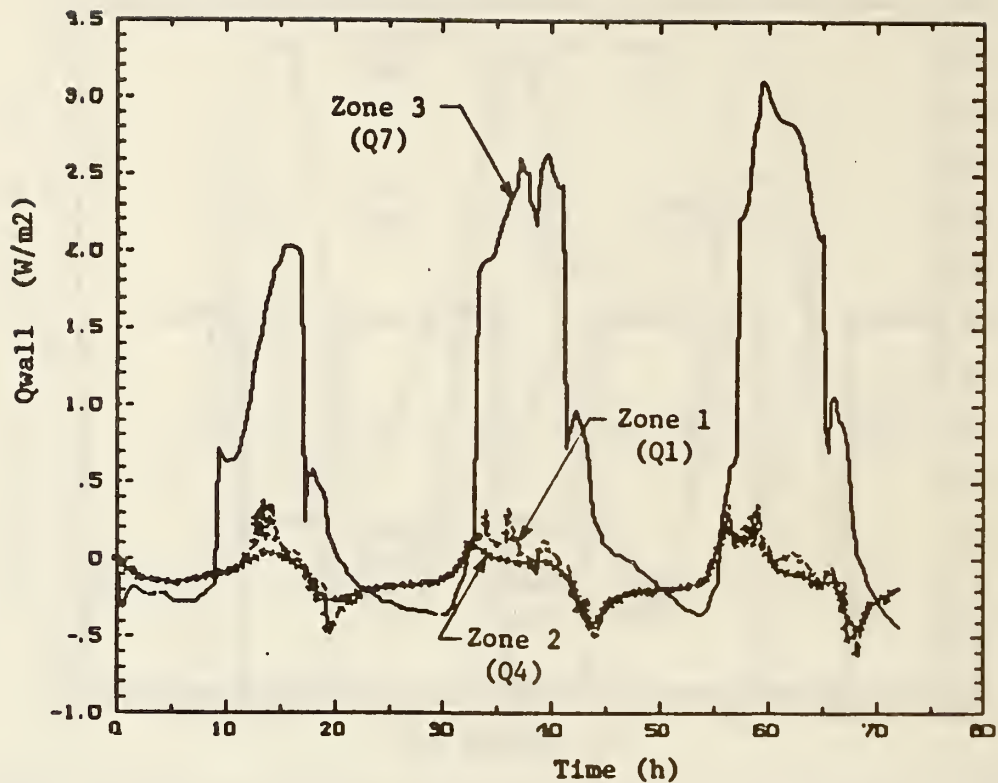

Figure D-7. Convective heat flow rates from the building inner surfaces

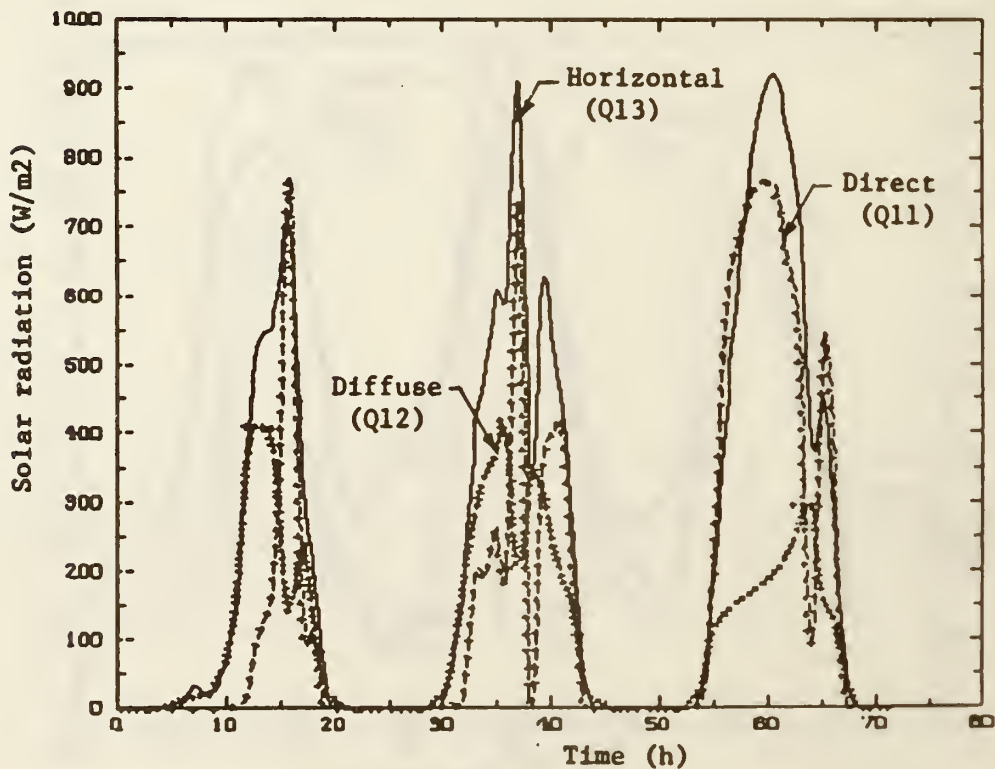

Figure D-8. Solar radiation influxes from a weather tape

U.S. DEPT. OF COMM. <b>BIBLIOGRAPHIC DATA SHEET</b> (See instructions)	<b>1. PUBLICATION OR REPORT NO.</b> NBSIR-86/3331	<b>2. Performing Organ. Report No.</b>	<b>3. Publication Date</b> MARCH 1986
<b>4. TITLE AND SUBTITLE</b> HVACSIM <sup>+</sup> Building Systems and Equipment Simulation Program: Building Loads Calculation			
<b>5. AUTHOR(S)</b> Cheol Park, Daniel R. Clark, George E. Kelly			
<b>6. PERFORMING ORGANIZATION</b> (If joint or other than NBS, see instructions)  <b>NATIONAL BUREAU OF STANDARDS</b> <b>DEPARTMENT OF COMMERCE</b> <b>WASHINGTON, D.C. 20234</b>		<b>7. Contract/Grant No.</b>	<b>8. Type of Report &amp; Period Covered</b>
<b>9. SPONSORING ORGANIZATION NAME AND COMPLETE ADDRESS</b> (Street, City, State, ZIP) Office of Buildings and Community Systems      U.S. Navy Civil Engineering Laboratory U.S. Department of Energy                              U.S. Department of Defense 1000 Independence Avenue, NW                      Port Hueneme, CA 93043 Washington, DC 20585			
<b>10. SUPPLEMENTARY NOTES</b>  <input type="checkbox"/> Document describes a computer program; SF-185, FIPS Software Summary, is attached.			
<b>11. ABSTRACT</b> (A 200-word or less factual summary of most significant information. If document includes a significant bibliography or literature survey, mention it here)  A non-proprietary building system simulation program called HVACSIM <sup>+</sup> , which stands for HVAC SIMulation PLUS other systems, has been developed at the National Bureau of Standards (NBS) in an effort to understand the dynamic interactions between a building shell, an HVAC system, and building controls. HVACSIM <sup>+</sup> consists of a main simulation program, a library of HVAC system component models, a building shell model, and interactive front end input data generation programs. The main simulation program employs a hierarchical, modular approach and advanced equation solving techniques to perform dynamic simulations of building/HVAC/control systems. In the building shell model, a fixed time step selected by the user is employed, while a variable time step approach is used in the HVAC and control systems portion of a simulation and the zone model. This report presents the overall architecture of the HVACSIM <sup>+</sup> program, algorithms used in the main simulation program, a brief discussion of the numerical methods used in solving a system of non-linear simultaneous equations, integrating stiff ordinary differential equations and interpolating data and descriptions of the building shell and zone models. Conduction transfer functions, weather data, and simulation procedure are also described. This report is the third document, which describes the building model, supplied with HVACSIM <sup>+</sup> .			
<b>12. KEY WORDS</b> (Six to twelve entries; alphabetical order; capitalize only proper names; and separate key words by semicolons) building dynamics; building simulation; building system modeling; computer simulation programs; control dynamics; dynamic modeling of building systems; dynamic performance of building systems; dynamic simulations; HVAC system simulations; HVACSIM <sup>+</sup>			
<b>13. AVAILABILITY</b> <input checked="" type="checkbox"/> Unlimited <input type="checkbox"/> For Official Distribution. Do Not Release to NTIS <input type="checkbox"/> Order From Superintendent of Documents, U.S. Government Printing Office, Washington, D.C. 20402.  <input checked="" type="checkbox"/> Order From National Technical Information Service (NTIS), Springfield, VA. 22161		<b>14. NO. OF PRINTED PAGES</b>  202	<b>15. Price</b>  \$22.95





