

NAT'L INST. OF STAND & TECH

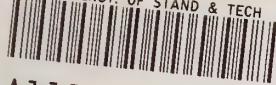

A11106 339871



REFERENCE

NBS
PUBLICATIONS

NBS TECHNICAL NOTE 1092

U.S. DEPARTMENT OF COMMERCE / National Bureau of Standards

Design, Evaluation, and Use of a Reverberation Chamber for Performing Electromagnetic Susceptibility/Vulnerability Measurements

M. L. Crawford
G. H. Koepke

QC
100
.U5753
No. 1092
1986

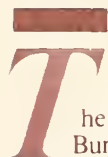

The National Bureau of Standards¹ was established by an act of Congress on March 3, 1901. The Bureau's overall goal is to strengthen and advance the nation's science and technology and facilitate their effective application for public benefit. To this end, the Bureau conducts research and provides: (1) a basis for the nation's physical measurement system, (2) scientific and technological services for industry and government, (3) a technical basis for equity in trade, and (4) technical services to promote public safety. The Bureau's technical work is performed by the National Measurement Laboratory, the National Engineering Laboratory, the Institute for Computer Sciences and Technology, and the Institute for Materials Science and Engineering.

The National Measurement Laboratory

Provides the national system of physical and chemical measurement; coordinates the system with measurement systems of other nations and furnishes essential services leading to accurate and uniform physical and chemical measurement throughout the Nation's scientific community, industry, and commerce; provides advisory and research services to other Government agencies; conducts physical and chemical research; develops, produces, and distributes Standard Reference Materials; and provides calibration services. The Laboratory consists of the following centers:

- Basic Standards²
- Radiation Research
- Chemical Physics
- Analytical Chemistry

The National Engineering Laboratory

Provides technology and technical services to the public and private sectors to address national needs and to solve national problems; conducts research in engineering and applied science in support of these efforts; builds and maintains competence in the necessary disciplines required to carry out this research and technical service; develops engineering data and measurement capabilities; provides engineering measurement traceability services; develops test methods and proposes engineering standards and code changes; develops and proposes new engineering practices; and develops and improves mechanisms to transfer results of its research to the ultimate user. The Laboratory consists of the following centers:

- Applied Mathematics
- Electronics and Electrical Engineering²
- Manufacturing Engineering
- Building Technology
- Fire Research
- Chemical Engineering²

The Institute for Computer Sciences and Technology

Conducts research and provides scientific and technical services to aid Federal agencies in the selection, acquisition, application, and use of computer technology to improve effectiveness and economy in Government operations in accordance with Public Law 89-306 (40 U.S.C. 759), relevant Executive Orders, and other directives; carries out this mission by managing the Federal Information Processing Standards Program, developing Federal ADP standards guidelines, and managing Federal participation in ADP voluntary standardization activities; provides scientific and technological advisory services and assistance to Federal agencies; and provides the technical foundation for computer-related policies of the Federal Government. The Institute consists of the following centers:

- Programming Science and Technology
- Computer Systems Engineering

The Institute for Materials Science and Engineering

Conducts research and provides measurements, data, standards, reference materials, quantitative understanding and other technical information fundamental to the processing, structure, properties and performance of materials; addresses the scientific basis for new advanced materials technologies; plans research around cross-country scientific themes such as nondestructive evaluation and phase diagram development; oversees Bureau-wide technical programs in nuclear reactor radiation research and nondestructive evaluation; and broadly disseminates generic technical information resulting from its programs. The Institute consists of the following Divisions:

- Inorganic Materials
- Fracture and Deformation³
- Polymers
- Metallurgy
- Reactor Radiation

¹Headquarters and Laboratories at Gaithersburg, MD, unless otherwise noted; mailing address Gaithersburg, MD 20899.

²Some divisions within the center are located at Boulder, CO 80303.

³Located at Boulder, CO, with some elements at Gaithersburg, MD.

NBS technical note
...

NBS
RESEARCH
INFORMATION
CENTER

NBSR

Q0100

.U5753

110.104

1986

Design, Evaluation, and Use of a Reverberation Chamber for Performing Electromagnetic Susceptibility/Vulnerability Measurements

M. L. Crawford
G. H. Koepke

Electromagnetic Fields Division
Center for Electronics and Electrical Engineering
National Bureau of Standards
Boulder, Colorado 80303

Supported in part by
Naval Surface Weapons Centers (NSWC)
Dalgren, Virginia

and
Rome Air Development Center (RADC)
Griffiss Air Force Base
Rome, New York



U.S. DEPARTMENT OF COMMERCE, Malcolm Baldrige, Secretary

NATIONAL BUREAU OF STANDARDS, Ernest Ambler, Director

Issued April 1986

National Bureau of Standards Technical Note 1092
Natl. Bur. Stand. (U.S.), Tech Note 1092, 146 pages (Apr. 1986)
CODEN:NBTNAE

U.S. GOVERNMENT PRINTING OFFICE
WASHINGTON: 1986

For sale by the Superintendent of Documents, U.S. Government Printing Office, Washington, DC 20402

FOREWORD

The research described in this report represents the culmination of over 3 years of work at the National Bureau of Standards (NBS), Electromagnetic Fields Division, Boulder, Colorado, to carefully evaluate, develop (when necessary), describe, and document the methodology for performing radiated susceptibility/vulnerability (EMS/V) measurements using a reverberation chamber. This effort was jointly funded by the Naval Surface Weapons Center (NSWC), Dahlgren, Virginia; Rome Air Development Center (RADC), Griffiss Air Force Base, Rome, New York; and the NBS. Three major tasks were outlined. These were to:

1. Determine how well a shielded enclosure could be made to operate as a reverberation chamber to establish time averaged (statistically determined), randomly polarized, uniform EM fields as a function of spatial position, frequency and chamber quality factor (Q);
2. Evaluate interaction effects between the chamber and equipment under test (EUT) placed inside the chamber to determine:
 - a. The range of applications of the measurement techniques (i.e., where the technique could or should not be used),
 - b. Whether measurement results obtained using the reverberation chamber could be correlated with results obtained using anechoic chambers or open field sites, and
 - c. To identify pertinent chamber calibration parameters;
3. Develop a technique applications and use manual.

These tasks were addressed sequentially in three major phases. The first phase was to design, construct, assemble and evaluate an empty (without the presence of an EUT inside) reverberation chamber with associated instrumentation and software to evaluate its electrical performance characteristics. This phase of the work began in January 1982 and was completed by the end of 1983. Results of this effort are contained in Section 2 of this report. Section 2 discusses the modification of a 2.74 m x 3.05 m x 4.57 m welded steel shielded enclosure located at NBS into a reverberation chamber. Information given includes theoretical concepts, physical design and construction details, and the evaluation of the empty chamber's electrical parameters. These parameters are excitation and reference receiving antennas voltage standing wave ratio (VSWR), loss, Q factor, wave impedance, spatial E-field distribution versus frequency, and determination of the test field level.

The second phase of the work was to evaluate the interaction effects between the chamber and the EUT placed in the chamber. This effort occupied the latter part of 1983 through 1984. The results are contained in Section 3 of this report. The third phase was to develop methodology and evaluate the use of the reverberation chamber for susceptibility measurements and compare the results to other more conventional measurements techniques such as anechoic chambers and to other reverberation chambers. This study included the selection and susceptibility evaluation of four samples of EUTs: a one centimeter dipole probe, a ridged horn antenna, a series of rectangular TEM transmission cells with apertures and a modified 7.0 cm (2.75") diameter folded fin aircraft rocket (FFAR). The first three "reference standard" EUT's were selected because they could be characterized theoretically. The fourth EUT (FFAR) was more typical of an operational EUT which is more indicative of the actual type of equipment routinely tested for EM susceptibility. Results were obtained for this phase of the effort during 1984 and 1985. Details of how the measurements were performed, including setups, approaches, and instrumentation and software requirements are contained in Section 4. The final task was to document these results, presented in Section 5, and to produce a reverberation measurement technique applications and use manual. This, of course, is one of the purposes of this report. Section 6 gives a brief summary and conclusions drawn from this study. Some of the more significant are: 1) the NBS chamber lower useful frequency limit is 200 MHz; 2) the spatial variation in the statistically determined E-field established in the chamber is approximately ± 8 dB at 200 MHz and decreases to ± 2 dB at 2 GHz; 3) the preferred measurement approaches are mode tuned (explained in section 4.3.2) at frequencies below 2 GHz and mode stirred (also explained in section 4.3.2) at frequencies above 2 GHz; 4) the loading effect, of lowering the chamber's Q by inserting the EUT, should be limited to an increase in chamber loss ≤ 6 dB or a minimum tuner effectiveness ≥ 20 dB; 5) the average wave impedance in the chamber is approximately 120π ; 6) the maximum E-field is approximately 7-8 dB greater than the average E-field established in the chamber; 7) scattering from EUT does not significantly influence the E-field statistical, spatial distribution; 8) the directional characteristics of antenna or EUT placed inside the chamber are effectively lost; 9) the response of EUT measured inside a reverberation chamber is less than when measured inside an anechoic chamber (open space) in proportion to the EUT open space gain; 10) the response of EUT to an interference

field after it has penetrated the EUT's shield appears to be equivalent in both reverberation and anechoic chambers; and 11) the experimental error analysis suggests that Root Square Sum (RSS) errors in establishing the test field inside a reverberation chamber range from approximately ± 10 dB at 200 MHz to ± 4 dB at 18 GHz.

Section 7 provides suggestions for future research and Section 8 acknowledges the significant contribution of others to this project. References cited are given in Section 9.

CONTENTS

Page

Abstract.....1

1. Background and Introduction.....1

2. Development of an Operational Reverberation Chamber.....2

 2.1 Theoretical Concepts.....2

 2.2 Physical Design Considerations.....5

 2.2.1 Chamber Physical Shape and Volume.....6

 2.2.2 Chamber Quality Factor (Q).....6

 2.2.3 Chamber Auxiliary Needs.....6

 2.2.4 Tuner Design.....6

 2.2.5 Chamber Excitation and Field Monitoring.....7

 2.3 Determination of Wave Impedance and E-Field Amplitude Distribution
 Inside Reverberation Chamber.....8

 2.3.1 Determining the Test Field and Wave Impedance Amplitudes.....8

 2.3.2 Maximum Versus Average Amplitude Responses.....9

 2.4 Spatial E-Field Distribution.....10

 2.5 Multiple Excitation of the Chamber.....10

3. Interaction Effects Between Chamber, Source and Reference Antennas, and
EUT.....11

 3.1 Placement Constraints of EUT.....11

 3.2 Scattering Effects of Metal Objects Upon E-Field Distribution.....11

 3.3 Loading Effects of EUT on Chamber.....11

4. Performing Immunity Measurements.....12

 4.1 Planning the Measurements.....12

 4.2 Measurement Approaches (Tuned vs. Stirred).....14

 4.3 Measurement System.....14

 4.3.1 Measurement Setup and Instrumentation Requirements.....14

 4.3.2 Software Requirements and Measurement Procedures.....14

5. Experimental Test Results.....19

 5.1 Correlation of Results to Anechoic Chamber Tests - Some Examples.....19

 5.1.1 Description of Anechoic Chamber Measurement System.....19

 5.1.2 Measurement of the Peak Response of a 1 cm Dipole and a
 Ridged Horn.....19

 5.1.3 Measurement of RF Coupling Through Apertures in TEM Lines.....20

 5.1.4 Measurements of the EM Susceptibility of a Modified 7.0 cm
 Folding Fin Aircraft Rocket (FFAR).....20

 5.2 Comparison of Results Between Reverberation Chambers.....21

6. Summary and Conclusions.....21

 6.1 Conclusions Drawn From Study.....21

 6.2 Summary of Measurement Uncertainties.....22

 6.2.1 Determining the Field Strength Inside the Chamber.....22

 6.2.2 General Comments on Error Analysis.....24

 6.3 Measurement Technique Advantages and Limitations.....24

7. Suggestions for Future Research Efforts.....25

8. Acknowledgments.....26

9. References.....26

List of Figures and Tables.....28

Appendix.....85

Design, Evaluation, and Use of a Reverberation Chamber for Performing
Electromagnetic Susceptibility/Vulnerability Measurements

M.L. Crawford and G.H. Koepke

Electromagnetic Fields Division
National Bureau of Standards
Boulder, Colorado 80303

This report presents the results of work at the National Bureau of Standards, Boulder, Colorado, to carefully evaluate, document, develop (when necessary), and describe the methodology for performing radiated susceptibility/vulnerability measurements using a reverberation chamber. The report describes the reverberation chamber theory of operation, construction, evaluation, functional operation, and use for performing immunity measurements. It includes an estimate of measurement uncertainties derived empirically from test results and from comparisons with anechoic chamber measurements. Finally, it discusses the limitations and advantages of the measurement technique to assist potential users in determining the applicability for this technique to their electromagnetic compatibility (EMC) measurement needs.

Key Words: electromagnetic susceptibility/vulnerability; estimated uncertainty; evaluation; measurement procedures; reverberation chamber

1. Background and Introduction

The use of mode tuned or stirred reverberation chambers for performing EMC measurements is a relatively new method which appears to have considerable potential for electromagnetic susceptibility/vulnerability testing [1-7]. The idea of reverberating a shielded enclosure as a way to improve the EMC measurement results obtained using the enclosure was first proposed in 1968 [1]. Since then measurement procedures have been developed for implementing the technique for both radiated susceptibility and emission testing, but with considerable skepticism and a general lack of acceptance on the part of many EMC engineers. Reasons given include: 1) a lack of information about interaction effects between the EUT, reverberation chamber, and sources used to excite the chamber, 2) significant unanswered questions concerning the interpretation and accuracy of the measurement results, and 3) the lack of clear correlation of test results with other more conventional measurement techniques. Emphases for performing the work described in this report result from numerous advantages suggested for use of a reverberation chamber. These include:

1. Electrical isolation from or to the external environment;
2. Accessibility (indoor test facility);
3. The ability to generate high level fields efficiently over large test volumes;
4. Broad frequency coverage;
5. Cost effectiveness;
6. Potential use for both radiated susceptibility and emission testing with minor instrumentation changes; and
7. No requirement of physical rotations of the equipment under test (EUT).

These advantages are somewhat offset by limitations which include loss of polarization and directivity information relative to the EMC/EMI profile of the EUT and reduced measurement accuracy. However, this technique does offer a time efficient, cost effective way to evaluate EMC performance of large equipment using existing shielded enclosures with only minor modifications. The concept utilizes the shielded, high-Q, multimoded environment to obtain uniform (time averaged) fields that may simulate "real world", near field environments.

This report describes efforts to answer some of the questions referred to above and outlines an approach using this technique for EMS/V testing. It also describes efforts to identify a "correlation factor" between reverberation chamber and anechoic chamber obtained results, and outlines a detailed, step by step procedure for performing EMS/V tests. An experimental error analysis is given to provide insight into the magnitude of the measurement uncertainties expected for tests performed using this method.

2. Development of an Operational Reverberation Chamber

2.1 Theoretical Concepts

A reverberation chamber is a large (in terms of wavelength) high quality (Q) cavity whose boundary conditions are continuously and randomly perturbed by means of a rotating conductive tuner or stirrer. The time averaged field inside such a cavity, when a sufficient number of modes are excited, is formed by uniformly distributed plane waves coming from all directions. This property causes the polarization of the field to vary randomly hence eliminating the need, or the utility of physical rotation of test objects in the field. This has its obvious advantages and disadvantages as is apparent from the results and conclusions given in this report.

Two analytical approaches can be used to provide basic knowledge for designing a reverberation chamber. One involves the direct solution of Maxwell's equations with time varying boundary conditions. A formal solution using this direct approach is rather difficult to obtain. In the second approach, suitable linear combinations of basic eigenmodes of the unperturbed cavity (without mode stirrer or tuner) with time-dependent expansion coefficients are taken to represent the field and to satisfy approximately the boundary condition on the surface of the rotating mode stirrer or tuner [8]. The main advantage of this latter approach is that the unperturbed eigenfrequencies and eigenmodes are much easier to calculate, and the problem can be reduced to a more familiar one under special conditions. A necessary condition for the validity of this method is, however, that the total number of eigenmodes which can exist inside a chamber be large for a specified frequency and chamber size. Thus, the measurement technique using reverberating chambers is good for high frequency application. Typical frequencies of operation are from a few hundred MHz to 18 GHz and above.

The frequencies at which particular modes can exist inside a shielded, rectangular enclosure of dimensions a, b, and d are given as [9]

$$f_{mnp} = 150 \sqrt{\left(\frac{m}{a}\right)^2 + \left(\frac{n}{b}\right)^2 + \left(\frac{p}{d}\right)^2} \quad (\text{MHz}) \quad (1)$$

where m, n, and p are integers.

Figure 2.1 gives the distinct frequencies of resonances of the first few modes for the NBS reverberation chamber. There are 26 resonant modes at distinct frequencies below 150 MHz and 63 resonant modes at distinct frequencies below 200 MHz.

As expected, the total possible number of eigenmodes, $N(f)$, inside an unperturbed, lossless, rectangular chamber increases in steps with frequency. A smooth approximation to $N(f)$ has been given by [8,10,11]:

$$N_s(f) = \frac{8\pi}{3} abd \left\{\frac{f}{c}\right\}^3 - (a + b + d) \frac{f}{c} + \frac{1}{2}, \quad (2)$$

where abd in m^3 represents the chamber volume, f is the operating frequency in Hz, and c is the speed of wave propagation in the chamber medium (usually air) in m/s. Note that the first term in (2) is identical to the well-known Weyl's formula derived originally for the same problem by a different approach, and is proportional to the chamber volume and the third power of frequency. The second term is the edge term, which is proportional to the sum of the linear dimensions of the chamber. This term may be used to modify Weyl's result, especially in the lower frequency range. Also, the inner surface area of the chamber, $2(ab + bd + da)$, is not involved in (2). An example is given in figure 2.2 showing $N(f)$ as curve 1, $N_s(f)$ as curve 2, and Weyl's formula as curve 3 for the NBS chamber. Note that none of the dimensions of the NBS chamber (2.74 m x 3.05 m x 4.57 m) are equal. Equivalent examples for a square-based chamber (2.17 m x 4.19 m x 4.19 m) and a cubic chamber (3.37 m)³, both of which have the same volume as that of the NBS chamber, are shown respectively in figures 2.3 and 2.4 for comparison purposes. Clearly, wider steps for curve 1 in figures 2.3 and 2.4 as compared with figure 2.2 are observed. This is true even though the smooth approximation $N_s(f)$ remains almost identical for all the three chambers. The main reason for this is due to the increased mode degeneracy for the last two chambers, under which the total number of distinct eigenmodes with respect to a given operating frequency and chamber size decreases.

While the total number of eigenmodes inside an unperturbed chamber is an important design criterion, another equally important factor to consider is the mode density function, dN/df , which represents the change in number of modes in a given frequency interval. Ideally, the chamber should be designed, if possible, so that the distribution of the modes is uniform. To determine the exact shape of dN/df involves using impulse functions since they are the derivatives of step functions. It is not difficult to see that within a given frequency interval, the average distance between the different impulses for the NBS chamber is shorter than that for the other two chambers having the same volume. An alternative quantity to examine for exhibiting this property is

$$\Delta N = \int_{\Delta F} \frac{dN}{df} df \quad , \quad (3)$$

which represents the increase or decrease in mode number within a frequency interval of Δf .

Results of ΔN when $\Delta f = 1$ MHz are presented respectively in figures 2.5 through 2.7 for the NBS chamber, the square-based chamber, and the cubic chamber. The uniformity of mode distribution in the frequency interval of 1 MHz is better for the NBS chamber (figure 2.7). This is the reason that the NBS chamber was designed with unequal dimensions. As a consequence, more uniformity for the electromagnetic field is expected within the NBS chamber than for chambers that have two equal sides or that are cubic, with the same volume and frequency of operation. Or, the NBS chamber should be capable of being operated with an extended lower frequency limit than other chambers of the same volume, in order to meet a given degree of uniformity for the final, expected field distribution. Thus, one of the general design criteria for a reverberating chamber is to make the volume as large as possible and the ratio of squares of linear dimensions as nonrational as possible.

A third design criterion, namely, the quality or Q factor, must also be considered in designing a reverberation chamber. Since there are so many eigenmodes which may exist in an unperturbed chamber with each mode carrying its own Q value [8,10,11], it is not always trivial to define a quality factor for the chamber as a whole. A composite quality factor for an unloaded chamber (without an EUT in it) within a specified frequency range can be obtained approximately from the equation [8],

$$\tilde{Q} = \frac{3}{2} \frac{V}{S \delta_s} \frac{1}{1 + \frac{3\lambda}{16} \left(\frac{1}{a} + \frac{1}{b} + \frac{1}{d} \right)} \quad (4)$$

where V is the chamber's volume in cubic meters, S is the internal surface area in square meters, and $\delta_s = \sqrt{\frac{2}{\omega \mu \sigma}}$ is the skin depth in meters, λ is the wavelength in meters, and a , b , and d , are the chamber's internal dimensions in meters.

The physical meaning of (4) may be interpreted by comparing it with the individual Q values of all the modes in the form of a cumulative distribution. Since $V/(S \delta_s)$ is a common factor whether the composite quality factor defined above or the quality factor for individual modes is considered, it is more convenient to present the results in terms of $1/Q$ values normalized with respect to $S \delta_s/V$. Thus, the variable used herein is

$$\alpha = \frac{1}{Q} (V/S \delta_s) \quad . \quad (5)$$

Examples of the cumulative distribution of α for the NBS chamber are given respectively in figures 2.8 - 2.10 for three different frequency bands. For the frequency band of 180 to 200 MHz in figure 2.8, the total number of modes existing in this band of 20 MHz is 69, with each mode having its own Q-value. The probability of having a high upper-bound value of $\alpha \leq 0.80$ (or a lower-bound for Q) is almost 100%, and that for a low value of $\alpha \leq 0.48$ (or a high value for Q) is only about 10%. This implies that almost all of the 69 modes in this frequency band have $\alpha \leq 0.80$. The arithmetic mean of 0.623 and the standard deviation of 0.090 are also indicated in the figure. The probability of having $\alpha \leq 0.623$ (arithmetic mean) is 50%, meaning that at least one half of the 69 modes have $\alpha \leq 0.623$.

For the case presented in figure 2.9, where the frequency band is from 330 to 350 MHz, also of a bandwidth of 20 MHz, there are 261 modes, an increase in number of modes relative to that in figure 2.8. This is because of higher frequency. A similar interpretation of the α values (or Q values) carried by these modes in terms of probability applies. There are now a small number of modes (low probability) carrying a value of α as low as 0.43 (high Q). The arithmetic mean and standard deviation are, respectively 0.630 (higher than the corresponding value in figure 2.8) and 0.085 (lower than the corresponding value of figure 2.8). A higher value of arithmetic mean implies that one half or more of the 261 modes carry a higher value of α (lower Q) compared to the frequency band considered in figure 2.8. A decrease in standard deviation reveals that a greater number of modes have α -values closer to the arithmetic mean.

If we consider a still higher frequency band 480 to 500 MHz such as that illustrated in figure 2.10, 534 possible modes will exist in the same bandwidth of 20 MHz. The arithmetic mean increases further to 0.646 while the standard deviation decreases further to 0.074, indicating that a greater number of modes will have still higher α values near the arithmetic mean. This tendency, increasing in arithmetic mean and decreasing in standard deviation with increased frequency, yields a limiting mean of $\alpha \leq 0.667$ with a 50% probability, which also agrees precisely with the limiting value for composite $\tilde{\alpha}$ derived from (4) and (5).

Thus, even though there are a large number of possible modes existing in a specified operating frequency band for a reverberating chamber, with each mode carrying its own value of α or Q, the probability that $\alpha \leq 0.667$ (or $Q \leq 1.5 V/S\sigma_s$) is 50%. This implies that one half of the modes have α -values less than 0.667. Preliminary estimation of a quality factor to characterize the reverberating chamber as a whole, based on the simple expression of \tilde{Q} in (4), for the purpose of predicting the field strength level to be generated in the test zone is indeed very useful.

Finite Q values also imply that more than 1 mode can be excited at a single frequency. The extent to which modes not specifically resonant at a given frequency are excited is, of course, dependant upon the particular modes' Q, and how close the modes' resonant frequencies are to the given frequency.

The composite \tilde{Q} estimated from (4) is considered an upper-bound value because it does not take into account losses other than that due to wall conductivity. In reality, some loss will also occur due to leakage from the chamber, loss in antenna support structures, etc., and loss in the chamber's wall coatings. Hence an alternative means of determining chamber Q can be achieved from measuring the chamber's loss. Chamber loss is determined experimentally by measuring the difference between the net input power, P_t , delivered to the chamber's transmitting antenna, and the power available, P_r , at the reference antenna terminals. A photograph showing the interior of the NBS reverberation chamber is shown in figure 2.11. If the energy is uniformly distributed over the volume of the chamber, an empirical value (Q') can be obtained [6] using the equation,

$$Q' \approx 16 \pi^2 \frac{V}{\lambda^3} \frac{P_r}{P_t}, \quad (6)$$

where V and λ are as previously defined.

Typical losses for the NBS chamber are shown in figure 2.12. The two curves show the average and minimum loss as a function of frequency. These results were determined statistically by rotating the chamber's tuner through 200 increments of 1.8 degrees and measuring the chamber's loss at each position for all test frequencies. The smooth curves are an estimated curve fit for the data.

Results obtained using (4) to calculate the composite \tilde{Q} and by using the data shown in figure 2.12 and (6) to calculate the experimental Q' are shown in figure 2.13. Figure 2.13a gives the curves for the calculated values of \tilde{Q} and Q' and figure 2.13b shows the ratio of \tilde{Q} to Q' . At frequencies above approximately 1 GHz the ratio approaches a constant value approximately equal to 3 or a loss equivalent of approximately 5 dB.

The Q factor of the chamber, of course, influences the rf input power requirements to generate the EM field levels inside the chamber for performing susceptibility tests. The average power received by the reference antenna, \bar{P}_r in watts, is related to the average power density, \bar{P}_d in watts per square meter, of the EM field inside the chamber by the equation,

$$\bar{P}_d = \bar{P}_r / \bar{A}_r \text{ (W/m}^2\text{)}, \quad (7)$$

where \bar{A}_r is the average effective aperture in square meters of the receiving antenna.

If the receiving antenna is subjected to EM energy coming from all aspect angles and random polarizations, the average gain of the antenna over 4π solid angle is unity. (i.e., The field distribution at each point in the antenna aperture plane is assumed to be a composite of randomly polarized plane waves. This implies that the orientation of the receiving antenna will not influence the measured response and hence the effective gain of the antenna is unity.) The effective aperture of the antenna then is given as, $\bar{A}_r = \lambda^2/8\pi$ [12]. However, data obtained, as shown later in this report, indicates that these conditions are not achieved ideally (the field is not completely randomly polarized and incident at all aspect angles and the assumption that the average gain for the antenna is one is not exact). Hence, a more practical value to use for the effective aperture appears to be $\lambda^2/4\pi$. This value has been suggested previously for use in reverberation chambers for determining the "equivalent" average power density, \bar{P}_d [4]. Equation (7) then becomes,

$$\bar{P}_d = \frac{4\pi \bar{P}_r}{\lambda^2} \text{ (W/m}^2\text{)}. \quad (8)$$

Combining (6) and (8), we can obtain an expression for comparing the average, equivalent power density inside chambers of different size, assuming equal net input power, or

$$\frac{\bar{P}'_{d_1}}{\bar{P}'_{d_2}} = \frac{V_2}{V_1} \frac{Q'_1}{Q'_2} = \frac{S_2}{S_1} \frac{\delta_2}{\delta_1}, \quad (9)$$

where the subscripts 1 and 2 refer to the two different enclosures, #1 and #2. For example, assume the #1 enclosure is the NBS enclosure with $S_1 = 69.63 \text{ m}^2$ and the #2 enclosure is a larger chamber constructed of the same metal ($\delta_1 = \delta_2$) with dimensions, 3.51 m x 5.18 m x 10.82 m, or $S_2 = 224.42 \text{ m}^2$; this would give a ratio in average power densities (assuming the same net input power) of $\bar{P}'_{d_1} / \bar{P}'_{d_2} = 3.22$ (i.e., the average power density inside the larger enclosure would be approximately 1/3.22 or 0.311 times as much as that in the NBS enclosure). Note that the validity of (9) is dependent upon a number of assumptions alluded to in its derivation.

2.2 Physical Design Considerations

A number of criteria should be considered in physically designing a reverberation chamber EM susceptibility/vulnerability measurement system. They can be addressed under the following categories:

1. Chamber physical shape and volume,
2. Chamber quality factor (Q),
3. Chamber auxiliary needs (venting, electrical power, EUT visual monitoring, EUT operational and functional monitoring requirements),
4. Tuner/stirrer(s) design, and
5. Chamber excitation and field monitoring.

2.2.1 Chamber Physical Shape and Volume

This criterion was addressed in Section 2.1. For optimum chamber performance (i.e., spatial field uniformity and accuracy in determining the test field level), especially at the low end of the frequency intended for use, the volume of the chamber should be as large as possible and the ratio of the squares of the chamber's linear dimensions should be as nonrational as possible. Choice of chamber size would be dictated by test volume size requirements, lowest test frequency, and budget considerations.

2.2.2 Chamber Quality Factor, (Q)

The second criterion, that of chamber Q, is established by carefully considering trade-off options. If one has the option of designing and constructing a new shielded chamber, it is advantageous to use solid welded aluminum or copper construction since this will result in a higher Q than if sheet steel is used. Presumably one can always lower the Q of the chamber, if desired, by inserting material such as lossy wall coatings or a limited amount of rf anechoic material. The reason for lowering the chamber Q is to increase the bandwidth of the chamber's modes, thus improving mode overlap and smoothing the EM field uniformity vs. frequency response characteristics, especially at the lower test frequencies. Doing this, however, increases the rf input power needed to generate the required field strengths and reduces the effectiveness of the chamber's tuner to redistribute energy uniformly into modes in all three axes of the chamber. In addition, the time required for the chamber test field to arrive at its steady state condition, after the input power to the chamber is applied, is a function of chamber Q. The higher the Q the longer the settling or charging time. This could have significant implications if the reverberation chamber is to be used for pulsed rf susceptibility testing. Regardless of the metal used in the chamber's construction (aluminum, copper or steel) it should be standard practice to keep the chamber clear of lossy material such as wood or absorbing materials except for special purposes.

2.2.3 Chamber Auxiliary Needs

The third criterion, chamber auxiliary needs, must be established based upon the intended use and the upper test frequency for use. Venting panels should use screens with apertures significantly smaller than waveguide below cutoff at the maximum intended test frequency. Electrical power supplied to outlets inside the chamber, EUT visual monitoring, and EUT operational and functional monitoring requirements are similar to conventional shielded enclosure requirements. A bulkhead panel similar to that shown for the NBS reverberation chamber in figure 2.14 can be used to access the excitation and reference receiving antennas, and the EUT. Care must be taken to ensure that the shielding integrity of the enclosure is not compromised by access holes or cables, etc. This may require the use of high resistance (carbon impregnated) lines [13] or fiber optic links for monitoring the EUT. In addition, waveguides below cutoff access ports can be very useful.

2.2.4 Tuner Design

The fourth criterion is to design the tuner to ensure its effectiveness to redistribute the energy inside the enclosure and hence to tune the field. To achieve this, the tuner must be electrically large ($>\lambda/2$ at the lowest frequency of operation) and be shaped or oriented to distribute energy into all possible modes. Three such tuners are shown in figures 2.15a, 2.15b, and 2.15c. The first tuner (figure 2.15a) was developed by McDonnell Douglas Corp. [2,14,15] after extensive testing to optimize the design for use in their translational electromagnetic environment chamber (TEMEC) facility. The second tuner (figure 2.15b) is used by the Naval Surface Weapons Center in their reverberation chamber [16]. The third tuner (figure 2.15c) is used in the NBS reverberation chamber. The tuner is mounted as shown in figure 2.16, with the blades bent at an angle of approximately 45 degrees to the ceiling to improve its scattering of the field evenly in all directions. The tuner mounting includes a shielded housing with internal metal wipers to prevent rf leakage from the chamber via the tuner shaft to the stepping motor. Details of the housing and motor mounting arrangement are shown in figure 2.17. The tuner controller system which includes the stepping motor and a computer accessed controller, allows movement of the tuner in increments as small as 0.113 degrees (3200 steps per revolution) at rates from seconds up to hours per revolution. The motion was optimized for as smooth a motion of the tuner as possible.

A test to determine how effectively the tuner is functioning is to measure the ratio of the maximum to minimum received power of the receiving antenna as a function of tuner position. This is done while maintaining a constant net input power to the enclosure's

transmitting antenna. The results of such measurements made with the NBS tuner are shown in figures 2.18a and 2.18b. The magnitude of the ratio is dependent upon a number of factors including tuner shape, size, orientation, and the Q of the enclosure. The average value of the maximum to minimum ratio is higher in the empty chamber. (Data for figure 2.18b were obtained with 4 pieces of 66 cm x 61 cm x 61 cm rf absorber placed in the center of the chamber 0.5 meter above the floor). The purpose for inserting the absorber was to simulate a gross loading effect of an EUT placed in the enclosure. A lower loss (ratio) is indicative of a higher Q and more effective mode tuning. This influences the spatial uniformity of the test field (statistically) as is shown in section 2.3. A reasonable guideline for proper operation of the tuner is a minimum tuning ratio of 20 dB.

Multiple tuners have been used in some reverberation chambers [3,6]. Typically they are mounted on opposite walls to improve the stirring of the fields in the chamber. This is especially important if the tuners are flat, thus acting as scatterers in only one plane. The tuner controller system used in the NBS system allows for control of several tuners simultaneously. This may be particularly advantageous if the reverberation chamber is especially large or is compartmentalized (multiple sections). Examples of compartmentalized chambers are a large chamber divided into two sections by a separating wall or a small chamber placed inside a large chamber. Both arrangements have been proposed for using the reverberation chamber method for measuring shielding effectiveness of materials and enclosures [17].

2.2.5 Chamber Excitation and Field Monitoring

The fifth consideration in designing a reverberation chamber EMC measurement system is in the selection and mounting of appropriate antennas for exciting and monitoring the EM fields inside the chamber. The following parameters are used in selecting the antennas:

- a) frequency range of interest,
- b) input power rating (>200 watts),
- c) bandwidth (>10:1 if possible),
- d) minimum VSWR (low as possible),
- e) efficiency for exciting modes inside chamber,
- f) minimum size, and
- g) durability.

The typical frequency range of application is from 200 MHz to 18 GHz or higher. A number of candidate antennas could be used in this range. No single antenna has sufficient bandwidth to cover the full range with the possible exception of the long wire antenna. Based upon the above and, to a certain extent, the antennas available at the Electromagnetic Fields Division of NBS, the following were selected for evaluation.

- a) Long wire antenna (200 MHz - 18 GHz),
- b) Log periodic antenna (200 MHz - 2 GHz),
- c) Monopole antenna (200 MHz - 1 GHz),
- d) Bow-tie antenna (200 MHz - 1 GHz),
- e) Leaky 50 ohm coaxial cable (200 MHz - 1 GHz),
- f) Ridged horn (1.0 GHz - 12 GHz),
- g) Double ridged circular horn (2.0 GHz - 18 GHz).

The efficiency with which energy can be injected into or coupled out of the chamber via transmitting or receiving antennas is determined by: 1) the voltage standing wave ratio (VSWR) of the antennas (i.e., the impedance match between the rf source and the transmitting antenna or between the receiving antenna and its output detector), and 2) the ability of the antennas to couple energy into or out of the particular modes that exist at the test frequencies of interest. Rotating the tuner changes the chamber's boundary conditions and hence, shifts the mode excitation frequencies. This, of course, changes the characteristics of the field inside the enclosure which in turn influences the effective VSWR of the antennas. The Q factor of the enclosure as a resonant cavity also has considerable effect upon the VSWR of the antenna. This is particularly true at frequencies below a few GHz.

The placement and orientation of the transmitting and receiving antennas can also influence the operation of the chamber [18]. Two positions or orientations are recommended: 1) position the transmitting and receiving antennas in different corners of the chamber, oriented toward the corners as shown in figure 2.19, or 2) position one of the antennas in a corner oriented toward the corner, for example the reference receiving antenna, with the other antenna (transmitting antenna) sufficiently far away and oriented toward the tuner. The first

arrangement was selected for use in the NBS chamber. The purpose for these configurations is to couple energy into and out of all chamber modes as efficiently and uniformly as possible without significantly favoring particular modes or favoring a direct path coupled signal between the transmitting and receiving antennas.

Installation of a long wire antenna inside the chamber is different from other antennas because it uses the chamber wall as its ground plane to obtain as close to a 50 ohm impedance as possible. Details for designing the taper transition region of the long wire antenna are shown in figure 2.20. A photograph of the long wire antenna installed inside the NBS chamber is shown in figure 2.21. The long wire extends around two surfaces of the chamber. This is done to achieve, however somewhat limited, the purpose of the locations and orientation configurations referred to above for other conventional antennas.

Based upon the results of data obtained for various antenna pairs selected from the above list, the following four antennas were chosen for use in the NBS chamber in the following frequency ranges:

- 1) Long wire (200 MHz - 1000 MHz), receiving mode,
- 2) Log Periodic (200 MHz - 1000 MHz), transmitting mode,
- 3) Ridged horn (1.0 GHz - 10 GHz), transmitting and receiving modes,
- 4) Double ridged circular horn (2.0 GHz - 18 GHz), transmitting and receiving modes.

Within the recommended frequency bands of operation, the long wire and log periodic antennas can accommodate up to 1000 watts input power, and the ridged horns and double ridged circular horns can accommodate up to 200 watts input power.

A number of preliminary tests were performed to determine the operational parameters of the NBS reverberation chamber using these antennas and to evaluate the interactions between EUT, the chamber, and the rf sources used in performing these measurements. Some of these tests and their results were previously published [19]. The VSWRs and coupling efficiency of these four antennas placed inside the empty NBS chamber are given in figures 2.22 and 2.23. Figure 2.22 shows the maximum, average, and minimum VSWR obtained statistically by measuring return loss from the antennas, operating in the transmitting mode, as a function of tuner position at discrete frequencies from 200 MHz to 18 GHz. The tuner was stepped at 1.8 degree increments (200 steps) through a complete revolution. Figure 2.22a is for the long wire antenna operating over the complete frequency range. Figure 2.22b, is the composite VSWR of three antennas (#2, #3, and #4) used within the frequency bands shown in the figure's caption. In the past a long wire antenna has been used quite extensively as a reference receiving antenna across the full frequency range [4,14,17,]. Its input VSWR is not as low, especially at frequencies above 1 GHz, as for the composite of the three antennas. Also, at frequencies above approximately 2 GHz, rotation of the tuner appears to have a minor influence on the VSWR of the antennas. This feature can have considerable impact upon the decision as to what approach to use in performing susceptibility measurements as discussed in section 4.1 of this report. Figure 2.23 shows the coupling efficiency or loss between the long wire antenna transmitting (200 MHz - 18 GHz), and a composite of the three antennas receiving. This figure is provided for comparison with figure 2.12. The long wire antenna is not as efficient in coupling energy into the chamber and hence, the loss is greater, particularly above 1 GHz.

The quality factor of the chamber as a resonant cavity also has considerable effect upon the VSWR and coupling efficiency of the antenna placed inside, especially at frequencies below a few GHz. This is shown in figures 2.22c and 2.24. These data were obtained with four pieces of 66 cm x 61 cm x 61 cm rf absorber placed in the center of the chamber's test zone. Note the significant reduction in the VSWR variations of the transmitting antenna associated with the substantially lower Q in the enclosure and the significant increase in the chamber loss.

2.3 Determination of Wave Impedance and E-Field Amplitude Distribution Inside Reverberation Chamber

2.3.1 Determining the Test Field and Wave Impedance Amplitudes

The field strength in the chamber can be determined in two ways. The first is to measure the power received by the reference antennas, and then determine the equivalent power density in the enclosure from (8). The equivalent electric field, \bar{E}_a , is then found using the expression,

$$\bar{E}_a = \sqrt{\bar{\eta}' \bar{P}_d} \approx \frac{4\pi}{\lambda} \sqrt{30 \bar{P}'_r} \quad (\text{V/m}), \quad (10)$$

where $\bar{\eta}'$ is the statistically averaged wave impedance in the chamber. This averaged wave impedance is assumed to be approximately equal to 120π ohms. Obviously, the wave impedance inside the reverberation chamber will have large variations as a function of tuner orientation and chamber location. To test the validity of (10), independent measurements were made of the maximum, average, and minimum magnetic and electric fields in the chamber. These measurements were made using a one centimeter diameter loop probe and a one-centimeter long dipole probe. The probes were rotated through three orthogonal orientations aligned with the chamber axes and located at the center of the test zone. The magnitudes of the total magnetic and electric fields were then determined as the square root of the sum of the squared values of each of the three components respectively for both the magnetic and electric fields. The corresponding ratios of the electric-field and magnetic-field amplitudes for a data base of 200 positions of the tuner were then used to determine an "equivalent" wave impedance. The results are shown in figure 2.25. Four curves are given. Three curves show the maximum, average and minimum wave impedance determined as a function of frequency. The fourth curve shows the wave impedance calculated from the ratio of E to H when the electric-field was a maximum. Even though the wave impedance varies widely as expected with frequency, the average wave impedance at frequencies above 200 MHz (the lower frequency limit recommended for this chamber) is approximately 120π ohms. This then, provides evidence that (10) is valid, at least for determining the average E-field in the chamber. The fourth curve was included because, as will be discussed later in this report, the convenient parameter for comparing reverberation chamber with anechoic chamber obtained EUT susceptibility data is the EUT's peak response. This typically corresponds to a maximum electric field in the reverberation chamber. Note that the wave impedance corresponding with the maximum E-field typically is greater than 120π ohms and was found to be as large as 1600 ohms thus contributing to an error as large as 6 dB in determining the maximum E-field if (10) is used.

The second method used to determine the field strength in the reverberation chamber is to measure the electric field using an electrically small dipole probe that has been previously calibrated in a standard uniform field. This is the same dipole probe, referred to above, that was used to determine the chamber's wave impedance. The assumption made in using the probe is that since it is electrically small, the fields measured in the reverberation chamber over the aperture of the dipole will be uniform (i.e., "equivalent" to the standard uniform field used in the probe's calibration); and hence the probe's response will give an accurate measurement of the "equivalent" field strength in the chamber. Results of the measurements comparing the electric-field strength generated in the chamber based upon these two methods are shown in figure 2.26. The maximum and average E-field strength data were normalized to one watt net input power. The agreement shown is typical of the random variations in the data used to determine the field in a reverberation chamber. The systematic offset difference between the field determined using the reference antenna and that determined using the probe is, however, less than 3 dB. This result also strengthens the validity of (10).

2.3.2 Maximum Versus Average Amplitude Responses

Another important observation from figure 2.26 is the approximate 7-8 dB difference in signal amplitude between the maximum and average field strengths. This can be explained simply in terms of the structure of the cavity modes in the chamber [20]. For a cavity of dimensions, a, b, and d, modes in all three dimensions can be represented as

$$\phi_{mnp}(x,y,z) \propto \sin \frac{m\pi x}{a} \sin \frac{n\pi y}{b} \sin \frac{p\pi z}{d}, \quad (11)$$

where x, y, and z correspond to the three orthogonal axes of the chamber and m, n, and p are the associated mode numbers.

An antenna typically responds to a specific field component, or in the reverberation chamber case, to the composite field impinging upon its aperture. However, measured power is related to $\phi_{mnp}^2(x,y,z)$. The maximum value of $\phi_{mnp}^2(x,y,z)$ occurs when each component is a maximum or

$$\text{Max}(\phi_{mnp}^2(x,y,z)) \leq 1. \quad (12)$$

The average value of $\phi_{mnp}^2(x,y,z)$ is given by

$$\text{Ave } (\phi_{\text{mnp}}^2(x,y,z)) = \frac{1}{abd} \int_v \phi_{\text{mnp}}^2(x,y,z) dx dy dz \approx \frac{1}{8}. \quad (13)$$

The ratio of $\text{Max } (\phi_{\text{mnp}}^2(x,y,z)) / \text{Ave } (\phi_{\text{mnp}}^2(x,y,z))$ in the limit then is 8 which corresponds to 9 dB (i.e., this is the theoretical maximum difference that can exist between the maximum and average responses of an antenna or EUT measured in a reverberation chamber). In practice, the mode mixing is not 100 percent efficient to achieve a perfect average nor does one obtain a perfect maximum in all three dimensions. Hence the average difference of 7 to 8 dB shown in figure 2.26 is expected.

In the past, a question regarding the validity of maximum or "peak" reverberation chamber results has been raised. However, this question seems to be resolved as apparent by examining the relationship between maximum and average measurements in the reverberation chamber exhibited in figure 2.26 and from the implications of (12) and (13). These results suggest one can extract one set of data (e.g., average) from the other (e.g., maximum) quite accurately (within ± 2 dB), assuming of course, that the response of the EUT is linear.

2.4 Spatial E-Field Distribution

Tests were made to determine the uniformity of the maximum and average values of the E-field in the chamber as a function of spatial position and frequency. Seven NBS isotropic probes [21] designed to operate at frequencies up to 2 GHz were placed inside the enclosure as shown in figures 2.19 and 2.21. Each probe has three orthogonally oriented dipoles aligned with the enclosure axes. Measurements were made of the field strength of each orthogonal component at the seven locations for each tuner position (200 steps of 1.8 degree increments). The maximum and average values for each component and the corresponding amplitudes were then determined from the complete data set for a normalized net input power to the chamber of 1 watt. The results of these measurements are shown in figure 2.27. These measurements were made in 50 MHz increments from 100 MHz to 2.0 GHz. The spread of the data points show the spatial field variation inside the enclosure at the indicated frequencies. Note at 200-300 MHz the spread and potential errors in determining E-field amplitude is as great as ± 8 dB, decreasing to approximately ± 2 dB at 2.0 GHz. Note also the large difference in the three orthogonal components at frequencies below 150 MHz. This is especially apparent from inspecting figure 2.28 which shows the average values of the seven statistically determined average and maximum E-fields for each component and their composite total determined from figure 2.27. Strong mode structure is indicated in the chamber at frequencies below 150 MHz (i.e., the presence of a dominant mode with its associated directional properties). Hence, there are insufficient modes for proper operation at these frequencies. At frequencies above 150 MHz, the relative amplitudes of the field components are approximately the same and the composite total of the average E-field components is approximately 4.8 dB greater than the individual components. This indicates that the measured value of the average of each component is independent of polarization of the dipole. (i.e., $E_{x(\text{ave})}$ is independent of $E_{y(\text{ave})}$, etc.). Thus,

$$E_{t(\text{ave})} = \sqrt{(E_{x(\text{ave})})^2 + (E_{y(\text{ave})})^2 + (E_{z(\text{ave})})^2} \approx \sqrt{3} (E_{(x,y,\text{or } z)\text{ave}}).$$

The composite total however, of the E-field components' maxima (figure 2.28b) is less than 4.8 dB. This indicates that the maximum measured values for each component are not independent. (i.e., $E_{x(\text{total})}$ is a function of $E_{y(\text{total})}$, etc.). The implication is that if multiple receptors are involved in establishing the maximum susceptibility of an EUT (or for example in measuring the E-field in the chamber by using an isotropic probe with 3 orthogonal dipoles), the difference between the maximum and average response may be less than the typical 7 to 8 dB referred to in section 2.3.

2.5 Multiple Excitation of the Chamber

Electromagnetic fields were generated inside the chamber using two separate antennas simultaneously excited in the frequency ranges, (200-400) MHz, and (1000-2000) MHz. The antennas used for the frequency range (200-400) MHz were a log periodic and a long wire described previously. Two ridged horns were used in the frequency range (1.0-2.0) GHz. The spatial, statistical, E-field uniformity did not improve significantly over using a single antenna excitation in the 200-400 MHz frequency range; however, it did improve slightly (from approximately ± 2 dB to ± 1.5 dB variations) in the frequency range (1.0-2.0) GHz.

The E-field amplitude in the chamber decreased when using two excitation antennas, in both frequency ranges, assuming the same net input power as for a single antenna. The decrease was approximately 1 dB in the frequency range (200-400) MHz and approximately 1.5 dB in the frequency range (1.0-2.0) GHz. This loss however, can be accounted for in the losses in the additional rf transmission line cables and the second excitation antenna (i.e., the antennas are not 100% efficient in converting input rf power to radiated power).

3. Interaction Effects Between Chamber, Source and Reference Antennas, and EUT.

3.1 Placement Constraints of EUT

Constraints on the placement of EUT inside the reverberation chamber are a result of the proximity effect of the chamber walls on the test field and upon the EUT. Measurements were made of the E-field close to the chamber's walls for comparison with measurements made of the E-field within the test zone outlined by the matrix of seven probes shown in figure 2.21. Two locations were selected: 1) 0.5 m from the chamber's side and back wall, 1.0 m above the floor; and 2) 0.12 m from the side wall approximately mid-way between the chamber's ends and 0.5 m above the floor. Location 1 was selected so the EUT test zone would be clear of obstructions but also with the probe far enough from the chamber's walls, hopefully, to avoid significant proximity effects. Location 1 measurements were consistent with the measurements made at the 7 probe locations. Location 2 was selected to determine just how significant the proximity effect is at distances less than one third wavelength (<800 MHz). The average E-field measured at location 2 was approximately 2 dB lower at frequencies from 200 to 400 MHz than the E-field measured in the test zone. The field close to the chamber wall then increased as a function of frequency, approaching the test zone measured field strength at frequencies above 1 GHz. These results indicate a need to maintain a minimum spacing for the reference antenna, field measurement probe(s), and/or EUT of at least $\lambda/3$ from the chamber's walls at the lowest test frequency. This equates to approximately 1/2 meter at 200 MHz for the NBS chamber. An exception to this guideline may be a desired spacing between the EUT and the chamber floor or walls. This spacing may be dictated by the test plan. If the EUT is electrically large (many wavelengths) it may be necessary to have a separation distance from the chamber walls greater than $\lambda/3$ at frequencies where $\lambda/3$ is less than 1/2 meter or greater than 1/2 meter under some test conditions to prevent shadowing effects from influencing the spatial distribution of the test field. Results of scattering effects measurements discussed in section 3.2 suggest shadowing is not a significant problem, if the EUT is placed in the center of the test zone as far from the walls as possible.

3.2 Scattering Effects of Metal Objects upon E-field Distribution

Two test objects were selected to simulate an EUT placed in the chamber to evaluate their scattering effect upon the field distribution inside the chamber. The first object was a solid welded aluminum box 30 cm x 50 cm x 60 cm in size. The second was an electronic equipment rack 56 cm x 67 cm x 114 cm in size. Tests were made to determine the E-field uniformity or distribution over the test zone matrix defined earlier using 6 isotropic probes (figure 2.19) with each of the two test objects placed at the center of the test zone. (The probe at the center of the test zone was removed to accommodate the test objects.) Figures 3.1a and 3.1b show the two test objects placed inside the enclosure. The mean value of the maximum and average values for each E-field component (vertical, longitudinal, and transverse) and their composite total were determined for each of the 6 probes. The results, shown in figure 3.2, give a comparison with the empty chamber E-field distribution measurements shown in figure 2.28. Little or no difference was noted in the statistical (average and maximum) values measured.

3.3 Loading Effects of EUT on Chamber

One of the concerns expressed about using a reverberation chamber for EMC measurements was the realization that if the EUT absorbed energy from the chamber (i.e., demonstrates susceptibility) it would reduce the Q of the chamber and thus affect the measurement results. Typically this is compensated for by simply increasing the net input power to the chamber transmitting antennas as required. This may not be sufficient if inserting the EUT lowers the chamber's Q to the extent that the chamber no longer reverberates or the tuner will no longer sufficiently stir the modes, (i.e., the chamber no longer functions properly). Recall that the absolute amplitude of the test field level inside the chamber is determined from the reference antenna received power measurements. The assumption is that this measurement is unaffected by the loading effect of the EUT. Two simple tests were used to evaluate the loading effect: the first was to insert a 500 MHz, half-wave, resonant dipole near the center of the chamber's test zone to determine if energy coupled from the chamber to the dipole would

reduce the field strength in the chamber. This test was intended to simulate the loading effect of a simple resonant EUT. Field strength measurements were made again using the seven probe matrix and the long wire antenna as a reference receiving antenna to determine the level of the test field, before and after inserting the resonant dipole. A constant normalized input power of 1 watt was applied at the input of the chamber log periodic transmitting antenna to establish the field in the chamber. The following observations were made:

- 1) Energy is conserved (i.e., power coupled from the chamber via the dipole results in a proportional decrease in the E-field in the room).
- 2) The 500 MHz resonant dipole and the long wire receiving antenna coupled approximately the same amount of power from the room.

The seven probe matrix used to determine the spatial distribution of the E-field inside the chamber, also load or reduces the Q factor in a similar fashion to the resonant dipole. Each of these probes couple a small amount of energy out of the test field. In addition, they have lossy transmission lines made up of carbon loaded teflon that serve to convey their detected dc signals to their instrumentation located outside the chamber. These lossy transmission lines increase the chamber's loss up to 5 dB at 2.0 GHz. However, this amount of loss did not seem to significantly influence the ability to determine the field level in the chamber, with or without the presence of the probes by using the reference receiving antenna. The field level simply was lower for the same net input power due to the loading effect of the probes in the chamber.

The second test used to evaluate the loading effect was to place varying amounts of rf absorbing material inside the chamber. This was done to get an indication of just how much loading the chamber could tolerate before it fails to operate properly and/or large errors existed in determining test field level and EUT response. Progressively greater amounts of absorber were added until approximately 90 percent of the net input power was being absorbed (i.e., the chamber loss was increased by approximately 10 dB). The amount of rf absorber required was four pieces of 66 cm pyramidal high performance absorber 61 cm x 61 cm square. Results for tuner effectiveness, VSWR and chamber loss with absorber loading were shown in figures 2.18b, 2.22c, and 2.24. As indicated earlier, lowering the chamber Q reduces the test field level in the chamber for a given net input power. Inserting the 4 pieces of absorber in the chamber lowers the field considerably as shown in figure 3.3. This figure compares the maximum E-field strength in the test volume defined by the 7 probe matrix inside the empty chamber with the field strength after the chamber is loaded with the 4 pieces of absorber.

In summary, the following observations can be made from the data obtained (figures 2.18b, 2.22c, 2.24 and 3.3). Lowering the chamber Q:

- 1) decreases the effectiveness of the tuner (lower Max/ in ratio),
- 2) improves the VSWR of the transmitting and receiving antennas,
- 3) increases the chamber loss and hence increases the rf power required to obtain test fields of the same level,
- 4) increases the uncertainty in determining the test field level and EUT response (indicated by the larger variations in the E-field data obtained with absorber, figure 3.3), and
- 5) decreases the spatial, statistical E-field uniformity.

In conclusion, the following guidelines are suggested. Inserting the EUT should not lower the maximum or average received power from the chamber's reference antenna for the same net input power into the chamber (before and after inserting the EUT) excessively. If these ratios, net input power/received power(max or ave), increase more than 6 dB, or if the tuner's average effectiveness decreases to less than 20 dB, use of the reverberation chamber is not recommended.

4.0 Performing Immunity Measurements

4.1 Planning the Measurements

A number of considerations are important in planning the measurements, writing the test plan, and documenting the test results. One is the amount of data required to accurately

characterize the EUT. Equipment susceptibility to EMI is primarily determined by the degree to which the interference field couples into and interacts with the equipment's components. This undesired coupling is influenced by a number of equipment parameters such as: input/output, power line, and circuit lead impedances and lead lengths; impedances of circuit components (especially those terminating lead wires); type of circuit components (particularly active components); and amount and type of EMI shielding and filtering used. The susceptibility of any particular equipment is usually a function of frequency, suggesting resonance effects within the equipment with its input/output leads and other interconnected equipment. These resonances may be caused, for example, by the reactance of the connecting leads acting as an antenna, coupling with the input impedance of the terminating circuit components. The quality factor (Q) of such a resonant circuit determines the maximum spacing or increment between frequencies at which susceptibility tests must be performed. Automated systems such as required by the reverberation chamber test methods are (by their digital nature) discrete frequency systems. The number of test points one can obtain using such a system are limited by the memory or storage capacity of the computer, the measurement system bandwidth, and the measurement time constraints. Thus, care must be exercised in choosing frequency and amplitude measurement intervals compatible with the test system and the number of test points required.

A second consideration is the test-field time duration versus reaction time of the EUT. Some EUTs have components with relatively slow thermal time constants. This equipment must be exposed to test fields with sufficient duration to allow reaction and interaction; otherwise susceptibility tests may not be true indicators of the equipment's vulnerability. For example, thermocouple devices used to simulate electro-explosive devices may require one to two seconds exposure time for maximum response. EUT soak time requirements influence the approach (section 4.2) selected for performing the tests using the reverberation chamber method.

Another important consideration relates to the need to simulate as closely as possible "real world" operating conditions. Ideally, susceptibility tests should be performed with the EUT connected and operated in its operational environment. Since this, most likely, is not possible, these operational conditions should be carefully simulated. This normally includes making certain the EUT is tested with its wiring harness in the same configuration (as nearly as possible) as when in actual use. (Actually, one of the advantages of the reverberation chamber method is that the test results are independent of EUT wiring harness, input/output and power lead orientation.) In addition, all connecting leads should be terminated with equivalent impedances as when in actual use. Failure to simulate these conditions can result in data that are misleading. An additional problem is the EUT-antenna-enclosure interaction that exists inside any shielded enclosure. Antenna radiation or receiving characteristics are altered when enclosed inside a shielded environment. One should realize that the EUT always interacts somewhat with the exposure field in any environment. What is difficult is sorting out the normal open-field scattering effect from the unknown perturbation effects of the EUT-antenna-enclosure interaction that is typically ignored in shielded room susceptibility testing. Efforts to quantify this effect for reverberation chamber obtained results are discussed in section 5.

How to sense and telemeter the performance of the EUT from the test environment without perturbing the EUT, the test environment or sensitive test equipment is another important consideration. This is usually done by using either fiber optics lines or "invisible" wire [13] (carbon impregnated Teflon) with appropriate readout devices.

Finally, one obvious purpose for performing susceptibility tests is to determine EUT compliance with pre-established performance criteria. For production item sampling, a worst case EMI exposure environment with pass-fail criteria may be appropriate. However, for engineering development of EMI-hardened equipment or for correcting EMI problems discovered in existing equipment, diagnostic testing is needed. This type of testing requires knowledge of the exposure field parameters, such as: frequency, repetition rates, and wave shape of test signal; type and percent of modulation imposed; and polarization, amplitude and signal waveform time variations. These parameters must be carefully selected, as part of the test plan, controlled, and (for some tests) statistically characterized for the testing to be meaningful. One obvious limitation of the reverberation chamber method for susceptibility testing is the loss of polarization information. However, this is in part compensated for because worst case response characteristics of the EUT can be determined without repositioning or orienting the EUT in the reverberation chamber since the test field is rotated around the EUT. If carefully controlled tests are performed, resonances and susceptible EUT circuit components can be determined, from which cause and effect relationships can be established. These can then be modified or eliminated to improve the immunity of the EUT. Another

important consideration in performing diagnostic testing is the desirability of determining how the EMI is coupled into the EUT. This requires separating, if possible, the sources of interference reception, such as EUT input/output and power line leads, leakage through the EUT case housing, or internally generated and coupled EMI. This can be achieved by a systematic process of shielding and filtering various leads and functional sections of the EUT's circuit, etc., while conducting the susceptibility tests.

4.2. Measurement Approach (Tuned vs. Stirred)

Two approaches are used for performing EMC measurements using the reverberation chamber. The first approach, mode tuned, steps the tuner at selected, uniform increments, permitting measurements of the net input power, reference antenna received power, field measuring probe response and the EUT response at each tuner position. This allows corrections and normalization of the received power, field measurements and EUT response to be made for variations in the net input power to the chamber. These variations are due to changes in the input VSWR of the transmitting antenna as a function of the tuner position. The number of tuner steps per revolution that must be used is a function of frequency and chamber Q. Typically, at least 200 steps or more are required to provide sufficient sampling to accurately determine the statistical parameters of the test field and EUT response (maximum and average amplitudes). If the sample size is too small, the fidelity of the measurements suffers and true maxima, minima, etc. are not recorded. The mode tuned approach also allows the operator to select long test field exposure times as needed to accommodate some EUT response times.

The second approach, mode stirred, rotates (steps) the tuner continuously while sampling the reference antenna received power, field probe response and EUT response at rates much faster than the tuner revolution rate. These measurements are made using a spectrum analyzer, diode detectors, and "smart" voltmeters with their own microprocessors capable of data storage and calculation of statistical functions such as mean values and standard deviations. The mode stirred approach allows large data samples (up to 9,999) for a single tuner revolution. Tuner revolution rates are adjusted to meet EUT response time and output monitor response time requirements. Typical revolution periods are from 1 to 12 minutes. This large sample, as compared to mode tuned, improves the accuracy in determining the statistics of the measured parameters, however, at the expense of increased uncertainty due to failure to correct for net input power variations.

Hence a trade-off exists between mode tuned and mode stirred operation. An examination of figure 2.22 suggests this trade-off occurs approximately between 1-2 GHz. (i.e., The mode tuned approach would be more accurate below 1-2 GHz where the mode density is not as great and corrections can be made for variations in the net input power caused by large variations in the input VSWR of the transmitting antennas. Mode stirring is more accurate at frequencies above 1-2 GHz where VSWR variations in the transmit antenna as a function of tuner position are small and large data samples of the test field and EUT response can be taken.)

4.3 Measurement System

4.3.1 Measurement Setup and Instrumentation Requirements

A block diagram of the basic NBS reverberation chamber EMC measurement system is shown in figure 4.1. The test field is established by means of rf source(s) connected to transmitting antenna(s) placed inside the chamber. Antennas used are discussed in section 2.2.5. Modes excited inside the chamber are then tuned or stirred by rotating the mode tuner which functions as a field-perturbing device. The EUT may be placed anywhere convenient within the chamber provided no point on the EUT is closer than 1/2 meter to any wall, or ceiling. Placement relative to the floor is dependent upon a number of factors including intended use configuration relative to ground-planes etc., and should be specified by the test plan. Test, power, and control cables are routed to appropriate monitors, etc., outside the chamber via shielded or filtered cables and feed-through connectors, high resistance lines, and fiber optic lines as required to prevent leakage of fields to the outside environment. Note that a precision 10 dB attenuator is used with the power detector or spectrum analyzer, whenever possible, to measure the receiving antenna power. This is done to minimize impedance mismatch with the receiving antenna. The calibrated bidirectional coupler at the input to the transmitting antenna allows measurements of the net input power so corrections can be made for changes in net input power resulting from antenna-rf generator impedance mismatch and rf generator output variations that occur during the rotation of the tuner. As referred to earlier, these corrections are made when using the mode tuned measurements approach for each incremental change in tuner rotation. For mode stirred, the net input power is measured only

at the beginning of the measurement cycle. Details of how the measurement cycle proceeds under computer control, how the data are managed, recorded, and processed for presentation are contained in the next section describing the software used for these functions.

4.3.2 Software Requirements and Measurement Procedures

The computer code used in the evaluation of the reverberating chamber has evolved from simple routines that record only the measurement data to the present complex programs that have abilities to recover from many common system failures and operator errors. The more sophisticated programming is made possible by using modern laboratory computers containing large amounts of memory. The primary function of recording the measurement data however, remains unchanged and is outlined in this section, with some discussion of the supporting activities and refinements.

A general overview of the software is shown in figure 4.2. The major tasks of accumulating data using the two primary methods (mode tuned and mode stirred), saving the measured results, and preparing the data graphics are shown. The measurement routines are supported by the module entitled System Calibrations. The data library is not actually program code, rather it indicates data storage that is available to the Data Graphics program and is added to by the measurement programs. Two major programs, detailed below, are used to implement the measurement approaches. They are quite different in how the instrumentation is programmed and the data managed and will be discussed separately. The basic computer code defining these measurements is listed in appendix A. The listings contain the details of the measurements as shown in figures 4.3 and 4.4. The instrument control modules have been omitted to avoid excessive detail.

Mode-Tuned Approach

The flow diagram for the mode-tuned measurement program is given in figure 4.3. This diagram is used to assist in guiding the operator systematically through the measurement procedure.

Step 1. Place the EUT inside the chamber and access it as required for operation and performance monitoring.

Details for placement of the EUT and accessing it are contained in sections 3.1, 4.1, and 4.3.1. The EUT should be placed at least one half meter away from the outer walls of the chamber unless specified in the test plan to simulate proximity to a ground plane.

Step 2. Connect the measurement system as shown in figure 4.1.

Step 3. Specify measurement and calibration parameters.

Calibration factors for the cables and directional couplers used must first be tabulated and stored in the computer for later access. All parameters used in the measurements are then specified using a menu of items from which the operator may select the values for the experiment. These parameters include: frequency range and increments, number of tuner steps, signal generator output level as required to obtain the desired field strength inside the chamber, the EUT output voltage considered as an upper bound for maximum safe EUT operation, and an estimate of the response time of the EUT. The experiment description, operator's name, and the system clock can be accessed in the menu also. When the operator is satisfied with the parameter values and exits the menu, these values plus all calibration values (e.g., cable loss, coupling factors, etc.) are tabulated for reference. The measurement hardware is then initialized and the measurement begins.

Step 4. Perform the measurement (automated measurement sequence).

The measurement sequence can be traced in figure 4.3. At the beginning of each test all the instruments are set to zero (if there is an internal auto-zeroing feature) or a reading is taken to determine the offset from zero with the field removed. These offset readings are then used to adjust the readings taken with the field applied. This should be done as often as needed to minimize errors resulting from zero drift.

It is important to have reached both mechanical and electrical stability at each step of the tuner before reading the instruments. As the mechanical time constant of the stepping motor and the chamber's tuner blades is typically much longer than the electrical response time of the measurement instrumentation or the EUT, the most efficient manner with which to

collect the data is to minimize the movements of the tuner. Any given measurement usually involves a sequence of frequencies at which to measure the response of the device. This routine is designed to collect the data for all frequencies at each tuner step before moving the tuner to another location. The data is then rearranged at the conclusion of the measurements such that data from all tuner positions for a given frequency is together before it is processed for final graphic presentation.

After the instruments are zeroed and their offset voltages recorded, the rf power is applied and the response of all devices which could be damaged by excessive field strength is measured. This checking is done as rapidly as possible for each frequency and provides one level of protection for the system. Typically, the operator should specify power levels that are appropriate for the EUT(s) being tested. Then this test will detect only those conditions which cause an unusually high response.

With the initial checking done, the program then proceeds to read the remaining instruments in the system. These include power meters, digital voltmeters, spectrum analyzer, specialized data acquisition systems, and/or any other monitoring device being used.

As mentioned above, all frequencies of interest are measured before the tuner is moved to the next position. There are many possible ways to group this data and save it on a mass storage device. The approach used here is to maintain all the data for a given tuner step (or several steps) together in one file. This file can then be recalled and the data rearranged such that all the information for a given frequency is together. Saving the data frequently allows the measurement to be continued, without starting over, should the system lose power or a fatal error occur.

The routines necessary for operation of the instruments are, of course, unique to the device but some general concepts are useful to discuss:

- a). The program should exercise some care to insure the validity of the readings. Most instruments will allow access to a status byte that will indicate many failures common to the device. This can be monitored during the read cycle and action taken if the measurement is not valid. Action is also necessary if the device fails to respond or hangs the interface bus. These situations may require operator assistance, but the program should be able to recover and repeat the operation if the condition is temporary.
- b). Readings taken within the limits of the instrument yet too quickly for the rest of the system to respond, for instance the tuner may still be vibrating or the sensor may be slow to respond, will cause erroneous results. For these measurements where the field being monitored is generated by a cw signal of constant amplitude, the response of a device should settle to a constant value, provided the tuner has stabilized and the device has had enough time to respond. The computer should be able to determine when to accept the reading based on the factors mentioned. One method is to install fixed wait statements that guarantee steady conditions. A more dynamic approach is to monitor the device and compare readings until steady conditions are reached. This optimizes the already lengthy measurement by avoiding long idle times that may not be necessary. A refinement to simply comparing readings is to compare the averages of several readings grouped together, referred to as a running average. This has a tendency to smooth noise that may be on the signal and also to make comparisons of low level readings (near the noise floor) more stable.

Step 5. Correct the data by applying the system calibration values and zero field offset readings.

The correction factors are applied to the measured quantities at the time the data are taken and key items are calculated. These items are then stored in the memory for later use in compiling the data. Items may include incident and reflected powers to the transmitting antenna corrected for cable loss and coupling factors, power received from the reference antenna (corrected), etc. Care must be taken at the beginning of the measurement to assure that calibration factors and cable loss correction to be used match the physical setup.

At the completion of the last tuner position, with all the data residing in mass storage, the measurement routine is complete. The remaining tasks are independent programs, freeing the measurement system for other measurements.

Step 6. Compile the corrected data by frequency, normalize to a constant net input power (for example 1 watt), perform the statistical calculations and present final results.

Normalization of the corrected measurement data for determining: a) the E-field in the chamber, and b) the EUT response, for a constant net input power is done for each tuner position. First the corrected net input power is determined and compared to the desired normalized value. The difference is then used to shift the corrected received power measurements and EUT response measurements as if the actual net input power had been the desired normalized value. This may involve a simple linear extrapolation as is the case for linear detectors, or it may require calibration of the nonlinear response characteristics of the received power detectors and/or EUT monitors thus resulting in appropriate corresponding nonlinear corrections.

The statistical calculations are performed using the corrected, normalized data. These calculations include the maximum, average, and minimum values as appropriate, of the desired parameters (net input power, received power, EUT output response, etc.). The calculations are made using data sets obtained by using the corrected normalized data at the selected number of discrete tuner positions for one complete revolution of the tuner, at each frequency of interest. These result are then, typically, presented in graphs as a function of frequency.

Mode Stirred Approach

The mode-stirred measurement (figure 4.4) begins in a similar manner to the mode-tuned discussed above. The automated measurements sequence of events is somewhat different and hence some of the parameters necessary for performing mode-stirred measurements differ from mode-tuned.

Step 1. Place EUT inside the chamber and access it as required for operation and performance monitoring.

This is the same as for mode tuned.

Step 2. Connect the measurement system as shown in figure 4.1

This step is similar to the setup for mode tuned except the spectrum analyzer is used to measure the reference antenna received power and the EUT monitors must be fast sampling devices such as "smart" voltmeters referred to earlier.

Step 3. Specify measurement and calibration parameters.

These parameters are similar to the mode tuned case with the following two exceptions:

- a) The specification of revolution time for the tuner determines the sample size and sampling parameters associated with the EUT monitoring equipment. Tuner steps (sampling size) are now given as a function of time for one complete revolution of the tuner from which the number of samples that will be taken during that single revolution, for each of the sampling instruments, is determined. These numbers require careful timing trials prior to automating a mode-stirred measurement. The instruments used for the tests detailed in this report, "smart" digital voltmeters, are capable of performing statistical operations on a large number of samples (up to 9999) using a single trigger command. This feature is very convenient for this type of measurement but requires that the number of samples needed to synchronize rotation time of the tuner and total sampling time of the voltmeter be known prior to triggering the measurement. The time required for taking each sample voltage varies slightly with the amplitude of the signal measured. This makes it difficult to estimate accurately the total time required for any given number of samples. Approximations are used and the program adjusts the sample count to insure the correct sampling time for a complete revolution. The sampling should be completed as near to the end of the tuner revolution as possible to avoid weighting the statistics with an incomplete data set or data taken as the tuner begins a second revolution. Typical rates for tuner rotation are in the range of 1 to 12 minutes per single revolution.
- b) The signal generator output level is now a range of values because this program has the ability to search for an optimum response of the device. The range of response values is also accessible in the mode-stirred menu and gives the operator control over minimum readable output from the EUT and also the level considered as the upper safe limit. The program will attempt to keep power levels adjusted such that the response is at some point above the minimum and never above a maximum.

Sometimes it is advantageous to monitor the EUT response using analog devices such as an xy recorder. If care is taken to insure that the response time of the recorder is short compared to the sampling rate or rotation rate of the tuner, the EUT output can be monitored in real time, thus allowing optimization of the sample rate to correspond to the EUT response time. Care must be taken to insure adequate sample time, otherwise the EUT response will be clipped yielding inaccurate results. This condition is easy to detect from the analog output plots and hence avoid.

When the operator is satisfied with the parameter values and exits the menu, these values plus all calibration values (e.g., cable loss, coupling factors, etc.) are tabulated for reference. The measurement hardware is then initialized and the measurement begins.

Step 4. Perform the measurement (automated measurement sequence)

The measurement sequence is shown in figure 4.4. At the beginning of each test all the instruments are set to zero (rf power is off), if possible, or the zero offset is recorded the same as for the mode-tuned approach. The rf power is then applied at the lowest specified level, the tuner motion is activated, and the EUT response is monitored. This first measurement attempt, at each specified frequency, results in a search for a threshold response from the EUT. If the EUT's response is below the preselected level, the rf power is increased in 1 dB increments and held constant allowing the tuner to rotate a few degrees, while searching for the threshold level. If the threshold value for the EUT's response is not reached, the generator level is increased again and the searching process repeated until the threshold level is reached or the maximum range selected for the generator output is achieved. Upon finding an acceptable power level, the instruments are triggered to begin a measurement cycle. Typically the instruments used include "smart" digital voltmeters as mentioned earlier and a spectrum analyzer looking for a peak response from the reference antenna. Any specialized detecting device would also be included. The response of the EUT is constantly monitored via a second fast sampling voltmeter (in addition to the "smart" voltmeter doing the statistics) to protect it from overload. If, during the test, the response should exceed the maximum safe value so that the power level is decreased or any other error condition is detected, the program will remember the correct power level to be used as the measurement is restarted.

At the time all the instruments are done sampling, the program checks to see if the tuner completed a full revolution before the measurements (sample) were finished. A comparison of the times taken for the tuner revolution and each meter's total sampling time is made. If these values agree to within a given tolerance and no other errors were detected, then the numbers are assumed to represent a valid measurement. On the other hand, if these conditions are not met, the sampling parameters are adjusted and the entire measurement process is repeated for the same frequency. Special care taken in the preparation of these sample parameters, as mentioned earlier, will minimize the need for repeat measurements.

The results from all the instruments are now read into the computer, corrected using the appropriate calibration factors and the necessary calculations are made. This includes the statistical parameters for the EUT monitored data, as determined by the "smart" voltmeters, and the peak value of the received power from the reference antenna as measured using the spectrum analyzer. Caution must be exercised if the test field is modulated since this may influence the accuracy of the measurement results depending upon the detector(s) response characteristics. The reference antenna received power data can be used to determine a normalized response for the EUT based upon a constant test field level as a function of frequency if desired. The net input power delivered to the chamber is measured after the acceptable power level is established at the beginning of the measurement cycle, just prior to triggering the "smart" voltmeters. These measurements may then be used to normalize the data to an equivalent constant input power level preselected for all test frequencies if desired. The entire process is then repeated until all frequencies have been measured.

The process by which the statistics are derived for the parameters monitored by the "smart voltmeters" consists of the following steps: 1) the measured analog data is converted to digital form; 2) the first data value is stored for future reference; 3) the second and subsequent data values are compared to the previous data values to determine maximum, minimum, and the running total values; 4) at the conclusion of the data collection, (completion of the data sample) the running total is divided by the sample size to calculate an average value for the data set; and 5) finally, the maximum, minimum, and average values stored in the "smart" voltmeter are transferred upon command to the computer for mass storage and future use as required.

Step 5. Compile the corrected data and present final results.

Data obtained using the mode stirring approach is not normalized at each tuner position. Corrections applied to this data to normalize it to a specified value of net input power must be applied to the maximum, average, and minimum values as determined by the "smart" voltmeters (EUT and other monitored responses) or the maximum value (reference received power) as determined by the spectrum analyzer. Correction made to the data for cable loss, etc., must also be made in a similar way. After these corrections are made, the data is compiled by frequency and presented typically in graph form usually showing only the maximum values as a function of frequency. For example see figures 5.15 and 5.16.

5. Experimental Test Results

5.1 Correlation of Results to Anechoic Chamber Tests - Some Examples

This section describes efforts to estimate a "correlation factor" between reverberation chamber and anechoic chamber obtained results. This was done first for reference standard EUTs and then for an EUT more typical of operational equipment. Tests were performed using the NBS reverberation chamber and a 4.9 m x 6.7 m x 8.5 m anechoic chamber also located at NBS. The EUTs included in this study are: 1) a one centimeter dipole probe antenna (200 MHz to 18 GHz), 2) a ridged horn antenna (800 MHz to 10 GHz), 3) a series of rectangular coaxial transmission line (TEM) cells with apertures, (200 MHz to 4000 MHz), and 4) a modified 7.0 cm (2.75 ") folded fin aircraft rocket, (FFAR) (200 MHz to 12.0 GHz).

5.1.1 Description of Anechoic Chamber Measurement System

A block diagram of the NBS anechoic chamber EMC measurement system is shown in figure 5.1. The test field is established inside the chamber by means of an rf source connected to a standard gain transmitting antenna. This "standard field" is computed from [22]

$$E = \frac{\sqrt{30 P_{\text{net}} G}}{D}, \quad (14)$$

where P_{net} is the net power in watts delivered to the transmitting antenna, G is the effective gain for the transmitting antenna, and D is the separation distance in meters. Equation (14) assumes far-field conditions for a field point on axis of the transmitting antenna so that G is the maximum power gain.

The net power, P_{net} , is determined using calibrated power meters and bidirectional couplers from the expression

$$P_{\text{net}} = P_{\text{inc}} CR_F - P_{\text{ref}} CR_R \quad (15)$$

where P_{inc} is the forward incident power, P_{ref} is the reverse reflected power measured on the sidearm of the coupler, and CR_F and CR_R are the forward and reverse coupling ratios for the coupler referenced to its output port.

The transmitting antennas used are open ended waveguides (200 to 500 MHz) and standard gain horns (500 MHz to 18 GHz).

Comparisons of the response or susceptibility characteristics of EUT (or antennas) obtained using an anechoic chamber and a reverberation chamber are typically made in terms of peak values. The main reasons for this are that typically the EUT's worst case performance or susceptibility is desired, and the practical consideration of the difficulty in obtaining a true average response for an EUT from anechoic chamber data. Even determining the EUT's peak response in an anechoic chamber (depending of course upon how well behaved the EUT radiation pattern characteristic is) can require considerable measurements involving complete pattern measurements.

5.1.2 Measurement of the Peak Response of a 1 cm Dipole and a Ridged Horn

A comparison of the peak output response data obtained for the 1.0 cm dipole using the NBS reverberation and anechoic chambers is given in figure 5.2. Note that the probe output response in the anechoic chamber is greater, in general, by about 2.5 dB than its output in

the reverberation chamber. This suggests that the correlation between the results may be related to the EUT's gain characteristics in the two chambers (i.e., the gain of the dipole probe in free space is approximately 2.5 dB). Determination of a far-field gain for a complex receptor (for example the EUT described in section 4.3.4) is extremely difficult. Therefore, a simple, well defined broadband receiving antenna (a ridged horn) was used as an EUT to repeat similar tests performed for the 1 cm dipole. The horn is designed to operate in the frequency range 800 MHz - 10 GHz. For these measurements in the anechoic chamber, the peak response (peak received power) of the horn occurs when the horn is bore-site aligned and polarization matched with the source antenna. These measurement results were then compared with the horn's peak received power in the reverberation chamber with the same level exposure field. The results are shown in figure 5.3a. Note that the horn's response is greater in the anechoic chamber. To see if this difference corresponded to the difference in the gain characteristics of the horn in the anechoic chamber, as compared to that in the reverberation chamber, the horn was calibrated to determine its far-field gain in the frequency range 800 MHz - 10 GHz. These results are shown in figure 5.3b. Again, note the general agreement between the difference in the horn's response measured in the two facilities and the horn's far-field gain.

5.1.3 Measurement of RF Coupling Through Apertures in TEM Lines

Measurements were made using the reverberation and anechoic chambers to evaluate the rf coupling through apertures cut into a series of TEM cells or transmission lines. Three TEM cells were used. Similar models (EUTs) have been used for evaluating shielding effectiveness of connector assemblies [23]. Electromagnetic energy coupled through the aperture in the TEM cell when exposed to the test field excites the fundamental TEM mode inside the cell. This results in rf power conducted to the cell's output ports which can then be measured. These results are compared with the theoretically predicted values based upon a planar field exposure to determine degree of correlation. The results obtained for one of the TEM cells, shown in the photograph of figure 5.4, are given in figure 5.5. The dimensions for this cell are 12 cm x 18 cm x 36 cm with a 5.1 cm x 5.1 cm aperture centered in the top of the outer conductor. The theoretically predicted peak coupling for a uniform field exposure is also shown on figure 5.5 [24]. Measurements were not made in the anechoic chamber at frequencies below 500 MHz because of the limitations of the anechoic chamber measurement system. The theoretical peak values should be essentially the same as the measured values in the anechoic chamber. Again, the anechoic chamber peak data are generally higher than the peak reverberation chamber data. Also, the average reverberation chamber data are approximately 7-8 dB lower than the peak data, similar to both the 1 cm dipole and ridged horn results.

Results obtained for the second cell, shown in figure 5.6, are given in figure 5.7. The dimensions for this cell are 12 cm x 12 cm x 24 cm with a 3.1 cm diameter aperture. The results are similar to those shown for the larger cell. Results obtained for the third cell, shown in figure 5.8, are given in figure 5.9. The dimensions for this cell are 3.0 cm x 6.0 cm x 11.4 cm with a 1.4 cm diameter aperture centered in the top of the outer conductor. Again the results are similar.

5.1.4 Measurements of the EM Susceptibility of a Modified 7.0 cm Folding Fin Aircraft Rocket (FFAR) [25].

A 7.0 cm diameter FFAR was modified with a thermocouple element to sense the response of the rocket's inserted electro-explosive device (EED). This was done to allow measurement of the rf current coupling into the EED's bridge wire circuit when the rocket is exposed to an rf field. The rocket was also modified with a 1.27 cm plastic spacer at the base of its fin (on the tail section) to increase the rf coupling to the bridge wire circuit. This lessened the requirements for high rf power to generate fields sufficient to perform these measurements. This modification was justified, realizing the purpose of this study was to compare susceptibility results obtained for the rocket in different environments and not to simply evaluate an EUT's susceptibility to EMI. Photographs showing the rocket placement inside the NBS reverberation chamber and the NBS anechoic chamber are shown in figures 5.10 and 5.11. Measurement results of the rocket's thermocouple peak output current resulting from rf coupling as a function of frequency are shown in figures 5.12a and 5.12b. These data were obtained using exposure fields normalized to 10 mW/cm² in each of the chambers. The anechoic chamber data were obtained by rotating the rocket in azimuth in a planar far-field using both vertical and horizontal polarizations. The rocket was rolled a few degrees around its axis before each azimuth cut. Sufficient roll angles were used to determine the peak response. Examples of pattern data obtained in the anechoic chamber at three selected frequencies are shown in figure 5.13. A total of 719 patterns were obtained in the anechoic chamber from

which the peak response at each frequency was determined. These data were then used to plot curve A of figure 5.12a. Curve A (anechoic chamber data) indicated greater response or more susceptibility, except at one frequency (1800 MHz), than curve B (reverberation chamber peak response). Again, the proposed explanation for this is the difference between the gain characteristics of the rocket's response in the anechoic chamber (for example see figure 5.13) and its gain characteristics in the reverberation chamber. The rocket gain is lost in the reverberation chamber. Figure 5.12b shows the difference between curves A and B for figure 5.12a.

5.2 Comparison of Results Between Reverberation Chambers

Measurements were made of the EM susceptibility response of three different EUTs, using two additional, similar, but different size reverberation chambers. These measurements were made to give an indication of the repeatability in measurement results obtained using the same technique (reverberation chamber methods) but with totally different facilities. The second and third reverberation chambers are located at the Naval Surface Weapons Center, Dahlgren, Virginia. These chambers were made from a single large shielded enclosure partitioned into two compartments with a removable center panel. The two chambers consist of: 1) the half chamber, 3.51 m x 5.18 m x 5.86 m in size using a little over half of the full enclosure, and 2) the full chamber, 3.51 m x 5.18 m x 10.82 m in size, using the full enclosure. The NSWC enclosure was constructed of continuously welded steel sheeting similar to the NBS enclosure. Two basic insights are provided by a comparison of results obtained from the evaluation of these different enclosures. First, that the input power requirements of a chamber is a function of its size and can be estimated based upon the calibration of a chamber of similar construction. Second, susceptibility test results obtained for the same EUT in different reverberation chambers are comparable. These conclusions are demonstrated in figures 5.14 to 5.17. Figure 5.14 shows a comparison of the fields inside the NBS and NSWC chambers calculated from the chamber's reference antenna received power measurements and then measured by a calibrated 1 cm dipole probe. The net input power was normalized to one watt for all three chambers. Note that the field inside the NBS chamber is approximately 4 dB stronger than the NSWC half chamber and 6 dB stronger than the NSWC full chamber. Recall that the power density inside a second chamber can be estimated from a calibrated chamber by using (9). The ratio of the average power densities for the NBS to NSWC full size chamber for the same net input power (see section 2.1) was 3.22. This is equal to approximately 5 dB, a little less than that indicated by comparing figures 5.14a and 5.14c, but still within reason.

The second point of obtaining comparable susceptibility results using different chambers is demonstrated in figures 5.15 to 5.17. These graphs show the comparison in measuring the responses of the NBS 1 cm dipole probe and a rectangular single ridged horn to a normalized 37 dB V/m field inside the three different chambers and the peak response of the 7.0 cm FFAR to a normalized 10 mW/cm² power density inside the NBS and the NSWC half size reverberation chambers. In general, the agreement is within measurement tolerances except at 200 MHz for the FFAR. This frequency approaches the lower limit for using the reverberation chambers and is also where the FFAR is most susceptible and hence where one would expect the greatest difference.

6. Summary and Conclusions

6.1 Conclusions Drawn From Study

1. The practical lower frequency limit for using the NBS enclosure as a reverberation chamber is approximately 200 MHz. This lower limit is due to a number of factors including insufficient mode density, limited tuner effectiveness, and ability to uniformly excite all modes in the chamber. These factors are a function of both chamber geometry and size. Increasing the inside dimensions of the chamber will lower the useful frequency limit in an approximately proportional manner.
2. Spatial variations in the E-field maximum and average values determined in the chamber's test volume are:

Frequency (MHz)	Variation in Measured E-Field
200	<± 8 dB
500	<± 5 dB
1000	<± 3 dB
2000	<± 2 dB

These data were determined using the mode tuned approach with 200 tuner increments for one complete tuner revolution. The limitation for determining the spatial E-field variation is most likely due to the increasing mode density and hence field complexity in the chamber as a function of frequency and the insufficient sampling of the field resulting from the limited number of tuner positions used. The spatial E-field variations should decrease less than 2 dB at frequencies above 2 GHz if sufficiently large data samples are taken.

3. Using a combination of antennas within their specified design frequency ranges for transmitting and as reference receiving antennas inside the chamber is preferred to the use of a long wire antenna. This is apparent because of the lower VSWR and greater efficiency in exciting the chamber and coupling energy from the chamber.
4. E-field data obtained using the mode stirred approach with the chamber empty have significantly less amplitude variations with frequency than data obtained using the mode tuned approach, particularly at frequencies above 1-2 GHz (e.g., <3 dB rather than <6 dB. Compare figure 2.26 to figure 3.3.) This implies that the mode stirring method is superior for some applications above these frequencies. This is significant since the stirred method is much simpler and faster to use. In comparing the two methods it is interesting to note the difference in the amplitude of the maximum fields at frequencies below 1-2 GHz. The mode tuned method is more accurate at these frequencies for determining the absolute amplitude of the test field since it allows for corrections due to changes in antenna VSWR. Because of these observations and other supporting data, the best results (accuracy versus measurement time considerations) for the NBS reverberation chamber can be obtained using the following approaches and tuner positions for susceptibility testing:

Frequency Range	Method	# Tuner Positions or Samples
0.2-1.0 GHz	Mode Tuned	200
1.0-2.0 GHz	Mode Tuned	400
>2.0 GHz	Mode Stirred	5000

5. Lowering the Q of the enclosure: a) increases the rf power required to obtain the test field, b) increases the uncertainty in determining the test field level, and c) decreases the spatial, statistical field uniformity.
6. The statistically determined average wave impedance of the EM field in the chamber is approximately that of free space (377 ohms), thus confirming the validity of (10).
7. The maximum E-field is approximately 7 to 8 dB greater than the average E-field.
8. Scattering from the EUT does not seem to influence the statistical, spatial E-field distribution within the chamber.
9. Multiple source excitation (from more than one location) improves the spatial E-field distribution slightly, but not enough to justify additional hardware requirements and the additional rf power needed to compensate for the loss in the additional input transmission line required.
10. Energy is conserved in the chamber (i.e., power coupled from the chamber via loss in transmission lines, antennas, EUT, physical support materials, etc., reduce the power density in the chamber. Thus it is good practice to remove all that are not essential to the tests from the chamber.
11. The chamber (NBS) continues to operate (as a reverberation chamber) with loading that reduces the Q significantly (up to 90% of the total energy absorbed), however, with significant loss in measurement accuracy.

6.2 Summary of Measurement Uncertainties

6.2.1 Determining the Field Strength Inside the Chamber

Recall from section 2.3.1 that the susceptibility/vulnerability test field established inside the chamber can be expressed either in terms of an "equivalent" power density (8) or an "equivalent" E-field strength (10). An estimate of the uncertainties in each of these quantities can be obtained by analyzing the contributing parameters involved in each

mode-tuned and mode stirred approaches respectively, within their appropriate frequency bands. Five major categories are identified. The first is the uncertainty in determining the received power from the chamber's reference antenna. This is broken up into four components: namely, cable loss, attenuator calibration, reference antenna efficiency and power meter or spectrum analyzer measurements uncertainties. Values shown are typical of estimated uncertainties stated for these type of measurements and instruments.

The second category is the impedance mismatch error that can occur between the reference receiving antenna(s) (source) and the power detector(s) (load). The actual power delivered to the load is a function of the impedance match between the source and load, with maximum power transfer occurring when a conjugate impedance match exists.

Power transfer between a source and a load is given as

$$P_f = \frac{\text{fraction of maximum available power absorbed by the load}}{\text{by the load}} = \frac{(1 - |\Gamma_S|^2)(1 - |\Gamma_L|^2)}{|1 - \Gamma_S \Gamma_L|^2} \quad (16)$$

where Γ_S and Γ_L denote complex reflection coefficients. The magnitudes, $|\Gamma_S|$ and $|\Gamma_L|$ can be obtained from the appropriate VSWR by the expressions

$$|\Gamma_i| = \frac{VSWR - 1}{VSWR + 1}, \quad i = S \text{ or } L.$$

The VSWRs for the reference antennas (sources) and power detectors (loads) used in the NBS reverberation chamber are given in table 6.3. These values were used to calculate the estimated uncertainties shown for the mismatch error in tables 6.1 and 6.2. Note that different average and maximum values are given.

The third category of error, referred to as mixing or sampling efficiency, is divided into two parts. The first part relates to the ability to obtain a uniform spatial field distribution (statistically) inside the chamber and to effectively destroy the polarization characteristics of the exposure field. (i.e., the statistically determined response characteristics of the EUT and chamber reference antenna are independent of their directional properties.) The second part is the uncertainty due to limiting the number of tuner positions per revolution when performing the measurement. This source of uncertainty is different when determining the average as compared to the maximum field as shown in the tables. Data shown in figure 2.27 and table 6.4 were used in obtaining these estimates.

The fourth category of uncertainty relates only to determining the equivalent E-field strength in the chamber from the equivalent power density. Recall that (10) assumes that the equivalent wave impedance inside the chamber is 120π ohms. In reality this is not true as was shown in figure 2.25. This figure was then used to provide an estimate for this error taking into account that a significant amount of data obtained to date indicates that peak fields are approximately 7-8 dB greater than the average field strength inside the chamber (see section 2.3.2). i.e., An examination of figure 2.25 shows values of wave impedance as large as 1600 ohms at frequencies below 500 MHz when the maximum E-field was measured. This would require a large correction, up to 6.3 dB. However, experience indicates that a well behaved relationship (7-8 dB difference) exists between the measured peak and average values of the E-field. This suggests that the peak value of the wave impedance for maximum E-field inside the chamber decreases as the frequency increases thus lowering this source of error. These observations are reflected in the uncertainty estimates shown in the tables.

The fifth source of error occurs if one fails to correct for net input power variations due to the loading effect of the chamber on the VSWR of the source antennas. (See section 4.2 for more details.) Note that these corrections are made typically when using the mode tuned approach and hence are not included in the total or root-sum-square error estimates of table 6.1. They are shown on the table to provide insight to the estimated magnitude of error expected if this correction were not made. The basis for these estimates are the data shown in figures 6.1a and 6.1b. These figures show the average and maximum E-field strength measured inside the NBS reverberation chamber using an array of seven NBS isotropic probes. A comparison is shown between results obtained before and after the measurements were corrected for net input power variations and normalized for an equivalent constant net input power. Note from table 6.1 this error is the same order of magnitude as 2), the mismatch error between the receiving antennas and power detectors. This is as expected since the source and

receiving antennas used in the chamber have similar VSWRs and the power detector (load) and generator VSWRs are also similar. This error is included in table 6.2 and estimated to be the same as for the receiving mismatch error.

The total (worst-case) uncertainties for each approach (mode-tuned, and mode-stirred) are shown at the bottom of each table. This uncertainty should be regarded as a conservative estimate. The probability of the true value of E_a being near the extreme of such worst-case uncertainty is small. This is because the probability of every error source being at its extreme value and in the worst possible combination is almost zero.

A more realistic method of combining uncertainties is the root-sum-of-the-squares (rss) method. The rss uncertainty is based on the fact that most of the errors are independent of each other and hence are random with respect to each other and combine like random variables. The rss method of combining random variables is justified by statistical considerations (beyond the scope of this report) which are also inherent in the reverberation chamber measurement methods.

Finding the rss uncertainty requires that each individual uncertainty be expressed in fractional form. The method of calculation follows the name - square the components, sum those squares and then take the square root. The results are shown at the bottom of tables 6.1 and 6.2.

6.2.2 General Comments on Error Analysis.

Some general comments on interpreting immunity measurement results uncertainties based upon the above experimental error analysis are appropriate.

- 1) The mismatch error at frequencies below 2 GHz, (particularly if corrections are not made for either the transmitting antennas or the receiving antennas mismatch looking into their source or load), will cause the field determination inside the chamber to be low. This also causes the EUT response results to be lower than they actually are. For example, the low frequency data of figures 5.15, 1 cm dipole, and 5.16, ridged horn, should be corrected (response increased) proportionally to the systematic offset error estimates show in tables 6.1 and 6.2. (i.e., 3.46 dB at 1.0 GHz and 1.66 dB at 2.0 GHz).
- 2) The wave impedance, when the peak response of an EUT is measured, appears to be higher than 120π ohms. This means that if the free space wave impedance of 120π ohms is used in determining the corresponding peak amplitude of the exposure field, there will be a systematic offset error resulting in too low a calculated E-field exposure value, or, since the actual E-field is higher than the calculated value this results in too high a EUT response indication for a specified E-field exposure.
- 3) The spatial variation in the measured, statistically determined E-field in the chamber resulting from a complete revolution of the tuner decreases from as great as ± 8 dB at 200 MHz down to less than ± 2 dB at 2.0 GHz. (See figure 2.27.) Logically, it is expected that this variation will continue to decrease as the frequency increases. However, high variations exist in the response data obtained for EUT at frequencies where the spatial E-field variations are small. This is probably due to the relatively large variations in the wave impedance as a function of tuner position. Some additional influence may be due to the mismatch characteristics of the antennas vs source and load as a function of frequency. A way to reduce this problem is to increase the number of frequencies at which data are taken (clustered around a particular frequency of interest) or increase the number of reference receiving antennas or probes used to determine the exposure field (for example see figure 2.27) and then average the data.

6.3 Measurement Technique Advantages and Limitations

Significant advantages do exist, as alluded to in the introduction, for using a reverberation chamber for EMC measurements. Specific advantages and limitations for which insight was obtain from this study include:

- a) The ability to generate high level fields efficiently. For example, 1 watt net input power into the NBS reverberation chamber results in electric fields of approximately 70 V/m. This is approximately 1/10 the input power required to generate the same level field in the NBS anechoic chamber, assuming far-field separation distances.

- b) Large test zones, for example up to 2/3 of the volume inside a reverberation chamber can be available excluding an area approximately 1/2 meter spacing to the walls.
- c) Broad frequency coverage (from 200 MHz to at least 18 GHz in the NBS chamber).
- d) Testing is cost effective. This is especially true in comparison to anechoic chamber testing. Significant savings are realized in two major ways. First, the facility installation and measurement system procurement costs for a reverberation chamber are significantly less than for an anechoic chamber. Second, the time required to perform a complete EMC analysis of an EUT should be much less using a reverberation chamber. Again, from our experience in evaluating the susceptibility of the 7.0 cm FFAR, it required approximately 1/10 the test time to obtain the reverberation chamber results as compared to the anechoic chamber results shown on figure 5.13.
- e) The directional characteristics of antenna or EUT placed inside a reverberation chamber are lost resulting in an equivalent gain of unity.
- f) The response of an antenna or EUT measured inside a reverberation chamber is less than when measured inside an anechoic chamber (open space) in proportion to its gain. Hence, it appears that the EUT's gain is the desired correlation factor. This implies that susceptibility criteria determined for an EUT using a reverberation chamber must include an additional factor proportional to the EUT's estimated maximum gain as a function of frequency.
- g) The response of EUT to an electromagnetic field after it has penetrated the EUT's shield, appears to be equivalent in both the reverberation and anechoic chambers.

The advantages indicated above may well outweigh the disadvantages implied in items e and f, at least for some applications. The obvious trade off is one of measurement uncertainty that one can tolerate in determining the EMC/EMI characteristics of specific EUT and the inherent measurement uncertainties associated with determining the amplitude of the test fields inside the reverberation chamber.

7. Suggestions for Future Research Efforts

Because of the significant potential of the reverberation chamber method for performing immunity measurements, considerable interest has been expressed to further evaluate this technique with the intent of extending its range of applications. Specifically, the following suggestions are offered.

- 1) Evaluate the reverberation chamber measurement method for pulsed rf (down to 1 μ s pulse duration) immunity testing, (i.e., experimentally investigate pulse dispersion characteristics of the chamber). Measurement studies are in progress at NBS under the sponsorship of the NSWC and RADC to complete this task.
- 2) Determine the feasibility of extending the use of the chamber from 18 GHz to 40 GHz. A plan exists to undertake such an effort in late 1985 at NBS under sponsorship of RADC.
- 3) Evaluate reverberation chamber excited as a TEM transducer, (i.e., determine the feasibility of consolidating a TEM cell and reverberation chamber into a single facility for testing from 10 kHz to 18 GHz and beyond). This item is suggested because of the unique potential of developing a single, shielded facility that could be used for EMC/EMV testing over the complete frequency range listed above. This task is also planned at NBS under RADC sponsorship.
- 4) Investigate the feasibility of using the reverberation chamber for multiple frequency immunity testing. This is of interest because such complex fields of multiple frequencies can exist in typical operational environments.
- 5) Investigate the use of the reverberation chamber technique for measuring shielding effectiveness of connectors (evaluate MIL STD 1344 measurement technique), shielding materials, and enclosures in comparison to other techniques. This suggestion is included with the objective of improving the state of art in shielding measurements and to determine if correlation or agreement exists between results obtained using the reverberation chamber method and other established techniques.

8.0 Acknowledgments

The work described in this report was jointly funded by the Naval Surface Weapons Center (NSWC), Dahlgren, Virginia; Rome Air Development Center (RADC), Griffiss Air Force Base, Rome, New York; and the National Bureau of Standards, (NBS), Boulder, Colorado. The authors express appreciation especially to John Bean, NSWC; Charles Blank, RADC; and Mark T. Ma, NBS for their support, helpful comments and editorial review. Acknowledgement is also given to John L. Workman for his assistance in performing many of the measurements included in this study.

9.0 References

- [1] Mendes, H.A. A new approach to electromagnetic field-strength measurements in shielded enclosures. in Wescon Tech. Papers; Los Angeles, CA. 1968 August.
- [2] Cummings, J.R. Translational electromagnetic environment chamber, a new method for measuring radiated susceptibility and emissions. Proc. IEEE Int. Symp. on EMC; 1975; San Antonio, Texas.
- [3] Corona, P; Latmiral, G; Paolini E; Piccioli L. Performance of a reverberating enclosure for power measurements in the microwave range. 2nd Symp. Tech. Exhibition on EMC; 1977; Montreux, Switzerland. 419-427.
- [4] Bean, J.L.; Hall, R.A. Electromagnetic susceptibility measurements using a mode-stirred chamber. Proc. IEEE Int. Symp. on EMC; 1978; Atlanta, GA.
- [5] Corona, P. Electromagnetic reverberating enclosures: behavior and applications. Alta. Frequ.: Vol. 49; 1980. 154-158.
- [6] Corona, P.; Latmiral, G; and Paolini, E. Performance and analysis of a reverberating enclosure with variable geometry. IEEE. Trans. on EMC; EMC-22(1): 2-5; 1980 February.
- [7] Crawford, M.L. Evaluation of a reverberating chamber facility for performing EM radiated field susceptibility measurements. Nat. Bur. Stand. (U.S.) NBSIR 81-1638; 1981 February.
- [8] Liu, B.H.; Chang, D.C.; and Ma, M.T. Eigenmodes and the composite quality factor of a reverberating chamber. Nat. Bur. Stand. (U.S.) NBS Tech. Note 1066; 1983 August.
- [9] Ramo, S.; and Whinnery, J.R. Fields and Waves in Modern Radio, 2nd ed. New York: John Wiley & Son, Inc.; 1960. 418-428.
- [10] Liu, B.H.; Chang, D.C.; and Ma, M.T. Design considerations of reverberating chambers for electromagnetic interference measurements. Proc. IEEE. Int Symp. on EMC; 1983; Washington, DC. 508-512.
- [11] Ma, M.T.; Kanda, M.; Crawford, M.L.; and Larsen, E.B. A review of electromagnetic compatibility/interference measurement methodologies. Proc of IEEE. 388-411; 1985 March.
- [12] Tai, C.T. On the definition of the effective aperture of antennas. IEEE Trans. Antennas and Propag. AP-9: 224-225; 1961 March.
- [13] Greene, F.M. Development of Electric and Magnetic Near-Field Probes. Nat. Bur. Stand. (U.S.) NBS Tech. Note 658; 1975 January.
- [14] Roe, J.M. An improved technological basis for radiated susceptibility and emissions specifications. Proc. IEEE. Int. Symp. on EMC; 1978; Atlanta, GA.
- [15] Roe, J.M. Design of tuner for TEMEC, McDonnell Douglas Corp., St. Louis, MO., Private Communication.
- [16] Bean, J.L. Design of tuner for NSWC reverberating chamber, Naval Surface Weapons Center, Dahlgren, VA., Private communication.

- [17] MIL-STD-1377 (Navy). Effectiveness of Cables, Connectors, and Weapons Enclosures Shielding and Filters in Precluding Hazards of Electromagnetic Radiation to Ordinance, Measurement of. 1971 August.
- [18] Lentz, R.; and Anderson, H. Reverberating chambers for EMC measurements. Proc. IEEE. Symp. on EMC; 1979; San Diego, CA.
- [19] Crawford, M.L. and Koepke, G.H. Operational considerations of a reverberation chamber for EMC immunity measurements - some experimental results. Proc. IEEE. Nat. Symp. on EMC; 1984; San Antonio, TX.
- [20] Wilson, P.F. Peak versus average response characteristics in a reverberation chamber. National Bureau of Standards, Boulder, CO, Private communication.
- [21] Bensema, W.D.; Reeve, G.R.; and Koepke, G.H. A multisensor automated EM field measurement system. Proc. IEEE IMTC/85 Conf; 1985; Tampa, FL.
- [22] Bowman, R.R. Calibration techniques for electromagnetic hazard meters: 500 MHz to 20 GHz. Nat. Bur. Stand. (U.S.) NBSIR 75-805; 1976 April.
- [23] Pressel, P.I. Mismatch: a major source of error in shielding effectiveness measurements. Proc. Seventeenth Annual Connector and Interconnection Technology Symp; 1984 September; Anaheim, CA.
- [24] Wilson, P.F. Apertured coaxial probe. Paper in progress.
- [25] Bean, J.L. Hero susceptibility of a 2.75 Inch FFAR: comparative results obtained from mode-stirred chambers, anechoic chamber, and ground plane test facilities, Proc. IEEE IMTC/85; 1985; Tampa, FL.

LIST OF FIGURES and TABLES

- Figure 2.1. Distinct frequencies of modes in NBS 3.05 m wide x 4.57 m long x 2.74 m high shielded chamber below 200 MHz.
- Figure 2.2 Total number of modes as a function of operating frequency for the NBS chamber.
- Figure 2.3 Total number of modes as a function of operating frequency for a square based chamber whose volume is the same as that of NBS chamber.
- Figure 2.4 Total number of modes as a function of operating frequency for a cubic chamber whose volume is the same as that of NBS chamber.
- Figure 2.5 An illustration of mode degeneracy (NBS chamber).
- Figure 2.6 An illustration of mode degeneracy (square-based chamber).
- Figure 2.7 An illustration of mode degeneracy (cubic chamber).
- Figure 2.8 Cumulative distribution curve of the normalized $1/Q$ values in the 180 MHz to 200 MHz frequency band for the NBS chamber.
- Figure 2.9 Cumulative distribution curve of the normalized $1/Q$ values in the 330 MHz to 350 MHz frequency band for the NBS chamber.
- Figure 2.10 Cumulative distribution curve of the normalized $1/Q$ values in the 480 MHz to 500 MHz frequency band for the NBS chamber.
- Figure 2.11 Photograph of interior of NBS reverberation chamber.
- Figure 2.12 Average and minimum losses between transmitted and received powers measured at antennas' terminals inside NBS reverberation chamber. Transmitting antennas are: log periodic (200 MHz - 1000 MHz), ridged horn (1.0 GHz - 4.0 GHz), double ridged circular horn (4.0 GHz - 18 GHz). Receiving antennas are: long wire (200 MHz - 1000 MHz), ridged horn (1.0 GHz - 4.0 GHz), double ridged circular horn (4.0 GHz - 18 GHz).
- Figure 2.13 Theoretical composite \tilde{Q} and experimental Q' determined for NBS reverberation chamber. a) Theoretical and experimental values of Q as a function of frequency. b) Ratio of the theoretical composite \tilde{Q} to experimental Q' as a function of frequency.
- Figure 2.14 Bulkhead panel used for accessing NBS reverberation chamber.
- Figure 2.15 Tuner designs for use in reverberation chambers. a) McDonnell Douglas Corp. TEMEC tuner, b) NSWC chamber tuner, c) NBS chamber tuner.
- Figure 2.16 Photograph of tuner, log-periodic transmitting antenna and NBS isotropic probes inside NBS reverberation chamber.
- Figure 2.17 Details of tuner and stepping motor mounting for the NBS reverberation chamber.
- Figure 2.18 Ratio of maximum to minimum received power obtained by rotating tuner in the frequency range 200 MHz to 18 GHz. a) Empty chamber, b) Four pieces of 66 cm rf absorber placed upright in center of chamber, 0.5 m above floor.
- Figure 2.19 Cross sectional views of NBS reverberation chamber showing placement of tuner, transmitting and receiving antennas, and NBS probes.
- Figure 2.20 Design of taper section of long wire antenna for use in Reverberation chamber.
- Figure 2.21 Photograph showing long wire antenna and NBS probes placement inside NBS reverberation chamber.

- Figure 2.22 VSWR of transmitting antennas placed inside NBS reverberation chamber. a) Long wire antenna, chamber empty, b) Composite of three antennas, (log-periodic, 0.2-1.0 GHz), (ridged horn, 1.0 - 4.0 GHz), and (double ridged circular horn, 4.0-18 GHz), chamber empty, and c) Composite of three antennas with chamber loaded with 4 pieces of 66 cm rf absorber placed upright in center of chamber, 0.5 m above floor.
- Figure 2.23 Average and minimum losses between transmitted and received powers measured at antennas's terminals inside NBS reverberation chamber. Long wire antenna transmitting (200 MHz - 18 GHz), composite of three antennas receiving (log periodic 200 MHz - 1000 MHz, ridged horn, 1.0 GHz - 4.0 GHz, double ridged circular horn, 4.0 GHz - 18 GHz).
- Figure 2.24 Average and minimum losses between transmitted and received powers measured at antennas' terminals inside NBS chamber with four pieces of 66 cm rf absorber upright in center of chamber, 0.5 m above floor. Composite of three antennas used for transmitting and receiving.
- Figure 2.25 Magnitude of wave impedance inside NBS reverberation chamber.
- Figure 2.26 Average and maximum E-field strengths inside empty NBS reverberation chamber for 1 W net input power determined from: a) composite of 3 antennas received power measurements, and b) calibrated 1 cm dipole probe measurements.
- Figure 2.27 E-field strength measured inside NBS reverberation chamber using array of 7 NBS isotropic probes: (a) maximum, and (b) average. Net power normalized to 1 Watt. Transmitting antennas are: log periodic (100 MHz - 1 GHz), ridged horn (1 GHz - 2 GHz).
- Figure 2.28 Mean values of the E-field strength measured inside NBS reverberation chamber using array of 7 NBS isotropic probes with 1 W net input power: (a) average, and (b) maximum. Data determined from maximum and average values of the 7 probes (7 locations) for the three orthogonal components and their sum (total) using 200 tuner positions (1.8 degree increments).
- Figure 3.1 Placement of metallic objects inside NBS reverberation chamber to evaluate scattering effects upon E-field spatial distribution. a) Photograph showing 30 cm x 50 cm x 60 cm welded aluminum box inside NBS reverberation chamber. b) Photograph showing rolling equipment rack inside NBS reverberation chamber.
- Figure 3.2 Comparison of the mean value of the average and maximum E-field strength measured using array of probes placed inside NBS reverberation chamber with chamber empty or with scattering object placed at center of test zone. a) 30 cm x 50 cm x 60 cm aluminum box, b) Rolling equipment rack.
- Figure 3.3 Maximum E-field strength inside empty chamber and chamber loaded with 4 pieces of 66 cm rf absorber for 1 W net input power determined from composite of 3 antennas received power measurements. Data obtained using mode stirring approach.
- Figure 4.1 Block diagram of NBS reverberation chamber evaluation and EMC measurement system.
- Figure 4.2 Major software tasks for performing and evaluation susceptibility tests using a reverberation chamber.
- Figure 4.3 Flow diagram for mode-tuned measurements.
- Figure 4.4 Flow diagram for mode-stirred measurements.
- Figure 5.1 Block diagram of NBS anechoic chamber EMC/EMI measurement system. Side view of chamber. The outside width is 6.7 m.
- Figure 5.2 Comparison of 1 cm dipole probe's peak responses to EM field established inside NBS reverberation and anechoic chambers. Output normalized to E-field exposure of 37 dB V/m.

- Figure 5.3 Comparison of ridged horn's peak responses to EM field established inside NBS reverberation and anechoic chambers. Output from horn normalized to exposure E-field of 37 dB V/m. a) Antenna output versus frequency, b) Difference in output responses of ridged horn measured in NBS reverberation and anechoic chambers compared to calibrated gain of horn.
- Figure 5.4 Photograph of 12 cm x 18 cm x 36 cm rectangular TEM cell with 5.1 cm x 5.1 cm aperture.
- Figure 5.5 Comparison of power coupled to one port of 12 cm x 18 cm x 36 cm TEM cell with 5.1 cm x 5.1 cm aperture placed inside NBS reverberation and anechoic chambers.
- Figure 5.6 Photograph of 12 cm x 12 cm x 24 cm rectangular TEM cell with 3.1 cm diameter aperture.
- Figure 5.7 Comparison of power coupled to one port of 12 cm x 12 cm x 24 cm TEM cell with 3.1 cm diameter aperture placed inside NBS reverberation and anechoic chambers.
- Figure 5.8 Photograph of 3.0 cm x 6.0 cm x 11.4 cm rectangular TEM cell with 1.4 cm diameter aperture.
- Figure 5.9 Comparison of power coupled to one port of 3.0 cm x 6.0 cm x 11.4 cm TEM cell with 1.4 cm diameter aperture placed inside NBS reverberation and anechoic chambers.
- Figure 5.10 Photograph of modified 7.0 cm Folding Fin Aircraft Rocket inside NBS reverberation chamber.
- Figure 5.11 Photograph of modified 7.0 cm Folding Fin Aircraft Rocket inside NBS anechoic chamber.
- Figure 5.12 Comparison of 7.0 cm modified FFAR thermocouple responses to EM field established inside NBS reverberation and anechoic chambers. Data normalized to exposure power density of 10 mW/cm^2 . a) Thermocouple output vs frequency. b) Difference in thermocouple output measured in NBS reverberation and anechoic chambers.
- Figure 5.13 Examples of azimuth patterns of 7.0 cm modified FFAR thermocouple response taken in NBS anechoic chamber.
- Figure 5.14 Comparison of the average and maximum E-field strengths inside the NBS and NSWC reverberation chambers determined for 1 W net input power using 1) reference antenna received power measurements, and 2) calibrated 1 cm dipole probe measurements. (a) NBS chamber, (b) NSWC half chamber, and (c) NSWC full chamber.
- Figure 5.15 Comparison of 1 cm dipole probe's peak responses to normalized E-field of 37 dB V/m using NBS and NSWC reverberation chambers.
- Figure 5.16 Comparison of ridged horn's peak responses to normalized exposure E-field of 37 dB V/m using NBS and NSWC reverberation chambers.
- Figure 5.17 Comparison of 7.0 cm modified FFAR thermocouple responses to EM field established inside NBS and NSWC half reverberation chambers. Data normalized to exposure power density of 10 mW/cm^2 . a) Thermocouple output vs frequency. b) Difference in thermocouple output measured in NBS and NSWC reverberation chambers.
- Figure 6.1 E-field strength measured inside NBS reverberation chamber using array of 7 NBS isotropic probes: (a) average, and (b) maximum. Comparison shown between results obtained before and after normalization of measurements to correct for changes in net input power. Normalized data corrected for net input power of 1.0 watt. chamber excitation antenna is log periodic. E_p is average field strength determined from 7 probes.

- Table 6.1 Summary and estimates of measurement uncertainties for determining field strength inside NBS reverberation chamber - Mode Tuned (200 MHz - 2.0 GHz).
- Table 6.2 Summary and estimates of measurement uncertainties for determining field strength inside NBS reverberation chamber - Mode Stirred (2.0 GHz - 18.0 GHz).
- Table 6.3 Estimates of impedance mismatch uncertainties for received power measurements.
- Table 6.4 Estimates of uncertainties due to limiting number of tuner positions (sample size).

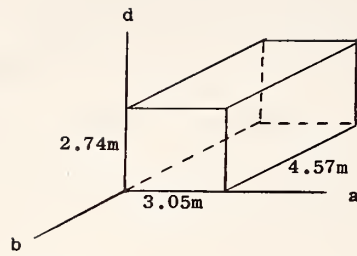

$$f_{mnp} = 150 \sqrt{\left(\frac{m}{a}\right)^2 + \left(\frac{n}{b}\right)^2 + \left(\frac{p}{d}\right)^2}$$

m, n, and p are integers

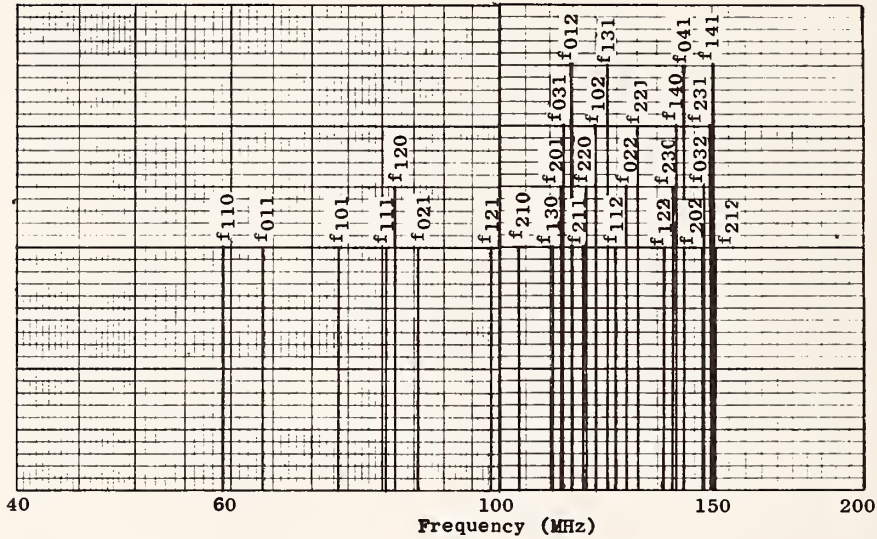

Distinct modes	Mode #	Frequency MHz	Distinct modes	Mode #	Frequency MHz
1	110	59.13	33	222	161.16
2	011	63.83	34	320	161.49
3	101	73.59	35	240	164.05
4	111	80.58	36	013	167.48
5	120	82.02	37	321	170.51
6	021	85.48	38	042	170.95
7	121	98.62	39	150	171.32
8	210	103.69	40	103	171.44
9	130	110.07	41	241	172.94
10	201	112.57	42	051	173.00
11	031	112.66	43	113	174.55
12	012	114.30	44	023	176.87
13	211	117.26	45	232	177.08
14	220	118.25	46	330	177.38
15	102	120.03	47	142	177.89
16	131	122.93	48	151	179.86
17	112	124.43	49	123	183.58
18	022	127.66	50	302	183.73
19	221	130.31	51	331	185.64
20	122	136.81	52	312	186.64
21	230	139.18	53	250	191.33
22	140	140.20	54	203	191.44
23	041	142.25	55	033	191.48
24	202	147.18	56	213	194.23
25	032	147.25	57	322	195.10
26	231	149.56	58	242	197.23
27	141	150.51	59	052	197.28
28	212	150.80	60	340	197.50
29	310	151.15	61	133	197.71
30	132	155.25	62	251	199.01
31	301	157.37	63	410	199.44
32	311	160.76	64	223	202.36

Figure 2.1 Distinct frequencies of modes in NBS 3.05 m wide by 4.57 m long x 2.72 m high shielded chamber below 200 MHz.

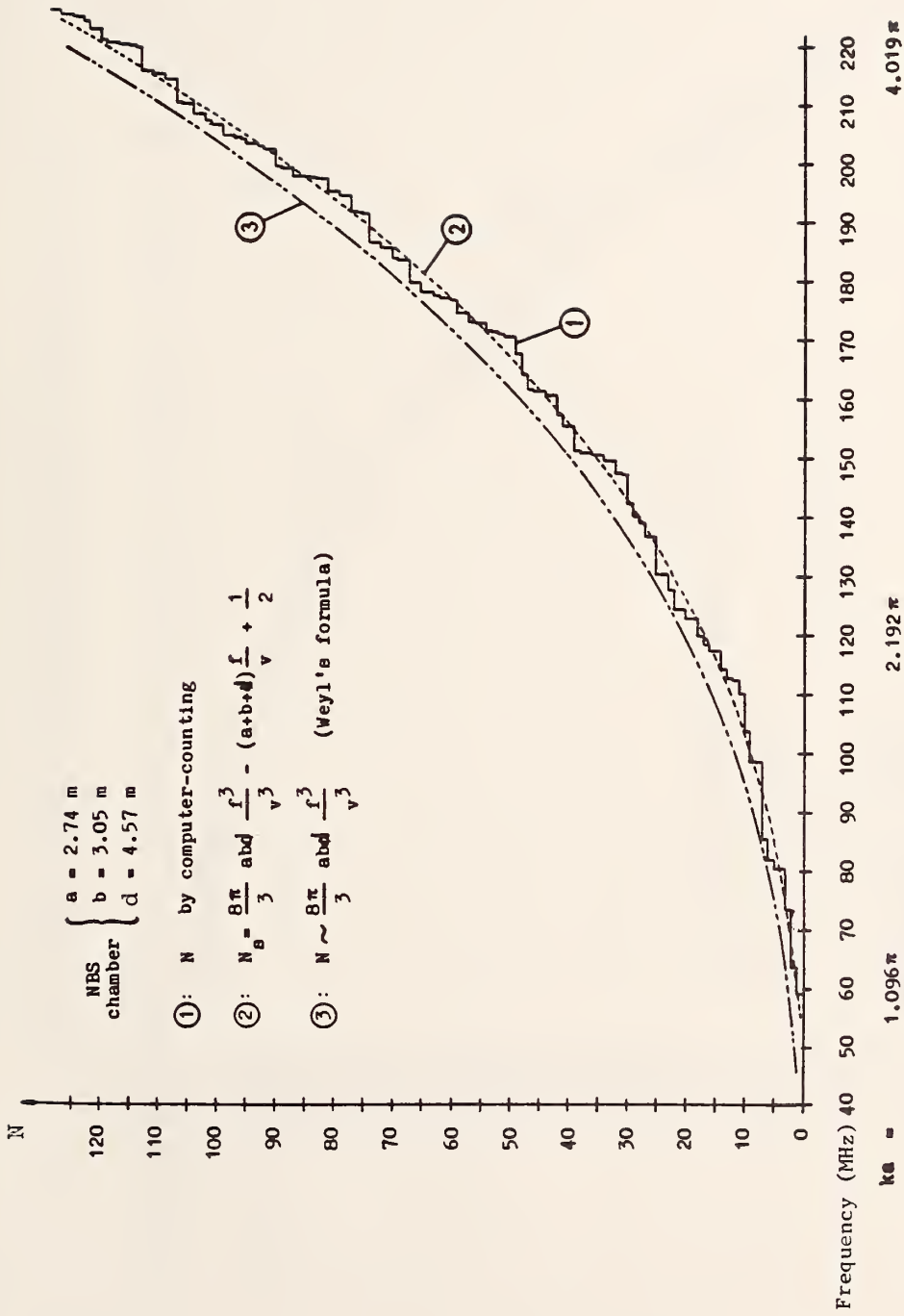

Figure 2.2 Total number of modes as a function of operating frequency for the NBS chamber.

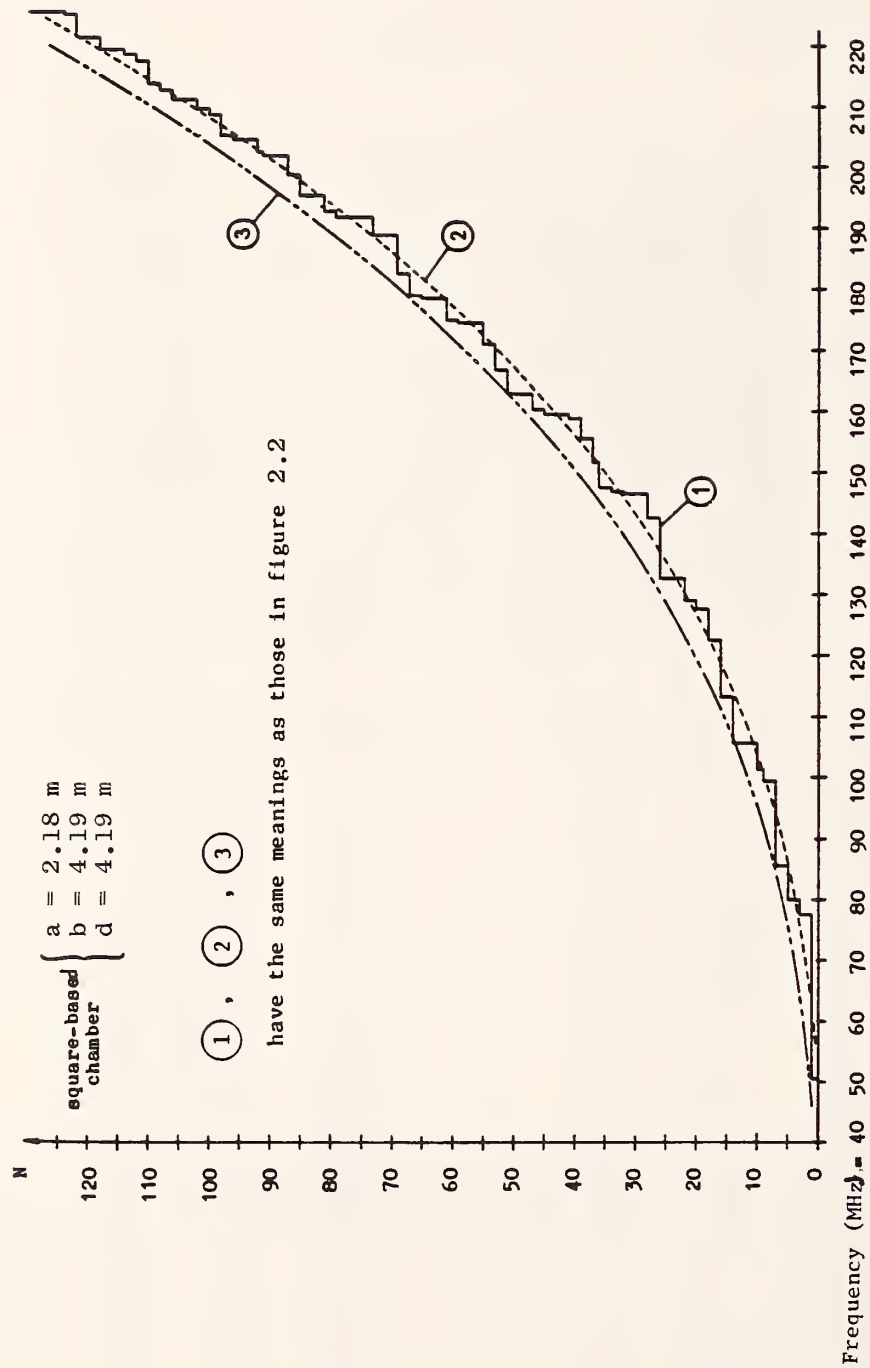

Figure 2.3 Total number of modes as a function of operating frequency for a square based chamber whose volume is the same as that of NBS chamber.

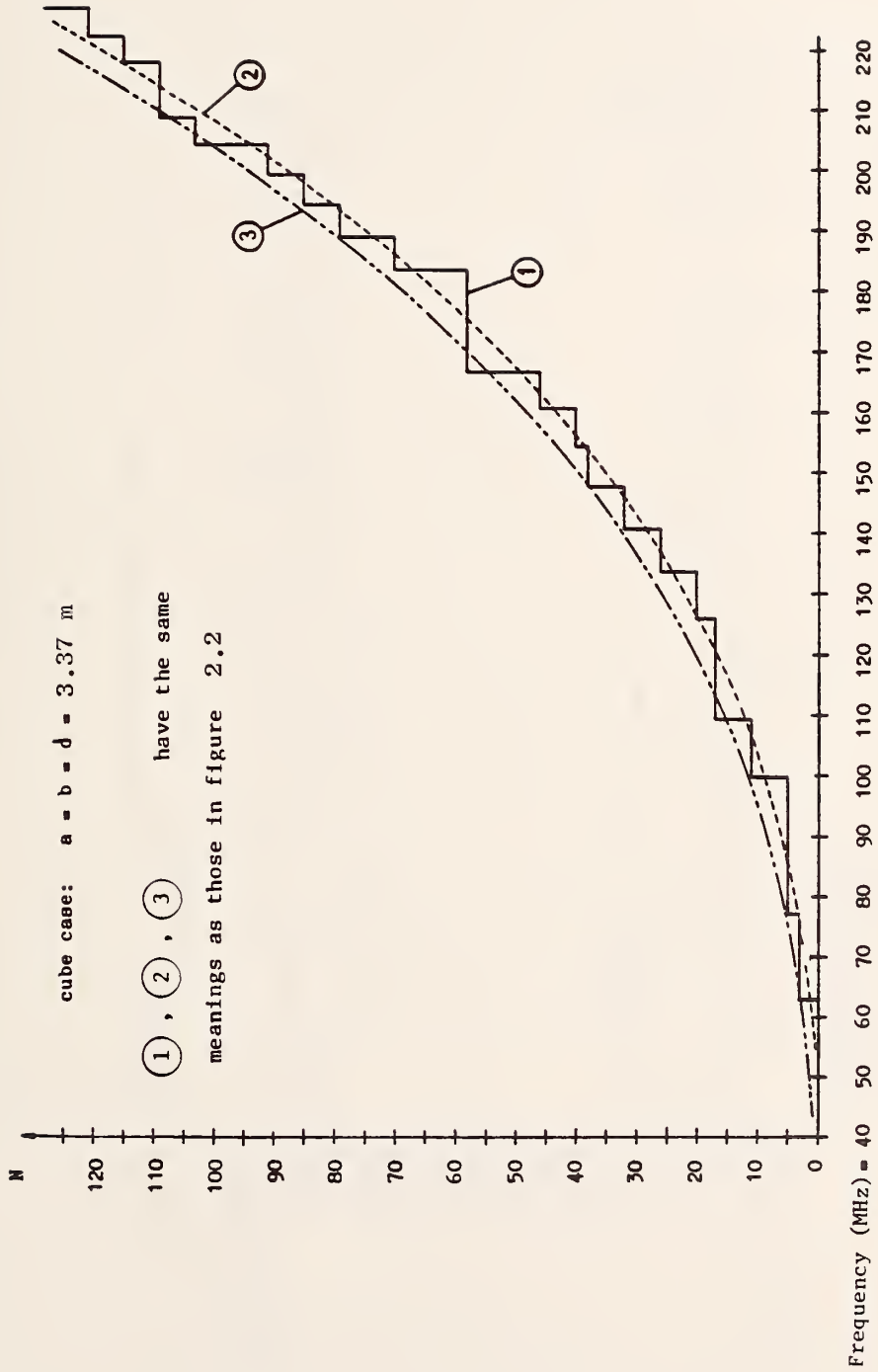

Figure 2.4 Total number of modes as a function of operating frequency for a cubic chamber whose volume is the same as that of NBS chamber.

NBS chamber $\begin{cases} a = 2.74 \text{ m} \\ b = 3.05 \text{ m} \\ d = 4.57 \text{ m} \end{cases}$

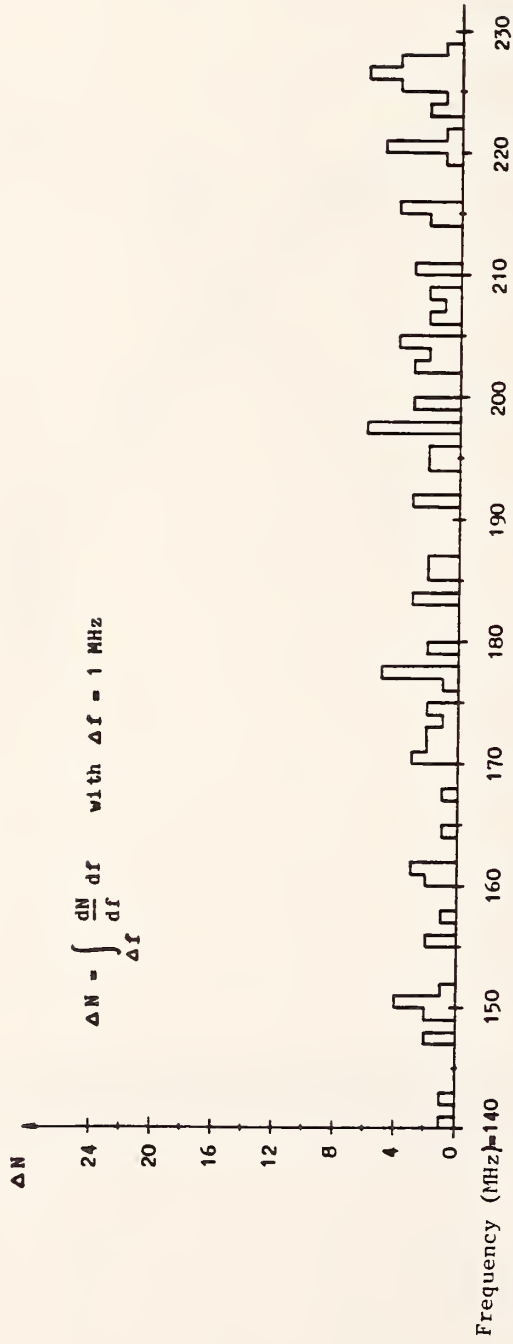

Figure 2.5 An illustration of mode degeneracy (NBS chamber).

square-based chamber { a = 2.18 m
 b = 4.19 m
 d = 4.19 m

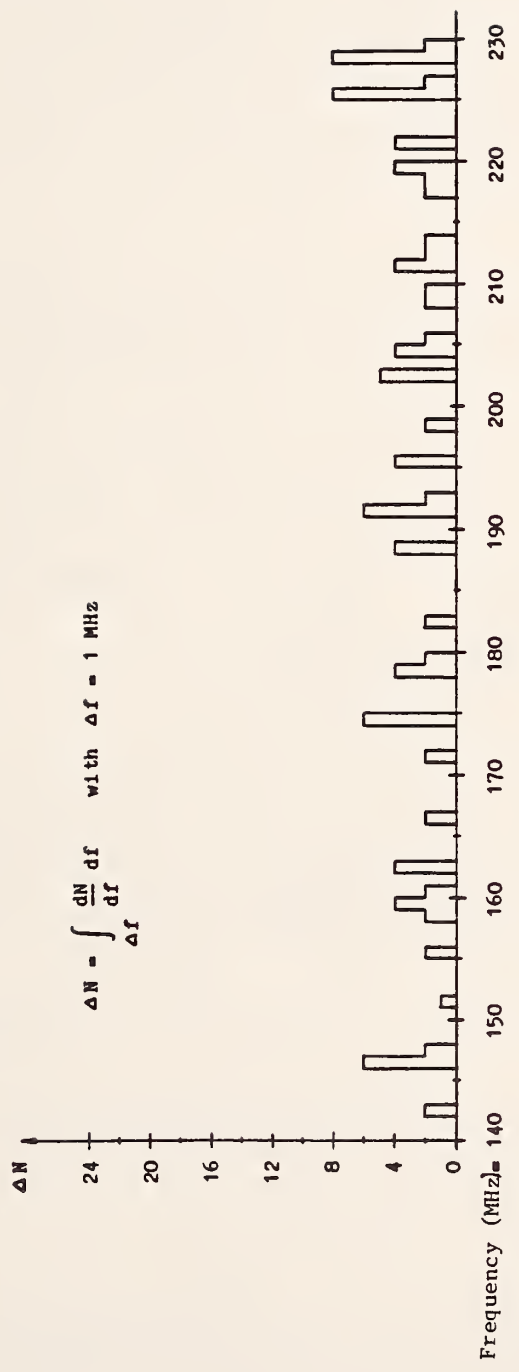

Figure 2.6 An illustration of mode degeneracy (square-base chamber).

cube case: $a = b = d = 3.37$ m

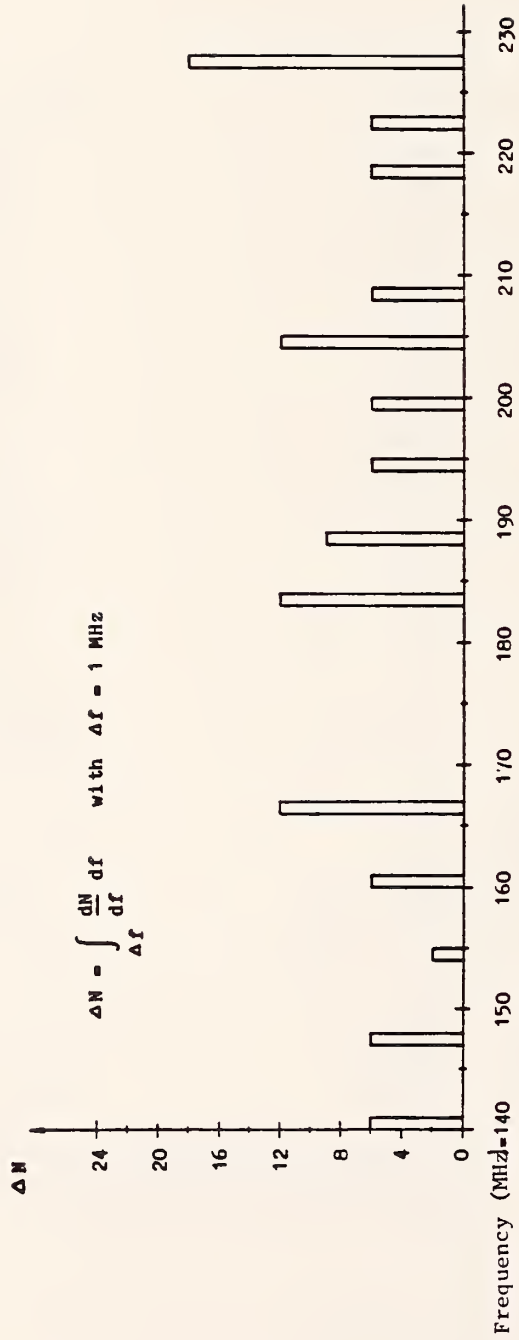

Figure 2.7 An illustration of mode degeneracy (cubic chamber).

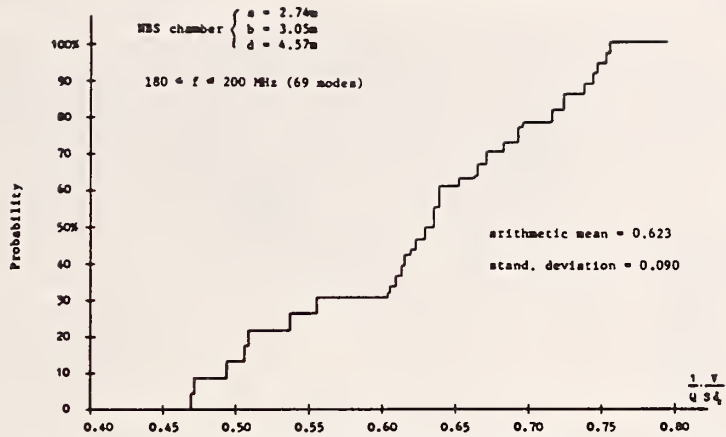

Figure 2.8 Cumulative distribution curve of the normalized $1/Q$ values in the 180 MHz to 200 MHz frequency band for the NBS chamber.

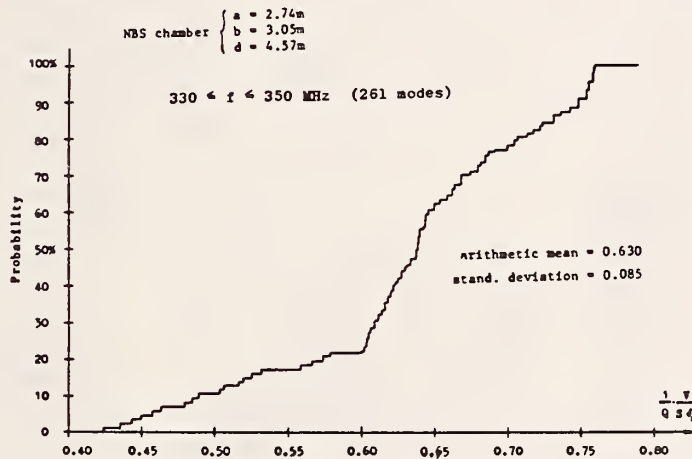

Figure 2.9 Cumulative distribution curve of the normalized $1/Q$ values in the 330 MHz to 350 MHz frequency band for the NBS chamber.

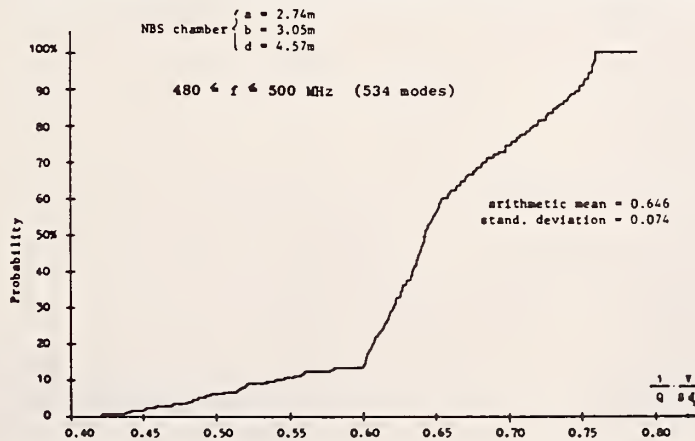

Figure 2.10 Cumulative distribution curve of the normalized $1/Q$ values in the 480 MHz to 500 MHz frequency band for the NBS chamber.

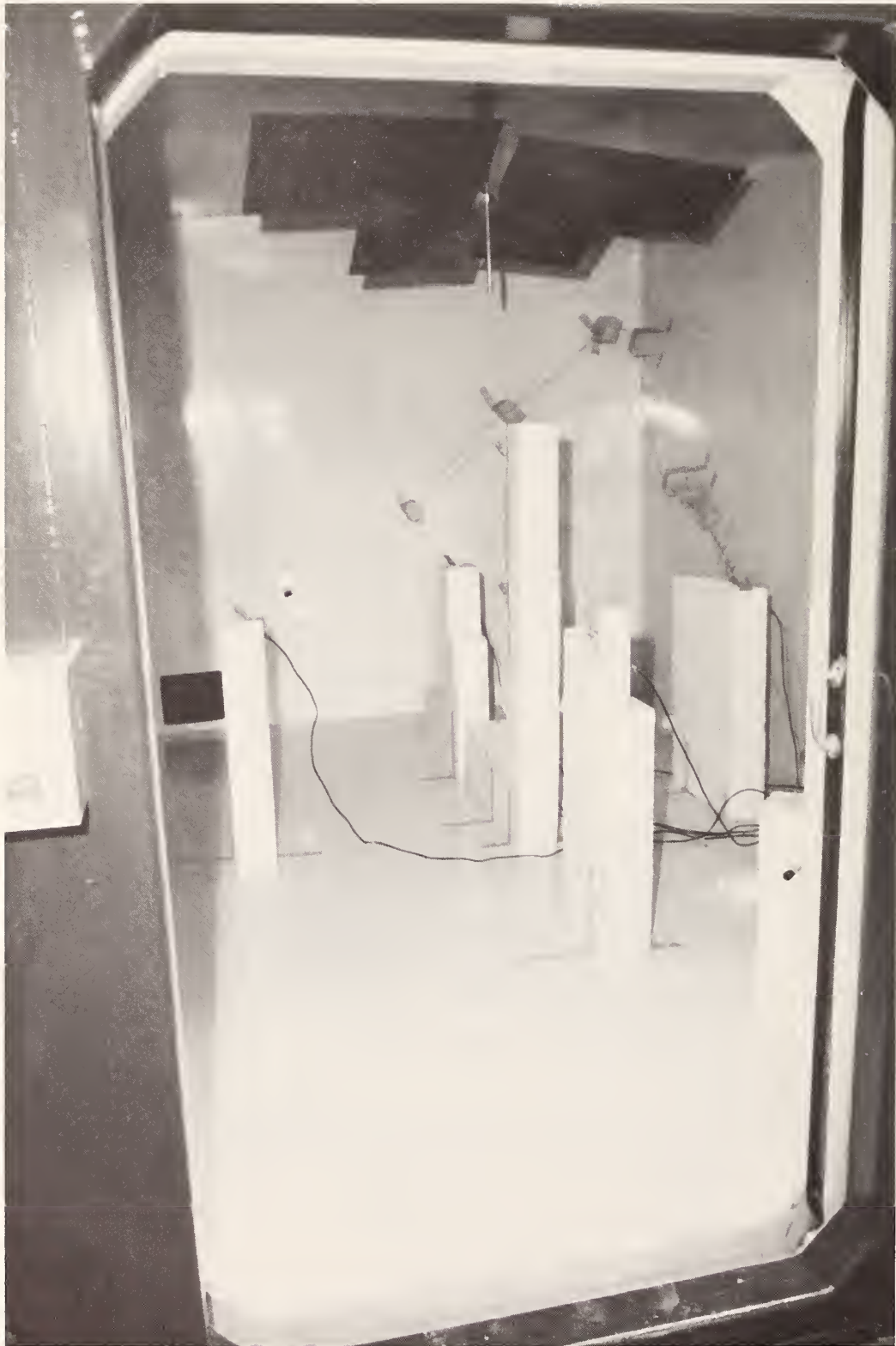

Figure 2.11 Photograph of interior of NBS reverberation chamber.

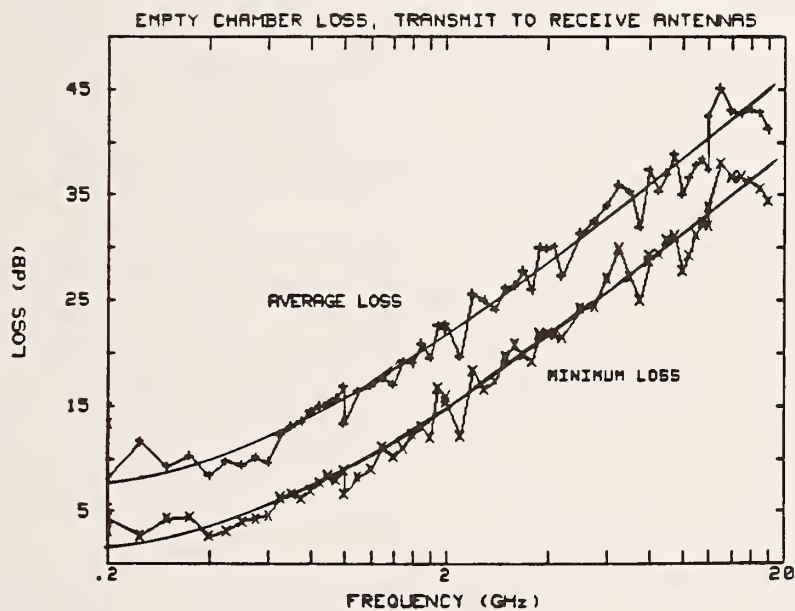

Figure 2.12 Average and minimum losses between transmitted and received powers measured at antennas' terminals inside NBS reverberation chamber. Transmitting antennas are: log periodic (200 MHz - 1000 MHz), ridged horn (1.0 GHz - 4.0 GHz), double ridged circular horn (4.0 GHz - 18 GHz). Receiving antennas are: long wire (200 MHz - 1000 MHz), ridged horn (1.0 GHz - 4.0 GHz), double ridged circular horn (4.0 GHz - 18 GHz).

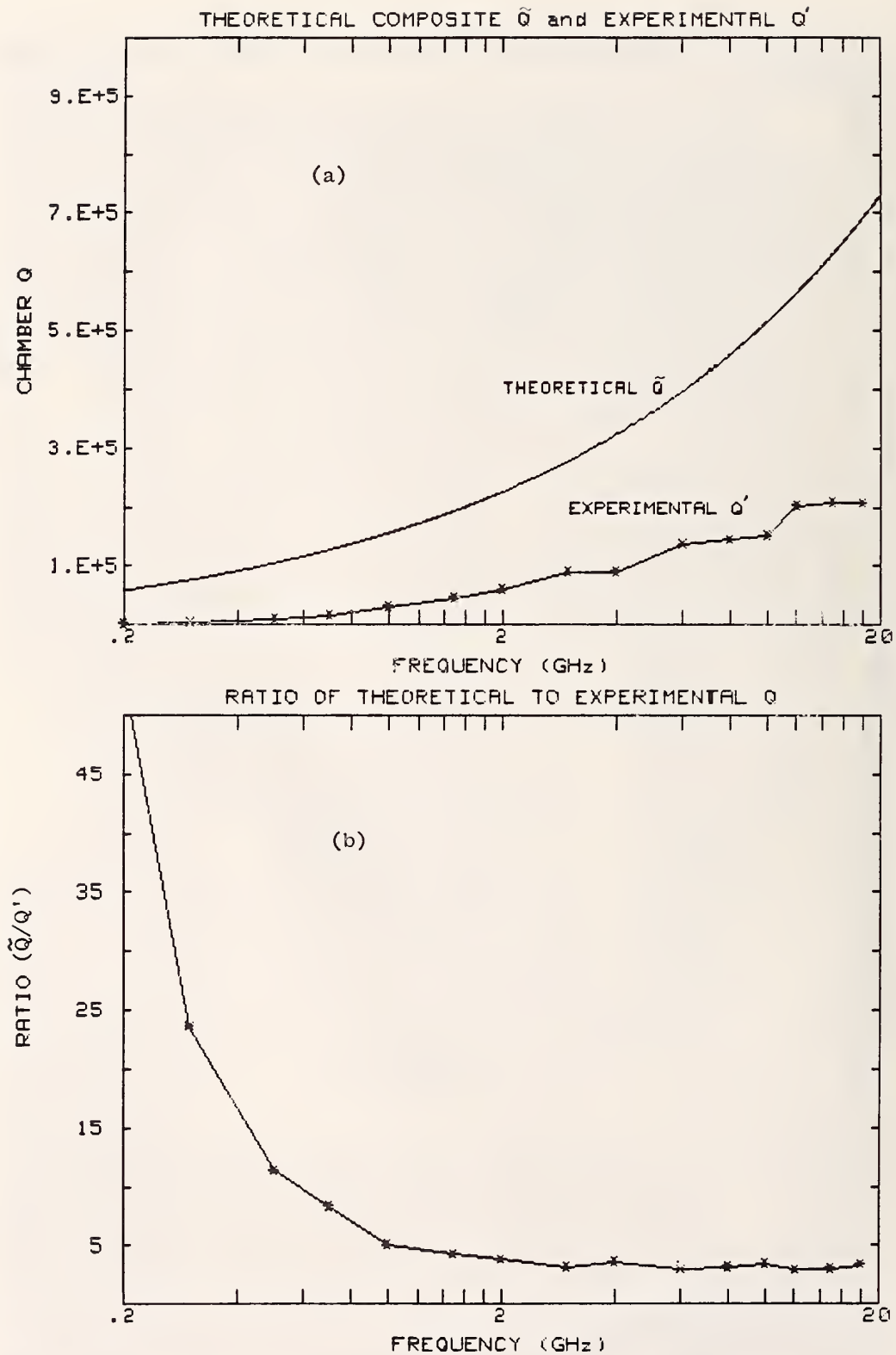

Figure 2.13 Theoretical composite \tilde{Q} and experimental Q' determined for NBS reverberation chamber. a) Theoretical and experimental values of Q as a function of frequency. b) Ratio of the theoretical composite \tilde{Q} to experimental Q' as a function of frequency.

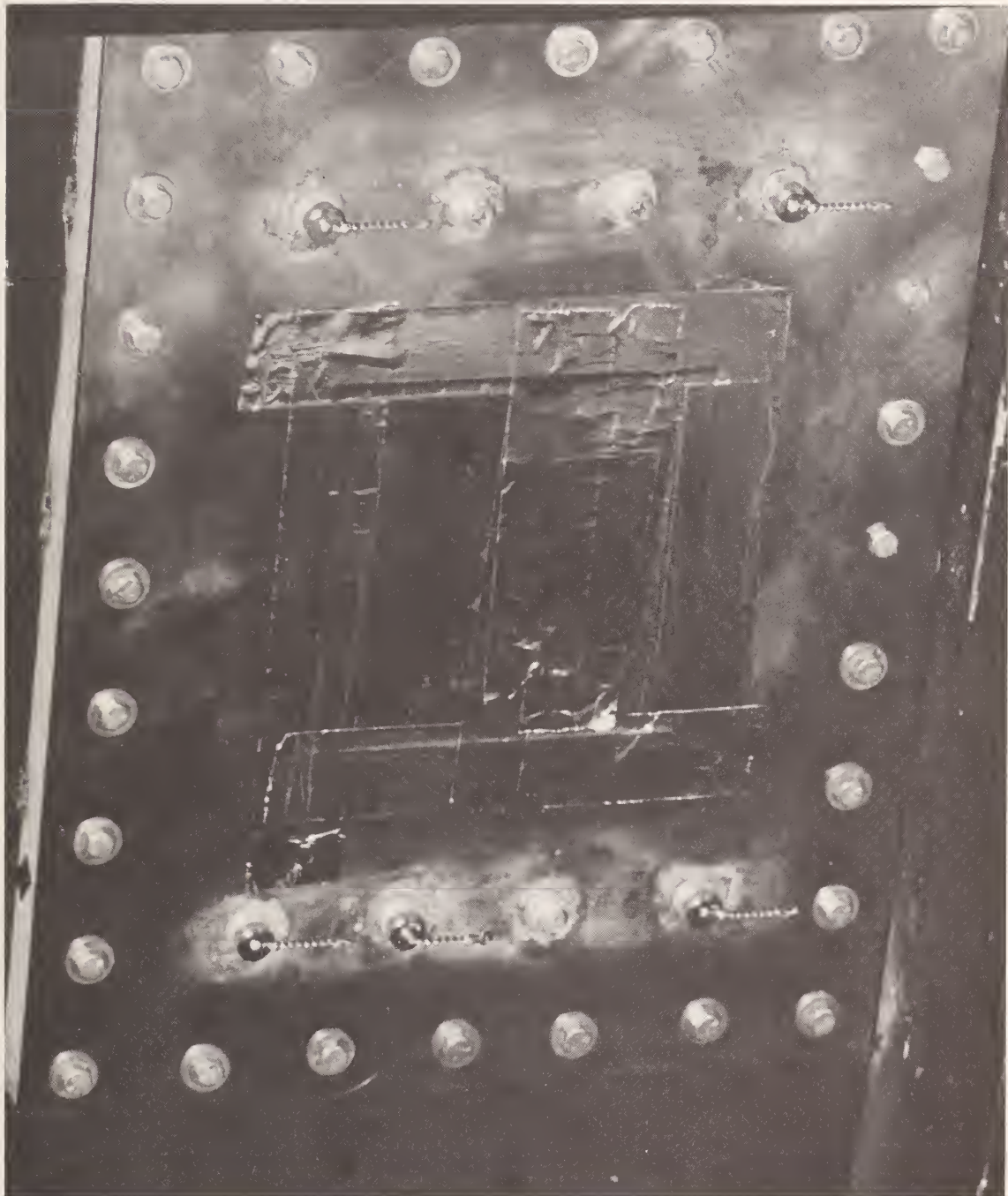

Figure 2.14 Bulkhead panel used for accessing NBS reverberation chamber.



Figure 2.15a Photograph of field tuner/stirrer installed in McDonnell Douglas Corporation 2.4 m x 3.0 m x 7.6 m TEMEC (reverberation chamber) facility.



Figure 2.15b Photograph of field tuner/stirrer installed in NSW 3.5 m x 5.2 m x 5.9 m reverberation chamber.



Figure 2.15c. Photograph of field tuner/stirrer installed in NBS 2.7 m x 3.1 m x 4.6 m reverberation chamber.

Figure 2.15. Tuner designs for use in reverberation chambers. a) McDonnell Douglas Corp. TEMEC tuner, b) NSW chamber tuner, c) NBS chamber tuner.



Figure 2.16 Photograph of tuner, log-periodic transmitting antenna and NBS isotropic probes inside NBS reverberation chamber.

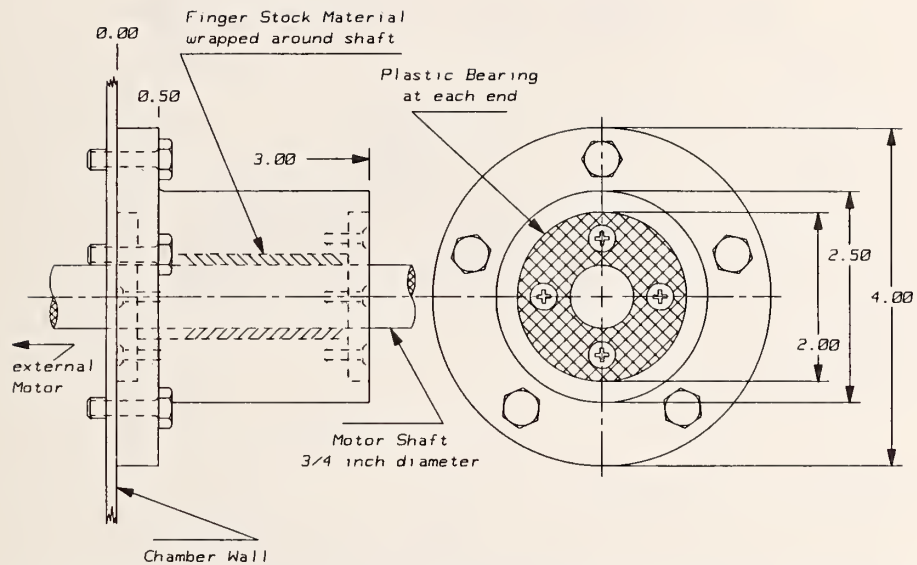

Figure 2.17a. Details of collet for mounting tuner shaft to motor through wall of reverberation chamber.

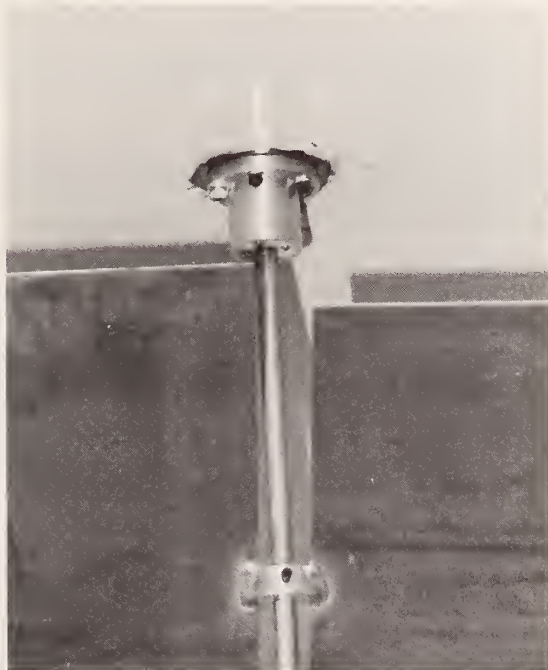

Figure 2.17b. Photograph of tuner shaft mounted through collet on ceiling of NBS reverberation chamber.

Figure 2.17 Details of tuner and stepping motor mounting for the NBS reverberation chamber.

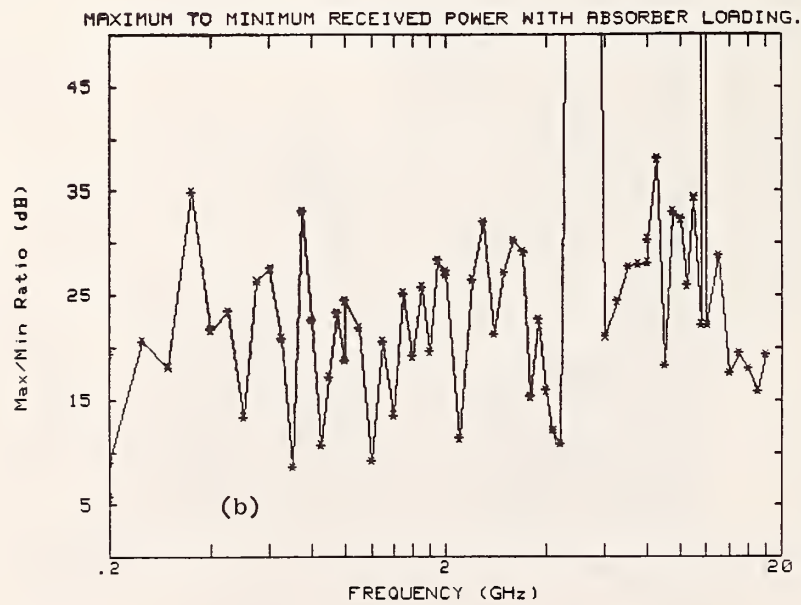
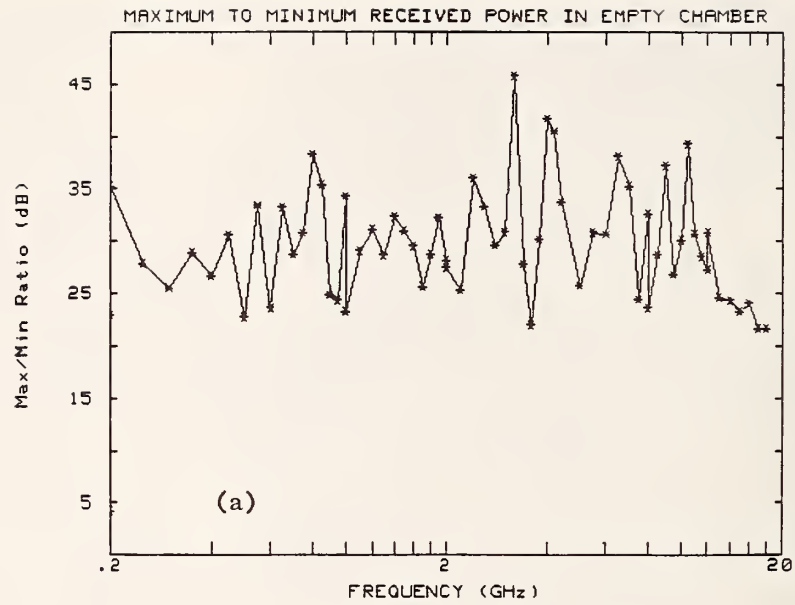

Figure 2.18 Ratio of maximum to minimum received power obtained by rotating tuner in the frequency range 200 MHz to 18 GHz. a) Empty chamber, b) Four pieces of 66 cm rf absorber placed upright in center of chamber, 0.5 m above floor.

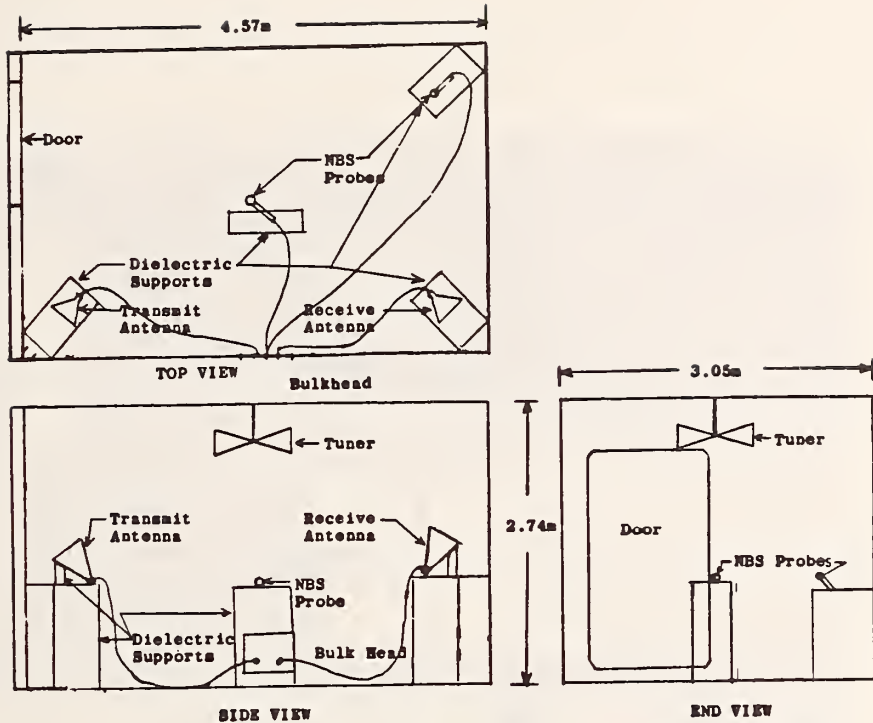

Figure 2.19a. Cross sectional views of NBS reverberation chamber for use at frequencies above 1.0 GHz showing location of antenna and NBS probes.

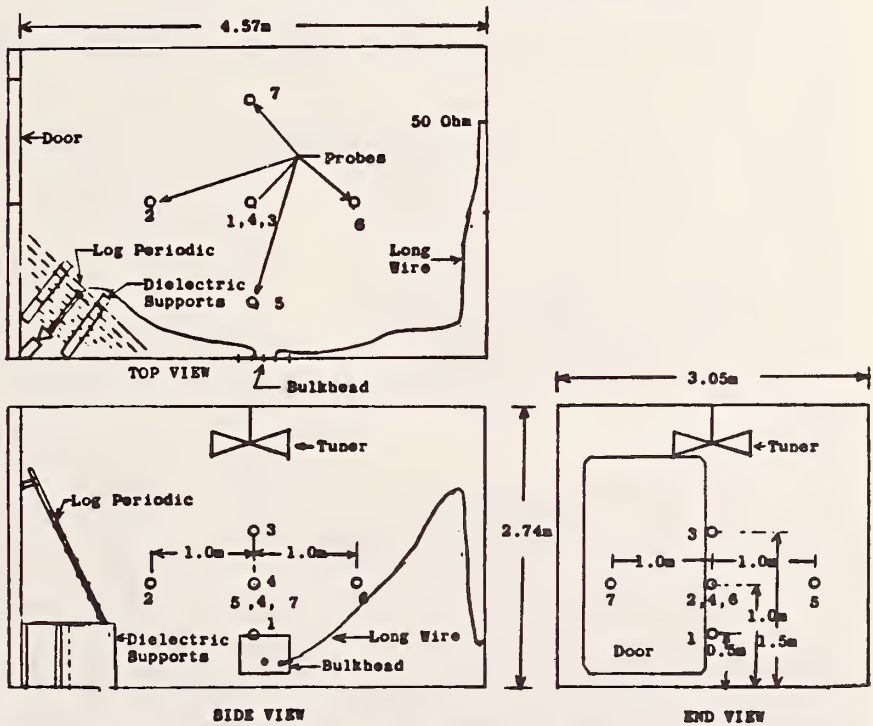

Figure 2.19b. Cross sectional views of NBS reverberation chamber for use at frequencies below 1.0 GHz showing location of antenna and array of NBS probes.

Figure 2.19 Cross sectional views of NBS reverberation chamber showing placement of tuner, transmitting and receiving antennas, and NBS probes.

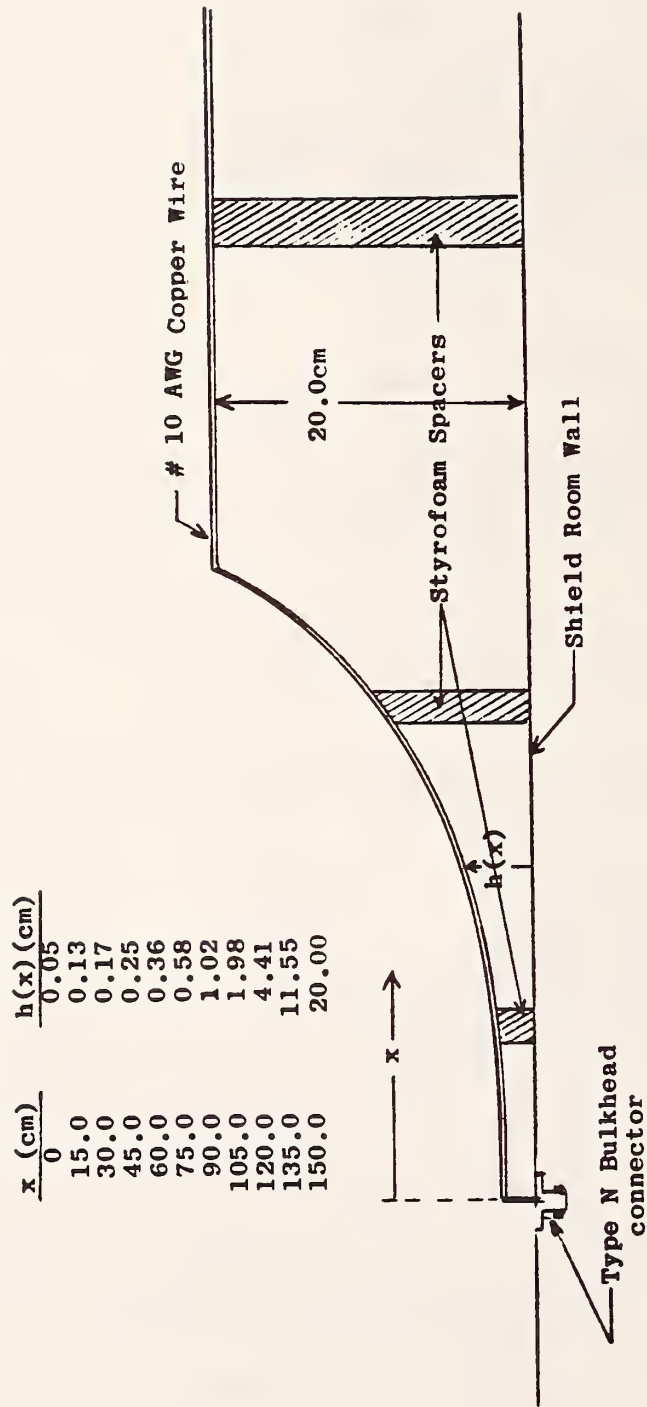

Figure 2.20 Design of taper section of long wire antenna for use in Reverberation chamber.

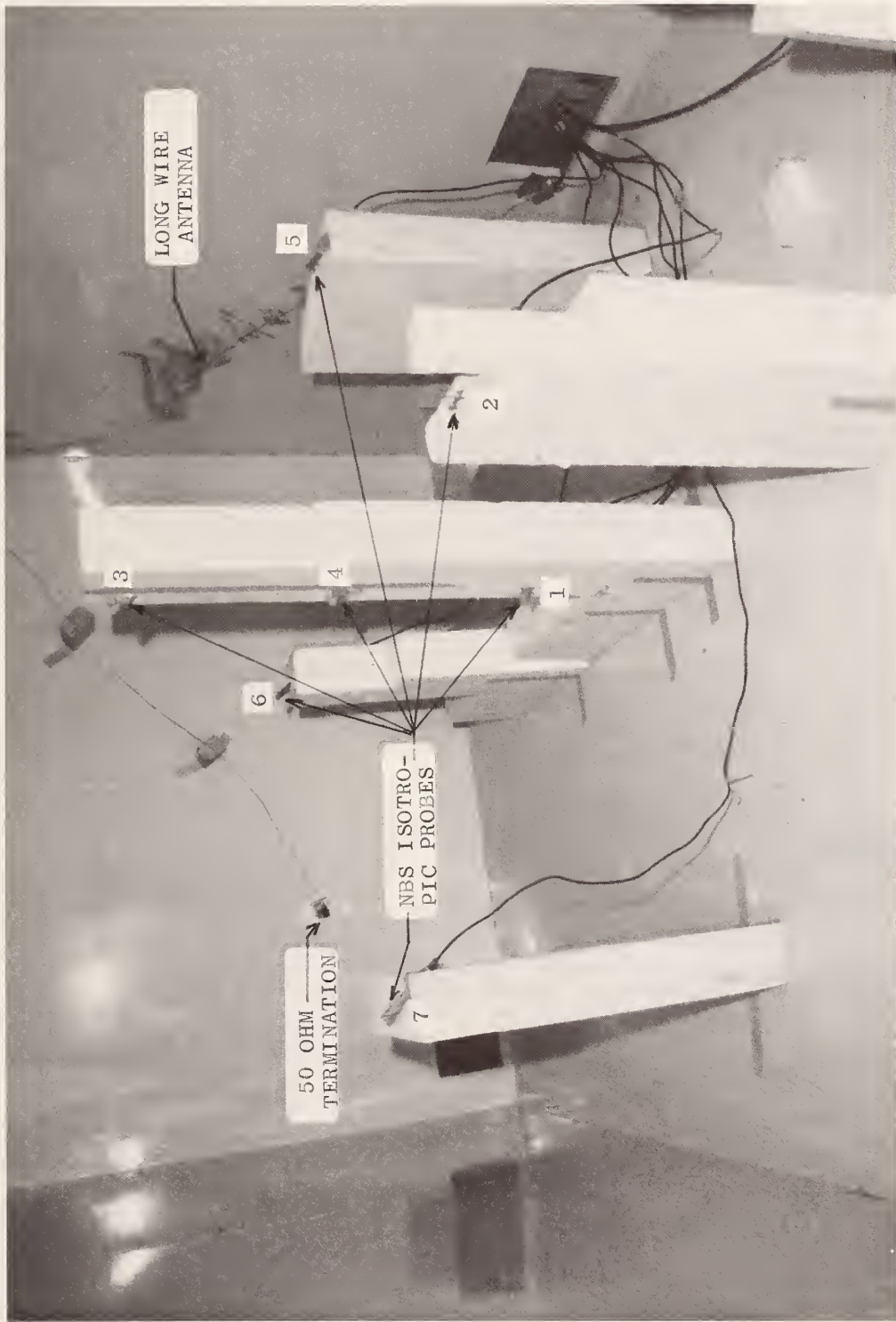

Figure 2.21 Photograph showing long wire antenna and NBS probes placement inside NBS reverberation chamber.

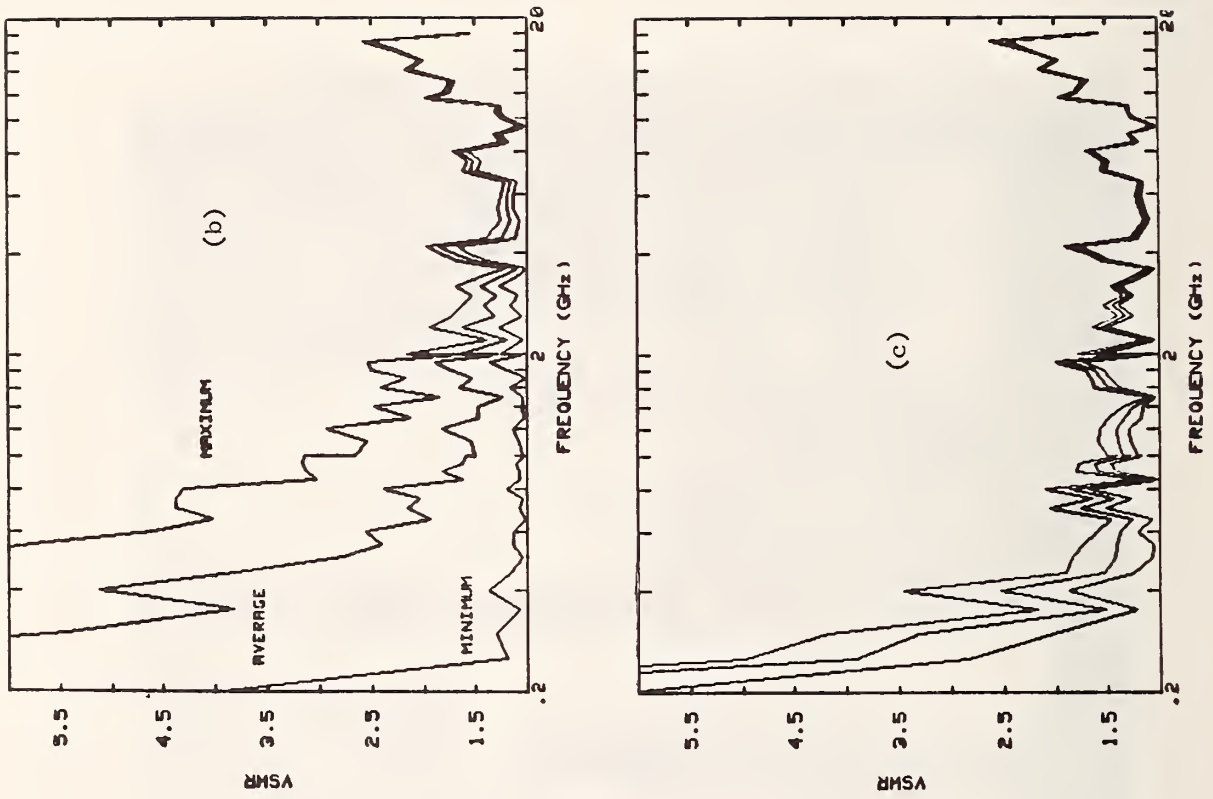

Figure 2.22 VSWR of transmitting antennas placed inside NBS reverberation chamber. a) Long wire antenna, chamber empty; b) composite of three antennas, (log-periodic, 0.2-1.0 GHz), ridged horn, 1.0-4.0 GHz), and (double ridged circular horn, 4.0-18 GHz), chamber empty; and c) composite of three antennas with chamber loaded with 4 pieces of 66 cm rf absorber placed upright in center of chamber, 0.5 m above floor.

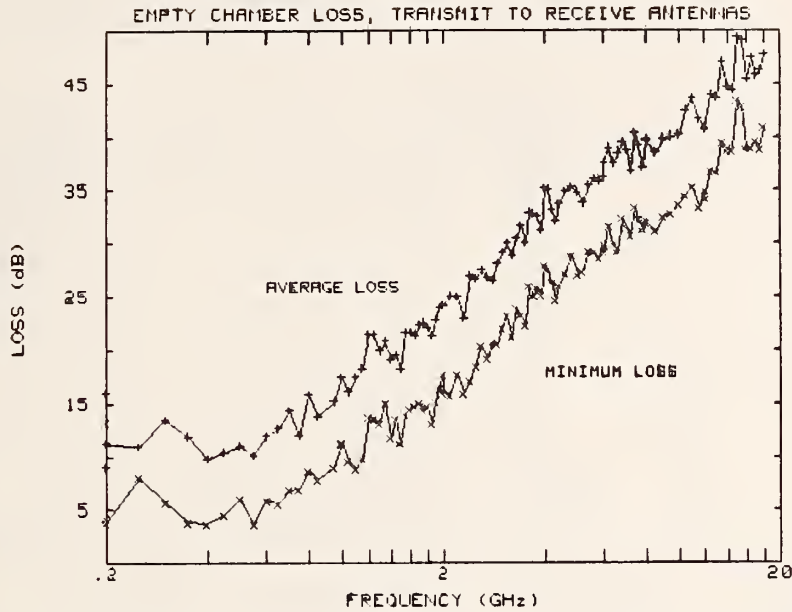

Figure 2.23 Average and minimum losses between transmitted and received powers measured at antennas' terminals inside NBS reverberation chamber. Long wire antenna transmitting (200 MHz - 18 GHz), composite of three antenna receiving (log periodic 200 MHz - 1000 MHz, ridged horn, 1.0 GHz - 4.0 GHz, double ridged circular horn, 4.0 GHz - 18 GHz).

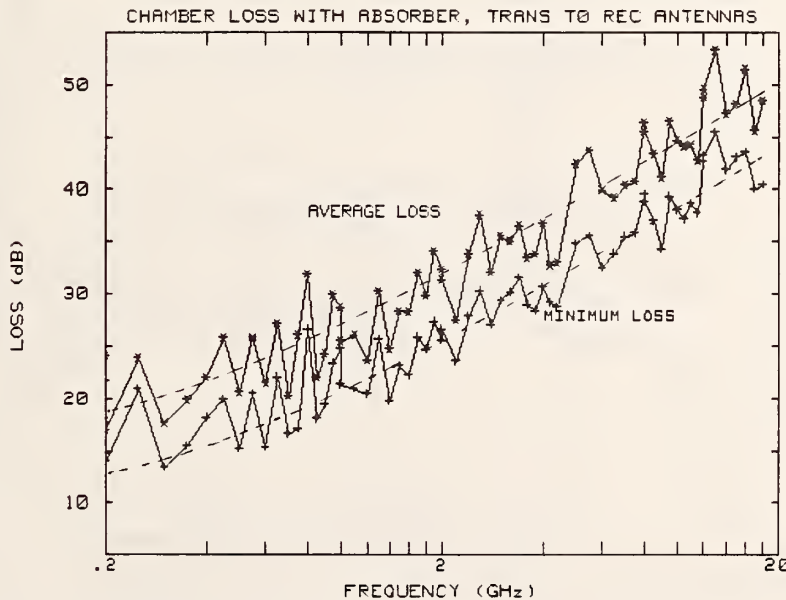

Figure 2.24 Average and minimum losses between transmitted and received powers measured at antennas' terminals inside NBS chamber with four pieces of 66 cm rf absorber upright in center of chamber, 0.5 m above floor. Composite of three antennas used for transmitting and receiving.

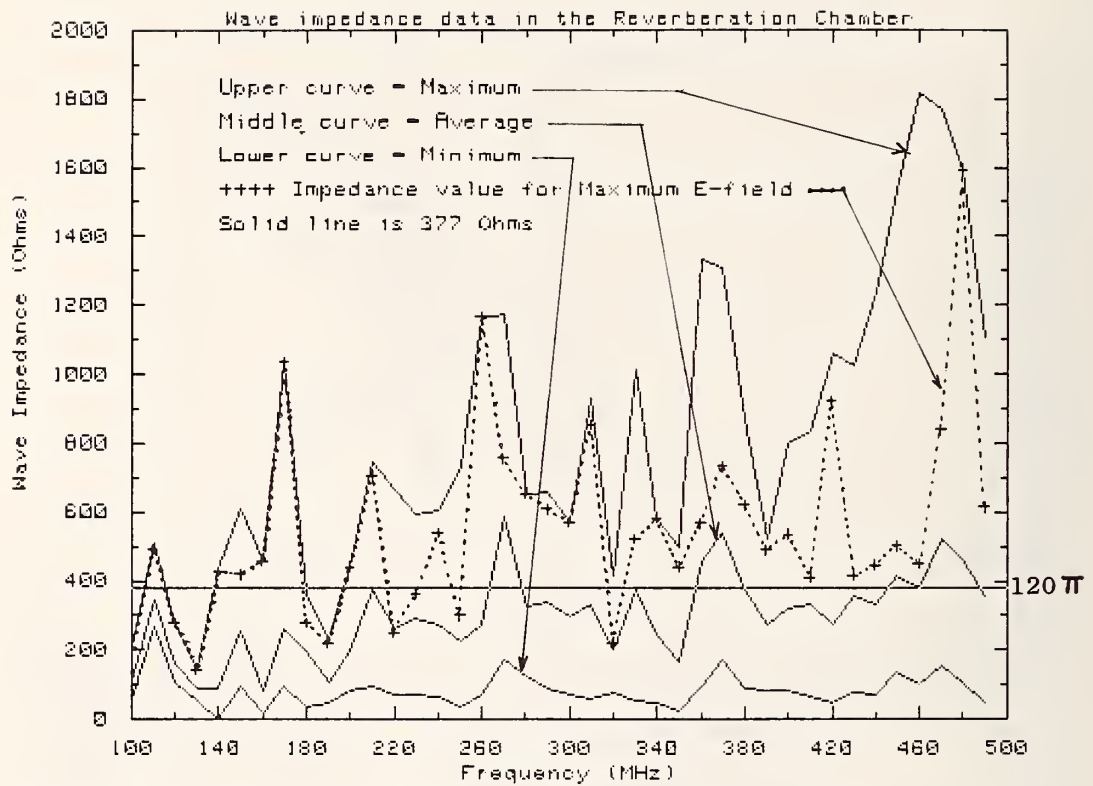

Figure 2.25 Magnitude of wave impedance inside NBS reverberation chamber.

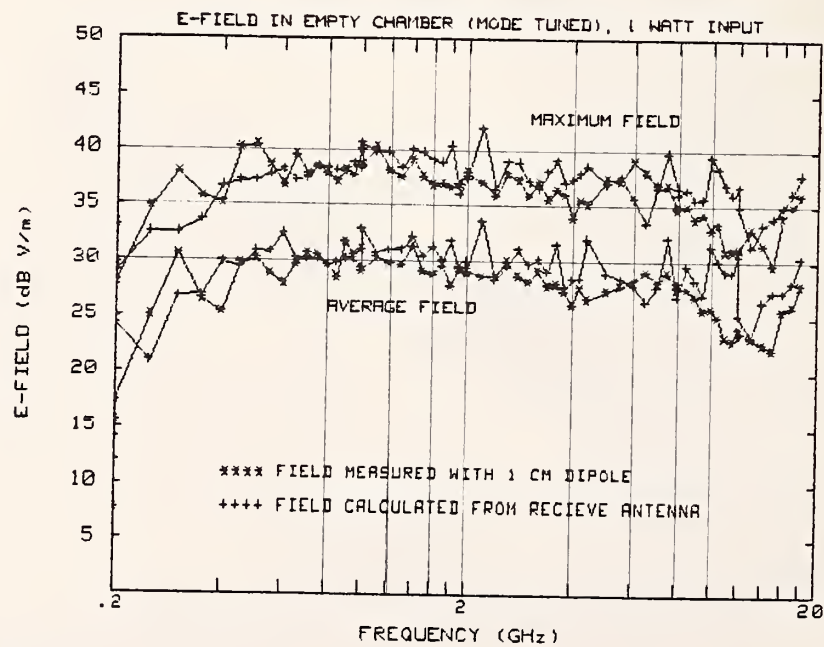
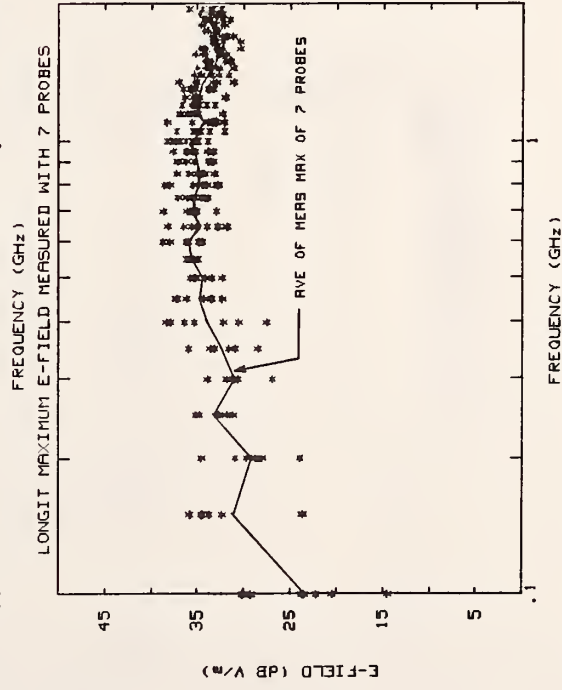
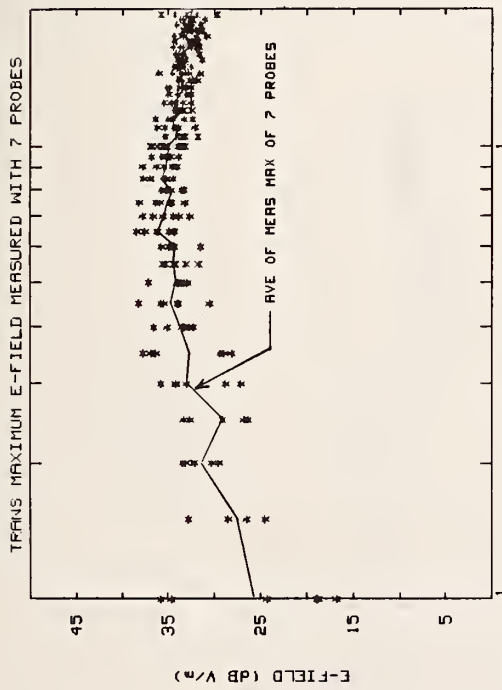
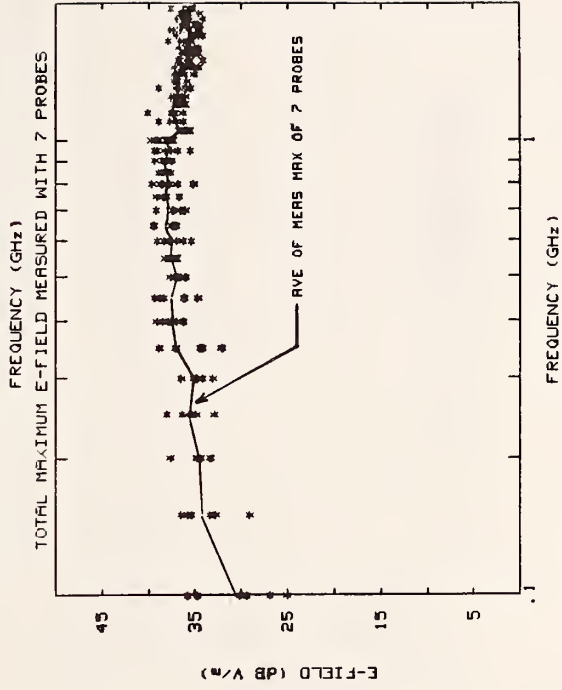
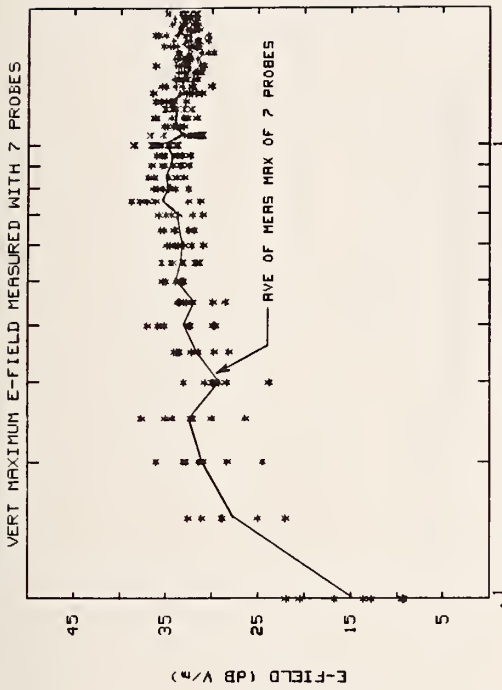
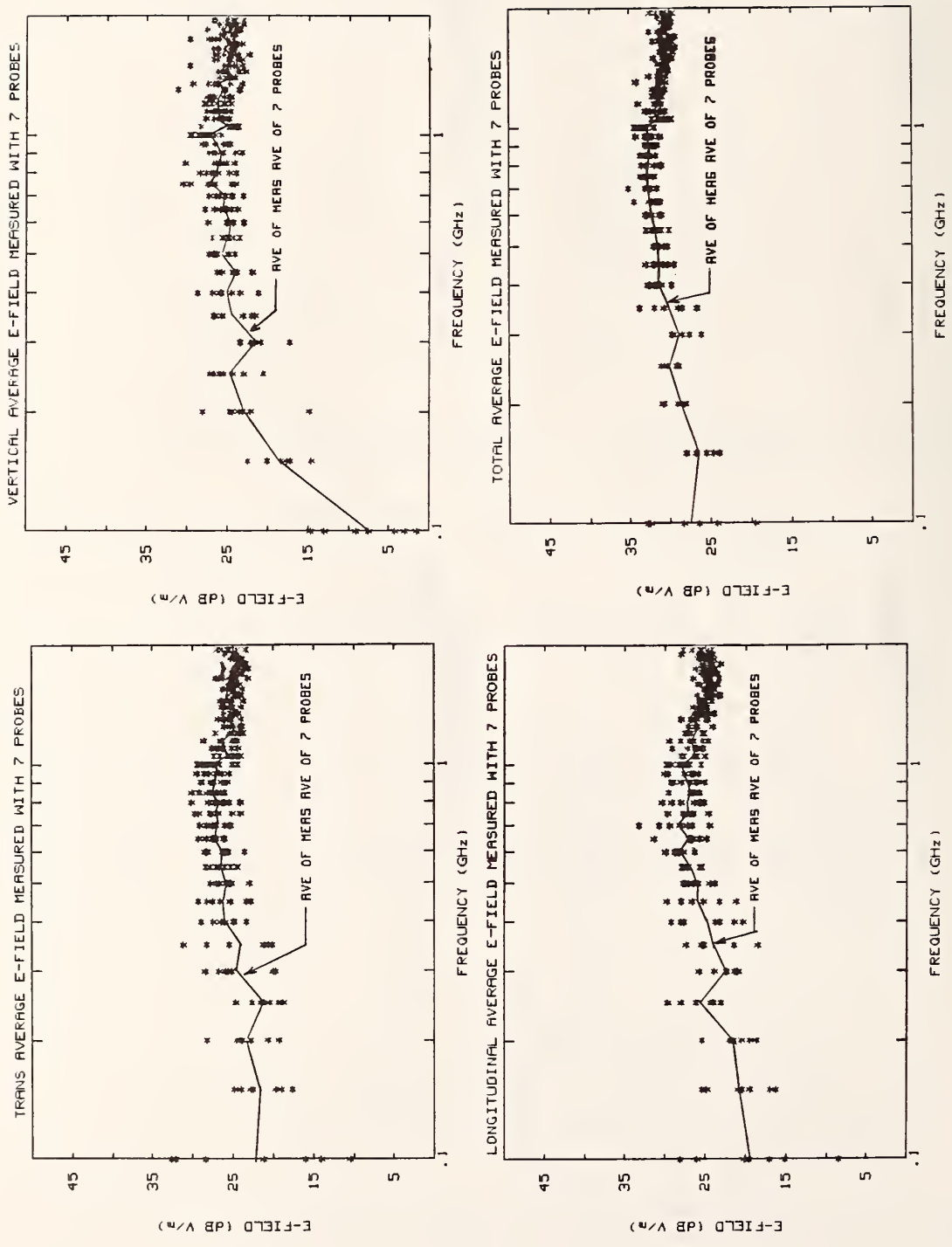

Figure 2.26 Average and maximum E-field strengths inside empty NBS reverberation chamber for 1 W net input power determined from: a) composite of 3 antennas received power measurements, and b) calibrated 1 cm dipole probe measurements.



(a)



(b)

Figure 2.27 E-field strength measured inside NBS reverberation chamber using array of 7 NBS isotropic probes: (a) maximum, and (b) average. Net power normalized to 1 Watt. Transmitting antennas are: log periodic (100 MHz - 1 GHz), ridged horn (1 GHz - 2 GHz).

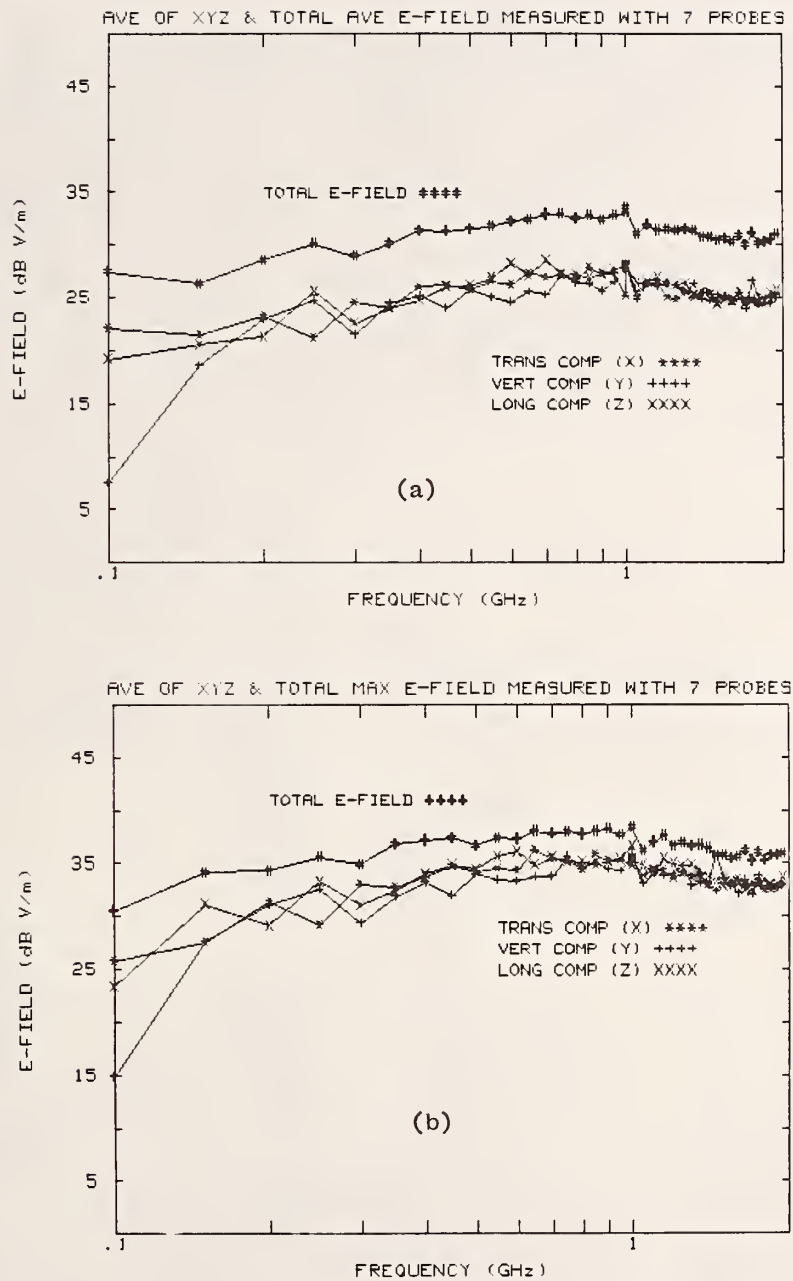

Figure 2.28 Mean values of the E-field strength measured inside NBS reverberation chamber using array of 7 NBS isotropic probes with 1 W net input power: (a) average, and (b) maximum. Data determined from maximum and average values of the 7 probes (7 locations) for the three orthogonal components and their sum (total) using 200 tuner positions (1.8 degree increments).



Figure 3.1a Photograph showing 30 cm x 50 cm x 60 cm welded aluminum box inside NBS reverberation chamber.

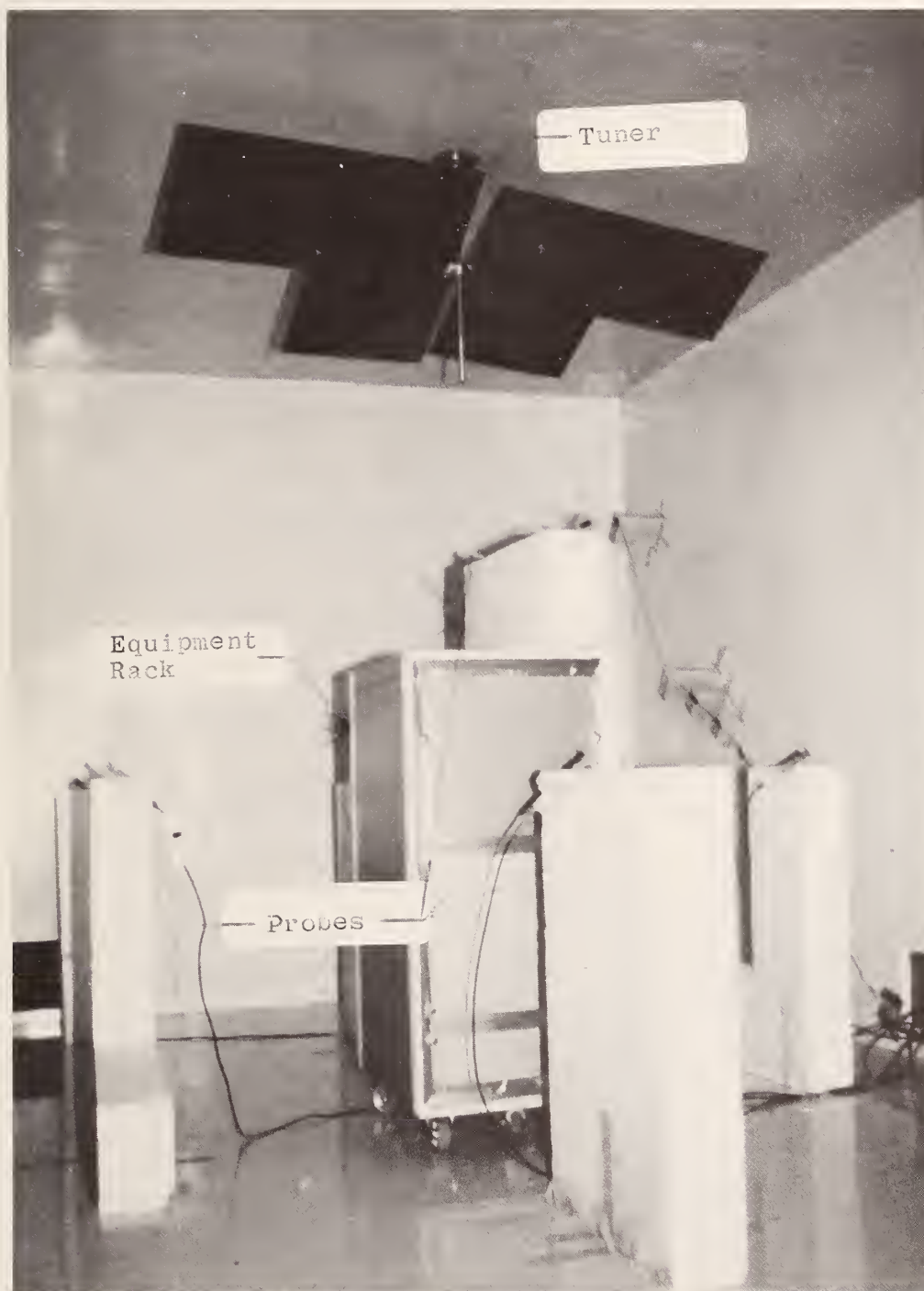

Figure 3.1b Photograph showing rolling equipment rack inside NBS reverberation chamber.

Figure 3.1 Placement of metallic objects inside NBS reverberation chamber to evaluate scattering effects upon E-field spatial distribution. a) Photograph showing 30 cm x 50 cm x 60 cm welded aluminum box inside NBS reverberation chamber. b) Photograph showing rolling equipment rack inside NBS reverberation chamber.

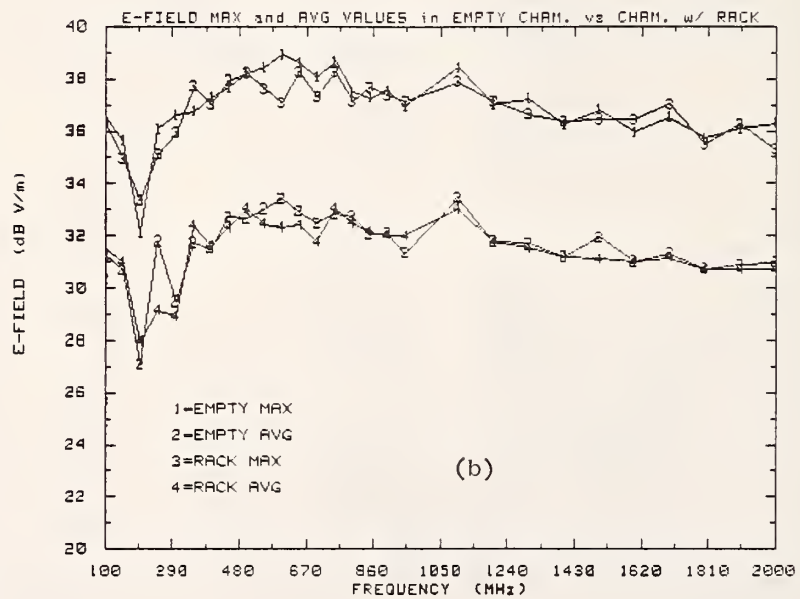
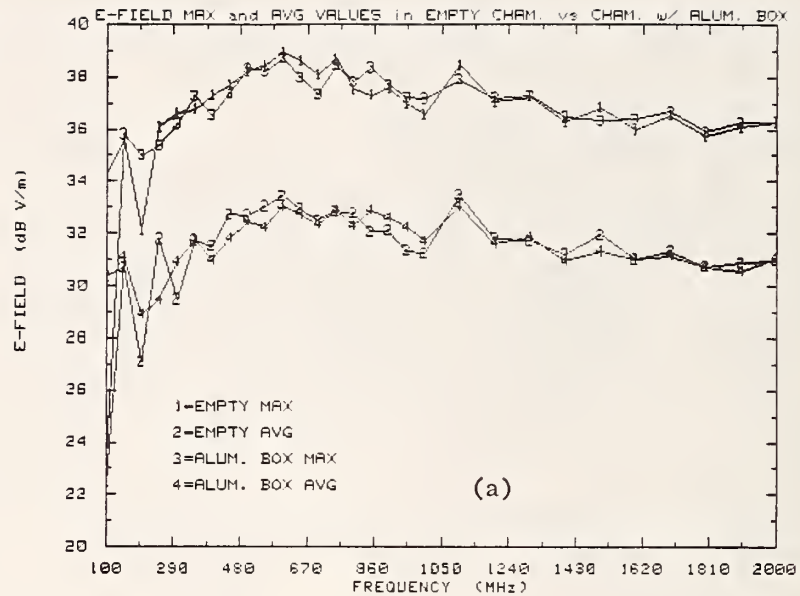

Figure 3.2 Comparison of the mean value of the average and maximum E-field strength measured using array of probes placed inside NBS reverberation chamber with chamber empty or with scattering object placed at center of test zone. a) 30 cm x 50 cm x 60 cm aluminum box, b) Rolling equipment rack.

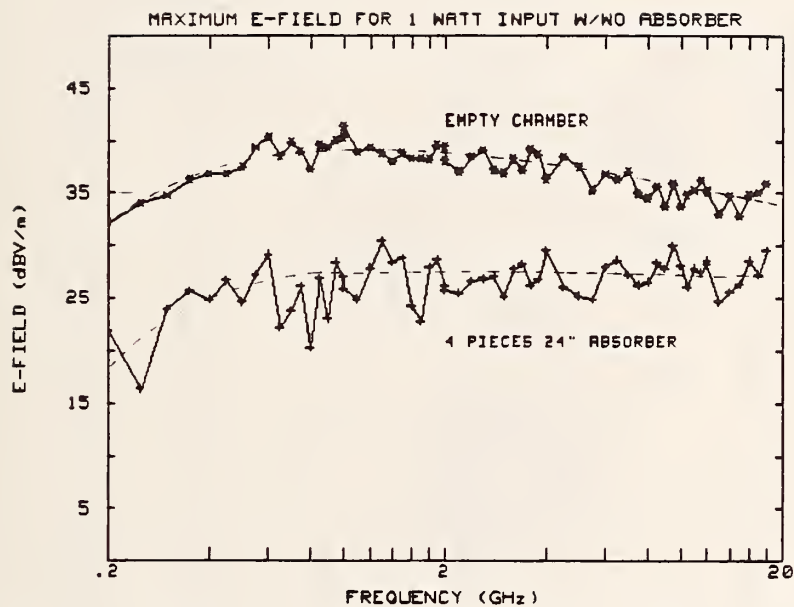

Figure 3.3 Maximum E-field strength inside empty chamber and chamber loaded with 4 pieces of 66 cm rf absorber for 1 W net input power determined from composite of 3 antennas received power measurements. Data obtained using mode stirring approach.

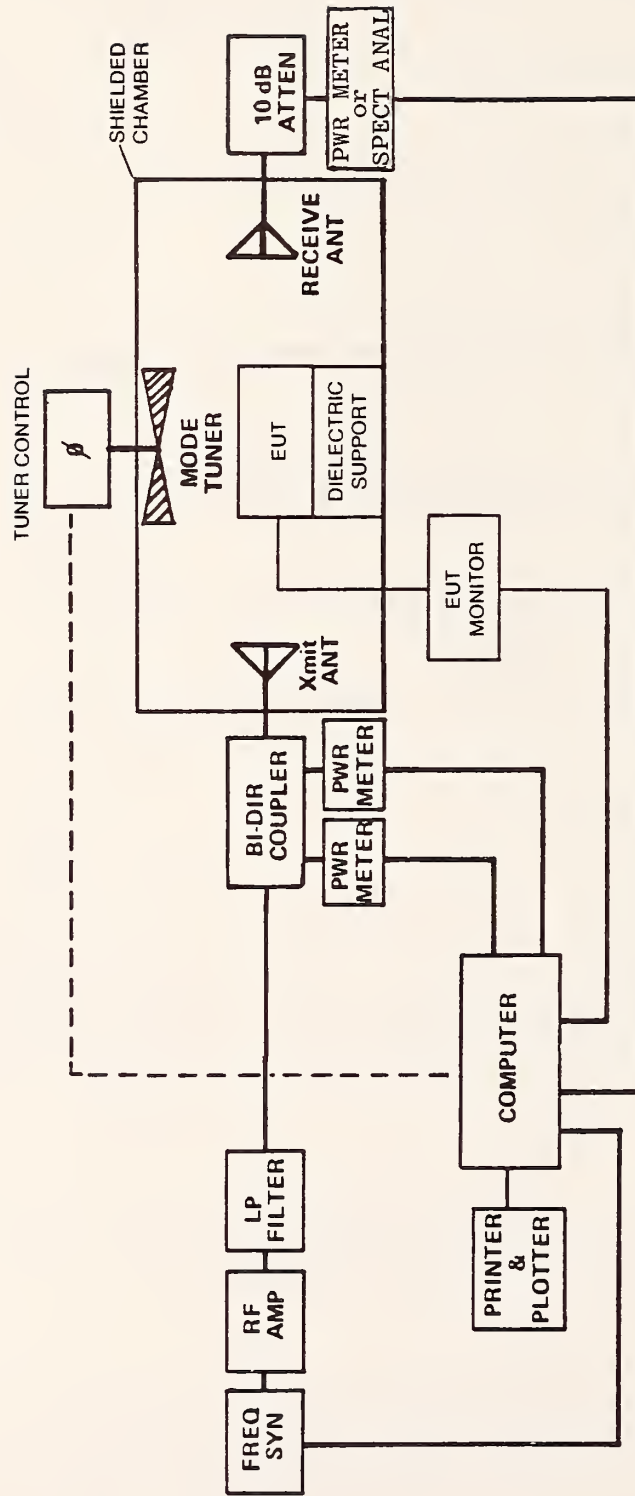

Figure 4.1 Block diagram of NBS reverberation chamber evaluation and EMC measurement system.

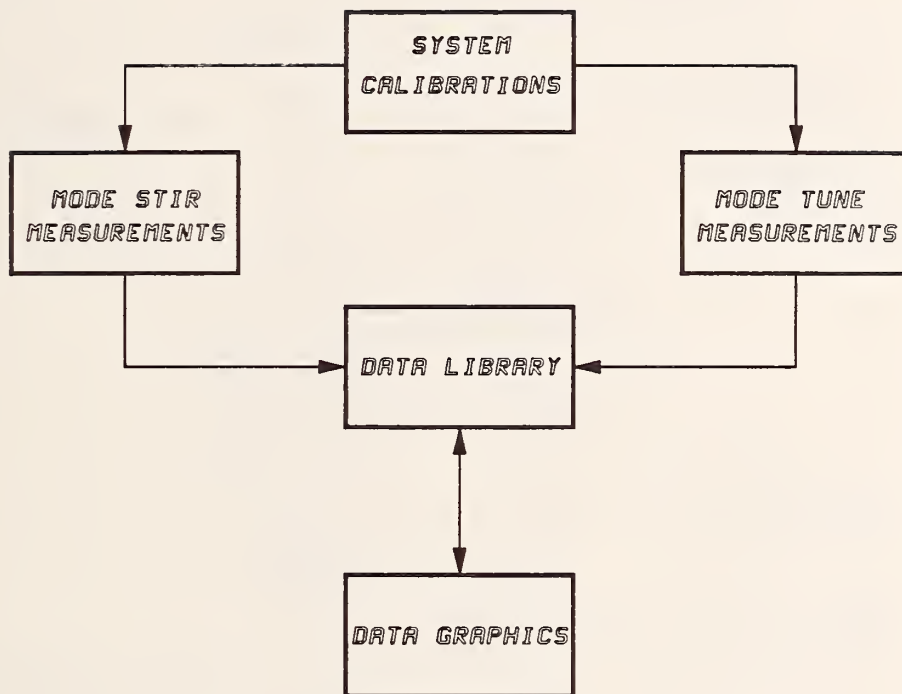

Figure 4.2 Major software tasks for performing and evaluation susceptibility tests using a reverberation chamber.

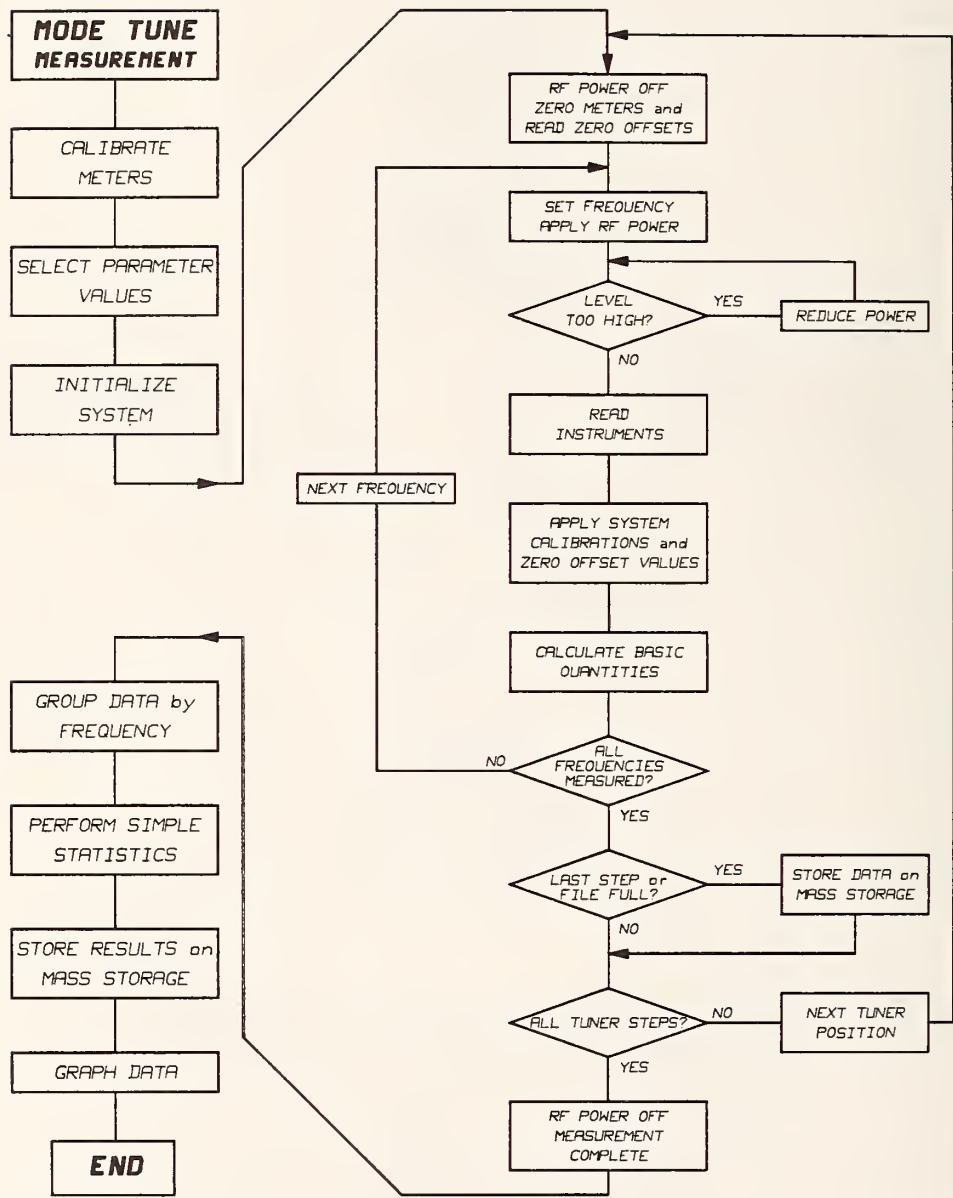

Figure 4.3 Flow diagram for mode-tuned measurements.

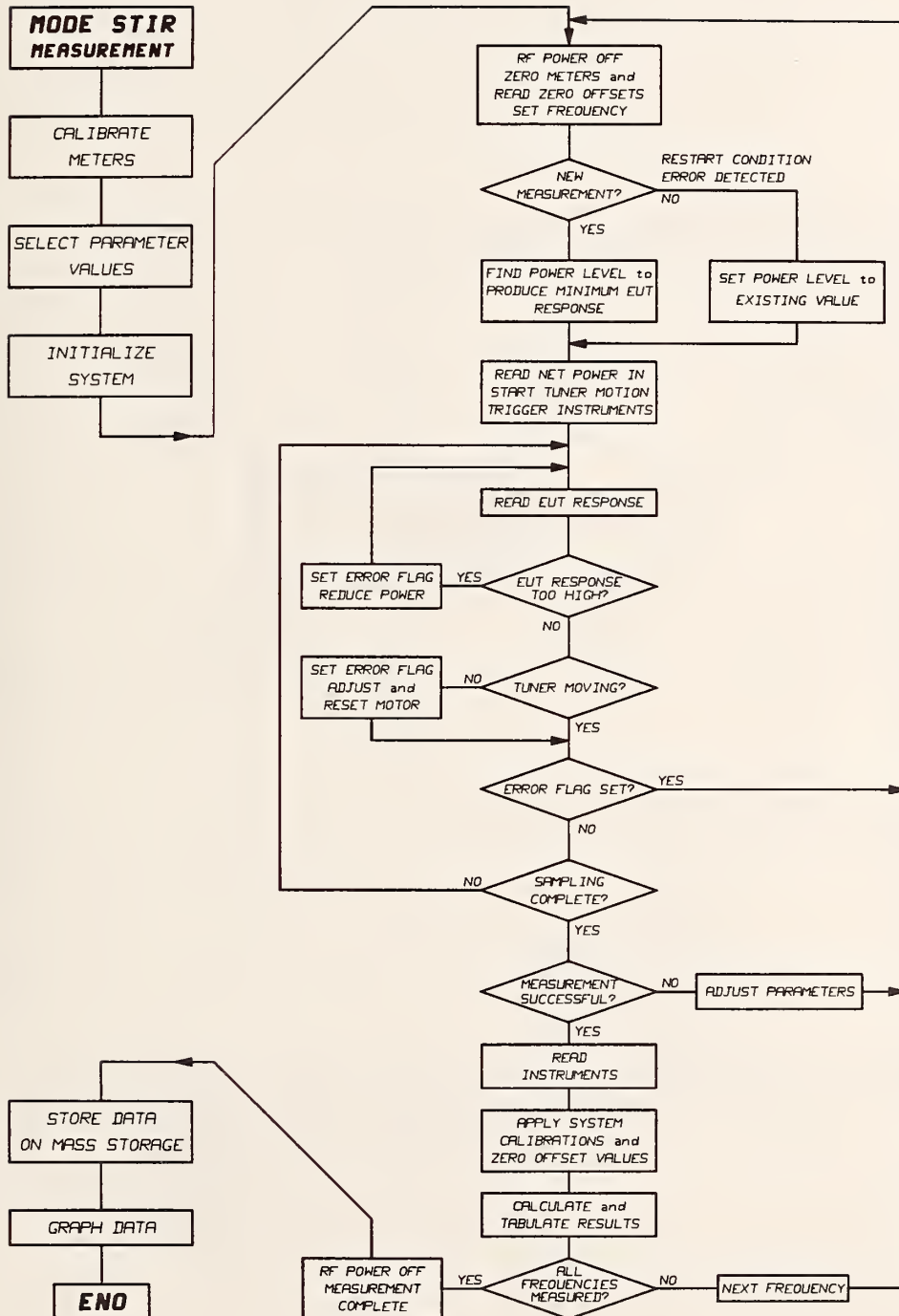

Figure 4.4 Flow diagram for mode-stirred measurements.

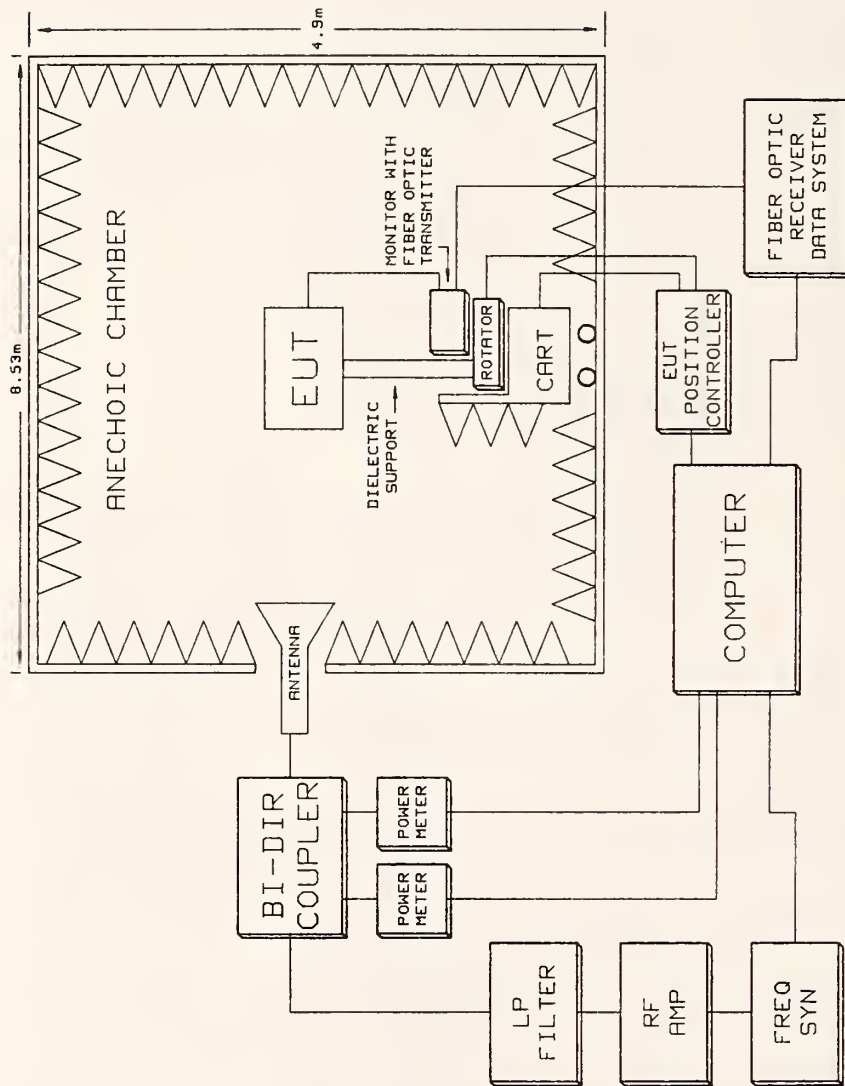

Figure 5.1 Block diagram of NBS anechoic chamber EMC/EMI measurement system. Side view of chamber. The outside width is 6.7 m.

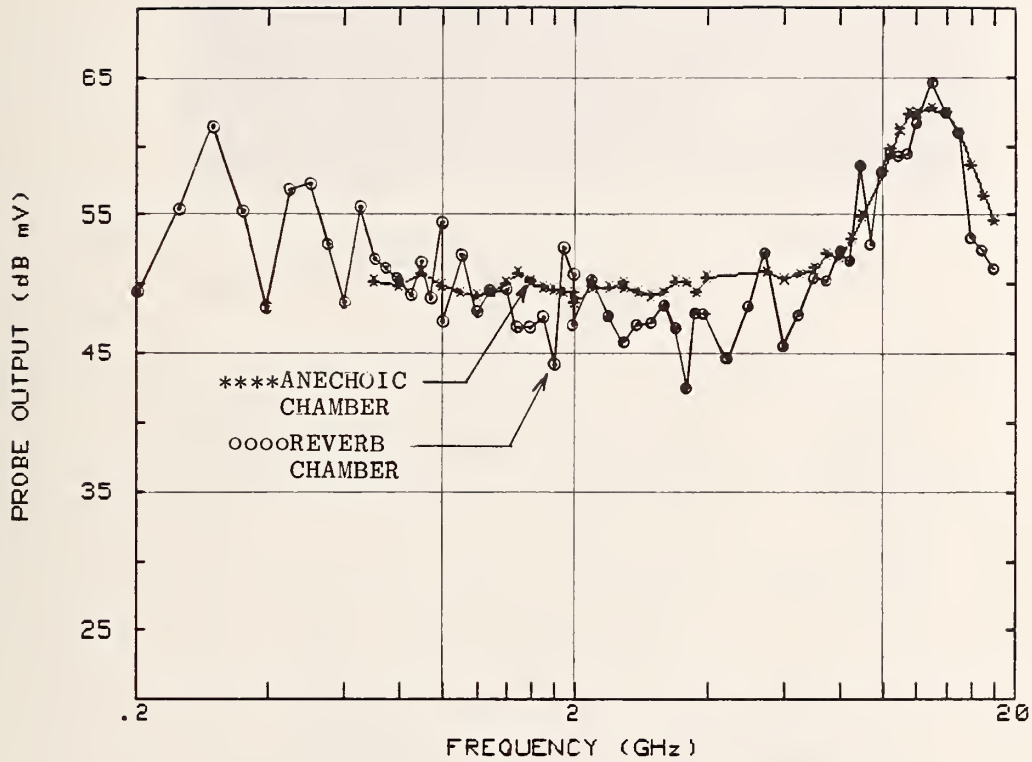

Figure 5.2 Comparison of 1 cm dipole probe's peak responses to EM field established inside NBS reverberation and anechoic chambers. Output normalized to E-field exposure of 37 dB V/m.

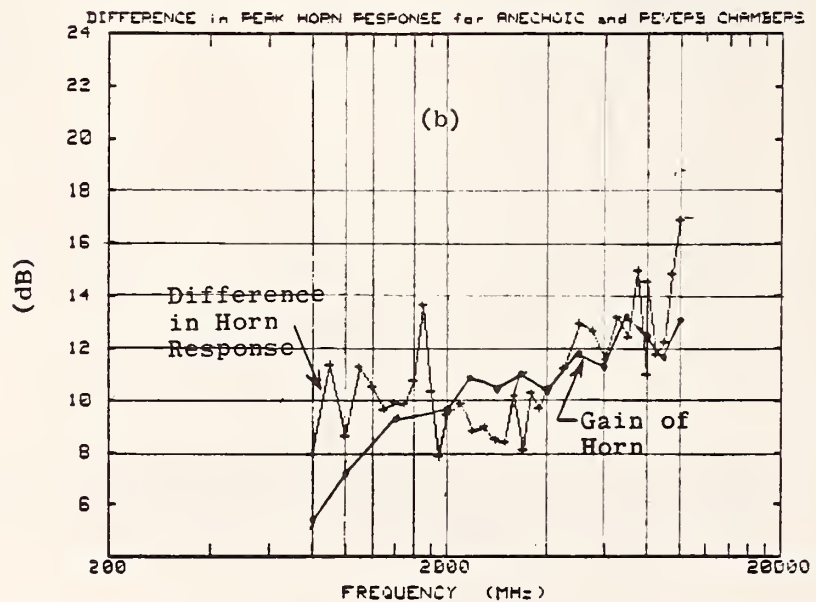
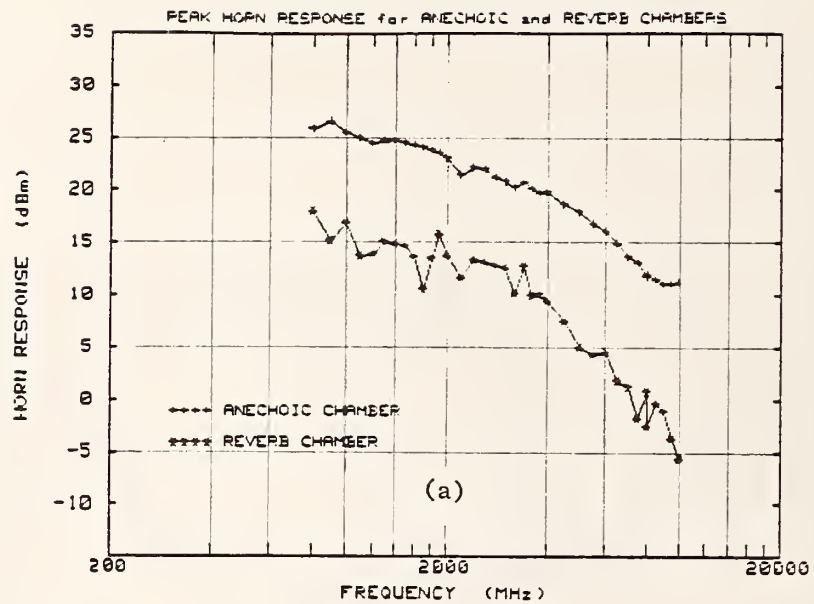

Figure 5.3 Comparison of ridged horn's peak responses to EM field established inside NBS reverberation and anechoic chambers. Output from horn normalized to exposure E-field of 37 dB V/m. a) Antenna output versus frequency, b) Difference in output responses of ridged horn measured in NBS reverberation and anechoic chambers compared to calibrated gain of horn.

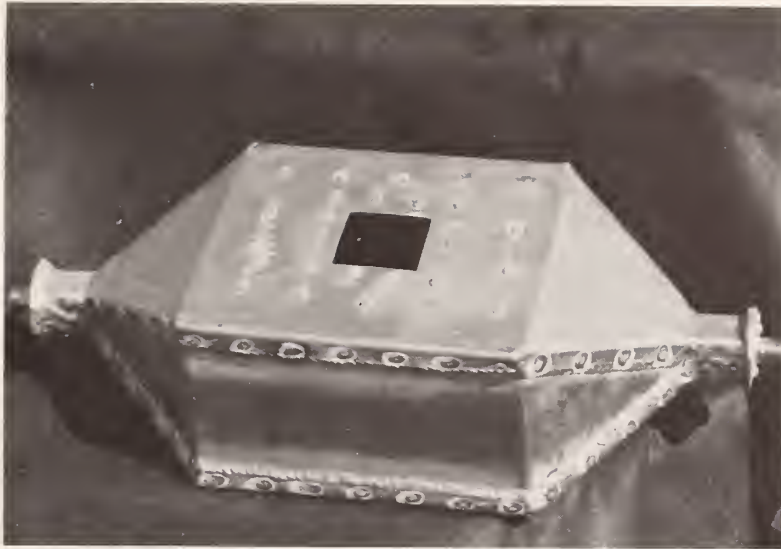

Figure 5.4 Photograph of 12 cm x 18 cm x 36 cm rectangular TEM cell with 5.1 cm x 5.1 cm aperture.

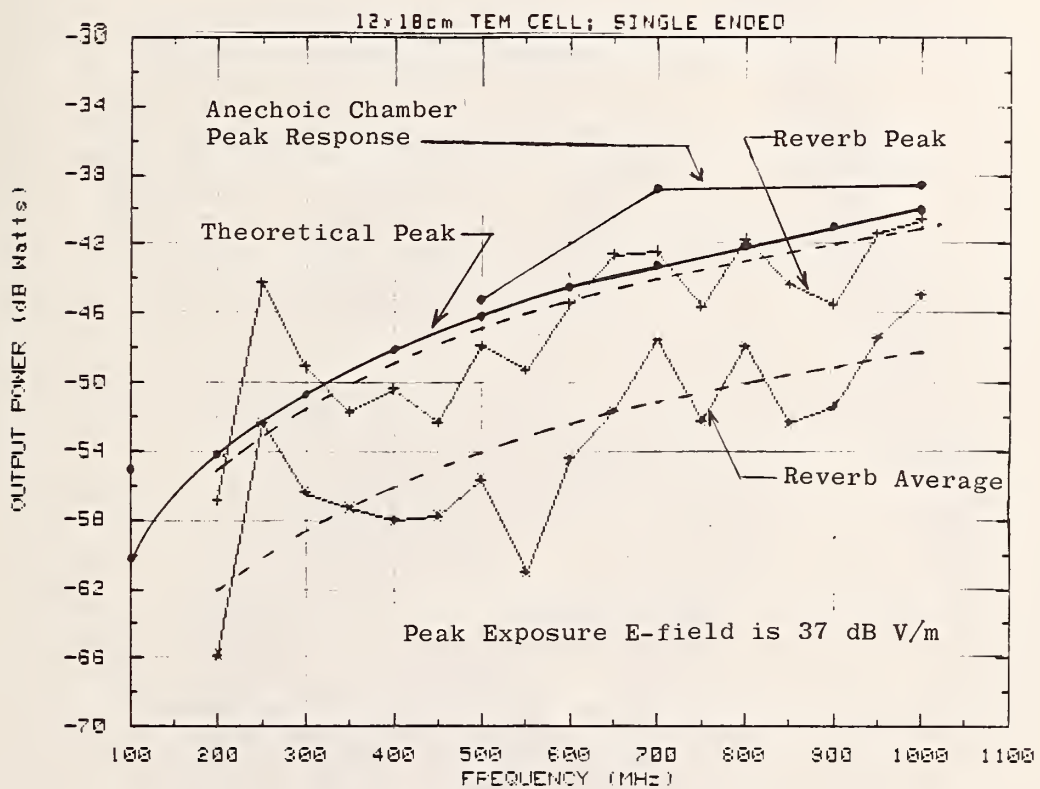

Figure 5.5 Comparison of power coupled to one port of 12 cm x 18 cm x 36 cm TEM cell with 5.1 cm x 5.1 cm aperture placed inside NBS reverberation and anechoic chambers.

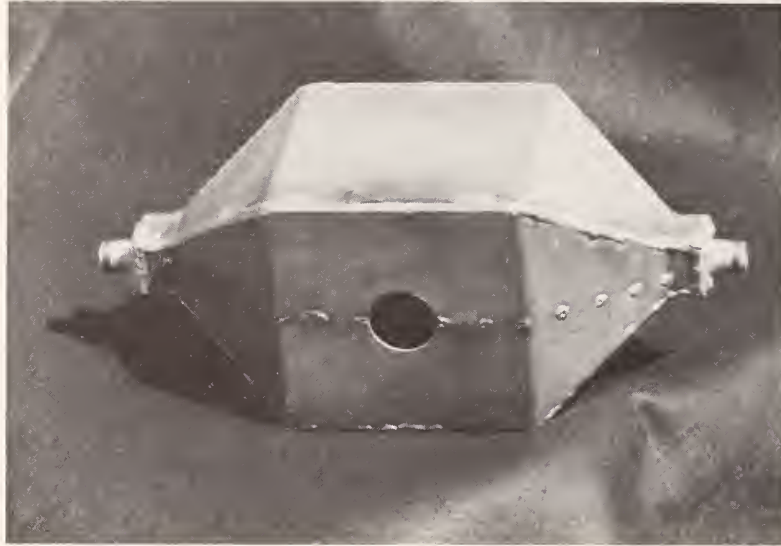

Figure 5.6 Photograph of 12 cm x 12 cm x 24 cm rectangular TEM cell with 3.1 cm diameter aperture.

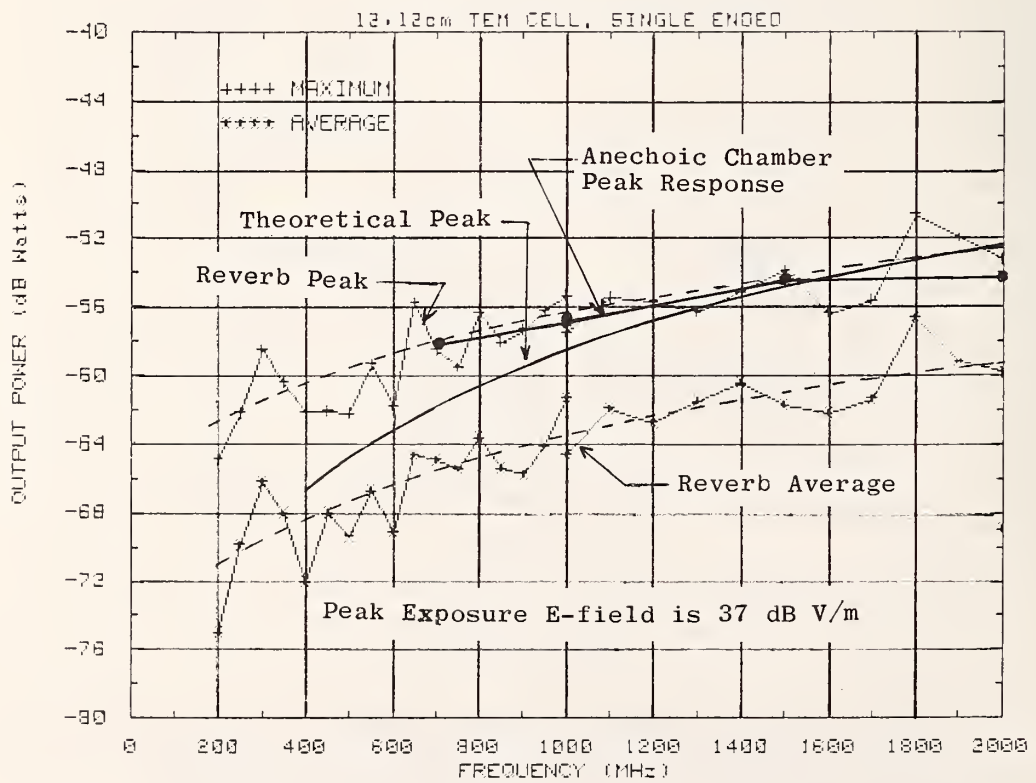

Figure 5.7 Comparison of power coupled to one port of 12 cm x 12 cm x 24 cm TEM cell with 3.1 cm diameter aperture placed inside NBS reverberation and anechoic chambers.



Figure 5.8 Photograph of 3.0 cm x 6.0 cm x 11.4 cm rectangular TEM cell with 1.4 cm diameter aperture.

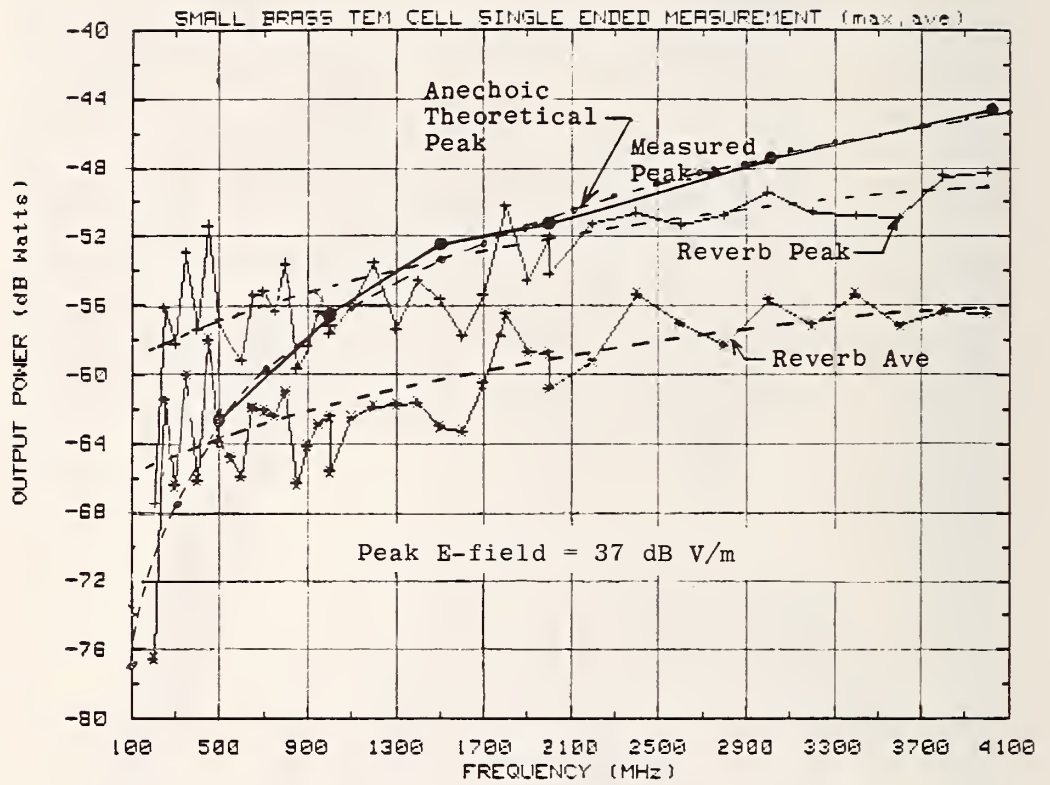

Figure 5.9 Comparison of power coupled to one port of 3.0 cm x 6.0 cm x 11.4 cm TEM cell with 1.4 cm diameter aperture placed inside NBS reverberation and anechoic chambers.



Figure 5.10 Photograph of modified 7.0 cm Folding Fin Aircraft Rocket inside NBS reverberation chamber.



Figure 5.11 Photograph of modified 7.0 cm Folding Fin Aircraft Rocket inside NBS anechoic chamber.

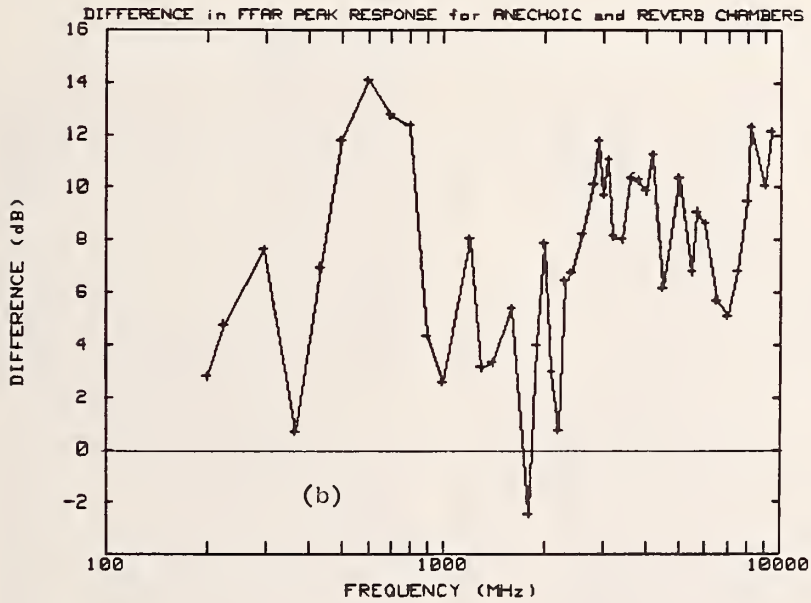
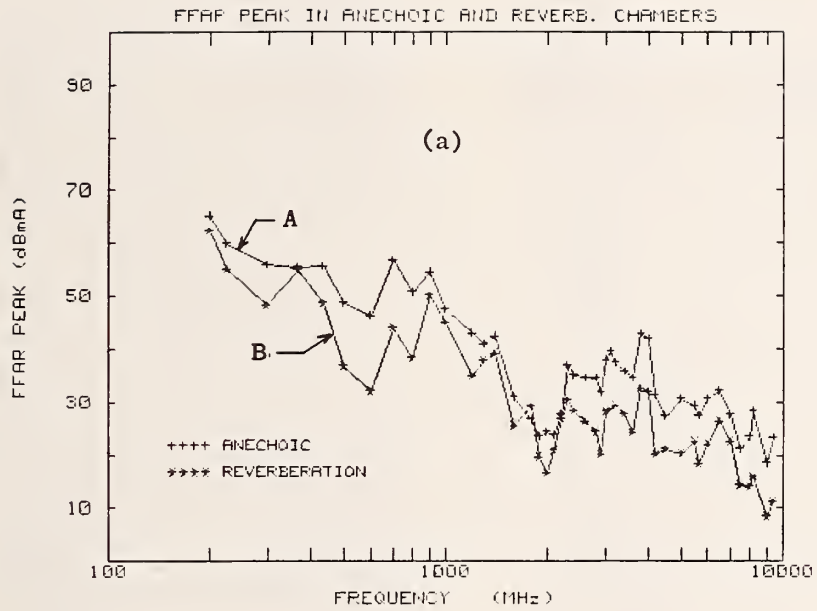

Figure 5.12 Comparison of 7.0 cm modified FFAR thermocouple responses to EM field established inside NBS reverberation and anechoic chambers. Data normalized to exposure power density of 10 mW/cm^2 . a) Thermocouple output vs frequency. b) Difference in thermocouple output measured in NBS reverberation and anechoic chambers.

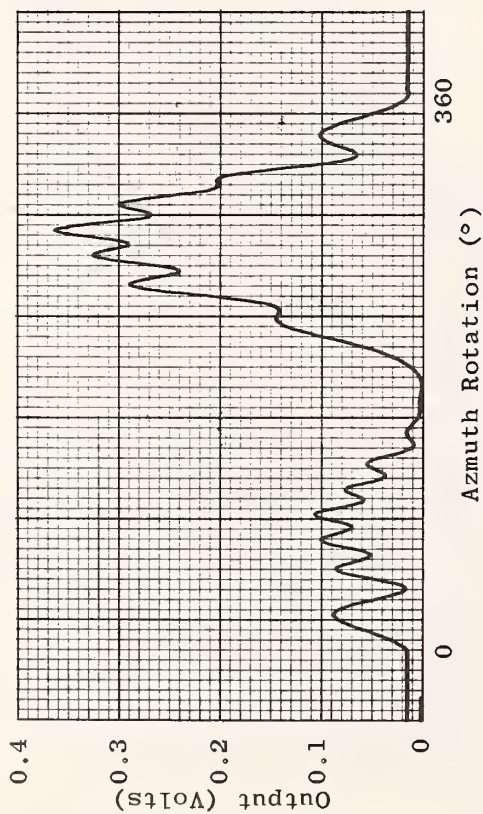

Figure 5.13a 700 MHz, Hor. Polar., Roll = 330°

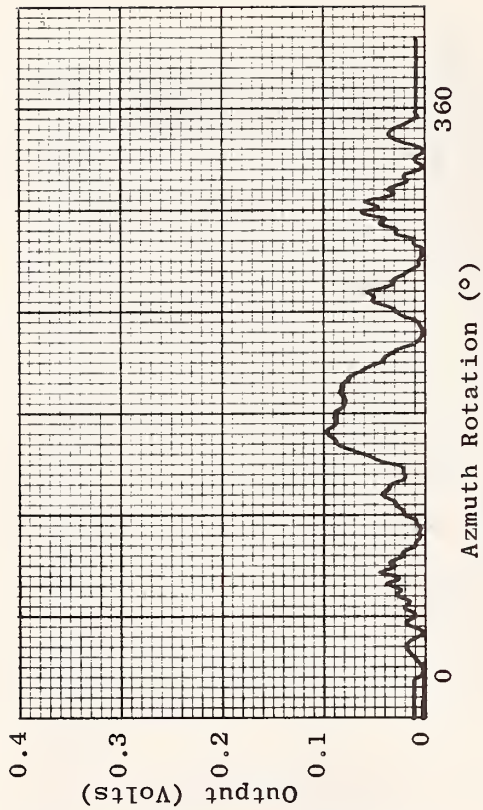

Figure 5.13b 1800 MHz, Hor. Polar., Roll = 0°

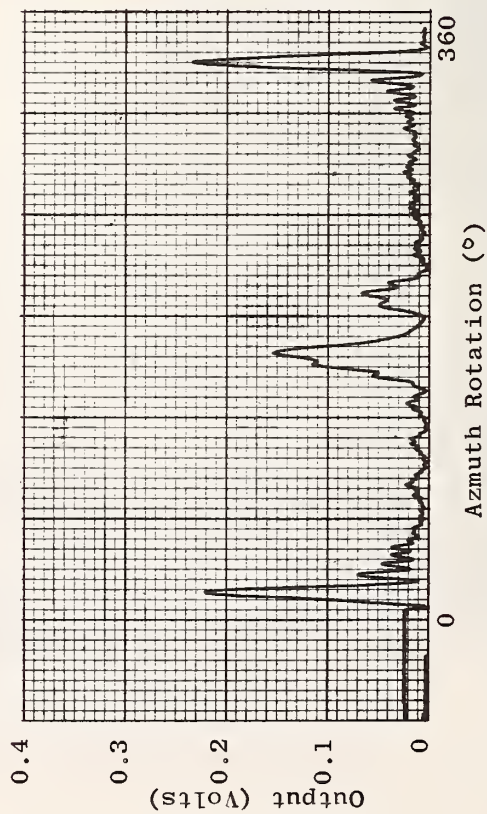

Figure 5.13c 3800 MHz, Hor. Polar., Roll = 0°

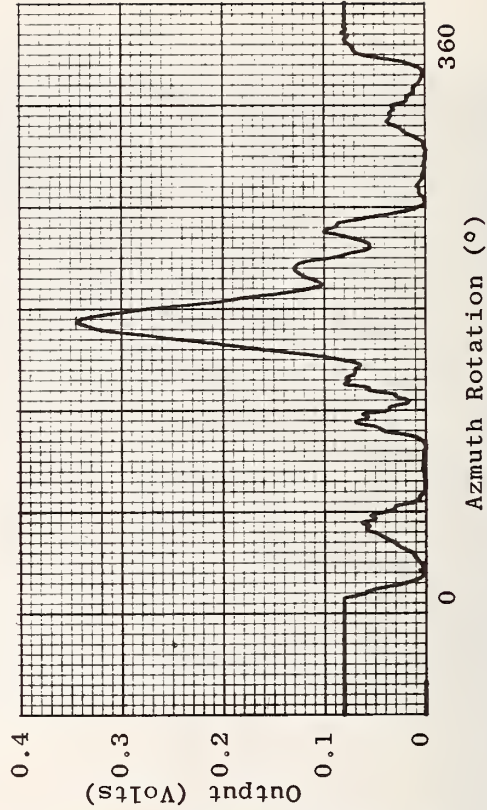

Figure 5.13d 3800 MHz, Vert. Polar., Roll = 0°

Figure 5.13 Examples of azimuth patterns of 7.0 cm modified FFAR thermocouple response taken in NBS anechoic chamber.

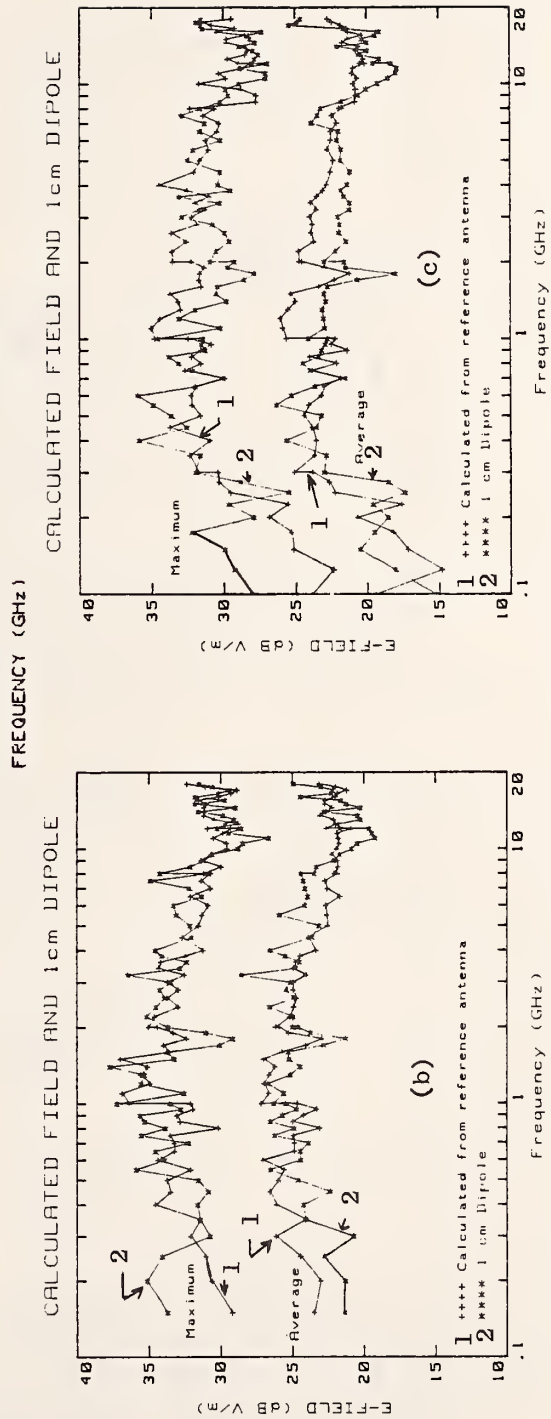
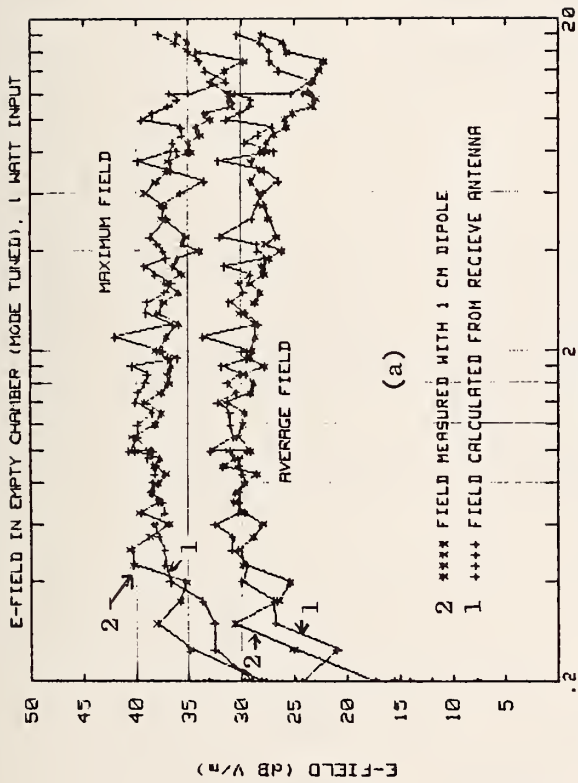

Figure 5.14 Comparison of the average and maximum E-field strengths inside the NBS and NSWC reverberation chambers determined for 1 W net input power using 1) reference antenna received power measurements, and 2) calibrated 1 cm dipole probe measurements. (a) NBS chamber, (b) NSWC half chamber, and (c) NSWC full chamber.

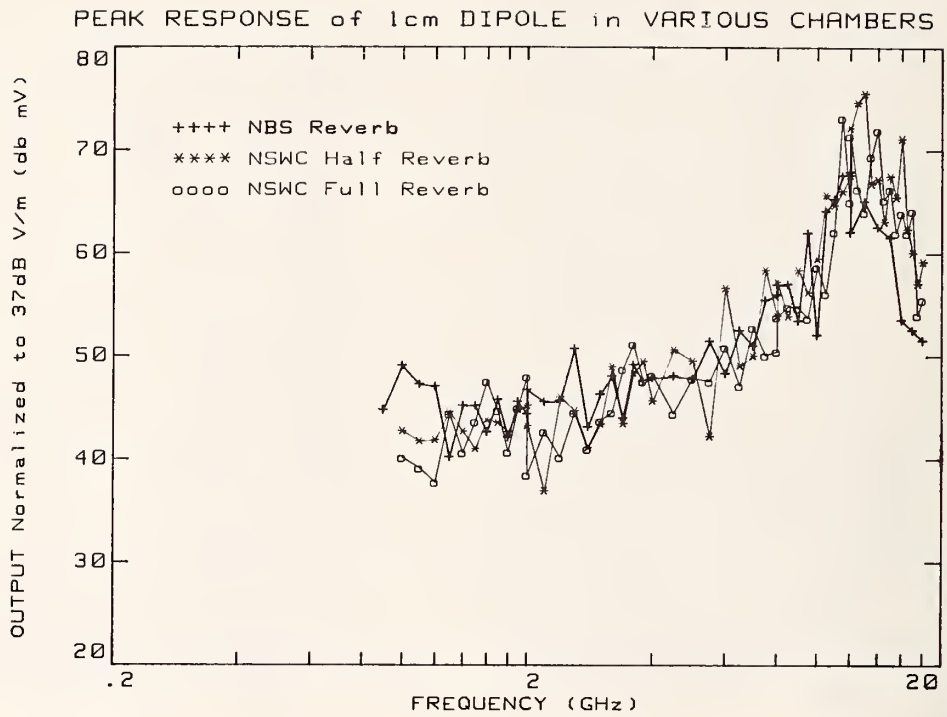

Figure 5.15 Comparison of 1 cm dipole probe's peak response to normalized E-field of 37 dB V/m using NBS and NSWC reverberation chambers.

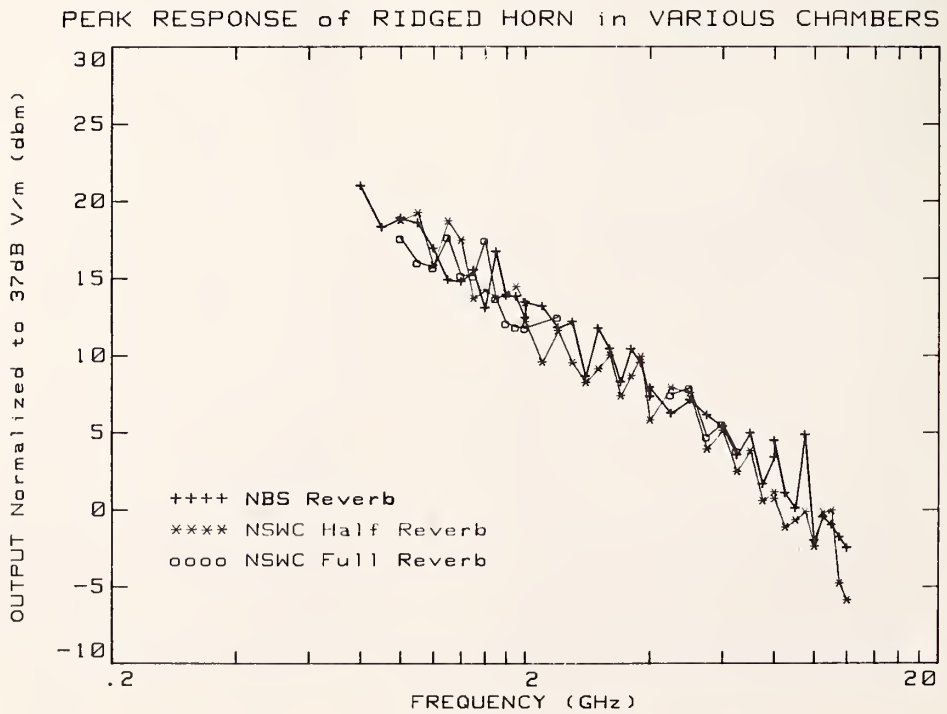

Figure 5.16 Comparison of ridged horn's peak responses to normalized exposure E-field of 37 dB V/m using NBS and NSWC reverberation chambers.

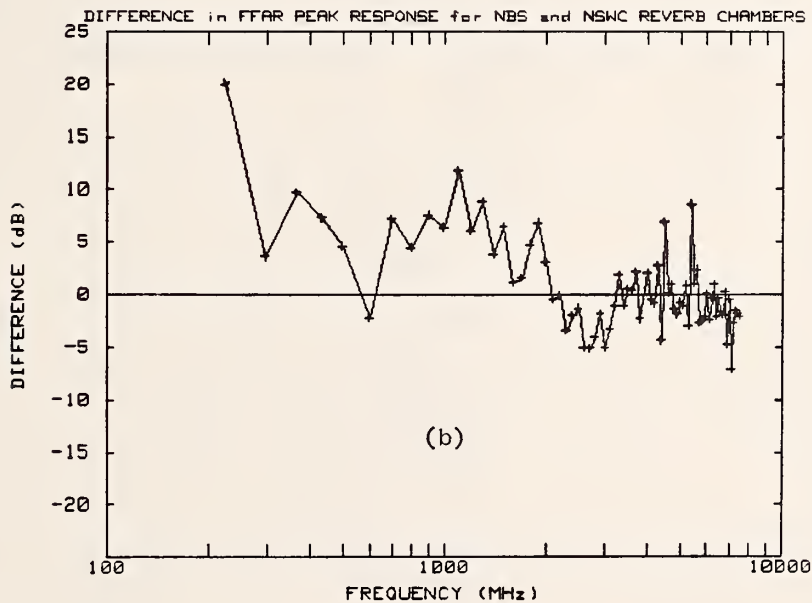
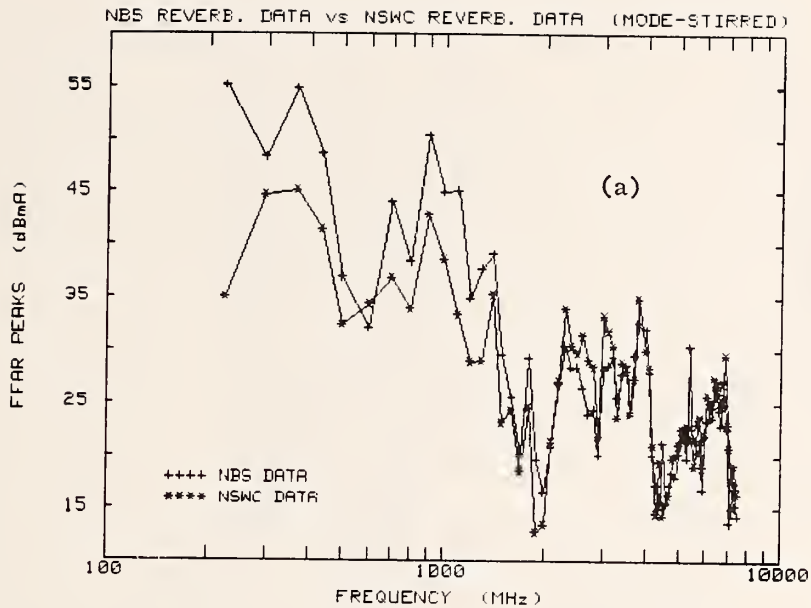
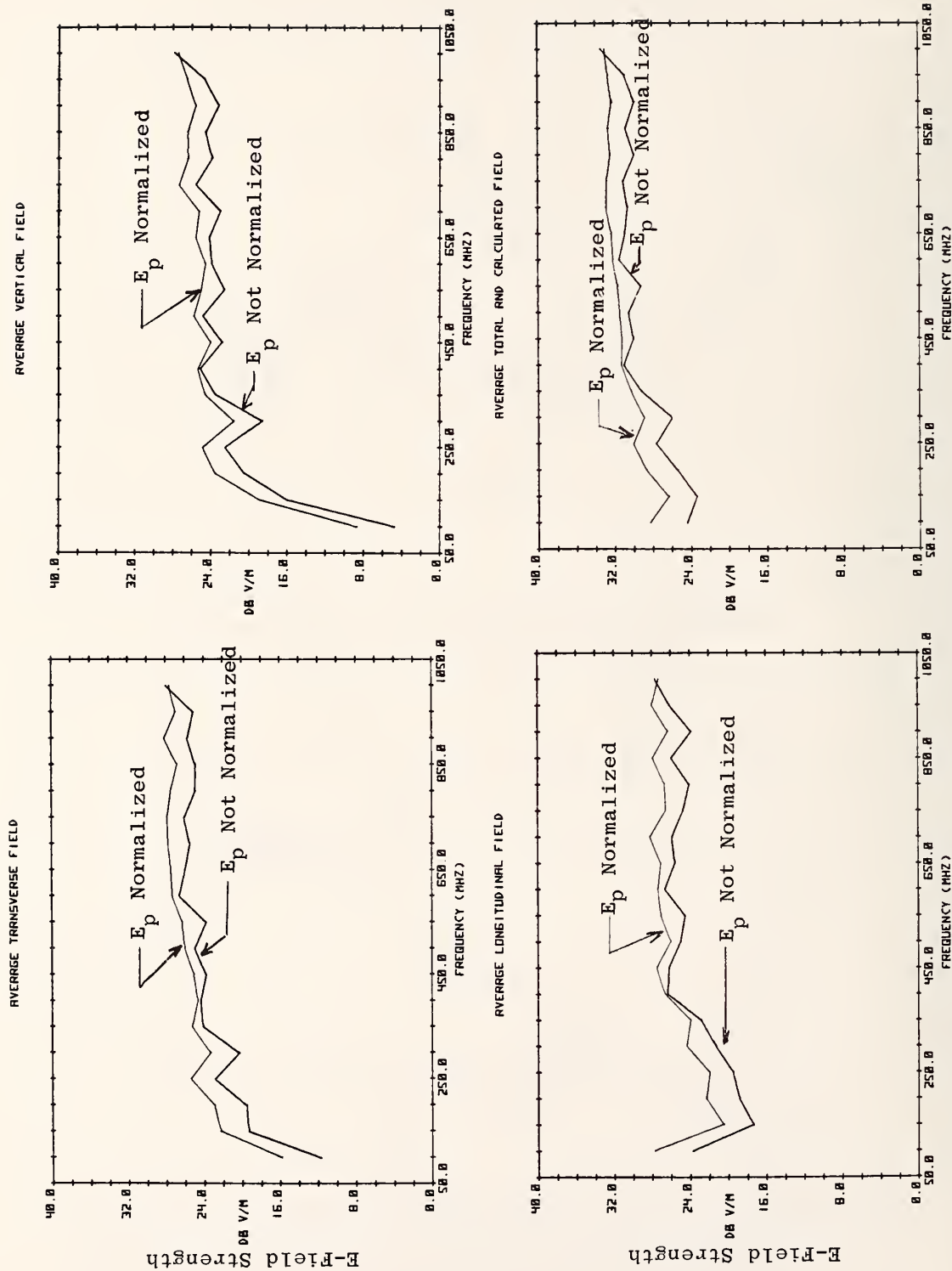

Figure 5.17 Comparison of 7.0 cm modified FFAR thermocouple responses to EM field established inside NBS and NSWC half reverberation chambers. Data normalized to exposure power density of 10 mW/cm^2 . a) Thermocouple output vs frequency. b) Difference in thermocouple output measured in NBS and NSWC reverberation chambers.



(a)

Figure 6.1 Sheet 1 of 2

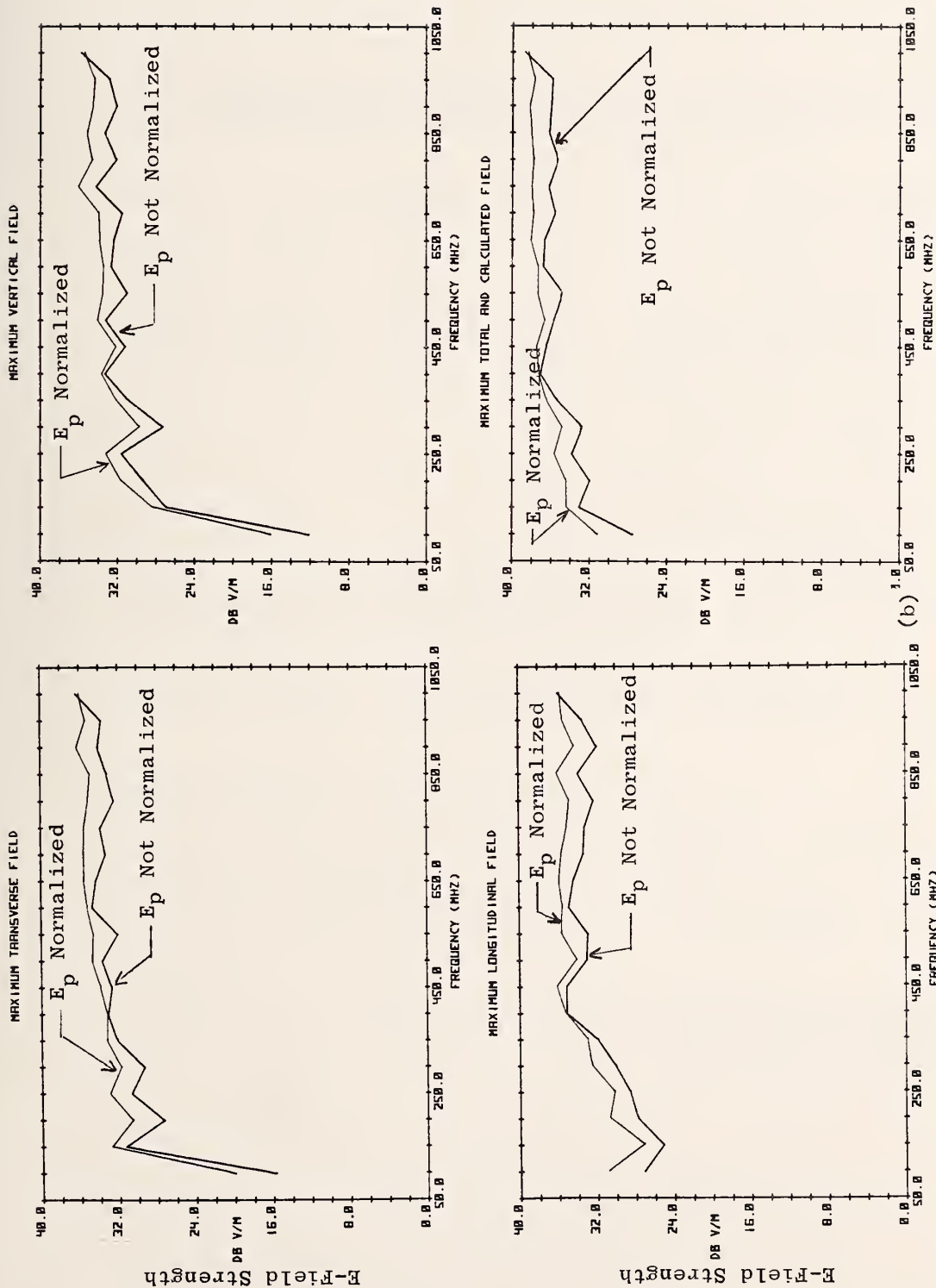

Figure 6.1 E-field strength measured inside NBS reverberation chamber using array of 7 NBS isotropic probes: (a) average, and (b) maximum. Comparison shown between results obtained before and after normalization of measurements to correct for changes in net input power. Normalized data corrected for net input power of 1.0 Watt. Chamber excitation antenna is log periodic. E_p is average field strength determined from 7 probes.

Table 6.1 Summary and estimates of measurement uncertainties for determining field strength inside NBS reverberation chamber - Mode Tuned (200 MHz - 2.0 GHz)

Source of Error	Error (dB)							
	200 MHz		500 MHz		1.0 GHz		2.0 GHz	
	Ave.	Max.	Ave.	Max.	Ave.	Max.	Ave.	Max.
1) Measuring Received Power								
Cable Loss	± 0.05		± 0.05		± 0.05		± 0.10	
Attenuator Calibration	± 0.10		± 0.10		± 0.10		± 0.10	
Antenna Efficiency	± 0.05		± 0.05		± 0.05		± 0.10	
Power Meter Calibration	± 0.20		± 0.20		± 0.20		± 0.20	
Total	± 0.40		± 0.40		± 0.40		± 0.50	
2) Receiving Power Mismatch (See Figure 6.1)	-2.8	-5.1	-1.5	-3.4	-0.7	-1.5	-0.3	-0.7
3) Mixing/Sampling Efficiency								
Spatial Field Uniformity (see figure 2.27)	± 8.0		± 5.0		± 3.0		± 2.0	
Limited Sample Size (see Table 6.4)	±0.2	±0.5	±0.2	±0.5	±0.2	±1.5	±0.3	±1.0
Total	±8.2	±8.5	±5.2	±5.5	±3.2	±4.5	±2.3	±3.0
4) Wave Impedance $\neq 120\pi$ (see Figure 2.25)	-2.8	-2.8	-2.0	-2.0	-2.0	-2.0	-2.0	-2.0
	+2.0	+6.0	+2.0	+6.0	+2.0	+4.5	+2.0	+3.0
Total Worst Case Error	-14.2	-16.8	-9.1	-11.3	-6.3	-8.4	-5.1	-6.2
	+10.6	+14.9	+7.6	+11.9	+5.6	+9.4	+4.8	+6.5
RSS Error	-9.1	-10.3	-5.8	-6.8	-3.9	-5.2	-3.1	-3.7
	+8.5	+10.4	+5.6	+8.1	+3.8	+6.4	+3.1	+4.3
5) Failure to Correct for Input Power Variations (Transmit Mismatch Error)	-4.0		-3.0		-2.0		-1.0	

Table 6.2 Summary and estimates of measurement uncertainties for determining field strength inside NBS reverberation chamber - Mode Stirred (2.0 GHz - 18.0 GHz)

Source of Error	Error (dB)									
	2.0 GHz		4.0 GHz		8.0 GHz		12.0 GHz		18.0 GHz	
	Ave.	Max.	Ave.	Max.	Ave.	Max.	Ave.	Max.	Ave.	Max.
1) Measuring Received Power										
Cable Loss	± 0.10		± 0.10		± 0.15		± 0.15		± 0.20	
Attenuator Calibration	± 0.10		± 0.15		± 0.15		± 0.20		± 0.20	
Antenna Efficiency	± 0.10		± 0.15		± 0.15		± 0.20		± 0.20	
Spectrum Analyzer Cal.	± 1.50		± 1.50		± 1.50		± 1.50		± 1.50	
Sub Total	± 1.80		± 1.90		± 1.95		± 2.05		± 2.10	
2) Receiving Power Mismatch (see Figure 6.1)	-0.8		-0.8		-0.8		-1.0		-1.8	
3) Mixing/Sampling Efficiency										
Spatial Field Var.	± 2.0		± 1.0		± 0.5		± 0.2		± 0.2	
Limited Sample Size (see Table 6.4)	±0.1 ±0.3		±0.2 ±0.5		±0.3 ±0.7		±0.3 ±1.0		±0.3 ±1.5	
Sub Total	±2.1 ±2.3		±1.2 ±1.5		±0.8 ±1.5		±0.5 ±1.2		±0.5 ±1.7	
4) Wave Imped ≠ 120π	Average ≤ ±2.0, -2.0 ≥ Maximum ≤ +3.0									
5) Failure to Correct for Input Power Var.	-0.8		-0.8		-0.8		-1.0		-1.8	
Total (Worst Case) Error	-7.5	-7.7	-6.7	-7.0	-6.4	-6.8	-6.6	-7.3	-8.2	-9.4
	+5.9	+7.1	+5.1	+6.4	+4.8	+6.2	+4.6	+6.3	+4.6	+6.8
RSS Error	-3.6	-3.7	-3.1	-3.3	-3.1	-3.2	-3.2	-3.4	-3.9	-4.2
	+3.4	+4.2	+3.0	+3.9	+2.9	+3.8	+2.9	+3.8	+2.9	+4.0

Table 6.3 Estimates of impedance mismatch uncertainties for received power measurements

Frequency GHz	Source		Load Max	Mismatch Error (dB)	
	Ave	Max		Ave	Max
0.2	5.0	10.0	1.10	-2.83	-5.15
0.5	3.0	6.0	1.10	-1.46	-3.40
1.0	2.0	3.0	1.10	-0.66	-1.46
2.0	1.5	2.0	1.10	-0.27	-0.66
2.0	2.0	2.0	1.20	-0.81	-0.81
4.0	2.0	2.0	1.20	-0.81	-0.81
8.0	2.0	2.0	1.20	-0.81	-0.81
12.0	2.0	2.0	1.30	-0.95	-0.95
18.0	2.5	2.5	1.50	-1.77	-1.77

Table 6.4 Estimates of uncertainties due to limiting number of tuner positions (sample size).

Frequency GHz	Error due to limiting Sample Size Ave/Max (dB)				
	Number of Tuner Positions				
	50	100	200	400	800
0.2	0.2/0.8	0.2/0.5	--	--	--
0.5	0.6/3.6	0.5/2.0	0.2/0.5	--	--
1.0	--	1.0/4.0	0.2/1.5	0.2/0.5	0.1/0.2
2.0	--	--	0.5/3.0	0.3/1.0	0.1/0.5
4.0	--	--	--	0.5/3.0	0.2/1.0
8.0	--	--	--	--	0.5/3.0

APPENDIX

Computer Programs for
Reverberation Chamber Immunity Measurements

```

100! RE-STORE "ModeTune01"
102 ! Original: 5 May 1984 G. Koepke (303) 497-5766
104 ! Revision: 21 Feb 1986, 09:20
106 !
108 ! This measurement routine will operate the REVERBERATION CHAMBER
110 ! using MODE TUNED techniques. The tuner is stepped in discrete steps
112 ! and measurements are performed at each step. In this version ALL
114 ! frequencies are measured at each tuner step before proceeding
116 ! to the next step. Both the case of susceptability (power supplied
118 ! by a signal generator) and emissions (power supplied by EUT) can be
120 ! handled. This program will handle EUT emissions by not measuring
122 ! the net input power and recording the received power as detected
124 ! by the reference antenna. Duplicate measurements are required to
126 ! inject an 'equivalent' (will be normalized later) power to set
128 ! up the same response using the transmit antenna as was measured
130 ! with the EUT only. This method will determine the total power
132 ! radiated by the EUT.
134 !
136 ! The program will also handle the case where the tuner is not stepped,
138 ! as in a TEM cell or ANECHOIC chamber where a single measurement
140 ! is needed. The data is condensed for this case.
142 !
144 ! Coupler, cable loss, and Power meter head corrections are applied
146 ! immediately to the measured data. These computations must be verified
148 ! by examining program lines that begin with the line label
150 ! Apply_cal_data, merely execute the EDIT command as shown.
152 !
154 ! EDIT Apply_cal_data
156 !
158 ! The measurement data are saved on disk for processing. It may also
160 ! be tabulated as the measurement proceeds by toggling a print flag
162 ! that is shown at the start of each tuner step.
164 !
166 ! .....
168 ! Features: 1) NBS multiprobe system
170 !           2) HP 436 and/or HP 438 power meters
172 !           3) HP 3456 or 3478 DVMs
174 !           4) HP 8566 Spectrum Analyzer (Power only)
176 !           5) HP relay actuator for RF switching
178 !           6) Superior Electric Stepping motor control
180 !           7) Either of HP8660A or HP8672A signal source.
182 !
184 ! ..... Current Configuration .....
186 !
188 ! Perform preliminary emissions experiments in the chamber.
190 !
192 ! Standard items: 1) Incident Power to transmit antenna
194 !                 2) Reflected power from transmit antenna
196 !                 3) Received power from reference antenna
198 !
200 ! Measure output of: 4) Any number of NBS probes via system.
202 !                   [not used for emission tests]
204 !
206 ! ..... Special Notes .....
208 !
210 !
212 !
214 !
216 !

```

```

218      !
220      !
222      ! ***** MAIN PROGRAM *****
224      !
226      OPTION BASE 1
228      DEG
230      OUTPUT 2 USING "K,#";"SCRATCH KEYX"
232      CALL Wipe_clean
234      GOSUB Dim_variables      ! Dimension all variables, set selected values.
236      GOSUB Load_cal_data    ! Load all calibration data for pads & cables.
238      New_measurement: !
240      PRINTER IS CRT
242      DISP CHR$(129)
244      GOSUB Initial_values   ! Preset all parameters and access menu.
246      GOSUB Sig_gen_subs     ! Load selected Signal Generator subs
248                          ! and selected coupler calibration data.
250      GOSUB Fillcalibration ! Fill lookup table for calibration values.
252      GOSUB Do_measurements  ! <-- read it again
254      GOSUB Die_gracefully  ! Delete signal generator subs from memory
256      PRINTER IS CRT
258      DISP " ";TIME$(TIMEDATE);" ";DATE$(TIMEDATE);" ....PROGRAM FINISHED,";
260      DISP " 'CONTINUE' to repeat."
262      PAUSE
264      GOTO New_measurement
266      STOP
268      !
270      ! ***** END of MAIN PROGRAM *****
272      !
274      ! //////////////////////////////////** DIMENSION VARIABLES **////////////////////////////////
276      !
278      Dim_variables: !
280      !
282      COM /Parameters/ REAL Fstart,Fstop,Fstep
284      COM /Parameters/ REAL Min_eut,Max_eut,Min_pwr,Max_pwr,Time_eut
286      COM /Parameters/ INTEGER Low_dbm,High_dbm,Step_dbm
288      COM /Parameters/ INTEGER Search_eut,Search_pwr,Re_run
290      COM /Parameters/ INTEGER Begin_step>Total_steps>Total_meters
292      COM /Parameters/ Run_id#[10],Measmt_id#[160],Time_date#[30]
294      COM /Parameters/ Meter_defns$(40)[40],Operator_name#[28],Test_type#[20]
296      COM /Parameters/ Coupler_id#[10],Generator_id#[10]
298      !
300      COM /Probe_system/ INTEGER Sys_size>Total_chans,Probe_addr(30,3)
302      COM /Probe_system/ INTEGER Top_probe,Fcal_pts,Fr_avgs
304      COM /Probe_system/ INTEGER Probe_volts(30),Overrange(30)
306      COM /Probe_system/ INTEGER Probe_zero(30),REAL Probe_v_m(30)
308      COM /Probe_system/ REAL Amplitude_cal(11,3,5),Freq_cal(11,3,13,2)
310      COM /Probe_system/ REAL Readtime(30),Freq_crib(13,2)
312      !
314      COM /Interrupts/ INTEGER Intr_pnty
316      COM /Motor_menu/ Motion_type#[10],Rev_rate,INTEGER Tuner_steps
318      COM /Bugs/ INTEGER Bug1,Bug2,Bug3,Printer
320      COM /Files/ Sourcedisk#[20],Outdisk#[20],Filename#[80]
322      !
324      !.....Cable and etc. calibration files.....
326      !
328      DIM Baddata_id$(15)[40]
330      INTEGER Calib_items
332      !
334      DIM Coup_inc(205,2),Coup_refl(205,2)
336      INTEGER Inc_pts,Refl_pts

```

```

338 REAL Coupinc,Couprefl
340 !
342 DIM Cable6_1(180,2),Cable6_6(180,2),Cable4_2(180,2),Cable4_4(180,2)
344 INTEGER C6_1pts,C6_6pts,C4_2pts,C4_4pts
346 REAL C6_1loss,C6_6loss,C4_2loss,C4_4loss
348 !
350 DIM Cable10_3(180,2),Cable10_5(180,2),Cable5_7(180,2)
352 INTEGER C10_3pts,C10_5pts,C5_7pts
354 REAL C10_3loss,C10_5loss,C5_7loss
356 !
358 DIM Cable_r4(80,2),Cable_r12(80,2)
360 INTEGER Cr4pts,Cr12pts
362 REAL Cr4loss,Cr12loss
364 !
366 DIM Pad_as6a(180,2),Pad_s6770(180,2),Pad_f5530(180,2)
368 INTEGER Pada_pts,Pads_pts,Padf_pts
370 REAL Pada_loss,Pads_loss,Padf_loss
372 !
374 DIM H_jct(77,2) !Anzac Hybrid Junction
376 INTEGER Jct_pts
378 REAL Jct_loss
380 !
382 !.....Other useful variables.....
384 !
386 DIM Cal_id#[40],Pwr_id#[2],Test#[160]
388 INTEGER Baddata,Dbm,Rf_on_off,Filesize,I,J,K,F
390 INTEGER Valid,Ftotal,File20steps,Beginstep,Endstep
392 INTEGER Printflag,Fcount,Too_hot,Printflag2,Steps
394 INTEGER Local_pnty,Probe
396 !
398 INTEGER Fp436a1,Fp436a2,Fp438a1,Fp438a2,Fsa8566b
400 INTEGER Fv3456a1,Fv3456a2,Fv3478a1,Fr59306a
402 REAL Z3456a1,Z3456a2,Z3478a1
404 REAL V3456a1,V3456a2,V3478a1
406 !
408 ! ..... we need these initial values .....
410 !
412 Printer=701
414 Sourcedisk#=":INTERNAL,4,0"
416 Outdisk#=":INTERNAL,4,1" ! or ":HP9133,700,0"
418 Intr_pnty=6
420 Local_pnty=Intr_pnty
422 Bugs:!
424 Printflag=1 ! Print all setup parameters and calibration values.
426 Printflag2=1 ! Print raw data if both Printflag and Printflag2
428 Bug1=0
430 Bug2=0
432 Bug3=0
434 !
436 RETURN
438 !
440 ! //////////////////////////////////****INITIALIZE VARIABLES & I/O****////////////////////////////////
442 !
444 Initial_values:!
446 !
448 ASSIGN @Motor TO 706 ! Stepping motor
450 ASSIGN @Pwr1 TO 709 ! Power meters HF436a
452 ASSIGN @Pwr2 TO 710
454 ASSIGN @Dual_pwr1 TO 711 ! Power meters HF436a
456 ASSIGN @Dual_pwr2 TO 712

```

```

458 ASSIGN @Sig_gen TO 719 ! Signal generator HP8660a or HP8672a
460 ASSIGN @Dvm1 TO 722 ! HP3456A Dvm.
462 ASSIGN @Dvm2 TO 723 ! HP3456A Dvm.
464 ASSIGN @Dvm3 TO 724 ! HP3478A Dvm.
466 ASSIGN @Gpio TO 12 ! NBS Multiprobe system
468 ASSIGN @Rly1 TO 717 ! HP relay actuator
470 ASSIGN @Spec_alzr TO 718 ! HP 8566 Spectrum Analyzer
472 !
474 !
476 Calib_items=15 ! 15 files for cables, coupler, and pad cals.
478 Fr_avgs=3 ! Read Multiprobe 3 times and average.
480 Motion_type#="STEP" ! or "CONTINUOUS" for MODE STIRRING.
482 Rev_rate=1.0 ! used only if MODE STIRRING operation.
484 Rf_on_off=1
486 !
488 CALL Measure_menu ! Go and set up measurement parameters.
490 GOSUB Configure_instr ! Turn on/off instruments as per menu
492 CALL Multiprobe_menu ! Set up the 30 probe system.
494 DISP CHR$(129)
496 GOSUB Data_definition ! Use above info to define data.
498 GOSUB Die_gracefully ! To assure clean start.
500 Dbm=Low_dbm ! Initialize the Generator Level
502 Tuner_steps=Total_steps ! Initialize the motor control
504 !
506 !-----ALLOCATE THE RAW DATA MATRIX-----
508 Ftotal=INT((Fstop-Fstart)/Fstep)+1
510 IF Test_type#="OTHER (NO STEPS)" THEN
512 File20steps=Ftotal
514 ELSE
516 File20steps=20*Ftotal
518 END IF
520 ALLOCATE Rawdata(Total_meters+Total_chans+1,File20steps)
522 !-----
524 !
526 DISP "INSERT OUTPUT DATA DISK IN ";
528 SELECT Outdisk#
530 CASE ":INTERNAL,4,0"
532 DISP "RIGHT DRIVE, ";
534 CASE ":INTERNAL,4,1"
536 DISP "LEFT DRIVE, ";
538 END SELECT
540 DISP "and hit 'Continue-k5'."
542 BEEP
544 ON KEY 5 LABEL "Continue",Local_prtY GOTO Datasaver
546 Zippity:GOTO Zippity
548 Datasaver:OFF KEY
550 GOSUB Save_configure
552 IF Printer<<CRT THEN
554 PRINTER IS Printer
556 PRINT RPT#("-",80)
558 PRINT
560 PRINTER IS CRT
562 END IF
564 GOSUB Print_vitals
566 DISP CHR$(12)
568 RETURN
570 !
572 ! ////////////////////////////////////////////////////
574 !
576 Configure_instr:!
```

```

578 ! ... Instrument read flags, if set the meter will be read ...
580 ! Stepping motor controlled by Test_type#
582 ! Signal generator HP8660a or HP8672a controlled by Test_type#
584 ! NBS Multiprobe system controlled by Total_chans
586 SELECT Test_type#
588 CASE "MODE TUNE REGULAR"
590     Fp436a1=0 ! Power meter HP436a at addr 09
592     Fp436a2=0 ! Power meter HP436a at addr 10
594     Fp438a1=1 ! Power meter HP438a at addr 11
596     Fp438a2=0 ! Power meter HP438a at addr 12
598     Fv3456a1=0 ! HP3456A Dvm at addr 22
600     Fv3456a2=0 ! HP3456A Dvm at addr 23
602     Fv3478a1=0 ! HP3478A Dvm at addr 24
604     Fr59306a=0 ! HP relay actuator at addr 17
606     Fsa8566b=1 ! HP 8566 Spectrum Analyzer at addr 18
608 CASE "MODE TUNE EMISSIONS"
610     Fp436a1=0 ! Power meter HP436a at addr 09
612     Fp436a2=0 ! Power meter HP436a at addr 10
614     Fp438a1=0 ! Power meter HP438a at addr 11
616     Fp438a2=0 ! Power meter HP438a at addr 12
618     Fv3456a1=0 ! HP3456A Dvm at addr 22
620     Fv3456a2=0 ! HP3456A Dvm at addr 23
622     Fv3478a1=0 ! HP3478A Dvm at addr 24
624     Fr59306a=0 ! HP relay actuator at addr 17
626     Fsa8566b=1 ! HP 8566 Spectrum Analyzer at addr 18
628 CASE "OTHER (NO STEPS)"
630     Fp436a1=0 ! Power meter HP436a at addr 09
632     Fp436a2=0 ! Power meter HP436a at addr 10
634     Fp438a1=1 ! Power meter HP438a at addr 11
636     Fp438a2=0 ! Power meter HP438a at addr 12
638     Fv3456a1=1 ! HP3456A Dvm at addr 22
640     Fv3456a2=0 ! HP3456A Dvm at addr 23
642     Fv3478a1=0 ! HP3478A Dvm at addr 24
644     Fr59306a=0 ! HP relay actuator at addr 17
646     Fsa8566b=0 ! HP 8566 Spectrum Analyzer at addr 18
648 END SELECT
650 !
652 RETURN
654 !
656 ! ///////////////////////////////////////////////////****DATA DEFINITION****//
658 !
660 Data_definition: ! Set up the definitions of each meter reading,
662 ! these are used later when processing
664 ! SO be sure these are correct.
666 ! The index corresponds to the Rawdata matrix row+1
668 ! Frequency is always in row 1
670 ! Meter 1 is in row 2, etc.
672 !
674 SELECT Test_type#
676 CASE "MODE TUNE REGULAR"
678     Total_meters=3
680     Meter_defns#(1)="Incident Power (Watts)"
682     Meter_defns#(2)="Reflected Power (Watts)"
684     Meter_defns#(3)="Recieved Power (Watts)"
686 CASE "MODE TUNE EMISSIONS"
688     Total_meters=1
690     Meter_defns#(1)="Recieved Power (Watts)"
692 CASE "OTHER (NO STEPS)"
694     Total_meters=3
696     Meter_defns#(1)="Incident Power (Watts)"

```

```

698     Meter_defns$(2)="Reflected Power (Watts)"
700     Meter_defns$(3)="Probe Output (Volts)"
702 END SELECT
704 !
706 FOR F=1 TO Total_chans
708     Test#="Amp # "%VAL$(Probe_addr(P,1))& ", 5cm Probe # "
710     Test#="Test#%VAL$(Probe_addr(P,2))&"-"
712     SELECT Probe_addr(P,3)
714     CASE 1
716         Test#="Test#&"X"
718     CASE 2
720         Test#="Test#&"Y"
722     CASE 3
724         Test#="Test#&"Z"
726     CASE 4
728         Test#="Test#&"Single"
730     CASE ELSE
732         Test#="Test#&"Error!"
734     END SELECT
736     IF LEN(Test#)>40 THEN
738         BEEP
740         DISP "ERROR in probe definitions"
742         PAUSE
744         Test#="Test#[1,40]
746     ELSE
748         Meter_defns$(F+Total_meters)=Test#
750     END IF
752 NEXT F
754 RETURN
756 !
758 !//////////*****DIE GRACEFULLY*****//////////
760 !
762 Die_gracefully: !
764 IF Bug1 THEN
766     PRINT TIME$(TIMEDATE);
768     PRINT RPT#("<",15);" DIE GRACEFULLY ";RPT#(">",15)
770 END IF
772 ON ERROR GOTO Delet_done1
774 SELECT Generator_id#
776 CASE "HF_8660A"
778     DELSUB Set_freq,Set_dbm,FNDigit10#,FNDigit3#,FNRev#
780 CASE "HF_8672A"
782     DELSUB Set_freq,Set_dbm
784 END SELECT
786 Delet_done1: !
788 OFF ERROR
790 ON ERROR GOTO Delet_done2
792 DEALLOCATE Rawdata(*),Adjust(*)
794 Delet_done2: !
796 OFF ERROR
798 RETURN
800 !
802 !//////////*****DIE GRACEFULLY*****//////////
804 !
806 Sig_gen_subs: !
808 PRINTER IS CRT
810 PRINT TABXY(1,18);RPT#("<",15);
812 PRINT " LOAD SUB PROGRAMS & Coupler Calibrations ";RPT#("<",15)
814 Filename#=Generator_id#&Sourcedisk#
816 DISP " Put 'CALIBRATION DATA & SUB Program' disk in ";

```

```

818 SELECT Sourcedisk#
820 CASE ":INTERNAL,4,0"
822     DISP "RIGHT DRIVE, ";
824 CASE ":INTERNAL,4,1"
826     DISP "LEFT DRIVE, ";
828 END SELECT
830 DISP "hit 'Continue+K5'."
832 BEEP
834 ON KEY 5 LABEL "Continue",Local_pnty GOTO Subloads
836 LOOP
838 END LOOP
840 Subloads:OFF KEY
842 DISP CHR$(12)
844 DISP " Signal Generator SUB PROGRAMS NOW LOADING "
846 ON ERROR CALL Errortrap
848 LOADSUB ALL FROM Filename#
850 OFF ERROR
852 DISP " Signal Generator SUB PROGRAMS LOADED "
854 WAIT 1
856 !
858 !-----
860 !
862 IF Printflag THEN PRINTER IS Printer
864 IF Printflag THEN PRINT "CALIBRATION DATA FOR THE FOLLOWING IS LOADED:"
866 SELECT Coupler_id#
868 CASE "HP_778D" ! 30 to 2000 MHz.
870     Filename#="HP_778D_f"&Sourcedisk#
872     CALL Enter_caldata(Filename#,Coup_inc(*),Cal_id#,Inc_pts)
874     Baddata_id#(1)=Cal_id#
876     IF Printflag THEN PRINT Cal_id#
878     Filename#="HP_778D_r"&Sourcedisk#
880     CALL Enter_caldata(Filename#,Coup_refl(*),Cal_id#,Refl_pts)
882     Baddata_id#(2)=Cal_id#
884     IF Printflag THEN PRINT Cal_id#
886 CASE "HP_11692D" ! 2 to 18 GHz
888     Filename#="HP11692D_f"&Sourcedisk#
890     CALL Enter_caldata(Filename#,Coup_inc(*),Cal_id#,Inc_pts)
892     Baddata_id#(1)=Cal_id#
894     IF Printflag THEN PRINT Cal_id#
896     Filename#="HP11692D_r"&Sourcedisk#
898     CALL Enter_caldata(Filename#,Coup_refl(*),Cal_id#,Refl_pts)
900     Baddata_id#(2)=Cal_id#
902     IF Printflag THEN PRINT Cal_id#
904 CASE "CH_130_4" ! 1 to 30 MHz Anzac bi-directional
906     Filename#="CH130_4_f1"&Sourcedisk#
908     CALL Enter_caldata(Filename#,Coup_inc(*),Cal_id#,Inc_pts)
910     Baddata_id#(1)=Cal_id#
912     IF Printflag THEN PRINT Cal_id#
914     Filename#="CH130_4_r1"&Sourcedisk#
916     CALL Enter_caldata(Filename#,Coup_refl(*),Cal_id#,Refl_pts)
918     Baddata_id#(2)=Cal_id#
920     IF Printflag THEN PRINT Cal_id#
922 CASE ELSE
924     PRINT "COUPLER CALIBRATION DATA ERROR.....NOT DEFINED."
926     BEEP
928     PAUSE
930 END SELECT
932 !
934 !-----
936 !

```

```

938 PRINT TABXY(1,18);RPT#(" ",80);
940 RETURN
942 !
944 ! //////////////////////////////////////
946 !
948 Load_cal_data:
950 PRINT TABXY(1,18);RPT#(" ",20);" LOAD CALIBRATION DATA ";RPT#(" ",20)
952 DISP " Put 'CALIBRATION DATA & SUB Program' disk in ";
954 SELECT Sourcedisk#
956 CASE ":INTERNAL,4,0"
958     DISP "RIGHT DRIVE, ";
960 CASE ":INTERNAL,4,1"
962     DISP "LEFT DRIVE, ";
964 END SELECT
966 DISP "hit 'Continue-k5'."
968 BEEP
970 ON KEY 5 LABEL "Continue",Local_pnty GOTO Calloads
972 LOOP
974 END LOOP
976 Calloads:OFF KEY
978 DISP " Calibration DATA for Cables, Couplers, Pads, etc. now LOADING "
980 !.....
982 !Install new calibration files here!
984 !.....
986 IF Printflag THEN PRINTER IS Printer
988 IF Printflag THEN PRINT "CALIBRATION DATA FOR THE FOLLOWING IS LOADED:"
990 !
992 !-----
994 !
996 Filename#="Cable6FT_1"&Sourcedisk#
998 CALL Enter_caldata(Filename#,Cable6_1(*),Cal_id#,C6_1pts)
1000 Baddata_id#(3)=Cal_id#
1002 IF Printflag THEN PRINT Cal_id#
1004 !
1006 Filename#="Cable6FT_6"&Sourcedisk#
1008 CALL Enter_caldata(Filename#,Cable6_6(*),Cal_id#,C6_6pts)
1010 Baddata_id#(4)=Cal_id#
1012 IF Printflag THEN PRINT Cal_id#
1014 !
1016 Filename#="Cable4FT_2"&Sourcedisk#
1018 CALL Enter_caldata(Filename#,Cable4_2(*),Cal_id#,C4_2pts)
1020 Baddata_id#(5)=Cal_id#
1022 IF Printflag THEN PRINT Cal_id#
1024 !
1026 Filename#="Cable4FT_4"&Sourcedisk#
1028 CALL Enter_caldata(Filename#,Cable4_4(*),Cal_id#,C4_4pts)
1030 Baddata_id#(6)=Cal_id#
1032 IF Printflag THEN PRINT Cal_id#
1034 !
1036 Filename#="Cable10F_3"&Sourcedisk#
1038 CALL Enter_caldata(Filename#,Cable10_3(*),Cal_id#,C10_3pts)
1040 Baddata_id#(7)=Cal_id#
1042 IF Printflag THEN PRINT Cal_id#
1044 !
1046 Filename#="Cable10F_5"&Sourcedisk#
1048 CALL Enter_caldata(Filename#,Cable10_5(*),Cal_id#,C10_5pts)
1050 Baddata_id#(8)=Cal_id#
1052 IF Printflag THEN PRINT Cal_id#
1054 !
1056 Filename#="Cable5FT_7"&Sourcedisk#

```

```

1058 CALL Enter_caldata(Filename#,Cable5_7(*),Cal_id#,CS_7pts)
1060 Baddata_id#(9)=Cal_id#
1062 IF Printflag THEN PRINT Cal_id#
1064 !
1066 Filename#="PAD_S6770"&Sourcedisk#
1068 CALL Enter_caldata(Filename#,Pad_s6770(*),Cal_id#,Pads_pts)
1070 Baddata_id#(10)=Cal_id#
1072 IF Printflag THEN PRINT Cal_id#
1074 !
1076 Filename#="PAD_5530"&Sourcedisk#
1078 CALL Enter_caldata(Filename#,Pad_f5530(*),Cal_id#,Padf_pts)
1080 Baddata_id#(11)=Cal_id#
1082 IF Printflag THEN PRINT Cal_id#
1084 !
1086 Filename#="PdAS6A1466"&Sourcedisk#
1088 CALL Enter_caldata(Filename#,Pad_as6a(*),Cal_id#,Pada_pts)
1090 Baddata_id#(12)=Cal_id#
1092 IF Printflag THEN PRINT Cal_id#
1094 !
1096 Filename#="ANZAC_JCT"&Sourcedisk#
1098 CALL Enter_caldata(Filename#,H_jct(*),Cal_id#,Jct_pts)
1100 Baddata_id#(13)=Cal_id#
1102 IF Printflag THEN PRINT Cal_id#
1104 !
1106 Filename#="Rcable4ft"&Sourcedisk#
1108 CALL Enter_caldata(Filename#,Cable_r4(*),Cal_id#,Cr4pts)
1110 Baddata_id#(14)=Cal_id#
1112 IF Printflag THEN PRINT Cal_id#
1114 !
1116 Filename#="Rcable12ft"&Sourcedisk#
1118 CALL Enter_caldata(Filename#,Cable_r12(*),Cal_id#,Cr12pts)
1120 Baddata_id#(15)=Cal_id#
1122 IF Printflag THEN PRINT Cal_id#
1124 !
1126 IF Printflag THEN
1128     PRINT RPT#("_",80)
1130     PRINT USING "4/"
1132 END IF
1134 DISP " Calibration DATA LOADED "
1136 WAIT 1
1138 PRINTER IS CRT
1140 CALL Wipe_clean
1142 RETURN
1144 !
1146 ! //////////////////////////////////////
1148 !
1150 Fillcalibration: ! Determine the cable, coup' r and pad calibration
1152 ! values for each frequer.
1154 ! Save these in the adjust(*) file for use by the
1156 ! measurement routine.
1158 !
1160 IF Bug1 THEN
1162     PRINT TIME#(TIMEDATE);
1164     PRINT RPT#("<",15);" FILL CALIBRATION MATRIX ";RPT#(">",15)
1166 END IF
1168 DISP "NOW Filling Calibration matrix."
1170 ALLOCATE Adjust(Ftotal,Calib_items)
1172 Fcount=1
1174 FOR Frequency=Fstart TO Fstop STEP Fstep
1176     CALL Get_cal_value(Frequency,Coupinc,Coup_inc(*),Baddata,Inc_pts)

```

```

1178     IF Baddata THEN
1180         Cal_id#=Baddata_id$(1)
1182         GOSUB Flagbaddata
1184     END IF
1186     Adjust(Fcount,1)=Coupinc
1188     !
1190     CALL Get_cal_value(Frequency,Coupref1,Coup_ref1(*),Baddata,Ref1_pts)
1192     IF Baddata THEN
1194         Cal_id#=Baddata_id$(2)
1196         GOSUB Flagbaddata
1198     END IF
1200     Adjust(Fcount,2)=Coupref1
1202     !
1204     CALL Get_cal_value(Frequency,C6_1loss,Cable6_1(*),Baddata,C6_1pts)
1206     IF Baddata THEN
1208         Cal_id#=Baddata_id$(3)
1210         GOSUB Flagbaddata
1212     END IF
1214     Adjust(Fcount,3)=C6_1loss
1216     !
1218     CALL Get_cal_value(Frequency,C6_6loss,Cable6_6(*),Baddata,C6_6pts)
1220     IF Baddata THEN
1222         Cal_id#=Baddata_id$(4)
1224         GOSUB Flagbaddata
1226     END IF
1228     Adjust(Fcount,4)=C6_6loss
1230     !
1232     CALL Get_cal_value(Frequency,C4_2loss,Cable4_2(*),Baddata,C4_2pts)
1234     IF Baddata THEN
1236         Cal_id#=Baddata_id$(5)
1238         GOSUB Flagbaddata
1240     END IF
1242     Adjust(Fcount,5)=C4_2loss
1244     !
1246     CALL Get_cal_value(Frequency,C4_4loss,Cable4_4(*),Baddata,C4_4pts)
1248     IF Baddata THEN
1250         Cal_id#=Baddata_id$(6)
1252         GOSUB Flagbaddata
1254     END IF
1256     Adjust(Fcount,6)=C4_4loss
1258     !
1260     CALL Get_cal_value(Frequency,C10_3loss,Cable10_3(*),Baddata,C10_3pts)
1262     IF Baddata THEN
1264         Cal_id#=Baddata_id$(7)
1266         GOSUB Flagbaddata
1268     END IF
1270     Adjust(Fcount,7)=C10_3loss
1272     !
1274     CALL Get_cal_value(Frequency,C10_5loss,Cable10_5(*),Baddata,C10_5pts)
1276     IF Baddata THEN
1278         Cal_id#=Baddata_id$(8)
1280         GOSUB Flagbaddata
1282     END IF
1284     Adjust(Fcount,8)=C10_5loss
1286     !
1288     CALL Get_cal_value(Frequency,C5_7loss,Cable5_7(*),Baddata,C5_7pts)
1290     IF Baddata THEN
1292         Cal_id#=Baddata_id$(9)
1294         GOSUB Flagbaddata
1296     END IF

```

```

1298     Adjust (Fcount,9)=C5_7loss
1300     !
1302     CALL Get_cal_value(Frequency,Pads_loss,Pad_s6770(*),Baddata,Pads_pts)
1304     IF Baddata THEN
1306         Cal_id#=Baddata_id$(10)
1308         GOSUB Flagbaddata
1310     END IF
1312     Adjust (Fcount,10)=Pads_loss
1314     !
1316     CALL Get_cal_value(Frequency,Padf_loss,Pad_f5530(*),Baddata,Padf_pts)
1318     IF Baddata THEN
1320         Cal_id#=Baddata_id$(11)
1322         GOSUB Flagbaddata
1324     END IF
1326     Adjust (Fcount,11)=Padf_loss
1328     !
1330     CALL Get_cal_value(Frequency,Pada_loss,Pad_as6a(*),Baddata,Pada_pts)
1332     IF Baddata THEN
1334         Cal_id#=Baddata_id$(12)
1336         GOSUB Flagbaddata
1338     END IF
1340     Adjust (Fcount,12)=Pada_loss
1342     !
1344     CALL Get_cal_value(Frequency,Jct_loss,H_jct(*),Baddata,Jct_pts)
1346     IF Baddata THEN
1348         Cal_id#=Baddata_id$(13)
1350         GOSUB Flagbaddata
1352     END IF
1354     Adjust (Fcount,13)=Jct_loss
1356     !
1358     CALL Get_cal_value(Frequency,Cr4loss,Cable_r4(*),Baddata,Cr4pts)
1360     IF Baddata THEN
1362         Cal_id#=Baddata_id$(14)
1364         GOSUB Flagbaddata
1366     END IF
1368     Adjust (Fcount,14)=Cr4loss
1370     !
1372     CALL Get_cal_value(Frequency,Cr12loss,Cable_r12(*),Baddata,Cr12pts)
1374     IF Baddata THEN
1376         Cal_id#=Baddata_id$(15)
1378         GOSUB Flagbaddata
1380     END IF
1382     Adjust (Fcount,15)=Cr12loss
1384     !
1386     Fcount=Fcount+1
1388     NEXT Frequency
1390     DISP "NOW tabulating calibration values."
1392     GOSUB Printcalvalues
1394     DISP CHR$(12)
1396     RETURN
1398     !
1400     ! //////////////////////////////////////////////////*****FLAG BAD DATA*****////////////////////////////////////
1402     !
1404     Flagbaddata:      !Inform the operator that there is wrong data
1406                     !being brought back from Enter_cal_data
1408                     !
1410     PRINTER IS Printer
1412     PRINT RPT$("*",5); " NO CAL DATA at ";Frequency;
1414     PRINT " MHz: ";Cal_id#
1416     BEEP

```

```

1418  PRINTER IS CRT
1420  RETURN
1422  !
1424  ! //////////////////////////////////////
1426  !
1428  Printcalvalues:      !MAKE LIST OF CALIBRATION VALUES USED.
1430  !
1432  PRINTER IS Printer
1434  PRINT
1436  PRINT RPT#(" ",24); " CALIBRATION / LOSS VALUES (dB) ";RPT#(" ",24)
1438  PRINT
1440  !
1442  !.....first half of the values.....
1444  !
1446  PRINT "Frequency  Coupler  ----- BLUE CABLES -----";
1448  PRINT "-----"
1450  PRINT "   MHz   Fward   Refl   6ft#1  6ft#6  4ft#2  4ft#4  10ft#3  ";
1452  PRINT "10ft#5  5ft#7"
1454  Lossfmt1: IMAGE MSD.D,X,2(MDD.DD,X),X,2(MDD.DD,X),#
1456  Lossfmt2: IMAGE 5(MDD.DD,X)
1458  Fcount=1
1460  FOR Frequency=Fstart TO Fstop STEP Fstep
1462      Coupinc=10*LGT(Adjust(Fcount,1))          !Coupler incident
1464      Couprefl=10*LGT(Adjust(Fcount,2))        !Coupler reflected
1466      C6_1loss=10*LGT(Adjust(Fcount,3))       !6 foot BLUE cable #1
1468      C6_6loss=10*LGT(Adjust(Fcount,4))       !6 foot BLUE cable #6
1470      C4_2loss=10*LGT(Adjust(Fcount,5))       !4 foot BLUE cable #2
1472      C4_4loss=10*LGT(Adjust(Fcount,6))       !4 foot BLUE cable #4
1474      C10_3loss=10*LGT(Adjust(Fcount,7))      !10 foot BLUE cable #3
1476      C10_5loss=10*LGT(Adjust(Fcount,8))      !10 foot BLUE cable #5
1478      C5_7loss=10*LGT(Adjust(Fcount,9))       !4 foot BLUE cable #4
1480      PRINT USING Lossfmt1;Frequency,Coupinc,Couprefl,C6_1loss,C6_6loss
1482      PRINT USING Lossfmt2;C4_2loss,C4_4loss,C10_3loss,C10_5loss,C5_7loss
1484      Fcount=Fcount+1
1486  NEXT Frequency
1488  PRINT RPT#("-",80)
1490  PRINT
1492  !
1494  !.....last half of the values.....
1496  !
1498  PRINT "Frequency S6770  F5530  ASA6A  HJct  Semi-Rigid"
1500  PRINT "   MHz   pad   pad   pad   loss   4ft  12ft"
1502  Lossfmt3: IMAGE MSD.D,X,2(MDD.DD,X),X,MDD.DD,X,#
1504  Lossfmt4: IMAGE 3(MDD.DD,X)
1506  Fcount=1
1508  FOR Frequency=Fstart TO Fstop STEP Fstep
1510      Pads_loss=10*LGT(Adjust(Fcount,10))      !Weinschel S6770 10dB pad
1512      Padf_loss=10*LGT(Adjust(Fcount,11))      !Weinschel F5530 10dB pad
1514      Pada_loss=10*LGT(Adjust(Fcount,12))      !Weinschel AS6A-1466 10dB
1516      Jct_loss=10*LGT(Adjust(Fcount,13))       !Anzac Hybrid Junction
1518      Cr4loss=10*LGT(Adjust(Fcount,14))        ! 4ft Rigid coax
1520      Cr12loss=10*LGT(Adjust(Fcount,15))       ! 12ft Rigid coax
1522      PRINT USING Lossfmt3;Frequency,Pads_loss,Padf_loss,Pada_loss
1524      PRINT USING Lossfmt4;Jct_loss,Cr4loss,Cr12loss
1526      Fcount=Fcount+1
1528  NEXT Frequency
1530  PRINT RPT#(" ",80)
1532  PRINT
1534  PRINTER IS CRT
1536  RETURN

```

```

1538 !
1540 ! ////////////////////////////////////////////////////
1542 !
1544 Extract_caldata: !Get all calibration data for this
1546 !frequency.
1548 !
1550 ! Calibration data for all cables, probes, & power heads.
1552 !
1554 Pwrintrcal1=FNFPwrintrcal1((Frequency)) !18 GHz HEAD.
1556 Pwrintrcal2=FNFPwrintrcal2((Frequency)) !26 GHz HEAD.
1558 !
1560 Coupinc=Adjust(Fcount,1) !Coupler incident
1562 Couprefl=Adjust(Fcount,2) !Coupler reflected
1564 C6_1loss=Adjust(Fcount,3) !6 foot BLUE cable #1
1566 C6_6loss=Adjust(Fcount,4) !6 foot BLUE cable #6 revr.
1568 C4_2loss=Adjust(Fcount,5) !4 foot BLUE cable #2
1570 C4_4loss=Adjust(Fcount,6) !4 foot BLUE cable #4
1572 C10_3loss=Adjust(Fcount,7) !10 foot BLUE cable #3
1574 C10_5loss=Adjust(Fcount,8) !10 foot BLUE cable #5
1576 C5_7loss=Adjust(Fcount,9) !5 foot BLUE cable #7
1578 Pada_loss=Adjust(Fcount,10) !Weinschel S6770 10dB pad
1580 Padf_loss=Adjust(Fcount,11) !Weinschel F5530 10dB pad
1582 Pada_loss=Adjust(Fcount,12) !Weinschel AS5A-1466 10dB
1584 Jct_loss=Adjust(Fcount,13) !Anzac Hybrid Junction
1586 Cr4loss=Adjust(Fcount,14) !4ft Semi-rigid coax lines
1588 Cr12loss=Adjust(Fcount,15) !12ft Semi-rigid coax lines
1590 RETURN
1592 !
1594 ! ////////////////////////////////////////////////////
1596 !
1598 Flip_printflag: !
1600 DISP " Toggle PRINTING of measurement data. "
1602 Waittime=TIMEDATE
1604 LOOP
1606 IF Printflag2 THEN
1608 ON KEY 0 LABEL "Print is ON",Local_prtY GOSUB Toggleprint
1610 ELSE
1612 ON KEY 0 LABEL "Print is OFF",Local_prtY GOSUB Toggleprint
1614 END IF
1616 EXIT IF TIMEDATE-Waittime>4
1618 END LOOP
1620 DISP CHR$(12)
1622 OFF KEY
1624 RETURN
1626 ! .....
1628 Toggleprint:!
1630 IF Printflag2 THEN
1632 Printflag2=0
1634 ELSE
1636 Printflag2=1
1638 END IF
1640 RETURN
1642 !
1644 !//*****PERFORM MEASUREMENTS*****//
1646 !
1648 Do_measurements:!
1650 !
1652 IF Bug1 THEN
1654 PRINT TIME$(TIMEDATE);RPT$("<",20); " DO MEASUREMENTS ";RPT$(">",20)
1656 END IF

```

```

1658 ! .....Initialize instruments .....
1660 REMOTE @Sig_gen
1662 IF Fp436a1 OR Fp436a2 THEN CALL Menu_pwr436a ! Set up 436A pwr mtrs
1664 IF Fv3456a1 THEN CALL Setdvm_3456a(@Dvm1)
1666 IF Fv3456a2 THEN CALL Setdvm_3456a(@Dvm2)
1668 IF Fv3478a1 THEN CALL Setdvm_3478a(@Dvm3)
1670 IF Fsa8566b THEN CALL Spec_alzr_setup(@Spec_alzr)
1672 IF Test_type#<>"OTHER (NO STEPS)" THEN
1674     CALL Initializemotor(@Motor)
1676     CALL Zeromotor(@Motor)
1678 END IF
1680 IF Test_type#="MODE TUNE EMISSIONS" THEN
1682     CALL Set_dbm(-140,0,@Sig_gen) !EUT is the source
1684 END IF
1686 ! .....
1688 !
1690 Column=1
1692 Beginstep=Begin_step
1694 Steps=Begin_step-1
1696 REPEAT ! measurements for all steps or once for non-stepping type.
1698     Steps=Steps+1
1700     !
1702     IF (Steps-1)/40.=INT((Steps-1)/40.) OR Steps=Begin_step THEN
1704         IF Test_type#="MODE TUNE EMISSIONS" THEN
1706             GOSUB Flip_printflag ! includes WAIT action.
1708         ELSE
1710             GOSUB Read_zero_field ! for all enabled instruments.
1712         END IF
1714     ELSE
1716         GOSUB Flip_printflag
1718     END IF
1720     !
1722     ! ..... ZERD Readings or WAIT complete .....
1724     !
1726     IF Total_chans<1 THEN ! Print single header for all frequencies
1728         IF Printflag AND Printflag2 THEN GOSUB Print_headinfo
1730     END IF
1732     IF Test_type#<>"MODE TUNE EMISSIONS" THEN ! Restore power
1734         CALL Set_freq((Frequency),@Sig_gen)
1736         CALL Set_dbm(Dbm,1,@Sig_gen)
1738     END IF
1740     !
1742     ! .....Measure all frequencies .....
1744     !
1746     Fcount=1
1748     FOR Frequency=Fstart TO Fstop STEP Fstep
1750         DISP CHR$(129)
1752         DISP " TIME: ";TIME$(TIMEDATE);
1754         IF Test_type#="OTHER (NO STEPS)" THEN
1756             DISP " Now Testing: FREQUENCY =";Frequency;" MHz. "
1758         ELSE
1760             DISP " TUNER STEP ";Steps;" , FREQUENCY =";Frequency;" MHz. "
1762         END IF
1764         GOSUB Extract_caldata ! Get all calibration data for this
1766             ! frequency.
1768         Rawdata(1,Column)=Frequency
1770         IF Test_type#<>"MODE TUNE EMISSIONS" THEN
1772             CALL Set_freq((Frequency),@Sig_gen)
1774         END IF
1776         IF Search_eut THEN GOSUB Level_eut_out

```

```

1778         IF Search_pwr THEN GOSUB Level_net_input
1780         GOSUB Read_meters           ! Read all enabled instruments.
1782                                     ! See Configure_instr for changes.
1784                                     ! Calibration data is applied there
1786                                     ! via Apply_cal_data.
1788         !
1790         ! .....FILL the DATA file .....
1792         !
1794 Fill_data_file: ! **** Make sure this assignment matches defns.
1796         SELECT Test_type#
1798         CASE "MODE TUNE REGULAR"
1800             Rawdata(2,Column)=P1
1802             Rawdata(3,Column)=P2
1804             Rawdata(4,Column)=Sa_pwr
1806         CASE "MODE TUNE EMISSIONS"
1808             Rawdata(1,Column)=Sa_pwr
1810         CASE "OTHER (NO STEPS)"
1812             Rawdata(2,Column)=P1
1814             Rawdata(3,Column)=P2
1816             Rawdata(4,Column)=V1
1818         END SELECT
1820         !
1822         IF Total_chans>0 THEN
1824             FOR P=Total_meters+2 TO Total_chans+Total_meters+1
1826                 Rawdata(P,Column)=Probe_v_m(P-Total_meters-1)
1828             NEXT P
1830         END IF
1832         !.....
1834         IF Printflag AND Printflag2 THEN
1836             IF Total_chans>0 THEN GOSUB Print_headinfo
1838             GOSUB Printrawdata
1840         END IF
1842         Column=Column+1
1844         Fcount=Fcount+1
1846     NEXT Frequency
1848     !
1850     ! ..... ALL frequencies measured .....
1852     !
1854     IF Test_type#="OTHER (NO STEPS)" THEN
1856         GOSUB Save_data
1858     ELSE
1860         PRINT TIME$(TIMEDATE); "...Step number";Steps;" completed....."
1862         IF (Column+Ftotal-1>File20steps) OR (Steps=Tuner_steps) THEN
1864             Endstep=Steps
1866             GOSUB Save_data
1868             Beginstep=Endstep+1
1870             Column=1
1872             MAT Rawdata= Rawdata*(0.)
1874         END IF
1876         CALL Movemotor(@Motor)
1878     END IF
1880 UNTIL Steps>=Tuner_steps OR Test_type#="OTHER (NO STEPS)"
1882     !
1884     IF Test_type#<>"MODE TUNE EMISSIONS" THEN
1886         CALL Set_dbm(-140,0,@Sig_gen)
1888     END IF
1890     LOCAL 7
1892     RETURN ! ALL Measurements complete.
1894     !
1896     ! //////////////////////////////////////

```

```

1898 !
1900 Read_zero_field: !
1902 PRINT TIME$(TIMEDATE);" Step number";Steps;" , zero meters."
1904 !
1906 ! ..... Measure all zero field values .....
1908 !
1910 CALL Set_dbm(-140,0,@Sig_gen)
1912 IF Fp436a1 AND Fp436a2 THEN
1914     CALL Zero_pwr_mtrs(@Sig_gen,@Pwr1,@Pwr2)
1916 ELSE
1918     IF Fp436a1 THEN CALL Zero_pwr_mtrs(@Sig_gen,@Pwr1)
1920     IF Fp436a2 THEN CALL Zero_pwr_mtrs(@Sig_gen,@Pwr2)
1922 END IF
1924 IF Fp438a1 THEN
1926     Ab$="AB"
1928     CALL Zero_438a(@Dual_pwr1,Ab$)
1930 END IF
1932 IF Fp438a2 THEN
1934     Ab$="A"
1936     CALL Zero_438a(@Dual_pwr2,Ab$)
1938 END IF
1940 IF Fv3456a1 THEN CALL Readdvm(Z3456a1,@Dvm1)
1942 IF Fv3456a2 THEN CALL Readdvm(Z3456a2,@Dvm2)
1944 IF Fv3478a1 THEN CALL Readdvm(Z3478a1,@Dvm3)
1946 IF Bug1 THEN
1948     PRINTER IS Printer
1950     PRINT "Zeros DVM1=";Z3456a1;" , DVM2=";Z3456a2;" DVM3=";Z3478a1
1952     PRINTER IS CRT
1954 END IF
1956 !
1958 ! Fill Probe_volts(30) using Probe_addr(*) and Total_chans
1960 !
1962 IF Total_chans>0 THEN
1964     MAT Probe_zero= (0)
1966     CALL Read_probes(@Gpio)
1968     MAT Probe_zero= Probe_volts
1970     IF MAX(Probe_zero(*))>10 OR MIN(Probe_zero(*))<-10 THEN
1972         PRINT TIME$(TIMEDATE);" ... ";
1974         PRINT " WARNING ... Check Multiprobe zero ***** "
1976     END IF
1978 END IF
1980 RETURN
1982 !
1984 ! ////////////////////////////////// APPLY CALIBRATION TO MEASUREMENT DATA //////////////////////////////////
1986 !
1988 Apply_cal_data: ! For listing of valid variable names
1990             ! see Extract_caldata. Values are in ratio form.
1992 Cal_power_1_2: !
1994     F1=Power1*Doupinc*Pwrmtcal1*Padf_loss/(C10_3loss*Pads_loss)
1996     F2=Power2*Doupref1*Pwrmtcal1*C10_3loss*Pads_loss
1998     RETURN
2000     !-----
2002 Cal_power_3_4: !
2004     F3=Power3
2006     F4=Power4
2008     RETURN
2010     !-----
2012 Cal_power_5: !
2014     F5=Power5
2016     RETURN

```

```

2018 !-----
2020 Cal_power_6: !
2022   P6=Power6
2024   RETURN
2026 !-----
2028 Cal_sa_power: !
2030   Sa_pwr=Sa_power*C10_5loss*C4_2loss*C4_4loss
2032   RETURN
2034 !-----
2036 !
2038 ! //////////////////////////////////////
2040 !
2042 Read_meters: ! Control module for all instrument reads.
2044   Too_hot=0
2046   P1=0
2048   P2=0
2050   Checktime=TIMEDATE
2052 !-----
2054 Hp438a_1: !
2056   IF Fp438a1 THEN
2058     GOSUB Power_1_2 ! HP438A both channels
2060     ! returns Power1, Power2 (watts)
2062     IF Too_hot THEN GOTO Read_meters
2064     GOSUB Cal_power_1_2 ! correct for losses and return P1,P2
2066   Min_power: IF (P1-P2)<Min_pwr THEN
2068     BEEP
2070     PRINTER IS Printer
2072     PRINT TIME$(TIMEDATE); " "
2074     PRINT RPT$("-",40); " INPUT IS TOO LOW ! "
2076     PRINT "Raw P1=";Power1;" ** Cal P1=";P1
2078     PRINT "Raw P2=";Power2;" ** Cal P2=";P2
2080     PRINT "Net input power (P1-P2) =" ;P1-P2
2082     PRINT RPT$("-",40)
2084     PRINTER IS CRT
2086     GOSUB Adjust_power
2088     GOTO Read_meters
2090   END IF
2092 END IF
2094 !-----
2096 Hp438a_2: !
2098   IF Fp438a2 THEN
2100     GOSUB Power_3_4 ! Set for channel A (Power3) only, Power4=0
2102     ! returns Power3, Power4 (watts)
2104     IF Too_hot THEN GOTO Read_meters
2106     GOSUB Cal_power_3_4 ! correct for losses and return P3,P4
2108   END IF
2110 !-----
2112 Hp436a_1: !
2114   IF Fp436a1 THEN
2116     GOSUB Power_5 ! HP 436A
2118     ! returns Power5
2120     IF Too_hot THEN GOTO Read_meters
2122     GOSUB Cal_power_5 ! correct for losses and return P5
2124   END IF
2126 !-----
2128 Hp436a_2: !
2130   IF Fp436a2 THEN
2132     GOSUB Power_6 ! HP 436A
2134     ! returns Power6
2136     IF Too_hot THEN GOTO Read_meters

```

```

2138     GOSUB Cal_power_6 ! correct for losses and return P6
2140 END IF
2142 !-----
2144 Nbs_probes: !
2146 IF Total_chans>0 THEN GOSUB Probe_rnd ! Multiprobe system
2148 IF Too_hot THEN GOTO Read_meters ! returns corrected V/m.
2150 !-----
2152 Wait_loop: !
2154 LOOP
2156 EXIT IF (TIMEDATE-Checktime)>Time_out
2158 END LOOP
2160 !-----
2162 Hp3456a_1: ! ===== EUT connected to this dvm. =====
2164 IF Fv3456a1 THEN
2166 CALL Readdvm(Volt1,@Dvm1) ! HP digital voltmeter
2168 ! returns Volts (DC volts)
2170 V1=Volt1-Z3456a1 ! correct for zero, yields V1
2172 IF V1>Max_out THEN
2174 PRINTER IS Printer
2176 PRINT TIME$(TIMEDATE);"...DVM1 error / EUT overload. "
2178 PRINT "Set max=";Max_out;"; Reading=";Volt1;"; Zero=";Z3456a1;
2180 PRINT "; Adjusted reading=";V1
2182 PRINTER IS CRT
2184 GOSUB Reduce_power
2186 GOTO Read_meters
2188 END IF
2190 END IF
2192 !-----
2194 Hp3456a_2: !
2196 IF Fv3456a2 THEN
2198 CALL Readdvm(Volt2,@Dvm2) ! HP digital voltmeter
2200 ! returns Volts (DC volts)
2202 V2=Volt2-Z3456a2 ! correct for zero, yields V2
2204 END IF
2206 !-----
2208 Hp3478a_1: !
2210 IF Fv3478a1 THEN
2212 CALL Readdvm(Volt3,@Dvm3) ! HP digital voltmeter
2214 ! returns Volts (DC volts)
2216 V3=Volt3-Z3478a1 ! correct for zero, yields V3
2218 END IF
2220 !-----
2222 Hp59306a_relay: ! An example of using the relay to measure multiple
2224 ! quantities. This requires additional instrument to
2226 ! actually do the measurements, as the relay only controls
2228 ! a system of rf switches.
2230 ! In this example, turn off the Spectrum Analyzer flag.
2232 IF Fr59306a THEN
2234 OUTPUT @Rly1;"A123" ! Toggle to SUM port
2236 CALL Spec_alzr_start(Frequency,@Spec_alzr)
2238 CALL Spec_alzr_read(Sa_power,Frequency,@Spec_alzr)
2240 Sa_power=10.0^((Sa_power/10.0)-3.0) ! dBm -> watts
2242 GOSUB Cal_sa_power! correct for losses and return Sa_pwr
2244 Sum_power=Sa_pwr
2246 !
2248 OUTPUT @Rly1;"B123" ! Toggle to DIFFERENCE port
2250 CALL Spec_alzr_start(Frequency,@Spec_alzr)
2252 CALL Spec_alzr_read(Sa_power,Frequency,@Spec_alzr)
2254 Sa_power=10.0^((Sa_power/10.0)-3.0) ! dBm -> watts
2256 GOSUB Cal_sa_power! correct for losses and return Sa_pwr

```

```

2258         Diff_power=Sa_pwr
2260     END IF
2262     !-----
2264 Spec_alzr:!
2266     IF Fsa8566b AND NOT Fr59306a THEN ! HP8566B Spectrum analyzer
2268         CALL Spec_alzr_start(Frequency,@Spec_alzr)
2270         CALL Spec_alzr_read(Sa_power,Frequency,@Spec_alzr)
2272         Sa_power=10.0^((Sa_power/10.0)-3.0) ! dBm -> watts
2274         GOSUB Cal_sa_power! correct for losses and return Sa_pwr
2276     END IF
2278     RETURN
2280     !
2282     ! /////////////// Read instrument subroutines ///////////////
2284     !
2286     ! ..... HP 438A Dual power meter - @Dual_pwr1 .....
2288     !
2290 Power_1_2:Ab$="AB"
2292     CALL Read_dual_pwr (Ab$,Apower,Bpower,Too_hot,Valid,@Dual_pwr1)
2294     IF Too_hot THEN
2296         GOSUB Reduce_power
2298     RETURN
2300     END IF
2302     IF NOT Valid AND NOT Too_hot THEN
2304         GOSUB Dual_pwr_error
2306         GOTO Power_1_2 ! Repeat measurements
2308     END IF
2310     IF Ab$="AB" OR Ab$="A" THEN
2312         IF Apower<0. THEN Apower=0. ! Power detectors are not sources
2314         Power1=Apower
2316     END IF
2318     IF Ab$="AB" OR Ab$="B" THEN
2320         IF Bpower<0. THEN Bpower=0.
2322         Power2=Bpower
2324     END IF
2326     RETURN
2328     !
2330     ! ..... HP 438A Dual power meter - @Dual_pwr2 .....
2332     !
2334 Power_3_4:Ab$="A" ! or Ab$="AB" if you want both channels.
2336     CALL Read_dual_pwr (Ab$,Apower,Bpower,Too_hot,Valid,@Dual_pwr2)
2338     IF Too_hot THEN
2340         GOSUB Reduce_power
2342     RETURN
2344     END IF
2346     IF NOT Valid AND NOT Too_hot THEN
2348         GOSUB Dual_pwr_error
2350         GOTO Power_3_4 ! Repeat measurements
2352     END IF
2354     IF Ab$="AB" OR Ab$="A" THEN
2356         IF Apower<0. THEN Apower=0. ! Power detectors are not sources
2358         Power3=Apower
2360     END IF
2362     IF Ab$="AB" OR Ab$="B" THEN
2364         IF Bpower<0. THEN Bpower=0.
2366         Power4=Bpower
2368     END IF
2370     RETURN
2372     !
2374     ! ..... HP 436A Power meter - @Pwr1 .....
2376     !

```

```

2378 Power_5: ! Pwr_id#="P1"
2380 CALL Read_pwr_meter(Power,Pwr_id#,Valid,@Pwr1,@Sig_gen)
2382 IF NOT Valid THEN
2384     DISP "ERROR IN 436a POWER METER 1"
2386     BEEP
2388     PAUSE
2390     Power=0.
2392     Too_hot=1
2394 END IF
2396 IF Power<0. THEN Power=0.
2398 Power5=Power
2400 RETURN
2402 !
2404 ! ..... HP 436A Power meter - @Pwr2 .....
2406 !
2408 Power_6: ! Pwr_id#="P6"
2410 CALL Read_pwr_meter(Power,Pwr_id#,Valid,@Pwr2,@Sig_gen)
2412 IF NOT Valid THEN
2414     DISP "ERROR IN 436a POWER METER 2"
2416     BEEP
2418     PAUSE
2420     Power=0.
2422     Too_hot=1
2424 END IF
2426 IF Power<0. THEN Power=0.
2428 Power6=Power
2430 RETURN
2432 !
2434 ! ..... NBS Multiprobe system .....
2436 !
2438 Probe_rd:
2440 IF Total_chans>0 THEN
2442     CALL Read_probes(@Gpio)
2444     Too_hot=0
2446     FOR P=1 TO Total_chans
2448         Too_hot=Too_hot OR Overrange(P)
2450     NEXT P
2452     IF Too_hot THEN
2454         GOSUB Reduce_power
2456     ELSE
2458         CALL Apply_probe_cal(Frequency) ! Amplitude correction.
2460                                         ! Frequency correction.
2462     END IF
2464 END IF
2466 RETURN
2468 !
2470 ! //////////////////////////////////////
2472 !
2474 Level_eut_out: ! This routine will adjust the signal generator
2476                 ! output to cause the EUT output (tied to @Dvm1)
2478                 ! to fall within the limits of Min_eut and Max_eut.
2480                 ! All the while within the bounds of Low_dbm to High_dbm.
2482 !
2484 !
2486 !
2488 !
2490 !
2492 RETURN
2494 !
2496 ! //////////////////////////////////////

```

```

2498      !
2500 Level_net_input: ! This routine will adjust the signal generator
2502                  ! output to cause the corrected net input power
2504                  ! to fall within the limits of Min_pwr and Max_pwr
2506                  ! All the while within the bounds of Low_dbm to High_dbm.
2508      !
2510      !
2512      !
2514      !
2516      !
2518      RETURN
2520      !
2522      ! ///////////////////////////////////////////////////////////////////
2524      !
2526 Adjust_power:  !
2528      DISP " INPUT power is too low. Check system (Continue-k5) "
2530      ON KEY 5 LABEL "Continue",Local_prty GOTO Tryitagain
2532      ON KEY 0 LABEL "Reduce Power",Local_prty GOSUB Reduce_power
2534      ON KEY 2 LABEL "Increase Pwr",Local_prty GOSUB Increase_pwr
2536      LOOP
2538      Myself:ON KEY 6 LABEL " dBm=%VAL$(Dbm),Local_prty GOTO Myself
2540      END LOOP
2542      Tryitagain:OFF KEY
2544      DISP CHR$(12)
2546      RETURN
2548      ! .....
2550 Reduce_power: !
2552      Dbm=Dbm-1
2554      CALL Set_dbm(Dbm,1,@Sig_gen)
2556      IF Printflag THEN
2558          PRINTER IS Printer
2560          PRINT TIME$(TIMEDATE);": Step#";Steps;" Freq=";Frequency;
2562          PRINT RPT#("*",10);" NEW GENERATOR LEVEL =" ;Dbm
2564          PRINTER IS CRT
2566      END IF
2568      RETURN
2570      ! .....
2572 Increase_pwr: !
2574      Dbm=Dbm+1
2576      CALL Set_dbm(Dbm,1,@Sig_gen)
2578      IF Printflag THEN
2580          PRINTER IS Printer
2582          PRINT TIME$(TIMEDATE);": Step#";Steps;" Freq=";Frequency;
2584          PRINT RPT#("*",10);" NEW GENERATOR LEVEL =" ;Dbm
2586          PRINTER IS CRT
2588      END IF
2590      RETURN
2592      !
2594      ! ///////////////////////////////////////////////////////////////////
2596      !
2598 Dual_pwr_error: !
2600      CALL Set_dbm(-140,0,@Sig_gen)      ! Kill power
2602      IF Printflag THEN
2604          PRINTER IS Printer
2606          PRINT TIME$(TIMEDATE);": Step#";Steps;" Freq=";Frequency;
2608          PRINT RPT#("*",10);" ERROR IN DUAL POWER METER !!!"
2610          PRINTER IS CRT
2612      END IF
2614      DISP " ERROR in DUAL POWER METER, correct and 'CONTINUE' "
2616      BEEP

```

```

2618 PAUSE
2620 CALL Set_dbm(Dbm,1,@Sig_gen) ! Restore power.
2622 RETURN
2624 !
2626 ! ////////////////***PRINT HEADING FOR RAW DATA***////////////////////
2628 !
2630 Print_headinfo: ! Values in order of insertion into matrix.
2632 PRINTER IS Printer
2634 PRINT
2636 SELECT Test_type#
2638 CASE "MODE TUNE REGULAR"
2640 PRINT RPT#("-",15);"Identifier: ";Run_id#;
2642 PRINT " STEP NUMBER ";Steps;RPT#("-",15)
2644 PRINT "FREQUENCY INC-PWR REFL-PWR ";
2646 PRINT " REC-PWR"
2648 PRINT " MHz Watts Watts ";
2650 PRINT " Watts"
2652 CASE "MODE TUNE EMISSIONS"
2654 PRINT RPT#("-",15);"Identifier: ";Run_id#;
2656 PRINT " STEP NUMBER ";Steps;RPT#("-",15)
2658 PRINT "FREQUENCY REC-PWR "
2660 PRINT " MHz Watts "
2662 CASE "OTHER (NO STEPS)"
2664 PRINT RPT#("=",80)
2666 PRINT "Measurement Identifier: ";Run_id#
2668 PRINT Measmt_id#
2670 PRINT RPT#(".",80)
2672 PRINT
2674 PRINT "FREQUENCY INC-PWR REFL-PWR ";
2676 PRINT " Probe OUTPUT"
2678 PRINT " MHz Watts Watts ";
2680 PRINT " VoIts"
2682 END SELECT
2684 PRINTER IS CRT
2686 RETURN
2688 !
2690 ! ////////////////***PRINT RAW DATA***////////////////////
2692 !
2694 Printrawdata: !
2696 Rawimage1: IMAGE 6D.2D,X,#
2698 Rawimage2: IMAGE #,MD.DDDE,X
2700 PRINTER IS Printer
2702 PRINT USING Rawimage1;Rawdata(1,Column)
2704 FOR I=2 TO Total_meters+1
2706 PRINT USING Rawimage2;Rawdata(I,Column)
2708 NEXT I
2710 PRINT
2712 IF Total_chans>1 THEN GOSUB Print_probes
2714 PRINTER IS CRT
2716 RETURN
2718 !
2720 ! ////////////////***PRINT RAW DATA***////////////////////
2722 !
2724 Print_probes: !
2726 PRINT RPT#(" ",80)
2728 PRINT "Amp# Probe# Axis Zero Output Drng?";
2730 PRINT " VoIts/mtr"
2732 Pimage1: IMAGE M3D,2X,M3D,3X,A,3X,2(M4D,2X),MDD,2X,M4D.2D
2734 FOR I=1 TO Total_chans
2736 Amp=Probe_addr(I,1)

```

```

2738         Probe=Probe_addr(I,2)
2740         SELECT Probe_addr(I,3)
2742         CASE 1
2744             Ax#="X"
2746         CASE 2
2748             Ax#="Y"
2750         CASE 3
2752             Ax#="Z"
2754         CASE 4
2756             Ax#="S"
2758         CASE ELSE
2760             Ax#="E"
2762         END SELECT
2764         Org=Overrange(I)
2766         Zer=Probe_zero(I)
2768         A_d=Probe_volts(I)
2770         V_m=Rawdata(Total_meters+I+1,Column)
2772         PRINT USING Pimage1;Amp,Probe,Ax#,Zer,A_d,Org,V_m
2774     NEXT I
2776     PRINT RPT#("_",80)
2778     PRINT
2780     PRINT
2782     RETURN
2784     !
2786     !!!!!!!!!!!!!!!!!!!!!!!!!!!!!!!**SAVE DATA**!!!!!!!!!!!!!!!!!!!!!!!!!!!!!!
2788     !
2790 Save_data: !
2792     ON ERROR CALL Errortrap
2794     IF Test_type#="OTHER (NO STEPS)" THEN
2796         Filename#=Run_id#
2798     ELSE
2800         Filename#="S"&VAL#(Beginstep)&_" "&VAL#(Endstep)
2802     END IF
2804     Filename#=Filename#&Outdisk#
2806     Filesize=INT(((Total_chans+Total_meters+1)*File20steps*8)/256)+2
2808     CREATE BDAT Filename#,Filesize,256
2810     ASSIGN @Datapath TO Filename#
2812     OUTPUT @Datapath;Rawdata(*)
2814     ASSIGN @Datapath TO *
2816     PRINTER IS Printer
2818     IF Test_type#="OTHER (NO STEPS)" THEN
2820         PRINT TIME#(TIMEDATE);" ..... DATA STORED ON FILE ";Filename#
2822     ELSE
2824         Filename#="S"&VAL#(Beginstep)&_" "&VAL#(Endstep)
2826         PRINT TIME#(TIMEDATE);".....DATA FOR STEPS ";
2828         PRINT Beginstep;" TO ";Endstep;" STORED ON FILE ";Filename#
2830     END IF
2832     OFF ERROR
2834     PRINTER IS CRT
2836     RETURN
2838     !
2840     !!!!!!!!!!!!!!!!!!!!!!!!!!!!!!!**SAVE CONFIGURE **!!!!!!!!!!!!!!!!!!!!!!!!!!!!!!
2842     !
2844 Save_configure: !
2846     ON ERROR CALL Errortrap
2848     Filename#="CONFIGURE"
2850     Filename#=Filename#&Outdisk#
2852     CREATE BDAT Filename#,16,256
2854     ASSIGN @Datapath TO Filename#
2856     OUTPUT @Datapath;Run_id#

```

```

2858 OUTPUT @Datapath;Measmt_id#
2860 OUTPUT @Datapath;Time_date#
2862 OUTPUT @Datapath;Fstart,Fstop,Fstep
2864 IF Test_type#="OTHER (NO STEPS)" THEN
2866     OUTPUT @Datapath;1
2868 ELSE
2870     OUTPUT @Datapath;Total_steps
2872 END IF
2874 OUTPUT @Datapath;Total_meters
2876 OUTPUT @Datapath;Total_chans
2878 OUTPUT @Datapath;Probe_addr(*)
2880 OUTPUT @Datapath;Meter_defns#(*)
2882 OUTPUT @Datapath;File20steps
2884 ASSIGN @Datapath TO *
2886 OFF ERROR
2888 PRINTER IS CRT
2890 PRINT TIME#(TIMEDATE);"  CONFIGURE file for ";Run_id#;" SAVED."
2892 RETURN
2894 !
2896 ! //////////////////////////////////////
2898 !
2900 Print_vitals: !
2902 PRINTER IS Printer
2904 PRINT RPT#("-",80)
2906 PRINT "THIS DATA SET IS IDENTIFIED AS: ";Run_id#
2908 PRINT "MEASUREMENT date: ";Time_date#
2910 PRINT RPT#("-",80)
2912 PRINT Measmt_id#
2914 PRINT RPT#("-",80)
2916 PRINT "FREQUENCIES ";Fstart;" TO ";
2918 PRINT Fstop;" STEP ";Fstep;" MHz."
2920 PRINT "THE TUNER STEPPED ";Total_steps;" increments."
2922 PRINT Total_meters;" PWR METERS and DVMS, along with ";Total_chans;
2924 PRINT " channels of the NBS multiprobe system."
2926 PRINT
2928 PRINT "The measured DATA are defined as follows:"
2930 PRINT RPT#("-",80)
2932 PRINT "Data slot #   Description";
2934 PRINT TAB(40);"Data slot #   Description"
2936 J=INT(((Total_chans+Total_meters)/2)+1)
2938 IF J<>((Total_chans+Total_meters)/2)+1 THEN J=J+1
2940 I=1
2942 K=J           ! J is startingpoint of second column.
2944 REPEAT
2946     PRINT I;" : ";Meter_defns#(I);
2948     IF K<=Total_chans+Total_meters THEN
2950         PRINT TAB(40);K;" : ";Meter_defns#(K)
2952     ELSE
2954         PRINT
2956     END IF
2958     I=I+1
2960     K=K+1
2962 UNTIL I>=J
2964 PRINT RPT#("-",80)
2966 PRINT USING "2/"
2968 PRINTER IS CRT
2970 RETURN
2972 !
2974 ! //////////////////////////////////////
2976 !

```

```

2978 END
2980 !
2982 ! *****
2984 !
2986 SUB Measure_menu
2988 Measure_menu: !
2990 ! Original: 5 May 1984
2992 ! Revision: 24 Jan 1986
2994 !
2996 ! This routine will facilitate setting up the
2998 ! measurement by providing MENU access to the
3000 ! parameters.
3002 !
3004 COM /Parameters/ REAL Fstart,Fstop,Fstep
3006 COM /Parameters/ REAL Min_eut,Max_eut,Min_pwr,Max_pwr,Time_eut
3008 COM /Parameters/ INTEGER Low_dbm,High_dbm,Step_dbm
3010 COM /Parameters/ INTEGER Search_eut,Search_pwr,Re_run
3012 COM /Parameters/ INTEGER Begin_step,Total_steps,Total_meters
3014 COM /Parameters/ Run_id#,Measmt_id#,Time_date#
3016 COM /Parameters/ Meter_defns#(*),Operator_name#,Test_type#
3018 COM /Parameters/ Coupler_id#,Generator_id#
3020 !
3022 COM /Files/ Sourcedisk#,Outdisk#,Filename#
3024 COM /Bugs/ INTEGER Bug1,Bug2,Bug3,Printer
3026 COM /Interrupts/ INTEGER Intr_prt
3028 DIM Test#[160]
3030 INTEGER Local_prt,I,Ascii_num,Interrupted
3032 Local_prt=Intr_prt
3034 DISP CHR$(129)
3036 !
3038 IF Printer=701 THEN
3040     ON TIMEOUT 7,.5 GOSUB Printerdead
3042     PRINT
3044     OFF TIMEOUT
3046 END IF
3048 !
3050 IF Bug1 THEN
3052     PRINT TIME$(TIMEDATE);RPT$(" ",10);" ENTER Measure_menu"
3054 END IF
3056 CALL Wipe_clean ! Clear the CRT.
3058 PRINTER IS CRT
3060 GOSUB Write_backgd ! Format menu area.
3062 IF NOT Re_run THEN
3064     GOSUB Start_up_values ! Initial values
3066 ! Put initial values in menu
3068 ELSE
3070     GOSUB Fill_in_values ! Put current values in menu
3072 END IF
3074 !
3076 !Make any changes or corrections.
3078 !
3080 GOSUB Define_keys
3082 PRINT TABXY(56,3);DATE$(TIMEDATE)
3084 LOOP
3086 IF Interrupted THEN GOSUB Define_keys
3088 ON KEY 5 LABEL "EXIT ^RESET",Local_prt GOTO Exit_sub
3090 ON KEY 15,Local_prt GOSUB Start_up_values
3092 PRINT TABXY(69,3);TIME$(TIMEDATE)
3094 END LOOP
3096 Exit sub:!
```

```

2978 END
2980 !
2982 ! *****
2984 !
2986 SUB Measure_menu
2988 Measure_menu: !
2990 ! Original: 5 May 1984
2992 ! Revision: 24 Jan 1986
2994 !
2996 ! This routine will facilitate setting up the
2998 ! measurement by providing MENU access to the
3000 ! parameters.
3002 !
3004 COM /Parameters/ REAL Fstart,Fstop,Fstep
3006 COM /Parameters/ REAL Min_eut,Max_eut,Min_pwr,Max_pwr,Time_eut
3008 COM /Parameters/ INTEGER Low_dbm,High_dbm,Step_dbm
3010 COM /Parameters/ INTEGER Search_eut,Search_pwr,Re_run
3012 COM /Parameters/ INTEGER Begin_step,Total_steps,total_meters
3014 COM /Parameters/ Run_id#,Measmt_id#,Time_date#
3016 COM /Parameters/ Meter_defns#(*),Operator_name#,Test_type#
3018 COM /Parameters/ Coupler_id#,Generator_id#
3020 !
3022 COM /Files/ Sourcedisk#,Outdisk#,Filename#
3024 COM /Bugs/ INTEGER Bug1,Bug2,Bug3,Printer
3026 COM /Interrupts/ INTEGER Intr_pnty
3028 DIM Test#[160]
3030 INTEGER Local_pnty,I,Ascii_num,Interrupted
3032 Local_pnty=Intr_pnty
3034 DISP CHR$(129)
3036 !
3038 IF Printer=701 THEN
3040     ON TIMEOUT 7,.5 GOSUB Printerdead
3042     PRINT
3044     OFF TIMEOUT
3046 END IF
3048 !
3050 IF Bug1 THEN
3052     PRINT TIME$(TIMEDATE);RPT$(" ",10);" ENTER Measure_menu"
3054 END IF
3056 CALL Wipe_clean           ! Clear the CRT.
3058 PRINTER IS CRT
3060 GOSUB Write_backgnd      ! Format menu area.
3062 IF NOT Re_run THEN
3064     GOSUB Start_up_values ! Initial values
3066                             ! Put initial values in menu
3068 ELSE
3070     GOSUB Fill_in_values  ! Put current values in menu
3072 END IF
3074 !
3076 !Make any changes or corrections.
3078 !
3080 GOSUB Define_keys
3082 PRINT TABXY(56,3);DATE$(TIMEDATE)
3084 LOOP
3086     IF Interrupted THEN GOSUB Define_keys
3088     ON KEY 5 LABEL "EXIT ^RESET",Local_pnty GOTO Exit_sub
3090     ON KEY 15,Local_pnty GOSUB Start_up_values
3092     PRINT TABXY(69,3);TIME$(TIMEDATE)
3094     END LOOP
3096 Exit_sub:!
```

```

3098     OFF KEY
3100     DISP CHR$(12)
3102     Time_date#=TIME$(TIMEDATE)&"; "&DATE$(TIMEDATE)
3104     PRINTER IS Printer
3106     IF Printer=701 THEN DUMP ALPHA
3108     IF Bug1 THEN
3110         PRINT TIME$(TIMEDATE);RPT$("*",10);" EXIT Measure_menu"
3112     END IF
3114     CALL Wipe_clean
3116     PRINTER IS CRT
3118     SUBEXIT
3120     !
3122     ! ////////////////////////////////////////////////////
3124     !
3126 Define_keys:!
3128     OFF KEY
3130     Interrupted=0
3132     DISP RPT$("<",15);"     SELECT PARAMETER TO CHANGE ";
3134     DISP " (^shift key)     ";RPT$(">",15)
3136     ON KEY 0 LABEL "TEST ID ^TYPE",Local_prty GOSUB Change_eutid
3138     ON KEY 10,Local_prty GOSUB Change_type
3140     ON KEY 1 LABEL "FREQS ^SIG GEN",Local_prty GOSUB Change_freqs
3142     ON KEY 11,Local_prty GOSUB Change_levels
3144     ON KEY 2 LABEL "INPUT MIN ^MAX",Local_prty GOSUB Change_pwr_min
3146     ON KEY 12,Local_prty GOSUB Change_pwr_max
3148     ON KEY 3 LABEL "LEVEL ^SEARCH",Local_prty GOSUB Change_search_p
3150     ON KEY 13,Local_prty GOSUB Change_search_e
3152     ON KEY 4 LABEL "EUT MIN ^MAX",Local_prty GOSUB Change_eut_min
3154     ON KEY 14,Local_prty GOSUB Change_eut_max
3156     ON KEY 6 LABEL "DATE ^NAME",Local_prty GOSUB Call_time_date
3158     ON KEY 16,Local_prty GOSUB Enter_name
3160     ON KEY 7 LABEL "Response Time",Local_prty GOSUB Change_response
3162     IF Test_type#<>"OTHER (NO STEPS)" THEN
3164         ON KEY 8 LABEL "TUNER ^BEGIN",Local_prty GOSUB Change_tuner
3166         ON KEY 18,Local_prty GOSUB Change_beginstp
3168     END IF
3170     ON KEY 9 LABEL "DISK DRIVE",Local_prty GOSUB Change_diskdriv
3172     RETURN
3174     !
3176     ! ////////////////////////////////////////////////////
3178     !
3180 Start_up_values: ! Define the initial values for all parameters.
3182     Re_run=1
3184     Fstart=100           ! Frequency range in MHz.
3186     Fstop=1000
3188     Fstep=50
3190     Low_dbm=-40        ! Signal generator level in dBm.
3192     High_dbm=-10
3194     Step_dbm=1
3196     Search_eut=0      ! 0= DO NOT auto search for EUT response
3198                       ! 1= DO
3200     Search_pwr=0      ! 0= DO NOT auto level the Net Input power.
3202                       ! 1= DO
3204     Min_eut=1.0E-6    ! Minimum output of EUT in volts.
3206     Max_eut=10.0      ! Maximum output of EUT in volts.
3208     Min_pwr=1.0E-6    ! Minimum net input power in watts.
3210     Max_pwr=10.0      ! Maximum net input power in watts.
3212     Time_eut=0.      ! Time for EUT to respond after field is set.
3214     Begin_step=1
3216     Total_steps=200  !An integer division of 3200

```

```

3218 Test_type#="MODE TUNE REGULAR" !or "MODE TUNE EMISSIONS"
3220 !or "OTHER (NO STEPS)"
3222 Run_id#="Run_1"
3224 Operator_name#="Galen Koepke"
3226 Measmt_id#="Evaluate the susceptability of a device"
3228 Measmt_id#="Measmt_id#%" in the NBS Reverberating Chamber."
3230 Coupler_id#="HP_778D"
3232 Generator_id#="HP_8660A"
3234 !
3236 GOSUB Fill_in_values ! Put initial values in menu
3238 RETURN
3240 !
3242 ! ////////////////////////////////////////////////////////////////////
3244 !
3246 Fill_in_values:
3248 !
3250 GOSUB Change_eutid ! Fill in the values
3252 GOSUB Print_type
3254 GOSUB Print_freqs
3256 GOSUB Print_gen_level
3258 GOSUB Print_beginstp
3260 GOSUB Print_tuner
3262 GOSUB Print_name
3264 GOSUB Print_search_p
3266 GOSUB Print_search_e
3268 GOSUB Print_eut_min
3270 GOSUB Print_eut_max
3272 GOSUB Print_pwr_min
3274 GOSUB Print_pwr_max
3276 GOSUB Print_wait
3278 GOSUB Print_diskdrive
3280 RETURN
3282 !
3284 ! ////////////////////////////////////////////////////////////////////
3286 !
3288 Write_backgnd: ! Format menu area.
3290 PRINT CHR$(129)
3292 PRINT TABXY(16,1);" ***MEASUREMENT PARAMETERS - *** "
3294 PRINT TABXY(1,3);" TEST ID: "
3296 PRINT TABXY(23,3);" TYPE: "
3298 PRINT TABXY(41,3);" DATE / TIME: "
3300 !
3302 PRINT CHR$(132);
3304 PRINT TABXY(1,5);RPT#(" ",160)
3306 PRINT CHR$(129);
3308 !
3310 PRINT TABXY(1,8);" FREQUENCY (MHz) "
3312 PRINT TABXY(1,9);" LOW: "
3314 PRINT TABXY(1,10);" HIGH: "
3316 PRINT TABXY(1,11);" STEP: "
3318 PRINT TABXY(21,8);" GENERATOR (dBm) "
3320 !
3322 PRINT TABXY(41,8);" NET INPUT POWER (W) "
3324 PRINT TABXY(41,9);" MIN: "
3326 PRINT TABXY(41,10);" MAX: "
3328 PRINT TABXY(41,11);" LEVEL INPUT? "
3330 PRINT TABXY(65,8);" EUT RESPONSE "
3332 PRINT TABXY(65,11);" SEARCH? "
3334 PRINT CHR$(128);
3336 PRINT TABXY(62,9);"... "

```

```

3338     PRINT TABXY(62,10);"... "
3340     PRINT CHR$(129);
3342     PRINT TABXY(1,13);" ESTIMATE EUT RESPONSE TIME "
3344     PRINT TABXY(41,13);" seconds. ";RPT#(" ",30)
3346     PRINT TABXY(41,15);" COUPLER/SIG GEN:";
3348     PRINT TABXY(1,15);" BEGIN TUNER POSITION "
3350     PRINT TABXY(29,15);" END "
3352     PRINT TABXY(1,17);" OPERATOR: ";
3354     PRINT TABXY(41,17);" OUTPUT DISK DRIVE: "
3356     PRINT CHR$(128)
3358     RETURN
3360     !
3362     ! ////////////////////////////////////////////////////////////////////
3364     !
3366 Printerdead:DISP "NO PRINTER at HPiB address 701 !!";
3368     DISP " Please correct situation and hit 'CONTINUE'"
3370     BEEP
3372     PAUSE
3374     RETURN
3376     !
3378     ! ////////////////////////////////////////////////////////////////////
3380     !
3382 Call_time_date:Interrupted=1
3384     CALL Time_date
3386     RETURN
3388     !
3390     ! ////////////////////////////////////////////////////////////////////
3392     !
3394 Change_eut_max:Interrupted=1
3396     IF Test_type#="MODE TUNE EMISSIONS" THEN RETURN
3398     DISP " ENTER the UPPER LIMIT for the EUT RESPONSE (your units) ";
3400     INPUT Max_eut
3402     IF Max_eut<Min_eut THEN
3404         Min_eut=Max_eut
3406         GOSUB Print_eut_min
3408     END IF
3410 Print_eut_max:!
3412     PRINT TABXY(66,10);
3414     IF Test_type#="MODE TUNE EMISSIONS" THEN
3416         PRINT USING "9A";" Not used"
3418     ELSE
3420         PRINT USING "MD.2DE";Max_eut
3422     END IF
3424     RETURN
3426     !
3428     ! ////////////////////////////////////////////////////////////////////
3430     !
3432 Change_eut_min:Interrupted=1
3434     IF NOT Search_eut OR Test_type#="MODE TUNE EMISSIONS" THEN RETURN
3436     DISP " ENTER the LOWER LIMIT for the EUT RESPONSE (your units) ";
3438     INPUT Min_eut
3440     IF Min_eut>Max_eut THEN Min_eut=Max_eut
3442 Print_eut_min:!
3444     PRINT TABXY(66,9);
3446     IF NOT Search_eut OR Test_type#="MODE TUNE EMISSIONS" THEN
3448         PRINT USING "9A";" Not used"
3450     ELSE
3452         PRINT USING "MD.2DE";Min_eut
3454     END IF
3456     RETURN

```

```

3458      !
3460      ! ////////////////////////////////////////////////////////////////////
3462      !
3464 Change_pwr_max:Interrupted=1
3466      IF NOT Search_pwr OR Test_type#="MODE TUNE EMISSIONS" THEN RETURN
3468      DISP " ENTER the Maximum NET Input Power ";
3470      INPUT Max_pwr
3472      IF Max_pwr<0. THEN Max_pwr=0.
3474      IF Max_pwr<Min_pwr THEN
3476          Min_pwr=Max_pwr
3478          GOSUB Print_pwr_min
3480      END IF
3482 Print_pwr_max:!
3484      PRINT TABXY(50,10);
3486      IF NOT Search_pwr OR Test_type#="MODE TUNE EMISSIONS" THEN
3488          PRINT USING "9A";" Not used"
3490      ELSE
3492          PRINT USING "MD.2DE";Max_pwr
3494      END IF
3496      RETURN
3498      !
3500      ! ////////////////////////////////////////////////////////////////////
3502      !
3504 Change_pwr_min:Interrupted=1
3506      IF Test_type#="MODE TUNE EMISSIONS" THEN RETURN
3508      DISP " ENTER the Minimum NET Input Power ";
3510      INPUT Min_pwr
3512      IF Min_pwr<0. THEN Min_pwr=0.
3514      IF Min_pwr>Max_pwr THEN Min_pwr=Max_pwr
3516 Print_pwr_min:!
3518      PRINT TABXY(50,9);
3520      IF Test_type#="MODE TUNE EMISSIONS" THEN
3522          PRINT USING "9A";" Not used"
3524      ELSE
3526          PRINT USING "MD.2DE";Min_pwr
3528      END IF
3530      RETURN
3532      !
3534      ! ////////////////////////////////////////////////////////////////////
3536      !
3538 Change_search_p:!
3540      IF Search_pwr=0 AND Search_eut=0 THEN
3542          Search_pwr=1
3544      ELSE
3546          Search_pwr=0
3548      END IF
3550      GOSUB Print_gen_level
3552      GOSUB Print_pwr_max
3554 Print_search_p:!
3556      PRINT TABXY(56,11);
3558      IF Test_type#="MODE TUNE EMISSIONS" THEN
3560          PRINT "OFF"
3562      ELSE
3564          IF Search_pwr THEN
3566              PRINT "ON "
3568          ELSE
3570              PRINT "OFF"
3572          END IF
3574      END IF
3576      RETURN

```

```

3578      !
3580      ! ////////////////////////////////////////////////////
3582      !
3584      Change_search_e: !
3586          IF Search_eut=0 AND Search_pwr=0 THEN!
3588              Search_eut=1
3590          ELSE
3592              Search_eut=0
3594          END IF
3596          GOSUB Print_gen_level
3598          GOSUB Print_eut_min
3600      Print_search_e: !
3602          PRINT TABXY(75,11);
3604          IF Test_type#="MODE TUNE EMISSIONS" THEN
3606              PRINT "OFF"
3608          ELSE
3610              IF Search_eut THEN
3612                  PRINT "ON "
3614              ELSE
3616                  PRINT "OFF"
3618              END IF
3620          END IF
3622          RETURN
3624          !
3626          ! ////////////////////////////////////////////////////
3628          !
3630      Change_type: !
3632          Interrupted=1
3634          OFF KEY
3636          DISP " SELECT MEASUREMENT TYPE. "
3638          ON KEY 0 LABEL "Source = ANT",Local_prt+1 GOTO Source_ant
3640          ON KEY 2 LABEL "Source = EUT",Local_prt+1 GOTO Source_eut
3642          ON KEY 4 LABEL "NO TUNER STF",Local_prt+1 GOTO Notunerstep
3644          LOOP
3646          END LOOP
3648      Source_ant: ! Regular MODE TUNED TESTS with transmitting antenna
3650          Test_type#="MODE TUNE REGULAR"
3652          Measmt_id#="Evaluate the susceptibility of a device"
3654          Measmt_id#="Measmt_id#%" in the NBS Reverberating Chamber."
3656          GOSUB Print_eutid
3658          GOTO New_type
3660      Source_eut: ! Emissions using MODE TUNED sequence, EUT is source
3662          Test_type#="MODE TUNE EMISSIONS"
3664          Measmt_id#="Measure the radiated emissions of a device"
3666          Measmt_id#="Measmt_id#%" in the NBS Reverberating Chamber."
3668          GOSUB Print_eutid
3670          GOTO New_type
3672      Notunerstep: ! Other measurements that require no TUNER stepping
3674          Test_type#="OTHER (NO STEPS)"
3676          Measmt_id#="Measure the response of a device to a field"
3678          Measmt_id#="Measmt_id#%" in the NBS 1.2 meter TEM CELL."
3680          GOSUB Print_eutid
3682      New_type: OFF KEY
3684          ! Update all the menu items affected by TYPE change.
3686          GOSUB Print_gen_level
3688          GOSUB Print_beginstp
3690          GOSUB Print_tuner
3692          GOSUB Print_search_e
3694          GOSUB Print_search_p
3696          GOSUB Print_gen_id

```

```

3698     GOSUB Print_pwr_min
3700     GOSUB Print_pwr_max
3702     GOSUB Print_eut_min
3704     GOSUB Print_eut_max
3706 Print_type: !
3708     PRINT CHR$(129);
3710     PRINT TABXY(45,1);
3712     SELECT Test_type#
3714     CASE "MODE TUNE REGULAR","MODE TUNE EMISSIONS"
3716         PRINT "MODE TUNED TESTS";
3718     CASE "OTHER (NO STEPS)"
3720         PRINT "TEM CELL TESTS  ";
3722     CASE ELSE
3724         PRINT "?????????????????";
3726     END SELECT
3728     PRINT CHR$(128);
3730     PRINT TABXY(31,3);
3732     SELECT Test_type#
3734     CASE "MODE TUNE REGULAR"
3736         PRINT "REGULAR  ";
3738     CASE "MODE TUNE EMISSIONS"
3740         PRINT "EMISSIONS";
3742     CASE "OTHER (NO STEPS)"
3744         PRINT "OTHER    ";
3746     CASE ELSE
3748         PRINT "?????????";
3750     END SELECT
3752     RETURN
3754     !
3756     ! ////////////////////////////////////////////////////////////////////
3758     !
3760 Change_beginstp: Interrupted=1
3762     IF Test_type#="OTHER (NO STEPS)" THEN GOTO Print_beginstp
3764     DISP " ENTER THE BEGINNING TUNER STEP NUMBER ";
3766     INPUT Begin_step
3768     IF Begin_step>Total_steps THEN Begin_step=Total_steps
3770 Print_beginstp: !
3772     PRINT TABXY(24,15);
3774     IF Test_type#<>"OTHER (NO STEPS)" THEN
3776         PRINT USING "4D";Begin_step
3778     ELSE
3780         PRINT USING "4A";"N/A "
3782     END IF
3784     RETURN
3786     !
3788     ! ////////////////////////////////////////////////////////////////////
3790     !
3792 Change_tuner: !
3794     IF Test_type#="OTHER (NO STEPS)" THEN GOTO Print_tuner
3796     SELECT Total_steps
3798     CASE 3200
3800         Total_steps=100
3802     CASE 1600
3804         Total_steps=3200
3806     CASE 800
3808         Total_steps=1600
3810     CASE 400
3812         Total_steps=800
3814     CASE 200
3816         Total_steps=400

```

```

3818         CASE 100
3820             Total_steps=200
3822         CASE ELSE
3824             Total_steps=400
3826         END SELECT
3828 Print_tuner: !
3830         PRINT TABXY(35,15);
3832         IF Test_type#<>"OTHER (NO STEPS)" THEN
3834             PRINT USING "4D";Total_steps
3836         ELSE
3838             PRINT USING "4A";"N/A "
3840         END IF
3842         IF Begin_step>Total_steps THEN
3844             Begin_step=Total_steps
3846             GOSUB Print_beginstp
3848         END IF
3850         RETURN
3852         !
3854         ! ////////////////////////////////////////////////////////////////////
3856         !
3858 Change_eutid: Interrupted=1
3860         DISP ". ENTER the TEST ID# (LEGAL FILE NAME) ";
3862         OUTPUT 2 USING "K,#";Run_id#
3864         LINPUT Test#
3866         IF LEN(Test#)=0 THEN Change_eutid
3868         IF LEN(Test#)>10 THEN
3870             BEEP
3872             DISP " ERROR in NAME ENTRY--100 MANY CHARACTERS, TRY AGAIN. "
3874             WAIT 1.8
3876             OUTPUT 2 USING "K,#";Filename#
3878             GOTO Change_eutid
3880         END IF
3882         FOR I=1 TO LEN(Test#)
3884             Ascii_num=NUM(Test#[I])
3886             SELECT Ascii_num
3888             CASE 65 TO 90,95,97 TO 122,48 TO 57
3890                 !Allowed characters
3892             CASE ELSE
3894                 BEEP
3896                 DISP "ERROR in NAME ENTRY--ILLEGAL CHARACTERS, TRY AGAIN."
3898                 WAIT 1.8
3900                 GOTO Change_eutid
3902             END SELECT
3904         NEXT I
3906         Run_id#=Test#
3908         !
3910         DISP " DESCRIPTION of the EUT and PURPOSE for test?? (<2 lines) ";
3912         OUTPUT 2 USING "K,#";Measmt_id#
3914         LINPUT Measmt_id#
3916 Print_eutid: !
3918         PRINT TABXY(12,3);RPT#(" ",10)
3920         PRINT TABXY(12,3);Run_id#
3922         PRINT CHR$(132);
3924         PRINT TABXY(1,5);RPT#(" ",160)
3926         PRINT TABXY(1,5);Measmt_id#
3928         PRINT CHR$(128);
3930         RETURN
3932         !
3934         ! ////////////////////////////////////////////////////////////////////
3936         !

```

```

3938 Enter_freq_er: !
3940     DISP " ERROR in numeric entry or ILLEGAL value. "
3942     BEEP
3944     WAIT 1.8
3946 Change_freqs:Interrupted=1
3948     DISP " ENTER Start, Stop, Step frequencies (MHz). ";
3950     DISP "[Ranges: 1-30, 30-2000, 2000-18000]";
3952     INPUT Test#
3954     ON ERROR GOTO Enter_freq_er
3956     Fstart=VAL(Test#)
3958     Fstop=VAL(Test#[POS(Test#,",")+1])
3960     Test#=Test#[POS(Test#,",")+1,LEN(Test#)]
3962     Fstep=VAL(Test#[POS(Test#,",")+1])
3964     OFF ERROR
3966     IF Fstop<Fstart THEN GOTO Enter_freq_er
3968     Fstart=MAX(MIN(Fstart,18000),1)
3970     Fstop=MAX(MIN(Fstop,18000),1)
3972     Fstep=MAX(MIN(Fstep,18000),.01)
3974     SELECT Fstart+(Fstop-Fstart)/2    !Mid point in the range of freq.
3976     CASE <=30    ! Set limits to 1-30 range
3978         IF Fstop>30 THEN Fstop=30
3980         Generator_id#="HF_8660A"
3982         Coupler_id#="CH_130_4"
3984     CASE <=2000    ! Set limits to 30-2000 range
3986         IF Fstart<30 THEN Fstart=30
3988         IF Fstop>2000 THEN Fstop=2000
3990         Coupler_id#="HF_778D"
3992         Generator_id#="HF_8660A"
3994     CASE >=2000    ! Set limits to 2000-18000 range
3996         IF Fstart<2000 THEN Fstart=2000
3998         Coupler_id#="HF_11692D"
4000         Generator_id#="HF_8672A"
4002     END SELECT
4004 Print_freqs:!
4006     PRINT TABXY(9,9);
4008     PRINT USING "5D.2D";Fstart
4010     PRINT TABXY(9,10);
4012     PRINT USING "5D.2D";Fstop
4014     PRINT TABXY(9,11);
4016     PRINT USING "5D.2D";Fstep
4018 Print_gen_id:!
4020     PRINT TABXY(59,15);RPT#(" ",21);
4022     IF Test_type#="MODE TUNE EMISSIONS" THEN
4024         PRINT TABXY(59,15);"Not used"
4026     ELSE
4028         PRINT TABXY(59,15);Coupler_id#;"/";Generator_id#
4030     END IF
4032     RETURN
4034     !
4036     ! ////////////////////////////////////////////////////////////////////
4038     !
4040 Change_levels:Interrupted=1
4042     IF Test_type#="MODE TUNE EMISSIONS" THEN RETURN
4044     IF Search_eut OR Search_pwr THEN
4046         DISP " ENTER the LOW, HIGH, STEP Signal generator LEVEL (dBm) ";
4048         DISP " ...integers only! ";
4050         INPUT Low_dbm,High_dbm,Step_dbm
4052         IF Low_dbm>High_dbm THEN Low_dbm=High_dbm    ! capped by high_dbm
4054         IF Step_dbm<1 THEN Step_dbm=1
4056     ELSE

```

```

4058         DISP " ENTER Signal generator LEVEL (dBm) ";
4060         DISP " ...integers only! ";
4062         INPUT Low_dbm
4064         IF High_dbm<Low_dbm THEN High_dbm=Low_dbm ! capped by low_dbm
4066     END IF
4068 Print_gen_level:
4070     PRINT CHR$(129);
4072     SELECT Test_type#
4074     CASE "MODE TUNE REGULAR","OTHER (NO STEPS)"
4076         IF Search_eut OR Search_pwr THEN
4078             PRINT TABXY(21,9);"  LOW: "
4080             PRINT TABXY(21,10);"  HIGH: "
4082             PRINT TABXY(21,11);"  STEP: "
4084         ELSE
4086             PRINT TABXY(21,9);"  FIXED: "
4088             PRINT TABXY(21,10);"  "
4090             PRINT TABXY(21,11);"  "
4092         END IF
4094     CASE "MODE TUNE EMISSIONS"
4096         PRINT TABXY(21,9);"  NOT  "
4098         PRINT TABXY(21,10);"  USED "
4100         PRINT TABXY(21,11);"  .... "
4102     CASE ELSE
4104         PRINT TABXY(21,9);"  ERROR "
4106         PRINT TABXY(21,10);"  DETECTED"
4108         PRINT TABXY(21,11);"  IN TYPE!"
4110     END SELECT
4112     PRINT CHR$(128);
4114     PRINT TABXY(30,9);
4116     PRINT USING "4A";"  "
4118     PRINT TABXY(30,10);
4120     PRINT USING "4A";"  "
4122     PRINT TABXY(30,11);
4124     PRINT USING "4A";"  "
4126     IF Test_type#<>"MODE TUNE EMISSIONS" THEN
4128         PRINT TABXY(30,9);
4130         PRINT USING "4D";Low_dbm
4132         IF Search_eut OR Search_pwr THEN
4134             PRINT TABXY(30,10);
4136             PRINT USING "4D";High_dbm
4138             PRINT TABXY(30,11);
4140             PRINT USING "4D";Step_dbm
4142         END IF
4144     END IF
4146     RETURN
4148     !
4150     ! ////////////////////////////////////////////////////////////////////////////////////////////////////////////////////////////////////
4152     !
4154 Change_response:Interrupted=1
4156     DISP " ENTER time for EUT to respond after field is set. (seconds) ";
4158     INPUT Time_eut
4160 Print_wait:
4162     PRINT TABXY(30,13);
4164     IF Time_eut<9999 THEN
4166         PRINT USING "X,5D.3D";Time_eut
4168     ELSE
4170         PRINT USING "MD.3DE";Time_eut
4172     END IF
4174     RETURN
4176     !

```

```

4178      ! //////////////////////////////////////
4180      !
4182 Enter_name: Interrupted=1
4184      DISP " PLEASE TYPE IN YOUR NAME ";
4186      LINFUT Test$
4188      Operator_name$=Test$[1,28]
4190 Print_name: !
4192      PRINT TABXY(13,17);RPT$(" ",28);
4194      PRINT TABXY(13,17);Operator_name$
4196      RETURN
4198      !
4200      ! //////////////////////////////////////
4202      !
4204 Change_diskdriv: !
4206      OFF KEY
4208      Interrupted=1
4210      DISP " SELECT DISK DRIVE for DATA OUTPUT. "
4212      ON KEY 0 LABEL "LEFT Internal",Local_prty+1 GOTO Left_internal
4214      ON KEY 2 LABEL "9133 HARD DISK",Local_prty+1 GOTO Hard9133
4216      ON KEY 4 LABEL "RIGHT Internal",Local_prty+1 GOTO Right_internal
4218      ON KEY 7 LABEL "9133 floppy",Local_prty+1 GOTO Floppy9133
4220      LOOP
4222      END LOOP
4224 Left_internal: Outdisk$=":INTERNAL,4,1"
4226      GOTO Disk_selected
4228 Right_internal: Outdisk$=":INTERNAL,4,0"
4230      GOTO Disk_selected
4232 Hard9133: Outdisk$=":HP9133,700,0"
4234      GOTO Disk_selected
4236 Floppy9133: Outdisk$=":HP9133,702,0"
4238 Disk_selected: OFF KEY
4240 Print_diskdrive: !
4242      PRINT TABXY(62,17);Outdisk$
4244      RETURN
4246      !
4248      ! //////////////////////////////////////
4250      !
4252 SUBEND
4254      !
4256      ! *****
4258      !

```

```

100! RE-STORE "MODE STIR"
102 ! Original: 22 May 1984, G. Koepke, NBS (303) 497-5766
104 ! Revision: 02 Oct 1985
106 ! .....
108 ! The program is currently configured as follows:
110 !     1) Read diode detector on DVM 1 [722] (Horn antenna)
112 !         Calibrate this reading via diode calibration
114 !         and normalize to 10 mW/cm^2 referenced to the
116 !         energy calculated via reference antenna as read
118 !         on the spectrum analyzer.
120 !
122 !     2) Read 1cm dipole output on DVM 2 [723] and DVM 3 [724]
124 !         This is the EUT for the measurement.
126 !         Calibrate via calibration curve and
128 !         normalize to 37 dB V/m as calculated from
130 !         reference received power.
132 !
134 !     3) In the event of failure to complete revolution
136 !         the program will modify sample count to compensate.
138 !
140 !     4) Parameters set for NBS chamber.
142 !
144 !     5) Save data is disabled, needs to be updated for GRAPH_DATA
146 !
148 ! .....
150 !
152 ! ===== CHECK ALL CABLES AND PAD PLACEMENTS =====
154 !
156 ! This measurement routine will operate the REVERBERATION CHAMBER
158 ! using MODE STIRED techniques. The tuner is stepped continuously
160 ! and measurements are performed asynchronously. In this version each
162 ! frequency is measured completely before proceeding
164 ! to the next frequency.
166 ! Coupler, cable loss, and Power meter head corrections are applied
168 ! immediately to the measured data.
170 ! The statistical results are saved for graphing.
172 !
174 !
176 OPTION BASE 1
178 DEG
180 PRINTER IS 1
182 OUTPUT 2 USING "K,#";"SCRATCH KEYX"
184 DISP CHR$(129)
186 !
188 GOSUB Die_gracefully      !For a clean slate.
190 GOSUB Dim_variables
192 GOSUB Initial_values
194 GOSUB Fillcalibration
196 GOSUB Do_measurements
198 GOSUB Die_gracefully
200 DISP "PROGRAM FINISHED"
202 STOP
204 !
206 !////////////////////**DIMENSION VARIABLES**////////////////////
208 !
210 Dim_variables: !
212 COM /Parameters/ Startf,Stopf,Stepf,Slow_down,Coupler_id#[10]
214 COM /Parameters/ Generator_id#[10],Dvm_integrat#[3]
216 COM /Parameters/ INTEGER Low_dbm,High_dbm,Step_dbm,Dvm_samples
218 COM /Parameters/ Upperlimit,Threshold,Rev_time

```

```

220 COM /Motor_menu/ Motion_type#[10],INTEGER Jog_wait
222 COM /Bug/ INTEGER Bug1,Bug2,Bug3,Printer
224 COM /Interrupts/ INTEGER Intr_prty
226 COM /Files/ Sourcedisk#[20],Outdisk#[20],Filename#[90]
228 !
230 DIM Coup_inc(100,2),Coup_ref1(100,2),Baddata_id#[10][80]
232 DIM Cable6a(180,2),Cable6b(180,2),Cable4(180,2),Cable10ft(180,2)
234 DIM Pad_as6a(180,2),Pad_s6770(180,2),Pad_f5530(180,2)
236 DIM Nswc(180,2) !NSWC CABLE DATA
238 !
240 DIM Cal_id#[180],Ab#[2],Pwr_id#[12],Test#[40]
242 !
244 INTEGER Baddata,Dbm,Rf_on_off
246 INTEGER Failflag
248 INTEGER Valid,Totalfreqs,Totalcurves,Ser_poll
250 INTEGER Printflag,Read1flag,Read2flag,Movingflag,Pad10db
252 !
254 INTEGER Nswc_pts
256 INTEGER Inc_pts,Ref1_pts,C6a_pts
258 INTEGER C6b_pts,C4_pts,C10_pts,Pada_pts,Pad_pts,Padf_pts
260 INTEGER Fcount,Too_hot,Printflag2
262 INTEGER Local_prty,P_sams,P,Dvm1_sams,Dvm2_sams
264 !
266 RETURN
268 !
270 !//////////****INITIALIZE VARIABLES & I/O****//////////
272 !
274 Initial_values: !
276 !
278 ASSIGN @Motor TO 706
280 ASSIGN @Pwr1 TO 709
282 ASSIGN @Pwr2 TO 710
284 ASSIGN @Dual_pwr1 TO 711
286 ASSIGN @Spectrum TO 718
288 ASSIGN @Dvm1 TO 722
290 ASSIGN @Dvm2 TO 723
292 ASSIGN @Dvm3 TO 724
294 ASSIGN @Sig_gen TO 719
296 !
298 Intr_prty=6
300 Local_prty=Intr_prty
302 Printer=701
304 Sourcedisk#=":INTERNAL,4,0"
306 Outdisk#=":INTERNAL,4,1"
308 !
310 Printflag=0
312 Bug1=0
314 Bug2=0
316 Bug3=0
318 !
320 Motion_type#="CONTINUOUS" !or "STEP" for MODE TUNED.
322 !
324 Rf_on_off=1 ! 1=on, 0=off
326 !
328 CALL Measure_menu !Go and set up the measurement parameters.
330 Dvm1_sams=Dvm_samples
332 Dvm2_sams=Dvm_samples
334 CALL Menu_pwr436a !Set up all power meters
336 GOSUB Die_gracefully !For a clean slate.
338 !

```

```

340 !-----ALLOCATE THE RAW DATA MATRIX-----
342 Totalfreqs=INT((Stopf-Startf)/Stepf)+1
344 Totalcurves=6
346 ALLOCATE Savedata(Totalfreqs,Totalcurves+1)
348 ALLOCATE Adjust(Totalfreqs,10)
350 !-----
352 !
354 PRINTER IS CRT
356 PRINT TABXY(1,18);RPT#(" ",20);" LOAD SUB PROGRAMS ";RPT#(" ",20)
358 Filename#=#Generator_id#&#Sourcedisk#
360 DISP "Insert 'SUB Program/Support DATA' disk in ";
362 SELECT Sourcedisk#
364 CASE ":INTERNAL,4,0"
366     DISP "RIGHT DRIVE, ";
368 CASE ":INTERNAL,4,1"
370     DISP "LEFT DRIVE, ";
372 END SELECT
374 DISP "and hit 'CONTINUE'."
376 BEEP
378 ON KEY 5 LABEL "CONTINUE",Local_prty GOTO Subloads
380 Zippy:GOTO Zippy
382 Subloads:OFF KEY
384 DISP CHR$(12)
386 DISP " Signal Generator SUB PROGRAMS NOW LOADING "
388 ON ERROR CALL Errortrap
390 LOADSUB ALL FROM Filename#
392 OFF ERROR
394 DISP " Signal Generator SUB PROGRAMS LOADED "
396 WAIT 1
398 !
400 PRINT TABXY(1,18);RPT#(" ",20);" LOAD CALIBRATION DATA ";RPT#(" ",20)
402 DISP " Calibration DATA for Cables, Couplers, Pads, etc. now LOADING "
404 !
406 Install_cal_fl:!. .... Install new calibration files here. ....!
408 !
410 IF Printflag THEN PRINTER IS Printer
412 IF Printflag THEN PRINT "CALIBRATION DATA FOR THE FOLLOWING IS LOADED:"
414 SELECT Coupler_id#
416 CASE "HP_778D"
418     Filename#="HP_778D_f"&#Sourcedisk#
420     Enter_caldata(Filename#,Coup_inc(*),Cal_id#,Inc_pts)
422     Baddata_id#(1)=Cal_id#
424     IF Printflag THEN PRINT Cal_id#
426     Filename#="HP_778D_r"&#Sourcedisk#
428     Enter_caldata(Filename#,Coup_refl(*),Cal_id#,Refl_pts)
430     Baddata_id#(2)=Cal_id#
432     IF Printflag THEN PRINT Cal_id#
434 CASE "HP_11692D"
436     Filename#="HP11692D_f"&#Sourcedisk#
438     Enter_caldata(Filename#,Coup_inc(*),Cal_id#,Inc_pts)
440     Baddata_id#(1)=Cal_id#
442     IF Printflag THEN PRINT Cal_id#
444     Filename#="HP11692D_r"&#Sourcedisk#
446     Enter_caldata(Filename#,Coup_refl(*),Cal_id#,Refl_pts)
448     Baddata_id#(2)=Cal_id#
450     IF Printflag THEN PRINT Cal_id#
452 CASE ELSE
454     PRINT "COUPLER CALIBRATION DATA ERROR. ....NOT DEFINED."
456     BEEP
458     PAUSE

```

```

460 END SELECT
462 !
464 !-----
466 !
468 Filename#="Cable6FT_1"&Sourcedisk#
470 Enter_caldata(Filename#,Cable6a(*),Cal_id#,C6a_pts)
472 Baddata_id#(3)=Cal_id#
474 IF Printflag THEN PRINT Cal_id#
476 !
478 Filename#="Cable6FT_6"&Sourcedisk#
480 Enter_caldata(Filename#,Cable6b(*),Cal_id#,C6b_pts)
482 Baddata_id#(4)=Cal_id#
484 IF Printflag THEN PRINT Cal_id#
486 !
488 Filename#="Cable4FT_2"&Sourcedisk#
490 Enter_caldata(Filename#,Cable4(*),Cal_id#,C4_pts)
492 Baddata_id#(5)=Cal_id#
494 IF Printflag THEN PRINT Cal_id#
496 !
498 Filename#="Cable10F_5"&Sourcedisk#
500 Enter_caldata(Filename#,Cable10ft(*),Cal_id#,C10_pts)
502 Baddata_id#(6)=Cal_id#
504 IF Printflag THEN PRINT Cal_id#
506 !
508 Filename#="PAD_S6770"&Sourcedisk#
510 Enter_caldata(Filename#,Pad_s6770(*),Cal_id#,Pad_pts)
512 Baddata_id#(7)=Cal_id#
514 IF Printflag THEN PRINT Cal_id#
516 !
518 Filename#="PAD_5530"&Sourcedisk#
520 Enter_caldata(Filename#,Pad_f5530(*),Cal_id#,Padf_pts)
522 Baddata_id#(8)=Cal_id#
524 IF Printflag THEN PRINT Cal_id#
526 !
528 Filename#="PdAS6A1466"&Sourcedisk#
530 Enter_caldata(Filename#,Pad_as6a(*),Cal_id#,Pada_pts)
532 Baddata_id#(9)=Cal_id#
534 IF Printflag THEN PRINT Cal_id#
536 !
538 Filename#="PdAS6A1466"
540 Filename#=Filename#&Sourcedisk#
542 Enter_caldata(Filename#,Nswc(*),Cal_id#,Nswc_pts)
544 Baddata_id#(10)=Cal_id#
546 IF Printflag THEN PRINT Cal_id#
548 DISP " Calibration DATA LOADED "
550 WAIT 1
552 PRINTER IS CRT
554 CALL Wipe_clean
556 !
558 !-----
560 !
562 DISP "INSERT OUTPUT DATA DISK IN ";
564 SELECT Outdisk#
566 CASE ":INTERNAL,4,0"
568     DISP "RIGHT DRIVE, ";
570 CASE ":INTERNAL,4,1"
572     DISP "LEFT DRIVE, ";
574 END SELECT
576 DISP "and hit 'CONTINUE'."
578 BEEP

```

```

580     ON KEY 5 LABEL "CONTINUE",Local_prty GOTO Datasaver
582 Zippity:G010 Zippity
584 Datasaver:OFF KEY
586     DISP CHR$(12)
588     !
590     RETURN
592     !
594     !//////////////////////***DIE GRACEFULLY***//////////////////////
596     !
598 Die_gracefully:    !
600     IF Bug1 THEN
602         PRINT TIME$(TIMEDATE);
604         PRINT RPT$("<",15);" DIE GRACEFULLY ";RPT$(">",15)
606     END IF
608     ON ERROR GOTO Delet_done1
610     SELECT Generator_id#
612     CASE "HP_8660A"
614         DELSUB Set_freq,Set_dbm,FNDigit10#,FNDigit3#,FNRev#
616     CASE "HP_8672A"
618         DELSUB Set_freq,Set_dbm
620     END SELECT
622 Delet_done1:    !
624     OFF ERROR
626     ON ERROR GOTO Delet_done2
628     DEALLOCATE Savedata(*),Adjust(*)
630 Delet_done2:    !
632     OFF ERROR
634     RETURN
636     !
638     !//////////////////////
640     !
642 Filcalibration:    !Determine the cable, coupler and pad calibration
644                     !values for each frequency.
646                     !Save these in the adjust(*) file for use by the
648                     !measurement routine.
650                     !
652     IF Bug1 THEN
654         PRINT TIME$(TIMEDATE);
656         PRINT RPT$("<",15);" FILL CALIBRATION MATRIX ";RPT$(">",15)
658     END IF
660     Fcount=1
662     FOR Frequency=Startf TO Stopf STEP Stepf
664         Get_cal_value(Frequency,Coupinc,Coup_inc(*),Baddata,Inc_pts)
666         IF Baddata THEN
668             Cal_id#=Baddata_id$(1)
670             GOSUB Flagbaddata
672         END IF
674         Adjust(Fcount,1)=Coupinc
676         !
678         Get_cal_value(Frequency,Couprefl,Coup_refl(*),Baddata,Ref1_pts)
680         IF Baddata THEN
682             Cal_id#=Baddata_id$(2)
684             GOSUB Flagbaddata
686         END IF
688         Adjust(Fcount,2)=Couprefl
690         !
692         Get_cal_value(Frequency,C6a_loss,Cable6a(*),Baddata,C6a_pts)
694         IF Baddata THEN
696             Cal_id#=Baddata_id$(3)
698             GOSUB Flagbaddata

```

```

700     END IF
702     Adjust (Fcount,3)=C6a_loss
704     !
706     Get_cal_value (Frequency,C6b_loss,Cable6b (*),Baddata,C6b_pts)
708     IF Baddata THEN
710         Cal_id#=Baddata_id$(4)
712         GOSUB Flagbaddata
714     END IF
716     Adjust (Fcount,4)=C6b_loss
718     !
720     Get_cal_value (Frequency,C4_loss,Cable4 (*),Baddata,C4_pts)
722     IF Baddata THEN
724         Cal_id#=Baddata_id$(5)
726         GOSUB Flagbaddata
728     END IF
730     Adjust (Fcount,5)=C4_loss
732     !
734     Get_cal_value (Frequency,C10_loss,Cable10ft (*),Baddata,C10_pts)
736     IF Baddata THEN
738         Cal_id#=Baddata_id$(6)
740         GOSUB Flagbaddata
742     END IF
744     Adjust (Fcount,6)=C10_loss
746     !
748     Get_cal_value (Frequency,Pad_loss,Pad_s6770 (*),Baddata,Pad_pts)
750     IF Baddata THEN
752         Cal_id#=Baddata_id$(7)
754         GOSUB Flagbaddata
756     END IF
758     Adjust (Fcount,7)=Pad_loss
760     !
762     Get_cal_value (Frequency,Padf_loss,Pad_f5530 (*),Baddata,Padf_pts)
764     IF Baddata THEN
766         Cal_id#=Baddata_id$(8)
768         GOSUB Flagbaddata
770     END IF
772     Adjust (Fcount,8)=Padf_loss
774     !
776     Get_cal_value (Frequency,Pada_loss,Pad_as6a (*),Baddata,Pada_pts)
778     IF Baddata THEN
780         Cal_id#=Baddata_id$(9)
782         GOSUB Flagbaddata
784     END IF
786     Adjust (Fcount,9)=Pada_loss
788     !
790     Get_cal_value (Frequency,Nswc_loss,Nswc (*),Baddata,Nswc_pts)
792     IF Baddata THEN
794         Cal_id#=Baddata_id$(10)
796         GOSUB Flagbaddata
798     END IF
800     Adjust (Fcount,10)=Nswc_loss
802     !
804     Fcount=Fcount+1
806     NEXT Frequency
808     GOSUB Printcalvalues
810     RETURN
812     !
814     ! //////////////////////////////////////////////////***FLAG BAD DATA***//////////////////////////////////////
816     !
818     Flagbaddata:           !Inform the operator that there is wrong data

```

```

820             !being brought back from Enter_cal_data
822             !
824     PRINTER IS CRT
826     PRINT TABXY(1,18);
828     PRINT RPT$("*",10);" CALIBRATION DATA out of range for ";Frequency;
830     PRINT " MHz ";RPT$("*",10)
832     DISP Cal_id$
834     BEEP
836     PAUSE
838     PRINT TABXY(1,18);
840     PRINT RPT$("*",10);" CALIBRATION VALUE OF 0 dB WILL BE USED ";
842     PRINT RPT$("*",10)
844     WAIT 3
846     PRINT TABXY(1,18);RPT$(" ",80)
848     DISP CHR$(12)
850     RETURN
852     !
854     ! ////////////////////////////////////////////////////////////////////////////////////////////////////////////////////////////////////
856     !
858 Printcalvalues:      !MAKE LIST OF CALIBRATION VALUES USED.
860             !
862     PRINTER IS Printer
864     PRINT
866     PRINT RPT$("*",24);" CALIBRATION / LOSS VALUES (dB) ";RPT$("*",24)
868     PRINT
870     PRINT "Frequency  Coupler  ----- BLUE CABLES -----";
872     PRINT " S6770  F5530  ASA6A TEST"
874     PRINT "   MHz      Inc  Ref1   6ft#1 6ft#6   4ft  10ft";
876     PRINT "   pad      pad  pad   Cbl"
878 Lossfmt1: IMAGE M5D.D,X,4(MDD.DD),#
880 Lossfmt2: IMAGE 3(MDD.DD),2(MDD.DD,X),#
882 Lossfmt3: IMAGE MDD.DD
884     Fcount=1
886     FOR Frequency=Startf TO Stopf STEP Stepf
888         Coupinc=10*LGT(Adjust(Fcount,1))           !Coupler incident
890         Couprefl=10*LGT(Adjust(Fcount,2))          !Coupler reflected
892         C6a_loss=10*LGT(Adjust(Fcount,3))          !6 foot BLUE cable #1
894         C6b_loss=10*LGT(Adjust(Fcount,4))          !6 foot BLUE cable #6
896         C4_loss=10*LGT(Adjust(Fcount,5))           !4 foot BLUE cables
898         C10_loss=10*LGT(Adjust(Fcount,6))           !10 foot BLUE cables
900         Pad_loss=10*LGT(Adjust(Fcount,7))           !Weinschel S6770 10dB pad
902         Padf_loss=10*LGT(Adjust(Fcount,8))          !Weinschel F5530 10dB pad
904         Pada_loss=10*LGT(Adjust(Fcount,9))          !Weinschel AS6A-1466 10dB
906         Nswc_loss=10*LGT(Adjust(Fcount,10))         !NSWC input cable
908         PRINT USING Lossfmt1;Frequency,Coupinc,Couprefl,C6a_loss,C6b_loss
910         PRINT USING Lossfmt2;C4_loss,C10_loss,Pad_loss,Padf_loss,Pada_loss
912         PRINT USING Lossfmt3;Nswc_loss
914         Fcount=Fcount+1
916     NEXT Frequency
918     PRINT
920     PRINT RPT$("*",80)
922     PRINT USING "4/"
924     PRINTER IS CRT
926     RETURN
928     !
930     !
932     ! ////////////////////////////////////////////////////////////////////////////////////////////////////////////////////////////////////
934     !
936 Do_measurements:      !
938     !

```

```

940 PRINTER IS 1
942 Fcount=1
944 Dbm=Low_dbm !Initialize the Generator Level
946 Frequency=Startf !Initialize first frequency.
948 ! BEEP
950 ! INPUT "ENTER THE RANGE SET ON THE 1 cm DIPOLE AMPLIFIER",F1cm_scale
952 ! DISP CHR$(12)
954 F1cm_scale=.1
956 Initializemotor (@Motor)
958 Zeromotor (@Motor)
960 !
962 REPEAT
964 !
966 !Initial values and zeroing
968 !
970 !Calibration data for all cables, probes, & power heads.
972 !
974 Fwrmtrcal1=FNFWrmtrcal1((Frequency)) !18 GHz HEAD.
976 Fwrmtrcal2=FNFWrmtrcal2((Frequency)) !26 GHz HEAD.
978 !
980 Coupinc=Adjust (Fcount,1) !Coupler incident
982 Couprefl=Adjust (Fcount,2) !Coupler reflected
984 C6a_loss=Adjust (Fcount,3) !6 foot BLUE cable #1
986 C6b_loss=Adjust (Fcount,4) !6 foot BLUE cable #6 rcvr.
988 C4_loss=Adjust (Fcount,5) !4 foot BLUE cable
990 C10_loss=Adjust (Fcount,6) !10 foot BLUE cable
992 Pad_loss=Adjust (Fcount,7) !Weinschel S6770 10dB pad
994 Padf_loss=Adjust (Fcount,8) !Weinschel F5530 10dB pad
996 Pada_loss=Adjust (Fcount,9) !Weinschel AS6A-1466 10dB
998 Nswc_loss=Adjust (Fcount,10) !NSWC input cable
1000 !
1002 Dvm1_sams=Dvm_samples !The measurement will be attempted at
1004 Dvm2_sams=Dvm_samples !the predicted number of samples first.
1006 !These will be adjusted if failure occurs.
1008 Failflag=0
1010 !
1012 Restart: !Any failure on this measurement causes branch to here.
1014 Set_dbm(-140,Rf_on_off,@Sig_gen)
1016 Set_freq(Frequency,@Sig_gen)
1018 Initializemotor (@Motor)
1020 !
1022 DISP CHR$(12)
1024 !
1026 Setdcv3456a (@Dvm1)
1028 Readdvm (Eut_zero,@Dvm1)
1030 Setdcv3456a (@Dvm2)
1032 Readdvm (F1cm_zero,@Dvm2)
1034 !
1036 Setdvm_3456a (@Dvm1,Dvm_integrat#,Dvm1_sams)
1038 Setdvm_3456a (@Dvm2,Dvm_integrat#,Dvm2_sams)
1040 Setdvm_3478a (@Dvm3)
1042 Spec_alzr_setup (@Spectrum)
1044 !
1046 !Zero_pwr_mtrs (@Pwr1,@Fwr2)
1048 !
1050 Ab#="AB"
1052 CALL Zero_438a (@Dual_pwr1,Ab#)
1054 !
1056 IF NOT Failflag THEN
1058 Dbm=Low_dbm

```

```

1060      Movemotor (@Motor)
1062      PRINT CHR$(12)
1064      PRINT TABXY (1,3);TIME$(TIMEDATE);"*****";
1066      PRINT " FREQUENCY ";Frequency;" MHz. *****"
1068      PRINT TABXY(1,5);"FINDING THRESHOLD VALUE dBm="
1070      PRINT TABXY(36,5);" Average EUT RESPONSE= "
1072      LOOP
1074          Set_dbm(Dbm,Rf_on_off,@Sig_gen)
1076          Vave=0.
1078          FOR Sams=1 TO 30
1080              Readdvm_3478a(@Dvm3,V)
1082              V=V-F1cm_zero
1084              Vave=Vave+V
1086          NEXT Sams
1088          Vave=Vave/40
1090          PRINT TABXY(30,5);
1092          PRINT USING "5D";Dbm
1094          PRINT TABXY(60,5);
1096          PRINT USING "3D.8D";Vave
1098          EXIT IF Vave>=Threshold OR Dbm>=High_dbm
1100          Dbm=Dbm+Step_dbm
1102      END LOOP
1104      Stop_motor (@Motor)
1106  ELSE
1108      Set_dbm(Dbm,Rf_on_off,@Sig_gen)
1110  END IF
1112  Failflag=1
1114  !
1116  ! Trigger measurement .....
1118  !
1120  DISP CHR$(12)
1122  Restart_point2:
1124  Ab$="AB"
1126  CALL Read_dual_pwr (Ab$,Apower,Bpower,Too_hot,Valid,@Dual_pwr1)
1128  IF Too_hot THEN
1130      GOSUB Reduce_power
1132      GOTO Restart_point2
1134  END IF
1136  IF NOT Valid AND NOT Too_hot THEN GOSUB Dual_pwr_error
1138  IF Apower<0. THEN Apower=0.
1140  IF Bpower<0. THEN Bpower=0.
1142  Incpwr_raw=Apower
1144  Refpwr_raw=Bpower
1146  !
1148  !....Sequence for reading 436a Power meters.....
1150  !   Pwr_id$="P1"
1152  !   Read_pwr_meter (Power,Pwr_id$,Valid,@Pwr1,@Sig_gen)
1154  !   IF NOT Valid THEN
1156  !       DISP "ERROR IN 436a POWER METER 1"
1158  !       BEEP
1160  !       FAUSE
1162  !   END IF
1164  !.....
1166  Incpwr=Incpwr_raw
1168  Incpwr=Incpwr*Coupinc*Pwrmtcal1/(C6b_loss) !Inc power at ANT
1170  Refpwr=Refpwr_raw*Coupref1*Pwrmtcal1*C6b_loss !Ref1 pwr at ANT
1172  Netpower=(Incpwr-Refpwr)
1174  !
1176  PRINT TIME$(TIMEDATE);
1178  PRINT "**** START NEW MEASURMENT AT FREQUENCY = ";Frequency

```

```

1180     ON INTR 7 GOSUB Check_dvm_done
1182     ENABLE INTR 7;2
1184     Movemotor(@Motor)
1186     IF Bug1 THEN PRINT "DVM1 trigger ";TIME$(TIMEDATE);" ";
1188     Trig1_time=TIMEDATE
1190     Trigger_3456a(@Dvm1)
1192     IF Bug1 THEN PRINT "DVM2 trigger ";TIME$(TIMEDATE);" ";
1194     Trig2_time=TIMEDATE
1196     Trigger_3456a(@Dvm2)
1198     Spec_alzr_start(Frequency,@Spectrum)
1200     IF Bug1 THEN PRINT "TRIGGER ANALYZER ";TIME$(TIMEDATE)
1202     Read1flag=0
1204     Read2flag=0
1206     Vpeak=0
1208     LOOP
1210         Readdvm_3478a(@Dvm3,V)
1212         V=V-F1cm_zero
1214         IF V>=Upperlimit THEN
1216             Stop_motor(@Motor)
1218             REPEAT
1220                 Dbm=Dbm-Step_dbm
1222                 Set_dbm(Dbm,Rf_on_off,@Sig_gen)
1224                 WAIT Slow_down
1226                 Readdvm_3478a(@Dvm3,V)
1228                 V=V-F1cm_zero
1230                 BEEP
1232                 PRINT "EUT MAXIMUM EXCEEDED **** POWER DECREASED TO ";
1234                 PRINT Dbm;" dBm."
1236                 UNTIL V<Upperlimit
1238                 OFF INTR 7
1240                 GOTO Restart
1242             END IF
1244             Checkmotor(@Motor,Movingflag)
1246             IF NOT Movingflag THEN
1248                 PRINT "MOTOR NOT MOVING*****DATA BAD"
1250                 GOTO Restart
1252             END IF
1254             IF V>Vpeak THEN Vpeak=V
1256             Countdown=Rev_time-(TIMEDATE-Trig1_time)
1258 Spy:  IMAGE M4D.D," Seconds left, EUT mV=",M6D.2D," / ",M6D.2D," "
1260             DISP USING Spy;Countdown,V*1000,Vpeak*1000
1262     EXIT IF Read1flag AND Read2flag
1264     END LOOP
1266     !=====
1268     ! Make sure that the correct voltmeters are connected for this test!
1270     ! IF (Vpeak+Eut_zero)>High2 THEN High2=Vpeak+Eut_zero
1272     !=====
1274     OFF INTR 7
1276     Failflag=0
1278     !
1280     ! Insure successful (synchronized tuner and dvms) measurement.
1282     !
1284     IF (Read1_time<.98*Rev_time) OR (Read1_time>1.02*Rev_time) THEN
1286         Dvm1_sams=INT((Rev_time/Read1_time)*Dvm1_sams)
1288         PRINT "Dvm 1 NOT synchronized with TUNER REVOLUTION. ";
1290         PRINT "Changing samples to ";Dvm1_sams
1292         Failflag=1
1294     END IF
1296     IF (Read2_time<.98*Rev_time) OR (Read2_time>1.02*Rev_time) THEN
1298         Dvm2_sams=INT((Rev_time/Read2_time)*Dvm2_sams)

```

```

1300         PRINT "Dvm 2 NOT synchronized with TUNER REVOLUTION. ";
1302         PRINT "Changing samples to ";Dvm2_sams
1304         Failflag=1
1306     END IF
1308     IF Failflag THEN
1310         Stop_motor(@Motor)
1312         GO10 Restart
1314     END IF
1316     Spec_alzr_read(Power,Frequency,@Spectrum)
1318     PRINT "SPECTRUM ANALYZER READS ";Power;" AT FREQUENCY ";Frequency
1320     Stop_motor(@Motor)
1322     Set_dbm(-140,Rf_on_off,@Sig_gen)
1324     !
1326     GOSUB Process_data
1328     GOSUB Print_alldata
1330     !
1332     Frequency=Frequency+Stepf
1334     Fcount=Fcount+1
1336 UNTIL Frequency>Stopf
1338     !
1340     Set_dbm(-140,0,@Sig_gen)
1342     ! GOSUB Save_data
1344     RETURN
1346     !
1348     ! ////////////////////////////////////////
1350     !
1352 Reduce_power: !
1354     Dbm=Dbm-1
1356     Set_dbm(Dbm,1,@Sig_gen)
1358     IF Printflag THEN
1360         PRINTER IS Printer
1362         PRINT TIME$(TIMEDATE);": Freq=";Frequency;
1364         PRINT RPT$("*",10);" NEW GENERATOR LEVEL =";Dbm
1366     END IF
1368     RETURN
1370     !
1372     ! ////////////////////////////////////////
1374     !
1376 Dual_pwr_error: !
1378     Set_dbm(-140,0,@Sig_gen)
1380     IF Printflag THEN
1382         PRINTER IS Printer
1384         PRINT TIME$(TIMEDATE);": Freq=";Frequency;
1386         PRINT RPT$("*",10);" ERROR IN DUAL POWER METER !!!"
1388     END IF
1390     STOP ! Program dies here!
1392     RETURN
1394     !
1396     ! ////////////////////////////////////////SERVICE DVM'S INTERUPT//////////////////////////////////////
1398     !
1400 Check_dvm_done: !
1402         !Respond to an INTERUPT on the HP1B generated by one of
1404         !two HP3456a DVMs. Meaning that the data is ready.
1406         !
1408     Ser_poll=SFOLL(@Dvm1)
1410     ENABLE INTR 7
1412     IF Ser_poll=66 THEN
1414         Read1_time=TIMEDATE-Trig1_time
1416         IF Bug1 THEN PRINT "DVM1 total sample time = ";Read1_time;" ";
1418         IF Bug1 THEN PRINT TIME$(TIMEDATE)

```

```

1420      !
1422      !.....
1424      !Since the output of the detector is negative, Low and High are
1426      !swapped.
1428      Readdvm_stat(@Dvm1,High1,Low1,Mean1,Var1,Sam1) !Low and High swapped!
1430      !.....
1432      !
1434      Low1=-1*Low1          !Crystal detector has negative output
1436      High1=-1*High1       ! " " " "
1438      Mean1=-1*Mean1       ! " " " "
1440      PRINT " DVM 1====",Low1,High1,Mean1,Var1,Sam1
1442      Read1flag=1
1444      END IF
1446      Ser_poll=SFOLL(@Dvm2)
1448      ENABLE INTR 7
1450      IF Ser_poll=66 THEN
1452          Read2_time=TIMEDATE-Trig2_time
1454          IF Bug1 THEN PRINT "DVM2 total sample time = ";Read2_time;" ";
1456          IF Bug1 THEN PRINT TIME$(TIMEDATE)
1458          Readdvm_stat(@Dvm2,Low2,High2,Mean2,Var2,Sam2)
1460          PRINT " DVM 2====",Low2,High2,Mean2,Var2,Sam2
1462          Read2flag=1
1464      END IF
1466      RETURN
1468      !
1470      !//////////*****PROCESS DATA*****//////////
1472      !
1474      Process_data:  !
1476      !
1478      !Calculations for power read from spectrum analyzer.
1480      !
1482      Power=(.001)*10^(Power/10.)          !Convert dBm to watts.
1484      Cor_power=Power*C10_loss*C6a_loss*Pada_loss
1486      !.....
1488      !ALSO EDIT PRINT STATEMENT IN LINE 1620
1490      !
1492      !Normalize to 10 mW/cm^2
1494      !
1496      Ref_pwr_den=(.4*PI*Frequency*Frequency*Cor_power)/9.0E+4
1498      Normal_pwr=SQR(10/Ref_pwr_den)
1500      !.....
1502      !Normalize to 37 dB V/m
1504      !
1506      Ref_e_field=(4*PI*Frequency/300)*SQR(Cor_power*30)
1508      Normal fld=((10.0^(37/20))/Ref_e_field))
1510      !.....
1512      !Calculations for CRYSTAL detector with 6 ft cable.
1514      !
1516      Cor_high1=(High1-Eut_zero)
1518      Cor_mean1=(Mean1-Eut_zero)
1520      IF Cor_high1<1.0E-50 THEN Cor_high1=1.0E-50
1522      IF Cor_mean1<1.0E-50 THEN Cor_mean1=1.0E-50
1524      !
1526      IF Cor_high1<=.1 THEN
1528          Cor_high1=.00304939*Cor_high1^(1.1195)!Convert to WATTS
1530      ELSE
1532          Cor_high1=.0135056*Cor_high1^(1.7488)!Convert to WATTS
1534      END IF
1536      !
1538      Cor_high1=Cor_high1*C10_loss

```

```

1540 Cor_high1=Cor_high1*Normal_pwr*Normal_pwr
1542 Cor_high1=10*LGT(Cor_high1/1.0E-3) !Convert to dBm
1544 !
1546 IF Cor_mean1=.1 THEN
1548 Cor_mean1=.00304939*Cor_mean1^(1.1195)!Convert to WATTS
1550 ELSE
1552 Cor_mean1=.0135056*Cor_mean1^(1.7488)!Convert to WATTS
1554 END IF
1556 !
1558 Cor_mean1=Cor_mean1*C10_loss
1560 Cor_mean1=Cor_mean1*Normal_pwr*Normal_pwr
1562 Cor_mean1=10*LGT(Cor_mean1/1.0E-3) !Convert to dBm
1564 !
1566 !Calculations for 1 cm DIPOLE with super amp.
1568 !
1570 Cor_high2=(High2-P1cm_zero)
1572 Return_field(Cor_high2,P1cm_fld_high)
1574 P1cm_fld_high=P1cm_fld_high*Normal_fld
1576 New_volts(P1cm_fld_high,Cor_high2)
1578 !
1580 Cor_mean2=(Mean2-P1cm_zero)
1582 Return_field(Cor_mean2,P1cm_fld_mean)
1584 P1cm_fld_mean=P1cm_fld_mean*Normal_fld
1586 New_volts(P1cm_fld_mean,Cor_mean2)
1588 !
1590 IF Cor_high2<1.0E-50 THEN Cor_high2=1.0E-50
1592 IF Cor_mean2<1.0E-50 THEN Cor_mean2=1.0E-50
1594 Cor_high2=20*LGT(Cor_high2*1000) !dB mV
1596 Cor_mean2=20*LGT(Cor_mean2*1000) !dB mV
1598 !
1600 Savedata(Fcount,1)=Frequency !MHz
1602 Savedata(Fcount,2)=Netpower !Watts
1604 Savedata(Fcount,3)=Ref_e_field !V/m
1606 Savedata(Fcount,4)=Cor_high1 !dBm
1608 Savedata(Fcount,5)=Cor_mean1 !dBm
1610 Savedata(Fcount,6)=Cor_high2 !dB mV
1612 Savedata(Fcount,7)=Cor_mean2 !dB mV
1614 !
1616 RETURN
1618 !
1620 !!!!!!!!!!!!!!!!!!!!!!!!!!!!!!!!!!!!!!!**PRINT RAW DATA**!!!!!!!!!!!!!!!!!!!!!!!!!!!!!!!!!!!!!!
1622 !
1624 Print_alldata:
1626 PRINTER IS Printer
1628 PRINT
1630 PRINT RPT#("-",80)
1632 PRINT "*****";
1634 PRINT USING "2X,6D.DD,6A,2X,#";Frequency;" MHz "
1636 PRINT "*****"
1638 PRINT RPT#("-",80)
1640 PRINT RPT#("_",80)
1642 PRINT "Measured RAW data:"
1644 PRINT
1646 PRINT " FWR IN MAX REC PWR HORN ZERO HORN PEAK";
1648 PRINT " HORN MEAN"
1650 PRINT " INC--Watts--REF Watts mV mV ";
1652 PRINT " mV"
1654 Spyraw1:IMAGE MD.4DE,X,MD.4DE,XX,MD.4DE,XX,6D.2D,3X,#
1656 Spyraw2:IMAGE 7D.2D,X,7D.2D
1658 PRINT USING Spyraw1;IncPwr_raw,RefPwr_raw,Power,Eut_zero*1000

```

```

1660 PRINT USING Spyraw2;High1*1000,Mean1*1000
1662 !
1664 PRINT
1666 PRINT "1cm PRB ZERO      1cm PRB PEAK      1cm PRB MEAN      Signal Gen Level"
1668 PRINT "      mV              mV              mV              dBm"
1670 Spyraw3:IMAGE 6D.2D,6X,7D.2D,6X,7D.2D,10X,5D
1672 PRINT USING Spyraw3;F1cm_zero*1000,High2*1000,Mean2*1000,Dbm
1674 PRINT
1676 PRINT RPT#("-",80)
1678 PRINT "PROCESSED DATA:"
1680 PRINT "HORN normalized to 10 mW/cm^2, 1cm DIFOLE normalized to 37";
1682 PRINT " dB V/m."
1684 PRINT
1686 PRINT "REC PWR CORR.      HORN PEAK      HORN MEAN      ";
1688 PRINT "1cm PRB PK      1cm PRB MEAN"
1690 PRINT "      Watts              dBm              dBm              ";
1692 PRINT "      dB mV              dB mV"
1694 Spyraw6:IMAGE MD.4DE,5X,M4D.2D,3X,#
1696 Spyraw7:IMAGE M6D.2D,2X,M4D.2D,4X,M4D.2D
1698 !
1700 PRINT USING Spyraw6;Cor_power,Cor_high1
1702 PRINT USING Spyraw7;Cor_mean1,Cor_high2,Cor_mean2
1704 PRINT TAB(41);RPT#("-",25)
1706 PRINT TAB(41);"Field V/m      Field V/m"
1708 PRINT USING "39X,M4D.2D,4X,M4D.2D";F1cm fld_high,F1cm fld_mean
1710 PRINT
1712 PRINT RPT#("-",65)
1714 PRINT "REC PWR CORR.      NET INPUT POWER      REF PWR DENSITY      REF FIELD"
1716 PRINT "      dBm              Watts              mW/cm^2              V/m"
1718 Spyraw8:IMAGE X,M4D.2D,10X,MD.4DE,6X,M2D.4D,5X,M4D.4D
1720 Power_dbm=10*LGT(1000*Cor_power)
1722 PRINT USING Spyraw8;Power_dbm,Netpower,Ref_pwr_den,Ref_e_field
1724 PRINT RPT#("-",80)
1726 PRINT RPT#("*",80)
1728 PRINT RPT#("-",80)
1730 PRINT
1732 PRINTER IS CRT
1734 RETURN
1736 !
1738 !//////////*****SAVE DATA*****//////////
1740 !
1742 Save_data: !
1744 RETURN
1746 DISP "ENTER FILE NAME FOR THIS DATA (<=10 CHR/NUMS ONLY) ";
1748 BEEP
1750 LINPUT Filename#
1752 IF LEN(Filename#)>10 THEN Save_data
1754 Filename#=Filename#&Outdisk#
1756 ON ERROR CALL Errortrap
1758 CREATE BDAT Filename#,(7*Totalfreqs+128),8
1760 ASSIGN @Datapath TO Filename#
1762 OUTPUT @Datapath;Totalcurves
1764 OUTPUT @Datapath;Totalfreqs
1766 OUTPUT @Datapath;Totalfreqs
1768 OUTPUT @Datapath;Savedata(*)
1770 ASSIGN @Datapath TO *
1772 !
1774 PRINTER IS Fprinter
1776 PRINT TIME$(TIMEDATE);".....DATA STORED ON FILE ";
1778 PRINT Filename#[1,POS(Filename#,";")-1];"....."

```

```

1780 PRINTER IS 1
1782 OFF ERROR
1784 RETURN
1786 !
1788 END
1790 !
1792 !*****
1794 !
1796 SUB Measure_menu
1798 !
1800 !This routine will facilitate setting up the
1802 !measurement.
1804 !
1806 COM /Parameters/ Startf,Stopf,Stepf,Slow_down,Coupler_id#[10]
1808 COM /Parameters/ Generator_id#[10],Dvm_integrat#[3]
1810 COM /Parameters/ INTEGER Low_dbm,High_dbm,Step_dbm,Dvm_samples
1812 COM /Parameters/ Upperlimit,Threshold,Rev_time
1814 COM /Motor_menu/ Motion_type#[10],INTEGER Jog_wait
1816 COM /Bugs/ INTEGER Bug1,Bug2,Bug3,Printer
1818 !
1820 DIM Eut_identity#[160],Operator_name#[60]
1822 !
1824 PRINTER IS 1
1826 Wipe_clean !Clear the CRT.
1828 !
1830 !Define the choices at start-up.
1832 !
1834 Operator_name#="Mike Crawford"
1836 !
1838 Startf=2000 !Frequency range in MHz.
1840 Stopf=4000
1842 Stepf=200
1844 !
1846 Low_dbm=-30 !Signal generator level in dBm.
1848 High_dbm=-10
1850 Step_dbm=1
1852 !
1854 Eut_identity#="Evaluate use of NSWC Reverberating Chamber "
1856 Eut_identity#="Eut_identity#&"for measuring response of EUT."
1858 !
1860 Threshold=50.0 !EUT LOWER THRESHOLD VOLTAGE. mV.
1862 Upperlimit=1200.0 !EUT FAILURE VOLTAGE. mV.
1864 !
1866 Slow_down=.02 !Time for EUT to respond after field is set.
1868 !
1870 Jog_wait=10 !Wait .10 seconds between each of 3200 jogs.
1872 !
1874 Coupler_id#="HP_11692D"
1876 Generator_id#="HP_8672A"
1878 !
1880 !Display the above parameters.
1882 !
1884 PRINT CHR$(129)
1886 PRINT TABXY(16,1);" MEASUREMENT PARAMETERS FOR MODE STIRRED TESTS. "
1898 PRINT TABXY(1,3);" TEST DESCRIPTION: "
1890 PRINT TABXY(1,7);" FREQUENCY RANGE "
1892 PRINT TABXY(30,7);"TO"
1894 PRINT TABXY(42,7);"STEP"
1896 PRINT TABXY(56,7);"MHz."
1898 PRINT TABXY(1,9);" SIG-GEN RANGE "

```



```

2020     Jog_wait=Jog_wait+1
2022 Print_tuner:  !
2024     Rev_time=38.37068*Jog_wait+4.92406
2026     !
2028     Dvm_samples=INT(1.15*(38.9729+23.60383*(Rev_time))) ! .1 cycle
2030     Dvm_integrat#=".1"
2032     !
2034     IF Dvm_samples>9999 THEN
2036         Dvm_samples=INT(1.15*(3.970658+12.8621757*(Rev_time)))! 1 cycle
2038         Dvm_integrat#="1"
2040     END IF
2042     IF Dvm_samples>9999 THEN
2044         Jog_wait=0
2046         GOTO Change_tuner
2048     END IF
2050     Hh=Rev_time DIV 3600
2052     Mm=(Rev_time-Hh*3600) DIV 60
2054     Ss=INT(Rev_time-Hh*3600) MOD 60
2056     PRINT TABXY(23,13);
2058     PRINT USING "DD,A,ZZ,A,ZZ";Hh,":",Mm,":",Ss
2060     PRINT TABXY(47,13);Dvm_samples
2062     PRINT TABXY(74,13);" "
2064     PRINT TABXY(74,13);Dvm_integrat#
2066     RETURN
2068     !
2070     !!!!!!!!!!!!!!!!!!!!!!!!!!!!!!!!!!!!!!!!!!!!!!!!!!!!!!!!!!!!!!!!!!!!!!!!!!!!!!!
2072     !
2074 Change_eutid:  !
2076     DISP "DESCRIPTION of the EUT and PURPOSE for test?? (<2 lines)";
2078     OUTPUT 2 USING "K,#";Eut_identity#
2080     LINFUT Eut_identity#
2082 Print_eutid:  !
2084     PRINT TABXY(1,4);RPT#(" ",160)
2086     PRINT TABXY(1,4);Eut_identity#
2088     RETURN
2090     !
2092     !!!!!!!!!!!!!!!!!!!!!!!!!!!!!!!!!!!!!!!!!!!!!!!!!!!!!!!!!!!!!!!!!!!!!!!!!!!!!!!
2094     !
2096 Change_freqs:  !
2098     DISP "ENTER the START, STOP, and STEP frequencies (MHz) ";
2100     INFUT Startf,Stopf,Stepf
2102     IF Startf<100 THEN Startf=100
2104     IF Startf>18000 THEN Startf=18000
2106     SELECT Startf
2108     CASE <2000
2110         IF Stopf>2000 THEN Stopf=2000
2112         Coupler_id#="HF_778D"
2114         Generator_id#="HF_8660A"
2116     CASE >=2000
2118         IF Stopf>18000 THEN Stopf=18000
2120         Coupler_id#="HF_11692D"
2122         Generator_id#="HF_8672A"
2124     END SELECT
2126 Print_freqs:  !
2128     PRINT TABXY(21,7);
2130     PRINT USING "5D.2D";Startf
2132     PRINT TABXY(33,7);
2134     PRINT USING "5D.2D";Stopf
2136     PRINT TABXY(47,7);
2138     PRINT USING "5D.2D";Stepf

```

U.S. DEPT. OF COMM. BIBLIOGRAPHIC DATA SHEET <i>(See instructions)</i>	1. PUBLICATION OR REPORT NO. NBS/TN-1092	2. Performing Organ. Report No.	3. Publication Date April 1986
4. TITLE AND SUBTITLE Design, Evaluation, and Use of a Reverberation Chamber for Performing Electromagnetic Susceptibility/Vulnerability Measurements			
5. AUTHOR(S) M. L. Crawford and G. H. Koepke			
6. PERFORMING ORGANIZATION <i>(If joint or other than NBS, see instructions)</i> NATIONAL BUREAU OF STANDARDS DEPARTMENT OF COMMERCE WASHINGTON, D.C. 20234		7. Contract/Grant No.	8. Type of Report & Period Covered
9. SPONSORING ORGANIZATION NAME AND COMPLETE ADDRESS <i>(Street, City, State, ZIP)</i> Naval Surface Weapons Center (NSWC), Dahlgren, Virginia and Rome Air Development Center (RADC), Griffiss Air Force Base, Rome, New York			
10. SUPPLEMENTARY NOTES <input type="checkbox"/> Document describes a computer program; SF-185, FIPS Software Summary, is attached.			
11. ABSTRACT <i>(A 200-word or less factual summary of most significant information. If document includes a significant bibliography or literature survey, mention it here)</i> This report presents the results of work at the National Bureau of Standards, Boulder, Colorado, to carefully evaluate, document, develop (when necessary), and describe the methodology for performing radiated susceptibility/vulnerability measurements using a reverberation chamber. The report describes the reverberation chamber theory of operation, construction, evaluation, functional operation, and use for performing immunity measurements. It includes an estimate of measurement uncertainties derived empirically from test results and from comparisons with anechoic chamber measurements. Finally, it discusses the limitations and advantages of the measurement technique to assist potential users in determining the applicability for this technique to their electromagnetic compatibility (EMC) measurement needs.			
12. KEY WORDS <i>(Six to twelve entries; alphabetical order; capitalize only proper names; and separate key words by semicolons)</i> electromagnetic susceptibility/vulnerability; estimated uncertainty; evaluation; measurement procedures; reverberation chamber			
13. AVAILABILITY <input checked="" type="checkbox"/> Unlimited <input type="checkbox"/> For Official Distribution. Do Not Release to NTIS <input checked="" type="checkbox"/> Order From Superintendent of Documents, U.S. Government Printing Office, Washington, D.C. 20402. <input type="checkbox"/> Order From National Technical Information Service (NTIS), Springfield, VA. 22161		14. NO. OF PRINTED PAGES 146	15. Price

NBS *Technical Publications*

Periodical

Journal of Research—The Journal of Research of the National Bureau of Standards reports NBS research and development in those disciplines of the physical and engineering sciences in which the Bureau is active. These include physics, chemistry, engineering, mathematics, and computer sciences. Papers cover a broad range of subjects, with major emphasis on measurement methodology and the basic technology underlying standardization. Also included from time to time are survey articles on topics closely related to the Bureau's technical and scientific programs. Issued six times a year.

Nonperiodicals

Monographs—Major contributions to the technical literature on various subjects related to the Bureau's scientific and technical activities.

Handbooks—Recommended codes of engineering and industrial practice (including safety codes) developed in cooperation with interested industries, professional organizations, and regulatory bodies.

Special Publications—Include proceedings of conferences sponsored by NBS, NBS annual reports, and other special publications appropriate to this grouping such as wall charts, pocket cards, and bibliographies.

Applied Mathematics Series—Mathematical tables, manuals, and studies of special interest to physicists, engineers, chemists, biologists, mathematicians, computer programmers, and others engaged in scientific and technical work.

National Standard Reference Data Series—Provides quantitative data on the physical and chemical properties of materials, compiled from the world's literature and critically evaluated. Developed under a worldwide program coordinated by NBS under the authority of the National Standard Data Act (Public Law 90-396).

NOTE: The Journal of Physical and Chemical Reference Data (JPCRD) is published quarterly for NBS by the American Chemical Society (ACS) and the American Institute of Physics (AIP). Subscriptions, reprints, and supplements are available from ACS, 1155 Sixteenth St., NW, Washington, DC 20056.

Building Science Series—Disseminates technical information developed at the Bureau on building materials, components, systems, and whole structures. The series presents research results, test methods, and performance criteria related to the structural and environmental functions and the durability and safety characteristics of building elements and systems.

Technical Notes—Studies or reports which are complete in themselves but restrictive in their treatment of a subject. Analogous to monographs but not so comprehensive in scope or definitive in treatment of the subject area. Often serve as a vehicle for final reports of work performed at NBS under the sponsorship of other government agencies.

Voluntary Product Standards—Developed under procedures published by the Department of Commerce in Part 10, Title 15, of the Code of Federal Regulations. The standards establish nationally recognized requirements for products, and provide all concerned interests with a basis for common understanding of the characteristics of the products. NBS administers this program as a supplement to the activities of the private sector standardizing organizations.

Consumer Information Series—Practical information, based on NBS research and experience, covering areas of interest to the consumer. Easily understandable language and illustrations provide useful background knowledge for shopping in today's technological marketplace.

Order the **above** NBS publications from: Superintendent of Documents, Government Printing Office, Washington, DC 20402.

Order the **following** NBS publications—FIPS and NBSIR's—from the National Technical Information Service, Springfield, VA 22161.

Federal Information Processing Standards Publications (FIPS PUB)—Publications in this series collectively constitute the Federal Information Processing Standards Register. The Register serves as the official source of information in the Federal Government regarding standards issued by NBS pursuant to the Federal Property and Administrative Services Act of 1949 as amended, Public Law 89-306 (79 Stat. 1127), and as implemented by Executive Order 11717 (38 FR 12315, dated May 11, 1973) and Part 6 of Title 15 CFR (Code of Federal Regulations).

NBS Interagency Reports (NBSIR)—A special series of interim or final reports on work performed by NBS for outside sponsors (both government and non-government). In general, initial distribution is handled by the sponsor; public distribution is by the National Technical Information Service, Springfield, VA 22161, in paper copy or microfiche form.

U.S. Department of Commerce
National Bureau of Standards
Gaithersburg, MD 20899

Official Business
Penalty for Private Use \$300

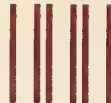

POSTAGE AND FEES PAID
U.S. DEPARTMENT OF COMMERCE
COM-215

SPECIAL FOURTH-CLASS RATE
BOOK