

SUBCHAPTER S—SUBDIVISION AND STABILITY

PART 170—STABILITY REQUIREMENTS FOR ALL INSPECTED VESSELS

Subpart A—General Provisions

- Sec.
- 170.001 Applicability.
 - 170.003 Right of appeal.
 - 170.005 Vessel alteration or repair.
 - 170.010 Equivalents.
 - 170.015 Incorporation by reference.
 - 170.020 OMB control numbers assigned pursuant to the Paperwork Reduction Act.

Subpart B—Definitions

- 170.050 General terms.
- 170.055 Definitions concerning a vessel.

Subpart C—Plan Approval

- 170.070 Applicability.
- 170.075 Plans.
- 170.080 Stability booklet.
- 170.085 Information required before a stability test.
- 170.090 Calculations.
- 170.093 Specific approvals.
- 170.095 Data submittal for a vessel equipped to lift.
- 170.100 Addresses for submittal of plans and calculations.

Subpart D—Stability Instructions for Operating Personnel

- 170.105 Applicability.
- 170.110 Stability booklet.
- 170.120 Stability letter.
- 170.125 Operating information for a vessel engaged in lifting.
- 170.135 [Reserved]
- 170.140 Operating information for a vessel constructed on or after January 1, 2009 and issued a SOLAS safety certificate.

Subpart E—Intact Stability Criteria

- 170.160 Specific applicability.
- 170.165 International Code on Intact Stability.
- 170.170 Weather criteria.
- 170.173 Criterion for vessels of unusual proportion and form.

Subpart F—Determination of Lightweight Displacement and Centers of Gravity

- 170.174 Specific applicability.
- 170.175 Stability test: General.
- 170.180 Plans and information required at the stability test.

- 170.185 Stability test preparations.
- 170.190 Stability test procedure modifications.
- 170.200 Estimated lightweight vertical center of gravity.

Subpart G—Special Installations

- 170.235 Fixed ballast.
- 170.245 Form flotation material.

Subpart H—Watertight Bulkhead Doors

- 170.248 Applicability.
- 170.250 Types and classes.
- 170.255 Class 1 doors; permissible locations.
- 170.260 Class 2 doors; permissible locations.
- 170.265 Class 3 doors; required locations.
- 170.270 Door design, operation, installation, and testing.
- 170.275 Special requirements for cargo space watertight doors.

Subpart I—Free Surface

- 170.285 Free surface correction for intact stability calculations.
- 170.290 Free surface correction for damage stability calculations.
- 170.295 Special considerations for free surface of passive roll stabilization tanks.
- 170.300 Special consideration for free surface of spoil in hopper dredge hoppers.

AUTHORITY: 43 U.S.C. 1333; 46 U.S.C. 2103, 3306, 3703; E.O. 12234, 45 FR 58801, 3 CFR, 1980 Comp., p. 277; Department of Homeland Security Delegation No. 0170.1.

SOURCE: CGD 79-023, 48 FR 51010, Nov. 4, 1983, unless otherwise noted.

Subpart A—General Provisions

§ 170.001 Applicability.

(a) This subchapter applies to each vessel that is—

(1) Contracted for on or after March 11, 1996, except where specifically stated otherwise; and

(2) Either—

(i) Inspected under another subchapter of this chapter, or is a foreign vessel that must comply with the requirements in subchapter O of this chapter; or

(ii) Required by either subchapter C or subchapter E of this chapter to meet applicable requirements contained in this subchapter.

(b) Each vessel contracted for before March 11, 1996 may be constructed in

§ 170.003

accordance with the regulations in effect at the time. However, any alterations or repairs must be done in accordance with §170.005.

(c) Certain regulations in this subchapter apply only to limited categories of vessels. Specific applicability statements are provided at the beginning of those regulations.

[CGD 79-023, 48 FR 51010, Nov. 4, 1983, as amended by CGD 89-037, 57 FR 41825, Sept. 11, 1992; CGD 85-080, 61 FR 943, Jan. 10, 1996; USCG-2007-0030, 75 FR 78082, Dec. 14, 2010]

§ 170.003 Right of appeal.

Any person directly affected by a decision or action taken under this subchapter, by or on behalf of the Coast Guard, may appeal therefrom in accordance with subpart 1.03 of this chapter.

[CGD 88-033, 54 FR 50382, Dec. 6, 1989]

§ 170.005 Vessel alteration or repair.

(a) Alterations and repairs to inspected vessels must be done—

(1) Under the direction of the Officer in Charge, Marine Inspection; and

(2) Except as provided in paragraph (b) of this section, in accordance with the regulations in this subchapter, to the extent practicable.

(b) Minor alterations and repairs may be done in accordance with regulations in effect at the time the vessel was contracted for.

§ 170.010 Equivalentents.

Substitutions for fittings, equipment, arrangements, calculations, information, or tests required in this subchapter may be approved by the Commandant, the Commanding Officer (MSC), Attn: Marine Safety Center, U.S. Coast Guard Stop 7410, 4200 Wilson Boulevard Suite 400, Arlington, VA 20598-7410, or the Officer in Charge, Marine Inspection, if the substitution provides an equivalent level of safety.

[USCG-2007-29018, 72 FR 53968, Sept. 21, 2007, as amended by USCG-2009-0702, 74 FR 49239, Sept. 25, 2009; USCG-2013-0671, 78 FR 60163, Sept. 30, 2013]

§ 170.015 Incorporation by reference.

(a) Certain material is incorporated by reference into this part with the approval of the Director of the Federal

46 CFR Ch. I (10-1-14 Edition)

Register under 5 U.S.C. 552(a) and 1 CFR part 51. To enforce any edition other than that specified in this section, the Coast Guard must publish a notice of change in the FEDERAL REGISTER and the material must be available to the public. All approved material is available for inspection at the National Archives and Records Administration (NARA). For information on the availability of this material at NARA, call 202-741-6030 or go to http://www.archives.gov/federal_register/code_of_federal_regulations/ibr_locations.html. It is also available for inspection at Coast Guard Headquarters. Contact Commandant (CG-ENG), Attn: Office of Design and Engineering Systems, U.S. Coast Guard Stop 7509, 2703 Martin Luther King Jr. Avenue SE., Washington, DC 20593-7509. The material is also available from the sources listed below.

(b) American Society for Testing and Materials (ASTM), 100 Barr Harbor Drive, West Conshohocken, PA 19428-2959.

(1) ASTM F 1196-00, Standard Specification for Sliding Watertight Door Assemblies, 2008, incorporation by reference (IBR) approved for §170.270.

(2) ASTM F 1197-00, Standard Specification for Sliding Watertight Door Control Systems, 2007, IBR approved for §170.270.

(c) Military Specifications and Standards, Standardization Documents Order Desk, Building 4D, 700 Robbins Avenue, Philadelphia, PA 19111-5094, <https://assist.daps.dla.mil/quicksearch/>.

(1) MIL-P-21929B, Military Specification, Plastic Material, Cellular Polyurethane, Foam-in-Place, Rigid (2 Pounds per Cubic Foot), 15 January 1991, IBR approved for §170.245.

(2) [Reserved]

(d) International Maritime Organization (IMO), Publications Section, 4 Albert Embankment, London SE1 7SR, United Kingdom, +44 (0)20 7735 7611, <http://www.imo.org/>.

(1) Resolution MSC.216(82), Adoption of Amendments to the International Convention for the Safety of Life At Sea, 1974, As Amended (IMO Res. MSC.216(82), Adopted on 8 December 2006, IBR approved for §§170.140 and 170.248.

(2) Resolution MSC 267(85), Adoption of the International Code on Intact Stability, 2008 (2008 IS Code), Adopted on 4 December 2008, IBR approved for § 170.165.

[USCG-2007-0030, 75 FR 78082, Dec. 14, 2010, as amended by USCG-2012-0832, 77 FR 59788, Oct. 1, 2012; USCG-2013-0671, 78 FR 60163, Sept. 30, 2013]

§ 170.020 OMB control numbers assigned pursuant to the Paperwork Reduction Act.

(a) *Purpose.* This section collects and displays the control numbers assigned to information collection and record-keeping requirements in this subchapter by the Office of Management and Budget (OMB) pursuant to the Paperwork Reduction Act of 1980 (44 U.S.C. 3501 *et seq.*). The Coast Guard intends that this section comply with the requirements of 44 U.S.C. 3507(f), which requires that agencies display a current control number assigned by the OMB for each approved agency information collection requirement.

(b) *Display.*

46 CFR part—	Current OMB control No.
§ 170.075	1625-0064
§ 170.080	1625-0064
§ 170.085	1625-0064
§ 170.090	1625-0064
§ 170.095	1625-0064
§ 170.100	1625-0064
§ 170.110	1625-0064
§ 170.120	1625-0064
§ 170.125	1625-0064
§ 170.135	1625-0064
§ 170.180	1625-0064

[CGD 89-037, 57 FR 41825, Sept. 11, 1992, as amended by USCG-2004-18884, 69 FR 58350, Sept. 30, 2004]

Subpart B—Definitions

§ 170.050 General terms.

(a) *Commanding Officer, Marine Safety Center (CO, MSC)* means a district commander described in 33 CFR part 3 whose command includes a merchant marine technical office or an authorized representative of the district commander.

(b) *Commandant* means the Commandant of the Coast Guard or an authorized representative of the Commandant.

(c) *Exposed waters* means waters more than 20 nautical miles (37 kilometers) from the mouth of a harbor of safe refuge and other waters which the Officer in Charge, Marine Inspection determines to present special hazards due to weather or other circumstances.

(d) *Great Lakes* includes both the waters of the Great Lakes and of the St. Lawrence River as far east as a straight line drawn from Cap de Rosiers to West Point, Anticosti Island, and west of a line along the 63rd meridian from Anticosti Island to the north shore of the St. Lawrence River.

(e) *Lakes, Bays, and Sounds* includes the waters of any lake, bay, or sound, except the Great Lakes.

(f) *Oceans* includes the waters of—

- (1) Any ocean;
- (2) The Gulf of Mexico;
- (3) The Caribbean Sea;
- (4) The Gulf of Alaska; and
- (5) Any other waters designated as “oceans” by the Commandant.

(g) *Officer in Charge Marine Inspection (OCMI)* means an officer of the Coast Guard who commands a Marine Inspection Zone described in 33 CFR part 3 or an authorized representative of that officer.

(h) *Oil* means oil of any kind or in any form, and includes but is not limited to petroleum, fuel oil, sludge, oil refuse, and oil mixed with wastes other than dredged spoil.

(i) *Partially protected waters* means—

- (1) Waters within 20 nautical miles (37 kilometers) of the mouth of a harbor of safe refuge, unless determined by the OCMI to be exposed waters; and
- (2) Those portions of rivers, harbors, lakes, etc. which the OCMI determines not to be sheltered.

(j) *Protected waters* means sheltered waters presenting no special hazards such as most rivers, harbors, lakes, etc.

(k) *Rivers* means any river, canal, or any other similar body of water designated by the OCMI.

[CGD 79-023, 48 FR 51010, Nov. 4, 1983, as amended by CGD 88-070, 53 FR 34537, Sept. 7, 1988]

§ 170.055 Definitions concerning a vessel.

(a) *Assumed average weight per person* means the weight calculated in accordance with § 170.090 of this part.

§ 170.055

46 CFR Ch. I (10–1–14 Edition)

(b) *Auxiliary sailing vessel* means a vessel capable of being propelled both by mechanical means and by sails.

(c) *Barge* means a vessel not equipped with a means of self-propulsion.

(d) *Beam* or *B* means the maximum width of a vessel from—

(1) Outside of planking to outside of planking on wooden vessels; and

(2) Outside of frame to outside of frame on all other vessels.

(e) *Bulkhead deck* means the uppermost deck to which watertight bulkheads and the watertight shell extend.

(f) *Constructed* means the date—

(1) The vessel's keel was laid; or

(2) Construction identifiable with the vessel began and assembly of that vessel commenced comprising of 50 metric tons or at least 1 percent of the estimated mass of all structural material, whichever is less.

(g) *Downflooding* means, except as provided in §174.035(b), the entry of seawater through any opening into the hull or superstructure of an undamaged vessel due to heel, trim, or submergence of the vessel.

(h) *Documented alterations* means changes to the vessel which are reflected in the approved stability information carried on board the vessel.

(i) *Downflooding angle* means, except as specified by §§171.055(f), 172.090(d), 173.095(e), 174.015(b), and 174.035(b)(2) of this chapter, the static angle from the intersection of the vessel's centerline and waterline in calm water to the first opening that cannot be closed watertight and through which downflooding can occur.

(j) *Draft* means the vertical distance from the molded baseline amidships to the waterline.

(k) *Length* means the distance between fore and aft points on a vessel. The following specific terms are used and correspond to specific fore and aft points:

(1) *Length between perpendiculars (LBP)* means the horizontal distance measured between perpendiculars taken at the forward-most and after-most points on the waterline corresponding to the deepest operating draft. For a small passenger vessel that has underwater projections extending forward of the forward-most point or aft of the after-most point on the deep-

est waterline of the vessel, the Commanding Officer, U.S. Coast Guard Marine Safety Center, may include the length or a portion of the length of the underwater projections in the value used for the LBP for the purposes of this subchapter. The length or a portion of the length of projections that contribute more than 2 percent of the underwater volume of the vessel is normally added to the actual LBP.

(2) *Length overall (LOA)* means the horizontal distance between the forward-most and after-most points on the hull.

(3) *Length on the waterline (LWL)* means the horizontal distance between the forward-most and after-most points on a vessel's waterline.

(4) *Length on deck (LOD)* means the length between the forward-most and after-most points on a specified deck measured along the deck, excluding sheer.

(5) *Load line length (LLL)* has the same meaning that is provided for the term *length* in §42.13–15(a) of this chapter.

(6) *Mean length* is the average of the length between perpendiculars (LBP) and the length on deck (LOD).

(1) *Lightweight* means the displacement of a vessel with fixed ballast and with machinery liquids at operating levels but without any cargo, stores, consumable liquids, water ballast, or persons and their effects.

(m) *Main transverse watertight bulkhead* means a transverse bulkhead that must be maintained watertight in order for the vessel to meet the damage stability and subdivision requirements in this subchapter.

(n) *Major conversion*, as applied to Great Lakes bulk carriers, means a conversion of an existing vessel that substantially changes the dimensions or carrying capacity of the vessel or changes the type of vessel or substantially prolongs its life or that otherwise so changes the vessel that it is essentially a new vessel.

(o) *Permeability* is the percentage of the volume of a space that can be occupied by water.

(p) *Sailing vessel* means a vessel propelled only by sails.

(q) *Ship* means a self-propelled vessel.

(r) *Tank vessel* means a vessel that is specially constructed or converted to carry liquid bulk cargo in tanks.

(s) *Tank barge* means a tank vessel not equipped with a means of self-propulsion.

(t) *Tank ship* means a tank vessel propelled by mechanical means or sails.

(u) *Vessel* means any vessel and includes both ships and barges.

(v) *Weather deck* means the uppermost deck exposed to the weather.

(w) *Existing sailing school vessel* means a sailing vessel whose keel was laid prior to (January 9, 1986), which has an application for initial inspection for certification as a sailing school vessel on file with the Coast Guard prior to (January 9, 1987), and whose initial inspection for certification is completed prior to (January 9, 1988).

(x) *New sailing school vessel* means a sailing school vessel which is not an existing sailing school vessel.

(y) *Small passenger vessel* means a vessel of less than 100 gross tons—

(1) Carrying more than 6 passengers, including at least one passenger for hire;

(2) That is chartered with the crew provided or specified by the owner or owner's representative and carrying more than 6 passengers;

(3) That is chartered with no crew provided or specified by the owner or owner's representative and carrying more than 12 passengers; or

(4) That is a submersible vessel carrying at least one passenger for hire.

[CGD 79-023, 48 FR 51010, Nov. 4, 1983]

EDITORIAL NOTE: For FEDERAL REGISTER citations affecting § 170.055, see the List of CFR Sections Affected, which appears in the Finding Aids section of the printed volume and at www.fdsys.gov.

Subpart C—Plan Approval

§ 170.070 Applicability.

(a) Except as provided in paragraph (b) of this section, this subpart applies to each vessel.

(b) This subpart does not apply to any of the following vessels unless the stability of the vessel is questioned by the OCMI, or regulations by which the vessel is inspected require their application:

(1) A passenger vessel that—

(i) Is less than 100 gross tons;

(ii) Is less than 65 feet (19.8 meters) LOD measured over the weather deck; and

(iii) Carries 49 or less passengers.

(2) A deck cargo barge that complies with the requirements in § 174.020 of this chapter.

(3) A tank vessel that only carries a product listed in § 30.25-1 of this chapter and that is less than 150 gross tons.

(4) A tank barge that—

(i) Operates only in rivers or lakes, bays, and sounds service;

(ii) Does not have to meet 33 CFR part 157, subpart B; and

(iii) Only carries a product listed in § 30.25-1 of this chapter.

(5) A sailing school vessel that is an open boat that complies with the requirements in § 173.063(e) of this subchapter.

[CGD 79-023, 48 FR 51010, Nov. 4, 1983, as amended by CGD 83-005, 51 FR 923, Jan. 9, 1986; USCG-2007-0030, 75 FR 78083, Dec. 14, 2010]

§ 170.075 Plans.

(a) Except as provided in paragraph (b) of this section, each applicant for an original certificate of inspection and approval of plans must also submit three copies for plan review being conducted by the Coast Guard Marine Safety Center of each of the following plans:

(1) General arrangement plan of decks, holds, and inner bottoms including inboard and outboard profiles.

(2) Lines.

(3) Curves of form.

(4) Capacity plan showing capacities and vertical, longitudinal, and transverse centers of gravity of stowage spaces and tanks.

(5) Tank sounding tables showing—

(i) Capacities, vertical centers of gravity, and longitudinal centers of gravity in graduated intervals; and

(ii) Free surface data for each tank.

(6) Draft mark locations including longitudinal location and vertical reference points.

(b) Each small passenger vessel that is designed to comply with the alternate intact stability requirements in

§ 170.080

§ 178.320 of this subchapter and the simplified method of spacing main transverse watertight bulkheads in § 179.220 of this subchapter does not have to submit the plans required by paragraph (a) of this section.

[CGD 79-023, 48 FR 51010, Nov. 4, 1983, as amended by CGD 85-080, 61 FR 944, Jan. 10, 1996; CGD 95-028, 62 FR 51217, Sept. 30, 1997; USCG-2007-0030, 75 FR 78083, Dec. 14, 2010]

§ 170.080 Stability booklet.

Before issuing an original certificate of inspection, the following number of copies of the stability booklet required by § 170.110 must be submitted for approval; three copies for plan review being conducted by the Coast Guard Marine Safety Center.

[CGD 95-028, 62 FR 51217, Sept. 30, 1997, as amended by USCG-2007-0030, 75 FR 78083, Dec. 14, 2010]

§ 170.085 Information required before a stability test.

If a stability test is to be performed, a stability test procedure that contains the information prescribed in § 170.185(g) must be submitted to the Coast Guard Marine Safety Center at least two weeks before the test.

[CGD 95-028, 62 FR 51217, Sept. 30, 1997, as amended by USCG-2007-0030, 75 FR 78083, Dec. 14, 2010]

§ 170.090 Calculations.

(a) All calculations required by this subchapter must be submitted with the plans required by § 170.075 of this subpart. Calculations must account for the weight of all loads carried aboard the vessel.

(b) If it is necessary to compute and plot any of the following curves as part of the calculations required in this subchapter, these plots must also be submitted:

- (1) Righting arm or moment curves.
- (2) Heeling arm or moment curves.
- (3) Cross curves of stability.
- (4) Floodable length curves.

(c) The assumed weight per person for calculations showing compliance with the regulations of this subchapter must be representative of the passengers and crew aboard the vessel while engaged in the service intended. Unless the Officer in Charge, Marine Inspection (OCMI) permits or requires

46 CFR Ch. I (10-1-14 Edition)

the use of other values in writing, the assumed weight per person of passengers and crew must not be less than that the Assumed Average Weight per Person (AAWPP) calculated in accordance with paragraphs (d) and (e) of this section.

(d)(1) The AAWPP is 185 lb from December 1, 2011 until the AAWPP is first updated pursuant to the provisions of this section. As of the effective date of the first AAWPP update after December 1, 2011, this paragraph (d)(1) will be superseded and cease to be effective.

(2) The formula in paragraph (e) of this section will be used to determine an update to the AAWPP. It requires the use of data in the most recent report released by the Centers for Disease Control and Prevention (CDC) through the National Center for Health Statistics (NCHS), or any successors to those centers. This report can be found on the CDC's Web site.

(3) Each time the CDC releases a report containing mean weights of United States adult males and females, the Coast Guard will apply the formula in paragraph (e) of this section to that data. The resulting value will become the new AAWPP only if the sum equals or exceeds 10 pounds more than the AAWPP then in effect. The Coast Guard will notify the public of the new AAWPP in the FEDERAL REGISTER and other appropriate media.

(4) Updates to the AAWPP used in calculations showing compliance with this subchapter will be promulgated as interpretive rules and become effective in accordance with the provisions of this section without further rule-making procedures.

(5) Notwithstanding any other provisions of this section, the Coast Guard may choose, in its discretion, to conduct further rulemaking procedures at any time to amend this subchapter, including updates of the AAWPP.

(6) Updates to the AAWPP used in calculations showing compliance with this subchapter will be published in a separate FEDERAL REGISTER notice and other appropriate media, except when the Coast Guard conducts further rule-making procedures under paragraph (d)(5) of this section.

(7) Notwithstanding any other provisions of this section, the Coast Guard

Coast Guard, DHS

§ 170.105

may choose, in its discretion, to delay or dispense with any update of the AAWPP. In the event the Coast Guard elects to dispense with or delay an update that would otherwise issue as an interpretive rule pursuant to the provisions of this section, the Coast Guard will inform the public of the decision and explain the reasons in a FEDERAL REGISTER notice.

(e) To obtain an AAWPP update, add the mean weight of all U.S. males aged 20 years and older to the mean weight of all U.S. females aged 20 years and older, and divide the sum by 2. To this average of the mean weights, add 7.5 pounds of assumed clothing weight, and round the resulting sum to the nearest whole number in pounds.

(f) Updates to the AAWPP will become effective beginning one calendar year after publication in the FEDERAL REGISTER of a notice described in paragraphs (d)(3) and (d)(6) of this section, except the initial AAWPP issued pursuant to paragraph (d)(1) of this section will become effective on December 1, 2011. Notwithstanding any other provisions of this title, the Coast Guard may implement updates to the AAWPP at any time with less than one year of public notice when required for public safety reasons.

(g) The most recent FEDERAL REGISTER notice that publishes the AAWPP as determined by this section is also on file at the Coast Guard Headquarters. Contact Commandant (CG-ENG-2), Attn: Naval Architecture Division, U.S. Coast Guard Stop 7509, 2703 Martin Luther King Jr. Avenue SE., Washington, DC 20593-7509, or go to: <http://www.uscg.mil/hq/cg5/cg5212>

[CGD 79-023, 48 FR 51010, Nov. 4, 1983, as amended by USCG-2007-0030, 75 FR 78083, Dec. 14, 2010; 76 FR 16698, Mar. 25, 2011; USCG-2012-0832, 77 FR 59788, Oct. 1, 2012; USCG-2013-0671, 78 FR 60163, Sept. 30, 2013]

§ 170.093 Specific approvals.

Certain rules in this subchapter require specific approval of equipment or arrangements by the Commandant, OCMI, or Coast Guard Marine Safety Center. These approval determinations

will be made as a part of the plan review process.

[CGD 95-028, 62 FR 51217, Sept. 30, 1997, as amended by USCG-2007-0030, 75 FR 78083, Dec. 14, 2010]

§ 170.095 Data submittal for a vessel equipped to lift.

The following data must be submitted with the plans required by § 170.075 if the vessel is engaged in lifting and is required to comply with subpart B of part 173 of this chapter:

(a) A graph of maximum hook load versus maximum crane radius.

(b) A table of crane radius versus the maximum distance above the main deck to which the hook load can be raised.

(c) A table showing maximum vertical and transverse moments at which the crane is to operate.

§ 170.100 Addresses for submittal of plans and calculations.

The plans, information, and calculations required by this subpart must be submitted to one of the following:

(a) The Sector Office in the zone where the vessel is to be built or altered.

(b) By visitors to the Commanding Officer, Marine Safety Center, U.S. Coast Guard, 4200 Wilson Boulevard Suite 400, Arlington, VA 22203, or by mail to: Commanding Officer (MSC), Attn: Marine Safety Center, U.S. Coast Guard Stop 7410, 4200 Wilson Boulevard Suite 400, Arlington, VA 20598-7410, in a written or electronic format. Information for submitting the VSP electronically can be found at <http://www.uscg.mil/HQ/MSC>.

[CGD 95-028, 62 FR 51217, Sept. 30, 1997, as amended by USCG-2006-25556, 72 FR 36330, July 2, 2007; USCG-2007-29018, 72 FR 53968, Sept. 21, 2007; USCG-2009-0702, 74 FR 49239, Sept. 25, 2009; USCG-2007-0030, 75 FR 78083, Dec. 14, 2010; USCG-2013-0671, 78 FR 60163, Sept. 30, 2013]

Subpart D—Stability Instructions for Operating Personnel

§ 170.105 Applicability.

(a) Except as provided in paragraph (b) of this section, this subpart applies to each vessel.

§ 170.110

46 CFR Ch. I (10–1–14 Edition)

(b) This subpart does not apply to any of the following vessels unless the stability of the vessel is questioned by the OCFMI:

(1) A deck cargo barge that complies with the requirements in §174.020 of this chapter.

(2) A tank vessel that only carries a product listed in §30.25–1 of this chapter and that is less than 150 gross tons.

(3) A tank barge that—

(i) Operates only in rivers or lakes, bays, and sounds service;

(ii) Does not have to meet 33 CFR part 157, subpart B; and

(iii) Only carries a product listed in §30.25–1 of this chapter.

(4) A sailing school vessel that is an open boat that complies with the requirements in §173.063(e) of this subchapter.

(5) A small passenger vessel inspected under subchapter T of this chapter if §178.210(c) of this chapter is applicable.

[CGD 79–023, 48 FR 51010, Nov. 4, 1983, as amended by CGD 83–005, 51 FR 923, Jan. 9, 1986; CGD 85–080, 61 FR 944, Jan. 10, 1996; USCG–2007–0030, 75 FR 78084, Dec. 14, 2010]

§ 170.110 Stability booklet.

(a) Except as provided in paragraph (e) of this section, a stability booklet must be prepared for each vessel, except for mobile offshore drilling units subject to the operating manual requirements of §109.121 of this chapter.

(b) Each stability booklet must be approved by the Coast Guard Marine Safety Center.

(c) Each stability book must contain sufficient information to enable the master to operate the vessel in compliance with applicable regulations in this subchapter. Information on loading restrictions used to determine compliance with applicable intact and damage stability criteria must encompass the entire range of operating drafts and the entire range of the operating trims. Information must include an effective procedure for supervision and reporting of the opening and closing of all loading doors, where applicable.

(d) The format of the stability booklet and the information included will vary dependent on the vessel type and operation. Units of measure used in the stability booklet must agree with the units of measure of the draft markings.

In developing the stability booklet, consideration must be given to including the following information:

(1) A general description of the vessel, including lightweight data.

(2) Instructions on the use of the booklet.

(3) General arrangement plans showing watertight compartments, closures, vents, downflooding angles, and allowable deck loadings.

(4) Hydrostatic curves or tables.

(5) Capacity plan showing capacities and vertical, longitudinal, and transverse centers of gravity of stowage spaces and tanks.

(6) Tank sounding tables showing capacities, vertical centers of gravity, and longitudinal centers of gravity in graduated intervals and showing free surface data for each tank.

(7) Information on loading restrictions, such as a maximum KG or minimum GM curve that can be used to determine compliance with applicable intact and damage stability criteria.

(8) Examples of loading conditions.

(9) A rapid and simple means for evaluating other loading conditions.

(10) A brief description of the stability calculations done including assumptions.

(11) General precautions for preventing unintentional flooding.

(12) A table of contents and index for the booklet.

(13) Each ship condition which, if damage occurs, may require crossflooding for survival and information concerning the use of any special crossflooding fittings.

(14) The amount and location of fixed ballast.

(15) Any other necessary guidance for the safe operation of the vessel under normal and emergency conditions.

(16) For each self-propelled hopper dredge with a working freeboard, the maximum specific gravity allowed for dredge spoil.

(e) A stability booklet is not required if sufficient information to enable the master to operate the vessel in compliance with the applicable regulations in this subchapter can be placed on the Certificate of Inspection, Load Line Certificate, or in the stability letter required in §170.120.

(f) On board electronic stability computers may be used as an adjunct to the required booklet, but the required booklet must contain all necessary information to allow for the evaluation of the stability of any intact condition that can be evaluated by use of the computer.

[CGD 79-023, 48 FR 51010, Nov. 4, 1983, as amended by CGD 83-071, 52 FR 6979, Mar. 6, 1987; CGD 88-070, 53 FR 34537, Sept. 7, 1988; CGD 76-080, 54 FR 36977, Sept. 6, 1989; CGD 89-037, 57 FR 41825, Sept. 11, 1992; CGD 95-028, 62 FR 51217, Sept. 30, 1997; USCG-2007-0030, 75 FR 78084, Dec. 14, 2010]

§ 170.120 Stability letter.

(a) Except as provided in paragraph (b) of this section, each vessel must have a stability letter issued by the Coast Guard before the vessel is placed into service. This letter sets forth conditions of operation.

(b) A stability letter is not required if the information can be placed on the Certificate of Inspection or the Load Line Certificate.

[CGD 79-023, 48 FR 51010, Nov. 4, 1983, as amended by CGD 95-028, 62 FR 51217, Sept. 30, 1997; USCG-2007-0030, 75 FR 78084, Dec. 14, 2010]

§ 170.125 Operating information for a vessel engaged in lifting.

In addition to the information required in §170.110, the following information must be included in the stability booklet of a vessel that is required to comply with §173.005 of this subchapter:

(a) *Non-counterballasted vessel.* If a vessel is not counterballasted, stability information setting forth hook load limits corresponding to boom radii based on the intact stability criterion in §173.020 must be provided.

(b) *Counterballasted vessel.* If a vessel is counterballasted with water, the following information must be provided:

(1) Instructions on the effect of the free surface of the counterballast water.

(2) Instructions on the amounts of counterballast needed to compensate for hook load heeling moments.

(3) If a vessel has fixed counterballast, a table of draft versus maximum vertical moment of deck cargo and hook load combined.

(4) If a vessel has variable counterballast, a table of draft versus maximum vertical moment of deck cargo and hook load combined for each counterballasted condition.

§ 170.135 [Reserved]

§ 170.140 Operating information for a vessel constructed on or after January 1, 2009 and issued a SOLAS safety certificate.

(a) This section applies to each vessel that is—

(1) Constructed on or after January 1, 2009; and

(2) Issued either a SOLAS Passenger Ship Safety Certificate or a SOLAS Cargo Ship Safety Construction Certificate.

(b) In addition to the information required in §170.110 of this part, the stability booklet of each vessel to which this section applies must contain the information required by applicable regulations of IMO Res. MSC.216(82) (incorporated by reference, see §170.015).

(c) As used in SOLAS chapter II-1, *Administration* means the Commandant, U.S. Coast Guard.

[USCG-2007-0030, 75 FR 78084, Dec. 14, 2010]

Subpart E—Intact Stability Criteria

§ 170.160 Specific applicability.

(a) Except as provided in paragraphs (b) through (d) of this section, this subpart applies to each vessel.

(b) This subpart does not apply to any of the following vessels unless the stability of the vessel is questioned by the OCMI:

(1) A deck cargo barge that complies with the requirements in §174.020 of this chapter.

(2) A tank vessel that only carries a product listed in §30.25-1 of this chapter and that is—

(i) Less than 150 gross tons; or

(ii) A tank barge that operates only in river or lakes, bays, and sounds service.

(3) A sailing school vessel that is an open boat that complies with the requirements in §173.063(e) of this subchapter.

(c) This subpart does not apply to the following vessels:

§ 170.165

(1) A tank barge that carries a product listed in Table 151.05 of this chapter.

(2) A mobile offshore drilling unit.

(3) A vessel that performs one of the simplified stability proof tests described in subpart C of part 178 of this chapter.

(d) A vessel that complies with §170.165 of this part need not comply with §§170.170 and 170.173 of this part.

[CGD 79-023, 48 FR 51010, Nov. 4, 1983, as amended by CGD 83-005, 51 FR 923, Jan. 9, 1986; CGD 85-080, 61 FR 944, Jan. 10, 1996; USCG-2007-29018, 72 FR 53968, Sept. 21, 2007; USCG-2009-0702, 74 FR 49239, Sept. 25, 2009; USCG-2007-0030, 75 FR 78084, Dec. 14, 2010]

§ 170.165 International Code on Intact Stability.

(a) Each vessel issued one or more of the certificates listed in paragraphs (a)(1) through (4) of this section, must comply with the Introduction and Part A of the International Code on Intact Stability, 2008 (2008 IS Code), unless permitted otherwise (incorporated by reference, see §170.015).

(1) International Load Line Certificate.

(2) SOLAS Passenger Ship Safety Certificate.

(3) SOLAS Cargo Ship Safety Construction Certificate.

(4) High-speed Craft Safety Certificate.

(b) A vessel not subject to the requirements of paragraph (a) of this section is permitted to comply with the applicable criteria contained in the 2008 IS Code as an alternative to the requirements of §§170.170 and 170.173 of this part.

[USCG-2007-0030, 75 FR 78084, Dec. 14, 2010]

§ 170.170 Weather criteria.

(a) Each vessel must be shown by design calculations to have a metacentric height (GM) that is equal to or greater than the following in each condition of loading and operation:

$$GM \geq \frac{PAH}{W \tan (T)}$$

Where—

P=.005+(L/14,200)² tons/ft² . . . for ocean service, Great Lakes winter service, or service on exposed waters.

46 CFR Ch. I (10-1-14 Edition)

P=.055+(L/1309)² metric tons/m² . . . for ocean service, Great Lakes winter service, or service on exposed waters.

P=.0033+(L/14,200)² tons/ft² . . . for Great Lakes summer service or service on partially protected waters.

P=.036+(L/1309)² metric tons/m² . . . for Great lakes summer service or service on partially protected waters.

P=.0025+(L/14,200)² tons/ft² . . . for service on protected waters.

P=.028+(L/1309)² metric tons/m² . . . for service on protected waters.

L=LBP in feet (meters).

A=projected lateral area in square feet (square meters) of the portion of the vessel and deck cargo above the waterline.

H=the vertical distance in feet (meters) from the center of A to the center of the underwater lateral area or approximately to the one-half draft point.

W=displacement in long (metric) tons.

T=either:

(1) the lesser of either 14 degrees heel or the angle of heel in degrees at which one-half the freeboard to the deck edge is immersed; or

(2) for a sailing vessel, T = the lesser of either 14 degrees or the angle of heel in degrees to the deck edge.

The deck edge is to be taken as the intersection of the sidshell and the uppermost continuous deck below which the sidshell is weathertight.

(b) If approved by the Coast Guard Marine Safety Center or the ABS, a larger value of T may be used for a vessel with a discontinuous weather deck or abnormal shear.

(c) When doing the calculations required by paragraph (a) of this section for a sailing vessel or auxiliary sailing vessel, the vessel must be assumed—

(1) To be under bare poles; or

(2) If the vessel has no auxiliary propulsion, to have storm sails set and trimmed flat.

(d) The criterion specified in this section is generally limited in application to the conditions of loading and operation of flush deck, mechanically powered vessels of ordinary proportions and form for which the righting arm (GZ) at the angle (T), calculated after the vessel is permitted to trim free until the trimming moment is zero, is not less than the minimum metacentric height (GM) calculated in paragraph (a) of this section multiplied by sin(T). On other types of vessels, the Coast Guard Marine Safety Center requires calculations in addition to those in paragraph (a) of this section. On a

mechanically powered vessel under 328 feet (100 meters) in length, other than a tugboat or a towboat, the requirements in § 170.173 are applied.

[CGD 79-023, 48 FR 51010, Nov. 4, 1983; 49 FR 37384, Sept. 24, 1984, as amended by CGD 88-070, 53 FR 34537, Sept. 7, 1988; CGD 85-080, 61 FR 944, Jan. 10, 1996; 61 FR 20556, May 7, 1996; CGD 95-028, 62 FR 51217, Sept. 30, 1997; USCG-2007-0030, 75 FR 78084, Dec. 14, 2010]

§ 170.173 Criterion for vessels of unusual proportion and form.

(a) If required by the Coast Guard Marine Safety Center, each mechanically powered vessel less than 328 feet (100 meters) LLL, other than a tugboat or towboat, must be shown by design calculations to comply with—

(1) Paragraph (b) or (c) of this section if the maximum righting arm occurs at an angle of heel less than or equal to 30 degrees; or

(2) Paragraph (b) of this section if the maximum righting arm occurs at an angle of heel greater than 30 degrees.

(b) Each vessel must have—

(1) An initial metacentric height (GM) of at least 0.49 feet (0.15 meters);

(2) A righting arm (GZ) of at least 0.66 feet (0.20 meters) at an angle of heel equal to or greater than 30 degrees;

(3) A maximum righting arm that occurs at an angle of heel not less than 25 degrees;

(4) An area under each righting arm curve of at least 10.3 foot-degrees (3.15 meter-degrees) up to an angle of heel of 30 degrees;

(5) An area under each righting arm curve of at least 16.9 foot-degrees (5.15 meter-degrees) up to an angle of heel of 40 degrees or the downflooding angle, whichever is less; and

(6) An area under each righting arm curve between the angles of 30 degrees and 40 degrees, or between 30 degrees and the downflooding angle if this angle is less than 40 degrees, of not less than 5.6 foot-degrees (1.72 meter-degrees).

(c) Each vessel must have—

(1) An initial metacentric height (GM) of at least 0.49 feet (0.15 meters);

(2) A maximum righting arm that occurs at an angle of heel not less than 15 degrees;

(3) An area under each righting arm curve of at least 16.9 foot-degrees (5.15 meter-degrees) up to an angle of heel of 40 degrees or the downflooding angle, whichever is less;

(4) An area under each righting arm curve between the angles of 30 degrees and 40 degrees, or between 30 degrees and the downflooding angle if this angle is less than 40 degrees, of not less than 5.6 foot-degrees (1.72 meter-degrees); and

(5) An area under each righting arm curve up to the angle of maximum righting arm of not less than the area determined by the following equation:

$$A=10.3+0.187(30-Y) \text{ foot-degrees}$$

$$A=3.15+0.057(30-Y) \text{ meter-degrees}$$

where—

A=area in foot-degrees (meter-degrees).

Y=angle of maximum righting arm, degrees.

(d) For the purpose of demonstrating compliance with paragraphs (b) and (c) of this section, at each angle of heel a vessel's righting arm is calculated after the vessel is permitted to trim free until the trimming moment is zero.

(e) For the purpose of demonstrating acceptable stability on the vessels described in § 170.170(d) as having unusual proportion and form, compliance with paragraphs (a) through (d) of this section or the following criteria is required:

(1) For partially protected routes, there must be—

(i) Positive righting arms to at least 35 degrees of heel;

(ii) No down flooding point to at least 20 degrees; and

(iii) At least 15 foot-degrees of energy to the smallest of the following angles:

(A) Angle of maximum righting arm.

(B) Angle of down flooding.

(C) 40 degrees.

(2) For protected routes, there must be—

(i) Positive righting arms to at least 25 degrees of heel;

(ii) No down flooding point to at least 15 degrees; and

(iii) At least 10 foot-degrees of energy to the smallest of the following angles:

(A) Angle of maximum righting arm.

(B) Angle of down flooding.

§ 170.174

(C) 40 degrees.

[CGD 79-023, 48 FR 51010, Nov. 4, 1983, as amended by CGD 85-080, 61 FR 944, Jan. 10, 1996; CGD 95-028, 62 FR 51218, Sept. 30, 1997; 62 FR 51353, Sept. 30, 1997; USCG-2007-0030, 75 FR 78084, Dec. 14, 2010]

Subpart F—Determination of Lightweight Displacement and Centers of Gravity

§ 170.174 Specific applicability.

This subpart applies to each vessel for which the lightweight displacement and centers of gravity must be determined in order to do the calculations required in this subchapter.

§ 170.175 Stability test: General.

(a) Except as provided in paragraphs (c) and (d) of this section and in § 170.200, the owner of a vessel must conduct a stability test of the vessel and calculate its vertical and longitudinal centers of gravity and its lightweight displacement.

(b) An authorized Coast Guard representative must be present at each stability test conducted under this section.

(c) The stability test may be dispensed with, or a deadweight survey may be substituted for the stability test, if the Coast Guard has a record of, or is provided with, the approved results of a stability test of a sister vessel.

(d) The stability test of a vessel may be dispensed with if the Coast Guard determines that an accurate estimate of the vessel's lightweight characteristics can be made and that locating the precise position of the vessel's vertical center of gravity is not necessary to ensure that the vessel has adequate stability in all probable loading conditions.

[CGD 79-023, 48 FR 51010, Nov. 4, 1983, as amended by CGD 95-028, 62 FR 51218, Sept. 30, 1997; USCG-1998-4442, 63 FR 52192, Sept. 30, 1998; USCG-2007-0030, 75 FR 78084, Dec. 14, 2010]

§ 170.180 Plans and information required at the stability test.

The owner of a vessel must provide the following Coast Guard approved plans and information to the author-

46 CFR Ch. I (10-1-14 Edition)

ized Coast Guard representative at the time of the stability test:

- (a) Lines.
- (b) Curves of form.
- (c) Capacity plans showing capacities and vertical and longitudinal centers of gravity of stowage spaces and tanks.
- (d) Tank sounding tables.
- (e) Draft mark locations.
- (f) General arrangement plan of decks, holds, and inner bottoms.
- (g) Inboard and outboard profiles.
- (h) The stability test procedure described in § 170.185(g).

[CGD 79-023, 48 FR 51010, Nov. 4, 1983, as amended by CGD 95-028, 62 FR 51218, Sept. 30, 1997; USCG-2007-0030, 75 FR 78084, Dec. 14, 2010]

§ 170.185 Stability test preparations.

The following preparations must be made before conducting a stability test:

(a) The vessel must be as complete as practicable at the time of the test.

(b) Each tank vessel must be empty and dry, except that a tank may be partially filled or full if the Coast Guard Marine Safety Center determines that empty and dry tanks are impracticable and that the effect of filling or partial filling on the location of the center of gravity and on the displacement can be accurately determined.

(c) All dunnage, tools, and other items extraneous to the vessel must be removed.

(d) The water depth at the mooring site must provide ample clearance against grounding.

(e) Each mooring line must be arranged so that it does not interfere with the inclination of the unit during the test.

(f) The draft and axis of rotation selected for testing a mobile offshore drilling unit must be those that result in acceptable accuracy in calculating the center of gravity and displacement of the unit.

(g) The stability test procedure required by § 170.085 must include the following:

- (1) Identification of the vessel to be tested.
- (2) Date and location of the test.
- (3) Inclining weight data.
- (4) Pendulum locations and lengths.

Coast Guard, DHS

§ 170.245

(5) Approximate draft and trim of the vessel.

(6) Condition of each tank.

(7) Estimated items to be installed, removed, or relocated after the test, including the weight and location of each item.

(8) Schedule of events.

(9) Person or persons responsible for conducting the test.

[CGD 79-023, 48 FR 51010, Nov. 4, 1983, as amended by CGD 88-070, 53 FR 34537, Sept. 7, 1988; CGD 95-028, 62 FR 51218, Sept. 30, 1997; USCG-2007-0030, 75 FR 78084, Dec. 14, 2010]

§ 170.190 Stability test procedure modifications.

The authorized Coast Guard representative present at a stability test may allow a deviation from the requirements of §§170.180 and 170.185 if the representative determines that the deviation would not decrease the accuracy of the test results.

[CGD 95-028, 62 FR 51218, Sept. 30, 1997, as amended by USCG-2007-0030, 75 FR 78084, Dec. 14, 2010]

§ 170.200 Estimated lightweight vertical center of gravity.

(a) Each tank vessel that does not carry a material listed in either Table 1 of part 153 or Table 4 of part 154 of this chapter may comply with this section in lieu of §170.175 if it—

(1) Is 150 gross tons or greater;

(2) Is of ordinary proportions and form;

(3) Has a flush weather deck, one or more longitudinal bulkheads, and no independent tanks; and

(4) Is designed not to carry cargo above the freeboard deck.

(b) When doing the calculations required by §§170.170 and 172.065, the vertical center of gravity of a tank vessel in the lightweight condition must be assumed to be equal to the following percentage of the molded depth of the vessel measured from the keel amidship:

(1) For a tank ship—70%.

(2) For a tank barge—60%.

(c) As used in this section, *molded depth* has the same meaning that is

provided for the term in §42.13-15(e) of this chapter.

[CGD 79-023, 48 FR 51010, Nov. 4, 1983, as amended by CGD 85-080, 61 FR 944, Jan. 10, 1996]

Subpart G—Special Installations

§ 170.235 Fixed ballast.

(a) Fixed ballast, if used, must be—

(1) Installed under the supervision of the OCMI; and

(2) Stowed in a manner that prevents shifting of position.

(b) Fixed ballast may not be removed from a vessel or relocated unless approved by the Coast Guard Marine Safety Center. However, ballast may be temporarily moved for vessel examination or repair if done under the supervision of the OCMI.

[CGD 79-023, 48 FR 51010, Nov. 4, 1983, as amended by CGD 88-070, 53 FR 34537, Sept. 7, 1988; CGD 95-028, 62 FR 51218, Sept. 30, 1997; USCG-2007-0030, 75 FR 78084, Dec. 14, 2010]

§ 170.245 Foam flotation material.

(a) Installation of foam must be approved by the OCMI.

(b) If foam is used to comply with §171.070(d), §171.095(c), or §173.063(e) of this subchapter, the following applies:

(1) Foam may be installed only in void spaces that are free of ignition sources.

(2) The foam must comply with NPFC MIL-P-21929B (incorporated by reference; see 46 CFR 170.015), including the requirements for fire resistance.

(3) A submergence test must be conducted for a period of at least 7 days to demonstrate whether the foam has adequate strength to withstand a hydrostatic head equivalent to that which would be imposed if the vessel were submerged to its margin line.

(4) The effective buoyancy at the end of the submergence test must be used as the buoyancy credit; however, in no case will a credit greater than 55 lbs per cubic foot (881 kilograms per cubic meter) be allowed.

(5) The structure enclosing the foam must be strong enough to accommodate the buoyancy of the foam.

(6) Piping and cables must not pass through foamed spaces unless they are within piping and cable trunks accessible from both ends.

§ 170.248

(7) Sample specimens must be prepared during installation and the density of the installed foam must be determined.

(8) Foam may be installed adjacent to fuel tanks if the boundary between the tank and space has double continuous fillet welds.

(9) MIL-P-21929B is incorporated by reference into this part.

(10) The results of all tests and calculations must be submitted to the OCMI.

(11) Blocked foam must—

(i) Be used in each area that may be exposed to water; and

(ii) Have a protective cover approved by the OCMI.

[CGD 79-023, 48 FR 51010, Nov. 4, 1983, as amended by CGD 83-005, 51 FR 923, Jan. 9, 1986; USCG-2003-16630, 73 FR 65203, Oct. 31, 2008]

Subpart H—Watertight Bulkhead Doors

§ 170.248 Applicability.

(a) Except as provided in paragraphs (b) through (d) of this section, this subpart applies to vessels with watertight doors in bulkheads that have been made watertight to comply with the flooding or damage stability regulations in this subchapter.

(b) A watertight door on a MODU must comply with § 174.100 of this subchapter.

(c) A watertight door on a self-propelled hopper dredge with a working freeboard must comply with § 174.335 of this subchapter.

(d) Unless permitted otherwise, each vessel constructed on or after January 1, 2009 and issued a SOLAS Passenger Ship Safety Certificate or a SOLAS Cargo Ship Safety Construction Certificate must comply with the applicable regulations of IMO Res. MSC.216(82) in addition to the requirements of this subpart (IMO Res. MSC.216(82) incorporated by reference, see § 170.015).

[CGD 79-023, 48 FR 51010, Nov. 4, 1983, as amended by CGD 76-080, 54 FR 36977, Sept. 6, 1989; USCG-2007-0030, 75 FR 78084, Dec. 14, 2010]

46 CFR Ch. I (10-1-14 Edition)

§ 170.250 Types and classes.

(a) Watertight doors, except doors between cargo spaces, are classed as follows:

(1) Class 1—Hinged door.

(2) Class 2—Sliding door, operated by hand gear only.

(3) Class 3—Sliding door, operated by power and by hand gear.

(b) The following types of watertight doors are not permitted:

(1) A plate door secured only by bolts; and

(2) A door required to be closed by dropping or by the action of dropping weights.

(c) Whenever a door of a particular class is prescribed by these regulations, a door of a class bearing a higher number may be used.

§ 170.255 Class 1 doors; permissible locations.

(a) Except as provided in paragraphs (b) and (c) of this section, Class 1 doors within passenger, crew, and working spaces are permitted only above a deck, the molded line of which, at its lowest point at side, is at least 7 feet (2.14 meters) above the deepest load line.

(b) Class 1 doors are permitted within passenger, crew, and working spaces, wherever located, if—

(1) In the judgment of the OCMI, the door is in a location where it will be closed at all times except when actually in use; and

(2) The vessel is less than 150 gross tons and will not proceed more than 20 nautical miles (37 kilometers) from shore; or

(3) The vessel is in rivers or lakes, bays, and sounds service.

(c) Class 1 doors are permitted in any location on a vessel that—

(1) Is less than 100 gross tons; and

(2) Will operate only in the offshore oil industry trade.

(d) Quick-acting Class 1 doors are permitted in any location on a vessel that operates on the Great Lakes and is required to meet the damage stability standards of subpart H of part 172 of this chapter.

(e) For vessels required to meet the damage stability standards of subpart H of this chapter, when Class 1 doors are installed below a deck the molded

line of which at its lowest point at side is less than 7 feet (2.14 meters) above the deepest load line, an indicator light for each door which warns when the door is open must be installed on the bridge.

[CGD 79-023, 48 FR 51010, Nov. 4, 1983, as amended by CGD 80-159, 51 FR 33059, Sept. 18, 1986]

§ 170.260 Class 2 doors; permissible locations.

(a) Except as provided in paragraphs (b) and (c) of this section, a Class 2 door is permitted only if—

(1) Its sill is above the deepest load line; and

(2) It is not a door described in § 170.265(d).

(b) If passenger spaces are located below the bulkhead deck, Class 2 doors with sills below the deepest load line may be used if—

(1) The number of watertight doors located below the deepest load line that are used intermittently during operation of the vessel does not exceed two, and;

(2) The doors provide access to or are within spaces containing machinery.

(c) If no passenger spaces are located below the bulkhead deck, Class 2 doors may be used if the number of watertight doors located below the deepest load line that are used intermittently during operation of the vessel does not exceed five.

(d) In determining whether Class 2 doors are allowed under paragraph (c) of this section, the watertight doors at the entrance to shaft tunnels need not be counted. If Class 2 doors are allowed under paragraph (c) of this section, the doors at the entrance to shaft tunnels may also be Class 2.

§ 170.265 Class 3 doors; required locations.

The following doors must always be Class 3:

(a) Doors in all locations not addressed in §§ 170.255 and 170.260.

(b) Doors between coal bunkers below the bulkhead deck that must be opened at sea.

(c) Doors into trunkways that pass through more than one main transverse watertight bulkhead if the door

sills are less than 2.14 meters above the deepest load line.

(d) Doors below a deck, the molded line of which, at its lowest point at side, is less than 2.14 meters (7 feet) above the deepest load line if—

(1) The vessel is engaged on a short international voyage as defined in § 171.010 of this subchapter; and

(2) The vessel is required by § 171.065 of this subchapter to have a factor of subdivision of 0.5 or less.

[CGD 79-023, 48 FR 51010, Nov. 4, 1983, as amended by CGD 85-080, 61 FR 944, Jan. 10, 1996; CGD 96-041, 61 FR 50734, Sept. 27, 1996]

§ 170.270 Door design, operation, installation, and testing.

(a) Each Class 1 door must have a quick action closing device operative from both sides of the door.

(b) Each Class 1 door on a vessel in ocean service must be designed to withstand a head of water equivalent to the depth from the sill of the door to the margin line but in no case less than 10 feet (3.05 meters).

(c) Each Class 2 and Class 3 door must—

(1) Be designed, constructed, tested, and marked in accordance with ASTM F 1196 (incorporated by reference, see § 170.015);

(2) Have controls in accordance with ASTM F 1197 (incorporated by reference, see § 170.015); and

(3) If installed in a subdivision bulkhead, meet Supplemental Requirements Nos. S1 and S3 of ASTM F 1196 (incorporated by reference, see § 170.015), unless the watertight doors are built in accordance with plans previously approved by the Coast Guard, in which case, only Supplemental Requirements Nos. S1 and S3.1.4 of ASTM F 1196 (incorporated by reference, see § 170.015) must be met. In either case, control systems for watertight doors must have power supplies, power sources, installation tests and inspection, and additional remote operating consoles in accordance with Supplemental Requirements Nos. S1 through S4 of ASTM F 1197 (incorporated by reference, see § 170.015).

(d) Installations of sliding watertight door assemblies must be in accordance with the following:

§ 170.275

(1) Before a sliding watertight door assembly is installed in a vessel, the bulkhead in the vicinity of the door opening must be stiffened. Such bulkhead stiffeners, or deck reinforcement where flush deck door openings are desired, must not be less than 6 inches nor more than 12 inches from the door frame so that an unstiffened diaphragm of bulkhead plating 6 to 12 inches wide is provided completely around the door frame. Where such limits cannot be maintained, alternative installations will be considered by the Marine Safety Center. In determining the scantlings of these bulkhead stiffeners, the door frame should not be considered as contributing to the strength of the bulkhead. Provision must also be made to adequately support the thrust bearings and other equipment that may be mounted on the bulkhead or deck.

(2) Sliding watertight door frames must be either bolted or welded watertight to the bulkhead.

(i) If bolted, a suitable thin heat and fire resistant gasket or suitable compound must be used between the bulkhead and the frame for watertightness. The bulkhead plating must be worked to a plane surface in way of the frame when mounting.

(ii) If welded, caution must be exercised in the welding process so that the door frame is not distorted.

(e) For each watertight door which is in a required subdivision bulkhead, an indicator light must be installed in the pilothouse and at each other vessel operating station from which the door is not visible. The indicator must show whether the door is open or closed.

[CGD 79-023, 48 FR 51010, Nov. 4, 1983, as amended by CGD 88-032, 56 FR 35828, July 29, 1991; CGD 85-080, 61 FR 944, Jan. 10, 1996; USCG-2000-7790, 65 FR 58464, Sept. 29, 2000]

§ 170.275 Special requirements for cargo space watertight doors.

(a) A door between cargo spaces—

(1) Must not be designed for remote operation;

(2) Must be located as high as practicable; and

(3) Must be located as far inboard of the side shell as practicable but in no case closer to the side shell than one-fifth of the beam of the vessel where

46 CFR Ch. I (10-1-14 Edition)

the beam is measured at right angles to the centerline of the vessel at the level of the deepest load line.

(b) If the door is accessible while the ship is in operation, it must have installed a lock or other device that prevents unauthorized opening.

(c) Before installing a watertight door in a cargo space, approval must be obtained from the Commanding Officer, Marine Safety Center.

[CGD 79-023, 48 FR 51010, Nov. 4, 1983, as amended by CGD 88-070, 53 FR 34537, Sept. 7, 1988]

Subpart I—Free Surface

§ 170.285 Free surface correction for intact stability calculations.

(a) When doing the intact stability calculations required by this subchapter, the virtual increase in the vessel's vertical center of gravity due to liquids in tanks must be determined by calculating—

(1) For each type of consumable liquid, the maximum free surface effect of at least one transverse pair of wing tanks or a single centerline tank; and

(2) The maximum free surface effect of each partially filled tank containing non-consumable liquids.

(b) For the purpose of paragraph (a)(1) of this section, the tank or combination of tanks selected must be those having the greatest free surface effect.

§ 170.290 Free surface correction for damage stability calculations.

(a) When doing the damage stability calculations required by this subchapter, the virtual increase in the vessel's vertical center of gravity due to liquids in tanks must be determined by calculating—

(1) For each type of consumable liquid, the free surface effect of at least one transverse pair of wing tanks or a single centerline tank; and

(2) The free surface effect of each partially filled tank containing other than consumable liquids.

(b) For the purpose of paragraph (a)(1) of this section, the tank or combination of tanks selected must be those having the greatest free surface effect.

Coast Guard, DHS

§ 170.295

(c) When doing the calculations in paragraph (a) of this section, the free surface effect of a liquid in a tank must be determined by—

- (1) Assuming the vessel is heeled five degrees from the vertical; or
- (2) Calculating the shift of the center of gravity of the liquid in the tank by the moment of transference method.

§ 170.295 Special consideration for free surface of passive roll stabilization tanks.

(a) The virtual increase in the vertical center of gravity due to a liquid in a roll stabilization tank may be calculated in accordance with paragraph (b) of this section if—

- (1) The virtual increase in the vertical center of gravity of the vessel is calculated in accordance with §170.285(a); and
 - (2) The slack surface in the roll stabilization tank is reduced during vessel motions because of the shape of the tank or the amount of liquid in the tank.
- (b) The virtual rise in the vertical center of gravity calculated in accordance with §170.285(a) for a stabilization tank may be reduced in accordance with the following equation:

$E.F.S.=(K)(F.F.S.)$

where—

- E.F.S.=the effective free surface.
- F.F.S.=the full free surface calculated in accordance with §170.285(a).
- K=the reduction factor calculated in accordance with paragraph (c) of this section.

(c) The factor (K) must be calculated as follows:

- (1) Plot $(I/d)\tan T$ on Graph 170.295 where—
 - (i) (I) is the moment of inertia of the free surface in the roll tank;
 - (ii) (d) is the density of the liquid in the roll tank; and
 - (iii) (T) is the angle of heel.
- (2) Plot the moments of transference of the liquid in the roll tank on Graph 170.295.
- (3) Construct a line A on Graph 170.295 so that the area under line A between $T = 0$ and the angle at which the deck edge is immersed or 28 degrees, whichever is smaller, is equal to the area under the curve of actual moments of transference between the same angles.
- (4) The factor (K) is calculated by determining the ratio of the ordinate of line A to the ordinate of the curve of $(I/d)\tan T$, both measured at the angle at which the deck edge is immersed or 28 degrees, whichever is smaller.

GRAPH 170.295
Special Free Surface Correction
for
Stabilization Tanks

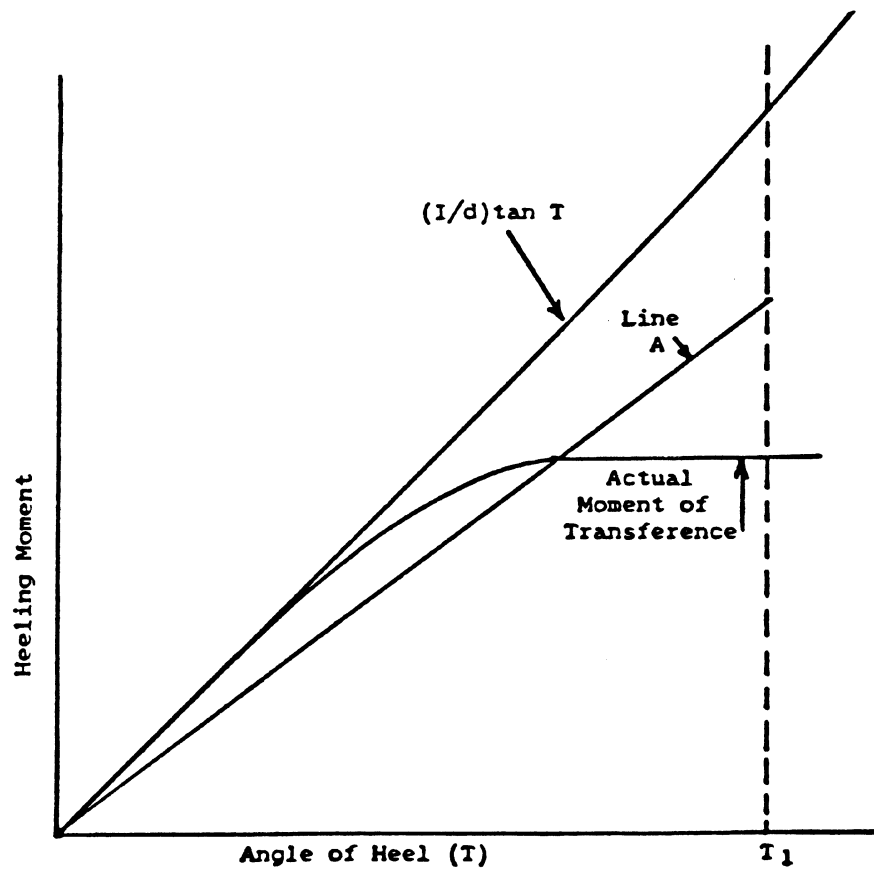

T_1 = the angle at which the deck edge is immersed or 28 degrees, whichever is smaller.

§ 170.300 Special consideration for free surface of spoil in hopper dredge hoppers.

The calculations required by this subchapter for each self-propelled hopper dredge must include—

(a) The free surface effect of consumable liquids and the free surface effect of the dredged spoil in the hoppers; and

(b) Either of the following assumptions when performing the calculations required by §174.310(b) of this chapter:

(1) If the dredged spoil is assumed to be jettisoned, the free surface of the dredged spoil may be disregarded.

(2) If the dredged spoil is not assumed to be jettisoned, the free surface of the dredged spoil must be calculated.

[CGD 76-080, 54 FR 36977, Sept. 6, 1989]

PART 171—SPECIAL RULES PERTAINING TO VESSELS CARRYING PASSENGERS

Subpart A—General

Sec.

- 171.001 Applicability.
- 171.010 Definitions.
- 171.012 Incorporation by reference.
- 171.015 Location of margin line.
- 171.017 One and two compartment standards of flooding.

Subpart B—Intact Stability

- 171.045 Weight of passengers and crew.
- 171.050 Passenger heel requirements for a mechanically propelled or a non-self propelled vessel.
- 171.052 Passenger heel requirements for pontoon vessels.
- 171.055 Intact stability requirements for a monohull sailing vessel or a monohull auxiliary sailing vessel.
- 171.057 Intact stability requirements for a sailing catamaran.

Subpart C—Subdivision and Damage Stability

- 171.060 Watertight subdivision: General.
- 171.065 Subdivision requirements—Type I.
- 171.066 Calculation of permeability for Type I subdivision.
- 171.067 Treatment of stepped and recessed bulkheads in Type I subdivision.
- 171.068 Special considerations for Type I subdivision for vessels on short international voyages.
- 171.070 Subdivision requirements—Type II.

- 171.072 Calculation of permeability for Type II subdivision.
- 171.073 Treatment of stepped and recessed bulkheads in Type II subdivision.
- 171.075 [Reserved]
- 171.080 Damage stability standards for vessels with Type I or Type II subdivision.

Subpart D—Additional Subdivision Requirements

- 171.085 Collision bulkhead.
- 171.090 Aft peak bulkhead.
- 171.095 Machinery space bulkhead.
- 171.100 Shaft tunnels and stern tubes.
- 171.105 Double bottoms.
- 171.106 Wells in double bottoms.
- 171.108 Manholes in double bottoms.
- 171.109 Watertight floors in double bottoms.

Subpart E—Penetrations and Openings in Watertight Bulkheads

- 171.110 Specific applicability.
- 171.111 Penetrations and openings in watertight bulkheads in vessels of 100 gross tons or more.
- 171.112 Watertight door openings.
- 171.113 Trunks.
- 171.114 Penetrations and openings in watertight bulkheads in a vessel less than a 100 gross tons.

Subpart F—Openings in the Side of a Vessel Below the Bulkhead or Weather Deck

- 171.115 Specific applicability.
- 171.116 Port lights.
- 171.117 Dead covers.
- 171.118 Automatic ventilators and side ports.
- 171.119 Openings below the weather deck in the side of a vessel less than 100 gross tons.

Subpart G—Watertight Integrity Above the Margin Line

- 171.120 Specific applicability.
- 171.122 Watertight integrity above the margin line in a vessel of 100 gross tons or more.
- 171.124 Watertight integrity above the margin line in a vessel less than 100 gross tons.

Subpart H—Drainage of Weather Decks

- 171.130 Specific applicability.
- 171.135 Weather deck drainage on a vessel of 100 gross tons or more.
- 171.140 Drainage of a flush deck vessel.
- 171.145 Drainage of a vessel with a cockpit.
- 171.150 Drainage of a vessel with a well deck.
- 171.155 Drainage of an open boat.

§ 171.001

AUTHORITY: 46 U.S.C. 2103, 3306; E.O. 12234, 45 FR 58801, 3 CFR, 1980 Comp., p. 277; Department of Homeland Security Delegation No. 0170.1.

SOURCE: CGD 79-023, 48 FR 51017, Nov. 4, 1983, unless otherwise noted.

Subpart A—General

§ 171.001 Applicability.

(a) Except as provided in paragraph (d) of this section, this part applies to passenger vessels inspected under subchapter K or H of this chapter, or a passenger vessel the stability of which is questioned by the Officer in Charge, Marine Inspection (OCMI).

(b) Specific sections of this part also apply to nautical school ships, sailing school vessels and oceanographic vessels. The applicable sections are listed in subparts C and D of part 173 of this chapter.

(c) Specific sections of this part may also apply to a small passenger vessel inspected under subchapter T of this chapter. The specific sections are listed in subparts B and C of part 178 of this chapter and in subpart B of part 179 of this chapter.

(d) Unless permitted otherwise, a passenger vessel constructed on or after January 1, 2009, and issued a SOLAS Passenger Ship Safety Certificate must meet the applicable requirements of IMO Res. MSC.216(82) (incorporated by reference, see § 171.012), instead of the requirements of this part. For the purposes of this section, the applicable requirements of IMO Res. MSC.216(82) are equivalent to the requirements of this part when applied to such vessels.

[CGD 79-023, 48 FR 51017, Nov. 4, 1983, as amended by CGD 83-005, 51 FR 923, Jan. 9, 1986; CGD 95-012, 60 FR 48052, Sept. 18, 1995; 60 FR 50120, Sept. 28, 1995; CGD 85-080, 61 FR 944, Jan. 10, 1996; USCG-2007-0030, 75 FR 78084, Dec. 14, 2010]

§ 171.010 Definitions.

(a) *Cockpit* means an exposed recess in the weather deck extending no more than one-half of the vessel's length over deck (LOD) measured over the weather deck.

(b) *Deepest subdivision load line* means the waterline that corresponds to the deepest draft permitted by the applica-

46 CFR Ch. I (10-1-14 Edition)

ble subdivision requirements in this part.

(c) *Equivalent plane bulkhead* means a bulkhead that is—

(1) Used in lieu of a recessed or stepped bulkhead when doing the subdivision calculations required in this part; and

(2) Located as shown in Figure 171.010(a).

(d) *Ferry* means a vessel that—

(1) Operates in other than ocean or coastwise service;

(2) Has provisions only for deck passengers or vehicles, or both;

(3) Operates on a short run on a frequent schedule between two points over the most direct water route;

(4) Offers a public service of a type normally attributed to a bridge or tunnel.

(e) *Freeing port* means any direct opening through the vessel's bulwark or hull to quickly drain overboard water which has been shipped on exposed decks.

(f) *Floodable length* means the length of a shell to shell segment of the vessel that, when flooded, will sink and trim the vessel until the margin line is tangent to the waterline.

(g) *Flush deck* means a continuous weather deck located at the uppermost sheer line of the hull.

(h) *International voyage* has the same meaning provided for the term in § 70.05-10 of this chapter.

(i) *Machinery space* means, unless otherwise prescribed by the Commandant for unusual arrangements, the space extending from the molded base line to the margin line and between the main transverse watertight bulkheads bounding the following spaces:

(1) Each space containing main and auxiliary propelling machinery.

(2) Each space containing propulsion boilers.

(3) Each space containing permanent coal bunkers.

(j) *Open boat* means a vessel not protected from entry of water by means of a complete deck, or by a combination of a partial weather deck and superstructure which is seaworthy for the waters upon which the vessel operates.

Coast Guard, DHS

§ 171.010

(k) *Passenger space* means a space which is provided for the accommodation and use of passengers, other than a baggage, store, provision or mail room.

(1) *Recessed bulkhead* means a bulkhead that is recessed as shown by bulkhead B in Figure 171.010(b).

(m) *Small passenger vessel* means a vessel of less than 100 gross tons—

(1) Carrying more than 6 passengers, including at least one passenger for hire;

(2) That is chartered with the crew provided or specified by the owner or owner's representative and carrying more than 6 passengers;

(3) That is chartered with no crew provided or specified by the owner or owner's representative and carrying more than 12 passengers; or

(4) That is a submersible vessel carrying at least one passenger for hire.

(n) *Short international voyage* means an international voyage where—

(1) A vessel is not more than 200 nautical miles (370 kilometers) from a port or place in which the passengers and crew could be placed in safety; and

(2) The total distance between the last port of call in the country in which the voyage began and the final port of destination does not exceed 600 nautical miles (1111 kilometers).

(o) *Scupper* means a pipe or tube of at least 30 millimeters (1.25 inches) in diameter leading down from a deck or sole and through the hull to drain water overboard.

(p) *Stepped bulkhead* means a bulkhead that is stepped as shown by bulkhead A in Figure 171.010(b).

Figure 171.010(a)

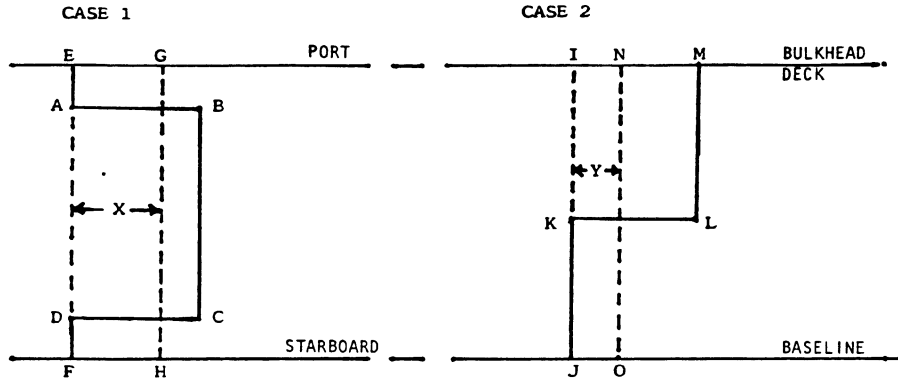

Case 1: $X = V/A$
where-

- X = Distance between EF and the equivalent plane bulkhead GH.
- V = Volume of the space directly below ABCD and extending to the shell.
- A = Sectional area midway between EF and GH.

Case 2: $Y = V/A$
where-

- Y = Distance between IJ and the equivalent plane bulkhead NO.
- V = Volume of the space directly below IKLM and extending to the shell.
- A = Sectional area midway between IJ and NO.

Figure 171.010(b)

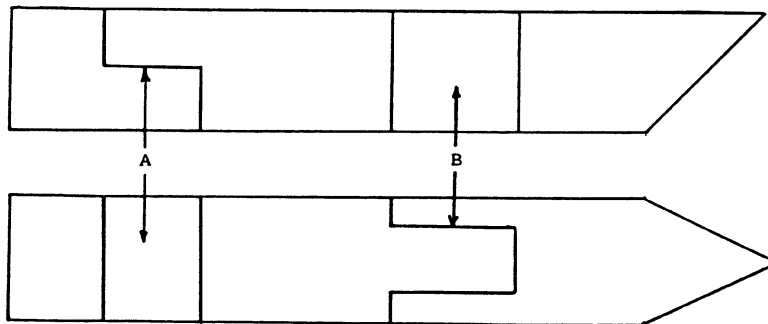

(q) *Well deck* means a weather deck fitted with solid bulwarks that impede the drainage of water over the sides or an exposed recess in the weather deck extending one-half or more of the

length of the vessel (LOD) measured over the weather deck.

[CGD 79-023, 48 FR 51017, Nov. 4, 1983, as amended by CGD 85-080, 61 FR 944, Jan. 10, 1996]

§ 171.012 Incorporation by reference.

(a) Certain material is incorporated by reference into this part with the approval of the Director of the Federal Register under 5 U.S.C. 552(a) and 1 CFR part 51. To enforce any edition other than that specified in this section, the Coast Guard must publish a notice of change in the FEDERAL REGISTER and the material must be available to the public. All approved material is available for inspection at the National Archives and Records Administration (NARA). For information on the availability of this material at NARA, call 202-741-6030 or go to http://www.archives.gov/federal_register/code_of_federal_regulations/ibr_locations.html. It is also available for inspection at the Coast Guard Headquarters. Contact Commandant (CG-ENG-2), Attn: Naval Architecture Division, U.S. Coast Guard Stop 7509, 2703 Martin Luther King Jr. Avenue SE., Washington, DC 20593-7509. The material is also available from the source listed in paragraph (b) of this section.

(b) International Maritime Organization (IMO), Publications Section, 4 Albert Embankment, London SE1 7SR, United Kingdom, +44 (0)20 7735 7611, <http://www.imo.org/>.

(1) Resolution MSC.216(82), Amendments to the International Convention

for the Safety of Life At Sea, 1974, As Amended (IMO Res. MSC.216(82), Adopted on 8 December 2006, incorporation by reference (IBR) approved for §§171.001 and 171.080.

(2) Resolution MSC 267(85), Adoption of the International Code on Intact Stability, 2008 (2008 IS Code), Adopted on 4 December 2008, IBR approved for §171.050.

[USCG-2007-0030, 75 FR 78085, Dec. 14, 2010, as amended by USCG-0832, 77 FR 59788, Oct. 1, 2012; USCG-2013-0671, 78 FR 60163, Sept. 30, 2013]

§ 171.015 Location of margin line.

(a) A vessel with a continuous bulkhead deck and sufficient sheer. If the average value of the sheer at the forward perpendicular (FP) and the after perpendicular (AP) is at least 12 inches (30.5 cm), the margin line must be located no less than 3 inches (7.6 cm) below the upper surface of the bulkhead deck at side as illustrated in Figure 171.015(a).

TABLE 171.015

Average value of sheer at FP and AP in inches (cm)	Required position of margin line below top of deck amidships in inches (cm)
12 (30.5)	3 (7.6)
6 (15.2)	6 (15.2)
0	9 (22.8)

Figure 171.015(a)

Margin Line for a Vessel With a Continuous Bulkhead Deck and With an Average Value of Sheer at the FP and AP of at Least 12 Inches (30.5 cm)

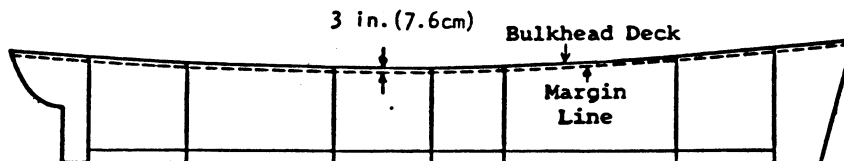

§ 171.015

46 CFR Ch. I (10-1-14 Edition)

(b) A vessel with a continuous bulkhead deck and insufficient sheer. If the average value of the sheer at the forward perpendicular (FP) and the after perpendicular (AP) is less than 12 inches (30.5 cm), the margin line must be a parabolic curve with the following characteristics:

(1) The parabolic curve must be at least 3 inches (7.6 cm) below the upper

surface of the bulkhead deck at the FP and AP.

(2) The parabolic curve must be at least the distance given in Table 171.015 below the surface of the bulkhead deck amidships.

(3) Intermediate values not shown in Table 171.015 must be interpolated.

(4) Figure 171.015(b) illustrates a margin line drawn in this manner.

Figure 171.015(b)

Margin Line for a Vessel With a Continuous Bulkhead Deck and With an Average Value of Sheer at the FP and AP Less Than 12 Inches (30.5 cm)

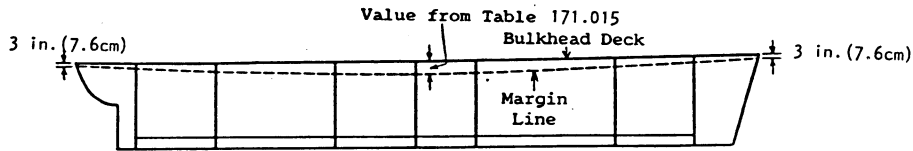

(c) A vessel with a discontinuous bulkhead deck. A continuous margin line must be drawn that is no more than 3

inches (7.6 cm) below the upper surface of the bulkhead deck at side as illustrated in Figure 171.015(c).

Figure 171.015(c)

Margin Line for a Vessel With a Discontinuous Bulkhead Deck

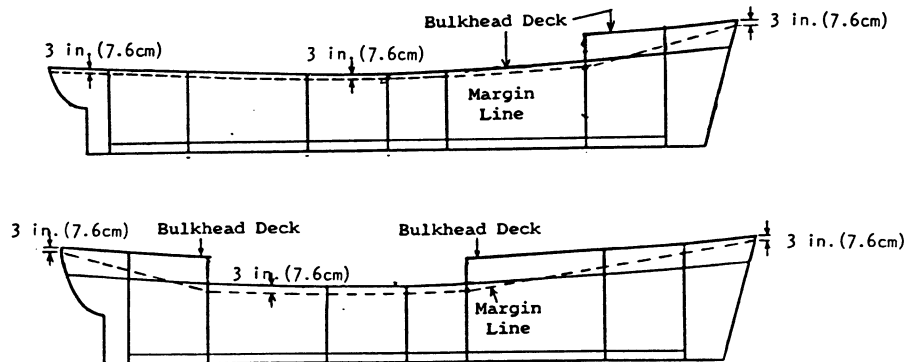

(d) A vessel with a discontinuous bulkhead deck where the side shell is carried watertight to a higher deck. A continuous margin line must be drawn as illustrated in Figure 171.015(d).

Figure 171.015(d)
Margin Line for a Vessel With a Discontinuous Bulkhead Deck and With Side Shell Watertight to a Higher Deck

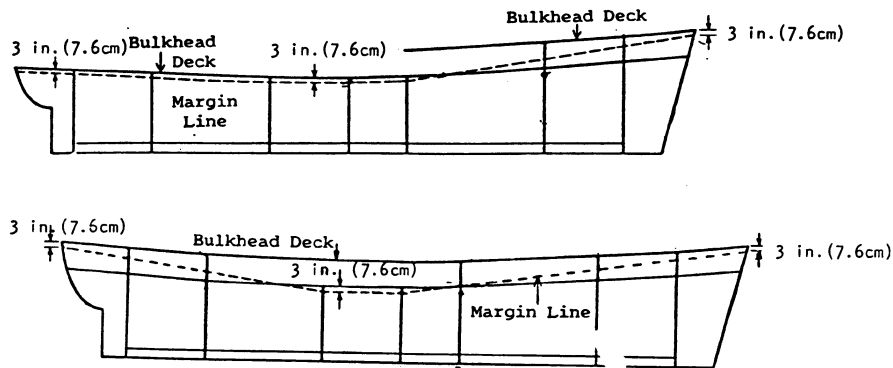

§ 171.017 One and two compartment standards of flooding.

(a) *One compartment standard of flooding.* A vessel is designed to a one compartment standard of flooding if the margin line is not submerged when the total buoyancy between each set of two adjacent main transverse watertight bulkheads is lost.

(b) *Two compartment standard of flooding.* A vessel is designed to a two compartment standard of flooding if the margin line is not submerged when the total buoyancy between each set of three adjacent main transverse watertight bulkheads is lost.

Subpart B—Intact Stability

§ 171.045 Weight of passengers and crew.

(a) This section applies to each vessel, regardless of when constructed.

(b) Compliance with the intact stability requirements applicable to each vessel, using a total weight of passengers and crew carried, is based upon an Assumed Average Weight per Per-

son, which is determined in accordance with § 170.090 of this chapter.

[USCG-2007-0030, 75 FR 78085, Dec. 14, 2010]

§ 171.050 Passenger heel requirements for a mechanically propelled or a non-self propelled vessel.

(a) Each mechanically propelled or non-self propelled vessel other than a pontoon vessel must be shown by design calculations, in each condition of loading and operation, to have a metacentric height (GM) in feet (meters) of not less than the value given by the following equation:

$$GM = [(W/\Delta)(\frac{2}{3})(b)]/(\tan(T))$$

Where—

Δ = displacement of the vessel in long (metric) tons.

W = total weight in long (metric) tons of persons other than required crew, including personal effects of those persons expected to be carried on the vessel.

T = 14 degrees or the angle of heel at which the deck edge is first submerged, whichever is less; and

b = distance in feet (meters) from the centerline of the vessel to the geometric center of the passenger deck on one side of the centerline.

§ 171.052

(b) The criteria specified in paragraph (a) of this section are limited in application to the conditions of loading and operation of vessels for which the righting arm (GZ) at the angle (T), calculated after the vessel is permitted to trim free until the trimming moment is zero, is not less than the minimum metacentric height (GM) calculated in paragraph (a) of this section multiplied by sin(T). In conditions not meeting this requirement, the Coast Guard Marine Safety Center requires calculations in addition to those in this section.

(c) A vessel that complies with the requirements for passenger ships contained in the International Code of Intact Stability, 2008 (2008 IS Code) (incorporated by reference, see §171.012) need not comply with paragraphs (a) or (b) of this section. Vessels complying with the 2008 IS Code must use the Assumed Average Weight per Person obtained according to §170.090 of this title to be exempt from the other requirements of this section.

[USCG-2007-0030, 75 FR 78085, Dec. 14, 2010]

§ 171.052 Passenger heel requirements for pontoon vessels.

(a) Each pontoon vessel, in each condition of loading and operation, must have an area under the righting arm curve from the angle of equilibrium to an angle of 40 degrees, the downflooding angle, or the angle of the maximum righting arm, whichever is less, of at least:

(1) For operation on exposed or partially protected waters—

(i) 10 foot-degrees with a crowding density of 5 square feet per person (2.15 persons per square meter); and

(ii) 7 foot-degrees with a crowding density of 2 square feet per person (5.38 persons per square meter); and

(2) For operation on protected waters—

(i) 5 foot-degrees with a crowding density of 5 square feet per person (2.15 persons per square meter); and

(ii) 2 foot-degrees with a crowding density of 2 square feet per person (5.38 persons per square meter).

(b) When assessing compliance with the criteria of this section, passengers are assumed to be distributed in all areas accessible to passengers so as to

46 CFR Ch. I (10-1-14 Edition)

produce the most unfavorable combination of heel and trim.

[USCG-2007-0030, 75 FR 78085, Dec. 14, 2010]

§ 171.055 Intact stability requirements for a monohull sailing vessel or a monohull auxiliary sailing vessel.

(a) Except as specified in paragraph (b) of this section, each monohull sailing vessel and auxiliary sailing vessel must be shown by design calculations to meet the stability requirements in this section.

(b) Additional or different stability requirements may be needed for a vessel of unusual form, proportion, or rig. The additional requirements, if needed, will be prescribed by the Commandant.

(c) Each vessel must have positive righting arms in each condition of loading and operation from—

(1) 0 to at least 70 degrees of heel for service on protected or partially protected waters; and

(2) 0 to at least 90 degrees of heel for service on exposed waters.

(d) Each vessel must be designed to satisfy the following equations:

(1) For a vessel in service on protected or partially protected waters—

$$\frac{1000(W)HZA}{(A)(H)} \geq X$$

$$\frac{1000(W)HQB}{(A)(H)} \geq Y$$

$$\frac{1000(W)HQC}{(A)(H)} \geq Z$$

where—

X=1.0 long tons/sq. ft. (10.9 metric tons/sq. meter).

Y=1.1 long tons/sq. ft. (12.0 metric tons/sq. meter).

Z=1.25 long tons/sq. ft. (13.7 metric tons/sq. meter).

(2) For a vessel on exposed waters—

$$\frac{1000(W)HZA}{(A)(H)} \geq X$$

$$\frac{1000(W)HZB}{(A)(H)} \geq Y$$

$$\frac{1000(W)HZC}{(A)(H)} \geq Z$$

where—

HZA, HZB, and HZC are calculated in the manner specified in paragraph (e) or (f) of this section.

X=1.5 long tons/sq. ft. (16.4 metric tons/sq. meter).

Y=1.7 long tons/sq. ft. (18.6 metric tons/sq. meter).

Z=1.9 long tons/sq. ft. (20.8 metric tons/sq. meter).

A=the projected lateral area or silhouette in square feet (meters) of the portion of the vessel above the waterline computed with all sail set and trimmed flat. Sail overlap areas need not be included except parachute type spinnakers which are to be added regardless of overlap.

H=the vertical distance in feet (meters) from the center of A to the center of the underwater lateral area or approximately to the one-half draft point.

W=the displacement of the vessel in long (metric) tons.

(e) Except as provided in paragraph (f) of this section, HZA, HZB, and HZC must be determined as follows for each condition of loading and operation:

(1) Plot the righting arm curve on Graphs 171.055 (b), (c), and (d) or (e).

(2) If the angle at which the maximum righting arm occurs is less than 35 degrees, the righting arm curve must be truncated as shown on Graph 171.055(a).

(3) Plot an assumed heeling arm curve on Graph 171.055(b) that satisfies the following conditions:

(i) The assumed heeling arm curve must be defined by the equation—

$$HZ=HZA \cos^2 (T)$$

where—

HZ=heeling arm.

HZA=heeling arm at 0 degrees of heel.

T=angle of heel.

(ii) The first intercept shown on Graph 171.055(b) must occur at the angle of heel corresponding to the angle at which deck edge immersion first occurs.

(4) Plot an assumed heeling arm curve on Graph 171.055(c) that satisfies the following conditions:

(i) The assumed heeling arm curve must be defined by the equation—

$$HZ=HZB \cos^2 (T)$$

where—

HZ=heeling arm.

HZB=heeling arm at 0 degrees of heel.

T=angle of heel.

(ii) The area under the assumed heeling arm curve between 0 degrees and the downflooding angle or 60 degrees, whichever is less, must be equal to the area under the righting arm curve between the same limiting angles.

(5) Plot an assumed heeling arm curve on Graph 171.055 (d) or (e) that satisfies the following conditions:

(i) The assumed heeling arm curve must be defined by—

$$HZ=HZC \cos^2 (T)$$

where—

HZ=heeling arm.

HZC=heeling arm at 0 degrees of heel.

T=angle of heel.

(ii) The area under the assumed heeling arm curve between the angles of 0 and 90 degrees must be equal to the area under the righting arm curve between 0 degrees and—

(A) 90 degrees if the righting arms are positive to an angle less than or equal to 90 degrees; or

(B) The largest angle corresponding to a positive righting arm but no more than 120 degrees if the righting arms are positive to an angle greater than 90 degrees.

(6) The values of HZA, HZB, and HZC are read directly from Graphs 171.055 (b), (c), and (d) or (e).

(f) For the purpose of this section, the downflooding angle means the static angle from the intersection of the vessel's centerline and waterline in calm water to the first opening that cannot be rapidly closed watertight.

(g) HZB and, if the righting arms are positive to an angle of 90 degrees or greater, HZC may be computed from the following equation:

§ 171.055

46 CFR Ch. I (10-1-14 Edition)

$$\text{HZB (or HZC)} = \frac{I}{((T/2) + 14.3 \sin 2T)}$$

where—

I=the area under the righting arm curve to—
 (1) the downflooding angle or 60 degrees,
 whichever is less, when computing HZB;
 or

(2) the largest angle corresponding to a
 positive righting arm or 90 degrees,
 whichever is greater, but no greater than
 120 degrees when computing HZC.

T=the downflooding angle or 60 degrees,
 whichever is less, when computing HZB
 or 90 degrees when computing HZC.

GRAPH 171.055(a)

Truncation of Righting Arm Curve if Maximum Righting
 Arm Occurs at an Angle of Heel Less Than 35 Degrees

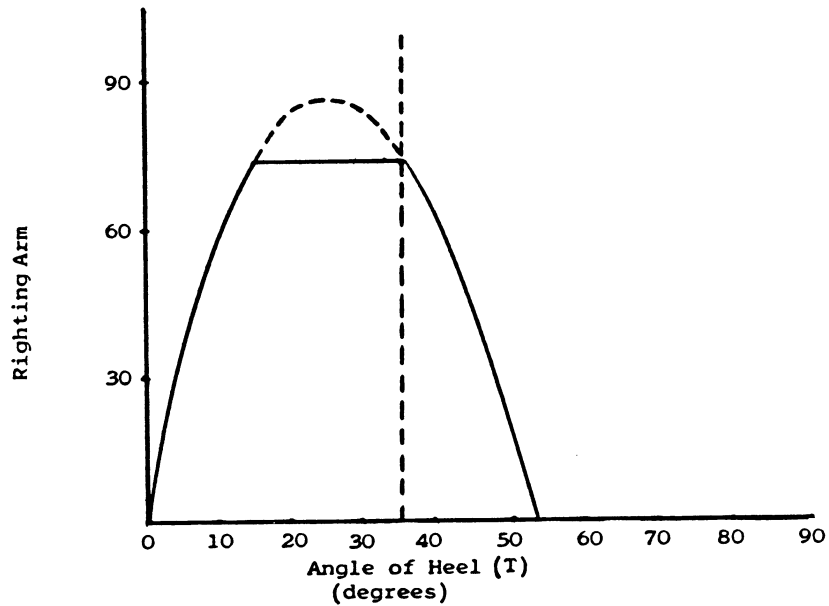

GRAPH 171.055(b)

First Intercept Occurs at the Angle at Which Deck
Edge Immersion First Occurs

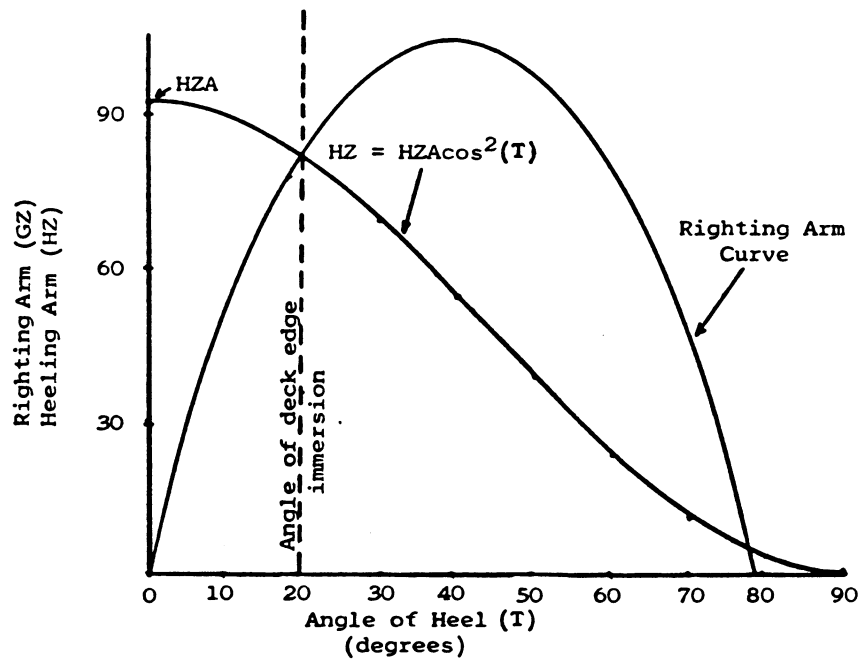

GRAPH 171.055(c)

Shaded Areas are Balanced to the Downflooding Angle

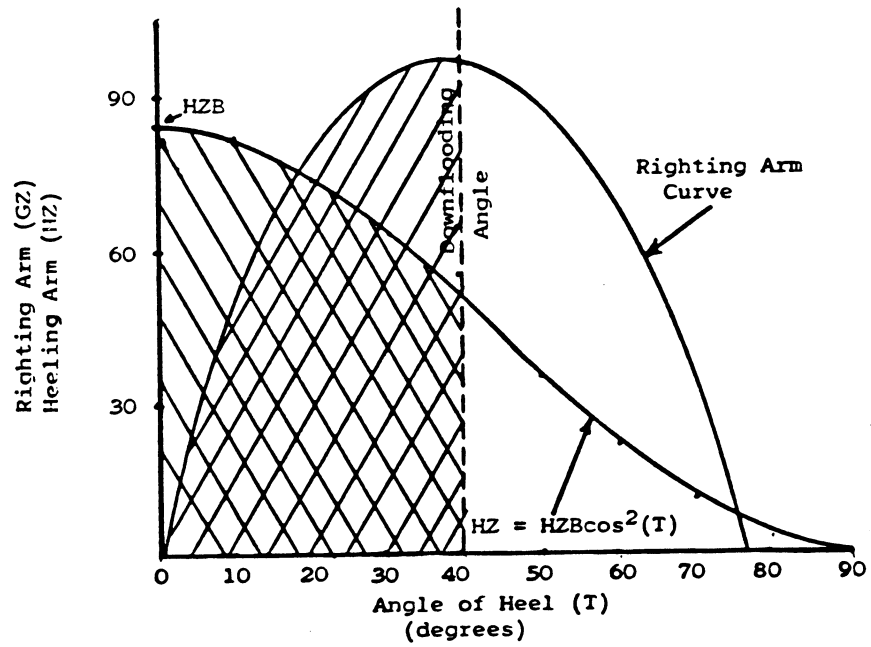

GRAPH 171.055(d)

Righting Arm Curve is not Positive to 90 Degrees and Negative Area is Included

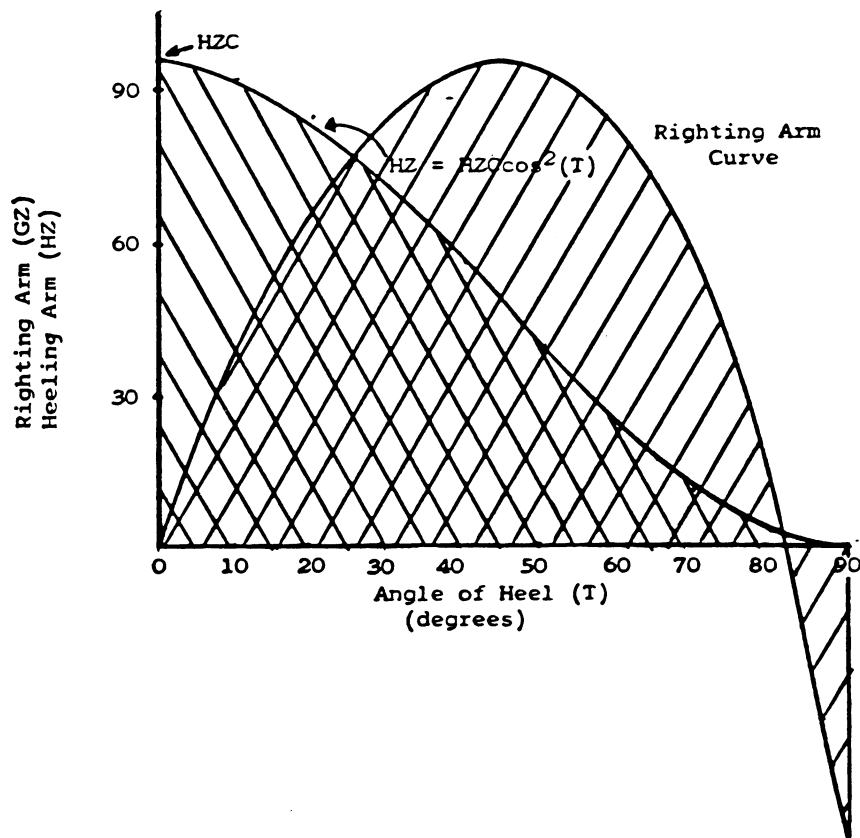

GRAPH 171.055(e)

Righting Arm Curve is Positive Beyond 90 Degrees

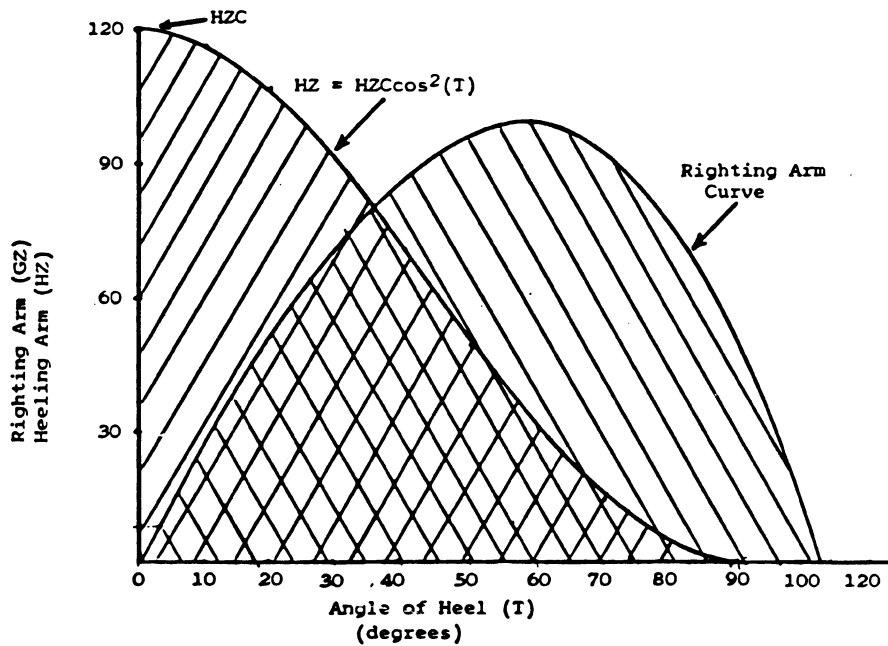

[CGD 79-023, 48 FR 51017, Nov. 4, 1983, as amended by CGD 83-005, 51 FR 924, Jan. 9, 1986]

§ 171.057 Intact stability requirements for a sailing catamaran.

(a) A sailing vessel that operates on protected waters must be designed to satisfy the following equation:

$$\frac{0.1(W)B}{(As)(Hc)} \geq X$$

Where—

B=the distance between hull centerlines in meters (feet).

As=the maximum sail area in square meters (square feet).

Hc=the height of the center of effort of the sail area above the deck, in meters (feet).

W=the total displacement of the vessel, in kilograms (pounds).

X=4.88 kilograms/square meter (1.0 pounds/square foot).

(b) A sailing vessel that operates on partially protected or exposed waters must be designed to satisfy the following equation:

$$\frac{0.1(W)B}{(As)(Hc)} \geq X$$

Where—

B=the distance between hull centerlines in meters (feet).

As=the maximum sail area in square meters (square feet).

Hc=the height of the center of effort of the sail area above the deck, in meters (feet).

W=the total displacement of the vessel, in kilograms (pounds).

X=7.32 kilograms/square meter (1.5 pounds/square foot).

[CGD 79-023, 48 FR 51017, Nov. 4, 1983, as amended by CGD 83-005, 51 FR 924, Jan. 9, 1986; CGD 85-080, 61 FR 944, Jan. 10, 1996]

Subpart C—Subdivision and Damage Stability

§ 171.060 Watertight subdivision: General.

(a) Each of the following vessels must be shown by design calculations to comply with the requirements in §§ 171.065 through 171.068 for Type I subdivision:

(1) Each vessel 100 gross tons or more on an international voyage; and

(2) Each vessel 150 gross tons or more in ocean service.

(b) Each vessel not described in paragraph (a) of this section must be shown by design calculations to comply with the requirements in §§ 171.070 to 171.073 for Type II subdivision.

(c) Except as allowed in § 171.070(c), each vessel must have a collision bulkhead.

(d) Each double-ended ferry that is required by paragraph (c) of this section to have a collision bulkhead must also have a second collision bulkhead. One collision bulkhead must be located in each end of the vessel.

[CGD 79-023, 48 FR 51017, Nov. 4, 1983, as amended by USCG-2007-0030, 75 FR 78085, Dec. 14, 2010]

§ 171.065 Subdivision requirements—Type I.

(a) Except as provided in paragraphs (c) and (f) of this section, the separation between main transverse watertight bulkheads on a vessel, other than one described in paragraph (b) of this section, must not exceed—

(floodable length)×(factor of subdivision)

where—

the factor of subdivision is listed under FS in Table 171.065(a).

(b) The factor of subdivision used to determine compliance with paragraph (a) of this section must be the smaller of 0.5 or the value determined from Table 171.065(a) if—

(1) The vessel is 430 feet (131 meters) or more in LBP; and

(2) The greater of the values of Y as determined by the following equations equals or exceeds the value of X in Table 171.065(b):

$$Y = \frac{(M + 2P)}{V}$$

or

$$Y = (M + 2P1)/(V + P1 - P)$$

where—

M, V, and P have the same value as listed in Table 171.065(a); and

P1=the smaller of the following:

(i) 0.6LN (0.056LN) where—

N=the total number of passengers; and

L=LBP in feet (meters).

(ii) The greater of the following:

(A) 0.4LN (0.037LN).

(B) The sum of P and the total volume of passenger spaces above the margin line.

(c) The distance A in Figure 171.065 between main transverse watertight bulkheads may exceed the maximum allowed by paragraphs (a) or (b) of this section if each of the distances B and C between adjacent main transverse watertight bulkheads in Figure 171.065 does not exceed the smaller of the following:

(1) The floodable length.

(2) Twice the separation allowed by paragraphs (a) or (b) of this section.

(d) In each vessel 330 feet (100 meters) or more in LBP, one of the main transverse watertight bulkheads aft of the collision bulkhead must be located at a distance from the forward perpendicular that is not greater than the maximum separation allowed by paragraph (a) or (b) of this section.

(e) The minimum separation between two adjacent main transverse watertight bulkheads must be at least 10 feet (3.05 meters) plus 3 percent of the LBP of the vessel, or 35 feet (10.7 meters), whichever is less.

(f) The maximum separation of bulkheads allowed by paragraphs (a) or (b) of this section may be increased by the

§ 171.065

46 CFR Ch. I (10-1-14 Edition)

amount allowed in paragraph (g) of this section if—

(1) The space between two adjacent main transverse watertight bulkheads contains internal watertight volume; and

(2) After the assumed side damage specified in paragraph (h) of this section is applied, the internal watertight volume will not be flooded.

(g) For the purpose of paragraph (f) of this section, the allowable increase in separation is as follows:

$$\text{Increase in separation} = \frac{\text{"total volume of allowed local subdivision"}}{\text{"transverse sectional area at center of compartment"}}$$

where—

“total volume of allowed local subdivision” is determined by calculating the unflooded volume on each side of the centerline and multiplying the smaller volume by two.

(h) The assumed extents of side damage are as follows:

(1) *The longitudinal extent of damage* must be assumed to extend over a length equal to the minimum spacing of bulkheads specified in paragraph (e) of this section.

(2) *The transverse extent of damage* must be assumed to penetrate a distance from the shell plating equal to one-fifth the maximum beam of the vessel and at right angles to the centerline at the level of the deepest subdivision load line.

(3) *The vertical extent of damage* must be assumed to extend vertically from the baseline to the margin line.

(i) The maximum separation between the following bulkheads must not exceed the maximum separation between main transverse watertight bulkheads:

(1) The collision bulkhead and the first main transverse watertight bulkhead aft of the collision bulkhead; and

(2) The last main transverse watertight bulkhead and the aftermost point on the bulkhead deck.

(j) The minimum separation between the following bulkheads must not be less than the minimum separation between main transverse watertight bulkheads:

(1) The collision bulkhead and the first main transverse watertight bulkhead aft of the collision bulkhead; and

(2) The last main transverse watertight bulkhead and the aftermost point on the bulkhead deck.

Figure 171.065

Combined Separation of Bulkheads

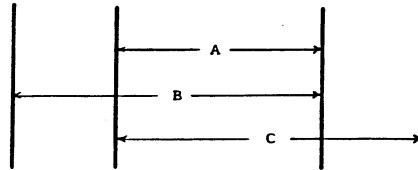

TABLE 171.065(a) (ENGLISH UNITS)

Vessel length (LBP)	Criterion numeral (CN)	FS
Vessel length greater than 392 feet.	CN less than or equal to 23.	A
	CN greater than 23 and less than 123.	F1
	CN greater than or equal to 123.	B
Vessel length greater than or equal to 200 feet and less than or equal to 392 feet.	CN less than or equal to S.	1
	CN greater than S and less than 123.	F2
Vessel length less than 200 feet.	CN greater than or equal to 123.	B
	1

Where—

FS=the factor of subdivision.
 $CN=60((M+2P)/V)+30000(N/L^2)$
 $A=(190/(L-160))+0.18$
 $B=(94/(L-85))+0.18$
 $F1=A - ((A-B)(CN-23)/100)$
 $S=(10904-25L)/48$
 $F2=1 - ((1-B)(CN-S)/(123-S))$
 L=the length of the vessel (LBP) in feet.

M=the sum of the volume of the machinery space and the volumes of any fuel tanks which are located above the inner bottom forward or aft of the machinery space in cubic feet.

P=the volume of passenger spaces below the margin line.

V=the volume of the vessel below the margin line.

N=the number of passengers that the vessel is to be certificated to carry.

TABLE 171.065(a) (METRIC UNITS)

Vessel length (LBP)	Criterion numeral (CN)	FS
Vessel length greater than 120 meters.	CN less than or equal to 23	A
	CN greater than 23 and less than 123.	F1
Vessel length greater than or equal to 61 meters and less than or equal to 120 meters.	CN greater than or equal to 123.	B
	CN less than or equal to S	1
Vessel length greater than or equal to 61 meters and less than or equal to 120 meters.	CN greater than S and less than 123.	F2
	CN greater than or equal to 123.	B
Vessel length less than 61 meters.	1

Where—
 FS—the factor of subdivision.
 $CN = 60((M+2P)/V) + 2787/(NL^2)$
 $A = (58/(L-49)) + 0.18$
 $B = (29/(L-26)) + 0.18$
 $F1 = A - ((A - B)(CN - 23)/100)$
 $S = (3323.5 - 25L)/14.6$
 $F2 = 1 - ((1 - B)(CN - S)/(123 - S))$
 L—the length of the vessel (LBP) in meters.
 M—the sum of the volume of the machinery space and the volumes of any fuel tanks which are located above the inner bottom forward or aft of the machinery space in cubic meters.
 P—the volume of passenger spaces below the margin line.
 V—the volume of the vessel below the margin line.
 N—the number of passengers that the vessel is to be certificated to carry.

TABLE 171.065(b)—TABLE OF X

Vessel LBP in feet (meters)	X ¹
430 (131)	1.336
440 (134)	1.285
450 (137)	1.230
460 (140)	1.174
470 (143)	1.117
480 (146)	1.060
490 (149)	1.002
500 (152)	0.944
510 (155)	0.885
520 (158)	0.826
530 (162)	0.766
540 (165)	0.706
550 (168)	0.645
554 (169) and up	0.625

¹ Interpolate for intermediate values.

[CGD 79-023, 48 FR 51017, Nov. 4, 1983, as amended by USCG-2007-0030, 75 FR 78085, Dec. 14, 2010]

§ 171.066 Calculation of permeability for Type I subdivision.

(a) Except as prescribed in paragraph (b) of this section, the following permeabilities must be used when doing the calculations required to demonstrate compliance with § 171.065(a), (b), and (c):

(1) When doing calculations required to demonstrate compliance with § 171.065(a) and (b), the uniform average

permeability given by the formulas in Table 171.066 must be used.

(2) When doing calculations required to demonstrate that compartments on opposite sides of a main transverse watertight bulkhead that bounds the machinery space comply with § 171.065(c), the mean of the uniform average permeabilities determined from Table 171.066 for the two compartments must be used.

(b) If an average permeability can be calculated that is less than that given by the formulas in Table 171.066, the lesser value may be substituted if approved by the Commanding Officer, Marine Safety Center. When determining this lesser value, the following permeabilities must be used:

(1) 95% for passenger, crew, and all other spaces that, in the full load condition, normally contain no cargo, stores, provisions, or mail.

(2) 60% for cargo, stores, provisions, or mail spaces.

(3) 85% for spaces containing machinery.

(4) Values approved by the Commanding Officer, Marine Safety Center for double bottoms, oil fuel, and other tanks.

(c) In the case of unusual arrangements, the Commanding Officer, Marine Safety Center may require a detailed calculation of average permeability for the portions of the vessel forward or aft of the machinery spaces. When doing these calculations, the permeabilities specified in paragraph (b) of this section must be used.

(d) When calculating permeability, the total volume of the 'tween deck spaces between two adjacent main transverse watertight bulkheads that contains any passenger or crew space must be regarded as passenger space volume, except that the volume of any space that is completely enclosed in steel bulkheads and is not a crew or passenger space may be excluded.

TABLE 171.066—TABLE OF UNIFORM AVERAGE PERMEABILITIES

Location	Uniform average permeability
Machinery space	$85 + \frac{10(a-c)}{v}$
	35(a)

§ 171.067

TABLE 171.066—TABLE OF UNIFORM AVERAGE PERMEABILITIES—Continued

Location	Uniform average permeability
Volume forward of machinery space	63+ _____ v
Volume aft of machinery space	35(a) 63+ _____ v

For each location specified in this table—
a=volume below the margin line of all spaces that, in the full load condition, normally contain no cargo, baggage, stores, provisions, or mail.
c=volume below the margin line of the cargo, stores, provisions, or mail spaces within the limits of the machinery space.
v=total volume below the margin line.

[CGD 79–023, 48 FR 51017, Nov. 4, 1983, as amended by CGD 88–070, 53 FR 34537, Sept. 7, 1988; USCG–2014–0688, 79 FR 58287, Sept. 29, 2014]

§ 171.067 Treatment of stepped and recessed bulkheads in Type I subdivision.

(a) For the purpose of this section—

(1) The main transverse watertight bulkhead immediately forward of a stepped bulkhead is referred to as bulkhead 1; and

(2) The main transverse watertight bulkhead immediately aft of the stepped bulkhead is referred to as bulkhead 3.

(b) If a main transverse watertight bulkhead is stepped, it and bulkheads 1 and 3 must meet one of the following conditions:

(1) The separation between bulkheads 1 and 3 must not exceed the following:

(i) If the factor of subdivision (F'S) determined from §171.065 (a) or (b) is greater than 0.9, the distance between bulkheads 1 and 3 must not exceed the maximum separation calculated to demonstrate compliance with §171.065.

(ii) If the factor of subdivision is 0.9 or less, the distance between bulkheads 1 and 3 must not exceed 90% of the floodable length or twice the maximum bulkhead separation calculated to demonstrate compliance with §171.065, whichever is smaller.

(2) Additional watertight bulkheads must be located as shown in Figure 171.067(a) so that distances A, B, C, and D, illustrated in Figure 171.067(a), satisfy the following:

(i) Distances A and B must not exceed the maximum spacing allowed by §171.065.

(ii) Distances C and D must not be less than the minimum separation prescribed by §171.065(e).

(3) The distance A, illustrated in Figure 171.067(b), must not exceed the maximum length determined in §171.065 corresponding to a margin line taken 3 inches (7.6 cm) below the step.

(c) A main transverse bulkhead may not be recessed unless all parts of the recess are inboard from the shell of the vessel a distance A as illustrated in Figure 171.067(c).

(d) Any part of a recess that lies outside the limits defined in paragraph (c) of this section must be treated as a step in accordance with paragraph (b) of this section.

(e) The distance between a main transverse watertight bulkhead and the transverse plane passing through the nearest portion of a recessed bulkhead must be greater than the minimum separation specified by §171.065(e).

(f) If a main transverse bulkhead is stepped or recessed, equivalent plane bulkheads must be used in the calculations required to demonstrate compliance with §171.065.

Figure 171.067(a)
Additional Subdivision

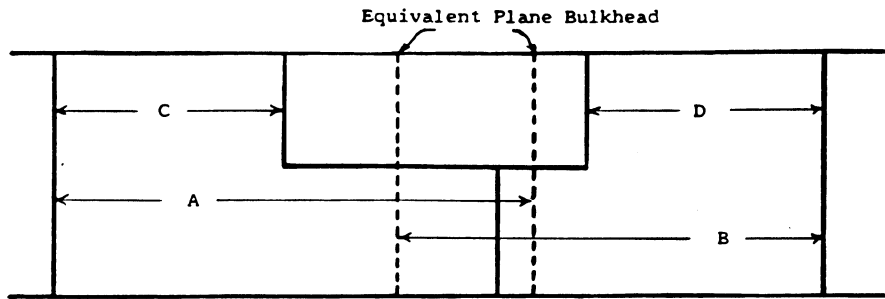

Figure 171.067(b)
Margin Line Below Step

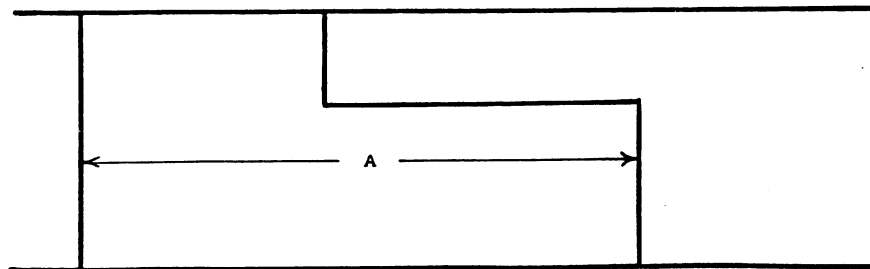
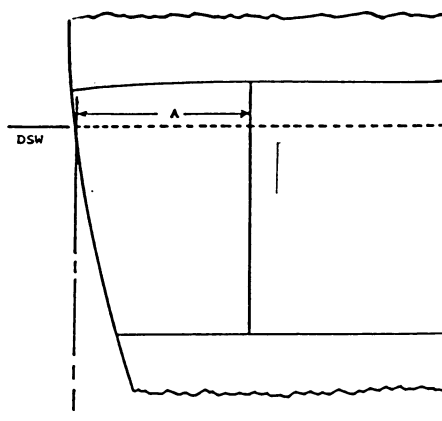

Figure 171.067(c)

Limits of a Recess



Section Through Recess
At ZZ

A = One-fifth the maximum beam measured on the waterline corresponding to the deepest subdivision waterline.

DSW = Deepest subdivision waterline

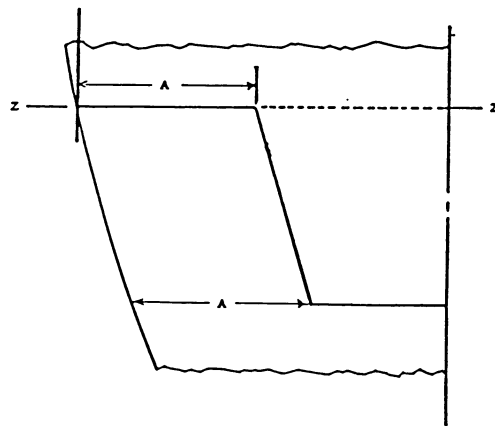

Plan View of Recess at
the waterline corresponding
to the deepest subdivision
waterline

§171.068 Special considerations for Type I subdivision for vessels on short international voyages.

(a) The calculations done to demonstrate compliance with §171.065 for a vessel that makes short international voyages and is permitted under §75.10-10 of this chapter to carry a number of

persons on board in excess of the life-boat capacity must—

- (1) Assume the uniform average permeabilities given in Table 171.068 in lieu of those in Table 171.066; and
- (2) Use a factor of subdivision (FS) that is the smaller of the following:
 - (i) The value from Table 171.065(a).
 - (ii) 0.50.

(b) For a vessel less than 300 feet (91 meters) in length, the Commanding Officer, Marine Safety Center may approve the separation of main transverse watertight bulkheads greater than that permitted by paragraph (a) of this section if—

(1) The shorter separation is impracticable; and

(2) The separation is the smallest that is practicable.

(c) In the case of ships less than 180 feet (55 meters) in length, the Commanding Officer, Marine Safety Center may approve a further relaxation in the bulkhead spacing. However, in no case may the separation be large enough to prevent the vessel from complying with the flooding requirements for Type II subdivision in §171.070.

standard of flooding specified in Table 171.070(b).

(c) A ferry vessel described in paragraph (d) of this section need not meet the standard of flooding specified in Table 171.070(b), except that a ferry vessel in Great Lakes service must at least have a collision bulkhead.

(d) Paragraph (c) of this section applies to a ferry vessel that—

(1) Is 150 feet (46 meters) or less in length; and

(2) Has sufficient air tankage, or other internal buoyancy to float the vessel with no part of the margin line submerged when the vessel is completely flooded. If foam is used to comply with this paragraph, it must be installed in accordance with the requirements in §170.245 of this subchapter.

(e) Except as specified in paragraph (f) of this section, each main transverse watertight bulkhead must be spaced as follows:

(1) Unless otherwise permitted, if the LBP of the vessel is 143 feet (43.5 meters) or more, or the vessel makes international voyages, each main transverse watertight bulkhead must be at least 10 feet (3 meters) plus 3 percent of the vessel's LBP from—

(i) Every other main transverse watertight bulkhead;

(ii) The collision bulkhead; and

(iii) The aftermost point on the bulkhead deck.

(2) If the LBP of the vessel is less than 143 feet (43.5 meters) and the vessel does not make international voyages, each main transverse watertight bulkhead must be no less than 10 percent of the vessel's LBP or 6 feet (1.8 meters), whichever is greater, from—

(i) Every other main transverse watertight bulkhead;

(ii) The collision bulkhead; and

(iii) The aftermost point on the bulkhead deck.

(f) If a vessel is required by §171.060 to have a collision bulkhead in each end of the vessel, then each main transverse watertight bulkhead must be no less than the distance specified in paragraph (e) of this section from—

(1) Every other main transverse watertight bulkhead; and

(2) Each collision bulkhead.

TABLE 171.068—TABLE OF UNIFORM AVERAGE PERMEABILITIES

Location	Uniform average permeability
Machinery Space	$10 \frac{(a - c)}{v}$ 85+
Volume Forward of Machinery Space	$35 \frac{(b)}{v}$ 95 -
Volume Aft of Machinery Space	$35 \frac{(b)}{v}$ 95 -

For each location specified in this table—
a=volume below the margin line of all spaces that, in the full load condition, normally contain no cargo, baggage, stores, provisions, or mail.

b=volume below the margin line and above the tops of floors, inner bottoms, or peak tanks of coal or oil fuel bunkers, chain lockers, fresh water tanks, and of all spaces that, in the full load condition, normally contain stores, baggage, mail, cargo, or provisions. If cargo holds are not occupied by cargo, no part of the cargo space is to be included in this volume.

c=volume below the margin line of the cargo, stores, provisions, or mail spaces within the limits of the machinery space.
v=total volume below the margin line.

[CGD 79-023, 48 FR 51017, Nov. 4, 1983, as amended by CGD 88-070, 53 FR 34537, Sept. 7, 1988]

§ 171.070 Subdivision requirements—Type II.

(a) Each vessel, except a ferry vessel, must be designed so that, while in each condition of loading and operation, it complies with the standard of flooding specified in Table 171.070(a).

(b) Except as provided in paragraph (c), each ferry vessel must be designed so that, while in each condition of loading and operation, it meets the

§ 171.072

46 CFR Ch. I (10–1–14 Edition)

TABLE 171.070(a)—STANDARD OF FLOODING

Passengers carried	Part of vessel	Standard of flooding (compartments)
400 or less	All	1
401 to 600	All of the vessel forward of the first MTWB aft of the collision bulkhead..	2
	All remaining portions of the vessel.	1
601 to 800	All of the vessel forward of the first MTWB that is aft of a point 40% of the vessel's LBP aft of the forward perpendicular.	2
	All remaining portions of the vessel.	1
801 to 1000	All of the vessel forward of the first MTWB that is aft of a point 60% of the vessel's LBP aft of the forward perpendicular.	2
	All remaining portions of the vessel.	1
More than 1000	All	2

Where for this table—
 "MTWB" means main transverse watertight bulkhead; and
 "Standard of Flooding" is explained in § 171.017 of this subchapter.

TABLE 171.070(b)—STANDARD OF FLOODING FOR FERRY VESSELS

Vessel length	Part of vessel	Standard of flooding (compartments)
150 feet (46 meters) or less.	All	1
Greater than 150 feet (46 meters) and less than or equal to 200 feet (61 meters).	All of the vessel forward of the first MTWB aft of the collision bulkhead.	2
	All of the vessel aft of the first MTWB forward of the aft peak bulkhead.	2
	All remaining portions of the vessel.	1
Greater than 200 feet (61 meters).	All	2

Where for this table—
 "MTWB" means main transverse watertight bulkhead; and
 "Standard of Flooding" is explained in § 171.017 of this subchapter.

[CGD 79–023, 48 FR 51017, Nov. 4, 1983, as amended by USCG–2007–0030, 75 FR 78085, Dec. 14, 2010; USCG–2014–0688, 79 FR 58287, Sept. 29, 2014]

§ 171.072 Calculation of permeability for Type II subdivision.

When doing calculations to show compliance with § 171.070, the following uniform average permeabilities must be assumed:

- (a) 85 percent in the machinery space.
- (b) 60 percent in the following spaces:
 - (1) Tanks that are normally filled when the vessel is in the full load condition.
 - (2) Chain lockers.
 - (3) Cargo spaces.
 - (4) Stores spaces.
 - (5) Mail or baggage spaces.
- (c) 95 percent in all other spaces.

[CGD 79–023, 48 FR 51017, Nov. 4, 1983, as amended by USCG–2014–0688, 79 FR 58287, Sept. 29, 2014]

§ 171.073 Treatment of stepped and recessed bulkheads in Type II subdivision.

(a) A main transverse watertight bulkhead may not be stepped unless additional watertight bulkheads are located as shown in Figure 171.067(a) so that the distances A, B, C, and D illustrated in Figure 171.067(a) comply with the following:

- (1) A and B must not exceed the maximum bulkhead spacing that permits compliance with § 171.070; and
- (2) C and D must not be less than the minimum spacing specified in § 171.070(e).

(b) A main transverse watertight bulkhead may not be recessed unless all parts of the recess are inboard from the shell of the vessel as illustrated in Figure 171.067(c).

(c) If a main transverse watertight bulkhead is recessed or stepped, an equivalent plane bulkhead must be used in the calculations required by § 171.070.

§ 171.075 [Reserved]

§ 171.080 Damage stability standards for vessels with Type I or Type II subdivision.

(a) *Calculations.* Each vessel with Type I or Type II subdivision must be shown by design calculations to meet the survival conditions in paragraph (e), (f), or (g) of this section in each condition of loading and operation assuming the extent and character of

damage specified in paragraph (b) of this section.

(b) *Extent and character of damage.* For the purpose of paragraph (a) of this section, design calculations must assume that the damage—

(1) Has the character specified in Table 171.080(a); and

(2) Consists of a penetration having the dimensions specified in Table 171.080(a) except that, if the most disabling penetration would be less than the penetration described in the table, the smaller penetration must be assumed.

(c) *Permeability.* When doing the calculations required in paragraph (a) of this section, the permeability of each space must be calculated in a manner approved by the Commanding Officer, Marine Safety Center or be taken from Table 171.080(c).

(d) *Definitions.* For the purposes of paragraphs (e) and (f) of this section, the following definitions apply:

(1) *New vessel* means a vessel—

(i) For which a building contract is placed on or after April 15, 1996;

(ii) In the absence of a building contract, the keel of which is laid, or which is at a similar stage of construction, on or after April 15, 1996;

(iii) The delivery of which occurs on or after January 1, 1997;

(iv) Application for the reflagging of which is made on or after January 1, 1997; or

(v) That has undergone—

(A) A major conversion for which the conversion contract is placed on or after April 15, 1996;

(B) In the absence of a contract, a major conversion begun on or after April 15, 1996; or

(C) A major conversion completed on or after January 1, 1997.

(2) *Existing vessel* means other than a new vessel.

(3) *Watertight* means capable of preventing the passage of water through the structure in any direction under a head of water for which the surrounding structure is designed.

(4) *Weathertight* means capable of preventing the penetration of water, even boarding seas, into the vessel in any sea condition.

(e) *Damage survival for all existing vessels except those vessels authorized to*

carry more than 12 passengers on an international voyage requiring a SOLAS Passenger Ship Safety Certificate. An existing vessel is presumed to survive assumed damage if it meets the following conditions in the final stage of flooding:

(1) On a vessel required to survive assumed damage with a longitudinal extent of 10 feet (3 meters) plus 0.03L, the final angle of equilibrium must not exceed 7 degrees after equalization, except that the final angle may be as large as 15 degrees if—

(i) The vessel is not equipped with equalization or is equipped with fully automatic equalization; and

(ii) The Commanding Officer, Marine Safety Center approves the vessel's range of stability in the damaged condition.

(2) On a vessel required to survive assumed damage with a longitudinal extent of 20 feet (6.1 meters) plus 0.04L, the angle of equilibrium must not exceed 15 degrees after equalization.

(3) The margin line may not be submerged at any point.

(4) The vessel's metacentric height (GM) must be at least 2 inches (5 cm) when the vessel is in the upright position.

(f) *Damage survival for all new vessels except those vessels authorized to carry more than 12 passengers on an international voyage requiring a SOLAS Passenger Ship Safety Certificate.* A new vessel is presumed to survive assumed damage if it is shown by calculations to meet the conditions set forth in paragraphs (f) (1) through (7) of this section in the final stage of flooding and to meet the conditions set forth in paragraphs (f) (8) and (9) of this section in each intermediate stage of flooding. For the purposes of establishing boundaries to determine compliance with the requirements in paragraphs (f) (1) through (9), openings that are fitted with weathertight closures and that are not submerged during any stage of flooding will not be considered downflooding points.

(1) Each vessel must have positive righting arms for a minimum range beyond the angle of equilibrium as follows:

§ 171.080

46 CFR Ch. I (10–1–14 Edition)

Vessel service	Required range (degrees)
Exposed waters, oceans, or Great Lakes winter ..	15
Partially protected waters or Great Lakes summer	10
Protected waters	5

(2) No vessel may have any opening through which downflooding can occur within the minimum range specified by paragraph (f)(1) of this section.

(3) Each vessel must have an area under each righting-arm curve of at least 0.015 meter-radians, measured from the angle of equilibrium to the smaller of the following angles:

(i) The angle at which downflooding occurs.

(ii) The angle of vanishing stability.

(4) Except as provided by paragraph (f)(5) of this section, each vessel must have within the positive range the greater of a righting arm (GZ) equal to or greater than 0.10 meter or a GZ as calculated using the formula:

$$GZ(m) = C \left(\frac{\text{Heeling Moment}}{\Delta} + 0.04 \right)$$

where—

C=1.00 for vessels on exposed waters, oceans, or Great Lakes winter;

C=0.75 for vessels on partially protected waters or Great Lakes summer;

C=0.50 for vessels on protected waters;

Δ=intact displacement; and

Heeling moment=greatest of the heeling moments as calculated in paragraphs (f)(4)(i) through (iv) of this section.

(i) The passenger heeling moment is calculated using the formula:

$$\text{Passenger Heeling Moment} = 0.5 (n w b)$$

where—

n=number of passengers;

w = passenger weight used for calculations as determined in accordance with §170.090(c) of this chapter; and

b=distance from the centerline of the vessel to the geometric center on one side of the centerline of the passenger deck used to leave the vessel in case of flooding.

(ii) The heeling moment due to asymmetric escape routes for passengers, if the vessel has asymmetric escape routes for passengers, is calculated assuming that—

(A) The weight of each passenger is the weight used for calculations as determined in accordance with §170.090(c) of this chapter;

(B) Each passenger occupies 0.25 square meter of deck area; and

(C) All passengers are distributed, on available deck areas unoccupied by permanently affixed objects, toward one side of the vessel on the decks where passengers would move to escape from the vessel in case of flooding, so that they produce the most adverse heeling moment.

(iii) The heeling moment due to the launching of survival craft is calculated assuming that—

(A) All survival craft, including davit-launched liferafts and rescue boats, fitted on the side to which the vessel heels after sustained damage, are swung out if necessary, fully loaded and ready for lowering;

(B) Persons not in the survival craft swung out and ready for lowering are distributed about the centerline of the vessel so that they do not provide additional heeling or righting moments; and

(C) Survival craft on the side of the vessel opposite that to which the vessel heels remain stowed.

(iv) The heeling moment due to wind pressure is calculated assuming that—

(A) The wind exerts a pressure of 120 Newtons per square meter;

(B) The wind acts on an area equal to the projected lateral area of the vessel above the waterline corresponding to the intact condition; and

(C) The lever arm of the wind is the vertical distance from a point at one-half the mean draft, or the center of area below the waterline, to the center of the lateral area.

(5) Each vessel whose arrangements do not generally allow port or starboard egress may be exempted, by the Commanding Officer, Marine Safety Center, from the transverse passenger heeling moment required by paragraph (f)(4)(i) of this section. Each vessel exempted must have sufficient longitudinal stability to prevent immersion of the deck edge during forward or aft egress.

(6) Each vessel must have an angle of equilibrium that does not exceed—

(i) 7 degrees for flooding of one compartment;

(ii) 12 degrees for flooding of two compartments; or

(iii) A maximum of 15 degrees for flooding of one or two compartments where—

(A) The vessel has positive righting arms for at least 20 degrees beyond the angle of equilibrium; and

(B) The vessel has an area under each righting-arm curve, when the equilibrium angle is between 7 degrees and 15 degrees, in accordance with the formula:

$$A \geq 0.0025(\theta - 1)$$

where—

A=Area required in m-rad under each righting-arm curve measured from the angle of equilibrium to the smaller of either the angle at which downflooding occurs or the angle of vanishing stability.
 θ=actual angle of equilibrium in degrees

(7) The margin line of the vessel must not be submerged when the vessel is in equilibrium.

(8) Each vessel must have a maximum angle of equilibrium that does not exceed 15 degrees during intermediate stages of flooding.

(9) Each vessel must have a range of stability and a maximum righting arm during each intermediate stage of flooding as follows:

Vessel service	Required range (degrees)	Required maximum righting arm
Exposed waters, oceans, or Great Lakes winter	7	0.05 m
Partially-protected waters or Great Lakes summer	5	0.035 m
Protected waters	5	0.035 m

Only one breach in the hull and only one free surface need be assumed when meeting the requirements of this paragraph.

(g) *Damage survival for vessels constructed before January 1 2009 authorized to carry more than 12 passengers on an international voyage requiring a SOLAS Passenger Ship Safety Certificate.* A vessel is presumed to survive assumed damage if it is shown by calculations to comply with the damage stability required for that vessel by the International Convention for the Safety of Life at Sea, 1974, as amended, the applicable regulations of IMO Res. MSC.216(82) (incorporated by reference, see § 171.012).

(h) *Equalization.* (1) Equalization systems on vessels of 150 gross tons or more in ocean service must meet the following:

(i) Equalization must be automatic except that the Commanding Officer, Marine Safety Center may approve other means of equalization if—

(A) It is impracticable to make equalization automatic; and

(B) Controls to cross-flooding equipment are located above the bulkhead deck.

(ii) Equalization must be fully accomplished within 15 minutes after damage occurs.

(2) Equalization on vessels under 150 gross tons in ocean service and on all vessels in other than ocean service must meet the following:

(i) Equalization must not depend on the operation of valves.

(ii) Equalization must be fully accomplished within 15 minutes after damage occurs.

(3) The estimated maximum angle of heel before equalization must be approved by the Commanding Officer, Marine Safety Center.

TABLE 171.080(a)—EXTENT AND CHARACTER OF DAMAGE

Vessel designator ¹	Longitudinal penetration ²	Transverse penetration ^{3 4}	Vertical penetration	Character of Damage
Z	10 feet (3 meters) plus .03L or 35 feet (10.7 meters) whichever is less. ⁵	B/5	from the baseline upward without limit.	Assumes no damage to any main transverse watertight bulkhead.
Y	10 feet (3 meters) plus .03L or 35 feet (10.7 meters) whichever is less.	B/5	From the baseline upward without limit.	Assumes damage to no more than one main transverse watertight bulkhead.
X	10 feet (3 meters) plus .03L or 35 feet (10.7 meters) whichever is less.	B/5	from the baseline upward without limit.	Assumes damage to no more than one main transverse watertight bulkhead.
	20 feet (6.1 meters) plus 0.04L	B/5	From the top of the double bottom upward without limit.	Assumes damage to no more than one main transverse watertight bulkhead.

TABLE 171.080(a)—EXTENT AND CHARACTER OF DAMAGE—Continued

Vessel designator ¹	Longitudinal penetration ²	Transverse penetration ^{3,4}	Vertical penetration	Character of Damage
W	20 feet (6.1 meters) plus 0.04L	B/5	From the baseline upward without limit.	Assumes damage to at least two main transverse watertight bulkheads.

¹ W, X, Y, and Z are determined from Table 171.080(b).
² L = LBP of the vessel in feet (meters).
³ B = the beam of the vessel in feet (meters) measured at or below the deepest subdivision load line as defined in § 171.010(b) except that, when doing calculations for a vessel that operates only on inland waters or a ferry vessel, B may be taken as the mean of the maximum beam on the bulkhead deck and the maximum beam at the deepest subdivision load line.
⁴ The transverse penetration is applied inboard from the side of the vessel, at right angles to the centerline, at the level of the deepest subdivision load line.
⁵ .1L or 6 feet (1.8 meters) whichever is greater for vessels described in § 171.070(e)(2).

TABLE 171.080(b)

Vessel category	Vessel designator
Vessels with type I subdivision and a factor of subdivision as determined from § 171.065 (a) or (b) of 0.33 or less.	W.
Vessels with type I subdivision and a factor of subdivision as determined from § 171.065 (a) or (b) greater than 0.33 and less than or equal to 0.50.	X.
Vessels with Type II subdivision that are required to meet a two compartment standard of flooding.	Y.
All other vessels	Z.

TABLE 171.080(c)—PERMEABILITY

Spaces and tanks	Permeability (percent)
Cargo, coal, stores	60.
Accommodations	95.
Machinery	85.
Tanks	o or 95. ¹

¹ Whichever value results in the more disabling condition.
 [CGD 79-023, 48 FR 51017, Nov. 4, 1983, as amended by CGD 88-070, 53 FR 34537, Sept. 7, 1988; CGD 89-037, 57 FR 41826, Sept. 11, 1992; CGD 94-010, 60 FR 53713, Oct. 17, 1995; CGD 97-057, 62 FR 51049, Sept. 30, 1997; USCG-2007-29018, 72 FR 53968, Sept. 21, 2007; USCG-2007-0030, 75 FR 78085, Dec. 14, 2010; USCG-2012-0832, 77 FR 59788, Oct. 1, 2012; USCG-2014-0688, 79 FR 58287, Sept. 29, 2014]

Subpart D—Additional Subdivision Requirements

§ 171.085 Collision bulkhead.

(a) Paragraphs (b) through (g) of this section apply to each vessel of 100 gross tons or more and paragraphs (h) through (j) of this section apply to each vessel that is less than 100 gross tons.
 (b) The portion of the collision bulkhead that is below the bulkhead deck must be watertight.

(c) Each portion of the collision bulkhead must be at least—
 (1) 5 percent of the LBP from the forward perpendicular in a motor vessel; and
 (2) 5 feet (1.52 meters) from the forward perpendicular in a steam vessel.
 (d) The collision bulkhead must be no more than 10 feet (3 meters) plus 5 percent of the LBP from the forward perpendicular.
 (e) The collision bulkhead must extend to the deck above the bulkhead deck if the vessel—
 (1) Is in ocean service; and
 (2) Has a superstructure that extends from a point forward of the collision bulkhead to a point at least 15 percent of the LBP aft of the collision bulkhead.
 (f) The collision bulkhead required by paragraph (e) of this section must have the following characteristics:
 (1) The portion of the collision bulkhead above the bulkhead deck must be weathertight.
 (2) If the portion of the collision bulkhead above the bulkhead deck is not located directly above the collision bulkhead below the bulkhead deck, then the bulkhead deck between must be weathertight.
 (g) Each opening in the collision bulkhead must—
 (1) Be located above the bulkhead deck; and
 (2) Have a watertight closure.
 (h) Each collision bulkhead—
 (1) Must extend to the deck above the bulkhead deck if in ocean service as defined in § 170.050(f) of this chapter or to the bulkhead deck if in service on other waters;
 (2) May not have watertight doors in it; and

(3) May have penetrations and openings that—

(i) Are located as high and as far inboard as practicable; and

(ii) Except as provided in paragraph (i) of this section, have means to make them watertight.

(i) Each vessel that is not required to comply with a one or two compartment standard of flooding may have an opening that cannot be made watertight in the collision bulkhead below the bulkhead deck if—

(1) The lowest edge of the opening is not more than 12 inches (30.5 centimeters) below the bulkhead deck; and

(2) There are at least 36 inches (92 centimeters) of intact collision bulkhead below the lower edge of the opening.

(j) Each portion of the collision bulkhead must be—

(1) At least 5 percent of the LBP from the forward perpendicular; and

(2) No more than 15 percent of the LBP from the forward perpendicular if the space forward of the collision bulkhead is not subject to damage stability requirements and at any location aft of the location described in paragraph (j)(1) of this section if the space forward of the collision bulkhead is subject to damage stability requirements.

[CGD 79-023, 48 FR 51017, Nov. 4, 1983, as amended by CGD 85-080, 61 FR 945, Jan. 10, 1996]

§ 171.090 Aft peak bulkhead.

(a) Each of the following vessels must have an aft peak bulkhead:

(1) Each vessel 100 gross tons or more on an international voyage.

(2) Each other vessel of more than 150 gross tons.

(b) Except as specified in paragraph (c) of this section, each portion of the aft peak bulkhead below the bulkhead deck must be watertight.

(c) A vessel may have an aft peak bulkhead that does not intersect the bulkhead deck if approved by the Commanding Officer, Marine Safety Center.

[CGD 79-023, 48 FR 51017, Nov. 4, 1983, as amended by CGD 88-070, 53 FR 34537, Sept. 7, 1988]

§ 171.095 Machinery space bulkhead.

(a) This section applies to each vessel of 100 gross tons or more.

(b) Except as provided in paragraph (c) of this section, a vessel required to have Type I or II subdivision must have enough main transverse watertight bulkheads to separate the machinery space from the remainder of the vessel. All portions of these bulkheads must be watertight below the bulkhead deck.

(c) Compliance with paragraph (b) of this section is not required if the vessel has sufficient air tanks or other internal buoyancy to maintain the vessel afloat while in the full load condition when all compartments and all other tanks are flooded. If foam is used to comply with this paragraph, it must be installed in accordance with the requirements in §170.245 of this subchapter.

§ 171.100 Shaft tunnels and stern tubes.

(a) Stern tubes in each of the following vessels must be enclosed in watertight spaces:

(1) Each vessel of 100 gross tons or more on an international voyage.

(2) Each other vessel over 150 gross tons in ocean or Great Lakes service.

(3) Each vessel under 100 gross tons that carries more than 12 passengers on an international voyage.

(b) The watertight seal in the bulkhead between the stern tube space and the machinery space must be located in a watertight shaft tunnel. The vessel must be designed so that the margin line will not be submerged when the watertight shaft tunnel is flooded.

(c) If a vessel has two or more shaft tunnels, they must be connected by a watertight passageway.

(d) If a vessel has two or less shaft tunnels, only one door is permitted between them and the machinery space. If a vessel has more than two shaft tunnels, only two doors are permitted between them and the machinery space.

[CGD 79-023, 48 FR 51017, Nov. 4, 1983, as amended by USCG-2014-0688, 79 FR 58287, Sept. 29, 2014]

§ 171.105 Double bottoms.

(a) This section applies to each vessel that carries more than 12 passengers on an international voyage and all other vessels that are—

(1) 100 gross tons or more; and

§ 171.105

46 CFR Ch. I (10-1-14 Edition)

(2) In ocean or Great Lakes service.

(b) Each vessel over 165 feet (50 meters) and under 200 feet (61 meters) in LBP must have a double bottom that extends from the forward end of the machinery space to the fore peak bulkhead.

(c) Each vessel over 200 feet (61 meters) and under 249 feet (76 meters) in LBP must have a double bottom that extends from the fore peak bulkhead to the forward end of the machinery space and a double bottom that extends from the aft peak bulkhead to the aft end of the machinery space.

(d) Each vessel 249 feet (76 meters) in LBP and upward must have a double bottom that extends from the fore to the aft peak bulkhead.

(e) Each double bottom required by this section must be at least the depth at the centerline given by the following equation:

$$D=18.0+0.05(L) \text{ inches}$$

$$D=45.7+0.417(L) \text{ centimeters}$$

where—

D=the depth at the centerline in inches (centimeters).

L=LBP in feet (meters).

(f) The line formed by the intersection of the margin plate and the bilge plating must be above the horizontal plane C, illustrated in Figure 171.105, at all points. The horizontal plane C is defined by point B, located, as shown in Figure 171.105, in the midships section.

Figure 171.105

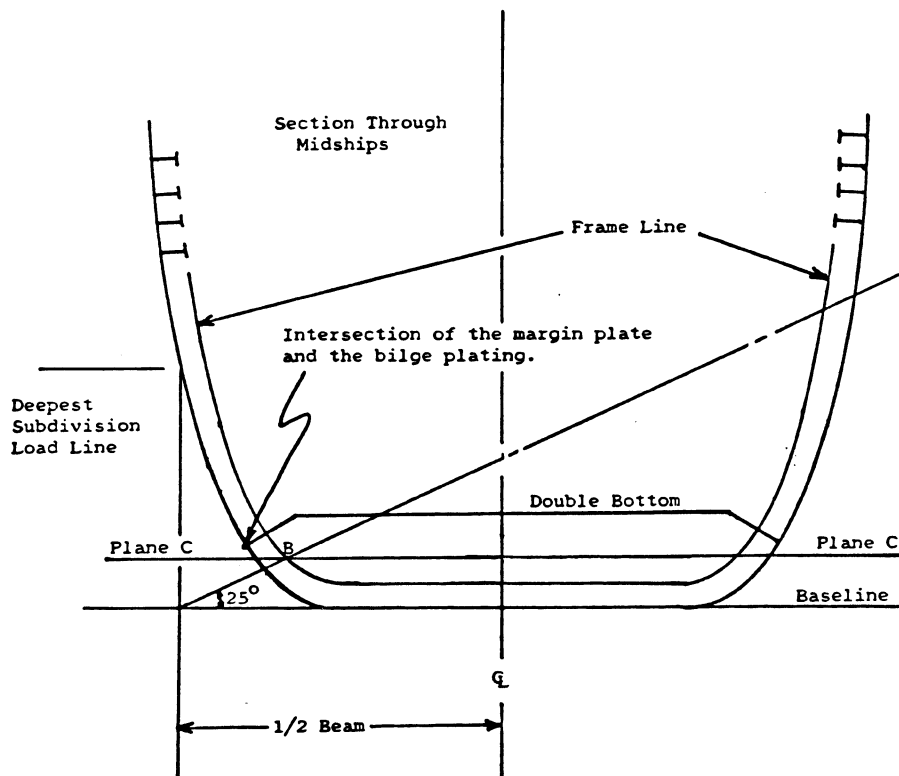
Lower Limit of the Intersection of Margin Plate and Bilge Plating

(g) A double bottom is not required in a tank that is integral with the hull of a vessel if—

(1) The tank is used exclusively for the carriage of liquids; and

(2) It is approved by the Commanding Officer, Marine Safety Center.

(h) A double bottom is not required in any part of a vessel where the separation of main transverse watertight bulkheads is governed by a factor of subdivision less than or equal to 0.50 if—

(1) The Commanding Officer, Marine Safety Center approves;

(2) The vessel makes short international voyages; and

(3) The vessel is permitted by § 75.10-10 of this chapter to carry a number of passengers in excess of the lifeboat capacity.

[CGD 79-023, 48 FR 51017, Nov 4, 1983, as amended by CGD 88-070, 53 FR 34532, Sept. 7, 1988]

§ 171.106 Wells in double bottoms.

(a) This section applies to each vessel that has a well installed in a double bottom required by § 171.105.

§ 171.108

(b) Except as provided in paragraph (c) of this section—

(1) The depth of a well must be at least 18 inches (45.7 cm) less than the depth of the double bottom at the centerline; and

(2) The well may not extend below the horizontal plane C illustrated in Figure 171.105.

(c) A well may extend to the outer bottom of a double bottom at the after end of a shaft tunnel.

§ 171.108 Manholes in double bottoms.

(a) The number of manholes in the inner bottom of a double bottom required by §171.105 must be reduced to the minimum required for adequate access.

(b) Each manhole must have a cover that can be—

(1) Made watertight; and

(2) Protected from damage by cargo or coal.

§ 171.109 Watertight floors in double bottoms.

If a vessel is required to have a double bottom, a watertight transverse division must be located in the double bottom under each main transverse watertight bulkhead or as near as practicable to the main transverse watertight bulkhead. If a vessel also has duct keels, the transverse divisions need not extend across them.

Subpart E—Penetrations and Openings in Watertight Bulkheads

§ 171.110 Specific applicability.

(a) Sections 171.111, 171.112, and 171.113 apply to each vessel of 100 gross tons or more.

(b) Section 171.114 applies to each vessel under 100 gross tons.

[CGD 79-023, 48 FR 51017, Nov. 4, 1983, as amended by CGD 85-080, 61 FR 945, Jan. 10, 1996; 62 FR 51353, Sept. 30, 1997]

§ 171.111 Penetrations and openings in watertight bulkheads in vessels of 100 gross tons or more.

(a) Except as provided in paragraph (f) of this section, each opening in a watertight bulkhead must have a means to close it watertight.

46 CFR Ch. I (10-1-14 Edition)

(b) Except in a machinery space, the means for closing each opening may not be by bolted portable plates.

(c) If a main transverse watertight bulkhead is penetrated, the penetration must be made watertight. Lead or other heat sensitive materials must not be used in a system that penetrates a main transverse watertight bulkhead if fire damage to this system would reduce the watertight integrity of the bulkhead.

(d) A main transverse watertight bulkhead must not be penetrated by valves or cocks unless they are a part of a piping system.

(e) If a pipe, scupper, or electric cable passes through a main transverse watertight bulkhead, the opening through which it passes must be watertight.

(f) A main transverse watertight bulkhead may not have non-watertight penetrations below the bulkhead deck unless—

(1) The margin line is more than 9 inches (23 centimeters) below the bulkhead deck at the intersection of the margin line and the line formed by the intersection of the plane of the main transverse watertight bulkhead and the shell; and

(2) Making all penetrations watertight is impracticable.

(g) Penetrations approved in accordance with paragraph (f) of this section must comply with the following:

(1) The bottom of the penetration must not be located—

(i) More than 24 inches (61 centimeters) below the bulkhead deck; nor

(ii) Less than 9 inches (23 centimeters) above the margin line.

(2) The penetration must not be located outboard from the centerline more than $\frac{1}{4}$ of the beam of the vessel measured—

(i) On the bulkhead deck; and

(ii) In the vertical plane of the penetration.

(h) No doors, manholes, or other access openings may be located in a watertight bulkhead that separates two cargo spaces or a cargo space and a permanent or reserve bunker.

§ 171.112 Watertight door openings.

(a) The opening for a watertight door must be located as high in the bulkhead and as far inboard as practicable.

(b) No more than one door, other than a door to a bunker or shaft alley, may be fitted in a main transverse watertight bulkhead within spaces containing the following:

- (1) Main and auxiliary propulsion machinery.
- (2) Propulsion boilers.
- (3) Permanent bunkers.

§ 171.113 Trunks.

(a) For the purpose of this section, “trunk” means a large enclosed passageway through any deck or bulkhead of a vessel.

(b) Each trunk, other than those specified in paragraph (c) of this section, must have a watertight door at each end except that a trunk may have a watertight door at one end if—

- (1) The trunk does not pass through more than one main compartment;
- (2) The sides of the trunk are not nearer to the shell than is permitted by § 171.067(c) for the sides of a recess in a bulkhead; and
- (3) The vessel complies with the subdivision requirements in this part when the volume of the trunk is included with the volume of the compartment into which it opens.

(c) Each trunk that provides access from a crew accommodation space and that passes through a main transverse watertight bulkhead must comply with the following:

- (1) The trunk must be watertight.
- (2) The trunk, if used for passage at sea, must have at least one end above the margin line and access to the other end of the trunk must be through a watertight door.
- (3) The trunk must not pass through the first main transverse watertight bulkhead aft of the collision bulkhead.

§ 171.114 Penetrations and openings in watertight bulkheads in a vessel less than a 100 gross tons.

(a) Penetrations and openings in watertight bulkheads must—

- (1) Be kept as high and as far inboard as practicable; and
 - (2) Have means to make them watertight.
- (b) Watertight bulkheads must not have sluice valves.

(c) Each main transverse watertight bulkhead must extend to the bulkhead deck.

[CGD 85-080, 62 FR 51353, Sept. 30, 1997]

Subpart F—Openings in the Side of a Vessel Below the Bulkhead or Weather Deck

§ 171.115 Specific applicability.

(a) Sections 171.116, 171.117, and 171.118 apply to each vessel of 100 gross tons or more.

(b) Section 171.119 applies to each vessel under 100 gross tons.

[CGD 79-023, 48 FR 51017, Nov. 4, 1983, as amended by CGD 85-080, 61 FR 945, Jan. 10, 1996; 62 FR 51353, Sept. 30, 1997]

§ 171.116 Port lights.

(a) A vessel may have port lights below the bulkhead deck if—

- (1) It is greater than 150 gross tons; and
- (2) It is in ocean service.

(b) All port lights in a space must be non-opening if the sill of any port light in that space is below a line that—

- (1) Is drawn parallel to the line formed by the intersection of the bulkhead deck and the shell of the vessel; and
- (2) Has its lowest point 2½ percent of the beam of the vessel above the deepest subdivision load line.

(c) For the purpose of paragraph (b) of this section, the beam of the vessel is measured at or below the deepest subdivision load line.

(d) Except as provided in paragraph (e) of this section, no port light may be located in a space that is used exclusively for the carriage of cargo, stores, or coal.

(e) A port light may be located in a space used alternately for the carriage of cargo or passengers.

(f) Each port light installed below the bulkhead deck must conform to the following requirements:

- (1) The design of each port light must be approved by the Commanding Officer, Marine Safety Center.
- (2) Each non-opening port light must be watertight.
- (3) Each opening port light must be constructed so that it can be secured watertight.

§ 171.117

(4) Each opening port light must be installed with at least one bolt that is secured by a round slotted or recessed nut that requires a special wrench to remove. The nut must be protected by a sleeve or guard to prevent it from being removed with ordinary tools.

[CGD 79-023, 48 FR 51017, Nov. 4, 1983, as amended by CGD 88-070, 53 FR 34537, Sept. 7, 1988]

§ 171.117 Dead covers.

(a) Except as provided in paragraph (b) of this section, each port light with the sill located below the margin line must have a hinged, inside dead cover.

(b) The dead cover on a port light located in an accommodation space for passengers other than steerage passengers may be portable if—

(1) The apparatus for stowing the dead cover is adjacent to its respective port light;

(2) The port light is located above the deck that is immediately above the deepest subdivision load line;

(3) The port light is aft of a point one-eighth of the LBP of the vessel from the forward perpendicular; and

(4) The port light is above a line that—

(i) Is parallel to the line formed by the intersection of the bulkhead deck and the side of the vessel; and

(ii) Has its lowest point at a height of 12 feet (3.66 meters) plus 2½ percent of the beam of the vessel above the deepest subdivision load line.

(c) For the purpose of paragraph (b) of this section, the beam of the vessel is measured at or below the deepest subdivision load line.

(d) Each dead cover must be designed so that—

(1) It can be secured watertight; and

(2) It is not necessary to release any of the special nuts required in § 171.116(f)(4) in order to secure the dead cover.

§ 171.118 Automatic ventilators and side ports.

(a) An automatic ventilator must not be fitted in the side of a vessel below the bulkhead deck unless approved by the Commanding Officer, Marine Safety Center.

(b) The design and construction of each gangway, cargo and coaling port,

46 CFR Ch. I (10-1-14 Edition)

and similar opening in the side of a vessel must be approved by the Commanding Officer, Marine Safety Center.

(c) In no case may the lowest point of any gangway, cargo and coaling port, or similar opening be below the deepest subdivision load line.

[CGD 79-023, 48 FR 51017, Nov. 4, 1983, as amended by CGD 88-070, 53 FR 34537, Sept. 7, 1988]

§ 171.119 Openings below the weather deck in the side of a vessel less than 100 gross tons.

(a) If a vessel operates on exposed or partially protected waters, an opening port light is not permitted below the weather deck unless—

(1) The sill is at least 30 inches (76.2 centimeters) above the deepest subdivision load line; and

(2) It has an inside, hinged dead cover.

(b) Except for engine exhausts, each inlet or discharge pipe that penetrates the hull below a line drawn parallel to and at least 6 inches (15.2 centimeters) above the deepest subdivision load line must have means to prevent water from entering the vessel if the pipe fractures or otherwise fails.

(c) A positive action valve or cock that is located as close as possible to the hull is an acceptable means for complying with paragraph (b) of this section.

(d) If an inlet or discharge pipe is inaccessible, the means for complying with paragraph (b) of this section must be a shut-off valve that is—

(1) Operable from the weather deck or other accessible location above the bulkhead deck; and

(2) Labeled at the operating point for identity and direction of closing.

(e) Any connecting device or valve in a hull penetration must not be cast iron.

(f) Each plug cock in an inlet or discharge pipe must have a means, other than a cotter pin, to prevent its loosening or removal from the body.

[CGD 85-080, 62 FR 51353, Sept. 30, 1997]

Subpart G—Watertight Integrity Above the Margin Line

§ 171.120 Specific applicability.

Each vessel that is 100 gross tons or more must comply with §171.122 and each vessel under 100 gross tons must comply with §171.124.

[CGD 85-080, 62 FR 51354, Sept. 30, 1997]

§ 171.122 Watertight integrity above the margin line in a vessel of 100 gross tons or more.

(a) For the purpose of this section, a partial watertight bulkhead is one in which all portions are not watertight.

(b) Except as provided in paragraph (d) of this section, the bulkhead deck or a deck above it must be weather-tight.

(c) Partial watertight bulkheads or web frames must be located in the immediate vicinity of main transverse watertight bulkheads to minimize as much as practicable the entry and spread of water above the bulkhead deck.

(d) If a partial watertight bulkhead or web frame is located on the bulkhead deck in order to comply with paragraph (c) of this section, the joint between it and the shell and bulkhead deck must be watertight.

(e) If a partial watertight bulkhead does not line up with a main transverse watertight bulkhead below the bulkhead deck, the bulkhead deck between them must be watertight.

(f) Each opening in an exposed weather deck must—

(1) Have a coaming that complies with the height requirements in table 171.124(d); and

(2) Have a means for closing it weather-tight.

(g) Each port light located between the bulkhead deck and the next deck above the bulkhead deck must have an inside dead cover than can be secured watertight.

[CGD 79-023, 48 FR 51017, Nov. 4, 1983, as amended by CGD 85-080, 61 FR 945, Jan. 10, 1996; 62 FR 51354, Sept. 30, 1997]

§ 171.124 Watertight integrity above the margin line in a vessel less than 100 gross tons.

(a) Each hatch exposed to the weather must be watertight; except that, the following hatches may be weather-tight:

(1) Each hatch on a watertight trunk that extends at least 12 inches (30.5 centimeters) above the weather deck.

(2) Each hatch in a cabin top.

(3) Each hatch on a vessel that operates only on protected waters.

(b) Each hatch cover must—

(1) Have securing devices; and

(2) Be attached to the hatch frame or coaming by hinges, captive chains, or to other devices to prevent its loss.

(c) Each hatch that provides access to crew or passenger accommodations must be operable from either side.

(d) Except as provided in paragraph (e) of this section, a weather-tight door with permanent watertight coamings that comply with the height requirements in table 171.124(d) must be provided for each opening located in a deck house or companionway that—

(1) Gives access into the hull; and

(2) Is located in—

(i) A cockpit;

(ii) A well; or

(iii) An exposed location on a flush deck vessel.

TABLE 171.124(d)

Route	Height of coaming
Exposed or partially protected	6 inches (15.2 centimeters).
Protected	3 inches (7.6 centimeters).

(e) If an opening in a location specified in paragraph (d) of this section is provided with a Class 1 watertight door, the height of the watertight coaming need only be sufficient to accommodate the door.

[CGD 85-080, 62 FR 51354, Sept. 30, 1997]

Subpart H—Drainage of Weather Decks

§ 171.130 Specific applicability.

(a) Section 171.135 applies to each vessel that is 100 gross tons or more.

§ 171.135

(b) Sections 171.140, 171.145, 171.150, and 171.155 apply to each vessel under 100 gross tons.

[CGD 79-023, 48 FR 51017, Nov. 4, 1983, as amended by CGD 85-080, 61 FR 945, Jan. 10, 1996; 62 FR 51354, Sept. 30, 1997]

§ 171.135 Weather deck drainage on a vessel of 100 gross tons or more.

The weather deck must have freeing ports, open rails, and scuppers, as necessary, to allow rapid clearing of water under all weather conditions.

§ 171.140 Drainage of a flush deck vessel.

(a) Except as provided in paragraph (b) of this section, the weather deck on a flush deck vessel must be watertight and have no obstruction to overboard drainage.

(b) Each vessel with a flush deck may have solid bulwarks in the forward one-third length of the vessel if—

(1) The bulwarks do not form a well enclosed on all sides; and

(2) The foredeck of the vessel has sufficient sheer to ensure drainage aft.

[CGD 85-080, 62 FR 51354, Sept. 30, 1997]

§ 171.145 Drainage of a vessel with a cockpit.

(a) Except as follows, the cockpit must be watertight:

(1) A cockpit may have companionways if they comply with § 171.124(d).

(2) A cockpit may have ventilation openings along its inner periphery if—

(i) The vessel operates only on protected or partially protected waters;

(ii) The ventilation openings are located as high as possible in the side of the cockpit; and

(iii) The height of the ventilation opening does not exceed 2 inches (5 centimeters).

(b) The cockpit must be designed to be self-bailing.

(c) Scuppers installed in a cockpit must be located to allow rapid clearing of water in all probable conditions of list and trim.

(d) Scuppers must have a combined area of at least the area given by either of the following equations:

$A=0.1(D)$ square inches.

$A=6.94(D)$ square centimeters.

Where—

46 CFR Ch. I (10-1-14 Edition)

A = the combined area of the scuppers in square inches (square centimeters).

D = the area of the cockpit in square feet (square meters).

(e) The cockpit deck of a vessel that operates on exposed or partially protected waters must be at least 10 inches (24.5 centimeters) above the deepest subdivision load line, unless the vessel complies with—

(1) The intact stability requirements of § 171.150;

(2) The Type II subdivision requirements in §§ 171.070, 171.072, and 171.073; and

(3) The damage stability requirements in § 171.080.

(f) The cockpit deck of all vessels that do not operate on exposed or partially protected waters must be located as high above the deepest subdivision load line as practicable.

[CGD 85-080, 62 FR 51354, Sept. 30, 1997]

§ 171.150 Drainage of a vessel with a well deck.

(a) Each well deck on a vessel must be watertight.

(b) Except as provided in paragraphs (c) and (d) of this section, the area required for freeing ports in the bulwarks that form a well must be determined as follows:

(1) If a vessel operates on exposed or partially protected waters, it must have at least 100 percent of the freeing port area derived from table 171.150.

(2) If a vessel operates only on protected or partially protected waters and complies with the requirements in the following sections for a vessel that operates on exposed waters, it must have at least 50 percent of the freeing port area derived from table 171.150:

(i) The intact stability requirements of § 171.030 or § 171.050 and § 171.170.

(ii) The subdivision requirements of § 171.040, § 171.043, or § 171.070.

(iii) The damage stability requirements of § 171.080.

(3) If a vessel operates only on protected waters, the freeing port area must be at least equal to the scupper area required by § 171.145(d) for a cockpit of the same size.

(c) The freeing ports must be located to allow rapid clearing of water in all probable conditions of list and trim.

(d) If a vessel that operates on exposed or partially protected waters does not have free drainage from the foredeck aft, then the freeing port area must be derived from table 171.150 using the entire bulwark length rather than the bulwark length in the after two-thirds of the vessel as stated in the table.

TABLE 171.150

Height of solid bulwark in inches (centimeters)	Freeing port area ^{1,2}
6(15)	2(42.3)
12(30)	4(84.7)
18(46)	8(169.3)
24(61)	12(253.9)
30(76)	16(338.6)
36(91)	20(423.2)

¹ Intermediate values of freeing port area can be obtained by interpolation.

² In square inches per foot (square centimeters per meter) of bulwark length in the after 2/3 of the vessel.

[CGD 85-080, 62 FR 51354, Sept. 30, 1997]

§ 171.155 Drainage of an open boat.

The deck within the hull of an open boat must drain to the bilge. Overboard drainage of the deck is not permitted.

[CGD 85-080, 62 FR 51355, Sept. 30, 1997]

PART 172—SPECIAL RULES PERTAINING TO BULK CARGOES

Subpart A—General

Sec.

172.005 Applicability.

Subpart B—Bulk Grain

172.010 Applicability.
 172.015 Document of authorization.
 172.020 Incorporation by reference.
 172.030 Exemptions for certain vessels.
 172.040 Certificate of loading.

Subpart C—Special Rules Pertaining to a Barge That Carries a Cargo Regulated Under Subchapter D of This Chapter

172.047 Specific applicability.
 172.048 Definitions.
 172.050 Damage stability.

Subpart D—Special Rules Pertaining to a Vessel That Carries a Cargo Regulated Under 33 CFR Part 157

172.060 Specific applicability.
 172.065 Damage stability.

172.070 Intact stability.

Subpart E—Special Rules Pertaining to a Barge That Carries a Hazardous Liquid Regulated Under Subchapter O of This Chapter

172.080 Specific applicability.
 172.085 Hull type.
 172.087 Cargo loading assumptions.
 172.090 Intact transverse stability.
 172.095 Intact longitudinal stability.
 172.100 Watertight integrity.
 172.103 Damage stability.
 172.104 Character of damage.
 172.105 Extent of damage.
 172.110 Survival conditions.

Subpart F—Special Rules Pertaining to a Ship That Carries a Hazardous Liquid Regulated Under Subchapter O of This Chapter

172.125 Specific applicability.
 172.127 Definitions.
 172.130 Calculations.
 172.133 Character of damage.
 172.135 Extent of damage.
 172.140 Permeability of spaces.
 172.150 Survival conditions.

Subpart G—Special Rules Pertaining to a Ship That Carries a Bulk Liquefied Gas Regulated Under Subchapter O of This Chapter

172.155 Specific applicability.
 172.160 Definitions.
 172.165 Intact stability calculations.
 172.170 Damage stability calculations.
 172.175 Character of damage.
 172.180 Extent of damage.
 172.185 Permeability of spaces.
 172.195 Survival conditions.
 172.205 Local damage.

Subpart H—Special Rules Pertaining to Great Lakes Dry Bulk Cargo Vessels

172.215 Specific applicability.
 172.220 Definitions.
 172.225 Calculations.
 172.230 Character of damage.
 172.235 Extent of damage.
 172.240 Permeability of spaces.
 172.245 Survival conditions.

AUTHORITY: 46 U.S.C. 3306, 3703, 5115; E.O. 12234, 45 FR 58801, 3 CFR, 1980 Comp., p. 277; Department of Homeland Security Delegation No. 0170.1.

SOURCE: CGD 79-023, 48 FR 51040, Nov. 4, 1983, unless otherwise noted.

Subpart A—General**§ 172.005 Applicability.**

This part applies to each vessel that carries one of the following cargoes in bulk:

- (a) Grain.
- (b) A cargo listed in Table 30.25–1 of this chapter.
- (c) A cargo regulated under 33 CFR part 157.
- (d) A cargo listed in Table 151.01–10(b) of this chapter.
- (e) A cargo listed in Table I of part 153 of this chapter.
- (f) A cargo listed in Table 4 of part 154 of this chapter.
- (g) Any dry bulk cargo carried in a new Great Lakes vessel.

[CGD 79–023, 48 FR 51040, Nov. 4, 1983, as amended by CGD 80–159, 51 FR 33059, Sept. 18, 1986]

Subpart B—Bulk Grain

SOURCE: CGD 95–028, 62 FR 51218, Sept. 30, 1997, unless otherwise noted.

§ 172.010 Applicability.

This subpart applies to each vessel that loads grain in bulk, except vessels engaged solely on voyages on rivers, lakes, bays, and sounds or on voyages between Great Lake ports and St. Lawrence River ports as far east as a straight line drawn from Cape de Rosiers to West Point, Anticosti Island and as far east of a line drawn along the 63rd meridian from Anticosti Island to the north shore of the St. Lawrence River.

§ 172.015 Document of authorization.

(a) Except as specified in §172.030, each vessel that loads grain in bulk must have a Document of Authorization issued in accordance with one of the following:

(1) Section 3 of the International Code for the Safe Carriage of Grain in Bulk if the Document of Authorization is issued on or after January 1, 1994. As used in the Code, the term “Administration” means “U.S. Coast Guard”.

(2) Regulation 10 part (a) of the Annex to IMO Assembly resolution A.264(VIII) if the Document of Author-

ization was issued before January 1, 1994.

(b) The Commandant recognizes the National Cargo Bureau, Inc., 17 Battery Place, Suite 1232, New York, New York 10004–1110, for the purpose of issuing Documents of Authorization in accordance with paragraph (a)(1) of this section.

[CGD 95–028, 62 FR 51218, Sept. 30, 1997, as amended by USCG–2007–29018, 72 FR 53968, Sept. 21, 2007]

§ 172.020 Incorporation by reference.

(a) Certain material is incorporated by reference into this part with the approval of the Director of the Federal Register under 5 U.S.C. 552(a) and 1 CFR part 51. To enforce any edition other than that specified in this section, the Coast Guard must publish a notice of change in the FEDERAL REGISTER and the material must be available to the public. All approved material is available for inspection at the National Archives and Records Administration (NARA). For information on the availability of this material at NARA, call 202–741–6030 or go to http://www.archives.gov/federal_register/code_of_federal_regulations/ibr_locations.html. It is also available for inspection at Coast Guard Headquarters. Contact Commandant (CG–ENG–2), Attn: Naval Architecture Division, U.S. Coast Guard Stop 7509, 2703 Martin Luther King Jr. Avenue SE., Washington, DC 20593–7509. The material is also available from the source listed in paragraph (b) of this section.

(b) International Maritime Organization (IMO), Publications Section, 4 Albert Embankment, London SE1 7SR, United Kingdom, +44 (0)20 7735 7611, <http://www.imo.org/>.

(1) Amendment to Chapter VI of the International Convention for the Safety of Life at Sea, 1960, Resolution A.264(VIII), incorporation by reference (IBR) approved for §172.015.

(2) Publication No. 240–E, International Code for the Safe Carriage of Grain in Bulk, IBR approved for §172.015.

(3) Resolution MEPC.117(52), Amendments to the Annex of the Protocol of 1978 Relating to the International Convention for the Prevention of Pollution from Ships, 1973 (IMO Res.

Coast Guard, DHS

§ 172.048

MEPC.117(52)), Adopted on 15 October 2004, IBR approved for § 172.070.

[USCG-2007-0030, 75 FR 78086, Dec. 14, 2010, as amended by USCG-2012-0832, 77 FR 59788, Oct. 1, 2012; USCG-2013-0671, 78 FR 60163, Sept. 30, 2013]

§ 172.030 Exemptions for certain vessels.

(a) Vessels are exempt from 172.015 on voyages between:

(1) United States ports along the East Coast as far south as Cape Henry, VA;

(2) Wilmington, NC and Miami, FL;

(3) United States ports in the Gulf of Mexico;

(4) Puget Sound ports and Canadian west coast ports or Columbia River ports, or both;

(5) San Francisco, Los Angeles, and San Diego, CA.

(b) Vessels exempt by paragraph (a) of this section must comply with the following conditions:

(1) The master is satisfied that the vessel's longitudinal strength is not impaired.

(2) The master ascertains the weather to be encountered on the voyage.

(3) Potential heeling moments are reduced to a minimum by carrying as few slack holds as possible.

(4) Each slack surface must be leveled.

(5) The transverse metacentric height (GM), in meters, of the vessel throughout the voyage, after correction for liquid free surface, has been shown by stability calculations to be in excess of the required GM (GMR), in meters.

(i) The GMR is the sum of the increments of GM (GMI) multiplied by the correction factor, *f* and *r*.

Where:

r=(available freeboard) (beam) of the vessel and

f=1 if *r* is >0.268 or

f=(0.268 *r*) if *r* is <0.268.

(ii) The GMI for each compartment which has a slack surface of grain, *i.e.*, is not trimmed full, is calculated by the following formula:

$$GMI=(B3 \times L \times 0.0661)(Disp. \times SF)$$

where:

B=breadth of slack grain surface (m)

L=Length of compartment (m)

Disp.=Displacement of vessel (tons)

SF=Stowage factor of grain in compartment (cubic meters/tons)

(c) Vessels which do not have the Document of Authorization required by § 172.015 may carry grain in bulk up to one third of their deadweight tonnage provided the stability complies with the requirements of Section 9 of the International Code for the Safe Carriage of Grain in Bulk.

§ 172.040 Certificate of loading.

(a) Before it sails, each vessel that loads grain in bulk, except vessels engaged solely on voyages on the Great Lakes, rivers, or lakes, bays, and sounds, must have a certificate of loading issued by an organization recognized by the Commandant for that purpose. The certificate of loading may be accepted as prima facie evidence of compliance with the regulations in this subpart.

(b) The Commandant recognizes the National Cargo Bureau, Inc., 17 Battery Place, Suite 1232, New York, New York 10004-1110, for the purpose of issuing certificates of loading.

[CGD 95-028, 62 FR 51218, Sept. 30, 1997, as amended by USCG-2007-29018, 72 FR 53968, Sept. 21, 2007]

Subpart C—Special Rules Pertaining to a Barge That Carries a Cargo Regulated Under Subchapter D of This Chapter

§ 172.047 Specific applicability.

This section applies to each tank barge that carries, in independent tanks described in § 151.15-1(b) of this chapter, a cargo listed in Table 30.25-1 of this chapter that is a—

(a) Liquefied flammable gas; or

(b) Flammable liquid that has a Reid vapor pressure in excess of 25 pounds per square inch (172.4 KPa).

§ 172.048 Definitions.

As used in this subpart—

MARPOL 73/38 means the International Convention for the Prevention of Pollution from Ships, 1973, as modified by the Protocol of 1978 relating to that Convention.

[USCG-2000-7641, 66 FR 55574, Nov. 2, 2001]

§ 172.050

46 CFR Ch. I (10–1–14 Edition)

§ 172.050 Damage stability.

(a) Each tank barge is assigned a hull type number by the Commandant in accordance with §32.63–5 of this chapter. The requirements in this section are specified according to the hull type number assigned.

(b) Except as provided in paragraph (c) of this section, each Type I and II barge hull must have a watertight weather deck.

(c) If a Type I or II barge hull has an open hopper, the fully loaded barge must be shown by design calculations to have at least 2 inches (50mm) of positive GM when the hopper space is flooded to the height of the weather deck.

(d) When demonstrating compliance with paragraph (c) of this section, credit may be given for the buoyancy of the immersed portion of cargo tanks if the tank securing devices are shown by design calculations to be strong enough to hold the tanks in place when they are subjected to the buoyant forces resulting from the water in the hopper.

(e) Each tank barge must be shown by design calculations to have at least 2 inches (50 mm) of positive GM in each condition of loading and operation after assuming the damage specified in paragraph (f) of this section is applied in the following locations:

(1) *Type I barge hull not in an integrated tow.* If a Type I hull is required and the barge is not a box barge designed for use in an integrated tow, design calculations must show that the barge hull can survive damage at any location including on the intersection of a transverse and longitudinal watertight bulkhead.

(2) *Type I barge hull in an integrated tow.* If a Type I hull is required and the barge is a box barge designed for operation in an integrated tow, design calculations must show that the barge can survive damage—

(i) To any location on the bottom of the tank barge except on a transverse watertight bulkhead; and

(ii) To any location on the side of the tank barge including on a transverse watertight bulkhead.

(3) *Type II hull.* If a Type II hull is required, design calculations must show that the barge can survive damage to

any location except to a transverse watertight bulkhead.

(f) For the purpose of paragraph (e) of this section—

(1) Design calculations must include both side and bottom damage, applied separately; and

(2) Damage must consist of the most disabling penetration up to and including penetrations having the following dimensions:

(i) Side damage must be assumed to be as follows:

(A) Longitudinal extent—6 feet (183 centimeters).

(B) Transverse extent—30 inches (76 centimeters).

(C) Vertical extent—from the baseline upward without limit.

(ii) Bottom damage must be assumed to be 15 inches (38.1 centimeters) from the baseline upward.

Subpart D—Special Rules Pertaining to a Vessel That Carries a Cargo Regulated Under 33 CFR Part 157

§ 172.060 Specific applicability.

This subpart applies to each U.S. tank vessel that is required to comply with 33 CFR 157.21.

[CGD 90–051, 57 FR 36246, Aug. 12, 1992]

§ 172.065 Damage stability.

(a) *Definitions.* As used in this section, *Length* or *L* means load line length (LLL).

(b) *Calculations.* Each tank vessel must be shown by design calculations to meet the survival conditions in paragraph (g) of this section in each condition of loading and operation except as specified in paragraph (c) of this section, assuming the damage specified in paragraph (d) of this section.

(c) *Conditions of loading and operation.* The design calculations required by paragraph (b) of this section need not be done for ballast conditions if the vessel is not carrying oil, other than oily residues, in cargo tanks.

(d) *Character of damage.* (1) If a tank vessel is longer than 738 feet (225 meters) in length, design calculations must show that it can survive damage at any location.

(2) If a tank vessel is longer than 492 feet (150 meters) in length, but not longer than 738 feet (225 meters), design calculations must show that it can survive damage at any location except the transverse bulkheads bounding an aft machinery space. The machinery space is calculated as a single floodable compartment.

(3) If a tank vessel is 492 feet (150 meters) or less in length, design calculations must show that it can survive damage—

(i) At any location between adjacent main transverse watertight bulkheads except to an aft machinery space;

(ii) To a main transverse watertight bulkhead spaced closer than the longitudinal extent of collision penetration specified in Table 172.065(a) from another main transverse watertight bulkhead; and

(iii) To a main transverse watertight bulkhead or a transverse watertight bulkhead bounding a side tank or double bottom tank if there is a step or a recess in the transverse bulkhead that is longer than 10 feet (3.05 meters) and that is located within the extent of penetration of assumed damage. The step formed by the after peak bulkhead and after peak tank top is not a step for the purpose of this regulation.

(e) *Extent of damage.* For the purpose of paragraph (b) of this section—

(1) Design calculations must include both side and bottom damage, applied separately; and

(2) Damage must consist of the penetrations having the dimensions given in Table 172.065(a) except that, if the most disabling penetrations would be less than the penetrations described in this paragraph, the smaller penetration must be assumed.

(f) *Permeability of spaces.* When doing the calculations required in paragraph (b) of this section—

(1) The permeability of a floodable space, other than a machinery space, must be as listed in Table 172.065(b);

(2) Calculations in which a machinery space is treated as a floodable space must be based on an assumed machinery space permeability of 85%, unless the use of an assumed permeability of less than 85% is justified in detail; and

(3) If a cargo tank would be penetrated under the assumed damage, the cargo tank must be assumed to lose all cargo and refill with salt water, or fresh water if the vessel operates solely on the Great Lakes, up to the level of the tank vessel's final equilibrium waterline.

(g) *Survival conditions.* A vessel is presumed to survive assumed damage if it meets the following conditions in the final stage of flooding:

(1) *Final waterline.* The final waterline, in the final condition of sinkage, heel, and trim, must be below the lower edge of an opening through which progressive flooding may take place, such as an air pipe, or an opening that is closed by means of a weathertight door or hatch cover. This opening does not include an opening closed by a—

(i) Watertight manhole cover;

(ii) Flush scuttle;

(iii) Small watertight cargo tank hatch cover that maintains the high integrity of the deck;

(iv) Class 1 door in a watertight bulkhead within the superstructure;

(v) Remotely operated sliding watertight door; or

(vi) Side scuttle of the non-opening type.

(2) *Heel angle.* The maximum angle of heel must not exceed 25 degrees, except that this angle may be increased to 30 degrees if no deck edge immersion occurs.

(3) *Range of stability.* Through an angle of 20 degrees beyond its position of equilibrium after flooding, a tank vessel must meet the following conditions:

(i) The righting arm curve must be positive.

(ii) The maximum righting arm must be at least 3.94 inches (10 cm).

(iii) Each submerged opening must be weathertight.

(4) *Progressive flooding.* Pipes, ducts or tunnels within the assumed extent of damage must be either—

(i) Equipped with arrangements such as stop check valves to prevent progressive flooding to other spaces with which they connect; or

(ii) Assumed in the design calculations required in paragraph (b) of this section to permit progressive flooding to the spaces with which they connect.

§ 172.070

(h) *Buoyancy of superstructure.* For the purpose of paragraph (b) of this section, the buoyancy of any superstructure directly above the side damage is to be disregarded. The unflooded parts of superstructures beyond the extent of damage may be taken into consideration if they are separated from the damaged space by watertight bulkheads and no progressive flooding of these intact spaces takes place.

TABLE 172.065(a)—EXTENT OF DAMAGE
COLLISION PENETRATION

Longitudinal extent	0.495L ^{2/3} or 47.6 feet ((1/3)L ^{2/3} or 14.5m) whichever is shorter.
Transverse extent ¹	B/5 or 37.74 feet (11.5m) which is shorter.
Vertical extent	From the baseline upward without limit.

GROUNDING PENETRATION AT THE FORWARD END BUT EXCLUDING ANY DAMAGE AFT OF A POINT 0.3L AFT OF THE FORWARD PERPENDICULAR

Longitudinal extent	0.495L ^{2/3} or 47.6 feet ((1/3)L ^{2/3} or 14.5m) whichever is shorter.
Transverse extent	B/6 or 32.81 feet (10m) whichever is shorter but not less than 16.41 feet (5m).
Vertical extent from the baseline.	B/15 or 19.7 feet (6m) whichever is shorter.

GROUNDING PENETRATION AT ANY OTHER LONGITUDINAL POSITION

Longitudinal extent	L/10 or 16.41 feet (5m) whichever is shorter.
Transverse extent	16.41 feet (5m).
Vertical extent from the baseline.	B/15 or 19.7 feet (6m) whichever is shorter.

GROUNDING PENETRATION FOR RAKING DAMAGE

For tank vessels of 20,000 DWT and above, the following assumed bottom raking damage must supplement the damage assumptions:

Longitudinal extent	For vessels of 75,000 DWT and above, 0.6L measured from the forward perpendicular.
.....	For vessels of less than 75,000 DWT, 0.4L measured from the forward perpendicular.
Transverse extent	B/3 anywhere in the bottom.
Vertical extent	Breach of the outer hull.

¹ Damage applied inboard from the vessel's side at right angles to the centerline at the level of the summer load line assigned under Subchapter E of this chapter.

TABLE 172.065(b)—PERMEABILITY

Spaces and tanks	Permeability (percent)
Storeroom spaces	60.
Accommodation spaces	95.
Voids	95.
Consumable liquid tanks	95 or 0. ¹
Other liquid tanks	95 or 0. ²

¹ Whichever results in the more disabling condition.
² If tanks are partially filled, the permeability must be determined from the actual density and amount of liquid carried.

46 CFR Ch. I (10–1–14 Edition)

[CGD 79–023, 48 FR 51040, Nov. 4, 1983, as amended by USCG–2000–7641, 66 FR 55574, Nov. 2, 2001; USCG–2014–0688, 79 FR 58287, Sept. 29, 2014]

§ 172.070 Intact stability.

All tank vessels of 5,000 deadweight tons (DWT) and above, contracted after December 3, 2001, must comply with the intact stability requirements of IMO Res. MEPC.117(52) (incorporated by reference, see § 172.020).

[USCG–2007–0030, 75 FR 78086, Dec. 14, 2010]

Subpart E—Special Rules Pertaining to a Barge That Carries a Hazardous Liquid Regulated Under Subchapter O of This Chapter

§ 172.080 Specific applicability.

This subpart applies to each tank barge that carries a cargo listed in Table 151.05 of this chapter.

[CGD 79–023, 48 FR 51040, Nov. 4, 1983, as amended by USCG–2009–0702, 74 FR 49239, Sept. 25, 2009]

§ 172.085 Hull type.

If a cargo listed in Table 151.05 of part 151 of this chapter is to be carried, the tank barge must be at least the hull type specified in Table 151.05 of this chapter for that cargo.

§ 172.087 Cargo loading assumptions.

(a) The calculations required in this subpart must be done for cargo weights and densities up to and including the maximum that is to be endorsed on the Certificate of Inspection in accordance with § 151.04–1(c) of this chapter.

(b) For each condition of loading and operation, each cargo tank must be assumed to have its maximum free surface.

§ 172.090 Intact transverse stability.

(a) Except as provided in paragraph (b) of this section, each tank barge must be shown by design calculations to have a righting arm curve with the following characteristics:

(1) If the tank barge is in river service, the area under the righting arm curve must be at least 5 foot-degrees (1.52 meter-degrees) up to the smallest of the following angles:

(i) The angle of maximum righting arm.

(ii) The downflooding angle.

(2) If the tank barge is in lakes, bays and sounds or Great Lakes summer service, the area under the righting arm curve must be at least 10 foot-degrees (3.05 meter-degrees) up to the smallest of the following angles:

(i) The angle of maximum righting arm.

(ii) The downflooding angle.

(3) If the tank barge is in ocean or Great Lakes winter service, the area under the righting arm curve must be at least 15 foot-degrees (4.57 meter-degrees) up to the smallest of the following angles:

(i) The angle of maximum righting arm.

(ii) The downflooding angle.

(b) If the vertical center of gravity of the cargo is below the weather deck at the side of the tank barge amidships, it must be shown by design calculations that the barge has at least the following metacentric height (GM) in feet (meters) in each condition of loading and operation:

$$GM = \frac{(K)(B)}{fe}$$

where—

K=0.3 for river service.

K=0.4 for lakes, bays and sounds and Great Lakes summer service.

K=0.5 for ocean and Great Lakes winter service.

B=beam in feet (meters).

fe=effective freeboard in feet (meters).

(c) The effective freeboard is given by—

fe=f + fa ; or

fe=d, whichever is less.

where—

f=the freeboard to the deck edge amidships in feet (meters).

fa=(1.25)(a/L)((2b/B)-1)(h); or

fa=h, whichever is less.

where—

a=trunk length in feet (meters).

L=LOA in feet (meters)

b=breadth of a watertight trunk in feet (meters).

B=beam of the barge in feet (meters).

h=height of a watertight trunk in feet (meters).

d=draft of the barge in feet (meters).

(d) For the purpose of this section, downflooding angle means the static angle from the intersection of the vessel's centerline and waterline in calm water to the first opening that does not close watertight automatically.

§ 172.095 Intact longitudinal stability.

Each tank barge must be shown by design calculations to have a longitudinal metacentric height (GM) in feet (meters) in each condition of loading and operation, at least equal to the following:

$$GM = \frac{0.02(L)^2}{d}$$

where—

L=LOA in feet (meters)

d=draft in feet (meters).

§ 172.100 Watertight integrity.

(a) Except as provided in paragraph (b) of this section, each Type I or II hopper barge hull must have a weather-tight weather deck.

(b) If a Type I or II barge hull has an open hopper, the fully loaded barge must be shown by design calculations to have at least 2 inches (50 mm) of positive GM when the hopper space is flooded to the height of the weather deck.

(c) When doing the calculations required by this section, credit may be given for the buoyancy of the immersed portion of cargo tanks if the tank securing devices are shown by design calculations to be strong enough to hold the tanks in place when they are subjected to the buoyant forces resulting from the water in the hopper.

§ 172.103 Damage stability.

Each tank barge must be shown by design calculations to meet the survival conditions in §172.110 assuming the damage specified in §172.104 to the hull type specified in Table 151.05 of part 151 of this chapter.

§ 172.104 Character of damage.

(a) *Type I barge hull not in an integrated tow.* If a Type I hull is required and the barge is not a box barge designed for use in an integrated tow, design calculations must show that the

§ 172.105

46 CFR Ch. I (10–1–14 Edition)

barge can survive damage at any location including the intersection of a transverse and a longitudinal bulkhead.

(b) *Type I barge hull in an integrated tow.* If a Type I barge hull is required and the barge is a box barge designed for operation in an integrated tow, design calculations must show that the barge can survive damage—

(1) At any location on the bottom of the tank barge except on a transverse watertight bulkhead; and

(2) At any location on the side of the tank barge including on a transverse watertight bulkhead.

(c) *Type II barge hull.* If a Type II hull is required, design calculations must show that a barge can survive damage at any location except on a transverse watertight bulkhead.

§ 172.105 Extent of damage.

For the purpose of § 172.103, design calculations must include both side and bottom damage, applied separately. Damage must consist of the most disabling penetration up to and including penetrations having the following dimensions:

(a) Side damage must be assumed to be as follows:

(1) Longitudinal extent—6 feet (183 centimeters).

(2) Transverse extent—30 inches (76 centimeters).

(3) Vertical extent—from the baseline upward without limit.

(b) Bottom damage must be assumed to be 15 inches (38 centimeters) from the baseline upward.

§ 172.110 Survival conditions.

(a) Paragraphs (c) and (d) of this section apply to a hopper barge and paragraphs (e) through (i) apply to all other tank barges.

(b) A barge is presumed to survive assumed damage if it meets the following conditions in the final stage of flooding:

(c) A hopper barge must not heel or trim beyond the angle at which—

(1) The deck edge is first submerged; or

(2) If the barge has a coaming that is at least 36 inches (91.5 centimeters) in height, the intersection of the deck and the coaming is first submerged, except

as provided in paragraph (d) of this section.

(d) A hopper barge must not heel beyond the angle at which the deck edge is first submerged by more than “fa” as defined in § 172.090(c).

(e) Except as provided in paragraphs (h) and (i) of this section, each tank barge must not heel beyond the angle at which—

(1) The deck edge is first submerged; or

(2) If the barge has one or more watertight trunks, the deck edge is first submerged by more than “fa” as defined in § 172.090(c).

(f) Except as provided in paragraphs (h) and (i) of this section, a tank barge must not trim beyond the angle at which—

(1) The deck edge is first submerged; or

(2) If the barge has one or more watertight trunks, the intersection of the deck and the trunk is first submerged.

(g) If a tank barge experiences simultaneous heel and trim, the trim requirements in paragraph (f) of this section apply only at the centerline.

(h) Except as provided in paragraph (i) of this section, in no case may any part of the actual cargo tank top be underwater in the final condition of equilibrium.

(i) If a barge has a “step-down” in hull depth on either or both ends and all cargo tank openings are located on the higher deck level, the deck edge and tank top in the stepped-down area may be submerged.

Subpart F—Special Rules Pertaining to a Ship That Carries a Hazardous Liquid Regulated Under Subchapter O of This Chapter

§ 172.125 Specific applicability.

This subpart applies to each tankship that carries a cargo listed in Table I of part 153 of this chapter, except that it does not apply to a tankship whose cargo tanks are clean and gas free.

§ 172.127 Definitions.

Length or *L* means load line length (LLL).

§ 172.130 Calculations.

(a) Except as provided in §153.7 of this chapter, each tankship must be shown by design calculations to meet the survival conditions in §172.150 in each condition of loading and operation assuming the damage specified in §172.133 for the hull type prescribed in part 153 of this chapter.

(b) If a cargo listed in Table I of part 153 of this chapter is to be carried, the vessel must be at least the hull type specified in part 153 of this chapter for that cargo.

[CGD 79-023, 48 FR 51040, Nov. 4, 1983, as amended by CGD 81-101, 52 FR 7799, Mar. 12, 1987]

§ 172.133 Character of damage.

(a) If a type I hull is required, design calculations must show that the vessel can survive damage at any location.

(b) Except as provided in §153.7 of this chapter, if a type II hull is required, design calculations must show that a vessel—

(1) Longer than 492 feet (150 meters) in length can survive damage at any location; and

(2) Except as specified in paragraph (d) of this section, 492 feet (150 meters) or less in length can survive damage at any location.

(c) If a Type III hull is required, design calculations must show that a vessel—

(1) Except as specified in paragraph (d) of this section, 410 feet (125 meters) in length or longer can survive damage at any location; and

(2) Less than 410 feet (125 meters) in length can survive damage at any location except to an aft machinery space.

(d) A vessel described in paragraph (b)(2) or (c)(1) of this section need not be designed to survive damage to a main transverse watertight bulkhead bounding an aft machinery space. Except as provided in §153.7 of this chapter, the machinery space must be calculated as a single floodable compartment.

[CGD 79-023, 48 FR 51040, Nov. 4, 1983, as amended by CGD 81-101, 52 FR 7799, Mar. 12, 1987]

§ 172.135 Extent of damage.

For the purpose of § 172.133—

(a) Design calculations must include both side and bottom damage, applied separately; and

(b) Damage must consist of the penetrations having the dimensions given in Table 172.135 except that, if the most disabling penetrations would be less than the penetrations given in Table 172.135, the smaller penetration must be assumed.

TABLE 172.135—EXTENT OF DAMAGE

COLLISION PENETRATION	
Longitudinal extent	0.495L ^{2/3} or 47.6 feet ((1/3)L ^{2/3} or 14.5m) whichever is shorter.
Transverse extent ¹	B/5 or 37.74 feet (11.5m) ² whichever is shorter.
Vertical extent	From the baseline upward without limit.
GROUNDING PENETRATION AT THE FORWARD END BUT EXCLUDING ANY DAMAGE AFT OF A POINT 0.3L AFT OF THE FORWARD PERPENDICULAR	
Longitudinal extent	L/10.
Transverse extent	B/6 or 32.81 feet (10m) whichever is shorter.
Vertical extent from the baseline upward.	B/15 or 19.7 feet (6m) whichever is shorter.
GROUNDING PENETRATION AT ANY OTHER LONGITUDINAL POSITION	
Longitudinal extent	L/10 or 16.41 feet (5m) whichever is shorter.
Transverse extent	16.41 feet (5m).
Vertical extent from the baseline upward.	B/15 or 19.7 feet (6m) whichever is shorter.

¹ Damage applied inboard from the vessel's side at right angles to the centerline at the level of the summer load line assigned under Subchapter E of this chapter.

² B is measured amidships.

§ 172.140 Permeability of spaces.

(a) When doing the calculations required in §172.130, the permeability of a floodable space other than a machinery space must be as listed in Table 172.060(b).

(b) Calculations in which a machinery space is treated as a floodable space must be based on an assumed machinery space permeability of 0.85, unless the use of an assumed permeability of less than 0.85 is justified in detail.

(c) If a cargo tank would be penetrated under the assumed damage, the cargo tank must be assumed to lose all cargo and refill with salt water up to the level of the tankship's final equilibrium waterline.

§ 172.150 Survival conditions.

A tankship is presumed to survive assumed damage if it meets the following conditions in the final stage of flooding:

§ 172.155

46 CFR Ch. I (10–1–14 Edition)

(a) *Final waterline.* The final waterline, in the final condition of sinkage, heel, and trim, must be below the lower edge of openings such as air pipes and openings closed by weathertight doors or hatch covers. The following types of openings may be submerged when the tankship is at the final waterline:

(1) Openings covered by watertight manhole covers or watertight flush scuttles.

(2) Small watertight cargo tank hatch covers.

(3) A Class 1 door in a watertight bulkhead within the superstructure.

(4) Remotely operated sliding watertight doors.

(5) Side scuttles of the non-opening type.

(b) *Heel angle.* (1) Except as described in paragraph (b)(2) of this section, the maximum angle of heel must not exceed 15 degrees (17 degrees if no part of the freeboard deck is immersed).

(2) The Commanding Officer, Marine Safety Center will consider on a case by case basis each vessel 492 feet (150 meters) or less in length having a final heel angle greater than 17 degrees but less than 25 degrees.

(c) *Range of stability.* Through an angle of 20 degrees beyond its position of equilibrium after flooding, a tankship must meet the following conditions:

(1) The righting arm curve must be positive.

(2) The maximum righting arm must be at least 3.95 inches (10 cm).

(3) Each submerged opening must be weathertight.

(d) *Progressive flooding.* Pipes, ducts or tunnels within the assumed extent of damage must be either—

(1) Equipped with arrangements such as stop check valves to prevent progressive flooding to other spaces with which they connect; or

(2) Assumed in the design calculations required by §172.130 to flood the spaces with which they connect.

(e) *Buoyancy of superstructure.* The buoyancy of any superstructure directly above the side damage is to be disregarded. The unflooded parts of superstructures beyond the extent of damage may be taken into consideration if they are separated from the damaged space by watertight bulk-

heads and no progressive flooding of these intact spaces takes place.

(f) *Metacentric height.* After flooding, the tankship's metacentric height must be at least 2 inches (50mm) when the ship is in the upright position.

(g) *Equalization arrangements.* Flooding equalization arrangements requiring mechanical operation such as valves or cross-flooding lines may not be assumed to reduce the angle of heel. Spaces joined by ducts of large cross sectional area are treated as common spaces.

(h) *Intermediate stages of flooding.* If an intermediate stage of flooding is more critical than the final stage, the tankship must be shown by design calculations to meet the requirements in this section in the intermediate stage.

[CGD 79-023, 48 FR 51040, Nov. 4, 1983, as amended by CGD 88-070, 53 FR 34537, Sept. 7, 1988]

Subpart G—Special Rules Pertaining to a Ship That Carries a Bulk Liquefied Gas Regulated Under Subchapter O of This Chapter

§ 172.155 Specific applicability.

This subpart applies to each tankship that has on board a bulk liquefied gas listed in Table 4 of part 154 of this chapter as cargo, cargo residue, or vapor.

§ 172.160 Definitions.

As used in this subpart—

(a) *Length* or *L* means the load line length (LLL).

(b) *MARVS* means the Maximum Allowable Relief Valve Setting of a cargo tank.

§ 172.165 Intact stability calculations.

(a) Design calculations must show that 2 inches (50mm) of positive metacentric height can be maintained by each tankship when it is being loaded and unloaded.

(b) For the purpose of demonstrating compliance with the requirements of paragraph (a) of this section, the effects of the addition of water ballast may be considered.

§ 172.170 Damage stability calculations.

(a) Each tankship must be shown by design calculations to meet the survival conditions in § 172.195 in each condition of loading and operation assuming the damage specified in § 172.175 for the hull type specified in Table 4 of part 154 of this chapter.

(b) If a cargo listed in Table 4 of part 154 of this chapter is to be carried, the vessel must be at least the ship type specified in Table 4 of part 154 of this chapter for the cargo.

§ 172.175 Character of damage.

(a) If a type IG hull is required, design calculations must show that the vessel can survive damage at any location.

(b) If a type IIG hull is required, design calculations must show that a vessel—

(1) Longer than 492 feet (150 meters) in length can survive damage at any location; and

(2) 492 feet (150 meters) or less in length can survive damage at any location except the transverse bulkheads bounding an aft machinery space. The machinery space is calculated as a single floodable compartment.

(c) If a vessel has independent tanks type C with a MARVS of 100 psi (689 kPa) gauge or greater, is 492 feet (150 meters) or less in length, and Table 4 of part 154 of this chapter allows a type IIPG hull, design calculations must show that the vessel can survive damage at any location, except as prescribed in paragraph (e) of this section.

(d) If a type IIIG hull is required, except as specified in paragraph (e) of this section, design calculations must show that a vessel—

(1) 410 feet (125 meters) in length or longer can survive damage at any location; and

(2) Less than 410 feet (125 meters) in length can survive damage at any location, except in the main machinery space.

(e) The calculations in paragraphs (c) and (d) of this section need not assume damage to a transverse bulkhead unless it is spaced closer than the longitudinal extent of collision penetration specified in Table 172.180 from another transverse bulkhead.

(f) If a main transverse watertight bulkhead or transverse watertight bulkhead bounding a side tank or double bottom tank has a step or a recess that is longer than 10 feet (3.05 meters) located within the extent of penetration of assumed damage, the vessel must be shown by design calculations to survive damage to this bulkhead. The step formed by the after peak bulkhead and after peak tank top is not a step for the purpose of this regulation.

§ 172.180 Extent of damage.

For the purpose of § 172.170—

(a) Design calculations must include both side and bottom damage, applied separately; and

(b) Damage must consist of the penetrations having the dimensions given in Table 172.180 except that, if the most disabling penetrations would be less than the penetrations given in Table 172.180, the smaller penetration must be assumed.

TABLE 172.180—EXTENT OF DAMAGE

COLLISION PENETRATION	
Longitudinal extent	0.495L ^{2/3} or 47.6 feet ((1/3)L ^{2/3} or 14.5m) whichever is shorter.
Transverse extent ¹	B/5 or 37.74 feet (11.5m) ² whichever is shorter.
Vertical extent	From the baseline upward without limit.
GROUNDING PENETRATION AT THE FORWARD END BUT EXCLUDING ANY DAMAGE AFT OF A POINT 0.3L AFT OF THE FORWARD PERPENDICULAR	
Longitudinal extent	0.495L ^{2/3} or 47.6 feet ((1/3)L ^{2/3} or 14.5m) whichever is shorter.
Transverse extent	B/6 or 32.81 feet (10m) whichever is shorter.
Vertical extent from the molded line of the shell at the centerline.	B/15 or 6.6 feet (2m) whichever is shorter.
GROUNDING PENETRATION AT ANY OTHER LONGITUDINAL POSITION	
Longitudinal extent	L/10 or 16.41 feet (5m) whichever is shorter.
Transverse extent	B/6 or 16.41 feet (5m) whichever is shorter.
Vertical extent from the molded line of the shell at the centerline.	B/15 or 6.6 feet (2m) whichever is shorter.

¹ Damage applied inboard from the vessel's side at right angles to the centerline at the level of the summer load line assigned under Subchapter E of this chapter.

² B is measured amidships.

§ 172.185 Permeability of spaces.

(a) When doing the calculations required in § 172.170, the permeability of a floodable space other than a machinery

§ 172.195

space must be as listed in Table 172.060(b).

(b) Calculations in which a machinery space is treated as a floodable space must be based on an assumed machinery space permeability of 85%, unless the use of an assumed permeability of less than 85% is justified in detail.

(c) If a cargo tank would be penetrated under the assumed damage, the cargo tank must be assumed to lose all cargo and refill with salt water up to the level of the tankship's final equilibrium waterline.

§ 172.195 Survival conditions.

A vessel is presumed to survive assumed damage if it meets the following conditions in the final stage of flooding:

(a) *Final waterline.* The final waterline, in the final condition of sinkage, heel, and trim, must be below the lower edge of an opening through which progressive flooding may take place, such as an air pipe, or an opening that is closed by means of a weathertight door or hatch cover. This opening does not include an opening closed by a—

- (1) Watertight manhole cover;
- (2) Flush scuttle;
- (3) Small watertight cargo tank hatch cover that maintains the high integrity of the deck;
- (4) A Class 1 door in a watertight bulkhead within the superstructure;
- (5) Remotely operated sliding watertight door; or
- (6) A side scuttle of the non-opening type.

(b) *Heel angle.* The maximum angle of heel must not exceed 30 degrees.

(c) *Range of stability.* Through an angle of 20 degrees beyond its position of equilibrium after flooding, a tankship must meet the following conditions:

- (1) The righting arm curve must be positive.
- (2) The maximum righting arm must be at least 3.94 inches (10 cm).
- (3) Each submerged opening must be weathertight.

(d) *Progressive flooding.* If pipes, ducts, or tunnels are within the assumed extent of damage, arrangements must be made to prevent progressive flooding to a space that is not assumed

46 CFR Ch. I (10–1–14 Edition)

to be flooded in the damaged stability calculations.

(e) *Buoyancy of superstructure.* The buoyancy of any superstructure directly above the side damage is to be disregarded. The unflooded parts of superstructures beyond the extent of damage may be taken into consideration if they are separated from the damaged space by watertight bulkheads and no progressive flooding of these intact spaces takes place.

(f) *Metacentric height.* After flooding, the tank ship's metacentric height must be at least 2 inches (50 mm) when the vessel is in the upright position.

(g) *Equalization arrangements.* Equalization arrangements requiring mechanical aids such as valves or cross-flooding lines may not be considered for reducing the angle of heel. Spaces joined by ducts of large cross-sectional area are treated as common spaces.

(h) *Intermediate stages of flooding.* If an intermediate stage of flooding is more critical than the final stage, the tank vessel must be shown by design calculations to meet the requirements in this section in the intermediate stage.

§ 172.205 Local damage.

(a) Each tankship must be shown by design calculations to meet the survival conditions in paragraph (b) of this section in each condition of loading and operation assuming that local damage extending 30 inches (76 cm) normal to the hull shell is applied at any location in the cargo length:

(b) The vessel is presumed to survive assumed local damage if it does not heel beyond the smaller of the following angles in the final stage of flooding:

- (1) 30 degrees.
- (2) The angle at which restoration of propulsion and steering, and use of the ballast system is precluded.

Subpart H—Special Rules Pertaining to Great Lakes Dry Bulk Cargo Vessels

SOURCE: CGD 80-159, 51 FR 33059, Sept. 18, 1986, unless otherwise noted.

§ 172.215 Specific applicability.

This subpart applies to each new Great Lakes vessel of 1600 gross tons or more carrying dry cargo in bulk.

§ 172.220 Definitions.

(a) As used in this subpart *Length (L)*, *Breadth (B)*, and *Molded Depth (D)* are as defined in §45.3 of this chapter.

(b) As used in this part *new Great Lakes Vessel* means a vessel operating solely within the limits of the Great Lakes as defined in this subchapter that:

(1) Was contracted for on or after November 17, 1986, or delivered on or after November 17, 1988.

(2) Has undergone a major conversion under a contract made on or after November 17, 1986, or completed a major conversion on or after November 17, 1987.

[CGD 80-159, 51 FR 33059, Sept. 18, 1986]

§ 172.225 Calculations.

(a) Each vessel must be shown by design calculations to meet the survival conditions in §172.245 in each condition of loading and operation, assuming the damage specified in §172.230.

(b) When doing the calculations required by paragraph (a) of this section, the virtual increase in the vertical center of gravity due to a liquid in a space must be determined by calculating either—

(1) The free surface effect of the liquid with the vessel assumed heeled five degrees from the vertical; or

(2) The shift of the center of gravity of the liquid by the moment of transference method.

(c) In calculating the free surface effect of consumable liquids, it must be assumed that, for each type of liquid, at least one transverse pair of wing tanks or a single centerline tank has a free surface. The tank or combination of tanks selected must be those having the greatest free surface effect.

(d) When doing the calculations required by paragraph (a) of this section, the buoyancy of any superstructure directly above the side damage must not be considered. The unflooded parts of superstructures beyond the extent of damage may be considered if they are separated from the damaged space by

watertight bulkheads and no progressive flooding of these intact spaces takes place.

§ 172.230 Character of damage.

(a) Design calculations must show that each vessel can survive damage—

(1) To any location between adjacent main transverse watertight bulkheads;

(2) To any location between a main transverse bulkhead and a partial transverse bulkhead in way of a side wing tank;

(3) To a main or wing tank transverse watertight bulkhead spaced closer than the longitudinal extent of collision penetration specified in Table 172.235 to another main transverse watertight bulkhead; and

(4) To a main transverse watertight bulkhead or a transverse watertight bulkhead bounding a side tank or double bottom tank if there is a step or a recess in the transverse bulkhead that is longer than 10 feet (3.05 meters) and that is located within the extent of penetration of assumed damage. The step formed by the after peak bulkhead and after peak tank top is not a step for the purpose of this paragraph.

§ 172.235 Extent of damage.

For the purpose of the calculations required in §172.225—

(a) Design calculations must include both side and bottom damage, applied separately; and

(b) Damage must consist of the penetrations having the dimensions given in Table 172.235 except that, if the most disabling penetrations would be less than the penetrations described in this paragraph, the smaller penetration must be assumed.

TABLE 172.235—EXTENT OF DAMAGE

Collision Penetration	
Longitudinal extent	0.495 L ^{2/3} or 47.6 feet. (1/3 L ^{2/3} or 14.5 m), whichever is less.
Transverse extent	4 feet 2 inches (1.25 m). ¹
Vertical extent	From the baseline upward without limit.
Grounding Penetration Forward of a Point 0.3L Aft of the Forward Perpendicular	
Longitudinal	0.495 L ^{2/3} or 47.6 feet. (1/3 L ^{2/3} or 14.5 m), whichever is less.

§ 172.240

TABLE 172.235—EXTENT OF DAMAGE—Continued

Transverse	B/6 or 32.8 feet (10 m), whichever is less, but not less than 16.4 feet (5 m). ¹
Vertical extent	0.75 m from the baseline.
Grounding Penetration at Any Other Longitudinal Position	
Longitudinal extent	L/10 or 16.4 feet (5 m), whichever is less.
Transverse	4 feet 2 inches (1.25 m).
Vertical extent	2 feet 6 inches (0.75 m) from the baseline.

¹ Damage applied inboard from the vessel's side at right angles to the centerline at the level of the summer load line assigned under Subchapter E of this chapter.

§ 172.240 Permeability of spaces.

When doing the calculations required in § 172.225,

(a) The permeability of a floodable space, other than a machinery or cargo space, must be assumed as listed in Table 172.240;

(b) Calculations in which a machinery space is treated as a floodable space must be based on an assumed machinery space permeability of 85% unless the use of an assumed permeability of less than 85% is justified in detail; and

(c) Calculations in which a cargo space that is completely filled is considered flooded must be based on an assumed cargo space permeability of 60% unless the use of an assumed permeability of less than 60% is justified in detail. If the cargo space is not completely filled, a cargo space permeability of 95% must be assumed unless the use of an assumed permeability of less than 95% is justified in detail.

TABLE 172.240—PERMEABILITY

Spaces and tanks	Permeability (percent)
Storeroom spaces	60
Accommodations spaces	95
Voids	95
Consumable liquid tanks	¹ 95 or 0
Other liquid tanks	² 95 or 0
Cargo (completely filled)	60
Cargo (empty)	95
Machinery	85

¹ Whichever results in the more disabling condition.
² If tanks are partially filled, the permeability must be determined from the actual density and amount of liquid carried.

§ 172.245 Survival conditions.

A vessel is presumed to survive assumed damage if it meets the following

conditions in the final stage of flooding:

(a) *Final waterline.* The final waterline, in the final condition of sinkage, heel, and trim must be below the lower edge of an opening through which progressive flooding may take place, such as an air pipe, or an opening that is closed by means of a weathertight door or hatch cover. This opening does not include an opening closed by a:

- (1) Watertight manhole cover;
- (2) Flush scuttle;
- (3) Small watertight cargo tank hatch cover that maintains the high integrity of the deck;
- (4) Class 1 door in a watertight bulkhead;
- (5) Remotely operated sliding watertight door;
- (6) Side scuttle of the nonopening type;
- (7) Retractable inflatable seal; or
- (8) Guillotine door.

(b) *Heel angle.* The maximum angle of heel must not exceed 15 degrees, except that this angle may be increased to 17 degrees if no deck edge immersion occurs.

(c) *Range of stability.* Through an angle of 20 degrees beyond its position of equilibrium after flooding, a vessel must meet the following conditions:

- (1) The righting arm curve must be positive.
- (2) The maximum righting arm must be at least 4 inches (10 cm).
- (3) Each submerged opening must be weathertight

(d) *Metacentric height.* After flooding, the metacentric height must be at least 2 inches (50 mm) when the vessel is in the equilibrium position.

(e) *Progressive flooding.* In the design calculations required by § 172.225, progressive flooding between spaces connected by pipes, ducts or tunnels must be assumed unless:

- (1) Pipes within the assumed extent of damage are equipped with arrangements such as stop check valves to prevent progressive flooding to other spaces with which they connect; and,
- (2) Progressive flooding through ducts or tunnels is protected against by:
 - (i) Retractable inflatable seals to cargo hopper gates; or

(ii) Guillotine doors in bulkheads in way of the conveyor belt.

PART 173—SPECIAL RULES PERTAINING TO VESSEL USE

Subpart A—General

Sec.
173.001 Applicability.

Subpart B—Lifting

173.005 Specific applicability.
173.007 Location of the hook load.
173.010 Definitions.
173.020 Intact stability standards: Counterballasted and non-counterballasted vessels.
173.025 Additional intact stability standards: Counterballasted vessels.

Subpart C—School Ships

173.050 Specific applicability.
173.051 Public nautical school ships.
173.052 Civilian nautical school ships.
173.053 Sailing school vessels.
173.054 Watertight subdivision and damage stability standards for new sailing school vessels.
173.055 Watertight subdivision and damage stability standards for existing sailing school vessels.
173.056 Collision and other watertight bulkheads.
173.057 Permitted locations for Class I watertight doors.
173.058 Double bottom requirements.
173.059 Penetrations and openings in watertight bulkheads.
173.060 Openings in the side of a vessel below the bulkhead or weather deck.
173.061 Watertight integrity above the margin line.
173.062 Drainage of weather deck.
173.063 Intact stability requirements.

Subpart D—Oceanographic Research

173.070 Specific applicability.
173.075 Subdivision requirements.
173.080 Damage stability requirements.
173.085 General subdivision requirements.

Subpart E—Towing

173.090 General.
173.095 Towline pull criterion.

AUTHORITY: 43 U.S.C. 1333; 46 U.S.C. 2113, 3306, 5115; E.O. 12234, 45 FR 58801, 3 CFR, 1980 Comp., p. 277; Department of Homeland Security Delegation No. 0170.1.

SOURCE: CGD 79-023, 48 FR 51045, Nov. 4, 1983, unless otherwise noted.

Subpart A—General

§ 173.001 Applicability.

Each vessel that is engaged in one of the following activities must comply with the applicable provisions of this part:

- (a) Lifting.
- (b) Training (schoolship).
- (c) Oceanographic research.
- (d) Towing.

Subpart B—Lifting

§ 173.005 Specific applicability.

This subpart applies to each vessel that—

- (a) Is equipped to lift cargo or other objects; and
- (b) Has a maximum heeling moment due to hook load greater than or equal to—

$(0.67)(W)(GM)(F/B)$ in meter-metric tons (foot-long tons), where—

W=displacement of the vessel with the hook load included in metric (long) tons.

GM=metacentric height with hook load included in meters (feet).

F=freeboard to the deck edge amidships in meters (feet).

B=beam in meters (feet).

[CGD 79-023, 48 FR 51045, Nov. 4, 1983, as amended by CGD 85-080, 61 FR 945, Jan. 10, 1996]

§ 173.007 Location of the hook load.

When doing the calculations required in this subpart, the hook load must be considered to be located at the head of the crane.

§ 173.010 Definitions.

As used in this part—

(a) *Hook load* means the weight of the object lifted by the crane.

(b) *Crane radius* means the distance illustrated in Figure 173.010.

§ 173.020

46 CFR Ch. I (10-1-14 Edition)

Figure 173.010
Crane Radius

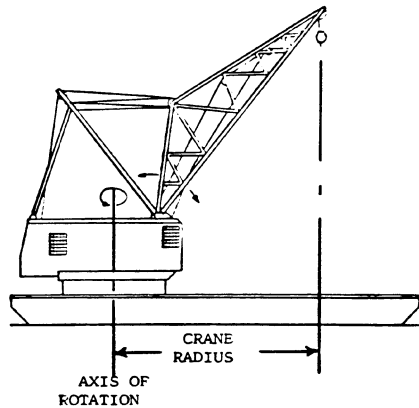

§ 173.020 Intact stability standards: Counterballasted and non-counterballasted vessels.

(a) Except as provided in paragraph (c) of this section, each vessel that is not equipped to counter-ballast while lifting must be shown by design calculations to comply with this section in each condition of loading and operation and at each combination of hook load and crane radius.

(b) Each vessel must have a righting arm curve with the following characteristics:

(1) If the vessel operates in protected or partially protected waters, the area under the righting arm curve up to the smallest of the following angles must be at least 10 foot-degrees (3.05 meter-degrees):

- (i) The angle corresponding to the maximum righting arm.
- (ii) The downflooding angle.
- (iii) 40 degrees.

(2) If the vessel operates in exposed waters, the area under the righting arm curve up to the smallest of the following angles must be at least 15 foot-degrees (4.57 meter-degrees):

- (i) The angle corresponding to the maximum righting arm.
- (ii) The downflooding angle.
- (iii) 40 degrees.

(c) If the vessel's hull proportions fall within all three of the following limits,

in lieu of complying with paragraph (b) of this section, the vessel owner may demonstrate in the presence of the OCMI that the vessel will not heel beyond the limits specified in paragraph (d) of this section:

- (1) Beam to depth—3.40 to 4.75.
- (2) Length to beam—3.20 to 4.50.
- (3) Draft to depth—0.60 to 0.85.

(d) For the purpose of paragraph (c) of this section, the following limits of heel apply with the vessel at its deepest operating draft:

- (1) Protected and partially protected waters and Great Lakes in summer—heel to main deck immersion or bilge emergence, whichever occurs first.
- (2) Exposed waters and Great Lakes in winter—heel permitted to one-half of the freeboard or one-half of the draft, whichever occurs first.

[CGD 79-023, 48 FR 51045, Nov. 4, 1983, as amended by CGD 85-080, 61 FR 945, Jan. 10, 1996]

§ 173.025 Additional intact stability standards: Counterballasted vessels.

(a) Each vessel equipped to counterballast while lifting must be shown by design calculations to be able to withstand the sudden loss of the hook load, in each condition of loading and operation and at each combination of hook load and crane radius.

(b) When doing the calculations required by this section, the hook load and counterballast heeling arms and vessel righting arms, as plotted on graph 173.025, must define areas that satisfy the following equation:

$$\text{Area II} > \text{Area I} + \text{K}$$

Where—

- (1) K=0 for operation on protected waters and 7 foot-degrees (2.13 meter-degrees) for operation on partially protected and exposed waters.
- (2) Areas I and II are shown on graph 173.025.

(c) Each heeling arm curve must be defined by—

$$\text{HA} = \text{HAO} \cos (T)$$

Where—

- HA=heeling arm.
- HAO=heeling arm at 0 degrees of heel.
- T=angle of heel.

GRAPH 173.025

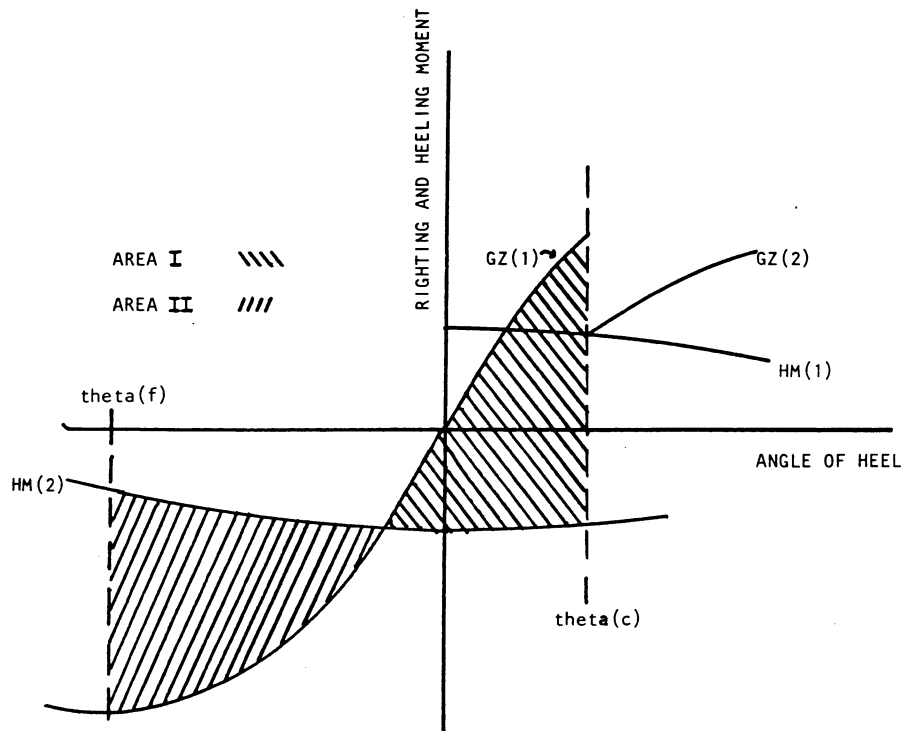

Where—

GZ(1) is the righting arm curve at the displacement corresponding to the vessel without hooking load.

GZ(2) is the righting arm curve at the displacement corresponding to the vessel with hook load.

HA(1) is the heeling arm curve due to the combined heeling moments of the hook load and the counterballast at the displacement with hook load.

HA(2) is the heeling arm due to the counterballast at the displacement without hook load.

Theta(c) is the angle of static equilibrium due to the combined hook load and counterballast heeling moments.

Theta(f) is the downflooding angle on the counterballasted side of the vessel.

[CGD 79-023, 48 FR 51045, Nov. 4, 1983, as amended by CGD 85-080, 61 FR 945, Jan. 10, 1996]

Subpart C—School Ships

§ 173.050 Specific applicability.

Each nautical school ship, inspected under Subchapter R of this chapter, must comply with this subpart.

§ 173.051 Public nautical school ships.

Each public nautical school ship must comply with—

- (a) Section 171.070(a) of this subchapter as a passenger vessel carrying 400 or less passengers;
- (b) Section 171.070(e) of this subchapter;
- (c) Section 171.072 of this subchapter; and
- (d) Section 171.073 of this subchapter.

[CGD 79-023, 48 FR 51045, Nov. 4, 1983. Redesignated by CGD 83-005, 51 FR 924, Jan. 9, 1986]

§ 173.052

§ 173.052 Civilian nautical school ships.

Each civilian nautical school ship must comply with part 171 of this subchapter as though it were a passenger vessel. In addition to regular passengers, for the purpose of complying with part 171, the following will also count as passengers;

- (a) A student.
- (b) A cadet.
- (c) An instructor who is not also a member of the crew.

[CGD 79-023, 48 FR 51045, Nov. 4, 1983. Redesignated by CGD 83-005, 51 FR 924, Jan. 9, 1986]

§ 173.053 Sailing school vessels.

(a) In addition to the requirements in §§173.054 through 173.063, each sailing school vessel must comply with the provisions of subpart A of part 171 of this subchapter.

(b) In addition to regular passengers, for the purpose of complying with §§171.070 through 171.073 and §171.080, the following will also be counted as passengers:

- (1) Sailing school students.
- (2) Sailing school instructors.
- (3) Guests.

[CGD 83-005, 51 FR 924, Jan. 9, 1986]

§ 173.054 Watertight subdivision and damage stability standards for new sailing school vessels.

(a) Each new sailing school vessel which has a mean length greater than 75 feet (22.8 meters) or which carries more than 30 persons must comply with—

- (1) Section 179.210(a) of this chapter;
- (2) Sections 171.070 through 171.073; and
- (3) Section 171.080 for Type II subdivision and damage stability.

(b) Each new sailing school vessel which has a mean length of 75 feet (22.8 meters) or less and carries more than 30 persons must comply with either—

- (1) Section 179.210(a) of this chapter and §179.220 of this chapter; or
- (2) Section 171.040(a)(1), §§171.070 through 171.073, and §171.080.

(c) Each new sailing school vessel which does not carry more than 30 persons must have a collision bulkhead unless it has a mean length less than 40 feet (12.2 meters) and is certificated for

46 CFR Ch. I (10-1-14 Edition)

protected or partially protected waters service only.

[CGD 83-005, 51 FR 924, Jan. 9, 1986, as amended by CGD 85-080, 61 FR 946, Jan. 10, 1996]

§ 173.055 Watertight subdivision and damage stability standards for existing sailing school vessels.

(a) Except as provided in paragraph (c) of this section, an existing sailing school vessel which carries more than 49 persons must be fitted with a collision bulkhead and any additional bulkheads necessary to provide one compartment subdivision.

(b) Except as provided in paragraph (c) of this section, an existing sailing school vessel which has a mean length greater than 65 feet (19.8 meters), must be fitted with additional transverse watertight bulkheads necessary to provide one compartment subdivision, when the following Subdivision Numerals are exceeded:

(1) For vessels to be operated on Exposed Waters:

$$L \times N > 4000$$

(2) For vessels to be operated on Partially Protected Waters:

$$L \times N > 4500$$

(3) For vessels to be operated on Protected Waters:

$$L \times N > 5000$$

where L is the mean length and N is the number of persons on board

(c) An existing sailing school vessel which is required to meet a one compartment subdivision standard and has a mean length of 90 feet (27.4 meters) or less may, instead of one compartment subdivision, be fitted with a collision bulkhead and sufficient air tankage or other internal buoyancy to maintain the fully-loaded vessel afloat with positive stability in the flooded condition.

(d) Except as provided in paragraph (e) of this section, an existing sailing school vessel which has a mean length greater than 65 feet (19.8 meters) must be fitted with a collision bulkhead.

(e) On an existing sailing school vessel, operating on protected waters, which has a mean length of 90 feet (27.4 meters) or less with no other requirement for subdivision, the collision bulkhead may be omitted.

(f) An existing sailing school vessel, operating on exposed waters, which has a mean length of 65 feet (19.8 meters) or less and is carrying more than 15 persons, must be fitted with a collision bulkhead.

[CGD 83-005, 51 FR 924, Jan. 9, 1986]

§ 173.056 Collision and other watertight bulkheads.

(a) Collision bulkheads required by this section must comply with the requirements in §171.085 of this subchapter.

(b) Each sailing school vessel required to meet paragraph (a) of §173.054 must comply with the machinery space bulkhead requirements in §171.095 of this subchapter.

[CGD 83-005, 51 FR 924, Jan. 9, 1986]

§ 173.057 Permitted locations for Class I watertight doors.

(a) Class I doors are permitted in any location on a sailing school vessel which has a mean length of 125 feet (38.1 meters) or less.

(b) Class I doors fitted in accordance with §170.270 of this subchapter shall additionally be marked in two-inch letters "RECLOSE AFTER USE", and be provided with a remote position indicator at the main navigating station of the vessel.

[CGD 83-005, 51 FR 924, Jan. 9, 1986]

§ 173.058 Double bottom requirements.

Each new sailing school vessel which has a mean length greater than 165 feet (50.3 meters) and is certificated for exposed water service must comply with the double bottom requirements in §§171.105 through 171.109, inclusive, of this subchapter.

[CGD 83-005, 51 FR 924, Jan. 9, 1986]

§ 173.059 Penetrations and openings in watertight bulkheads.

Penetrations and openings in watertight bulkheads must comply with the requirements in subpart E of part 171 of this subchapter or §§ 179.320, 179.330, and 179.340 in subchapter T of this chapter.

[CGD 83-005, 51 FR 924, Jan. 9, 1986, as amended by CGD 85-080, 61 FR 946, Jan. 10, 1996]

§ 173.060 Openings in the side of a vessel below the bulkhead or weather deck.

(a) Openings in the side of a vessel below the bulkhead or weather deck must comply with the requirements in subpart F of part 171 of this subchapter or §179.350 in subchapter T of this chapter.

(b) In addition to the requirements in paragraph (a) of this section, each sailing school vessel which has a mean length greater than 90 feet must comply with the requirements in §56.50-95 of Subchapter F of this chapter.

[CGD 83-005, 51 FR 924, Jan. 9, 1986, as amended by CGD 85-080, 61 FR 945, Jan. 10, 1996]

§ 173.061 Watertight integrity above the margin line.

The watertight integrity of each sailing school vessel above the margin line must comply with the requirements in subpart G of part 171 of this subchapter or §179.360 in subchapter T of this chapter.

[CGD 83-005, 51 FR 925, Jan. 9, 1986, as amended by CGD 85-080, 61 FR 946, Jan. 10, 1996; 61 FR 20556, May 7, 1996]

§ 173.062 Drainage of weather deck.

The weather deck of each sailing school vessel must be provided with drainage in accordance with the requirements in subpart H of part 171 of this subchapter or subpart D of part 178 in subchapter T of this chapter.

[CGD 83-005, 51 FR 925, Jan. 9, 1986, as amended by CGD 85-080, 61 FR 946, Jan. 10, 1996]

§ 173.063 Intact stability requirements.

(a) Except as provided in this section, each sailing school vessel must meet the intact stability requirements in §§170.170, 171.050, and 171.055 of this chapter.

(b) In applying the requirements in §§170.170 and 171.050 of this subchapter, the value of "T" is equal to the angle of heel at which the deck edge is immersed or $\frac{1}{3}$ of the downflooding angle, whichever is less.

(c) In applying the requirements of §171.055(d) (1) and (2) of this subchapter—

(1) The value "X" is equal to 0.6 long tons/square foot (9.8 metric tons/square meter).

§ 173.063

46 CFR Ch. I (10–1–14 Edition)

(2) For a vessel in service on protected or partially protected waters, values “Y” and “Z” are determined from graphs 173.063 (a) and (b) and multiplied by the multiplier in graph 173.063(e).

(3) For a vessel in service on exposed waters, “Y” and “Z” are determined from graphs 173.063 (c) and (d) and multiplied by the multiplier from graph 173.063(e).

(4) To convert required numerals to units of “metric tons/square meter,” multiply by 10.94.

(d) Each vessel of the open boat type that is required to comply with the requirements in §§178.300 and 178.310 of

this chapter, may instead comply with the requirements in paragraph (e) of this section.

(e) In lieu of complying with the requirements of paragraph (b) of this section, an open boat may be provided with sufficient air tankage or other internal buoyancy to maintain the vessel afloat when the vessel is completely flooded or capsized. If foam is used to comply with this paragraph, it must be installed in accordance with the requirements in §170.245 of this subchapter.

(f) A sailing school catamaran must meet the intact stability requirements in §171.057.

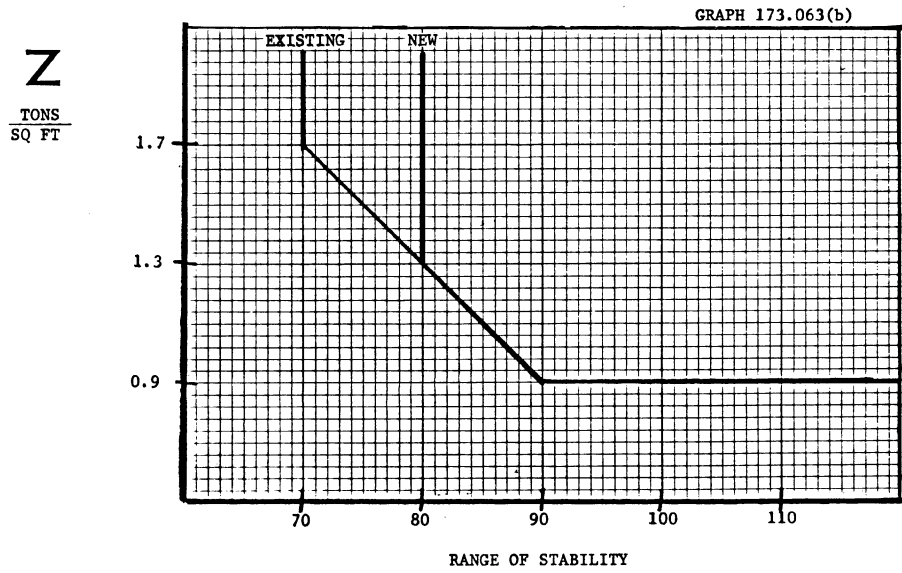
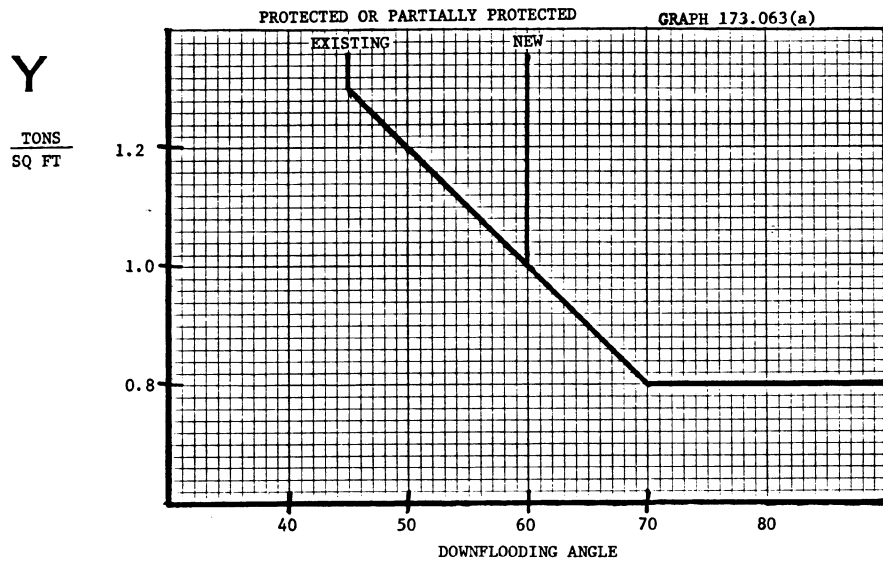

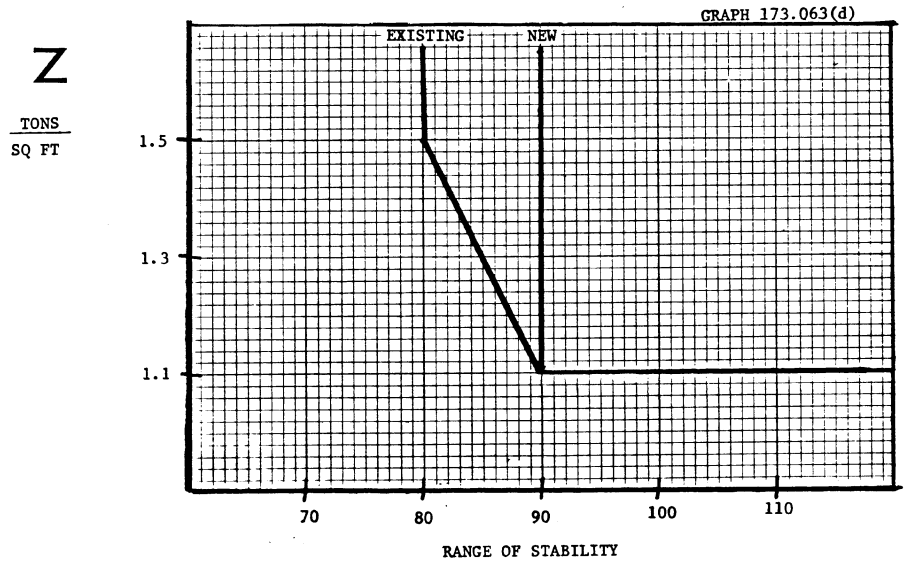
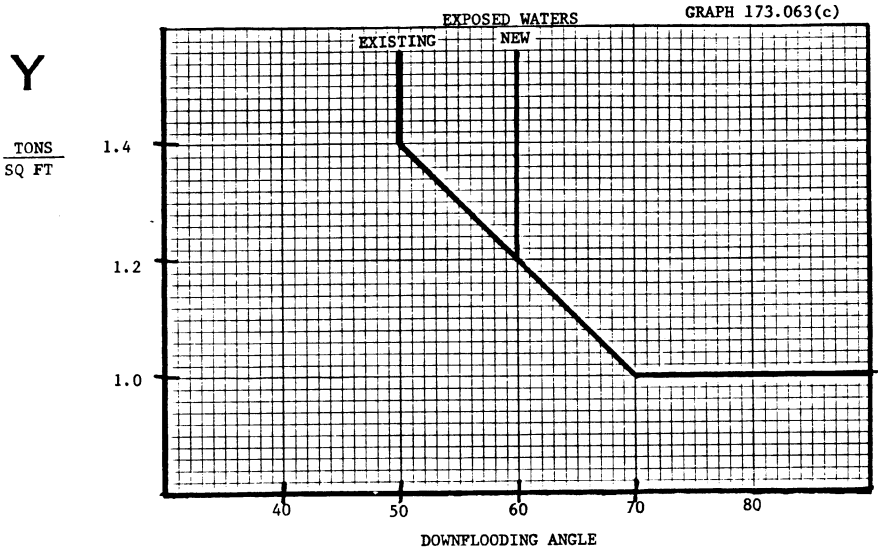

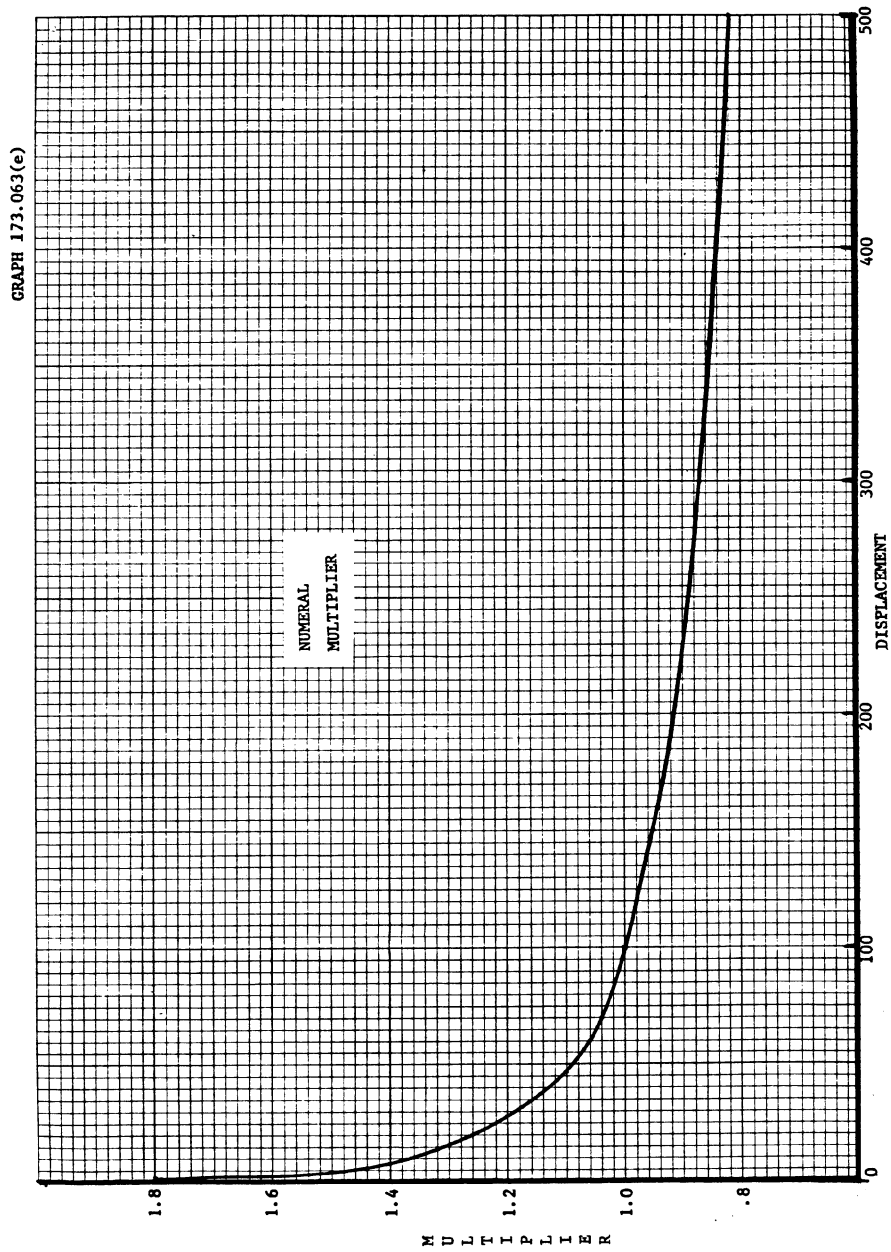

[CGD 83-005, 51 FR 925, Jan. 9, 1986, as amended by CGD 85-080, 61 FR 946, Jan. 10, 1996]

Subpart D—Oceanographic Research

§ 173.070 Specific applicability.

Each oceanographic vessel, inspected under Subchapter U of this chapter, except a barge that is less than 300 gross tons, must comply with this subpart.

§ 173.075 Subdivision requirements.

(a) Each oceanographic vessel must comply with the subdivision requirements in §§ 171.070, 171.072, and 171.073 of this subchapter as if it were a passenger vessel carrying 400 or less passengers.

(b) Each vessel must have a collision bulkhead.

§ 173.080 Damage stability requirements.

Each oceanographic vessel must comply with § 171.080 of this subchapter as a category Z vessel.

§ 173.085 General subdivision requirements.

Each oceanographic vessel must comply with the following:

(a) Section 171.085(c)(1), (d) and (g) of this subchapter.

(b) Section 171.105 (a) through (g) of this subchapter except that a reduction or elimination of the required inner bottom is allowed if—

(1) The inner bottom would interfere with the mission of the vessel; and

(2) As a result of other design features, the ability of the vessel to withstand side and bottom damage is not reduced.

(c) Section 171.106 of this subchapter.

(d) Section 171.108 of this subchapter.

(e) Section 171.109 of this subchapter.

(f) Section 171.111 of this subchapter.

(g) Section 171.113 of this subchapter.

(h) The collision bulkhead must not be penetrated by more than one pipe that carries liquid to or from the forepeak tank. This pipe must have a screwdown valve that is—

(1) Operative from above the bulkhead deck; and

(2) Attached to the bulkhead inside the forepeak tank.

(i) Section 171.116 (b), (c), and (e) of this subchapter.

(j) Section 171.117(c) of this subchapter.

(k) Each port light in a space located below the freeboard deck, as defined in § 42.13–15(i) of this chapter, or in a space within an enclosed superstructure must be fitted with a hinged inside dead cover.

(l) Section 171.118 (b) and (c) of this subchapter.

(m) Section 171.122 (a) through (d) and (f) of this subchapter.

(n) Section 171.135 of this subchapter.

(o) A ventilation duct or forced draft duct may not penetrate a main transverse watertight bulkhead unless—

(1) The penetration is watertight;

(2) The penetration is located as near the vessel's centerline as possible; and

(3) The bottom of the duct is not more than—

(i) 18 inches (45.7 cm) below the bulkhead deck; and

(ii) 4 feet (121.9 cm) above the final waterline after damage determined in § 173.080.

Subpart E—Towing

§ 173.090 General.

This subpart applies to each vessel that is equipped for towing.

§ 173.095 Towline pull criterion.

(a) In each towing condition, each vessel must be shown by design calculations to meet the requirements of either paragraph (b) or (c) of this section.

(b) The vessel's metacentric height (GM) must be equal to or greater than the following:

$$GM = \frac{(N)(P \times D)^{2/3}(s)(h)}{K\Delta(f/B)}$$

where—

N=number of propellers.

P=shaft power per shaft in horsepower (kilowatts).

D=propeller diameter in feet (meters).

s=that fraction of the propeller circle cylinder which would be intercepted by the rudder if turned to 45 degrees from the vessel's centerline.

h=vertical distance from propeller shaft centerline at rudder to towing bits in feet (meters).

Δ=displacement in long tons (metric tons).

f=minimum freeboard along the length of the vessel in feet (meters).

B=molded beam in feet (meters).

K=38 in English units.
K=13.93 in metric units.

(c) When a heeling arm curve, calculated in accordance with paragraph (d) of this section, is plotted against the vessel's righting arm curve—

(1) Equilibrium must be reached before the downflooding angle; and

(2) The residual righting energy must be at least 2 foot-degrees (.61 meter-degrees) up to the smallest of the following angles:

(i) The angle of maximum righting arm.

(ii) The downflooding angle.

(iii) 40 degrees.

(d) The heeling arm curve specified in paragraph (c) of this section must be calculated by the following equation:

$$HA = \frac{2(N)(P \times D)^2_3}{(s)(h)(\cos \theta)} \quad K\Delta$$

where—

HA=heeling arm.

θ =angle of heel.

N, P, D, K, s, h, and Δ are as defined in paragraph (b) of this section.

(e) For the purpose of this section, downflooding angle means the static angle from the intersection of the vessel's centerline and waterline in calm water to the first opening that does not close watertight automatically.

(f) For the purpose of this section, at each angle of heel, a vessel's righting arm may be calculated considering either—

(1) The vessel is permitted to trim free until the trimming moment is zero; or

(2) The vessel does not trim as it heels.

PART 174—SPECIAL RULES PERTAINING TO SPECIFIC VESSEL TYPES

Subpart A—General

Sec.

174.005 Applicability.

174.007 Incorporation by reference.

Subpart B—Special Rules Pertaining to Deck Cargo Barges

174.010 Specific applicability.

174.015 Intact stability.

174.020 Alternate intact stability criterion.

Subpart C—Special Rules Pertaining to Mobile Offshore Drilling Units

174.030 Specific applicability.

174.035 Definitions.

174.040 Stability requirements: general.

174.045 Intact stability requirements.

174.050 Stability on bottom.

174.055 Calculation of wind heeling moment (Hm).

174.065 Damage stability requirements.

174.070 General damage stability assumptions.

174.075 Compartments assumed flooded: general.

174.080 Flooding on self-elevating and surface type units.

174.085 Flooding on column stabilized units.

174.090 Permeability of spaces.

174.100 Appliances for watertight and weathertight integrity.

Subpart D [Reserved]

Subpart E—Special Rules Pertaining to Tugboats and Towboats

174.140 Specific applicability.

174.145 Intact stability requirements.

Subpart F [Reserved]

Subpart G—Special Rules Pertaining to Offshore Supply Vessels

174.180 Applicability.

174.185 Intact stability.

174.190 Collision bulkhead.

174.195 Bulkheads in machinery spaces.

174.200 Damaged stability in machinery spaces for all OSVs.

174.205 Additional damaged stability for OSVs carrying more than 16 offshore workers.

174.207 Damaged stability criteria.

174.210 Watertight doors in watertight bulkheads.

174.215 Drainage of weather deck.

174.220 Hatches and coamings.

174.225 Hull penetrations and shell connections.

Subpart H—Special Rules Pertaining to Liffboats

174.240 Applicability.

174.245 General.

174.250 Unrestricted service.

174.255 Restricted service.

174.260 Freeboard.

Subpart I—Hopper Dredges With Working Freeboard Assignments

174.300 Specific applicability.

§ 174.005

46 CFR Ch. I (10–1–14 Edition)

174.305 Definitions.

CALCULATIONS

174.310 General.
174.315 Extent and character of damage.
174.320 Damage survival.
174.325 Equalization.
174.330 Jettisoning of spoil.

DESIGN

174.335 Watertight doors.
174.340 Collision bulkhead.

Subpart J—Special Rules Pertaining to Dry Cargo Ships

174.350 Specific applicability.
174.355 Definitions.
174.360 Calculations.

AUTHORITY: 42 U.S.C. 9118, 9119, 9153; 43 U.S.C. 1333; 46 U.S.C. 3306, 3703; E.O. 12234, 45 FR 58801, 3 CFR, 1980 Comp., p. 277; Department of Homeland Security Delegation No. 0170.1. Section 174.180 also issued under sec. 617, Pub. L. 111–281, 124 Stat. 2905.

SOURCE: CGD 79–023, 48 FR 51048, Nov. 4, 1983, unless otherwise noted.

Subpart A—General

§ 174.005 Applicability.

Each of the following vessels must comply with the applicable provisions of this part:

- (a) Deck cargo barge.
- (b) Mobile offshore drilling unit (MODU) inspected under subchapter IA of this chapter.
- (c) Tugboat and towboat inspected under subchapter I of this chapter.
- (d) Self-propelled hopper dredge having an assigned working freeboard.
- (e) Oceangoing ships of 500 gross tons or over, as calculated by the International Convention on Tonnage Measurement of Ships, 1969, designed primarily for the carriage of dry cargoes, including roll-on/roll-off ships.
- (f) Offshore supply vessel inspected under subchapter L of this chapter.
- (g) Liftboat inspected under subchapter L of this chapter.

[CGD 95–012, 60 FR 48052, Sept. 18, 1995; 60 FR 50120, Sept. 28, 1995, as amended by CGD 82–004 and CGD 86–074, 60 FR 57671, Nov. 16, 1995; CGD 82–004 and CGD 86–074, 62 FR 49353, Sept. 19, 1997]

§ 174.007 Incorporation by reference.

(a) Certain material is incorporated by reference into this part with the ap-

proval of the Director of the Federal Register under 5 U.S.C. 552(a) and 1 CFR part 51. To enforce any edition other than that specified in this section, the Coast Guard must publish a notice of change in the FEDERAL REGISTER and the material must be available to the public. All approved material is available for inspection at the National Archives and Records Administration (NARA). For information on the availability of this material at NARA, call 202–741–6030 or go to http://www.archives.gov/federal_register/code_of_federal_regulations/ibr_locations.html. It is also available for inspection at Coast Guard Headquarters. Contact Commandant (CG–ENG–2), Attn: Naval Architecture Division, U.S. Coast Guard Stop 7509, 2703 Martin Luther King Jr. Avenue SE., Washington, DC 20593–7509. The material is also from the sources listed in paragraphs (b) and (c) of this section.

(b) American Society for Testing and Materials (ASTM) 100 Barr Harbor Drive, West Conshohocken, PA 19428–2959.

(1) ASTM F 1196–00, Standard Specification for Sliding Watertight Door Assemblies, 2008, incorporation by reference (IBR) approved for § 174.100.

(2) ASTM F 1197–00, Standard Specification for Sliding Watertight Door Control Systems, 2007, IBR approved for § 174.100.

(c) International Maritime Organization (IMO), Publications Section, 4 Albert Embankment, London SE1 7SR, United Kingdom, +44 (0)20 7735 7611, <http://www.imo.org/>.

(1) Resolution MSC.216(82), Adoption of Amendments to the International Convention for the Safety of Life At Sea, 1974, As Amended (IMO Res. MSC.216(82)), Adopted on 8 December 2006, IBR approved for § 174.360.

(2) [Reserved]

[USCG–2007–0030, 75 FR 78086, Dec. 14, 2010, as amended by USCG–2012–0832, 77 FR 59788, Oct. 1, 2012; USCG–2013–0671, 78 FR 60164, Sept. 30, 2013]

Subpart B—Special Rules Pertaining to Deck Cargo Barges

Subpart C—Special Rules Pertaining to Mobile Offshore Drilling Units

§ 174.010 Specific applicability.

Each barge that carries cargo above the weather deck must comply with this subpart.

§ 174.015 Intact stability.

(a) Except as provided in §174.020, in each condition of loading and operation, each barge must be shown by design calculations to have an area under the righting arm curve up to the angle of maximum righting arm, the downflooding angle, or 40 degrees, whichever angle is smallest, equal to or greater than—

(1) 15 foot-degrees (4.57 meter-degrees) for ocean and Great Lakes winter service; and

(2) 10 foot-degrees (3.05 meter-degrees) for lakes, bays, sounds, and Great Lakes summer service.

(b) For the purpose of this section, downflooding angle means the static angle from the intersection of the vessel's centerline and waterline in calm water to the first opening that does not close watertight automatically.

§ 174.020 Alternate intact stability criterion.

A barge need not comply with §174.015 and subparts C and E of part 170 of this chapter if it has the following characteristics:

(a) The weather deck is watertight.

(b) The barge's hull proportions fall within any one of the ratios in categories (A) through (D) in Table 174.020.

(c) The maximum cargo height is 30 feet (9.25 meters) or a value equal to the depth of the barge amidships, whichever is less.

TABLE 174.020

Category	Beam/depth ratio	Draft/depth ratio
A	3.00 to 3.74	Equal to or less than 0.70.
B	3.75 to 3.99	Equal to or less than 0.72.
C	4.00 to 4.49	Equal to or less than 0.76.
D	4.50 to 6.00	Equal to or less than 0.80.

§ 174.030 Specific applicability.

Each mobile offshore drilling unit (MODU) inspected under Subchapter IA of this chapter must comply with this subpart.

§ 174.035 Definitions.

(a) For the purpose of this subpart the following terms have the same definitions as given in subchapter IA of this chapter:

- (1) *Column stabilized unit.*
- (2) *Mobile offshore drilling unit.*
- (3) *Self-elevating unit.*
- (4) *Surface type unit.*

(b) For the purpose of this subpart—

(1) *Downflooding* means the entry of seawater through any opening that cannot be rapidly closed watertight, into the hull, superstructure, or columns of an undamaged unit due to heel, trim, or submergence of the unit.

(2) *Downflooding angle* means the static angle from the intersection of the unit's centerline and waterline in calm water to the first opening through which downflooding can occur when subjected to a wind heeling moment (Hm) calculated in accordance with §174.055.

(3) *Normal operating condition* means a condition of a unit when loaded or arranged for drilling, field transit, or ocean transit.

(4) *Severe storm condition* means a condition of a unit when loaded or arranged to withstand the passage of a severe storm.

§ 174.040 Stability requirements: general.

Each unit must be designed to have at least 2 inches (50mm) of positive metacentric height in the upright equilibrium position for the full range of drafts, whether at the operating draft for navigation, towing, or drilling afloat, or at a temporary draft when changing drafts.

§ 174.045 Intact stability requirements.

(a) Each unit must be designed so that the wind heeling moments (Hm) and righting moments calculated for each of its normal operating conditions

§ 174.045

46 CFR Ch. I (10-1-14 Edition)

and severe storm conditions, when plotted on GRAPH 174.045, define areas that satisfy the equation:

$$\text{Area(A)} \geq (K) \times (\text{Area (B)})$$

where—

- (1) K=1.4 except that if the unit is a column stabilized unit K=1.3;
- (2) Area (A) is the area on GRAPH 174.045 under the righting moment curve between 0 and the second intercept angle or the angle of heel at which downflooding would occur, whichever angle is less; and
- (3) Area (B) is the area on GRAPH 174.045 under the wind heeling moment curve between 0 and the second intercept angle or the angle of heel at which downflooding of the unit would occur whichever angle is less.

(b) Each righting moment on graph §174.045 must be positive for all angles greater than 0 and less than the second intercept angle.

(c) For the purposes of this section, openings fitted with the weathertight closing appliances specified in §174.100(b) are not considered as openings through which downflooding could occur if they can be rapidly closed and would not be submerged below the units' waterline prior to the first intercept angle, except that ventilation intakes and outlets for machinery spaces, crew spaces, and other spaces where ventilation is normally required are considered as openings through which downflooding could occur regardless of location.

(d) Each unit must be designed so that it can be changed from each of its normal operating conditions to a severe storm condition within a minimum period of time consistent with the operating manual required in §109.121 of this chapter.

GRAPH 174.045

Intact Stability Curves for a Given Normal Operating or Severe Storm Mode

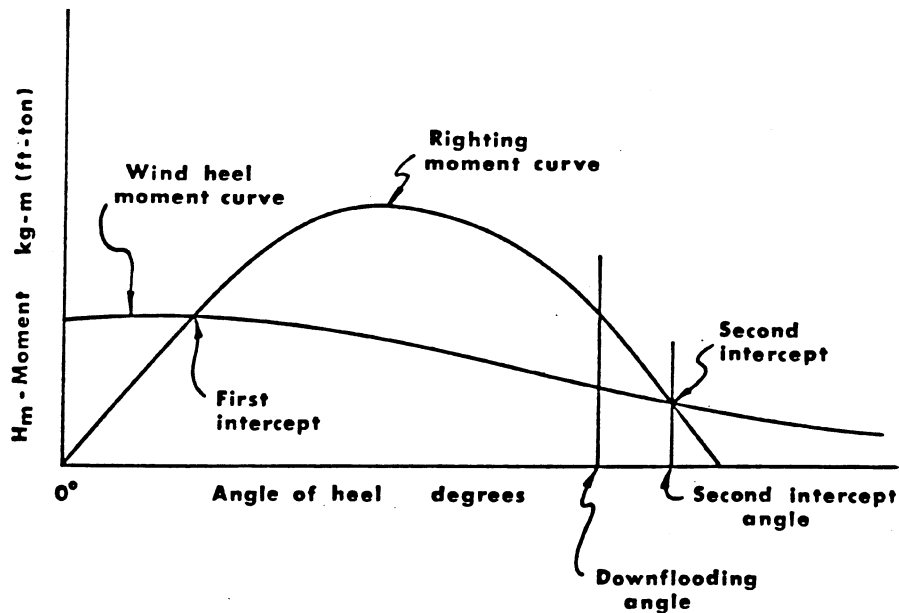

[CGD 79-023, 48 FR 51048, Nov. 4, 1983, as amended by CGD 83-071, 52 FR 6979, Mar. 6, 1987]

§ 174.050 Stability on bottom.

Each bottom bearing unit must be designed so that, while supported on the sea bottom with footings or a mat, it continually exerts a downward force on each footing or the mat when subjected to the forces of wave and current and to wind blowing at the velocities described in § 174.055(b)(3).

§ 174.055 Calculation of wind heeling moment (Hm).

(a) The wind heeling moment (Hm) of a unit in a given normal operating condition or severe storm condition is the sum of the individual wind heeling moments (H) calculated for each of the ex-

posed surfaces on the unit; *i.e.*, $H_m = \sum H$.

(b) Each wind heeling moment (H) must be calculated using the equation:

$$H = k(v)^2(C_h)(C_s)(A)(h)$$

where—

- (1) H=wind heeling moment for an exposed surface on the unit in foot-pounds (kilogram-meters);
- (2) $k=0.00338 \text{ lb.}/(\text{ft.}^2\text{-knots}^2)$ ($0.0623 \text{ (kg-sec}^2\text{)}/\text{m}^4$);
- (3) v =wind velocity of—
 - (i) 70 knots (36 meters per second) for normal operating conditions.
 - (ii) 100 knots (51.5 meters per second) for severe storm conditions.
 - (iii) 50 knots (25.8 meters per second) for damage conditions.

§ 174.065

- (4) A=projected area in square feet (square meters) of an exposed surface on the unit;
- (5) Ch=height coefficient for "A" from Table 174.055(a);
- (6) Cs=shape coefficient for "A" from Table 174.055(b); and
- (7) h=the vertical distance in feet (meters) from the center of lateral resistance of the underwater hull to the center of wind pressure on "A".

(c) When calculating "A" in the equation described in paragraph (b) of this section—

- (1) The projected area of each column or leg; if the unit has columns or legs, must not include shielding allowances;
- (2) Each area exposed as a result of heel must be included;
- (3) The projected area of a cluster of deck houses may be used instead of the projected area of each individual deck house in the cluster; and
- (4) The projected area of open truss work may be calculated by taking 30% of the projected areas of both the front and back sides of the open truss work rather than by determining the projected area of each structural member of the truss work.

TABLE 174.055(a)—CH VALUES

Feet		Meters		Ch.
Over	Not exceeding	Over	Not exceeding	
0	50	0.0	15.3	1.00
50	100	15.3	30.5	1.10
100	150	30.5	46.0	1.20
150	200	46.0	61.0	1.30
200	250	61.0	76.0	1.37
250	300	76.0	91.5	1.43
300	350	91.5	106.5	1.48
350	400	106.5	2.0	1.52
400	450	122.0	137.0	1.56
450	500	137.0	152.5	1.60
500	550	152.5	167.5	1.63
550	600	167.5	183.0	1.67
600	650	183.0	198.0	1.70
650	700	198.0	213.5	1.72
700	750	213.5	228.5	1.75
750	800	228.5	244.0	1.77
800	850	244.0	256.0	1.79
Above 850		Above 256		1.80

NOTE: The "Ch" value in this table, used in the equation described in section § 174.055(b), corresponds to the value of the vertical distance in feet (meters) from the water surface at the design draft of the unit to the center of area of the "A" value used in the equation.

TABLE 174.055(b)—CS VALUES

Shape	Cs.
Cylindrical shapes	0.5
Hull (surface type)	1.0
Deckhouse	1.0

46 CFR Ch. I (10–1–14 Edition)

TABLE 174.055(b)—Cs VALUES—Continued

Shape	Cs.
Cluster of deckhouses	1.1
Isolated structural shapes (cranes, angles, channels, beams, etc.)	1.5
Under deck areas (smooth surfaces)	1.0
Under deck areas (exposed beams and girders)	1.3
Rig derrick (each face and open truss works)	1.25

NOTE: The "Cs" value in this table, used in the equation described in § 174.055(b), corresponds to the shape of the projected "A" in the equation.

[CGD 79-023, 48 FR 51048, Nov. 4, 1983, as amended by USCG-2014-0688, 79 FR 58287, Sept. 29, 2014]

§ 174.065 Damage stability requirements.

(a) Each unit must be designed so that, while in each of its normal operating conditions and severe storm conditions, its final equilibrium waterline would remain below the lowest edge of any opening through which additional flooding could occur if the unit were subjected simultaneously to—

- (1) Damage causing flooding described in §§ 174.075 through 174.085; and
- (2) A wind heeling moment calculated in accordance with § 174.055(b) using a wind velocity of 50 knots (25.8 meters per second).

(b) Each unit must have a means to close off each pipe, ventilation system, and trunk in each compartment described in § 174.080 or § 174.085 if any portion of the pipe, ventilation system, or trunk is within 5 feet (1.5 meters) of the hull.

§ 174.070 General damage stability assumptions.

For the purpose of determining compliance with § 174.065, the assumptions are made that during flooding and the resulting change in the unit's waterline—

(a) The unit is not anchored or moored; and

(b) No compartment on the unit is ballasted or pumped out to compensate for the flooding described in §§ 174.075 through 174.085.

§ 174.075 Compartments assumed flooded: general.

The individual flooding of each of the compartments described in §§ 174.080 and 174.085 must be assumed for the purpose of determining compliance

with §174.065 (a). Simultaneous flooding of more than one compartment must be assumed only when indicated in §§ 174.080 and 174.085.

§ 174.080 Flooding on self-elevating and surface type units.

(a) On a surface type unit or self-elevating unit, all compartments within 5 feet (1.5 meters) of the hull of the unit between two adjacent main watertight bulkheads, the bottom shell, and the uppermost continuous deck or first superstructure deck where superstructures are fitted must be assumed to be subject to simultaneous flooding.

(b) On the mat of a self-elevating unit, all compartments of the mat must be assumed to be subject to individual flooding.

§ 174.085 Flooding on column stabilized units.

(a) Watertight compartments that are outboard of, or traversed by, a plane which connects the vertical centerlines of the columns on the periphery of the unit, and within 5 feet (1.5 meters) of an outer surface of a column or footing on the periphery of the unit, must be assumed to be subject to flooding as follows:

(1) When a column is subdivided into watertight compartments by horizontal watertight flats, all compartments in the column within 5 feet (1.5 meters) of the unit's waterline before damage causing flooding must be assumed to be subject to simultaneous flooding.

(2) When a column is subdivided into watertight compartments by vertical watertight bulkheads, each two adjacent compartments must be assumed subject to simultaneous flooding if the distance between the vertical watertight bulkheads, measured at the column periphery, is equal to or less than one-eighth of the column perimeter at the draft under consideration.

(3) When a column is subdivided into watertight compartments by horizontal watertight flats and vertical watertight bulkheads, those compartments that are within the bounds described in paragraph (a)(2) of this section and within 5 feet (1.5 meters) of the unit's waterline before damage

causing flooding must be assumed to be subject to simultaneous flooding.

(b) Each compartment in a footing must be assumed to be subject to individual flooding when any part of the compartment is within 5 feet (1.5 meters) of the unit's waterline before damage causing flooding.

§ 174.090 Permeability of spaces.

When doing the calculations required in §174.065—

(a) The permeability of a floodable space, other than a machinery space, must be as listed in Table 174.090; and

(b) Calculations in which a machinery space is treated as a floodable space must be based on an assumed machinery space permeability of 85%, unless the use of an assumed permeability of less than 85% is justified in detail.

TABLE 174.090—PERMEABILITY

Spaces and tanks	Permeability (percent)
Storeroom spaces	60.
Accommodation spaces	95.
Voids	95.
Consumable liquid tanks	95 or 0. ¹
Other liquid tanks	95 or 0. ²

¹ Whichever results in the more disabling condition.

² If tanks are partially filled, the permeability must be determined from the actual density and amount of liquid carried.

§ 174.100 Appliances for watertight and weathertight integrity.

(a) Appliances to insure watertight integrity include watertight doors, hatches, scuttles, bolted manhole covers, or other watertight closures for openings in watertight decks and bulkheads.

(b) Appliances to insure weathertight integrity include weathertight doors and hatches, closures for air pipes, ventilators, ventilation intakes and outlets, and closures for other openings in deckhouses and superstructures.

(c) Each internal opening equipped with appliances to insure watertight integrity that is used intermittently during operation of the unit while afloat must meet the following:

(1) Each door, hatch, and scuttle must—

(i) Be remotely controlled from a normally manned control station, and be operable locally from both sides of the bulkhead; or

§ 174.140

46 CFR Ch. I (10–1–14 Edition)

(ii) If there is no means of remote control there must be an alarm system that signals whether the appliance is open or closed both locally at each appliance and in a normally manned control station.

(2) Each closing appliance must remain watertight under the design water pressure of the watertight boundary of which it is a part.

(d) Each external opening fitted with an appliance to insure weathertight integrity must be located so that it would not be submerged below the final equilibrium waterline if the unit is subjected simultaneously to—

(1) Damage causing flooding described in §§174.075 through 174.085; and

(2) A wind heeling moment calculated in accordance with §174.055 using a wind velocity of 50 knots (25.8 meters per second).

(e) If a unit is equipped with sliding watertight doors, each sliding watertight door must—

(1) Be designed, constructed, tested, and marked in accordance with ASTM F 1196 (incorporated by reference, see §174.007);

(2) Have controls in accordance with ASTM F 1197 (incorporated by reference, see §174.007), except that a remote manual means of closure, as specified in paragraphs 7.1 and 7.5.1, and a remote mechanical indicator, as specified in paragraph 7.5.2, will not be required; and

(3) If installed in a subdivision bulkhead, meet Supplemental Requirements Nos. S1 and S3 of ASTM F 1196 (incorporated by reference, see §174.007), unless the watertight doors are built in accordance with plans previously approved by the Coast Guard, in which case, only Supplemental Requirements Nos. S1 and S3.1.4 of ASTM F 1196 (incorporated by reference, see §174.007) must be met. In either case, control systems for watertight doors must have power supplies, power sources, installation tests and inspection, and additional remote operating consoles in accordance with Supplemental Requirements Nos. S1 through S4 of ASTM F 1197 (incorporated by reference, see §174.007).

(f) Installations of sliding watertight door assemblies must be in accordance with the following:

(1) Before a sliding watertight door assembly is installed in a vessel, the bulkhead in the vicinity of the door opening must be stiffened. Such bulkhead stiffeners, or deck reinforcement where flush deck door openings are desired, must not be less than 6 inches nor more than 12 inches from the door frame so that an unstiffened diaphragm of bulkhead plating 6 to 12 inches wide is provided completely around the door frame. Where such limits cannot be maintained, alternative installations will be considered by the Marine Safety Center. In determining the scantlings of these bulkhead stiffeners, the door frame should not be considered as contributing to the strength of the bulkhead. Provision must also be made to adequately support the thrust bearings and other equipment that may be mounted on the bulkhead or deck.

(2) Sliding watertight door frames must be either bolted or welded watertight to the bulkhead.

(i) If bolted, a suitable thin heat and fire resistant gasket or suitable compound must be used between the bulkhead and the frame for watertightness. The bulkhead plating shall be worked to a plane surface in way of the frame when mounting.

(ii) If welded, caution must be exercised in the welding process so that the door frame is not distorted.

[CGD 79-023, 48 FR 51048, Nov. 4, 1983, as amended by CGD 88-032, 56 FR 35828, July 29, 1991; USCG-2000-7790, 65 FR 58464, Sept. 29, 2000]

Subpart D [Reserved]

Subpart E—Special Rules Pertaining to Tugboats and Towboats

§ 174.140 Specific applicability.

Each tugboat and towboat inspected under subchapter I of this chapter must comply with this subpart.

§ 174.145 Intact stability requirements.

(a) In each condition of loading and operation, each vessel must be shown by design calculations to meet the requirements of paragraphs (b) through (e) of this section.

(b) The area under each righting arm curve must be at least 16.9 foot-degrees (5.15 meter-degrees) up to the smallest of the following angles:

- (1) The angle of maximum righting arm.
- (2) The downflooding angle.
- (3) 40 degrees.

(c) The area under each righting arm curve must be at least 5.6 foot-degrees (1.72 meter-degrees) between the angles of 30 degrees and 40 degrees, or between 30 degrees and the downflooding angle if this angle is less than 40 degrees.

(d) The maximum righting arm shall occur at a heel of at least 25 degrees.

(e) The righting arm curve must be positive to at least 60 degrees.

(f) For the purpose of this section, at each angle of heel, a vessel's righting arm may be calculated considering either—

- (1) The vessel is permitted to trim free until the trimming moment is zero; or
- (2) The vessel does not trim as it heels.

Subpart F [Reserved]

Subpart G—Special Rules Pertaining to Offshore Supply Vessels

SOURCE: CGD 82-004 and CGD 86-074, 62 FR 49353, Sept. 19, 1997, unless otherwise noted.

§ 174.180 Applicability.

This subpart applies to OSVs except liftboats inspected under subchapter L of this chapter and OSVs of at least 6,000 GT ITC (500 GRT if GT ITC is not assigned) as defined in §125.160 of this chapter.

[USCG-2012-0208, 79 FR 48939, Aug. 18, 2014]

§ 174.185 Intact stability.

(a) Each OSV must be shown by design calculations to meet, under each condition of loading and operation, the minimal requirements for metacentric height (GM) in §170.170 of this chapter, and in either §170.173 of this chapter or paragraphs (b) through (e) of this section.

(b) The area under each righting arm curve must be at least 0.08 meter-radi-

ans (15 foot-degrees) up to the smallest of the following angles:

- (1) The angle of maximum righting arm;
- (2) The downflooding angle; or
- (3) 40 degrees.

(c) The downflooding angle must not be less than 20 degrees.

(d) The righting arm curve must be positive to at least 40 degrees.

(e) The freeboard at the stern must be equal to the freeboard calculated to comply with subchapter E of this chapter or to the value taken from Table 174.185, whichever is less.

(f) For paragraphs (b) and (d) of this section, at each angle of heel an OSV's righting arm may be calculated considering either—

- (1) The vessel is permitted to trim free until the trimming moment is zero; or
- (2) The vessel does not trim as it heels.

(g) For the purpose of paragraphs (b) and (d) of this section, the method of calculating righting arms chosen must be the same for all calculations.

TABLE 174.185—MINIMAL FREEBOARD AT THE STERN

LBP in meters (feet)	Freeboard at stern in millimeters (inches)
Less than 20 (65)	300 (12)
20 (65) but less than 30 (100)	380 (15)
30 (100) but less than 40 (130)	400 (18)
40 (130) but less than 50 (155)	500 (20)
50 (155) but less than 60 (190)	560 (22)
60 (190) but less than 70 (230)	610 (24)
70 (230) and greater	660 (26)

§ 174.190 Collision bulkhead.

(a) Each OSV must have a collision bulkhead in compliance with §§171.085(c)(1), (d), (e)(2), and (f) of this chapter.

(b) Penetration of the collision bulkhead by piping must be minimal, and, where fitted, piping must meet the requirements of §§56.50-1(b)(1) and (c) and 128.230 of this chapter.

§ 174.195 Bulkheads in machinery spaces.

(a) The bulkhead in each machinery space of each OSV must be watertight to the bulkhead deck.

§ 174.200

(b) Each penetration of, and each opening in, a bulkhead in a machinery space must—

(1) Be kept as high and as far inboard as practicable; and

(2) Except as provided by §174.210 of this subpart and by paragraph (c) of this section, have means to make it watertight.

(c) No penetration of a bulkhead in a machinery space by a ventilation duct need have means to make the bulkhead watertight if—

(1) Every part of the duct is at least 760 millimeter (30 inches) from the side of the OSV; and

(2) The duct is continuously watertight from the penetration to the main deck.

(d) Each penetration of a bulkhead in a machinery space by piping must meet the design requirements for material and pressure in subchapter F of this chapter.

§ 174.200 Damaged stability in machinery spaces for all OSVs.

Each OSV must be shown by design calculations to comply, under each afloat condition of loading and operation, with §174.207 of this subpart in case of damage between any two watertight bulkheads in each machinery space.

§ 174.205 Additional damaged stability for OSVs carrying more than 16 offshore workers.

(a) *Calculations.* Each OSV carrying more than 16 offshore workers must be shown by design calculations to comply, under each afloat condition of loading and operation, with §174.207 of this subpart in case of the damage specified by paragraph (b) of this section.

(b) *Character of damage.* For paragraph (a) of this section, design calculations must show that the OSV can survive damage at any place other than either the collision bulkhead or a transverse watertight bulkhead unless—

(1) The transverse watertight bulkhead is closer than the longitudinal extent of damage, specified by Table 174.207(a), to the adjacent transverse watertight bulkhead; or

46 CFR Ch. I (10–1–14 Edition)

(2) The transverse watertight bulkhead has a step or a recess, which must be assumed damaged, if it is both more than 3 meters (10 feet) in length and located within the transverse extent of damage specified by Table 174.207(a) of this section.

§ 174.207 Damaged stability criteria.

(a) *Extent of damage.* Damage must consist of penetrations having the dimensions specified by table 174.207(a) of this section, except that, if the most disabling penetrations are smaller than the penetrations specified by the table, damage must consist of the smaller penetrations.

(b) *Permeability of spaces.* The permeability of a floodable space must be as specified by Table 174.207(b) of this section.

(c) *Survival conditions.* An OSV is presumed to survive assumed damage if it meets the following conditions in the final stage of flooding:

(1) *Final waterline.* The final waterline, in the final stage of sinkage, heel, and trim, must be below the lower edge of an opening through which progressive flooding may take place, such as an air pipe, a tonnage opening, an opening closed by a weathertight door or hatch-cover, or a tank vent fitted with a ball check-valve. This opening does not include an opening closed by a—

- (i) Watertight manhole-cover;
- (ii) Flush scuttle;
- (iii) Small hatch-cover for a watertight cargo-tank that maintains the high integrity of the deck;
- (iv) Watertight door in compliance with §174.210 of this subpart; or
- (v) Side scuttle of the non-opening type.

(2) *Angle of heel.* The angle of heel must not exceed 15 degrees.

(3) *Range of stability.* Through an angle of 20 degrees beyond its position of equilibrium after flooding, an OSV must meet the following conditions:

- (i) The righting arm curve must be positive.
- (ii) The righting arm must be at least 100 millimeters (4 inches).
- (iii) Each submerged opening must be weathertight. (A tank vent fitted with a ball check-valve is weathertight.)

(4) *Progressive flooding.* Piping, ducts, or tunnels within the assumed extent of damage must be either—

(i) Equipped with arrangements, such as stop check-valves, to prevent progressive flooding of the spaces with which they connect; or

(ii) Assumed in the calculations required by paragraph (a) of this section to permit progressive flooding of the spaces with which they connect.

(d) *Buoyancy of superstructure.* For paragraph (a) of this section, the buoyancy of any superstructure directly above the side damage must be considered in the most unfavorable condition.

TABLE 174.207(a)—EXTENT OF DAMAGE

Collision Penetration	
Longitudinal extent (vessels with LBP not greater than 45 meters [143 feet]).	.1L or 1.8 meters (6 feet), whichever is greater in length.
Longitudinal extent (vessels with LBP greater than 45 meters [143 feet]).	3 meters (10 feet) + .03L.
Transverse extent*	760 millimeters (30 inches).
Vertical extent.	From baseline upward without limit.

*The transverse penetration applies inboard from the side of the vessel, at right angles to the centerline, at the level of the deepest load waterline.

TABLE 174.207(b)—PERMEABILITY OF SPACES

Spaces and tanks	Permeability
Storerooms	60 percent.
Accommodations	95 percent.
Machinery	85 percent.
Voids and passageways	95 percent.
Dry-bulk tanks	0 (*) or 95 percent.
Consumable-liquid tanks	0 (*) or 95 percent.
Other liquid tanks	0 (*) 0 (**) or 95 percent.

*Whichever results in the more disabling condition.
 **If tanks are partly filled, the permeability must be determined from the actual density and amount of liquid carried.

§ 174.210 Watertight doors in watertight bulkheads.

(a) This section applies to each vessel with watertight doors in bulkheads made watertight in compliance with this chapter.

(b) Except as provided by paragraph (c) of this section, each watertight door must comply with subpart H of part 170 of this chapter.

(c) A Class-1 door may be installed at any place if—

(1) The door has a quick-acting closing-device operative from both sides of the door;

(2) The door is designed to withstand a head of water equivalent to the depth from the sill of the door to the bulkhead deck or 3 meters (10 feet), whichever is greater; and

(3) The vessel's pilothouse contains a visual indicator showing whether the door is open or closed.

(d) Each watertight door must be marked in compliance with §131.893 of this chapter.

(e) If a Class-1 door is installed, the vessel's stability letter will require the master to ensure that the door is always closed except when being used for access.

§ 174.215 Drainage of weather deck.

The weather deck must have open rails to allow rapid clearing of water, or must have freeing ports in compliance with § 42.15–70 of this chapter.

§ 174.220 Hatches and coamings.

(a) Each hatch exposed to the weather must be watertight, except that the following hatches may be only weathertight:

(1) Each hatch on a watertight trunk that extends at least 430 millimeters (17 inches) above the weather deck.

(2) Each hatch in a cabin top.
 (b) Each hatch cover must—
 (1) Have securing-devices; and
 (2) Be attached to the hatch frame or coaming by hinges, captive chains, or other devices to prevent its loss.

(c) Each hatch that provides access to quarters or to accommodation spaces for crew members or offshore workers must be capable of being opened and closed from either side.

(d) Except as provided by paragraph (e) of this section, a weathertight door with a permanent watertight coaming at least 380 millimeters (15 inches) high must be installed for each opening in a deckhouse or companionway that—

(1) Gives access into the hull; and
 (2) Is in an exposed place.

(e) If an opening in a deckhouse or companionway has a Class-1 watertight door installed, the height of the watertight coaming need only accommodate the door.

§ 174.225

46 CFR Ch. I (10–1–14 Edition)

§ 174.225 Hull penetrations and shell connections.

Each overboard discharge and shell connection except an engine exhaust must comply with §§ 56.50–95 and 128.230 of this chapter.

Subpart H—Special Rules Pertaining to Liftboats

SOURCE: CGD 82–004 and CGD 86–074, 62 FR 49355, Sept. 19, 1997, unless otherwise noted.

§ 174.240 Applicability.

Each liftboat inspected under subchapter L of this chapter must comply with this subpart.

§ 174.245 General.

Each liftboat must comply with §§ 174.210 through 174.225.

§ 174.250 Unrestricted service.

Each liftboat not limited to restricted service must comply with subpart C of this part in each condition of loading and operation.

§ 174.255 Restricted service.

This section applies to each liftboat unable to comply with § 174.250 and limited to restricted service as defined by § 125.160 of this chapter.

(a) *Intact stability.* (1) Each liftboat must be shown by design calculations to meet, under each condition of loading and operation afloat, the following requirements:

(i) Those imposed by § 174.045, given a “K” value of at least 1.4.

(ii) A range of positive stability of at least 10 degrees extending from the angle of the first intercept of the curves of righting moment and wind heeling moment, either to the angle of the second intercept of those curves or to the angle of heel at which downflooding would occur, whichever angle is less.

(iii) A residual righting energy of at least 0.003 meter radians (5 foot-degrees) between the angle of the first intercept of the curves of righting moment and wind heeling moment, either to the angle of the second intercept of those curves or to the angle of heel at which downflooding would occur, whichever angle is less.

(2) For this section, each wind heeling moment must be calculated as prescribed by § 174.055 of this part using winds of 60 knots for normal conditions of operation afloat and of 70 knots for severe-storm conditions of operation afloat.

(3) For paragraph (a)(1) of this section, the initial metacentric height must be at least 300 millimeters (1 foot) for each leg position encountered while afloat including the full range of leg positions encountered while jacking.

(b) *Damaged stability.* (1) Each liftboat must be designed so that, while it is in each of its normal operating conditions, its final equilibrium waterline will remain below the lowest edge of any opening through which additional flooding can occur if the liftboat is subjected simultaneously to—

(i) Damage causing flooding described by paragraph (b)(4) of this section; and

(ii) A wind heeling moment calculated in compliance with § 174.055(b) using a wind speed of 50 knots.

(2) Each liftboat must have a means of closing off each pipe, ventilation system, and trunk in each compartment described by paragraph (b)(4) of this section if any part of the pipe, ventilation system, or trunk is within 760 millimeters (30 inches) of the hull.

(3) For compliance with paragraph (b)(1) of this section, no compartment on the liftboat may be ballasted or pumped out to compensate for the flooding described by paragraph (b)(4) of this section.

(4) For compliance with paragraph (b)(1) of this section, each compartment within 760 millimeters (30 inches) of the hull, excluding the bottom of the liftboat, between two adjacent main watertight bulkheads and the uppermost continuous deck or first superstructure deck where superstructures are fitted must be assumed subject to simultaneous flooding.

(5) In the calculations required by paragraph (b)(1) of this section, the permeability of a floodable space must be as listed by Table 174.205(d).

(c) *On-bottom stability.* Each liftboat must be shown by design calculations to exert a continuous downward force on each footing when the vessel is supported on the bottom with footings and

is subjected to the forces of waves, currents, and winds of 70 knots under normal conditions of operation, and winds of 100 knots under severe-storm conditions of operation when elevated in a safe place, if this place is other than a harbor of safe refuge. The waves and currents must be appropriate for the winds and place.

§ 174.260 Freeboard.

(a) Each liftboat not required to obtain and maintain a loadline in compliance with subchapter E of this chapter must place markings on each side of the vessel amidships. These markings must each consist of a horizontal line 460 millimeters (18 inches) in length and 25 millimeters (1 inch) in height. The upper edges of the markings must be at a distance equal to the authorized freeboard measured vertically below the intersection of the continuation outwards of the upper surface of the weather deck and the outer surface of the shell. This distance must be at least 610 millimeters (24 inches).

(b) The markings required by paragraph (a) of this section may not be submerged in any condition of loading or operation.

Subpart I—Hopper Dredges With Working Freeboard Assignments

SOURCE: CGD 76-080, 54 FR 36977, Sept. 6, 1989, unless otherwise noted.

§ 174.300 Specific applicability.

This subpart applies to each self-propelled hopper dredge for which a working freeboard assignment is being sought under part 44, subpart C, of this chapter.

§ 174.305 Definitions.

Hopper dredge has the same meaning as contained in §44.310 of this chapter.

Length has the same meaning as contained in §42.13-15(a) of this chapter.

Working freeboard has the same meaning as contained in §44.310 of this chapter.

CALCULATIONS

§ 174.310 General.

(a) Each hopper dredge under this subpart must be shown by design cal-

culations based on the assumptions under paragraphs (b), (c), (d), and (e) of this section, that it meets—

(1) The requirements in §§170.170, 170.173, and 170.300 of this chapter in each condition of loading and operation; and

(2) The survival conditions of §174.320 in each condition of loading and operation assuming the character and extent of damage specified in §174.315.

(b) The calculations required by paragraph (a) of this section must assume:

(1) The hoppers are full of seawater;

(2) The permeability of flooded spaces is as provided by Table 174.310;

(3) The equalization provisions of §174.325; and

(4) The jettisoning provisions of §174.330.

(c) The calculations required by this section must take into account a sufficient number of loading conditions to identify the condition in which the vessel is least stable, including, but not limited to, the most severe loading condition, and the:

(1) Specific gravity of the dredge spoil, from 1.02 up to and including the maximum required by paragraph (e)(1) of this section; and

(2) Draft, up to and including the draft corresponding to the working freeboard for the full range of trim.

(d) The calculations required by this section for a dredge with open hoppers may include spillage of spoil from the hopper resulting from changing the angle of heel and trim.

(e) The following assumptions must be made when doing the calculations required by this section:

(1) Dredged spoil in the hopper is a homogeneous liquid with a maximum specific gravity for the areas of operation.

(2) When calculating the vessel's righting arm, it is assumed at each angle of heel that the vessel trims free and the trimming moment is zero.

TABLE 174.310—PERMEABILITY OF FLOODABLE SPACES

Spaces and tanks	Permeability
Storerooms	0.60
Accommodation spaces	0.95
Consumable liquid tanks	0.00 or 0.95—whichever results in the more disabling condition.

§ 174.315

TABLE 174.310—PERMEABILITY OF FLOODABLE SPACES—Continued

Spaces and tanks	Permeability
Machinery space	0.85—unless otherwise supported by calculations.
Cargo tanks	Determined from the actual density and amount of liquid carried in the tank.

§ 174.315 Extent and character of damage.

(a) The calculations required by §174.310 must show that the dredge can survive damage at any location along the length of the vessel including at a transverse bulkhead in accordance with paragraph (b) of this section.

(b) The calculations required by paragraph (a) of this section must assume the most disabling side penetration with the damage collision penetration provided by Table 174.315, except that if the most disabling damage collision penetrations would be less than those provided by Table 174.315, the smaller damage collision penetration must be assumed.

TABLE 174.315—EXTENT OF DAMAGE COLLISION PENETRATION

Longitudinal extent	0.495L ^{2/3} or 47.6 feet. [(1/3)(L) ^{2/3} or 14.5 meters] whichever is less.
Transverse extent ¹	B/5 or 37.7 feet. (11.5 meters), whichever is less.
Vertical extent	From the base line upward without limit.

¹ Damage applied inboard from the vessel's side at a right angle to the centerline at the draft corresponding to the working freeboard assigned under subchapter E of this chapter.

§ 174.320 Damage survival.

A hopper dredge survives assumed damage if it meets the following conditions:

(a) The maximum angle of heel in each stage of flooding must not exceed 30 degrees or the angle of downflooding whichever is less.

(b) The final waterline, taking into account sinkage, heel, and trim, must be below the lowest edge of each opening through which progressive flooding may take place.

(c) The righting arm curve calculated after damage must:

(1) Have a minimum positive range of 20 degrees beyond the angle of equilibrium; and

(2) Reach a height of at least 4 inches (100mm) within the 20 degree positive range.

(d) Each opening within, or partially within, the 20 degree range beyond the angle of equilibrium must be weather-tight.

(e) After flooding or equalization as allowed by §174.325, the hopper dredge's metacentric height must be at least 2 inches (50mm) when the dredge is in an upright position.

§ 174.325 Equalization.

When doing the calculations required by §174.310 of this subpart—

(a) Equalization arrangements requiring mechanical aids, such as valves, may not be assumed to be effective in reducing the angle of heel; and

(b) Spaces joined by ducts may be assumed to be common spaces only if equalization takes place within 15 minutes after flooding begins.

§ 174.330 Jettisoning of spoil.

(a) When doing the calculations required by §174.310 for a hopper dredge with bottom doors, it may be assumed that the spoil is jettisoned immediately after damage and that the bottom doors remain open if:

(1) The bottom doors are designed so that they may be fully opened from:

(i) The closed position within two minutes even if the main power source is lost or the bottom door actuating mechanism is damaged; and

(ii) The navigating bridge;

(2) The discharge area through the bottom doors is equal to or greater than 30 percent of the maximum cross sectional area of the hopper measured in a plane parallel to the waterline; and

(3) Asymmetrical jettisoning of the spoil is impossible.

(b) When doing the calculations required by §174.310 for a hopper dredge with a split hull, it may be assumed that the spoil is jettisoned immediately after damage if—

(1) The hull is designed so that—

(i) The complete separation is effected within two minutes even if the

main power source is lost or the actuating means is damaged; and

(ii) The actuating means can be operated from the navigating bridge;

(2) It is shown to the Commanding Officer, Marine Safety Center, either by calculations or by operational tests, that the hulls can separate sufficiently to allow the dredged material to dump without bridging; and

(3) Asymmetrical jettisoning of the spoil is impossible.

DESIGN

§ 174.335 Watertight doors.

(a) Each hopper dredge must have sliding watertight doors (Class 3) approved under §170.270 of this chapter if the sill for the door is—

(1) Installed below the bulkhead deck; and

(2) Less than 24 inches above the final waterline as shown by the calculations required by §174.310 in each damage condition up to and including the maximum amount of assumed damage.

(b) Each hopper dredge must have sliding watertight doors (Class 3) approved under §170.270 of this chapter, or quick acting hinged watertight doors (Class 1) approved under the same subpart if the sill of the watertight door is—

(1) Installed below the bulkhead deck; and

(2) Greater than 24 inches above the final waterline as shown by the calculations required by §174.310 in each damage condition up to and including the maximum amount of assumed damage.

[CGD 76-080, 54 FR 36977, Sept. 6, 1989, as amended by CGD 95-072, 60 FR 50468, Sept. 29, 1995]

§ 174.340 Collision bulkhead.

Each hopper dredge must have a collision bulkhead that is located not less than 5 percent of the length abaft of the forward perpendicular.

Subpart J—Special Rules Pertaining to Dry Cargo Ships

SOURCE: CGD 87-094, 58 FR 17320, Apr. 1, 1993, unless otherwise noted.

§ 174.350 Specific applicability.

This subpart applies to each new ship of 500 gross tons or over, as calculated by the International Convention on Tonnage Measurement of Ships, 1969, designed primarily for the carriage of dry cargoes, including roll-on/roll-off ships and integrated tug and barges (ITBs) when operating as a combined unit.

§ 174.355 Definitions.

New ship means a ship:

(1) For which the building contract is placed on or after February 1, 1992; or

(2) In the absence of a building contract, the keel of which is laid or which is at a similar stage of construction on or after August 1, 1992; or

(3) The delivery of which is on or after February 1, 1997; or

(4) For which application for reflagging is made on or after February 1, 1997; or

(5) Which has undergone a major conversion:

(i) For which the contract is placed on or after February 1, 1992; or

(ii) In the absence of a contract, the construction work of which is begun on or after August 1, 1992; or

(iii) Which is completed on or after February 1, 1997.

§ 174.360 Calculations.

Each ship to which this subpart applies must comply with the minimum standard of subdivision and damage stability applicable to that ship under IMO Res. MSC.216(82), (incorporated by reference, see §174.007). Compliance with the applicable requirements must be demonstrated by calculations and reflected in information on loading restrictions, such as a maximum height of the center of gravity (KG) or minimum metacentric height (GM) curve, that is part of the stability information required by §170.110 of this chapter.

[USCG-2007-0030, 75 FR 78086, Dec. 14, 2010]