



# Code of Federal Regulations

---

## 14

### Parts 140 To 199

Revised as of January 1, 2008

## Aeronautics and Space

---

Containing a codification of documents  
of general applicability and future effect

As of January 1, 2008

*With Ancillaries*

Published by  
Office of the Federal Register  
National Archives and Records  
Administration

A Special Edition of the Federal Register



## U.S. GOVERNMENT OFFICIAL EDITION NOTICE

### Legal Status and Use of Seals and Logos

The seal of the National Archives and Records Administration (NARA) authenticates the Code of Federal Regulations (CFR) as the official codification of Federal regulations established under the Federal Register Act. Under the provisions of 44 U.S.C. 1507, the contents of the CFR, a special edition of the Federal Register, shall be judicially noticed. The CFR is prima facie evidence of the original documents published in the Federal Register (44 U.S.C. 1510).

It is prohibited to use NARA's official seal and the stylized Code of Federal Regulations logo on any republication of this material without the express, written permission of the Archivist of the United States or the Archivist's designee. Any person using NARA's official seals and logos in a manner inconsistent with the provisions of 36 CFR part 1200 is subject to the penalties specified in 18 U.S.C. 506, 701, and 1017.

### Use of ISBN Prefix

This is the Official U.S. Government edition of this publication and is herein identified to certify its authenticity. Use of the 0-16 ISBN prefix is for U.S. Government Printing Office Official Editions only. The Superintendent of Documents of the U.S. Government Printing Office requests that any reprinted edition clearly be labeled as a copy of the authentic work with a new ISBN.



U.S. GOVERNMENT PRINTING OFFICE

U.S. Superintendent of Documents • Washington, DC 20402-0001

<http://bookstore.gpo.gov>

Phone: toll-free (866) 512-1800; DC area (202) 512-1800

# Table of Contents

	<i>Page</i>
Explanation .....	v
Title 14:	
Chapter I—Federal Aviation Administration, Department of Transportation (Continued) .....	3
Finding Aids:	
Material Approved for Incorporation by Reference .....	321
Table of CFR Titles and Chapters .....	327
Alphabetical List of Agencies Appearing in the CFR .....	345
List of CFR Sections Affected .....	355

---

*Cite this Code:* CFR

*To cite the regulations in  
this volume use title,  
part and section num-  
ber. Thus, 14 CFR 141.1  
refers to title 14, part  
141, section 1.*

---

## Explanation

The Code of Federal Regulations is a codification of the general and permanent rules published in the Federal Register by the Executive departments and agencies of the Federal Government. The Code is divided into 50 titles which represent broad areas subject to Federal regulation. Each title is divided into chapters which usually bear the name of the issuing agency. Each chapter is further subdivided into parts covering specific regulatory areas.

Each volume of the Code is revised at least once each calendar year and issued on a quarterly basis approximately as follows:

Title 1 through Title 16.....	as of January 1
Title 17 through Title 27.....	as of April 1
Title 28 through Title 41.....	as of July 1
Title 42 through Title 50.....	as of October 1

The appropriate revision date is printed on the cover of each volume.

### LEGAL STATUS

The contents of the Federal Register are required to be judicially noticed (44 U.S.C. 1507). The Code of Federal Regulations is prima facie evidence of the text of the original documents (44 U.S.C. 1510).

### HOW TO USE THE CODE OF FEDERAL REGULATIONS

The Code of Federal Regulations is kept up to date by the individual issues of the Federal Register. These two publications must be used together to determine the latest version of any given rule.

To determine whether a Code volume has been amended since its revision date (in this case, January 1, 2008), consult the "List of CFR Sections Affected (LSA)," which is issued monthly, and the "Cumulative List of Parts Affected," which appears in the Reader Aids section of the daily Federal Register. These two lists will identify the Federal Register page number of the latest amendment of any given rule.

### EFFECTIVE AND EXPIRATION DATES

Each volume of the Code contains amendments published in the Federal Register since the last revision of that volume of the Code. Source citations for the regulations are referred to by volume number and page number of the Federal Register and date of publication. Publication dates and effective dates are usually not the same and care must be exercised by the user in determining the actual effective date. In instances where the effective date is beyond the cut-off date for the Code a note has been inserted to reflect the future effective date. In those instances where a regulation published in the Federal Register states a date certain for expiration, an appropriate note will be inserted following the text.

### OMB CONTROL NUMBERS

The Paperwork Reduction Act of 1980 (Pub. L. 96-511) requires Federal agencies to display an OMB control number with their information collection request.

Many agencies have begun publishing numerous OMB control numbers as amendments to existing regulations in the CFR. These OMB numbers are placed as close as possible to the applicable recordkeeping or reporting requirements.

#### OBSOLETE PROVISIONS

Provisions that become obsolete before the revision date stated on the cover of each volume are not carried. Code users may find the text of provisions in effect on a given date in the past by using the appropriate numerical list of sections affected. For the period before January 1, 1986, consult either the List of CFR Sections Affected, 1949-1963, 1964-1972, or 1973-1985, published in seven separate volumes. For the period beginning January 1, 1986, a "List of CFR Sections Affected" is published at the end of each CFR volume.

#### INCORPORATION BY REFERENCE

*What is incorporation by reference?* Incorporation by reference was established by statute and allows Federal agencies to meet the requirement to publish regulations in the Federal Register by referring to materials already published elsewhere. For an incorporation to be valid, the Director of the Federal Register must approve it. The legal effect of incorporation by reference is that the material is treated as if it were published in full in the Federal Register (5 U.S.C. 552(a)). This material, like any other properly issued regulation, has the force of law.

*What is a proper incorporation by reference?* The Director of the Federal Register will approve an incorporation by reference only when the requirements of 1 CFR part 51 are met. Some of the elements on which approval is based are:

- (a) The incorporation will substantially reduce the volume of material published in the Federal Register.
- (b) The matter incorporated is in fact available to the extent necessary to afford fairness and uniformity in the administrative process.
- (c) The incorporating document is drafted and submitted for publication in accordance with 1 CFR part 51.

Properly approved incorporations by reference in this volume are listed in the Finding Aids at the end of this volume.

*What if the material incorporated by reference cannot be found?* If you have any problem locating or obtaining a copy of material listed in the Finding Aids of this volume as an approved incorporation by reference, please contact the agency that issued the regulation containing that incorporation. If, after contacting the agency, you find the material is not available, please notify the Director of the Federal Register, National Archives and Records Administration, Washington DC 20408, or call 202-741-6010.

#### CFR INDEXES AND TABULAR GUIDES

A subject index to the Code of Federal Regulations is contained in a separate volume, revised annually as of January 1, entitled CFR INDEX AND FINDING AIDS. This volume contains the Parallel Table of Statutory Authorities and Agency Rules (Table I). A list of CFR titles, chapters, and parts and an alphabetical list of agencies publishing in the CFR are also included in this volume.

An index to the text of "Title 3—The President" is carried within that volume.

The Federal Register Index is issued monthly in cumulative form. This index is based on a consolidation of the "Contents" entries in the daily Federal Register.

A List of CFR Sections Affected (LSA) is published monthly, keyed to the revision dates of the 50 CFR titles.

## REPUBLICATION OF MATERIAL

There are no restrictions on the republication of material appearing in the Code of Federal Regulations.

## INQUIRIES

For a legal interpretation or explanation of any regulation in this volume, contact the issuing agency. The issuing agency's name appears at the top of odd-numbered pages.

For inquiries concerning CFR reference assistance, call 202-741-6000 or write to the Director, Office of the Federal Register, National Archives and Records Administration, Washington, DC 20408 or e-mail [fedreg.info@nara.gov](mailto:fedreg.info@nara.gov).

## SALES

The Government Printing Office (GPO) processes all sales and distribution of the CFR. For payment by credit card, call toll-free, 866-512-1800, or DC area, 202-512-1800, M-F 8 a.m. to 4 p.m. e.s.t. or fax your order to 202-512-2250, 24 hours a day. For payment by check, write to: US Government Printing Office – New Orders, P.O. Box 979050, St. Louis, MO 63197-9000. For GPO Customer Service call 202-512-1803.

## ELECTRONIC SERVICES

The full text of the Code of Federal Regulations, the LSA (List of CFR Sections Affected), The United States Government Manual, the Federal Register, Public Laws, Public Papers, Weekly Compilation of Presidential Documents and the Privacy Act Compilation are available in electronic format at [www.gpoaccess.gov/nara](http://www.gpoaccess.gov/nara) (“GPO Access”). For more information, contact Electronic Information Dissemination Services, U.S. Government Printing Office. Phone 202-512-1530, or 888-293-6498 (toll-free). E-mail, [gpoaccess@gpo.gov](mailto:gpoaccess@gpo.gov).

The Office of the Federal Register also offers a free service on the National Archives and Records Administration's (NARA) World Wide Web site for public law numbers, Federal Register finding aids, and related information. Connect to NARA's web site at [www.archives.gov/federal-register](http://www.archives.gov/federal-register). The NARA site also contains links to GPO Access.

RAYMOND A. MOSLEY,  
*Director,*  
*Office of the Federal Register.*  
*January 1, 2008.*



## THIS TITLE

Title 14—AERONAUTICS AND SPACE is composed of five volumes. The parts in these volumes are arranged in the following order: parts 1–59, 60–139, 140–199, 200–1199, and part 1200–End. The first three volumes containing parts 1–199 are comprised of chapter I—Federal Aviation Administration, Department of Transportation (DOT). The fourth volume containing parts 200–1199 is comprised of chapter II—Office of the Secretary, DOT (Aviation Proceedings) and chapter III—Commercial Space Transportation, Federal Aviation Administration, DOT. The fifth volume containing part 1200–End is comprised of chapter V—National Aeronautics and Space Administration and chapter VI—Office of Management and Budget. The contents of these volumes represent all current regulations codified under this title of the CFR as of January 1, 2008.

For this volume, Bonnie Fritts was Chief Editor. The Code of Federal Regulations publication program is under the direction of Michael L. White, assisted by Ann Worley.



# Title 14—Aeronautics and Space

(This book contains parts 140 to 199)

---

	<i>Part</i>
CHAPTER I—Federal Aviation Administration, Department of Transportation (Continued) .....	141



# CHAPTER I—FEDERAL AVIATION ADMINISTRATION, DEPARTMENT OF TRANSPORTATION (CONTINUED)

---

## SUBCHAPTER H—SCHOOLS AND OTHER CERTIFICATED AGENCIES

<i>Part</i>		<i>Page</i>
140	[Reserved]	
141	Pilot schools .....	5
142	Training centers .....	40
143	[Reserved]	
145	Repair stations .....	52
147	Aviation maintenance technician schools .....	64

## SUBCHAPTER I—AIRPORTS

150	Airport noise compatibility planning .....	74
151	Federal aid to airports .....	88
152	Airport aid program .....	125
155	Release of airport property from surplus property disposal restrictions .....	160
156	State block grant pilot program .....	164
157	Notice of construction, alteration, activation, and deactivation of airports .....	165
158	Passenger facility charges (PFC's) .....	167
161	Notice and approval of airport noise and access restrictions .....	192
169	Expenditure of Federal funds for nonmilitary airports or air navigation facilities thereon .....	212

## SUBCHAPTER J—NAVIGATIONAL FACILITIES

170	Establishment and discontinuance criteria for air traffic control services and navigational facilities .....	214
171	Non-Federal navigation facilities .....	217

## SUBCHAPTER K—ADMINISTRATIVE REGULATIONS

183	Representatives of the Administrator .....	297
-----	--	-----

14 CFR Ch. I (1-1-08 Edition)

<i>Part</i>		<i>Page</i>
185	Testimony by employees and production of records in legal proceedings, and service of legal process and pleadings .....	305
187	Fees .....	305
189	Use of Federal Aviation Administration commu- nications system .....	309
193	Protection of voluntarily submitted information ...	311
	SUBCHAPTERS L-M [RESERVED]	
	SUBCHAPTER N—WAR RISK INSURANCE	
198	Aviation insurance .....	316
199	[Reserved]	

## SUBCHAPTER H—SCHOOLS AND OTHER CERTIFICATED AGENCIES

### PART 140 [RESERVED]

### PART 141—PILOT SCHOOLS

#### Subpart A—General

- Sec.
- 141.1 Applicability.
  - 141.3 Certificate required.
  - 141.5 Requirements for a pilot school certificate.
  - 141.7 Provisional pilot school certificate.
  - 141.9 Examining authority.
  - 141.11 Pilot school ratings.
  - 141.13 Application for issuance, amendment, or renewal.
  - 141.17 Duration of certificate and examining authority.
  - 141.18 Carriage of narcotic drugs, marijuana, and depressant or stimulant drugs or substances.
  - 141.19 Display of certificate.
  - 141.21 Inspections.
  - 141.23 Advertising limitations.
  - 141.25 Business office and operations base.
  - 141.26 Training agreements.
  - 141.27 Renewal of certificates and ratings.
  - 141.29 [Reserved]

#### Subpart B—Personnel, Aircraft, and Facilities Requirements

- 141.31 Applicability.
- 141.33 Personnel.
- 141.35 Chief instructor qualifications.
- 141.36 Assistant chief instructor qualifications.
- 141.37 Check instructor qualifications.
- 141.38 Airports.
- 141.39 Aircraft.
- 141.41 Flight simulators, flight training devices, and training aids.
- 141.43 Pilot briefing areas.
- 141.45 Ground training facilities.

#### Subpart C—Training Course Outline and Curriculum

- 141.51 Applicability.
- 141.53 Approval procedures for a training course: General.
- 141.55 Training course: Contents.
- 141.57 Special curricula.

#### Subpart D—Examining Authority

- 141.61 Applicability.
- 141.63 Examining authority qualification requirements.
- 141.65 Privileges.
- 141.67 Limitations and reports.

#### Subpart E—Operating Rules

- 141.71 Applicability.
- 141.73 Privileges.
- 141.75 Aircraft requirements.
- 141.77 Limitations.
- 141.79 Flight training.
- 141.81 Ground training.
- 141.83 Quality of training.
- 141.85 Chief instructor responsibilities.
- 141.87 Change of chief instructor.
- 141.89 Maintenance of personnel, facilities, and equipment.
- 141.91 Satellite bases.
- 141.93 Enrollment.
- 141.95 Graduation certificate.

#### Subpart F—Records

- 141.101 Training records.
- APPENDIX A TO PART 141—RECREATIONAL PILOT CERTIFICATION COURSE
- APPENDIX B TO PART 141—PRIVATE PILOT CERTIFICATION COURSE
- APPENDIX C TO PART 141—INSTRUMENT RATING COURSE
- APPENDIX D TO PART 141—COMMERCIAL PILOT CERTIFICATION COURSE
- APPENDIX E TO PART 141—AIRLINE TRANSPORT PILOT CERTIFICATION COURSE
- APPENDIX F TO PART 141—FLIGHT INSTRUCTOR CERTIFICATION COURSE
- APPENDIX G TO PART 141—FLIGHT INSTRUCTOR INSTRUMENT (FOR AN AIRPLANE, HELICOPTER, OR POWERED-LIFT INSTRUMENT INSTRUCTOR RATING) CERTIFICATION COURSE
- APPENDIX H TO PART 141—GROUND INSTRUCTOR CERTIFICATION COURSE
- APPENDIX I TO PART 141—ADDITIONAL AIRCRAFT CATEGORY OR CLASS RATING COURSE
- APPENDIX J TO PART 141—AIRCRAFT TYPE RATING COURSE, FOR OTHER THAN AN AIRLINE TRANSPORT PILOT CERTIFICATE
- APPENDIX K TO PART 141—SPECIAL PREPARATION COURSES
- APPENDIX L TO PART 141—PILOT GROUND SCHOOL COURSE

AUTHORITY: 49 U.S.C. 106(g), 40113, 44701-44703, 44707, 44709, 44711, 45102-45103, 45301-45302.

SOURCE: Docket No. 25910, 62 FR 16347, Apr. 4, 1997, unless otherwise noted.

#### Subpart A—General

##### § 141.1 Applicability.

This part prescribes the requirements for issuing pilot school certificates,

**§ 141.3**

provisional pilot school certificates, and associated ratings, and the general operating rules applicable to a holder of a certificate or rating issued under this part.

**§ 141.3 Certificate required.**

No person may operate as a certificated pilot school without, or in violation of, a pilot school certificate or provisional pilot school certificate issued under this part.

**§ 141.5 Requirements for a pilot school certificate.**

An applicant may be issued a pilot school certificate with associated ratings if the applicant:

- (a) Completes the application for a pilot school certificate on a form and in a manner prescribed by the Administrator;
- (b) Holds a provisional pilot school certificate, issued under this part, for at least 24 calendar months preceding the month in which the application for a pilot school certificate is made;
- (c) Meets the applicable requirements of subparts A through C of this part for the school ratings sought; and
- (d) Has trained and recommended for pilot certification and rating tests, within 24 calendar months preceding the month the application is made for the pilot school certificate, at least 10 students for a knowledge or practical test for a pilot certificate, flight instructor certificate, ground instructor certificate, an additional rating, an end-of-course test for a training course specified in appendix K to this part, or any combination of those tests, and at least 80 percent of all tests administered were passed on the first attempt.

[Doc. No. 25910, 62 FR 16347, Apr. 4, 1997; Amdt. 141-9, 62 FR 40907, July 30, 1997]

**§ 141.7 Provisional pilot school certificate.**

An applicant that meets the applicable requirements of subparts A, B, and C of this part, but does not meet the recent training activity requirements of § 141.5(d) of this part, may be issued a provisional pilot school certificate with ratings.

**§ 141.9 Examining authority.**

An applicant is issued examining authority for its pilot school certificate if the applicant meets the requirements of subpart D of this part.

**§ 141.11 Pilot school ratings.**

(a) The ratings listed in paragraph (b) of this section may be issued to an applicant for:

(1) A pilot school certificate, provided the applicant meets the requirements of § 141.5 of this part; or

(2) A provisional pilot school certificate, provided the applicant meets the requirements of § 141.7 of this part.

(b) An applicant may be authorized to conduct the following courses:

(1) *Certification and rating courses.* (Appendixes A through J).

- (i) Recreational pilot course.
- (ii) Private pilot course.
- (iii) Commercial pilot course.
- (iv) Instrument rating course.
- (v) Airline transport pilot course.
- (vi) Flight instructor course.
- (vii) Flight instructor instrument course.
- (viii) Ground instructor course.
- (ix) Additional aircraft category or class rating course.
- (x) Aircraft type rating course.

(2) *Special preparation courses.* (Appendix K).

- (i) Pilot refresher course.
- (ii) Flight instructor refresher course.
- (iii) Ground instructor refresher course.
- (iv) Agricultural aircraft operations course.
- (v) Rotorcraft external-load operations course.
- (vi) Special operations course.
- (vii) Test pilot course.

(3) *Pilot ground school course.* (Appendix L).

**§ 141.13 Application for issuance, amendment, or renewal.**

(a) Application for an original certificate and rating, an additional rating, or the renewal of a certificate under this part must be made on a form and in a manner prescribed by the Administrator.

(b) Application for the issuance or amendment of a certificate or rating must be accompanied by two copies of

## Federal Aviation Administration, DOT

## § 141.25

each proposed training course curriculum for which approval is sought.

### § 141.17 Duration of certificate and examining authority.

(a) Unless surrendered, suspended, or revoked, a pilot school's certificate or a provisional pilot school's certificate expires:

(1) On the last day of the 24th calendar month from the month the certificate was issued;

(2) Except as provided in paragraph (b) of this section, on the date that any change in ownership of the school occurs;

(3) On the date of any change in the facilities upon which the school's certificate is based occurs; or

(4) Upon notice by the Administrator that the school has failed for more than 60 days to maintain the facilities, aircraft, or personnel required for any one of the school's approved training courses.

(b) A change in the ownership of a pilot school or provisional pilot school does not terminate that school's certificate if, within 30 days after the date that any change in ownership of the school occurs:

(1) Application is made for an appropriate amendment to the certificate; and

(2) No change in the facilities, personnel, or approved training courses is involved.

(c) An examining authority issued to the holder of a pilot school certificate expires on the date that the pilot school certificate expires, or is surrendered, suspended, or revoked.

### § 141.18 Carriage of narcotic drugs, marijuana, and depressant or stimulant drugs or substances.

If the holder of a certificate issued under this part permits any aircraft owned or leased by that holder to be engaged in any operation that the certificate holder knows to be in violation of § 91.19(a) of this chapter, that operation is a basis for suspending or revoking the certificate.

### § 141.19 Display of certificate.

(a) Each holder of a pilot school certificate or a provisional pilot school certificate must display that certifi-

cate in a place in the school that is normally accessible to the public and is not obscured.

(b) A certificate must be made available for inspection upon request by:

(1) The Administrator;

(2) An authorized representative of the National Transportation Safety Board; or

(3) A Federal, State, or local law enforcement officer.

### § 141.21 Inspections.

Each holder of a certificate issued under this part must allow the Administrator to inspect its personnel, facilities, equipment, and records to determine the certificate holder's:

(a) Eligibility to hold its certificate;

(b) Compliance with 49 U.S.C. 40101 *et seq.*, formerly the Federal Aviation Act of 1958, as amended; and

(c) Compliance with the Federal Aviation Regulations.

### § 141.23 Advertising limitations.

(a) The holder of a pilot school certificate or a provisional pilot school certificate may not make any statement relating to its certification and ratings that is false or designed to mislead any person contemplating enrollment in that school.

(b) The holder of a pilot school certificate or a provisional pilot school certificate may not advertise that the school is certificated unless it clearly differentiates between courses that have been approved under part 141 of this chapter and those that have not been approved under part 141 of this chapter.

(c) The holder of a pilot school certificate or a provisional pilot school certificate must promptly remove:

(1) From vacated premises, all signs indicating that the school was certificated by the Administrator; or

(2) All indications (including signs), wherever located, that the school is certificated by the Administrator when its certificate has expired or has been surrendered, suspended, or revoked.

### § 141.25 Business office and operations base.

(a) Each holder of a pilot school or a provisional pilot school certificate

**§ 141.26**

must maintain a principal business office with a mailing address in the name shown on its certificate.

(b) The facilities and equipment at the principal business office must be adequate to maintain the files and records required to operate the business of the school.

(c) The principal business office may not be shared with, or used by, another pilot school.

(d) Before changing the location of the principal business office or the operations base, each certificate holder must notify the FAA Flight Standards District Office having jurisdiction over the area of the new location, and the notice must be:

- (1) Submitted in writing at least 30 days before the change of location; and
- (2) Accompanied by any amendments needed for the certificate holder's approved training course outline.

(e) A certificate holder may conduct training at an operations base other than the one specified in its certificate, if:

- (1) The Administrator has inspected and approved the base for use by the certificate holder; and
- (2) The course of training and any needed amendments have been approved for use at that base.

**§ 141.26 Training agreements.**

A training center certificated under part 142 of this chapter may provide the training, testing, and checking for pilot schools certificated under part 141 of this chapter, and is considered to meet the requirements of part 141, provided—

- (a) There is a training agreement between the certificated training center and the pilot school;
- (b) The training, testing, and checking provided by the certificated training center is approved and conducted under part 142;
- (c) The pilot school certificated under part 141 obtains the Administrator's approval for a training course outline that includes the training, testing, and checking to be conducted under part 141 and the training, testing, and checking to be conducted under part 142; and
- (d) Upon completion of the training, testing, and checking conducted under

**14 CFR Ch. I (1–1–08 Edition)**

part 142, a copy of each student's training record is forwarded to the part 141 school and becomes part of the student's permanent training record.

**§ 141.27 Renewal of certificates and ratings.**

(a) *Pilot school.* (1) A pilot school may apply for renewal of its school certificate and ratings within 30 days preceding the month the pilot school's certificate expires, provided the school meets the requirements prescribed in paragraph (a)(2) of this section for renewal of its certificate and ratings.

(2) A pilot school may have its school certificate and ratings renewed for an additional 24 calendar months if the Administrator determines the school's personnel, aircraft, facility and airport, approved training courses, training records, and recent training ability and quality meet the requirements of this part.

(3) A pilot school that does not meet the renewal requirements in paragraph (a)(2) of this section, may apply for a provisional pilot school certificate if the school meets the requirements of § 141.7 of this part.

(b) *Provisional pilot school.* (1) Except as provided in paragraph (b)(3) of this section, a provisional pilot school may not have its provisional pilot school certificate or the ratings on that certificate renewed.

(2) A provisional pilot school may apply for a pilot school certificate and associated ratings provided that school meets the requirements of § 141.5 of this part.

(3) A former provisional pilot school may apply for another provisional pilot school certificate, provided 180 days have elapsed since its last provisional pilot school certificate expired.

**§ 141.29 [Reserved]**

**Subpart B—Personnel, Aircraft, and Facilities Requirements**

**§ 141.31 Applicability.**

- (a) This subpart prescribes:
  - (1) The personnel and aircraft requirements for a pilot school certificate or a provisional pilot school certificate; and

**Federal Aviation Administration, DOT**

**§ 141.35**

(2) The facilities that a pilot school or provisional pilot school must have available on a continuous basis.

(b) As used in this subpart, to have continuous use of a facility, including an airport, the school must have:

(1) Ownership of the facility or airport for at least 6 calendar months after the date the application for initial certification and on the date of renewal of the school's certificate is made; or

(2) A written lease agreement for the facility or airport for at least 6 calendar months after the date the application for initial certification and on the date of renewal of the school's certificate is made.

[Doc. No. 25910, 62 FR 16347, Apr. 4, 1997; Amdt. 141-9, 62 FR 40907, July 30, 1997]

**§ 141.33 Personnel.**

(a) An applicant for a pilot school certificate or for a provisional pilot school certificate must meet the following personnel requirements:

(1) Each applicant must have adequate personnel, including certificated flight instructors, certificated ground instructors, or holders of a commercial pilot certificate with a lighter-than-air rating, and a chief instructor for each approved course of training who is qualified and competent to perform the duties to which that instructor is assigned.

(2) If the school employs dispatchers, aircraft handlers, and line and service personnel, then it must instruct those persons in the procedures and responsibilities of their employment.

(3) Each instructor to be used for ground or flight training must hold a flight instructor certificate, ground instructor certificate, or commercial pilot certificate with a lighter-than-air rating, as appropriate, with ratings for the approved course of training and any aircraft used in that course.

(b) An applicant for a pilot school certificate or for a provisional pilot school certificate must designate a chief instructor for each of the school's approved training courses, who must meet the requirements of §141.35 of this part.

(c) When necessary, an applicant for a pilot school certificate or for a provisional pilot school certificate may des-

ignate a person to be an assistant chief instructor for an approved training course, provided that person meets the requirements of §141.36 of this part.

(d) A pilot school and a provisional pilot school may designate a person to be a check instructor for conducting student stage checks, end-of-course tests, and instructor proficiency checks, provided:

(1) That person meets the requirements of §141.37 of this part; and

(2) That school has a student enrollment of at least 50 students at the time designation is sought.

(e) A person, as listed in this section, may serve in more than one position for a school, provided that person is qualified for each position.

[Doc. No. 25910, 62 FR 16347, Apr. 4, 1997; Amdt. 141-9, 62 FR 40907, July 30, 1997]

**§ 141.35 Chief instructor qualifications.**

(a) To be eligible for designation as a chief instructor for a course of training, a person must meet the following requirements:

(1) Hold a commercial pilot certificate or an airline transport pilot certificate, and, except for a chief instructor for a course of training solely for a lighter-than-air rating, a current flight instructor certificate. The certificates must contain the appropriate aircraft category and class ratings for the category and class of aircraft used in the course and an instrument rating, if an instrument rating is required for enrollment in the course of training;

(2) Meet the pilot-in-command recent flight experience requirements of §61.57 of this chapter;

(3) Pass a knowledge test on—

(i) Teaching methods;

(ii) Applicable provisions of the "Aeronautical Information Manual";

(iii) Applicable provisions of parts 61, 91, and 141 of this chapter; and

(iv) The objectives and approved course completion standards of the course for which the person seeks to obtain designation.

(4) Pass a proficiency test on instructional skills and ability to train students on the flight procedures and maneuvers appropriate to the course;

(5) Except for a course of training for gliders, balloons, or airships, the chief

**§ 141.36**

**14 CFR Ch. I (1–1–08 Edition)**

instructor must meet the applicable requirements in paragraphs (b), (c), and (d) of this section; and

(6) A chief instructor for a course of training for gliders, balloons or airships is only required to have 40 percent of the hours required in paragraphs (b) and (d) of this section.

(b) For a course of training leading to the issuance of a recreational or private pilot certificate or rating, a chief instructor must have:

(1) At least 1,000 hours as pilot in command; and

(2) Primary flight training experience, acquired as either a certificated flight instructor or an instructor in a military pilot flight training program, or a combination thereof, consisting of at least—

(i) 2 years and a total of 500 flight hours; or

(ii) 1,000 flight hours.

(c) For a course of training leading to the issuance of an instrument rating or a rating with instrument privileges, a chief instructor must have:

(1) At least 100 hours of flight time under actual or simulated instrument conditions;

(2) At least 1,000 hours as pilot in command; and

(3) Instrument flight instructor experience, acquired as either a certificated flight instructor-instrument or an instructor in a military pilot flight training program, or a combination thereof, consisting of at least—

(i) 2 years and a total of 250 flight hours; or

(ii) 400 flight hours.

(d) For a course of training other than one leading to the issuance of a recreational or private pilot certificate or rating, or an instrument rating or a rating with instrument privileges, a chief instructor must have:

(1) At least 2,000 hours as pilot in command; and

(2) Flight training experience, acquired as either a certificated flight instructor or an instructor in a military pilot flight training program, or a combination thereof, consisting of at least—

(i) 3 years and a total of 1,000 flight hours; or

(ii) 1,500 flight hours.

(e) To be eligible for designation as chief instructor for a ground school course, a person must have 1 year of experience as a ground school instructor at a certificated pilot school.

[Doc. No. 25910, 62 FR 16347, Apr. 4, 1997; Amdt. 141–9, 62 FR 40907, July 30, 1997; as amended by Amdt. 141–10, 63 FR 20289, Apr. 23, 1998]

**§ 141.36 Assistant chief instructor qualifications.**

(a) To be eligible for designation as an assistant chief instructor for a course of training, a person must meet the following requirements:

(1) Hold a commercial pilot or an airline transport pilot certificate and, except for the assistant chief instructor for a course of training solely for a lighter-than-air rating, a current flight instructor certificate. The certificates must contain the appropriate aircraft category, class, and instrument ratings if an instrument rating is required by the course of training for the category and class of aircraft used in the course;

(2) Meet the pilot-in-command recent flight experience requirements of § 61.57 of this chapter;

(3) Pass a knowledge test on—

(i) Teaching methods;

(ii) Applicable provisions of the “Aeronautical Information Manual”;

(iii) Applicable provisions of parts 61, 91, and 141 of this chapter; and

(iv) The objectives and approved course completion standards of the course for which the person seeks to obtain designation.

(4) Pass a proficiency test on the flight procedures and maneuvers appropriate to that course; and

(5) Meet the applicable requirements in paragraphs (b), (c), and (d) of this section. However, an assistant chief instructor for a course of training for gliders, balloons, or airships is only required to have 40 percent of the hours required in paragraphs (b) and (d) of this section.

(b) For a course of training leading to the issuance of a recreational or private pilot certificate or rating, an assistant chief instructor must have:

(1) At least 500 hours as pilot in command; and

(2) Flight training experience, acquired as either a certificated flight instructor or an instructor in a military pilot flight training program, or a combination thereof, consisting of at least—

(i) 1 year and a total of 250 flight hours; or

(ii) 500 flight hours.

(c) For a course of training leading to the issuance of an instrument rating or a rating with instrument privileges, an assistant chief flight instructor must have:

(1) At least 50 hours of flight time under actual or simulated instrument conditions;

(2) At least 500 hours as pilot in command; and

(3) Instrument flight instructor experience, acquired as either a certificated flight instructor-instrument or an instructor in a military pilot flight training program, or a combination thereof, consisting of at least—

(i) 1 year and a total of 125 flight hours; or

(ii) 200 flight hours.

(d) For a course of training other than one leading to the issuance of a recreational or private pilot certificate or rating, or an instrument rating or a rating with instrument privileges, an assistant chief instructor must have:

(1) At least 1,000 hours as pilot in command; and

(2) Flight training experience, acquired as either a certificated flight instructor or an instructor in a military pilot flight training program, or a combination thereof, consisting of at least—

(i) 1½ years and a total of 500 flight hours; or

(ii) 750 flight hours.

(e) To be eligible for designation as an assistant chief instructor for a ground school course, a person must have 6 months of experience as a ground school instructor at a certificated pilot school.

[Doc. No. 25910, 62 FR 16347, Apr. 4, 1997; Amdt. 141-9, 62 FR 40907, July 30, 1997; as amended by Amdt. 141-10, 63 FR 20289, Apr. 23, 1998]

### § 141.37 Check instructor qualifications.

(a) To be designated as a check instructor for conducting student stage checks, end-of-course tests, and instructor proficiency checks under this part, a person must meet the eligibility requirements of this section:

(1) For checks and tests that relate to either flight or ground training, the person must pass a test, given by the chief instructor, on—

(i) Teaching methods;

(ii) Applicable provisions of the “Aeronautical Information Manual”;

(iii) Applicable provisions of parts 61, 91, and 141 of this chapter; and

(iv) The objectives and course completion standards of the approved training course for the designation sought.

(2) For checks and tests that relate to a flight training course, the person must—

(i) Meet the requirements in paragraph (a)(1) of this section;

(ii) Hold a commercial pilot certificate or an airline transport pilot certificate and, except for a check instructor for a course of training for a lighter-than-air rating, a current flight instructor certificate. The certificates must contain the appropriate aircraft category, class, and instrument ratings for the category and class of aircraft used in the course;

(iii) Meet the pilot-in-command recent flight experience requirements of § 61.57 of this chapter; and

(iv) Pass a proficiency test, given by the chief instructor or assistant chief instructor, on the flight procedures and maneuvers of the approved training course for the designation sought.

(3) For checks and tests that relate to ground training, the person must—

(i) Meet the requirements in paragraph (a)(1) of this section;

(ii) Except for a course of training for a lighter-than-air rating, hold a current flight instructor certificate or ground instructor certificate with ratings appropriate to the category and class of aircraft used in the course; and

(iii) For a course of training for a lighter-than-air rating, hold a commercial pilot certificate with a lighter-than-air category rating and the appropriate class rating.

### § 141.38

(b) A person who meets the eligibility requirements in paragraph (a) of this section must:

(1) Be designated, in writing, by the chief instructor to conduct student stage checks, end-of-course tests, and instructor proficiency checks; and

(2) Be approved by the FAA Flight Standards District Office having jurisdiction over the school.

(c) A check instructor may not conduct a stage check or an end-of-course test of any student for whom the check instructor has:

(1) Served as the principal instructor; or

(2) Recommended for a stage check or end-of-course test.

[Doc. No. 25910, 62 FR 16347, Apr. 4, 1997; Amdt. 141-9, 62 FR 40907, July 30, 1997]

### § 141.38 Airports.

(a) An applicant for a pilot school certificate or a provisional pilot school certificate must show that he or she has continuous use of each airport at which training flights originate.

(b) Each airport used for airplanes and gliders must have at least one runway or takeoff area that allows training aircraft to make a normal takeoff or landing under the following conditions at the aircraft's maximum certificated takeoff gross weight:

(1) Under wind conditions of not more than 5 miles per hour;

(2) At temperatures in the operating area equal to the mean high temperature for the hottest month of the year;

(3) If applicable, with the powerplant operation, and landing gear and flap operation recommended by the manufacturer; and

(4) In the case of a takeoff—

(i) With smooth transition from lift-off to the best rate of climb speed without exceptional piloting skills or techniques; and

(ii) Clearing all obstacles in the take-off flight path by at least 50 feet.

(c) Each airport must have a wind direction indicator that is visible from the end of each runway at ground level;

(d) Each airport must have a traffic direction indicator when:

(1) The airport does not have an operating control tower; and

(2) UNICOM advisories are not available.

### 14 CFR Ch. I (1-1-08 Edition)

(e) Except as provided in paragraph (f) of this section, each airport used for night training flights must have permanent runway lights;

(f) An airport or seaplane base used for night training flights in seaplanes is permitted to use adequate non-permanent lighting or shoreline lighting, if approved by the Administrator.

[Doc. No. 25910, 62 FR 16347, Apr. 4, 1997; Amdt. 141-9, 62 FR 40907, July 30, 1997]

### § 141.39 Aircraft.

An applicant for a pilot school certificate or provisional pilot school certificate must show that each aircraft used by that school for flight training and solo flights meets the following requirements:

(a) Each aircraft must be registered as a civil aircraft in the United States;

(b) Each aircraft must be certificated with a standard airworthiness certificate or a primary airworthiness certificate, unless the Administrator determines that due to the nature of the approved course, an aircraft not having a standard airworthiness certificate or primary airworthiness certificate may be used;

(c) Each aircraft must be maintained and inspected in accordance with the requirements under subpart E of part 91 of this chapter that apply to aircraft operated for hire;

(d) Each aircraft used in flight training must have at least two pilot stations with engine-power controls that can be easily reached and operated in a normal manner from both pilot stations; and

(e) Each aircraft used in a course involving IFR en route operations and instrument approaches must be equipped and maintained for IFR operations. For training in the control and precision maneuvering of an aircraft by reference to instruments, the aircraft may be equipped as provided in the approved course of training.

[Doc. No. 25910, 62 FR 16347, Apr. 4, 1997; Amdt. 141-9, 62 FR 40908, July 30, 1997]

### § 141.41 Flight simulators, flight training devices, and training aids.

An applicant for a pilot school certificate or a provisional pilot school certificate must show that its flight

simulators, flight training devices, training aids, and equipment meet the following requirements:

(a) *Flight simulators.* Each flight simulator used to obtain flight training credit allowed for flight simulators in an approved pilot training course curriculum must—

(1) Be a full-size aircraft cockpit replica of a specific type of aircraft, or make, model, and series of aircraft;

(2) Include the hardware and software necessary to represent the aircraft in ground operations and flight operations;

(3) Use a force cueing system that provides cues at least equivalent to those cues provided by a 3 degree freedom of motion system;

(4) Use a visual system that provides at least a 45-degree horizontal field of view and a 30-degree vertical field of view simultaneously for each pilot; and

(5) Have been evaluated, qualified, and approved by the Administrator.

(b) *Flight training devices.* Each flight training device used to obtain flight training credit allowed for flight training devices in an approved pilot training course curriculum must—

(1) Be a full-size replica of instruments, equipment panels, and controls of an aircraft, or set of aircraft, in an open flight deck area or in an enclosed cockpit, including the hardware and software for the systems installed that is necessary to simulate the aircraft in ground and flight operations;

(2) Need not have a force (motion) cueing or visual system; and

(3) Have been evaluated, qualified, and approved by the Administrator.

(c) *Training aids and equipment.* Each training aid, including any audiovisual aid, projector, tape recorder, mockup, chart, or aircraft component listed in the approved training course outline, must be accurate and appropriate to the course for which it is used.

[Doc. No. 25910, 62 FR 16347, Apr. 4, 1997; Amdt. 141-9, 62 FR 40908, July 30, 1997]

#### § 141.43 Pilot briefing areas.

(a) An applicant for a pilot school certificate or provisional pilot school certificate must show that the applicant has continuous use of a briefing area located at each airport at which training flights originate that is:

(1) Adequate to shelter students waiting to engage in their training flights;

(2) Arranged and equipped for the conduct of pilot briefings; and

(3) Except as provided in paragraph (c) of this section, for a school with an instrument rating or commercial pilot course, equipped with private landline or telephone communication to the nearest FAA Flight Service Station.

(b) A briefing area required by paragraph (a) of this section may not be used by the applicant if it is available for use by any other pilot school during the period it is required for use by the applicant.

(c) The communication equipment required by paragraph (a)(3) of this section is not required if the briefing area and the flight service station are located on the same airport, and are readily accessible to each other.

#### § 141.45 Ground training facilities.

An applicant for a pilot school or provisional pilot school certificate must show that:

(a) Each room, training booth, or other space used for instructional purposes is heated, lighted, and ventilated to conform to local building, sanitation, and health codes; and

(b) The training facility is so located that the students in that facility are not distracted by the training conducted in other rooms, or by flight and maintenance operations on the airport.

### Subpart C—Training Course Outline and Curriculum

#### § 141.51 Applicability.

This subpart prescribes the curriculum and course outline requirements for the issuance of a pilot school certificate or provisional pilot school certificate and ratings.

#### § 141.53 Approval procedures for a training course: General.

(a) *General.* An applicant for a pilot school certificate or provisional pilot school certificate must obtain the Administrator's approval of the outline of each training course for which certification and rating is sought.

(b) *Application.* (1) An application for the approval of an initial or amended training course must be submitted in

§ 141.55

14 CFR Ch. I (1-1-08 Edition)

duplicate to the FAA Flight Standards District Office having jurisdiction over the area where the school is based.

(2) An application for the approval of an initial or amended training course must be submitted at least 30 days before any training under that course, or any amendment thereto, is scheduled to begin.

(3) An application for amending a training course must be accompanied by two copies of the amendment.

(c) *Training courses.* (1) A training course submitted for approval prior to August 4, 1997 may, if approved, retain that approval until 1 year after August 4, 1997.

(2) An applicant for a pilot school certificate or provisional pilot school certificate may request approval of the training courses specified in §141.11(b) of this part.

[Doc. No. 25910, 62 FR 16347, Apr. 4, 1997; Amdt. 141-9, 62 FR 40908, July 30, 1997]

§ 141.55 **Training course: Contents.**

(a) Each training course for which approval is requested must meet the minimum curriculum requirements in accordance with the appropriate appendix of this part.

(b) Except as provided in paragraphs (d) and (e) of this section, each training course for which approval is requested must meet the minimum ground and flight training time requirements in accordance with the appropriate appendix of this part.

(c) Each training course for which approval is requested must contain:

(1) A description of each room used for ground training, including the room's size and the maximum number of students that may be trained in the room at one time;

(2) A description of each type of audiovisual aid, projector, tape recorder, mockup, chart, aircraft component, and other special training aids used for ground training;

(3) A description of each flight simulator or flight training device used for training;

(4) A listing of the airports at which training flights originate and a description of the facilities, including pilot briefing areas that are available for use by the school's students and personnel at each of those airports;

(5) A description of the type of aircraft including any special equipment used for each phase of training;

(6) The minimum qualifications and ratings for each instructor assigned to ground or flight training; and

(7) A training syllabus that includes the following information—

(i) The prerequisites for enrolling in the ground and flight portion of the course that include the pilot certificate and rating (if required by this part), training, pilot experience, and pilot knowledge;

(ii) A detailed description of each lesson, including the lesson's objectives, standards, and planned time for completion;

(iii) A description of what the course is expected to accomplish with regard to student learning;

(iv) The expected accomplishments and the standards for each stage of training; and

(v) A description of the checks and tests to be used to measure a student's accomplishments for each stage of training.

(d) A pilot school may request and receive initial approval for a period of not more than 24 calendar months for any of the training courses of this part without specifying the minimum ground and flight training time requirements of this part, provided the following provisions are met:

(1) The school holds a pilot school certificate issued under this part and has held that certificate for a period of at least 24 consecutive calendar months preceding the month of the request;

(2) In addition to the information required by paragraph (c) of this section, the training course specifies planned ground and flight training time requirements for the course;

(3) The school does not request the training course to be approved for examining authority, nor may that school hold examining authority for that course; and

(4) The practical test or knowledge test for the course is to be given by—

(i) An FAA inspector; or  
(ii) An examiner who is not an employee of the school.

(e) A certificated pilot school may request and receive final approval for any

of the training courses of this part without specifying the minimum ground and flight training time requirements of this part, provided the following conditions are met:

(1) The school has held initial approval for that training course for at least 24 calendar months.

(2) The school has—

(i) Trained at least 10 students in that training course within the preceding 24 calendar months and recommended those students for a pilot, flight instructor, or ground instructor certificate or rating; and

(ii) At least 80 percent of those students passed the practical or knowledge test, or any combination thereof, on the first attempt, and that test was given by—

(A) An FAA inspector; or

(B) An examiner who is not an employee of the school.

(3) In addition to the information required by paragraph (c) of this section, the training course specifies planned ground and flight training time requirements for the course.

(4) The school does not request that the training course be approved for examining authority nor may that school hold examining authority for that course.

#### § 141.57 Special curricula.

An applicant for a pilot school certificate or provisional pilot school certificate may apply for approval to conduct a special course of airman training for which a curriculum is not prescribed in the appendixes of this part, if the applicant shows that the training course contains features that could achieve a level of pilot proficiency equivalent to that achieved by a training course prescribed in the appendixes of this part or the requirements of part 61 of this chapter.

### Subpart D—Examining Authority

#### § 141.61 Applicability.

This subpart prescribes the requirements for the issuance of examining authority to the holder of a pilot school certificate, and the privileges and limitations of that examining authority.

#### § 141.63 Examining authority qualification requirements.

(a) A pilot school must meet the following prerequisites to receive initial approval for examining authority:

(1) The school must complete the application for examining authority on a form and in a manner prescribed by the Administrator;

(2) The school must hold a pilot school certificate and rating issued under this part;

(3) The school must have held the rating in which examining authority is sought for at least 24 consecutive calendar months preceding the month of application for examining authority;

(4) The training course for which examining authority is requested may not be a course that is approved without meeting the minimum ground and flight training time requirements of this part; and

(5) Within 24 calendar months before the date of application for examining authority, that school must meet the following requirements—

(i) The school must have trained at least 10 students in the training course for which examining authority is sought and recommended those students for a pilot, flight instructor, or ground instructor certificate or rating; and

(ii) At least 90 percent of those students passed the required practical or knowledge test, or any combination thereof, for the pilot, flight instructor, or ground instructor certificate or rating on the first attempt, and that test was given by—

(A) An FAA inspector; or

(B) An examiner who is not an employee of the school.

(b) A pilot school must meet the following requirements to retain approval of its examining authority:

(1) The school must complete the application for renewal of its examining authority on a form and in a manner prescribed by the Administrator;

(2) The school must hold a pilot school certificate and rating issued under this part;

(3) The school must have held the rating for which continued examining authority is sought for at least 24 calendar months preceding the month of

## § 141.65

application for renewal of its examining authority; and

(4) The training course for which continued examining authority is requested may not be a course that is approved without meeting the minimum ground and flight training time requirements of this part.

[Doc. No. 25910, 62 FR 16347, Apr. 4, 1997; Amdt. 141-9, 62 FR 40908, July 30, 1997]

### § 141.65 Privileges.

A pilot school that holds examining authority may recommend a person who graduated from its course for the appropriate pilot, flight instructor, or ground instructor certificate or rating without taking the FAA knowledge test or practical test in accordance with the provisions of this subpart.

### § 141.67 Limitations and reports.

A pilot school that holds examining authority may only recommend the issuance of a pilot, flight instructor, or ground instructor certificate and rating to a person who does not take an FAA knowledge test or practical test, if the recommendation for the issuance of that certificate or rating is in accordance with the following requirements:

(a) The person graduated from a training course for which the pilot school holds examining authority.

(b) Except as provided in this paragraph, the person satisfactorily completed all the curriculum requirements of that pilot school's approved training course. A person who transfers from one part 141 approved pilot school to another part 141 approved pilot school may receive credit for that previous training, provided the following requirements are met:

(1) The maximum credited training time does not exceed one-half of the receiving school's curriculum requirements;

(2) The person completes a knowledge and proficiency test conducted by the receiving school for the purpose of determining the amount of pilot experience and knowledge to be credited;

(3) The receiving school determines (based on the person's performance on the knowledge and proficiency test required by paragraph (b)(2) of this section) the amount of credit to be award-

## 14 CFR Ch. I (1-1-08 Edition)

ed, and records that credit in the person's training record;

(4) The person who requests credit for previous pilot experience and knowledge obtained the experience and knowledge from another part 141 approved pilot school and training course; and

(5) The receiving school retains a copy of the person's training record from the previous school.

(c) Tests given by a pilot school that holds examining authority must be approved by the Administrator and be at least equal in scope, depth, and difficulty to the comparable knowledge and practical tests prescribed by the Administrator under part 61 of this chapter.

(d) A pilot school that holds examining authority may not use its knowledge or practical tests if the school:

(1) Knows, or has reason to believe, the test has been compromised; or

(2) Is notified by an FAA Flight Standards District Office that there is reason to believe or it is known that the test has been compromised.

(e) A pilot school that holds examining authority must maintain a record of all temporary airman certificates it issues, which consist of the following information:

(1) A chronological listing that includes—

(i) The date the temporary airman certificate was issued;

(ii) The student to whom the temporary airman certificate was issued, and that student's permanent mailing address and telephone number;

(iii) The training course from which the student graduated;

(iv) The name of person who conducted the knowledge or practical test;

(v) The type of temporary airman certificate or rating issued to the student; and

(vi) The date the student's airman application file was sent to the FAA for processing for a permanent airman certificate.

(2) A copy of the record containing each student's graduation certificate, airman application, temporary airman certificate, superseded airman certificate (if applicable), and knowledge test or practical test results; and

(3) The records required by paragraph (e) of this section must be retained for 1 year and made available to the Administrator upon request. These records must be surrendered to the Administrator when the pilot school ceases to have examining authority.

(f) Except for pilot schools that have an airman certification representative, when a student passes the knowledge test or practical test, the pilot school that holds examining authority must submit that student's airman application file and training record to the FAA for processing for the issuance of a permanent airman certificate.

[Doc. No. 25910, 62 FR 16347, Apr. 4, 1997; Amdt. 141-9, 62 FR 40908, July 30, 1997]

### Subpart E—Operating Rules

#### § 141.71 Applicability.

This subpart prescribes the operating rules applicable to a pilot school or provisional pilot school certificated under the provisions of this part.

#### § 141.73 Privileges.

(a) The holder of a pilot school certificate or a provisional pilot school certificate may advertise and conduct approved pilot training courses in accordance with the certificate and any ratings that it holds.

(b) A pilot school that holds examining authority for an approved training course may recommend a graduate of that course for the issuance of an appropriate pilot, flight instructor, or ground instructor certificate and rating, without taking an FAA knowledge test or practical test, provided the training course has been approved and meets the minimum ground and flight training time requirements of this part.

#### § 141.75 Aircraft requirements.

The following items must be carried on each aircraft used for flight training and solo flights:

(a) A pretakeoff and prelanding checklist; and

(b) The operator's handbook for the aircraft, if one is furnished by the manufacturer, or copies of the handbook if

furnished to each student using the aircraft.

[Doc. No. 25910, 62 FR 40908, July 30, 1997]

#### § 141.77 Limitations.

(a) The holder of a pilot school certificate or a provisional pilot school certificate may not issue a graduation certificate to a student, or recommend a student for a pilot certificate or rating, unless the student has:

(1) Completed the training specified in the pilot school's course of training; and

(2) Passed the required final tests.

(b) Except as provided in paragraph (c) of this section, the holder of a pilot school certificate or a provisional pilot school certificate may not graduate a student from a course of training unless the student has completed all of the curriculum requirements of that course;

(c) A student may be given credit towards the curriculum requirements of a course for previous pilot experience and knowledge, provided the following conditions are met:

(1) If the credit is based upon a part 141-approved training course, the credit given that student for the previous pilot experience and knowledge may be 50 percent of the curriculum requirements and must be based upon a proficiency test or knowledge test, or both, conducted by the receiving pilot school;

(2) If the credit is not based upon a part 141-approved training course, the credit given that student for the previous pilot experience and knowledge shall not exceed more than 25 percent of the curriculum requirements and must be based upon a proficiency test or knowledge test, or both, conducted by the receiving pilot school;

(3) The receiving school determines the amount of course credit to be transferred under paragraph (c)(1) or paragraph (c)(2) of this section, based on a proficiency test or knowledge test, or both, of the student; and

(4) Credit for training specified in paragraph (c)(1) or paragraph (c)(2) of this section may be given only if the previous provider of the training has certified in writing, or other form acceptable to the Administrator as to the kind and amount of training provided,

## § 141.79

and the result of each stage check and end-of-course test, if applicable, given to the student.

[Doc. No. 25910, 62 FR 16347, Apr. 4, 1997; Amdt. 141-9, 62 FR 40908, July 30, 1997]

### § 141.79 Flight training.

(a) No person other than a certificated flight instructor or commercial pilot with a lighter-than-air rating who has the ratings and the minimum qualifications specified in the approved training course outline may give a student flight training under an approved course of training.

(b) No student pilot may be authorized to start a solo practice flight from an airport until the flight has been approved by a certificated flight instructor or commercial pilot with a lighter-than-air rating who is present at that airport.

(c) Each chief instructor and assistant chief instructor assigned to a training course must complete, at least once every 12 calendar months, an approved syllabus of training consisting of ground or flight training, or both, or an approved flight instructor refresher course.

(d) Each certificated flight instructor or commercial pilot with a lighter-than-air rating who is assigned to a flight training course must satisfactorily complete the following tasks, which must be administered by the school's chief instructor, assistant chief instructor, or check instructor:

(1) Prior to receiving authorization to train students in a flight training course, must—

(i) Accomplish a review of and receive a briefing on the objectives and standards of that training course; and

(ii) Accomplish an initial proficiency check in each make and model of aircraft used in that training course in which that person provides training; and

(2) Every 12 calendar months after the month in which the person last complied with the requirements of paragraph (d)(1)(ii) of this section, accomplish a recurrent proficiency check in one of the aircraft in which the person trains students.

[Doc. No. 25910, 62 FR 16347, Apr. 4, 1997; Amdt. 141-9, 62 FR 40908, July 30, 1997]

## 14 CFR Ch. I (1-1-08 Edition)

### § 141.81 Ground training.

(a) Except as provided in paragraph (b) of this section, each instructor who is assigned to a ground training course must hold a flight or ground instructor certificate, or a commercial pilot certificate with a lighter-than-air rating, with the appropriate rating for that course of training.

(b) A person who does not meet the requirements of paragraph (a) of this section may be assigned ground training duties in a ground training course, if:

(1) The chief instructor who is assigned to that ground training course finds the person qualified to give that training; and

(2) The training is given while under the supervision of the chief instructor or the assistant chief instructor who is present at the facility when the training is given.

(c) An instructor may not be used in a ground training course until that instructor has been briefed on the objectives and standards of that course by the chief instructor, assistant chief instructor, or check instructor.

[Doc. No. 25910, 62 FR 16347, Apr. 4, 1997; Amdt. 141-9, 62 FR 40908, July 30, 1997]

### § 141.83 Quality of training.

(a) Each pilot school or provisional pilot school must meet the following requirements:

(1) Comply with its approved training course; and

(2) Provide training of such quality that meets the requirements of § 141.5(d) of this part.

(b) The failure of a pilot school or provisional pilot school to maintain the quality of training specified in paragraph (a) of this section may be the basis for suspending or revoking that school's certificate.

(c) When requested by the Administrator, a pilot school or provisional pilot school must allow the FAA to administer any knowledge test, practical test, stage check, or end-of-course test to its students.

(d) When a stage check or end-of-course test is administered by the FAA under the provisions of paragraph (c) of this section, and the student has not completed the training course, then

**Federal Aviation Administration, DOT**

**§ 141.89**

that test will be based on the standards prescribed in the school's approved training course.

(e) When a practical test or knowledge test is administered by the FAA under the provisions of paragraph (c) of this section, to a student who has completed the school's training course, that test will be based upon the areas of operation approved by the Administrator.

[Doc. No. 25910, 62 FR 16347, Apr. 4, 1997; Amdt. 141-9, 62 FR 40908, July 30, 1997]

**§ 141.85 Chief instructor responsibilities.**

(a) Each person designated as a chief instructor for a pilot school or provisional pilot school shall be responsible for:

(1) Certifying each student's training record, graduation certificate, stage check and end-of-course test report, recommendation for course completion, and application;

(2) Ensuring that each certificated flight instructor, certificated ground instructor, or commercial pilot with a lighter-than-air rating passes an initial proficiency check prior to that instructor being assigned instructing duties in the school's approved training course, and thereafter that the instructor passes a recurrent proficiency check every 12 calendar months after the month in which the initial test was accomplished;

(3) Ensuring that each student accomplishes the required stage checks and end-of-course tests in accordance with the school's approved training course; and

(4) Maintaining training techniques, procedures, and standards for the school that are acceptable to the Administrator.

(b) The chief instructor or an assistant chief instructor must be available at the pilot school or, if away from the pilot school, be available by telephone, radio, or other electronic means during the time that training is given for an approved training course.

(c) The chief instructor may delegate authority for conducting stage checks, end-of-course tests, and flight instruc-

tor proficiency checks to the assistant chief instructor or a check instructor.

[Doc. No. 25910, 62 FR 16347, Apr. 4, 1997; Amdt. 141-9, 62 FR 40908, July 30, 1997]

**§ 141.87 Change of chief instructor.**

Whenever a pilot school or provisional pilot school makes a change of designation of its chief instructor, that school:

(a) Must immediately provide the FAA Flight Standards District Office that has jurisdiction over the area in which the school is located with written notification of the change;

(b) May conduct training without a chief instructor for that training course for a period not to exceed 60 days while awaiting the designation and approval of another chief instructor;

(c) May, for a period not to exceed 60 days, have the stage checks and end-of-course tests administered by:

(1) The training course's assistant chief instructor, if one has been designated;

(2) The training course's check instructor, if one has been designated;

(3) An FAA inspector; or

(4) An examiner.

(d) Must, after 60 days without a chief instructor, cease operations and surrender its certificate to the Administrator; and

(e) May have its certificate reinstated, upon:

(1) Designating and approving another chief instructor;

(2) Showing it meets the requirements of § 141.27(a)(2) of this part; and

(3) Applying for reinstatement on a form and in a manner prescribed by the Administrator.

**§ 141.89 Maintenance of personnel, facilities, and equipment.**

The holder of a pilot school certificate or provisional pilot school certificate may not provide training to a student who is enrolled in an approved course of training unless:

(a) Each airport, aircraft, and facility necessary for that training meets the standards specified in the holder's approved training course outline and the appropriate requirements of this part; and

**§ 141.91**

(b) Except as provided in §141.87 of this part, each chief instructor, assistant chief instructor, check instructor, or instructor meets the qualifications specified in the holder's approved course of training and the appropriate requirements of this part.

**§ 141.91 Satellite bases.**

The holder of a pilot school certificate or provisional pilot school certificate may conduct ground training or flight training in an approved course of training at a base other than its main operations base if:

(a) An assistant chief instructor is designated for each satellite base, and that assistant chief instructor is available at that base or, if away from the premises, by telephone, radio, or other electronic means during the time that training is provided for an approved training course;

(b) The airport, facilities, and personnel used at the satellite base meet the appropriate requirements of subpart B of this part and its approved training course outline;

(c) The instructors are under the direct supervision of the chief instructor or assistant chief instructor for the appropriate training course, who is readily available for consultation in accordance with §141.85(b) of this part; and

(d) The FAA Flight Standards District Office having jurisdiction over the area in which the school is located is notified in writing if training is conducted at a base other than the school's main operations base for more than 7 consecutive days.

[Doc. No. 25910, 62 FR. 16347, Apr. 4, 1997; Amdt. 141-9, 62 FR 40908, July 30, 1997]

**§ 141.93 Enrollment.**

(a) The holder of a pilot school certificate or a provisional pilot school certificate must, at the time a student is enrolled in an approved training course, furnish that student with a copy of the following:

(1) A certificate of enrollment containing—

(i) The name of the course in which the student is enrolled; and

(ii) The date of that enrollment.

(2) A copy of the student's training syllabus.

**14 CFR Ch. I (1-1-08 Edition)**

(3) A copy of the safety procedures and practices developed by the school that describe the use of the school's facilities and the operation of its aircraft. Those procedures and practices shall include training on at least the following information—

(i) The weather minimums required by the school for dual and solo flights;

(ii) The procedures for starting and taxiing aircraft on the ramp;

(iii) Fire precautions and procedures;

(iv) Redispach procedures after unprogrammed landings, on and off airports;

(v) Aircraft discrepancies and approval for return-to-service determinations;

(vi) Securing of aircraft when not in use;

(vii) Fuel reserves necessary for local and cross-country flights;

(viii) Avoidance of other aircraft in flight and on the ground;

(ix) Minimum altitude limitations and simulated emergency landing instructions; and

(x) A description of and instructions regarding the use of assigned practice areas.

(b) The holder of a pilot school certificate or provisional pilot school certificate must maintain a monthly listing of persons enrolled in each training course offered by the school.

[Doc. No. 25910, 62 FR 16347, Apr. 4, 1997; Amdt. 141-9, 62 FR 40908, July 30, 1997]

**§ 141.95 Graduation certificate.**

(a) The holder of a pilot school certificate or provisional pilot school certificate must issue a graduation certificate to each student who completes its approved course of training.

(b) The graduation certificate must be issued to the student upon completion of the course of training and contain at least the following information:

(1) The name of the school and the certificate number of the school;

(2) The name of the graduate to whom it was issued;

(3) The course of training for which it was issued;

(4) The date of graduation;

(5) A statement that the student has satisfactorily completed each required stage of the approved course of training including the tests for those stages;

(6) A certification of the information contained on the graduation certificate by the chief instructor for that course of training; and

(7) A statement showing the cross-country training that the student received in the course of training.

[Doc. No. 25910, 62 FR 16347, Apr. 4, 1997; Amdt. 141-9, 62 FR 40908, July 30, 1997]

### Subpart F—Records

#### § 141.101 Training records.

(a) Each holder of a pilot school certificate or provisional pilot school certificate must establish and maintain a current and accurate record of the participation of each student enrolled in an approved course of training conducted by the school that includes the following information:

(1) The date the student was enrolled in the approved course;

(2) A chronological log of the student's course attendance, subjects, and flight operations covered in the student's training, and the names and grades of any tests taken by the student; and

(3) The date the student graduated, terminated training, or transferred to another school.

(b) The records required to be maintained in a student's logbook will not suffice for the record required by paragraph (a) of this section.

(c) Whenever a student graduates, terminates training, or transfers to another school, the student's record must be certified to that effect by the chief instructor.

(d) The holder of a pilot school certificate or a provisional pilot school certificate must retain each student record required by this section for at least 1 year from the date that the student:

(1) Graduates from the course to which the record pertains;

(2) Terminates enrollment in the course to which the record pertains; or

(3) Transfers to another school.

(e) The holder of a pilot school certificate or a provisional pilot school certificate must make a copy of the

student's training record available upon request by the student.

[Doc. No. 25910, 62 FR 16347, Apr. 4, 1997; Amdt. 141-9, 62 FR 40908, July 30, 1997]

#### APPENDIX A TO PART 141—RECREATIONAL PILOT CERTIFICATION COURSE

1. *Applicability.* This appendix prescribes the minimum curriculum required for a recreational pilot certification course under this part, for the following ratings:

(a) Airplane single-engine.

(b) Rotorcraft helicopter.

(c) Rotorcraft gyroplane.

2. *Eligibility for enrollment.* A person must hold a student pilot certificate prior to enrolling in the flight portion of the recreational pilot certification course.

3. *Aeronautical knowledge training.* Each approved course must include at least 20 hours of ground training on the following aeronautical knowledge areas, appropriate to the aircraft category and class for which the course applies:

(a) Applicable Federal Aviation Regulations for recreational pilot privileges, limitations, and flight operations;

(b) Accident reporting requirements of the National Transportation Safety Board;

(c) Applicable subjects in the "Aeronautical Information Manual" and the appropriate FAA advisory circulars;

(d) Use of aeronautical charts for VFR navigation using pilotage with the aid of a magnetic compass;

(e) Recognition of critical weather situations from the ground and in flight, windshear avoidance, and the procurement and use of aeronautical weather reports and forecasts;

(f) Safe and efficient operation of aircraft, including collision avoidance, and recognition and avoidance of wake turbulence;

(g) Effects of density altitude on takeoff and climb performance;

(h) Weight and balance computations;

(i) Principles of aerodynamics, powerplants, and aircraft systems;

(j) Stall awareness, spin entry, spins, and spin recovery techniques, if applying for an airplane single-engine rating;

(k) Aeronautical decision making and judgment; and

(1) Preflight action that includes—

(1) How to obtain information on runway lengths at airports of intended use, data on takeoff and landing distances, weather reports and forecasts, and fuel requirements; and

(2) How to plan for alternatives if the planned flight cannot be completed or delays are encountered.

4. *Flight training.* (a) Each approved course must include at least 30 hours of flight training (of which 15 hours must be with a certificated flight instructor and 3 hours must be solo flight training as provided in section No. 5 of this appendix) on the approved areas of operation listed in paragraph (c) of this section that are appropriate to the aircraft category and class rating for which the course applies, including:

(1) Except as provided in §61.100 of this chapter, 2 hours of dual flight training to and at an airport that is located more than 25 nautical miles from the airport where the applicant normally trains, with at least three takeoffs and three landings; and

(2) 3 hours of dual flight training in an aircraft that is appropriate to the aircraft category and class for which the course applies, in preparation for the practical test within 60 days preceding the date of the test.

(b) Each training flight must include a pre-flight briefing and a postflight critique of the student by the flight instructor assigned to that flight.

(c) Flight training must include the following approved areas of operation appropriate to the aircraft category and class rating—

(1) *For an airplane single-engine course:* (i) Preflight preparation;  
 (ii) Preflight procedures;  
 (iii) Airport operations;  
 (iv) Takeoffs, landings, and go-arounds;  
 (v) Performance maneuvers;  
 (vi) Ground reference maneuvers;  
 (vii) Navigation;  
 (viii) Slow flight and stalls;  
 (ix) Emergency operations; and  
 (x) Postflight procedures.

(2) *For a rotorcraft helicopter course:* (i) Preflight preparation;  
 (ii) Preflight procedures;  
 (iii) Airport and heliport operations;  
 (iv) Hovering maneuvers;  
 (v) Takeoffs, landings, and go-arounds;  
 (vi) Performance maneuvers;  
 (vii) Navigation;  
 (viii) Emergency operations; and  
 (ix) Postflight procedures.

(3) *For a rotorcraft gyroplane course:* (i) Preflight preparation;  
 (ii) Preflight procedures;  
 (iii) Airport operations;  
 (iv) Takeoffs, landings, and go-arounds;  
 (v) Performance maneuvers;  
 (vi) Ground reference maneuvers;  
 (vii) Navigation;  
 (viii) Flight at slow airspeeds;  
 (ix) Emergency operations; and  
 (x) Postflight procedures.

5. *Solo flight training.* Each approved course must include at least 3 hours of solo flight training on the approved areas of operation listed in paragraph (c) of section No. 4 of this appendix that are appropriate to the aircraft

category and class rating for which the course applies.

6. *Stage checks and end-of-course tests.* (a) Each student enrolled in a recreational pilot course must satisfactorily accomplish the stage checks and end-of-course tests, in accordance with the school's approved training course, consisting of the approved areas of operation listed in paragraph (c) of section No. 4 of this appendix that are appropriate to the aircraft category and class rating for which the course applies.

(b) Each student must demonstrate satisfactory proficiency prior to receiving an endorsement to operate an aircraft in solo flight.

[Doc. No. 25910, 62 FR 16347, Apr. 4, 1997; Amdt. 141–9, 62 FR 40908, July 30, 1997]

#### APPENDIX B TO PART 141—PRIVATE PILOT CERTIFICATION COURSE

1. *Applicability.* This appendix prescribes the minimum curriculum for a private pilot certification course required under this part, for the following ratings:

- (a) Airplane single-engine.
- (b) Airplane multiengine.
- (c) Rotorcraft helicopter.
- (d) Rotorcraft gyroplane.
- (e) Powered-lift.
- (f) Glider.
- (g) Lighter-than-air airship.
- (h) Lighter-than-air balloon.

2. *Eligibility for enrollment.* A person must hold a recreational or student pilot certificate prior to enrolling in the flight portion of the private pilot certification course.

3. *Aeronautical knowledge training.*

(a) Each approved course must include at least the following ground training on the aeronautical knowledge areas listed in paragraph (b) of this section, appropriate to the aircraft category and class rating:

(1) 35 hours of training if the course is for an airplane, rotorcraft, or powered-lift category rating.

(2) 15 hours of training if the course is for a glider category rating.

(3) 10 hours of training if the course is for a lighter-than-air category with a balloon class rating.

(4) 35 hours of training if the course is for a lighter-than-air category with an airship class rating.

(b) Ground training must include the following aeronautical knowledge areas:

(1) Applicable Federal Aviation Regulations for private pilot privileges, limitations, and flight operations;

(2) Accident reporting requirements of the National Transportation Safety Board;

(3) Applicable subjects of the "Aeronautical Information Manual" and the appropriate FAA advisory circulars;

(4) Aeronautical charts for VFR navigation using pilotage, dead reckoning, and navigation systems;

(5) Radio communication procedures;

(6) Recognition of critical weather situations from the ground and in flight, windshear avoidance, and the procurement and use of aeronautical weather reports and forecasts;

(7) Safe and efficient operation of aircraft, including collision avoidance, and recognition and avoidance of wake turbulence;

(8) Effects of density altitude on takeoff and climb performance;

(9) Weight and balance computations;

(10) Principles of aerodynamics, powerplants, and aircraft systems;

(11) If the course of training is for an airplane category or glider category rating, stall awareness, spin entry, spins, and spin recovery techniques;

(12) Aeronautical decision making and judgment; and

(13) Preflight action that includes—

(i) How to obtain information on runway lengths at airports of intended use, data on takeoff and landing distances, weather reports and forecasts, and fuel requirements; and

(ii) How to plan for alternatives if the planned flight cannot be completed or delays are encountered.

4. *Flight training.* (a) Each approved course must include at least the following flight training, as provided in this section and section No. 5 of this appendix, on the approved areas of operation listed in paragraph (d) of this section, appropriate to the aircraft category and class rating:

(1) 35 hours of training if the course is for an airplane, rotorcraft, powered-lift, or airship rating.

(2) 6 hours of training if the course is for a glider rating.

(3) 8 hours of training if the course is for a balloon rating.

(b) Each approved course must include at least the following flight training:

(1) *For an airplane single-engine course:* 20 hours of flight training from a certificated flight instructor on the approved areas of operation in paragraph (d)(1) of this section that includes at least—

(i) Except as provided in §61.111 of this chapter, 3 hours of cross-country flight training in a single-engine airplane;

(ii) 3 hours of night flight training in a single-engine airplane that includes—

(A) One cross-country flight of more than 100-nautical-miles total distance; and

(B) 10 takeoffs and 10 landings to a full stop (with each landing involving a flight in the traffic pattern) at an airport.

(iii) 3 hours of instrument training in a single-engine airplane; and

(iv) 3 hours of flight training in a single-engine airplane in preparation for the practical test within 60 days preceding the date of the test.

(2) *For an airplane multiengine course:* 20 hours of flight training from a certificated flight instructor on the approved areas of operation in paragraph (d)(2) of this section that includes at least—

(i) Except as provided in §61.111 of this chapter, 3 hours of cross-country flight training in a multiengine airplane;

(ii) 3 hours of night flight training in a multiengine airplane that includes—

(A) One cross-country flight of more than 100-nautical-miles total distance; and

(B) 10 takeoffs and 10 landings to a full stop (with each landing involving a flight in the traffic pattern) at an airport.

(iii) 3 hours of instrument training in a multiengine airplane; and

(iv) 3 hours of flight training in a multiengine airplane in preparation for the practical test within 60 days preceding the date of the test.

(3) *For a rotorcraft helicopter course:* 20 hours of flight training from a certificated flight instructor on the approved areas of operation in paragraph (d)(3) of this section that includes at least—

(i) Except as provided in §61.111 of this chapter, 3 hours of cross-country flight training in a helicopter.

(ii) 3 hours of night flight training in a helicopter that includes—

(A) One cross-country flight of more than 50-nautical-miles total distance; and

(B) 10 takeoffs and 10 landings to a full stop (with each landing involving a flight in the traffic pattern) at an airport.

(iii) 3 hours of flight training in a helicopter in preparation for the practical test within 60 days preceding the date of the test.

(4) *For a rotorcraft gyroplane course:* 20 hours of flight training from a certificated flight instructor on the approved areas of operation in paragraph (d)(4) of this section that includes at least—

(i) Except as provided in §61.111 of this chapter, 3 hours of cross-country flight training in a gyroplane.

(ii) 3 hours of night flight training in a gyroplane that includes—

(A) One cross-country flight over 50-nautical-miles total distance; and

(B) 10 takeoffs and 10 landings to a full stop (with each landing involving a flight in the traffic pattern) at an airport.

(iii) 3 hours of flight training in a gyroplane in preparation for the practical test within 60 days preceding the date of the test.

(5) *For a powered-lift course:* 20 hours of flight training from a certificated flight instructor on the approved areas of operation in paragraph (d)(5) of this section that includes at least—

(i) Except as provided in §61.111 of this chapter, 3 hours of cross-country flight training in a powered-lift;

(ii) 3 hours of night flight training in a powered-lift that includes—

(A) One cross-country flight of more than 100-nautical-miles total distance; and

(B) 10 takeoffs and 10 landings to a full stop (with each landing involving a flight in the traffic pattern) at an airport.

(iii) 3 hours of instrument training in a powered-lift; and

(iv) 3 hours of flight training in a powered-lift in preparation for the practical test, within 60 days preceding the date of the test.

(6) *For a glider course:* 4 hours of flight training from a certificated flight instructor on the approved areas of operation in paragraph (d)(6) of this section that includes at least—

(i) Five training flights in a glider with a certificated flight instructor on the launch/tow procedures approved for the course and on the appropriate approved areas of operation listed in paragraph (d)(6) of this section; and

(ii) Three training flights in a glider with a certificated flight instructor in preparation for the practical test within 60 days preceding the date of the test.

(7) *For a lighter-than-air airship course:* 20 hours of flight training from a commercial pilot with an airship rating on the approved areas of operation in paragraph (d)(7) of this section that includes at least—

(i) Except as provided in §61.111 of this chapter, 3 hours of cross-country flight training in an airship;

(ii) 3 hours of night flight training in an airship that includes—

(A) One cross-country flight over 25-nautical-miles total distance; and

(B) Five takeoffs and five landings to a full stop (with each landing involving a flight in the traffic pattern) at an airport.

(iii) 3 hours of instrument training in an airship; and

(iv) 3 hours of flight training in an airship in preparation for the practical test within 60 days preceding the date of the test.

(8) *For a lighter-than-air balloon course:* 8 hours of flight training, including at least five training flights, from a commercial pilot with a balloon rating on the approved areas of operation in paragraph (d)(8) of this section, that includes—

(i) If the training is being performed in a gas balloon—

(A) Two flights of 1 hour each;

(B) One flight involving a controlled ascent to 3,000 feet above the launch site; and

(C) Two flights in preparation for the practical test within 60 days preceding the date of the test.

(ii) If the training is being performed in a balloon with an airborne heater—

(A) Two flights of 30 minutes each;

(B) One flight involving a controlled ascent to 2,000 feet above the launch site; and

(C) Two flights in preparation for the practical test within 60 days preceding the date of the test.

(c) For use of flight simulators or flight training devices:

(1) The course may include training in a flight simulator or flight training device, provided it is representative of the aircraft for which the course is approved, meets the requirements of this paragraph, and the training is given by an authorized instructor.

(2) Training in a flight simulator that meets the requirements of §141.41(a) of this part may be credited for a maximum of 20 percent of the total flight training hour requirements of the approved course, or of this section, whichever is less.

(3) Training in a flight training device that meets the requirements of §141.41(b) of this part may be credited for a maximum of 15 percent of the total flight training hour requirements of the approved course, or of this section, whichever is less.

(4) Training in flight simulators or flight training devices described in paragraphs (c)(2) and (c)(3) of this section, if used in combination, may be credited for a maximum of 20 percent of the total flight training hour requirements of the approved course, or of this section, whichever is less. However, credit for training in a flight training device that meets the requirements of §141.41(b) cannot exceed the limitation provided for in paragraph (c)(3) of this section.

(d) Each approved course must include the flight training on the approved areas of operation listed in this paragraph that are appropriate to the aircraft category and class rating—

(1) *For a single-engine airplane course:* (i) Preflight preparation;

(ii) Preflight procedures;

(iii) Airport and seaplane base operations;

(iv) Takeoffs, landings, and go-arounds;

(v) Performance maneuvers;

(vi) Ground reference maneuvers;

(vii) Navigation;

(viii) Slow flight and stalls;

(ix) Basic instrument maneuvers;

(x) Emergency operations;

(xi) Night operations, and

(xii) Postflight procedures.

(2) *For a multiengine airplane course:* (i) Preflight preparation;

(ii) Preflight procedures;

(iii) Airport and seaplane base operations;

(iv) Takeoffs, landings, and go-arounds;

(v) Performance maneuvers;

(vi) Ground reference maneuvers;

(vii) Navigation;

(viii) Slow flight and stalls;

(ix) Basic instrument maneuvers;

(x) Emergency operations;

(xi) Multiengine operations;

(xii) Night operations; and

(xiii) Postflight procedures.

- (3) *For a rotorcraft helicopter course:* (i) Preflight preparation;
- (ii) Preflight procedures;
  - (iii) Airport and heliport operations;
  - (iv) Hovering maneuvers;
  - (v) Takeoffs, landings, and go-arounds;
  - (vi) Performance maneuvers;
  - (vii) Navigation;
  - (viii) Emergency operations;
  - (ix) Night operations; and
  - (x) Postflight procedures.
- (4) *For a rotorcraft gyroplane course:*
- (i) Preflight preparation;
  - (ii) Preflight procedures;
  - (iii) Airport operations;
  - (iv) Takeoffs, landings, and go-arounds;
  - (v) Performance maneuvers;
  - (vi) Ground reference maneuvers;
  - (vii) Navigation;
  - (viii) Flight at slow airspeeds;
  - (ix) Emergency operations;
  - (x) Night operations; and
  - (xi) Postflight procedures.
- (5) *For a powered-lift course:* (i) Preflight preparation;
- (ii) Preflight procedures;
  - (iii) Airport and heliport operations;
  - (iv) Hovering maneuvers;
  - (v) Takeoffs, landings, and go-arounds;
  - (vi) Performance maneuvers;
  - (vii) Ground reference maneuvers;
  - (viii) Navigation;
  - (ix) Slow flight and stalls;
  - (x) Basic instrument maneuvers;
  - (xi) Emergency operations;
  - (xii) Night operations; and
  - (xiii) Postflight procedures.
- (6) *For a glider course:* (i) Preflight preparation;
- (ii) Preflight procedures;
  - (iii) Airport and gliderport operations;
  - (iv) Launches/tows, as appropriate, and landings;
  - (v) Performance speeds;
  - (vi) Soaring techniques;
  - (vii) Performance maneuvers;
  - (viii) Navigation;
  - (ix) Slow flight and stalls;
  - (x) Emergency operations; and
  - (xi) Postflight procedures.
- (7) *For a lighter-than-air airship course:* (i) Preflight preparation;
- (ii) Preflight procedures;
  - (iii) Airport operations;
  - (iv) Takeoffs, landings, and go-arounds;
  - (v) Performance maneuvers;
  - (vi) Ground reference maneuvers;
  - (vii) Navigation;
  - (viii) Emergency operations; and
  - (ix) Postflight procedures.
- (8) *For a lighter-than-air balloon course:* (i) Preflight preparation;
- (ii) Preflight procedures;
  - (iii) Airport operations;
  - (iv) Launches and landings;
  - (v) Performance maneuvers;
  - (vi) Navigation;

- (vii) Emergency operations; and
- (viii) Postflight procedures.

5. *Solo flight training.* Each approved course must include at least the following solo flight training:

(a) *For an airplane single-engine course:* 5 hours of solo flight training in a single-engine airplane on the approved areas of operation in paragraph (d)(1) of section No. 4 of this appendix that includes at least—

(1) One solo cross-country flight of at least 100 nautical miles with landings at a minimum of three points, and one segment of the flight consisting of a straight-line distance of at least 50 nautical miles between the takeoff and landing locations; and

(2) Three takeoffs and three landings to a full stop (with each landing involving a flight in the traffic pattern) at an airport with an operating control tower.

(b) *For an airplane multiengine course:* 5 hours of flight training in a multiengine airplane performing the duties of a pilot in command while under the supervision of a certificated flight instructor. The training must consist of the approved areas of operation in paragraph (d)(2) of section No. 4 of this appendix, and include at least—

(1) One cross-country flight of at least 100 nautical miles with landings at a minimum of three points, and one segment of the flight consisting of a straight-line distance of at least 50 nautical miles between the takeoff and landing locations; and

(2) Three takeoffs and three landings to a full stop (with each landing involving a flight in the traffic pattern) at an airport with an operating control tower.

(c) *For a rotorcraft helicopter course:* 5 hours of solo flight training in a helicopter on the approved areas of operation in paragraph (d)(3) of section No. 4 of this appendix that includes at least—

(1) One solo cross-country flight of more than 50 nautical miles with landings at a minimum of three points, and one segment of the flight consisting of a straight-line distance of at least 25 nautical miles between the takeoff and landing locations; and

(2) Three takeoffs and three landings to a full stop (with each landing involving a flight in the traffic pattern) at an airport with an operating control tower.

(d) *For a rotorcraft gyroplane course:* 5 hours of solo flight training in gyroplanes on the approved areas of operation in paragraph (d)(4) of section No. 4 of this appendix that includes at least—

(1) One solo cross-country flight of more than 50 nautical miles with landings at a minimum of three points, and one segment of the flight consisting of a straight-line distance of at least 25 nautical miles between the takeoff and landing locations; and

(2) Three takeoffs and three landings to a full stop (with each landing involving a

flight in the traffic pattern) at an airport with an operating control tower.

(e) *For a powered-lift course:* 5 hours of solo flight training in a powered-lift on the approved areas of operation in paragraph (d)(5) of section No. 4 of this appendix that includes at least—

(1) One solo cross-country flight of at least 100 nautical miles with landings at a minimum of three points, and one segment of the flight consisting of a straight-line distance of at least 50 nautical miles between the takeoff and landing locations; and

(2) Three takeoffs and three landings to a full stop (with each landing involving a flight in the traffic pattern) at an airport with an operating control tower.

(f) *For a glider course:* Two solo flights in a glider on the approved areas of operation in paragraph (d)(6) of section No. 4 of this appendix, and the launch and tow procedures appropriate for the approved course.

(g) *For a lighter-than-air airship course:* 5 hours of flight training in an airship performing the duties of pilot in command while under the supervision of a commercial pilot with an airship rating. The training must consist of the approved areas of operation in paragraph (d)(7) of section No. 4 of this appendix.

(h) *For a lighter-than-air balloon course:* Two solo flights in a balloon with an airborne heater if the course involves a balloon with an airborne heater or, if the course involves a gas balloon, at least two flights in a gas balloon performing the duties of pilot in command while under the supervision of a commercial pilot with a balloon rating. The training must consist of the approved areas of operation in paragraph (d)(8) of section No. 4 of this appendix, in the kind of balloon for which the course applies.

#### 6. *Stage checks and end-of-course tests.*

(a) Each student enrolled in a private pilot course must satisfactorily accomplish the stage checks and end-of-course tests in accordance with the school's approved training course, consisting of the approved areas of operation listed in paragraph (d) of section No. 4 of this appendix that are appropriate to the aircraft category and class rating for which the course applies.

(b) Each student must demonstrate satisfactory proficiency prior to receiving an endorsement to operate an aircraft in solo flight.

[Doc. No. 25910, 62 FR 16347, Apr. 4, 1997; Amdt. 141–9, 62 FR 40908, July 30, 1997; as amended by Amdt. 141–10, 63 FR 20289, Apr. 23, 1998]

### APPENDIX C TO PART 141—INSTRUMENT RATING COURSE

1. *Applicability.* This appendix prescribes the minimum curriculum for an instrument

rating course and an additional instrument rating course, required under this part, for the following ratings:

- (a) Instrument—airplane.
- (b) Instrument—helicopter.
- (c) Instrument—powered-lift.

2. *Eligibility for enrollment.* A person must hold at least a private pilot certificate with an aircraft category and class rating appropriate to the instrument rating for which the course applies prior to enrolling in the flight portion of the instrument rating course.

3. *Aeronautical knowledge training.* (a) Each approved course must include at least the following ground training on the aeronautical knowledge areas listed in paragraph (b) of this section appropriate to the instrument rating for which the course applies:

(1) 30 hours of training if the course is for an initial instrument rating.

(2) 20 hours of training if the course is for an additional instrument rating.

(b) Ground training must include the following aeronautical knowledge areas:

(1) Applicable Federal Aviation Regulations for IFR flight operations;

(2) Appropriate information in the "Aeronautical Information Manual";

(3) Air traffic control system and procedures for instrument flight operations;

(4) IFR navigation and approaches by use of navigation systems;

(5) Use of IFR en route and instrument approach procedure charts;

(6) Procurement and use of aviation weather reports and forecasts, and the elements of forecasting weather trends on the basis of that information and personal observation of weather conditions;

(7) Safe and efficient operation of aircraft under instrument flight rules and conditions;

(8) Recognition of critical weather situations and windshear avoidance;

(9) Aeronautical decision making and judgment; and

(10) Crew resource management, to include crew communication and coordination.

4. *Flight training.* (a) Each approved course must include at least the following flight training on the approved areas of operation listed in paragraph (d) of this section, appropriate to the instrument-aircraft category and class rating for which the course applies:

(1) 35 hours of instrument training if the course is for an initial instrument rating.

(2) 15 hours of instrument training if the course is for an additional instrument rating.

(b) For the use of flight simulators or flight training devices—

(1) The course may include training in a flight simulator or flight training device, provided it is representative of the aircraft for which the course is approved, meets the requirements of this paragraph, and the training is given by an authorized instructor.

(2) Training in a flight simulator that meets the requirements of §141.41(a) of this part may be credited for a maximum of 50 percent of the total flight training hour requirements of the approved course, or of this section, whichever is less.

(3) Training in a flight training device that meets the requirements of §141.41(b) of this part may be credited for a maximum of 40 percent of the total flight training hour requirements of the approved course, or of this section, whichever is less.

(4) Training in flight simulators or flight training devices described in paragraphs (b)(2) and (b)(3) of this section, if used in combination, may be credited for a maximum of 50 percent of the total flight training hour requirements of the approved course, or of this section, whichever is less. However, credit for training in a flight training device that meets the requirements of §141.41(b) cannot exceed the limitation provided for in paragraph (b)(3) of this section.

(c) Each approved course must include the following flight training—

(1) *For an instrument airplane course:* Instrument training time from a certificated flight instructor with an instrument rating on the approved areas of operation in paragraph (d) of this section including at least one cross-country flight that—

(i) Is in the category and class of airplane that the course is approved for, and is performed under IFR;

(ii) Is a distance of at least 250 nautical miles along airways or ATC-directed routing with one segment of the flight consisting of at least a straight-line distance of 100 nautical miles between airports;

(iii) Involves an instrument approach at each airport; and

(iv) Involves three different kinds of approaches with the use of navigation systems.

(2) *For an instrument helicopter course:* Instrument training time from a certificated flight instructor with an instrument rating on the approved areas of operation in paragraph (d) of this section including at least one cross-country flight that—

(i) Is in a helicopter and is performed under IFR;

(ii) Is a distance of at least 100 nautical miles along airways or ATC-directed routing with one segment of the flight consisting of at least a straight-line distance of 50 nautical miles between airports;

(iii) Involves an instrument approach at each airport; and

(iv) Involves three different kinds of approaches with the use of navigation systems.

(3) *For an instrument powered-lift course:* Instrument training time from a certificated flight instructor with an instrument rating on the approved areas of operation in paragraph (d) of this section including at least one cross-country flight that—

(i) Is in a powered-lift and is performed under IFR;

(ii) Is a distance of at least 250 nautical miles along airways or ATC-directed routing with one segment of the flight consisting of at least a straight-line distance of 100 nautical miles between airports;

(iii) Involves an instrument approach at each airport; and

(iv) Involves three different kinds of approaches with the use of navigation systems.

(d) Each approved course must include the flight training on the approved areas of operation listed in this paragraph appropriate to the instrument aircraft category and class rating for which the course applies:

(1) Preflight preparation;

(2) Preflight procedures;

(3) Air traffic control clearances and procedures;

(4) Flight by reference to instruments;

(5) Navigation systems;

(6) Instrument approach procedures;

(7) Emergency operations; and

(8) Postflight procedures.

5. *Stage checks and end-of-course tests.* Each student enrolled in an instrument rating course must satisfactorily accomplish the stage checks and end-of-course tests, in accordance with the school's approved training course, consisting of the approved areas of operation listed in paragraph (d) of section No. 4 of this appendix that are appropriate to the aircraft category and class rating for which the course applies.

[Doc. No. 25910, 62 FR 16347, Apr. 4, 1997; Amdt. 141-9, 62 FR 40909, July 30, 1997]

#### APPENDIX D TO PART 141—COMMERCIAL PILOT CERTIFICATION COURSE

1. *Applicability.* This appendix prescribes the minimum curriculum for a commercial pilot certification course required under this part, for the following ratings:

(a) Airplane single-engine.

(b) Airplane multiengine.

(c) Rotorcraft helicopter.

(d) Rotorcraft gyroplane.

(e) Powered-lift.

(f) Glider.

(g) Lighter-than-air airship.

(h) Lighter-than-air balloon.

2. *Eligibility for enrollment.* A person must hold the following prior to enrolling in the flight portion of the commercial pilot certification course:

(a) At least a private pilot certificate; and

(b) If the course is for a rating in an airplane or a powered-lift category, then the person must:

(1) Hold an instrument rating in the aircraft that is appropriate to the aircraft category rating for which the course applies; or

(2) Be concurrently enrolled in an instrument rating course that is appropriate to the

aircraft category rating for which the course applies, and pass the required instrument rating practical test prior to completing the commercial pilot certification course.

3. *Aeronautical knowledge training.* (a) Each approved course must include at least the following ground training on the aeronautical knowledge areas listed in paragraph (b) of this section, appropriate to the aircraft category and class rating for which the course applies:

(1) 35 hours of training if the course is for an airplane category rating or a powered-lift category rating.

(2) 65 hours of training if the course is for a lighter-than-air category with an airship class rating.

(3) 30 hours of training if the course is for a rotocraft category rating.

(4) 20 hours of training if the course is for a glider category rating.

(5) 20 hours of training if the course is for lighter-than-air category with a balloon class rating.

(b) Ground training must include the following aeronautical knowledge areas:

(1) Federal Aviation Regulations that apply to commercial pilot privileges, limitations, and flight operations;

(2) Accident reporting requirements of the National Transportation Safety Board;

(3) Basic aerodynamics and the principles of flight;

(4) Meteorology, to include recognition of critical weather situations, windshear recognition and avoidance, and the use of aeronautical weather reports and forecasts;

(5) Safe and efficient operation of aircraft;

(6) Weight and balance computations;

(7) Use of performance charts;

(8) Significance and effects of exceeding aircraft performance limitations;

(9) Use of aeronautical charts and a magnetic compass for pilotage and dead reckoning;

(10) Use of air navigation facilities;

(11) Aeronautical decision making and judgment;

(12) Principles and functions of aircraft systems;

(13) Maneuvers, procedures, and emergency operations appropriate to the aircraft;

(14) Night and high-altitude operations;

(15) Descriptions of and procedures for operating within the National Airspace System; and

(16) Procedures for flight and ground training for lighter-than-air ratings.

4. *Flight training.* (a) Each approved course must include at least the following flight training, as provided in this section and section No. 5 of this appendix, on the approved areas of operation listed in paragraph (d) of this section that are appropriate to the aircraft category and class rating for which the course applies:

(1) 120 hours of training if the course is for an airplane or powered-lift rating.

(2) 155 hours of training if the course is for an airship rating.

(3) 115 hours of training if the course is for a rotocraft rating.

(4) 6 hours of training if the course is for a glider rating.

(5) 10 hours of training and 8 training flights if the course is for a balloon rating.

(b) Each approved course must include at least the following flight training:

(1) *For an airplane single-engine course:* 55 hours of flight training from a certificated flight instructor on the approved areas of operation listed in paragraph (d)(1) of this section that includes at least—

(i) 5 hours of instrument training in a single-engine airplane;

(ii) 10 hours of training in a single-engine airplane that has retractable landing gear, flaps, and a controllable pitch propeller, or is turbine-powered;

(iii) One cross-country flight in a single-engine airplane of at least a 2-hour duration, a total straight-line distance of more than 100 nautical miles from the original point of departure, and occurring in day VFR conditions;

(iv) One cross-country flight in a single-engine airplane of at least a 2-hour duration, a total straight-line distance of more than 100 nautical miles from the original point of departure, and occurring in night VFR conditions; and

(v) 3 hours in a single-engine airplane in preparation for the practical test within 60 days preceding the date of the test.

(2) *For an airplane multiengine course:* 55 hours of flight training from a certificated flight instructor on the approved areas of operation listed in paragraph (d)(2) of this section that includes at least—

(i) 5 hours of instrument training in a multiengine airplane;

(ii) 10 hours of training in a multiengine airplane that has retractable landing gear, flaps, and a controllable pitch propeller, or is turbine-powered;

(iii) One cross-country flight in a multiengine airplane of at least a 2-hour duration, a total straight-line distance of more than 100 nautical miles from the original point of departure, and occurring in day VFR conditions;

(iv) One cross-country flight in a multiengine airplane of at least a 2-hour duration, a total straight-line distance of more than 100 nautical miles from the original point of departure, and occurring in night VFR conditions; and

(v) 3 hours in a multiengine airplane in preparation for the practical test within 60 days preceding the date of the test.

(3) *For a rotorcraft helicopter course:* 30 hours of flight training from a certificated flight

instructor on the approved areas of operation listed in paragraph (d)(3) of this section that includes at least—

(i) 5 hours of instrument training;

(ii) One cross-country flight in a helicopter of at least a 2-hour duration, a total straight-line distance of more than 50 nautical miles from the original point of departure and occurring in day VFR conditions;

(iii) One cross-country flight in a helicopter of at least a 2-hour duration, a total straight-line distance of more than 50 nautical miles from the original point of departure, and occurring in night VFR conditions; and

(iv) 3 hours in a helicopter in preparation for the practical test within 60 days preceding the date of the test.

(4) *For a rotorcraft gyroplane course:* 30 hours of flight training from a certificated flight instructor on the approved areas of operation listed in paragraph (d)(4) of this section that includes at least—

(i) 5 hours of instrument training;

(ii) One cross-country flight in a gyroplane of at least a 2-hour duration, a total straight-line distance of more than 50 nautical miles from the original point of departure, and occurring in day VFR conditions;

(iii) One cross-country flight in a gyroplane of at least a 2-hour duration, a total straight-line distance of more than 50 nautical miles from the original point of departure, and occurring in night VFR conditions; and

(iv) 3 hours in a gyroplane in preparation for the practical test within 60 days preceding the date of the test.

(5) *For a powered-lift course:* 55 hours of flight training from a certificated flight instructor on the approved areas of operation listed in paragraph (d)(5) of this section that includes at least—

(i) 5 hours of instrument training in a powered-lift;

(ii) One cross-country flight in a powered-lift of at least a 2-hour duration, a total straight-line distance of more than 100 nautical miles from the original point of departure, and occurring in day VFR conditions;

(iii) One cross-country flight in a powered-lift of at least a 2-hour duration, a total straight-line distance of more than 100 nautical miles from the original point of departure, and occurring in night VFR conditions; and

(iv) 3 hours in a powered-lift in preparation for the practical test within 60 days preceding the date of the test.

(6) *For a glider course:* 4 hours of flight training from a certificated flight instructor on the approved areas of operation in paragraph (d)(6) of this section, that includes at least—

(i) Five training flights in a glider with a certificated flight instructor on the launch/tow procedures approved for the course and

on the appropriate approved areas of operation listed in paragraph (d)(6) of this section; and

(ii) Three training flights in a glider with a certificated flight instructor in preparation for the practical test within 60 days preceding the date of the test.

(7) *For a lighter-than-air airship course:* 55 hours of flight training in airships from a commercial pilot with an airship rating on the approved areas of operation in paragraph (d)(7) of this section that includes at least—

(i) 3 hours of instrument training in an airship;

(ii) One cross-country flight in an airship of at least a 1-hour duration, a total straight-line distance of more than 25 nautical miles from the original point of departure, and occurring in day VFR conditions; and

(iii) One cross-country flight in an airship of at least a 1-hour duration, a total straight-line distance of more than 25 nautical miles from the original point of departure, and occurring in night VFR conditions; and

(iv) 3 hours in an airship, in preparation for the practical test within 60 days preceding the date of the test.

(8) *For a lighter-than-air balloon course:* Flight training from a commercial pilot with a balloon rating on the approved areas of operation in paragraph (d)(8) of this section that includes at least—

(i) If the course involves training in a gas balloon:

(A) Two flights of 1 hour each;

(B) One flight involving a controlled ascent to at least 5,000 feet above the launch site; and

(C) Two flights in preparation for the practical test within 60 days preceding the date of the test.

(ii) If the course involves training in a balloon with an airborne heater:

(A) Two flights of 30 minutes each;

(B) One flight involving a controlled ascent to at least 3,000 feet above the launch site; and

(C) Two flights in preparation for the practical test within 60 days preceding the date of the test.

(c) For the use of flight simulators or flight training devices:

(1) The course may include training in a flight simulator or flight training device, provided it is representative of the aircraft for which the course is approved, meets the requirements of this paragraph, and is given by an authorized instructor.

(2) Training in a flight simulator that meets the requirements of §141.41(a) of this part may be credited for a maximum of 30 percent of the total flight training hour requirements of the approved course, or of this section, whichever is less.

(3) Training in a flight training device that meets the requirements of §141.41(b) of this part may be credited for a maximum of 20 percent of the total flight training hour requirements of the approved course, or of this section, whichever is less.

(4) Training in the flight training devices described in paragraphs (c)(2) and (c)(3) of this section, if used in combination, may be credited for a maximum of 30 percent of the total flight training hour requirements of the approved course, or of this section, whichever is less. However, credit for training in a flight training device that meets the requirements of §141.41(b) cannot exceed the limitation provided for in paragraph (c)(3) of this section.

(d) Each approved course must include the flight training on the approved areas of operation listed in this paragraph that are appropriate to the aircraft category and class rating—

(1) *For an airplane single-engine course:* (i) Preflight preparation;

- (ii) Preflight procedures;
- (iii) Airport and seaplane base operations;
- (iv) Takeoffs, landings, and go-arounds;
- (v) Performance maneuvers;
- (vi) Navigation;
- (vii) Slow flight and stalls;
- (viii) Emergency operations;
- (ix) High-altitude operations; and
- (x) Postflight procedures.

(2) *For an airplane multiengine course:* (i) Preflight preparation;

- (ii) Preflight procedures;
- (iii) Airport and seaplane base operations;
- (iv) Takeoffs, landings, and go-arounds;
- (v) Performance maneuvers;
- (vi) Navigation;
- (vii) Slow flight and stalls;
- (viii) Emergency operations;
- (ix) Multiengine operations;
- (x) High-altitude operations; and
- (xi) Postflight procedures.

(3) *For a rotorcraft helicopter course:* (i) Preflight preparation;

- (ii) Preflight procedures;
- (iii) Airport and heliport operations;
- (iv) Hovering maneuvers;
- (v) Takeoffs, landings, and go-arounds;
- (vi) Performance maneuvers;
- (vii) Navigation;
- (viii) Emergency operations;
- (ix) Special operations; and
- (x) Postflight procedures.

(4) *For a rotorcraft gyroplane course:* (i) Preflight preparation;

- (ii) Preflight procedures;
- (iii) Airport operations;
- (iv) Takeoffs, landings, and go-arounds;
- (v) Performance maneuvers;
- (vi) Navigation;
- (vii) Flight at slow airspeeds;
- (viii) Emergency operations; and
- (ix) Postflight procedures.

(5) *For a powered-lift course:* (i) Preflight preparation;

- (ii) Preflight procedures;
- (iii) Airport and heliport operations;
- (iv) Hovering maneuvers;
- (v) Takeoffs, landings, and go-arounds;
- (vi) Performance maneuvers;
- (vii) Navigation;
- (viii) Slow flight and stalls;
- (ix) Emergency operations;
- (x) High altitude operations;
- (xi) Special operations; and
- (xii) Postflight procedures.

(6) *For a glider course:* (i) Preflight preparation;

- (ii) Preflight procedures;
- (iii) Airport and gliderport operations;
- (iv) Launches/tows, as appropriate, and landings;
- (v) Performance speeds;
- (vi) Soaring techniques;
- (vii) Performance maneuvers;
- (viii) Navigation;
- (ix) Slow flight and stalls;
- (x) Emergency operations; and
- (xi) Postflight procedures.

(7) *For a lighter-than-air airship course:* (i) Fundamentals of instructing;

- (ii) Technical subjects;
- (iii) Preflight preparation;
- (iv) Preflight lessons on a maneuver to be performed in flight;
- (v) Preflight procedures;
- (vi) Airport operations;
- (vii) Takeoffs, landings, and go-arounds;
- (viii) Performance maneuvers;
- (ix) Navigation;
- (x) Emergency operations; and
- (xi) Postflight procedures.

(8) *For a lighter-than-air balloon course:* (i) Fundamentals of instructing;

- (ii) Technical subjects;
- (iii) Preflight preparation;
- (iv) Preflight lesson on a maneuver to be performed in flight;
- (v) Preflight procedures;
- (vi) Airport operations;
- (vii) Launches and landings;
- (viii) Performance maneuvers;
- (ix) Navigation;
- (x) Emergency operations; and
- (xi) Postflight procedures.

5. *Solo training.* Each approved course must include at least the following solo flight training:

(a) *For an airplane single-engine course:* 10 hours of solo flight training in a single-engine airplane on the approved areas of operation in paragraph (d)(1) of section No. 4 of this appendix that includes at least—

- (1) One cross-country flight, if the training is being performed in the State of Hawaii, with landings at a minimum of three points, and one of the segments consisting of a straight-line distance of at least 150 nautical miles;

(2) One cross-country flight, if the training is being performed in a State other than Hawaii, with landings at a minimum of three points, and one segment of the flight consisting of a straight-line distance of at least 250 nautical miles; and

(3) 5 hours in night VFR conditions with 10 takeoffs and 10 landings (with each landing involving a flight with a traffic pattern) at an airport with an operating control tower.

(b) *For an airplane multiengine course:* 10 hours of flight training in a multiengine airplane performing the duties of pilot in command while under the supervision of a certificated flight instructor. The training must consist of the approved areas of operation in paragraph (d)(2) of section No. 4 of this appendix, and include at least—

(1) One cross-country flight, if the training is being performed in the State of Hawaii, with landings at a minimum of three points, and one of the segments consisting of a straight-line distance of at least 150 nautical miles;

(2) One cross-country flight, if the training is being performed in a State other than Hawaii, with landings at a minimum of three points and one segment of the flight consisting of straight-line distance of at least 250 nautical miles; and

(3) 5 hours in night VFR conditions with 10 takeoffs and 10 landings (with each landing involving a flight with a traffic pattern) at an airport with an operating control tower.

(c) *For a rotorcraft helicopter course:* 10 hours of solo flight training in a helicopter on the approved areas of operation in paragraph (d)(3) of section No. 4 of this appendix that includes at least—

(1) One cross-country flight with landings at a minimum of three points and one segment of the flight consisting of a straight-line distance of at least 50 nautical miles from the original point of departure; and

(2) 5 hours in night VFR conditions with 10 takeoffs and 10 landings (with each landing involving a flight with a traffic pattern) at an airport with an operating control tower.

(d) *For a rotorcraft-gyroplane course:* 10 hours of solo flight training in a gyroplane on the approved areas of operation in paragraph (d)(4) of section No. 4 of this appendix that includes at least—

(1) One cross-country flight with landings at a minimum of three points, and one segment of the flight consisting of a straight-line distance of at least 50 nautical miles from the original point of departure; and

(2) 5 hours in night VFR conditions with 10 takeoffs and 10 landings (with each landing involving a flight with a traffic pattern) at an airport with an operating control tower.

(e) *For a powered-lift course:* 10 hours of solo flight training in a powered-lift on the approved areas of operation in paragraph (d)(5) of section No. 4 of this appendix that includes at least—

(1) One cross-country flight, if the training is being performed in the State of Hawaii, with landings at a minimum of three points, and one segment of the flight consisting of a straight-line distance of at least 150 nautical miles;

(2) One cross-country flight, if the training is being performed in a State other than Hawaii, with landings at a minimum of three points, and one segment of the flight consisting of a straight-line distance of at least 250 nautical miles; and

(3) 5 hours in night VFR conditions with 10 takeoffs and 10 landings (with each landing involving a flight with a traffic pattern) at an airport with an operating control tower.

(f) *For a glider course:* 5 solo flights in a glider on the approved areas of operation in paragraph (d)(6) of section No. 4 of this appendix.

(g) *For a lighter-than-air airship course:* 10 hours of flight training in an airship performing the duties of pilot in command while under the supervision of a commercial pilot with an airship rating. The training must consist of the approved areas of operation in paragraph (d)(7) of section No. 4 of this appendix and include at least—

(1) One cross-country flight with landings at a minimum of three points, and one segment of the flight consisting of a straight-line distance of at least 25 nautical miles from the original point of departure; and

(2) 5 hours in night VFR conditions with 10 takeoffs and 10 landings (with each landing involving a flight with a traffic pattern).

(h) *For a lighter-than-air balloon course:* Two solo flights if the course is for a hot air balloon rating, or, if the course is for a gas balloon rating, at least two flights in a gas balloon, while performing the duties of pilot in command under the supervision of a commercial pilot with a balloon rating. The training shall consist of the approved areas of operation in paragraph (d)(8) of section No. 4 of this appendix, in the kind of balloon for which the course applies.

6. *Stage checks and end-of-course tests.* (a) Each student enrolled in a commercial pilot course must satisfactorily accomplish the stage checks and end-of-course tests, in accordance with the school's approved training course, consisting of the approved areas of operation listed in paragraph (d) of section No. 4 of this appendix that are appropriate to aircraft category and class rating for which the course applies.

(b) Each student must demonstrate satisfactory proficiency prior to receiving an endorsement to operate an aircraft in solo flight.

[Doc. No. 25910, 62 FR 16347, Apr. 4, 1997; Amdt. 141-9, 62 FR 40909, July 30, 1997; as amended by Amdt. 141-10, 63 FR 20290, Apr. 23, 1998]

APPENDIX E TO PART 141—AIRLINE  
TRANSPORT PILOT CERTIFICATION  
COURSE

1. *Applicability.* This appendix prescribes the minimum curriculum for an airline transport pilot certification course under this part, for the following ratings:

- (a) Airplane single-engine.
- (b) Airplane multiengine.
- (c) Rotorcraft helicopter.
- (d) Powered-lift.

2. *Eligibility for enrollment.* Prior to enrolling in the flight portion of the airline transport pilot certification course, a person must:

(a) Meet the aeronautical experience requirements prescribed in subpart G of part 61 of this chapter for an airline transport pilot certificate that is appropriate to the aircraft category and class rating for which the course applies;

(b) Hold at least a commercial pilot certificate and an instrument rating;

(c) Meet the military experience requirements under §61.73 of this chapter to qualify for a commercial pilot certificate and an instrument rating, if the person is a rated military pilot or former rated military pilot of an Armed Force of the United States; or

(d) Hold either a foreign airline transport pilot license or foreign commercial pilot license and an instrument rating, if the person holds a pilot license issued by a contracting State to the Convention on International Civil Aviation.

3. *Aeronautical knowledge areas.* (a) Each approved course must include at least 40 hours of ground training on the aeronautical knowledge areas listed in paragraph (b) of this section, appropriate to the aircraft category and class rating for which the course applies.

(b) Ground training must include the following aeronautical knowledge areas:

(1) Applicable Federal Aviation Regulations of this chapter that relate to airline transport pilot privileges, limitations, and flight operations;

(2) Meteorology, including knowledge of and effects of fronts, frontal characteristics, cloud formations, icing, and upper-air data;

(3) General system of weather and NOTAM collection, dissemination, interpretation, and use;

(4) Interpretation and use of weather charts, maps, forecasts, sequence reports, abbreviations, and symbols;

(5) National Weather Service functions as they pertain to operations in the National Airspace System;

(6) Windshear and microburst awareness, identification, and avoidance;

(7) Principles of air navigation under instrument meteorological conditions in the National Airspace System;

(8) Air traffic control procedures and pilot responsibilities as they relate to en route operations, terminal area and radar operations, and instrument departure and approach procedures;

(9) Aircraft loading; weight and balance; use of charts, graphs, tables, formulas, and computations; and the effects on aircraft performance;

(10) Aerodynamics relating to an aircraft's flight characteristics and performance in normal and abnormal flight regimes;

(11) Human factors;

(12) Aeronautical decision making and judgment; and

(13) Crew resource management to include crew communication and coordination.

4. *Flight training.* (a) Each approved course must include at least 25 hours of flight training on the approved areas of operation listed in paragraph (c) of this section appropriate to the aircraft category and class rating for which the course applies. At least 15 hours of this flight training must be instrument flight training.

(b) For the use of flight simulators or flight training devices—

(1) The course may include training in a flight simulator or flight training device, provided it is representative of the aircraft for which the course is approved, meets the requirements of this paragraph, and the training is given by an authorized instructor.

(2) Training in a flight simulator that meets the requirements of §141.41(a) of this part may be credited for a maximum of 50 percent of the total flight training hour requirements of the approved course, or of this section, whichever is less.

(3) Training in a flight training device that meets the requirements of §141.41(b) of this part may be credited for a maximum of 25 percent of the total flight training hour requirements of the approved course, or of this section, whichever is less.

(4) Training in flight simulators or flight training devices described in paragraphs (b)(2) and (b)(3) of this section, if used in combination, may be credited for a maximum of 50 percent of the total flight training hour requirements of the approved course, or of this section, whichever is less. However, credit for training in a flight training device that meets the requirements of §141.41(b) cannot exceed the limitation provided for in paragraph (b)(3) of this section.

(c) Each approved course must include flight training on the approved areas of operation listed in this paragraph appropriate to the aircraft category and class rating for which the course applies:

(1) Preflight preparation;

(2) Preflight procedures;

(3) Takeoff and departure phase;

(4) In-flight maneuvers;

(5) Instrument procedures;

- (6) Landings and approaches to landings;
- (7) Normal and abnormal procedures;
- (8) Emergency procedures; and
- (9) Postflight procedures.

5. *Stage checks and end-of-course tests.* (a) Each student enrolled in an airline transport pilot course must satisfactorily accomplish the stage checks and end-of-course tests, in accordance with the school's approved training course, consisting of the approved areas of operation listed in paragraph (c) of section No. 4 of this appendix that are appropriate to the aircraft category and class rating for which the course applies.

(b) Each student must demonstrate satisfactory proficiency prior to receiving an endorsement to operate an aircraft in solo flight.

[Doc. No. 25910, 62 FR 16347, Apr. 4, 1997; Amdt. 141-9, 62 FR 40909, July 30, 1997]

#### APPENDIX F TO PART 141—FLIGHT INSTRUCTOR CERTIFICATION COURSE

1. *Applicability.* This appendix prescribes the minimum curriculum for a flight instructor certification course and an additional flight instructor rating course required under this part, for the following ratings:

- (a) Airplane single-engine.
- (b) Airplane multiengine.
- (c) Rotorcraft helicopter.
- (d) Rotorcraft gyroplane.
- (e) Powered-lift.
- (f) Glider category.

2. *Eligibility for enrollment.* A person must hold the following prior to enrolling in the flight portion of the flight instructor or additional flight instructor rating course:

(a) A commercial pilot certificate or an airline transport pilot certificate, with an aircraft category and class rating appropriate to the flight instructor rating for which the course applies; and

(b) An instrument rating or privilege in an aircraft that is appropriate to the aircraft category and class rating for which the course applies, if the course is for a flight instructor airplane or powered-lift instrument rating.

3. *Aeronautical knowledge training.* (a) Each approved course must include at least the following ground training in the aeronautical knowledge areas listed in paragraph (b) of this section:

(1) 40 hours of training if the course is for an initial issuance of a flight instructor certificate; or

(2) 20 hours of training if the course is for an additional flight instructor rating.

(b) Ground training must include the following aeronautical knowledge areas:

(1) The fundamentals of instructing including—

- (i) The learning process;

- (ii) Elements of effective teaching;
- (iii) Student evaluation and testing;
- (iv) Course development;
- (v) Lesson planning; and
- (vi) Classroom training techniques.

(2) The aeronautical knowledge areas in which training is required for—

(i) A recreational, private, and commercial pilot certificate that is appropriate to the aircraft category and class rating for which the course applies; and

(ii) An instrument rating that is appropriate to the aircraft category and class rating for which the course applies, if the course is for an airplane or powered-lift aircraft rating.

(c) A student who satisfactorily completes 2 years of study on the principles of education at a college or university may be credited with no more than 20 hours of the training required in paragraph (a)(1) of this section.

4. *Flight training.* (a) Each approved course must include at least the following flight training on the approved areas of operation of paragraph (c) of this section appropriate to the flight instructor rating for which the course applies:

(1) 25 hours, if the course is for an airplane, rotorcraft, or powered-lift rating; and

(2) 10 hours, which must include 10 flights, if the course is for a glider category rating.

(b) For the use of flight simulators or flight training devices:

(1) The course may include training in a flight simulator or flight training device, provided it is representative of the aircraft for which the course is approved, meets the requirements of this paragraph, and the training is given by an authorized instructor.

(2) Training in a flight simulator that meets the requirements of §141.41(a) of this part, may be credited for a maximum of 10 percent of the total flight training hour requirements of the approved course, or of this section, whichever is less.

(3) Training in a flight training device that meets the requirements of §141.41(b) of this part, may be credited for a maximum of 5 percent of the total flight training hour requirements of the approved course, or of this section, whichever is less.

(4) Training in flight simulators or flight training devices described in paragraphs (b)(2) and (b)(3) of this section, if used in combination, may be credited for a maximum of 10 percent of the total flight training hour requirements of the approved course, or of this section, whichever is less. However, credit for training in a flight training device that meets the requirements of §141.41(b) cannot exceed the limitation provided for in paragraph (b)(3) of this section.

(c) Each approved course must include flight training on the approved areas of operation listed in this paragraph that are appropriate to the aircraft category and class rating for which the course applies—

- (1) *For an airplane—single-engine course:* (i) Fundamentals of instructing;  
 (ii) Technical subject areas;  
 (iii) Preflight preparation;  
 (iv) Preflight lesson on a maneuver to be performed in flight;  
 (v) Preflight procedures;  
 (vi) Airport and seaplane base operations;  
 (vii) Takeoffs, landings, and go-arounds;  
 (viii) Fundamentals of flight;  
 (ix) Performance maneuvers;  
 (x) Ground reference maneuvers;  
 (xi) Slow flight, stalls, and spins;  
 (xii) Basic instrument maneuvers;  
 (xiii) Emergency operations; and  
 (xiv) Postflight procedures.
- (2) *For an airplane—multiengine course:* (i) Fundamentals of instructing;  
 (ii) Technical subject areas;  
 (iii) Preflight preparation;  
 (iv) Preflight lesson on a maneuver to be performed in flight;  
 (v) Preflight procedures;  
 (vi) Airport and seaplane base operations;  
 (vii) Takeoffs, landings, and go-arounds;  
 (viii) Fundamentals of flight;  
 (ix) Performance maneuvers;  
 (x) Ground reference maneuvers;  
 (xi) Slow flight and stalls;  
 (xii) Basic instrument maneuvers;  
 (xiii) Emergency operations;  
 (xiv) Multiengine operations; and  
 (xv) Postflight procedures.
- (3) *For a rotorcraft—helicopter course:* (i) Fundamentals of instructing;  
 (ii) Technical subject areas;  
 (iii) Preflight preparation;  
 (iv) Preflight lesson on a maneuver to be performed in flight;  
 (v) Preflight procedures;  
 (vi) Airport and heliport operations;  
 (vii) Hovering maneuvers;  
 (viii) Takeoffs, landings, and go-arounds;  
 (ix) Fundamentals of flight;  
 (x) Performance maneuvers;  
 (xi) Emergency operations;  
 (xii) Special operations; and  
 (xiii) Postflight procedures.
- (4) *For a rotorcraft—gyroplane course:* (i) Fundamentals of instructing;  
 (ii) Technical subject areas;  
 (iii) Preflight preparation;  
 (iv) Preflight lesson on a maneuver to be performed in flight;  
 (v) Preflight procedures;  
 (vi) Airport operations;  
 (vii) Takeoffs, landings, and go-arounds;  
 (viii) Fundamentals of flight;  
 (ix) Performance maneuvers;  
 (x) Flight at slow airspeeds;  
 (xi) Ground reference maneuvers;  
 (xii) Emergency operations; and

(xiii) Postflight procedures.

- (5) *For a powered-lift course:* (i) Fundamentals of instructing;  
 (ii) Technical subject areas;  
 (iii) Preflight preparation;  
 (iv) Preflight lesson on a maneuver to be performed in flight;  
 (v) Preflight procedures;  
 (vi) Airport and heliport operations;  
 (vii) Hovering maneuvers;  
 (viii) Takeoffs, landings, and go-arounds;  
 (ix) Fundamentals of flight;  
 (x) Performance maneuvers;  
 (xi) Ground reference maneuvers;  
 (xii) Slow flight and stalls;  
 (xiii) Basic instrument maneuvers;  
 (xiv) Emergency operations;  
 (xv) Special operations; and  
 (xvi) Postflight procedures.
- (6) *For a glider course:* (i) Fundamentals of instructing;  
 (ii) Technical subject areas;  
 (iii) Preflight preparation;  
 (iv) Preflight lesson on a maneuver to be performed in flight;  
 (v) Preflight procedures;  
 (vi) Airport and gliderport operations;  
 (vii) Tows or launches, landings, and go-arounds, if applicable;  
 (viii) Fundamentals of flight;  
 (ix) Performance speeds;  
 (x) Soaring techniques;  
 (xi) Performance maneuvers;  
 (xii) Slow flight, stalls, and spins;  
 (xiii) Emergency operations; and  
 (xiv) Postflight procedures.

5. *Stage checks and end-of-course tests.* (a) Each student enrolled in a flight instructor course must satisfactorily accomplish the stage checks and end-of-course tests, in accordance with the school's approved training course, consisting of the appropriate approved areas of operation listed in paragraph (c) of section No. 4 of this appendix appropriate to the flight instructor rating for which the course applies.

(b) In the case of a student who is enrolled in a flight instructor-airplane rating or flight instructor-glider rating course, that student must have:

- (1) Received a logbook endorsement from a certificated flight instructor certifying the student received ground and flight training on stall awareness, spin entry, spins, and spin recovery procedures in an aircraft that is certificated for spins and is appropriate to the rating sought; and
- (2) Demonstrated instructional proficiency in stall awareness, spin entry, spins, and spin recovery procedures.

[Doc. No. 25910, 62 FR 16347, Apr. 4, 1997; Amdt. 141–9, 62 FR 40909, July 30, 1997]

APPENDIX G TO PART 141—FLIGHT INSTRUCTOR INSTRUMENT (FOR AN AIRPLANE, HELICOPTER, OR POWERED-LIFT INSTRUMENT INSTRUCTOR RATING, AS APPROPRIATE) CERTIFICATION COURSE

1. *Applicability.* This appendix prescribes the minimum curriculum for a flight instructor instrument certification course required under this part, for the following ratings:

- (a) Flight Instructor Instrument—Airplane.
- (b) Flight Instructor Instrument—Helicopter.
- (c) Flight Instructor Instrument—Powered-lift aircraft.

2. *Eligibility for enrollment.* A person must hold the following prior to enrolling in the flight portion of the flight instructor instrument course:

- (a) A commercial pilot certificate or airline transport pilot certificate with an aircraft category and class rating appropriate to the flight instructor category and class rating for which the course applies; and
- (b) An instrument rating or privilege on that flight instructor applicant's pilot certificate that is appropriate to the flight instructor instrument rating (for an airplane-, helicopter-, or powered-lift-instrument rating, as appropriate) for which the course applies.

3. *Aeronautical knowledge training.* (a) Each approved course must include at least 15 hours of ground training on the aeronautical knowledge areas listed in paragraph (b) of this section, appropriate to the flight instructor instrument rating (for an airplane-, helicopter-, or powered-lift-instrument rating, as appropriate) for which the course applies:

(b) Ground training must include the following aeronautical knowledge areas:

- (1) The fundamentals of instructing including:
  - (i) The learning process;
  - (ii) Elements of effective teaching;
  - (iii) Student evaluation and testing;
  - (iv) Course development;
  - (v) Lesson planning; and
  - (vi) Classroom training techniques.
- (2) The aeronautical knowledge areas in which training is required for an instrument rating that is appropriate to the aircraft category and class rating for the course which applies.

4. *Flight training.* (a) Each approved course must include at least 15 hours of flight training in the approved areas of operation of paragraph (c) of this section appropriate to the flight instructor rating for which the course applies.

(b) For the use of flight simulators or flight training devices:

(1) The course may include training in a flight simulator or flight training device, provided it is representative of the aircraft for which the course is approved for, meets requirements of this paragraph, and the training is given by an instructor.

(2) Training in a flight simulator that meets the requirements of §141.41(a) of this part, may be credited for a maximum of 10 percent of the total flight training hour requirements of the approved course, or of this section, whichever is less.

(3) Training in a flight training device that meets the requirements of §141.41(b) of this part, may be credited for a maximum of 5 percent of the total flight training hour requirements of the approved course, or of this section, whichever is less.

(4) Training in flight simulators or flight training devices described in paragraphs (b)(2) and (b)(3) of this section, if used in combination, may be credited for a maximum of 10 percent of the total flight training hour requirements of the approved course, or of this section, whichever is less. However, credit for training in a flight training device that meets the requirements of §141.41(b) cannot exceed the limitation provided for in paragraph (b)(3) of this section.

(c) An approved course for the flight instructor-instrument rating must include flight training on the following approved areas of operation that are appropriate to the instrument-aircraft category and class rating for which the course applies:

- (1) Fundamentals of instructing;
- (2) Technical subject areas;
- (3) Preflight preparation;
- (4) Preflight lesson on a maneuver to be performed in flight;
- (5) Air traffic control clearances and procedures;
- (6) Flight by reference to instruments;
- (7) Navigation systems;
- (8) Instrument approach procedures;
- (9) Emergency operations; and
- (10) Postflight procedures.

5. *Stage checks and end-of-course tests.* Each student enrolled in a flight instructor instrument course must satisfactorily accomplish the stage checks and end-of-course tests, in accordance with the school's approved training course, consisting of the approved areas of operation listed in paragraph (c) of section No. 4 of this appendix that are appropriate to the flight instructor instrument rating (for an airplane-, helicopter-, or powered-lift-instrument rating, as appropriate) for which the course applies.

[Doc. No. 25910, 62 FR 16347, Apr. 4, 1997; Amdt. 141-9, 62 FR 40909, July 30, 1997]

APPENDIX H TO PART 141—GROUND  
INSTRUCTOR CERTIFICATION COURSE

1. *Applicability.* This appendix prescribes the minimum curriculum for a ground instructor certification course and an additional ground instructor rating course, required under this part, for the following ratings:

- (a) Ground Instructor—Basic.
- (b) Ground Instructor—Advanced.
- (c) Ground Instructor—Instrument.

2. *Aeronautical knowledge training.* (a) Each approved course must include at least the following ground training on the knowledge areas listed in paragraphs (b), (c), (d), and (e) of this section, appropriate to the ground instructor rating for which the course applies:

(1) 20 hours of training if the course is for an initial issuance of a ground instructor certificate; or

(2) 10 hours of training if the course is for an additional ground instructor rating.

(b) Ground training must include the following aeronautical knowledge areas:

- (1) Learning process;
- (2) Elements of effective teaching;
- (3) Student evaluation and testing;
- (4) Course development;
- (5) Lesson planning; and
- (6) Classroom training techniques.

(c) Ground training for a basic ground instructor certificate must include the aeronautical knowledge areas applicable to a recreational and private pilot.

(d) Ground training for an advanced ground instructor rating must include the aeronautical knowledge areas applicable to a recreational, private, commercial, and airline transport pilot.

(e) Ground training for an instrument ground instructor rating must include the aeronautical knowledge areas applicable to an instrument rating.

(f) A student who satisfactorily completed 2 years of study on the principles of education at a college or university may be credited with 10 hours of the training required in paragraph (a)(1) of this section.

3. *Stage checks and end-of-course tests.* Each student enrolled in a ground instructor course must satisfactorily accomplish the stage checks and end-of-course tests, in accordance with the school's approved training course, consisting of the approved knowledge areas in paragraph (b), (c), (d), and (e) of section No. 2 of this appendix appropriate to the ground instructor rating for which the course applies.

APPENDIX I TO PART 141—ADDITIONAL  
AIRCRAFT CATEGORY OR CLASS RATING  
COURSE

1. *Applicability.* This appendix prescribes the minimum curriculum for an additional aircraft category rating course or an addi-

tional aircraft class rating course required under this part, for the following ratings:

- (a) Airplane single-engine.
- (b) Airplane multiengine.
- (c) Rotorcraft helicopter.
- (d) Rotorcraft gyroplane.
- (e) Powered-lift.
- (f) Glider.
- (g) Lighter-than-air airship.
- (h) Lighter-than-air balloon.

2. *Eligibility for enrollment.* A person must hold the level of pilot certificate for the additional aircraft category and class rating for which the course applies prior to enrolling in the flight portion of an additional aircraft category or additional aircraft class rating course.

3. *Aeronautical knowledge training.* Each approved course for an additional aircraft category rating and additional aircraft class rating must include ground training time requirements and ground training on the aeronautical knowledge areas that are specific to that aircraft category and class rating and pilot certificate level for which the course applies as required in appendix A, B, D, or E of this part, as appropriate.

4. *Flight training.* (a) Each approved course for an additional aircraft category rating or additional aircraft class rating must include the flight training time requirements and flight training on the areas of operation that are specific to that aircraft category and class rating and pilot certificate level for which the course applies as required in appendix A, B, D, or E of this part, as appropriate.

(b) For the use of flight simulators or flight training devices:

(1) The course may include training in a flight simulator or flight training device, provided it is representative of the aircraft for which the course is approved, meets the requirements of this paragraph, and the training is given by an authorized instructor.

(2) Training in a flight simulator that meets the requirements of §141.41(a) of this part may be credited for a maximum of 30 percent of the total flight training hour requirements of the approved course, or of this section, whichever is less.

(3) Training in a flight training device that meets the requirements of §141.41(b) of this part may be credited for a maximum of 20 percent of the total flight training hour requirements of the approved course, or of this section, whichever is less.

(4) Training in the flight simulators or flight training devices described in paragraphs (b)(2) and (b)(3) of this section, if used in combination, may be credited for a maximum of 30 percent of the total flight training hour requirements of the approved course, or of this section, whichever is less. However, credit for training in a flight training device that meets the requirements of

§141.41(b) cannot exceed the limitation provided for in paragraph (c)(3) of this section.

5. *Stage checks and end-of-course tests.* (a) Each student enrolled in an additional aircraft category rating course or an additional aircraft class rating course must satisfactorily accomplish the stage checks and end-of-course tests, in accordance with the school's approved training course, consisting of the approved areas of operation in section No. 4 of this appendix that are appropriate to the aircraft category and class rating for which the course applies at the appropriate pilot certificate level.

(b) Each student must demonstrate satisfactory proficiency prior to receiving an endorsement to operate an aircraft in solo flight.

[Doc. No. 25910, 62 FR 16347, Apr. 4, 1997; Amdt. 141-9, 62 FR 40909, July 30, 1997]

APPENDIX J TO PART 141—AIRCRAFT TYPE RATING COURSE, FOR OTHER THAN AN AIRLINE TRANSPORT PILOT CERTIFICATE

1. *Applicability.* This appendix prescribes the minimum curriculum for an aircraft type rating course other than an airline transport pilot certificate, for:

(a) A type rating in an airplane category—single-engine class.

(b) A type rating in an airplane category—multiengine class.

(c) A type rating in a rotorcraft category—helicopter class.

(d) A type rating in a powered-lift category.

(e) Other aircraft type ratings specified by the Administrator through the aircraft type certificate procedures.

2. *Eligibility for enrollment.* Prior to enrolling in the flight portion of an aircraft type rating course, a person must hold at least a private pilot certificate and:

(a) An instrument rating in the category and class of aircraft that is appropriate to the aircraft type rating for which the course applies, provided the aircraft's type certificate does not have a VFR limitation; or

(b) Be concurrently enrolled in an instrument rating course in the category and class of aircraft that is appropriate to the aircraft type rating for which the course applies, and pass the required instrument rating practical test concurrently with the aircraft type rating practical test.

3. *Aeronautical knowledge training.* (a) Each approved course must include at least 10 hours of ground training on the aeronautical knowledge areas listed in paragraph (b) of this section, appropriate to the aircraft type rating for which the course applies.

(b) Ground training must include the following aeronautical areas:

(1) Proper control of airspeed, configuration, direction, altitude, and attitude in accordance with procedures and limitations contained in the aircraft's flight manual, checklists, or other approved material appropriate to the aircraft type;

(2) Compliance with approved en route, instrument approach, missed approach, ATC, or other applicable procedures that apply to the aircraft type;

(3) Subjects requiring a practical knowledge of the aircraft type and its powerplant, systems, components, operational, and performance factors;

(4) The aircraft's normal, abnormal, and emergency procedures, and the operations and limitations relating thereto;

(5) Appropriate provisions of the approved aircraft's flight manual;

(6) Location of and purpose for inspecting each item on the aircraft's checklist that relates to the exterior and interior preflight; and

(7) Use of the aircraft's prestart checklist, appropriate control system checks, starting procedures, radio and electronic equipment checks, and the selection of proper navigation and communication radio facilities and frequencies.

4. *Flight training.* (a) Each approved course must include at least:

(1) Flight training on the approved areas of operation of paragraph (c) of this section in the aircraft type for which the course applies; and

(2) 10 hours of training of which at least 5 hours must be instrument training in the aircraft for which the course applies.

(b) For the use of flight simulators or flight training devices:

(1) The course may include training in a flight simulator or flight training device, provided it is representative of the aircraft for which the course is approved, meets requirements of this paragraph, and the training is given by an authorized instructor.

(2) Training in a flight simulator that meets the requirements of §141.41(a) of this part, may be credited for a maximum of 50 percent of the total flight training hour requirements of the approved course, or of this section, whichever is less.

(3) Training in a flight training device that meets the requirements of §141.41(b) of this part, may be credited for a maximum of 25 percent of the total flight training hour requirements of the approved course, or of this section, whichever is less.

(4) Training in the flight simulators or flight training devices described in paragraphs (b)(2) and (b)(3) of this section, if used in combination, may be credited for a maximum of 50 percent of the total flight training hour requirements of the approved course, or of this section, whichever is less. However, credit training in a flight training device that meets the requirements of

§141.41(b) cannot exceed the limitation provided for in paragraph (b)(3) of this section.

(c) Each approved course must include the flight training on the areas of operation listed in this paragraph, that are appropriate to the aircraft category and class rating for which the course applies:

(1) *A type rating for an airplane—single-engine course:* (i) Preflight preparation;

- (ii) Preflight procedures;
- (iii) Takeoff and departure phase;
- (iv) In-flight maneuvers;
- (v) Instrument procedures;
- (vi) Landings and approaches to landings;
- (vii) Normal and abnormal procedures;
- (viii) Emergency procedures; and
- (ix) Postflight procedures.

(2) *A type rating for an airplane—multiengine course:* (i) Preflight preparation;

- (ii) Preflight procedures;
- (iii) Takeoff and departure phase;
- (iv) In-flight maneuvers;
- (v) Instrument procedures;
- (vi) Landings and approaches to landings;
- (vii) Normal and abnormal procedures;
- (viii) Emergency procedures; and
- (ix) Postflight procedures.

(3) *A type rating for a powered-lift course:* (i) Preflight preparation;

- (ii) Preflight procedures;
- (iii) Takeoff and departure phase;
- (iv) In-flight maneuvers;
- (v) Instrument procedures;
- (vi) Landings and approaches to landings;
- (vii) Normal and abnormal procedures;
- (viii) Emergency procedures; and
- (ix) Postflight procedures.

(4) *A type rating for a rotorcraft—helicopter course:* (i) Preflight preparation;

- (ii) Preflight procedures;
- (iii) Takeoff and departure phase;
- (iv) In-flight maneuvers;
- (v) Instrument procedures;
- (vi) Landings and approaches to landings;
- (vii) Normal and abnormal procedures;
- (viii) Emergency procedures; and
- (ix) Postflight procedures.

(5) *Other aircraft type ratings specified by the Administrator through aircraft type certificate procedures:* (i) Preflight preparation;

- (ii) Preflight procedures;
- (iii) Takeoff and departure phase;
- (iv) In-flight maneuvers;
- (v) Instrument procedures;
- (vi) Landings and approaches to landings;
- (vii) Normal and abnormal procedures;
- (viii) Emergency procedures; and
- (ix) Postflight procedures.

5. *Stage checks and end-of-course tests.* (a) Each student enrolled in an aircraft type rating course must satisfactorily accomplish the stage checks and end-of-course tests, in accordance with the school's approved training course, consisting of the approved areas of operation that are appropriate to the aircraft type rating for which the course applies

at the airline transport pilot certificate level; and

(b) Each student must demonstrate satisfactory proficiency prior to receiving an endorsement to operate an aircraft in solo flight.

[Doc. No. 25910, 62 FR 16347, Apr. 4, 1997; Amdt. 141–9, 62 FR 40910, July 30, 1997]

#### APPENDIX K TO PART 141—SPECIAL PREPARATION COURSES

1. *Applicability.* This appendix prescribes the minimum curriculum for the special preparation courses that are listed in §141.11 of this part.

2. *Eligibility for enrollment.* Prior to enrolling in the flight portion of a special preparation course, a person must hold a pilot certificate, flight instructor certificate, or ground instructor certificate that is appropriate for the exercise of the operating privileges or authorizations sought.

3. *General requirements.* (a) To be approved, a special preparation course must:

(1) Meet the appropriate requirements of this appendix; and

(2) Prepare the graduate with the necessary skills, competency, and proficiency to exercise safely the privileges of the certificate, rating, or authorization for which the course is established.

(b) An approved special preparation course must include ground and flight training on the operating privileges or authorization sought, for developing competency, proficiency, resourcefulness, self-confidence, and self-reliance in the student.

4. *Use of flight simulators or flight training devices.* (a) The approved special preparation course may include training in a flight simulator or flight training device, provided it is representative of the aircraft for which the course is approved, meets requirements of this paragraph, and the training is given by an authorized instructor.

(b) Training in a flight simulator that meets the requirements of §141.41(a) of this part, may be credited for a maximum of 10 percent of the total flight training hour requirements of the approved course, or of this section, whichever is less.

(c) Training in a flight training device that meets the requirements of §141.41(b) of this part, may be credited for a maximum of 5 percent of the total flight training hour requirements of the approved course, or of this section, whichever is less.

(d) Training in the flight simulators or flight training devices described in paragraphs (b) and (c) of this section, if used in combination, may be credited for a maximum of 10 percent of the total flight training hour requirements of the approved course, or of this section, whichever is less.

However, credit for training in a flight training device that meets the requirements of §141.41(b) cannot exceed the limitation provided for in paragraph (c) of this section.

5. *Stage check and end-of-course tests.* Each person enrolled in a special preparation course must satisfactorily accomplish the stage checks and end-of-course tests, in accordance with the school's approved training course, consisting of the approved areas of operation that are appropriate to the operating privileges or authorization sought, and for which the course applies.

6. *Agricultural aircraft operations course.* An approved special preparation course for pilots in agricultural aircraft operations must include at least the following—

(a) 25 hours of training on:

- (1) Agricultural aircraft operations;
- (2) Safe piloting and operating practices and procedures for handling, dispensing, and disposing agricultural and industrial chemicals, including operating in and around congested areas; and
- (3) Applicable provisions of part 137 of this chapter.

(b) 15 hours of flight training on agricultural aircraft operations.

7. *Rotorcraft external-load operations course.* An approved special preparation course for pilots of external-load operations must include at least the following—

(a) 10 hours of training on:

- (1) Rotorcraft external-load operations;
- (2) Safe piloting and operating practices and procedures for external-load operations, including operating in and around congested areas; and
- (3) Applicable provisions of part 133 of this chapter.

(b) 15 hours of flight training on external-load operations.

8. *Test pilot course.* An approved special preparation course for pilots in test pilot duties must include at least the following—

(a) Aeronautical knowledge training on:

- (1) Performing aircraft maintenance, quality assurance, and certification test flight operations;
- (2) Safe piloting and operating practices and procedures for performing aircraft maintenance, quality assurance, and certification test flight operations;
- (3) Applicable parts of this chapter that pertain to aircraft maintenance, quality assurance, and certification tests; and
- (4) Test pilot duties and responsibilities.

(b) 15 hours of flight training on test pilot duties and responsibilities.

9. *Special operations course.* An approved special preparation course for pilots in special operations that are mission-specific for certain aircraft must include at least the following—

(a) Aeronautical knowledge training on:

- (1) Performing that special flight operation;

(2) Safe piloting operating practices and procedures for performing that special flight operation;

(3) Applicable parts of this chapter that pertain to that special flight operation; and

(4) Pilot in command duties and responsibilities for performing that special flight operation.

(b) Flight training:

(1) On that special flight operation; and

(2) To develop skills, competency, proficiency, resourcefulness, self-confidence, and self-reliance in the student for performing that special flight operation in a safe manner.

10. *Pilot refresher course.* An approved special preparation pilot refresher course for a pilot certificate, aircraft category and class rating, or an instrument rating must include at least the following—

(a) 4 hours of aeronautical knowledge training on:

(1) The aeronautical knowledge areas that are applicable to the level of pilot certificate, aircraft category and class rating, or instrument rating, as appropriate, that pertain to that course;

(2) Safe piloting operating practices and procedures; and

(3) Applicable provisions of parts 61 and 91 of this chapter for pilots.

(b) 6 hours of flight training on the approved areas of operation that are applicable to the level of pilot certificate, aircraft category and class rating, or instrument rating, as appropriate, for performing pilot-in-command duties and responsibilities.

11. *Flight instructor refresher course.* An approved special preparation flight instructor refresher course must include at least a combined total of 16 hours of aeronautical knowledge training, flight training, or any combination of ground and flight training on the following—

(a) Aeronautical knowledge training on:

(1) The aeronautical knowledge areas of part 61 of this chapter that apply to student, recreational, private, and commercial pilot certificates and instrument ratings;

(2) The aeronautical knowledge areas of part 61 of this chapter that apply to flight instructor certificates;

(3) Safe piloting operating practices and procedures, including airport operations and operating in the National Airspace System; and

(4) Applicable provisions of parts 61 and 91 of this chapter that apply to pilots and flight instructors.

(b) Flight training to review:

(1) The approved areas of operations applicable to student, recreational, private, and commercial pilot certificates and instrument ratings; and

(2) The skills, competency, and proficiency for performing flight instructor duties and responsibilities.

**Pt. 141, App. L**

12. *Ground instructor refresher course.* An approved special preparation ground instructor refresher course must include at least 16 hours of aeronautical knowledge training on:

(a) The aeronautical knowledge areas of part 61 of this chapter that apply to student, recreational, private, and commercial pilots and instrument rated pilots;

(b) The aeronautical knowledge areas of part 61 of this chapter that apply to ground instructors;

(c) Safe piloting operating practices and procedures, including airport operations and operating in the National Airspace System; and

(d) Applicable provisions of parts 61 and 91 of this chapter that apply to pilots and ground instructors.

[Doc. No. 25910, 62 FR 16347, Apr. 4, 1997; Amdt. 141-9, 62 FR 40910, July 30, 1997]

**APPENDIX L TO PART 141—PILOT  
GROUND SCHOOL COURSE**

1. *Applicability.* This appendix prescribes the minimum curriculum for a pilot ground school course required under this part.

2. *General requirements.* An approved course of training for a pilot ground school must include training on the aeronautical knowledge areas that are:

(a) Needed to safely exercise the privileges of the certificate, rating, or authority for which the course is established; and

(b) Conducted to develop competency, proficiency, resourcefulness, self-confidence, and self-reliance in each student.

3. *Aeronautical knowledge training requirements.* Each approved pilot ground school course must include:

(a) The aeronautical knowledge training that is appropriate to the aircraft rating and pilot certificate level for which the course applies; and

(b) An adequate number of total aeronautical knowledge training hours appropriate to the aircraft rating and pilot certificate level for which the course applies.

4. *Stage checks and end-of-course tests.* Each person enrolled in a pilot ground school course must satisfactorily accomplish the stage checks and end-of-course tests, in accordance with the school's approved training course, consisting of the approved areas of operation that are appropriate to the operating privileges or authorization that graduation from the course will permit and for which the course applies.

**PART 142—TRAINING CENTERS**

SPECIAL FEDERAL AVIATION REGULATION NO. 93 [NOTE]

**14 CFR Ch. I (1-1-08 Edition)**

**Subpart A—General**

Sec.

142.1 Applicability.

142.3 Definitions.

142.5 Certificate and training specifications required.

142.7 Duration of a certificate.

142.9 Deviations or waivers.

142.11 Application for issuance or amendment.

142.13 Management and personnel requirements.

142.15 Facilities.

142.17 Satellite training centers.

142.21-142.25 [Reserved]

142.27 Display of certificate.

142.29 Inspections.

142.31 Advertising limitations.

142.33 Training agreements.

**Subpart B—Aircrew Curriculum and  
Syllabus Requirements**

142.35 Applicability.

142.37 Approval of flight aircrew training program.

142.39 Training program curriculum requirements.

**Subpart C—Personnel and Flight Training  
Equipment Requirements**

142.45 Applicability.

142.47 Training center instructor eligibility requirements.

142.49 Training center instructor and evaluator privileges and limitations.

142.51 [Reserved]

142.53 Training center instructor training and testing requirements.

142.55 Training center evaluator requirements.

142.57 Aircraft requirements.

142.59 Flight simulators and flight training devices.

**Subpart D—Operating Rules**

142.61 Applicability.

142.63 Privileges.

142.65 Limitations.

**Subpart E—Recordkeeping**

142.71 Applicability.

142.73 Recordkeeping requirements.

**Subpart F—Other Approved Courses**

142.81 Conduct of other approved courses.

AUTHORITY: 49 U.S.C. 106(g), 40113, 40119, 44101, 44701-44703, 44705, 44707, 44709-44711, 45102-45103, 45301-45302.

SOURCE: Docket No. 26933, 61 FR 34562, July 2, 1996, unless otherwise noted.

SPECIAL FEDERAL AVIATION REGULATION  
No. 93

EDITORIAL NOTE: For the text of SFAR No. 93, see part 61 of this chapter.

**Subpart A—General****§ 142.1 Applicability.**

(a) This subpart prescribes the requirements governing the certification and operation of aviation training centers. Except as provided in paragraph (b) of this section, this part provides an alternative means to accomplish training required by parts 61, 63, 91, 121, 125, 127, 135, or 137 of this chapter.

(b) Certification under this part is not required for training that is—

(1) Approved under the provisions of parts 63, 91, 121, 127, 135, or 137 of this chapter;

(2) Approved under SFAR 58, Advanced Qualification Programs, for the authorization holder's own employees;

(3) Conducted under part 61 unless that part requires certification under this part;

(4) Conducted by a part 121 certificate holder for another part 121 certificate holder;

(5) Conducted by a part 135 certificate holder for another part 135 certificate holder; or

(6) Conducted by a part 91 fractional ownership program manager for another part 91 fractional ownership program manager.

(c) Except as provided in paragraph (b) of this section, after August 3, 1998, no person may conduct training, testing, or checking in advanced flight training devices or flight simulators without, or in violation of, the certificate and training specifications required by this part.

[Doc. No. 26933, 61 FR 34562, July 2, 1996, as amended by Amdt. 142-4, 66 FR 21067, Apr. 27, 2001; Amdt. 142-5, 68 FR 54588, Sept. 17, 2003]

**§ 142.3 Definitions.**

As used in this part:

*Advanced Flight Training Device* as used in this part, means a flight training device as defined in part 61 of this chapter that has a cockpit that accurately replicates a specific make, model, and type aircraft cockpit, and handling characteristics that accurately

model the aircraft handling characteristics.

*Core Curriculum* means a set of courses approved by the Administrator, for use by a training center and its satellite training centers. The core curriculum consists of training which is required for certification. It does not include training for tasks and circumstances unique to a particular user.

*Course* means—

(1) A program of instruction to obtain pilot certification, qualification, authorization, or currency;

(2) A program of instruction to meet a specified number of requirements of a program for pilot training, certification, qualification, authorization, or currency; or

(3) A curriculum, or curriculum segment, as defined in SFAR 58 of part 121 of this chapter.

*Courseware* means instructional material developed for each course or curriculum, including lesson plans, flight event descriptions, computer software programs, audiovisual programs, workbooks, and handouts.

*Evaluator* means a person employed by a training center certificate holder who performs tests for certification, added ratings, authorizations, and proficiency checks that are authorized by the certificate holder's training specification, and who is authorized by the Administrator to administer such checks and tests.

*Flight training equipment* means flight simulators, as defined in §61.1(b)(5) of this chapter, flight training devices, as defined in §61.1(b)(7) of this chapter, and aircraft.

*Instructor* means a person employed by a training center and designated to provide instruction in accordance with subpart C of this part.

*Line-Operational Simulation* means simulation conducted using operational-oriented flight scenarios that accurately replicate interaction among flightcrew members and between flightcrew members and dispatch facilities, other crewmembers, air traffic control, and ground operations. Line operational simulation simulations are conducted for training and evaluation purposes and include random, abnormal, and emergency occurrences. Line

## § 142.5

operational simulation specifically includes line-oriented flight training, special purpose operational training, and line operational evaluation.

*Specialty Curriculum* means a set of courses that is designed to satisfy a requirement of the Federal Aviation Regulations and that is approved by the Administrator for use by a particular training center or satellite training center. The specialty curriculum includes training requirements unique to one or more training center clients.

*Training center* means an organization governed by the applicable requirements of this part that provides training, testing, and checking under contract or other arrangement to airmen subject to the requirements of this chapter.

*Training program* consists of courses, courseware, facilities, flight training equipment, and personnel necessary to accomplish a specific training objective. It may include a core curriculum and a specialty curriculum.

*Training specifications* means a document issued to a training center certificate holder by the Administrator that prescribes that center's training, checking, and testing authorizations and limitations, and specifies training program requirements.

[Doc. No. 26933, 61 FR 34562, July 2, 1996, as amended by Amdt. 142-2, 62 FR 68137, Dec. 30, 1997]

### § 142.5 Certificate and training specifications required.

(a) No person may operate a certificated training center without, or in violation of, a training center certificate and training specifications issued under this part.

(b) An applicant will be issued a training center certificate and training specifications with appropriate limitations if the applicant shows that it has adequate facilities, equipment, personnel, and courseware required by § 142.11 to conduct training approved under § 142.37.

### § 142.7 Duration of a certificate.

(a) Except as provided in paragraph (b) of this section, a training center certificate issued under this part is effective until the certificate is surren-

## 14 CFR Ch. I (1-1-08 Edition)

dered or until the Administrator suspends, revokes, or terminates it.

(b) Unless sooner surrendered, suspended, or revoked, a certificate issued under this part for a training center located outside the United States expires at the end of the twelfth month after the month in which it is issued or renewed.

(c) If the Administrator suspends, revokes, or terminates a training center certificate, the holder of that certificate shall return the certificate to the Administrator within 5 working days after being notified that the certificate is suspended, revoked, or terminated.

### § 142.9 Deviations or waivers.

(a) The Administrator may issue deviations or waivers from any of the requirements of this part.

(b) A training center applicant requesting a deviation or waiver under this section must provide the Administrator with information acceptable to the Administrator that shows—

(1) Justification for the deviation or waiver; and

(2) That the deviation or waiver will not adversely affect the quality of instruction or evaluation.

### § 142.11 Application for issuance or amendment.

(a) An application for a training center certificate and training specifications shall—

(1) Be made on a form and in a manner prescribed by the Administrator;

(2) Be filed with the FAA Flight Standards District Office that has jurisdiction over the area in which the applicant's principal business office is located; and

(3) Be made at least 120 calendar days before the beginning of any proposed training or 60 calendar days before effecting an amendment to any approved training, unless a shorter filing period is approved by the Administrator.

(b) Each application for a training center certificate and training specification shall provide—

(1) A statement showing that the minimum qualification requirements for each management position are met or exceeded;

**Federal Aviation Administration, DOT**

**§ 142.11**

(2) A statement acknowledging that the applicant shall notify the Administrator within 10 working days of any change made in the assignment of persons in the required management positions;

(3) The proposed training authorizations and training specifications requested by the applicant;

(4) The proposed evaluation authorization;

(5) A description of the flight training equipment that the applicant proposes to use;

(6) A description of the applicant's training facilities, equipment, qualifications of personnel to be used, and proposed evaluation plans;

(7) A training program curriculum, including syllabi, outlines, courseware, procedures, and documentation to support the items required in subpart B of this part, upon request by the Administrator;

(8) A description of a recordkeeping system that will identify and document the details of training, qualification, and certification of students, instructors, and evaluators;

(9) A description of quality control measures proposed; and

(10) A method of demonstrating the applicant's qualification and ability to provide training for a certificate or rating in fewer than the minimum hours prescribed in part 61 of this chapter if the applicant proposes to do so.

(c) The facilities and equipment described in paragraph (b)(6) of this section shall—

(1) Be available for inspection and evaluation prior to approval; and

(2) Be in place and operational at the location of the proposed training center prior to issuance of a certificate under this part.

(d) An applicant who meets the requirements of this part and is approved by the Administrator is entitled to—

(1) A training center certificate containing all business names included on the application under which the certificate holder may conduct operations and the address of each business office used by the certificate holder; and

(2) Training specifications, issued by the Administrator to the certificate holder, containing—

(i) The type of training authorized, including approved courses;

(ii) The category, class, and type of aircraft that may be used for training, testing, and checking;

(iii) For each flight simulator or flight training device, the make, model, and series of airplane or the set of airplanes being simulated and the qualification level assigned, or the make, model, and series of rotorcraft, or set of rotorcraft being simulated and the qualification level assigned;

(iv) For each flight simulator and flight training device subject to qualification evaluation by the Administrator, the identification number assigned by the FAA;

(v) The name and address of all satellite training centers, and the approved courses offered at each satellite training center;

(vi) Authorized deviations or waivers from this part; and

(vii) Any other items the Administrator may require or allow.

(e) The Administrator may deny, suspend, revoke, or terminate a certificate under this part if the Administrator finds that the applicant or the certificate holder—

(1) Held a training center certificate that was revoked, suspended, or terminated within the previous 5 years; or

(2) Employs or proposes to employ a person who—

(i) Was previously employed in a management or supervisory position by the holder of a training center certificate that was revoked, suspended, or terminated within the previous 5 years;

(ii) Exercised control over any certificate holder whose certificate has been revoked, suspended, or terminated within the last 5 years; and

(iii) Contributed materially to the revocation, suspension, or termination of that certificate and who will be employed in a management or supervisory position, or who will be in control of or have a substantial ownership interest in the training center.

(3) Has provided incomplete, inaccurate, fraudulent, or false information for a training center certificate;

(4) Should not be granted a certificate if the grant would not foster aviation safety.

**§ 142.13**

**14 CFR Ch. I (1–1–08 Edition)**

(f) At any time, the Administrator may amend a training center certificate—

(1) On the Administrator's own initiative, under section 609 of the Federal Aviation Act of 1958 (49 U.S.C. 1429), as amended, and part 13 of this chapter; or

(2) Upon timely application by the certificate holder.

(g) The certificate holder must file an application to amend a training center certificate at least 60 calendar days prior to the applicant's proposed effective amendment date unless a different filing period is approved by the Administrator.

[Doc. No. 26933, 61 FR 34562, July 2, 1996, as amended by Amdt. 142-1, 62 FR 13791, Mar. 21, 1997]

**§ 142.13 Management and personnel requirements.**

An applicant for a training center certificate must show that—

(a) For each proposed curriculum, the training center has, and shall maintain, a sufficient number of instructors who are qualified in accordance with subpart C of this part to perform the duties to which they are assigned;

(b) The training center has designated, and shall maintain, a sufficient number of approved evaluators to provide required checks and tests to graduation candidates within 7 calendar days of training completion for any curriculum leading to airman certificates or ratings, or both;

(c) The training center has, and shall maintain, a sufficient number of management personnel who are qualified and competent to perform required duties; and

(d) A management representative, and all personnel who are designated by the training center to conduct direct student training, are able to understand, read, write, and fluently speak the English language.

**§ 142.15 Facilities.**

(a) An applicant for, or holder of, a training center certificate shall ensure that—

(1) Each room, training booth, or other space used for instructional purposes is heated, lighted, and ventilated to conform to local building, sanitation, and health codes; and

(2) The facilities used for instruction are not routinely subject to significant distractions caused by flight operations and maintenance operations at the airport.

(b) An applicant for, or holder of, a training center certificate shall establish and maintain a principal business office that is physically located at the address shown on its training center certificate.

(c) The records required to be maintained by this part must be located in facilities adequate for that purpose.

(d) An applicant for, or holder of, a training center certificate must have available exclusively, for adequate periods of time and at a location approved by the Administrator, adequate flight training equipment and courseware, including at least one flight simulator or advanced flight training device.

[Doc. No. 26933, 61 FR 34562, July 2, 1996, as amended by Amdt. 142-3, 63 FR 53537, Oct. 5, 1998]

**§ 142.17 Satellite training centers.**

(a) The holder of a training center certificate may conduct training in accordance with an approved training program at a satellite training center if—

(1) The facilities, equipment, personnel, and course content of the satellite training center meet the applicable requirements of this part;

(2) The instructors and evaluators at the satellite training center are under the direct supervision of management personnel of the principal training center;

(3) The Administrator is notified in writing that a particular satellite is to begin operations at least 60 days prior to proposed commencement of operations at the satellite training center; and

(4) The certificate holder's training specifications reflect the name and address of the satellite training center and the approved courses offered at the satellite training center.

(b) The certificate holder's training specifications shall prescribe the operations required and authorized at each satellite training center.

[Doc. No. 26933, 61 FR 34562, July 2, 1996, as amended by Amdt. 142-3, 63 FR 53537, Oct. 5, 1998]

**§§ 142.21-142.25 [Reserved]**

**§ 142.27 Display of certificate.**

(a) Each holder of a training center certificate must prominently display that certificate in a place accessible to the public in the principal business office of the training center.

(b) A training center certificate and training specifications must be made available for inspection upon request by—

- (1) The Administrator;
- (2) An authorized representative of the National Transportation Safety Board; or
- (3) Any Federal, State, or local law enforcement agency.

**§ 142.29 Inspections.**

Each certificate holder must allow the Administrator to inspect training center facilities, equipment, and records at any reasonable time and in any reasonable place in order to determine compliance with or to determine initial or continuing eligibility under 49 U.S.C. 44701, 44707, formerly the Federal Aviation Act of 1958, as amended, and the training center's certificate and training specifications.

**§ 142.31 Advertising limitations.**

(a) A certificate holder may not conduct, and may not advertise to conduct, any training, testing, and checking that is not approved by the Administrator if that training is designed to satisfy any requirement of this chapter.

(b) A certificate holder whose certificate has been surrendered, suspended, revoked, or terminated must—

- (1) Promptly remove all indications, including signs, wherever located, that the training center was certificated by the Administrator; and
- (2) Promptly notify all advertising agents, or advertising media, or both, employed by the certificate holder to cease all advertising indicating that

the training center is certificated by the Administrator.

**§ 142.33 Training agreements.**

A pilot school certificated under part 141 of this chapter may provide training, testing, and checking for a training center certificated under this part if—

(a) There is a training, testing, and checking agreement between the certificated training center and the pilot school;

(b) The training, testing, and checking provided by the certificated pilot school is approved and conducted in accordance with this part;

(c) The pilot school certificated under part 141 obtains the Administrator's approval for a training course outline that includes the portion of the training, testing, and checking to be conducted under part 141; and

(d) Upon completion of training, testing, and checking conducted under part 141, a copy of each student's training record is forwarded to the part 142 training center and becomes part of the student's permanent training record.

**Subpart B—Aircrew Curriculum and Syllabus Requirements**

**§ 142.35 Applicability.**

This subpart prescribes the curriculum and syllabus requirements for the issuance of a training center certificate and training specifications for training, testing, and checking conducted to meet the requirements of part 61 of this chapter.

**§ 142.37 Approval of flight aircrew training program.**

(a) Except as provided in paragraph (b) of this section, each applicant for, or holder of, a training center certificate must apply to the Administrator for training program approval.

(b) A curriculum approved under SFAR 58 of part 121 of this chapter is approved under this part without modifications.

(c) Application for training program approval shall be made in a form and in a manner acceptable to the Administrator.

(d) Each application for training program approval must indicate—

## § 142.39

(1) Which courses are part of the core curriculum and which courses are part of the specialty curriculum;

(2) Which requirements of part 61 of this chapter would be satisfied by the curriculum or curriculums; and

(3) Which requirements of part 61 of this chapter would not be satisfied by the curriculum or curriculums.

(e) If, after a certificate holder begins operations under an approved training program, the Administrator finds that the certificate holder is not meeting the provisions of its approved training program, the Administrator may require the certificate holder to make revisions to that training program.

(f) If the Administrator requires a certificate holder to make revisions to an approved training program and the certificate holder does not make those required revisions, within 30 calendar days, the Administrator may suspend, revoke, or terminate the training center certificate under the provisions of § 142.11(e).

### § 142.39 Training program curriculum requirements.

Each training program curriculum submitted to the Administrator for approval must meet the applicable requirements of this part and must contain—

(a) A syllabus for each proposed curriculum;

(b) Minimum aircraft and flight training equipment requirements for each proposed curriculum;

(c) Minimum instructor and evaluator qualifications for each proposed curriculum;

(d) A curriculum for initial training and continuing training of each instructor or evaluator employed to instruct in a proposed curriculum; and

(e) For each curriculum that provides for the issuance of a certificate or rating in fewer than the minimum hours prescribed by part 61 of this chapter—

(1) A means of demonstrating the ability to accomplish such training in the reduced number of hours; and

(2) A means of tracking student performance.

## 14 CFR Ch. I (1–1–08 Edition)

### Subpart C—Personnel and Flight Training Equipment Requirements

#### § 142.45 Applicability.

This subpart prescribes the personnel and flight training equipment requirements for a certificate holder that is training to meet the requirements of part 61 of this chapter.

#### § 142.47 Training center instructor eligibility requirements.

(a) A certificate holder may not employ a person as an instructor in a flight training course that is subject to approval by the Administrator unless that person—

(1) Is at least 18 years of age;

(2) Is able to read, write, and speak and understand in the English language;

(3) If instructing in an aircraft in flight, is qualified in accordance with subpart H of this chapter;

(4) Satisfies the requirements of paragraph (c) of this section; and

(5) Meets at least one of the following requirements—

(i) Except as allowed by paragraph (a)(5)(ii) of this section, meets the aeronautical experience requirements of § 61.129 (a), (b), (c), or (e) of this chapter, as applicable, excluding the required hours of instruction in preparation for the commercial pilot practical test;

(ii) If instructing in flight simulator or flight training device that represents an airplane requiring a type rating or if instructing in a curriculum leading to the issuance of an airline transport pilot certificate or an added rating to an airline transport pilot certificate, meets the aeronautical experience requirements of § 61.159, § 61.161, or § 61.163 of this chapter, as applicable; or

(iii) Is employed as a flight simulator instructor or a flight training device instructor for a training center providing instruction and testing to meet the requirements of part 61 of this chapter on August 1, 1996.

(b) A training center must designate each instructor in writing to instruct in each approved course, prior to that person functioning as an instructor in that course.

(c) Prior to initial designation, each instructor shall:

**Federal Aviation Administration, DOT**

**§ 142.53**

(1) Complete at least 8 hours of ground training on the following subject matter:

- (i) Instruction methods and techniques.
- (ii) Training policies and procedures.
- (iii) The fundamental principles of the learning process.
- (iv) Instructor duties, privileges, responsibilities, and limitations.
- (v) Proper operation of simulation controls and systems.
- (vi) Proper operation of environmental control and warning or caution panels.
- (vii) Limitations of simulation.
- (viii) Minimum equipment requirements for each curriculum.
- (ix) Revisions to the training courses.
- (x) Cockpit resource management and crew coordination.

(2) Satisfactorily complete a written test—

- (i) On the subjects specified in paragraph (c)(1) of this section; and
- (ii) That is accepted by the Administrator as being of equivalent difficulty, complexity, and scope as the tests provided by the Administrator for the flight instructor airplane and instrument flight instructor knowledge tests.

[Doc. No. 26933, 61 FR 34562, July 2, 1996, as amended by Amdt. 142-2, 62 FR 68137, Dec. 30, 1997]

**§ 142.49 Training center instructor and evaluator privileges and limitations.**

(a) A certificate holder may allow an instructor to provide:

- (1) Instruction for each curriculum for which that instructor is qualified.
- (2) Testing and checking for which that instructor is qualified.
- (3) Instruction, testing, and checking intended to satisfy the requirements of any part of this chapter.

(b) A training center whose instructor or evaluator is designated in accordance with the requirements of this subpart to conduct training, testing, or checking in qualified and approved flight training equipment, may allow its instructor or evaluator to give endorsements required by part 61 of this chapter if that instructor or evaluator is authorized by the Administrator to instruct or evaluate in a part 142 cur-

riculum that requires such endorsements.

(c) A training center may not allow an instructor to—

- (1) Excluding briefings and debriefings, conduct more than 8 hours of instruction in any 24-consecutive-hour period;
- (2) Provide flight training equipment instruction unless that instructor meets the requirements of §142.53 (a)(1) through (a)(4), and §142.53(b), as applicable; or
- (3) Provide flight instruction in an aircraft unless that instructor—
  - (i) Meets the requirements of §142.53(a)(1), (a)(2), and (a)(5);
  - (ii) Is qualified and authorized in accordance with subpart H of part 61 of this chapter;
  - (iii) Holds certificates and ratings specified by part 61 of this chapter appropriate to the category, class, and type aircraft in which instructing;
  - (iv) If instructing or evaluating in an aircraft in flight while occupying a required crewmember seat, holds at least a valid second class medical certificate; and
  - (v) Meets the recency of experience requirements of part 61 of this chapter.

[Doc. No. 26933, 61 FR 34562, July 2, 1996, as amended by Amdt. 142-2, 62 FR 68137, Dec. 30, 1997]

**§ 142.51 [Reserved]**

**§ 142.53 Training center instructor training and testing requirements.**

(a) Except as provided in paragraph (c) of this section, prior to designation and every 12 calendar months beginning the first day of the month following an instructor's initial designation, a certificate holder must ensure that each of its instructors meets the following requirements:

- (1) Each instructor must satisfactorily demonstrate to an authorized evaluator knowledge of, and proficiency in, instructing in a representative segment of each curriculum for which that instructor is designated to instruct under this part.
- (2) Each instructor must satisfactorily complete an approved course of ground instruction in at least—
  - (i) The fundamental principles of the learning process;

- (ii) Elements of effective teaching, instruction methods, and techniques;
- (iii) Instructor duties, privileges, responsibilities, and limitations;
- (iv) Training policies and procedures;
- (v) Cockpit resource management and crew coordination; and
- (vi) Evaluation.

(3) Each instructor who instructs in a qualified and approved flight simulator or flight training device must satisfactorily complete an approved course of training in the operation of the flight simulator, and an approved course of ground instruction, applicable to the training courses the instructor is designated to instruct.

(4) The flight simulator training course required by paragraph (a)(3) of this section which must include—

- (i) Proper operation of flight simulator and flight training device controls and systems;
- (ii) Proper operation of environmental and fault panels;
- (iii) Limitations of simulation; and
- (iv) Minimum equipment requirements for each curriculum.

(5) Each flight instructor who provides training in an aircraft must satisfactorily complete an approved course of ground instruction and flight training in an aircraft, flight simulator, or flight training device.

(6) The approved course of ground instruction and flight training required by paragraph (a)(5) of this section which must include instruction in—

- (i) Performance and analysis of flight training procedures and maneuvers applicable to the training courses that the instructor is designated to instruct;
- (ii) Technical subjects covering aircraft subsystems and operating rules applicable to the training courses that the instructor is designated to instruct;
- (iii) Emergency operations;
- (iv) Emergency situations likely to develop during training; and
- (v) Appropriate safety measures.

(7) Each instructor who instructs in qualified and approved flight training equipment must pass a written test and annual proficiency check—

- (i) In the flight training equipment in which the instructor will be instructing; and

(ii) On the subject matter and maneuvers of a representative segment of each curriculum for which the instructor will be instructing.

(b) In addition to the requirements of paragraphs (a)(1) through (a)(7) of this section, each certificate holder must ensure that each instructor who instructs in a flight simulator that the Administrator has approved for all training and all testing for the airline transport pilot certification test, aircraft type rating test, or both, has met at least one of the following three requirements:

(1) Each instructor must have performed 2 hours in flight, including three takeoffs and three landings as the sole manipulator of the controls of an aircraft of the same category and class, and, if a type rating is required, of the same type replicated by the approved flight simulator in which that instructor is designated to instruct;

(2) Each instructor must have participated in an approved line-observation program under part 121 or part 135 of this chapter, and that—

(i) Was accomplished in the same airplane type as the airplane represented by the flight simulator in which that instructor is designated to instruct; and

(ii) Included line-oriented flight training of at least 1 hour of flight during which the instructor was the sole manipulator of the controls in a flight simulator that replicated the same type aircraft for which that instructor is designated to instruct; or

(3) Each instructor must have participated in an approved in-flight observation training course that—

(i) Consisted of at least 2 hours of flight time in an airplane of the same type as the airplane replicated by the flight simulator in which the instructor is designated to instruct; and

(ii) Included line-oriented flight training of at least 1 hour of flight during which the instructor was the sole manipulator of the controls in a flight simulator that replicated the same type aircraft for which that instructor is designated to instruct.

(c) An instructor who satisfactorily completes a curriculum required by paragraph (a) or (b) of this section in the calendar month before or after the

month in which it is due is considered to have taken it in the month in which it was due for the purpose of computing when the next training is due.

(d) The Administrator may give credit for the requirements of paragraph (a) or (b) of this section to an instructor who has satisfactorily completed an instructor training course for a part 121 or part 135 certificate holder if the Administrator finds such a course equivalent to the requirements of paragraph (a) or (b) of this section.

[Doc. No. 26933, 61 FR 34562, July 2, 1996, as amended by Amdt. 142-1, 62 FR 13791, Mar. 21, 1997]

**§ 142.55 Training center evaluator requirements.**

(a) Except as provided by paragraph (d) of this section, a training center must ensure that each person authorized as an evaluator—

- (1) Is approved by the Administrator;
- (2) Is in compliance with §§ 142.47, 142.49, and 142.53 and applicable sections of part 187 of this chapter; and
- (3) Prior to designation, and except as provided in paragraph (b) of this section, every 12-calendar-month period following initial designation, the certificate holder must ensure that the evaluator satisfactorily completes a curriculum that includes the following:
  - (i) Evaluator duties, functions, and responsibilities;
  - (ii) Methods, procedures, and techniques for conducting required tests and checks;
  - (iii) Evaluation of pilot performance; and
  - (iv) Management of unsatisfactory tests and subsequent corrective action; and
- (4) If evaluating in qualified and approved flight training equipment must satisfactorily pass a written test and annual proficiency check in a flight simulator or aircraft in which the evaluator will be evaluating.

(b) An evaluator who satisfactorily completes a curriculum required by paragraph (a) of this section in the calendar month before or the calendar month after the month in which it is due is considered to have taken it in the month in which it was due for the purpose of computing when the next training is due.

(c) The Administrator may give credit for the requirements of paragraph (a)(3) of this section to an evaluator who has satisfactorily completed an evaluator training course for a part 121 or part 135 certificate holder if the Administrator finds such a course equivalent to the requirements of paragraph (a)(3) of this section.

(d) An evaluator who is qualified under SFAR 58 shall be authorized to conduct evaluations under the Advanced Qualification Program without complying with the requirements of this section.

**§ 142.57 Aircraft requirements.**

(a) An applicant for, or holder of, a training center certificate must ensure that each aircraft used for flight instruction and solo flights meets the following requirements:

- (1) Except for flight instruction and solo flights in a curriculum for agricultural aircraft operations, external load operations, and similar aerial work operations, the aircraft must have an FAA standard airworthiness certificate or a foreign equivalent of an FAA standard airworthiness certificate, acceptable to the Administrator.
- (2) The aircraft must be maintained and inspected in accordance with—
  - (i) The requirements of part 91, subpart E, of this chapter; and
  - (ii) An approved program for maintenance and inspection.
- (3) The aircraft must be equipped as provided in the training specifications for the approved course for which it is used.

(b) Except as provided in paragraph (c) of this section, an applicant for, or holder of, a training center certificate must ensure that each aircraft used for flight instruction is at least a two-place aircraft with engine power controls and flight controls that are easily reached and that operate in a conventional manner from both pilot stations.

(c) Airplanes with controls such as nose-wheel steering, switches, fuel selectors, and engine air flow controls that are not easily reached and operated in a conventional manner by both pilots may be used for flight instruction if the certificate holder determines that the flight instruction can

## § 142.59

be conducted in a safe manner considering the location of controls and their nonconventional operation, or both.

### § 142.59 Flight simulators and flight training devices.

(a) An applicant for, or holder of, a training center certificate must show that each flight simulator and flight training device used for training, testing, and checking (except AQP) will be or is specifically qualified and approved by the Administrator for—

(1) Each maneuver and procedure for the make, model, and series of aircraft, set of aircraft, or aircraft type simulated, as applicable; and

(2) Each curriculum or training course in which the flight simulator or flight training device is used, if that curriculum or course is used to satisfy any requirement of 14 CFR chapter I.

(b) The approval required by paragraph (a)(2) of this section must include—

(1) The set of aircraft, or type aircraft;

(2) If applicable, the particular variation within type, for which the training, testing, or checking is being conducted; and

(3) The particular maneuver, procedure, or crewmember function to be performed.

(c) Each qualified and approved flight simulator or flight training device used by a training center must—

(1) Be maintained to ensure the reliability of the performances, functions, and all other characteristics that were required for qualification;

(2) Be modified to conform with any modification to the aircraft being simulated if the modification results in changes to performance, function, or other characteristics required for qualification;

(3) Be given a functional preflight check each day before being used; and

(4) Have a discrepancy log in which the instructor or evaluator, at the end of each training session, enters each discrepancy.

(d) Unless otherwise authorized by the Administrator, each component on a qualified and approved flight simulator or flight training device used by a training center must be operative if the component is essential to, or in-

## 14 CFR Ch. I (1–1–08 Edition)

involved in, the training, testing, or checking of airmen.

(e) Training centers shall not be restricted to specific—

(1) Route segments during line-oriented flight training scenarios; and

(2) Visual data bases replicating a specific customer's bases of operation.

(f) Training centers may request evaluation, qualification, and continuing evaluation for qualification of flight simulators and flight training devices without—

(1) Holding an air carrier certificate; or

(2) Having a specific relationship to an air carrier certificate holder.

### Subpart D—Operating Rules

#### § 142.61 Applicability.

This subpart prescribes the operating rules applicable to a training center certificated under this part and operating a course or training program curriculum approved in accordance with subpart B of this part.

#### § 142.63 Privileges.

A certificate holder may allow flight simulator instructors and evaluators to meet recency of experience requirements through the use of a qualified and approved flight simulator or qualified and approved flight training device if that flight simulator or flight training device is—

(a) Used in a course approved in accordance with subpart B of this part; or

(b) Approved under the Advanced Qualification Program for meeting recency of experience requirements.

#### § 142.65 Limitations.

(a) A certificate holder shall—

(1) Ensure that a flight simulator or flight training device freeze, slow motion, or repositioning feature is not used during testing or checking; and

(2) Ensure that a repositioning feature is used during line operational simulation for evaluation and line-oriented flight training only to advance along a flight route to the point where the descent and approach phase of the flight begins.

(b) When flight testing, flight checking, or line operational simulation is being conducted, the certificate holder

must ensure that one of the following occupies each crewmember position:

(1) A crewmember qualified in the aircraft category, class, and type, if a type rating is required, provided that no flight instructor who is giving instruction may occupy a crewmember position.

(2) A student, provided that no student may be used in a crewmember position with any other student not in the same specific course.

(c) The holder of a training center certificate may not recommend a trainee for a certificate or rating, unless the trainee—

(1) Has satisfactorily completed the training specified in the course approved under §142.37; and

(2) Has passed the final tests required by §142.37.

(d) The holder of a training center certificate may not graduate a student from a course unless the student has satisfactorily completed the curriculum requirements of that course.

### Subpart E—Recordkeeping

#### § 142.71 Applicability.

This subpart prescribes the training center recordkeeping requirements for trainees enrolled in a course, and instructors and evaluators designated to instruct a course, approved in accordance with subpart B of this part.

#### § 142.73 Recordkeeping requirements.

(a) A certificate holder must maintain a record for each trainee that contains—

(1) The name of the trainee;

(2) A copy of the trainee's pilot certificate, if any, and medical certificate;

(3) The name of the course and the make and model of flight training equipment used;

(4) The trainee's prerequisite experience and course time completed;

(5) The trainee's performance on each lesson and the name of the instructor providing instruction;

(6) The date and result of each end-of-course practical test and the name of the evaluator conducting the test; and

(7) The number of hours of additional training that was accomplished after any unsatisfactory practical test.

(b) A certificate holder shall maintain a record for each instructor or evaluator designated to instruct a course approved in accordance with subpart B of this part that indicates that the instructor or evaluator has complied with the requirements of §§142.13, 142.45, 142.47, 142.49, and 142.53, as applicable.

(c) The certificate holder shall—

(1) Maintain the records required by paragraphs (a) of this section for at least 1 year following the completion of training, testing or checking;

(2) Maintain the qualification records required by paragraph (b) of this section while the instructor or evaluator is in the employ of the certificate holder and for 1 year thereafter; and

(3) Maintain the recurrent demonstration of proficiency records required by paragraph (b) of this section for at least 1 year.

(d) The certificate holder must provide the records required by this section to the Administrator, upon request and at a reasonable time, and shall keep the records required by—

(1) Paragraph (a) of this section at the training center, or satellite training center where the training, testing, or checking, if appropriate, occurred; and

(2) Paragraph (b) of this section at the training center or satellite training center where the instructor or evaluator is primarily employed.

(e) The certificate holder shall provide to a trainee, upon request and at a reasonable time, a copy of his or her training records.

### Subpart F—Other Approved Courses

#### § 142.81 Conduct of other approved courses.

(a) An applicant for, or holder of, a training center certificate may apply for approval to conduct a course for which a curriculum is not prescribed by this part.

(b) The course for which application is made under paragraph (a) of this section may be for flight crewmembers other than pilots, airmen other than flight crewmembers, material handlers,

**Pt. 145**

ground servicing personnel, and security personnel, and others approved by the Administrator.

(c) An applicant for course approval under this subpart must comply with the applicable requirements of subpart A through subpart F of this part.

(d) The Administrator approves the course for which the application is made if the training center or training center applicant shows that the course contains a curriculum that will achieve a level of competency equal to, or greater than, that required by the appropriate part of this chapter.

**PART 143 [RESERVED]**

**PART 145—REPAIR STATIONS**

SPECIAL FEDERAL AVIATION REGULATION NO. 36 [NOTE]

**Subpart A—General**

Sec.

- 145.1 Applicability.
- 145.3 Definition of terms.
- 145.5 Certificate and operations specifications requirements.

**Subpart B—Certification**

- 145.51 Application for certificate.
- 145.53 Issue of certificate.
- 145.55 Duration and renewal of certificate.
- 145.57 Amendment to or transfer of certificate.
- 145.59 Ratings.
- 145.61 Limited ratings.

**Subpart C—Housing, Facilities, Equipment, Materials, and Data**

- 145.101 General.
- 145.103 Housing and facilities requirements.
- 145.105 Change of location, housing, or facilities.
- 145.107 Satellite repair stations.
- 145.109 Equipment, materials, and data requirements.

**Subpart D—Personnel**

- 145.151 Personnel requirements.
- 145.153 Supervisory personnel requirements.
- 145.155 Inspection personnel requirements.
- 145.157 Personnel authorized to approve an article for return to service.
- 145.159 Recommendation of a person for certification as a repairman.
- 145.161 Records of management, supervisory, and inspection personnel.
- 145.163 Training requirements.

**14 CFR Ch. I (1–1–08 Edition)**

- 145.165 Hazardous materials training.

**Subpart E—Operating Rules**

- 145.201 Privileges and limitations of certificate.
- 145.203 Work performed at another location.
- 145.205 Maintenance, preventive maintenance, and alterations performed for certificate holders under parts 121, 125, and 135, and for foreign air carriers or foreign persons operating a U.S.-registered aircraft in common carriage under part 129.
- 145.206 Notification of hazardous materials authorizations.
- 145.207 Repair station manual.
- 145.209 Repair station manual contents.
- 145.211 Quality control system.
- 145.213 Inspection of maintenance, preventive maintenance, or alterations.
- 145.215 Capability list.
- 145.217 Contract maintenance.
- 145.219 Recordkeeping.
- 145.221 Service difficulty reports.
- 145.223 FAA inspections.

AUTHORITY: 49 U.S.C. 106(g), 40113, 44701–44702, 44707, 44709, 44717.

SPECIAL FEDERAL AVIATION REGULATION No. 36

EDITORIAL NOTE: For the text of SFAR No. 36, see part 121 of this chapter.

**Subpart A—General**

SOURCE: Docket No. FAA–1999–5836, 66 FR 41117, Aug. 6, 2001, unless otherwise noted.

**§ 145.1 Applicability.**

This part describes how to obtain a repair station certificate. This part also contains the rules a certificated repair station must follow related to its performance of maintenance, preventive maintenance, or alterations of an aircraft, airframe, aircraft engine, propeller, appliance, or component part to which part 43 applies. It also applies to any person who holds, or is required to hold, a repair station certificate issued under this part.

**§ 145.3 Definition of terms.**

For the purposes of this part, the following definitions apply:

- (a) *Accountable manager* means the person designated by the certificated repair station who is responsible for and has the authority over all repair station operations that are conducted under part 145, including ensuring that

repair station personnel follow the regulations and serving as the primary contact with the FAA.

(b) *Article* means an aircraft, airframe, aircraft engine, propeller, appliance, or component part.

(c) *Directly in charge* means having the responsibility for the work of a certificated repair station that performs maintenance, preventive maintenance, alterations, or other functions affecting aircraft airworthiness. A person directly in charge does not need to physically observe and direct each worker constantly but must be available for consultation on matters requiring instruction or decision from higher authority.

(d) *Line maintenance means*—

(1) Any unscheduled maintenance resulting from unforeseen events; or

(2) Scheduled checks that contain servicing and/or inspections that do not require specialized training, equipment, or facilities.

#### § 145.5 Certificate and operations specifications requirements.

(a) No person may operate as a certificated repair station without, or in violation of, a repair station certificate, ratings, or operations specifications issued under this part.

(b) The certificate and operations specifications issued to a certificated repair station must be available on the premises for inspection by the public and the FAA.

### Subpart B—Certification

SOURCE: Docket No. FAA-1999-5836, 66 FR 41117, Aug. 6, 2001, unless otherwise noted.

#### § 145.51 Application for certificate.

(a) An application for a repair station certificate and rating must be made in a format acceptable to the FAA and must include the following:

(1) A repair station manual acceptable to the FAA as required by § 145.207;

(2) A quality control manual acceptable to the FAA as required by § 145.211(c);

(3) A list by type, make, or model, as appropriate, of each article for which the application is made;

(4) An organizational chart of the repair station and the names and titles of managing and supervisory personnel;

(5) A description of the housing and facilities, including the physical address, in accordance with § 145.103;

(6) A list of the maintenance functions, for approval by the FAA, to be performed for the repair station under contract by another person in accordance with § 145.217; and

(7) A training program for approval by the FAA in accordance with § 145.163.

(b) The equipment, personnel, technical data, and housing and facilities required for the certificate and rating, or for an additional rating must be in place for inspection at the time of certification or rating approval by the FAA. An applicant may meet the equipment requirement of this paragraph if the applicant has a contract acceptable to the FAA with another person to make the equipment available to the applicant at the time of certification and at any time that it is necessary when the relevant work is being performed by the repair station.

(c) In addition to meeting the other applicable requirements for a repair station certificate and rating, an applicant for a repair station certificate and rating located outside the United States must meet the following requirements:

(1) The applicant must show that the repair station certificate and/or rating is necessary for maintaining or altering the following:

(i) U.S.-registered aircraft and articles for use on U.S.-registered aircraft, or

(ii) Foreign-registered aircraft operated under the provisions of part 121 or part 135, and articles for use on these aircraft.

(2) The applicant must show that the fee prescribed by the FAA has been paid.

(d) An application for an additional rating, amended repair station certificate, or renewal of a repair station certificate must be made in a format acceptable to the FAA. The application must include only that information necessary to substantiate the change or renewal of the certificate.

**§ 145.53**

**14 CFR Ch. I (1–1–08 Edition)**

**§ 145.53 Issue of certificate.**

(a) Except as provided in paragraph (b), (c), or (d) of this section, a person who meets the requirements of this part is entitled to a repair station certificate with appropriate ratings prescribing such operations specifications and limitations as are necessary in the interest of safety.

(b) If the person is located in a country with which the United States has a bilateral aviation safety agreement, the FAA may find that the person meets the requirements of this part based on a certification from the civil aviation authority of that country. This certification must be made in accordance with implementation procedures signed by the Administrator or the Administrator's designee.

(c) Before a repair station certificate can be issued for a repair station that is located within the United States, the applicant shall certify in writing that all "hazmat employees" (see 49 CFR 171.8) for the repair station, its contractors, or subcontractors are trained as required in 49 CFR part 172 subpart H.

(d) Before a repair station certificate can be issued for a repair station that is located outside the United States, the applicant shall certify in writing that all employees for the repair station, its contractors, or subcontractors performing a job function concerning the transport of dangerous goods (hazardous material) are trained as outlined in the most current edition of the International Civil Aviation Organization Technical Instructions for the Safe Transport of Dangerous Goods by Air.

[Doc. No. FAA–2003–15085, 70 FR 58831, Oct. 7, 2005]

**§ 145.55 Duration and renewal of certificate.**

(a) A certificate or rating issued to a repair station located in the United States is effective from the date of issue until the repair station surrenders it or the FAA suspends or revokes it.

(b) A certificate or rating issued to a repair station located outside the United States is effective from the date of issue until the last day of the 12th

month after the date of issue unless the repair station surrenders the certificate or the FAA suspends or revokes it. The FAA may renew the certificate or rating for 24 months if the repair station has operated in compliance with the applicable requirements of part 145 within the preceding certificate duration period.

(c) A certificated repair station located outside the United States that applies for a renewal of its repair station certificate must—

(1) Submit its request for renewal no later than 30 days before the repair station's current certificate expires. If a request for renewal is not made within this period, the repair station must follow the application procedures in §145.51.

(2) Send its request for renewal to the FAA office that has jurisdiction over the certificated repair station.

(d) The holder of an expired, surrendered, suspended, or revoked certificate must return it to the FAA.

**§ 145.57 Amendment to or transfer of certificate.**

(a) The holder of a repair station certificate must apply for a change to its certificate in a format acceptable to the Administrator. A change to the certificate must include certification in compliance with §145.53(c) or (d), if not previously submitted. A certificate change is necessary if the certificate holder—

(1) Changes the location of the repair station, or

(2) Requests to add or amend a rating.

(b) If the holder of a repair station certificate sells or transfers its assets, the new owner must apply for an amended certificate in accordance with §145.51.

[Doc. No. FAA–1999–5836, 66 FR 41117, Aug. 6, 2001, as amended by Amdt. 145–24, 70 FR 58831, Oct. 7, 2005]

**§ 145.59 Ratings.**

The following ratings are issued under this subpart:

(a) *Airframe ratings.*

(1) *Class 1:* Composite construction of small aircraft.

(2) *Class 2:* Composite construction of large aircraft.

(3) *Class 3*: All-metal construction of small aircraft.

(4) *Class 4*: All-metal construction of large aircraft.

(b) *Powerplant ratings*.

(1) *Class 1*: Reciprocating engines of 400 horsepower or less.

(2) *Class 2*: Reciprocating engines of more than 400 horsepower.

(3) *Class 3*: Turbine engines.

(c) *Propeller ratings*.

(1) *Class 1*: Fixed-pitch and ground-adjustable propellers of wood, metal, or composite construction.

(2) *Class 2*: Other propellers, by make.

(d) *Radio ratings*.

(1) *Class 1*: Communication equipment. Radio transmitting and/or receiving equipment used in an aircraft to send or receive communications in flight, regardless of carrier frequency or type of modulation used. This equipment includes auxiliary and related aircraft interphone systems, amplifier systems, electrical or electronic intercrew signaling devices, and similar equipment. This equipment does not include equipment used for navigating or aiding navigation of aircraft, equipment used for measuring altitude or terrain clearance, other measuring equipment operated on radio or radar principles, or mechanical, electrical, gyroscopic, or electronic instruments that are a part of communications radio equipment.

(2) *Class 2*: Navigational equipment. A radio system used in an aircraft for en route or approach navigation. This does not include equipment operated on radar or pulsed radio frequency principles, or equipment used for measuring altitude or terrain clearance.

(3) *Class 3*: Radar equipment. An aircraft electronic system operated on radar or pulsed radio frequency principles.

(e) *Instrument ratings*.

(1) *Class 1*: Mechanical. A diaphragm, bourdon tube, aneroid, optical, or mechanically driven centrifugal instrument used on aircraft or to operate aircraft, including tachometers, airspeed indicators, pressure gauges drift sights, magnetic compasses, altimeters, or similar mechanical instruments.

(2) *Class 2*: Electrical. Self-synchronous and electrical-indicating instruments and systems, including re-

mote indicating instruments, cylinder head temperature gauges, or similar electrical instruments.

(3) *Class 3*: Gyroscopic. An instrument or system using gyroscopic principles and motivated by air pressure or electrical energy, including automatic pilot control units, turn and bank indicators, directional gyros, and their parts, and flux gate and gyrosyn compasses.

(4) *Class 4*: Electronic. An instrument whose operation depends on electron tubes, transistors, or similar devices, including capacitance type quantity gauges, system amplifiers, and engine analyzers.

(f) *Accessory ratings*.

(1) *Class 1*: A mechanical accessory that depends on friction, hydraulics, mechanical linkage, or pneumatic pressure for operation, including aircraft wheel brakes, mechanically driven pumps, carburetors, aircraft wheel assemblies, shock absorber struts and hydraulic servo units.

(2) *Class 2*: An electrical accessory that depends on electrical energy for its operation, and a generator, including starters, voltage regulators, electric motors, electrically driven fuel pumps magnetos, or similar electrical accessories.

(3) *Class 3*: An electronic accessory that depends on the use of an electron tube transistor, or similar device, including supercharger, temperature, air conditioning controls, or similar electronic controls.

#### § 145.61 Limited ratings.

(a) The FAA may issue a limited rating to a certificated repair station that maintains or alters only a particular type of airframe, powerplant, propeller, radio, instrument, or accessory, or part thereof, or performs only specialized maintenance requiring equipment and skills not ordinarily performed under other repair station ratings. Such a rating may be limited to a specific model aircraft, engine, or constituent part, or to any number of parts made by a particular manufacturer.

(b) The FAA issues limited ratings for—

(1) Airframes of a particular make and model;

**§ 145.101**

**14 CFR Ch. I (1–1–08 Edition)**

- (2) Engines of a particular make and model;
- (3) Propellers of a particular make and model;
- (4) Instruments of a particular make and model;
- (5) Radio equipment of a particular make and model;
- (6) Accessories of a particular make and model;
- (7) Landing gear components;
- (8) Floats, by make;
- (9) Nondestructive inspection, testing, and processing;
- (10) Emergency equipment;
- (11) Rotor blades, by make and model; and
- (12) Aircraft fabric work.

(c) For a limited rating for specialized services, the operations specifications of the repair station must contain the specification used to perform the specialized service. The specification may be—

- (1) A civil or military specification currently used by industry and approved by the FAA, or
- (2) A specification developed by the applicant and approved by the FAA.

**Subpart C—Housing, Facilities, Equipment, Materials, and Data**

SOURCE: Docket No. FAA-1999-5836, 66 FR 41117, Aug. 6, 2001, unless otherwise noted.

**§ 145.101 General.**

A certificated repair station must provide housing, facilities, equipment, materials, and data that meet the applicable requirements for the issuance of the certificate and ratings the repair station holds.

**§ 145.103 Housing and facilities requirements.**

- (a) Each certificated repair station must provide—
  - (1) Housing for the facilities, equipment, materials, and personnel consistent with its ratings.
  - (2) Facilities for properly performing the maintenance, preventive maintenance, or alterations of articles or the specialized services for which it is rated. Facilities must include the following:
    - (i) Sufficient work space and areas for the proper segregation and protec-

tion of articles during all maintenance, preventive maintenance, or alterations;

- (ii) Segregated work areas enabling environmentally hazardous or sensitive operations such as painting, cleaning, welding, avionics work, electronic work, and machining to be done properly and in a manner that does not adversely affect other maintenance or alteration articles or activities;

- (iii) Suitable racks, hoists, trays, stands, and other segregation means for the storage and protection of all articles undergoing maintenance, preventive maintenance, or alterations;

- (iv) Space sufficient to segregate articles and materials stocked for installation from those articles undergoing maintenance, preventive maintenance, or alterations; and

- (v) Ventilation, lighting, and control of temperature, humidity, and other climatic conditions sufficient to ensure personnel perform maintenance, preventive maintenance, or alterations to the standards required by this part.

- (b) A certificated repair station with an airframe rating must provide suitable permanent housing to enclose the largest type and model of aircraft listed on its operations specifications.

- (c) A certificated repair station may perform maintenance, preventive maintenance, or alterations on articles outside of its housing if it provides suitable facilities that are acceptable to the FAA and meet the requirements of §145.103(a) so that the work can be done in accordance with the requirements of part 43 of this chapter.

**§ 145.105 Change of location, housing, or facilities.**

- (a) A certificated repair station may not change the location of its housing without written approval from the FAA.

- (b) A certificated repair station may not make any changes to its housing or facilities required by §145.103 that could have a significant effect on its ability to perform the maintenance, preventive maintenance, or alterations under its repair station certificate and operations specifications without written approval from the FAA.

- (c) The FAA may prescribe the conditions, including any limitations, under

which a certificated repair station must operate while it is changing its location, housing, or facilities.

**§ 145.107 Satellite repair stations.**

(a) A certificated repair station under the managerial control of another certificated repair station may operate as a satellite repair station with its own certificate issued by the FAA. A satellite repair station—

(1) May not hold a rating not held by the certificated repair station with managerial control;

(2) Must meet the requirements for each rating it holds;

(3) Must submit a repair station manual acceptable to the FAA as required by § 145.207; and

(4) Must submit a quality control manual acceptable to the FAA as required by § 145.211(c).

(b) Unless the FAA indicates otherwise, personnel and equipment from the certificated repair station with managerial control and from each of the satellite repair stations may be shared. However, inspection personnel must be designated for each satellite repair station and available at the satellite repair station any time a determination of airworthiness or return to service is made. In other circumstances, inspection personnel may be away from the premises but must be available by telephone, radio, or other electronic means.

(c) A satellite repair station may not be located in a country other than the domicile country of the certificated repair station with managerial control.

**§ 145.109 Equipment, materials, and data requirements.**

(a) Except as otherwise prescribed by the FAA, a certificated repair station must have the equipment, tools, and materials necessary to perform the maintenance, preventive maintenance, or alterations under its repair station certificate and operations specifications in accordance with part 43. The equipment, tools, and material must be located on the premises and under the repair station's control when the work is being done.

(b) A certificated repair station must ensure all test and inspection equipment and tools used to make air-

worthiness determinations on articles are calibrated to a standard acceptable to the FAA.

(c) The equipment, tools, and material must be those recommended by the manufacturer of the article or must be at least equivalent to those recommended by the manufacturer and acceptable to the FAA.

(d) A certificated repair station must maintain, in a format acceptable to the FAA, the documents and data required for the performance of maintenance, preventive maintenance, or alterations under its repair station certificate and operations specifications in accordance with part 43. The following documents and data must be current and accessible when the relevant work is being done:

(1) Airworthiness directives,

(2) Instructions for continued airworthiness,

(3) Maintenance manuals,

(4) Overhaul manuals,

(5) Standard practice manuals,

(6) Service bulletins, and

(7) Other applicable data acceptable to or approved by the FAA.

**Subpart D—Personnel**

SOURCE: Docket No. FAA-1999-5836, 66 FR 41117, Aug. 6, 2001, unless otherwise noted.

**§ 145.151 Personnel requirements.**

Each certificated repair station must—

(a) Designate a repair station employee as the accountable manager;

(b) Provide qualified personnel to plan, supervise, perform, and approve for return to service the maintenance, preventive maintenance, or alterations performed under the repair station certificate and operations specifications;

(c) Ensure it has a sufficient number of employees with the training or knowledge and experience in the performance of maintenance, preventive maintenance, or alterations authorized by the repair station certificate and operations specifications to ensure all work is performed in accordance with part 43; and

(d) Determine the abilities of its non-certificated employees performing

**§ 145.153**

maintenance functions based on training, knowledge, experience, or practical tests.

**§ 145.153 Supervisory personnel requirements.**

(a) A certificated repair station must ensure it has a sufficient number of supervisors to direct the work performed under the repair station certificate and operations specifications. The supervisors must oversee the work performed by any individuals who are unfamiliar with the methods, techniques, practices, aids, equipment, and tools used to perform the maintenance, preventive maintenance, or alterations.

(b) Each supervisor must—

(1) If employed by a repair station located inside the United States, be certificated under part 65.

(2) If employed by a repair station located outside the United States—

(i) Have a minimum of 18 months of practical experience in the work being performed; or

(ii) Be trained in or thoroughly familiar with the methods, techniques, practices, aids, equipment, and tools used to perform the maintenance, preventive maintenance, or alterations.

(c) A certificated repair station must ensure its supervisors understand, read, and write English.

**§ 145.155 Inspection personnel requirements.**

(a) A certificated repair station must ensure that persons performing inspections under the repair station certificate and operations specifications are—

(1) Thoroughly familiar with the applicable regulations in this chapter and with the inspection methods, techniques, practices, aids, equipment, and tools used to determine the airworthiness of the article on which maintenance, preventive maintenance, or alterations are being performed; and

(2) Proficient in using the various types of inspection equipment and visual inspection aids appropriate for the article being inspected; and

(b) A certificated repair station must ensure its inspectors understand, read, and write English.

**14 CFR Ch. I (1–1–08 Edition)**

**§ 145.157 Personnel authorized to approve an article for return to service.**

(a) A certificated repair station located inside the United States must ensure each person authorized to approve an article for return to service under the repair station certificate and operations specifications is certificated under part 65.

(b) A certificated repair station located outside the United States must ensure each person authorized to approve an article for return to service under the repair station certificate and operations specifications is—

(1) Trained in or has 18 months practical experience with the methods, techniques, practices, aids, equipment, and tools used to perform the maintenance, preventive maintenance, or alterations; and

(2) Thoroughly familiar with the applicable regulations in this chapter and proficient in the use of the various inspection methods, techniques, practices, aids, equipment, and tools appropriate for the work being performed and approved for return to service.

(c) A certificated repair station must ensure each person authorized to approve an article for return to service understands, reads, and writes English.

**§ 145.159 Recommendation of a person for certification as a repairman.**

A certificated repair station that chooses to use repairmen to meet the applicable personnel requirements of this part must certify in a format acceptable to the FAA that each person recommended for certification as a repairman—

(a) Is employed by the repair station, and

(b) Meets the eligibility requirements of § 65.101.

**§ 145.161 Records of management, supervisory, and inspection personnel.**

(a) A certificated repair station must maintain and make available in a format acceptable to the FAA the following:

(1) A roster of management and supervisory personnel that includes the names of the repair station officials

**Federal Aviation Administration, DOT**

**§ 145.201**

who are responsible for its management and the names of its supervisors who oversee maintenance functions.

(2) A roster with the names of all inspection personnel.

(3) A roster of personnel authorized to sign a maintenance release for approving a maintained or altered article for return to service.

(4) A summary of the employment of each individual whose name is on the personnel rosters required by paragraphs (a)(1) through (a)(3) of this section. The summary must contain enough information on each individual listed on the roster to show compliance with the experience requirements of this part and must include the following:

- (i) Present title,
- (ii) Total years of experience and the type of maintenance work performed,
- (iii) Past relevant employment with names of employers and periods of employment,
- (iv) Scope of present employment, and
- (v) The type of mechanic or repairman certificate held and the ratings on that certificate, if applicable.

(b) Within 5 business days of the change, the rosters required by this section must reflect changes caused by termination, reassignment, change in duties or scope of assignment, or addition of personnel.

**§ 145.163 Training requirements.**

(a) A certificated repair station must have an employee training program approved by the FAA that consists of initial and recurrent training. For purposes of meeting the requirements of this paragraph, beginning April 6, 2006—

(1) An applicant for a repair station certificate must submit a training program for approval by the FAA as required by §145.51(a)(7).

(2) A repair station certificated before that date must submit its training program to the FAA for approval by the last day of the month in which its repair station certificate was issued.

(b) The training program must ensure each employee assigned to perform maintenance, preventive maintenance, or alterations, and inspection

functions is capable of performing the assigned task.

(c) A certificated repair station must document, in a format acceptable to the FAA, the individual employee training required under paragraph (a) of this section. These training records must be retained for a minimum of 2 years.

(d) A certificated repair station must submit revisions to its training program to its certificate holding district office in accordance with the procedures required by §145.209(e).

[Docket No. FAA-1999-5836, 66 FR 41117, Aug. 6, 2001, as amended at 70 FR 15581, Mar. 28, 2005]

**§ 145.165 Hazardous materials training.**

(a) Each repair station that meets the definition of a hazmat employer under 49 CFR 171.8 must have a hazardous materials training program that meets the training requirements of 49 CFR part 172 subpart H.

(b) A repair station employee may not perform or directly supervise a job function listed in §121.1001 or §135.501 for, or on behalf of the part 121 or 135 operator including loading of items for transport on an aircraft operated by a part 121 or part 135 certificate holder unless that person has received training in accordance with the part 121 or part 135 operator's FAA approved hazardous materials training program.

[Doc. No. FAA-2003-15085, 70 FR 58831, Oct. 7, 2005]

**Subpart E—Operating Rules**

SOURCE: Docket No. FAA-1999-5836, 66 FR 41117, Aug. 6, 2001, unless otherwise noted.

**§ 145.201 Privileges and limitations of certificate.**

(a) A certificated repair station may—

(1) Perform maintenance, preventive maintenance, or alterations in accordance with part 43 on any article for which it is rated and within the limitations in its operations specifications.

(2) Arrange for another person to perform the maintenance, preventive maintenance, or alterations of any article for which the certificated repair

## § 145.203

station is rated. If that person is not certificated under part 145, the certificated repair station must ensure that the noncertificated person follows a quality control system equivalent to the system followed by the certificated repair station.

(3) Approve for return to service any article for which it is rated after it has performed maintenance, preventive maintenance, or an alteration in accordance with part 43.

(b) A certificated repair station may not maintain or alter any article for which it is not rated, and may not maintain or alter any article for which it is rated if it requires special technical data, equipment, or facilities that are not available to it.

(c) A certificated repair station may not approve for return to service'

(1) Any article unless the maintenance, preventive maintenance, or alteration was performed in accordance with the applicable approved technical data or data acceptable to the FAA.

(2) Any article after a major repair or major alteration unless the major repair or major alteration was performed in accordance with applicable approved technical data; and

(3) Any experimental aircraft after a major repair or major alteration performed under §43.1(b) unless the major repair or major alteration was performed in accordance with methods and applicable technical data acceptable to the FAA.

## § 145.203 Work performed at another location.

A certificated repair station may temporarily transport material, equipment, and personnel needed to perform maintenance, preventive maintenance, alterations, or certain specialized services on an article for which it is rated to a place other than the repair station's fixed location if the following requirements are met:

(a) The work is necessary due to a special circumstance, as determined by the FAA; or

(b) It is necessary to perform such work on a recurring basis, and the repair station's manual includes the procedures for accomplishing maintenance, preventive maintenance, alterations, or specialized services at a

## 14 CFR Ch. I (1-1-08 Edition)

place other than the repair station's fixed location.

## § 145.205 Maintenance, preventive maintenance, and alterations performed for certificate holders under parts 121, 125, and 135, and for foreign air carriers or foreign persons operating a U.S.-registered aircraft in common carriage under part 129.

(a) A certificated repair station that performs maintenance, preventive maintenance, or alterations for an air carrier or commercial operator that has a continuous airworthiness maintenance program under part 121 or part 135 must follow the air carrier's or commercial operator's program and applicable sections of its maintenance manual.

(b) A certificated repair station that performs inspections for a certificate holder conducting operations under part 125 must follow the operator's FAA-approved inspection program.

(c) A certificated repair station that performs maintenance, preventive maintenance, or alterations for a foreign air carrier or foreign person operating a U.S.-registered aircraft under part 129 must follow the operator's FAA-approved maintenance program.

(d) Notwithstanding the housing requirement of §145.103(b), the FAA may grant approval for a certificated repair station to perform line maintenance for an air carrier certificated under part 121 or part 135, or a foreign air carrier or foreign person operating a U.S.-registered aircraft in common carriage under part 129 on any aircraft of that air carrier or person, provided—

(1) The certificated repair station performs such line maintenance in accordance with the operator's manual, if applicable, and approved maintenance program;

(2) The certificated repair station has the necessary equipment, trained personnel, and technical data to perform such line maintenance; and

(3) The certificated repair station's operations specifications include an authorization to perform line maintenance.

## § 145.206 Notification of hazardous materials authorizations.

(a) Each repair station must acknowledge receipt of the part 121 or

part 135 operator notification required under §§ 121.1005(e) and 135.505(e) of this chapter prior to performing work for, or on behalf of that certificate holder.

(b) Prior to performing work for or on behalf of a part 121 or part 135 operator, each repair station must notify its employees, contractors, or subcontractors that handle or replace aircraft components or other items regulated by 49 CFR parts 171 through 180 of each certificate holder's operations specifications authorization permitting, or prohibition against, carrying hazardous materials. This notification must be provided subsequent to the notification by the part 121 or part 135 operator of such operations specifications authorization/designation.

[Doc. No. FAA-2003-15085, 70 FR 58831, Oct. 7, 2005, as amended by Amdt. 145-25, 70 FR 75397, Dec. 20, 2005]

#### § 145.207 Repair station manual.

(a) A certificated repair station must prepare and follow a repair station manual acceptable to the FAA.

(b) A certificated repair station must maintain a current repair station manual.

(c) A certificated repair station's current repair station manual must be accessible for use by repair station personnel required by subpart D of this part.

(d) A certificated repair station must provide to its certificate holding district office the current repair station manual in a format acceptable to the FAA.

(e) A certificated repair station must notify its certificate holding district office of each revision of its repair station manual in accordance with the procedures required by § 145.209(j).

#### § 145.209 Repair station manual contents.

A certificated repair station's manual must include the following:

(a) An organizational chart identifying—

(1) Each management position with authority to act on behalf of the repair station,

(2) The area of responsibility assigned to each management position, and

(3) The duties, responsibilities, and authority of each management position;

(b) Procedures for maintaining and revising the rosters required by § 145.161;

(c) A description of the certificated repair station's operations, including the housing, facilities, equipment, and materials as required by subpart C of this part;

(d) Procedures for—

(1) Revising the capability list provided for in § 145.215 and notifying the certificate holding district office of revisions to the list, including how often the certificate holding district office will be notified of revisions; and

(2) The self-evaluation required under § 145.215(c) for revising the capability list, including methods and frequency of such evaluations, and procedures for reporting the results to the appropriate manager for review and action;

(e) Procedures for revising the training program required by § 145.163 and submitting revisions to the certificate holding district office for approval;

(f) Procedures to govern work performed at another location in accordance with § 145.203;

(g) Procedures for maintenance, preventive maintenance, or alterations performed under § 145.205;

(h) Procedures for—

(1) Maintaining and revising the contract maintenance information required by § 145.217(a)(2)(i), including submitting revisions to the certificate holding district office for approval; and

(2) Maintaining and revising the contract maintenance information required by § 145.217(a)(2)(ii) and notifying the certificate holding district office of revisions to this information, including how often the certificate holding district office will be notified of revisions;

(i) A description of the required records and the recordkeeping system used to obtain, store, and retrieve the required records;

(j) Procedures for revising the repair station's manual and notifying its certificate holding district office of revisions to the manual, including how often the certificate holding district office will be notified of revisions; and

**§ 145.211**

**14 CFR Ch. I (1–1–08 Edition)**

(k) A description of the system used to identify and control sections of the repair station manual.

**§ 145.211 Quality control system.**

(a) A certificated repair station must establish and maintain a quality control system acceptable to the FAA that ensures the airworthiness of the articles on which the repair station or any of its contractors performs maintenance, preventive maintenance, or alterations.

(b) Repair station personnel must follow the quality control system when performing maintenance, preventive maintenance, or alterations under the repair station certificate and operations specifications.

(c) A certificated repair station must prepare and keep current a quality control manual in a format acceptable to the FAA that includes the following:

(1) A description of the system and procedures used for—

(i) Inspecting incoming raw materials to ensure acceptable quality;

(ii) Performing preliminary inspection of all articles that are maintained;

(iii) Inspecting all articles that have been involved in an accident for hidden damage before maintenance, preventive maintenance, or alteration is performed;

(iv) Establishing and maintaining proficiency of inspection personnel;

(v) Establishing and maintaining current technical data for maintaining articles;

(vi) Qualifying and surveilling non-certificated persons who perform maintenance, preventive maintenance, or alterations for the repair station;

(vii) Performing final inspection and return to service of maintained articles;

(viii) Calibrating measuring and test equipment used in maintaining articles, including the intervals at which the equipment will be calibrated; and

(ix) Taking corrective action on deficiencies;

(2) References, where applicable, to the manufacturer's inspection standards for a particular article, including reference to any data specified by that manufacturer;

(3) A sample of the inspection and maintenance forms and instructions

for completing such forms or a reference to a separate forms manual; and

(4) Procedures for revising the quality control manual required under this section and notifying the certificate holding district office of the revisions, including how often the certificate holding district office will be notified of revisions.

(d) A certificated repair station must notify its certificate holding district office of revisions to its quality control manual.

**§ 145.213 Inspection of maintenance, preventive maintenance, or alterations.**

(a) A certificated repair station must inspect each article upon which it has performed maintenance, preventive maintenance, or alterations as described in paragraphs (b) and (c) of this section before approving that article for return to service.

(b) A certificated repair station must certify on an article's maintenance release that the article is airworthy with respect to the maintenance, preventive maintenance, or alterations performed after—

(1) The repair station performs work on the article; and

(2) An inspector inspects the article on which the repair station has performed work and determines it to be airworthy with respect to the work performed.

(c) For the purposes of paragraphs (a) and (b) of this section, an inspector must meet the requirements of § 145.155.

(d) Except for individuals employed by a repair station located outside the United States, only an employee certificated under part 65 is authorized to sign off on final inspections and maintenance releases for the repair station.

**§ 145.215 Capability list.**

(a) A certificated repair station with a limited rating may perform maintenance, preventive maintenance, or alterations on an article if the article is listed on a current capability list acceptable to the FAA or on the repair station's operations specifications.

(b) The capability list must identify each article by make and model or other nomenclature designated by the

article's manufacturer and be available in a format acceptable to the FAA.

(c) An article may be listed on the capability list only if the article is within the scope of the ratings of the repair station's certificate, and only after the repair station has performed a self-evaluation in accordance with the procedures under § 145.209(d)(2). The repair station must perform this self-evaluation to determine that the repair station has all of the housing, facilities, equipment, material, technical data, processes, and trained personnel in place to perform the work on the article as required by part 145. The repair station must retain on file documentation of the evaluation.

(d) Upon listing an additional article on its capability list, the repair station must provide its certificate holding district office with a copy of the revised list in accordance with the procedures required in § 145.209(d)(1).

#### § 145.217 Contract maintenance.

(a) A certificated repair station may contract a maintenance function pertaining to an article to an outside source provided—

(1) The FAA approves the maintenance function to be contracted to the outside source; and

(2) The repair station maintains and makes available to its certificate holding district office, in a format acceptable to the FAA, the following information:

(i) The maintenance functions contracted to each outside facility; and

(ii) The name of each outside facility to whom the repair station contracts maintenance functions and the type of certificate and ratings, if any, held by each facility.

(b) A certificated repair station may contract a maintenance function pertaining to an article to a noncertificated person provided—

(1) The noncertificated person follows a quality control system equivalent to the system followed by the certificated repair station;

(2) The certificated repair station remains directly in charge of the work performed by the noncertificated person; and

(3) The certificated repair station verifies, by test and/or inspection, that

the work has been performed satisfactorily by the noncertificated person and that the article is airworthy before approving it for return to service.

(c) A certificated repair station may not provide only approval for return to service of a complete type-certificated product following contract maintenance, preventive maintenance, or alterations.

#### § 145.219 Recordkeeping.

(a) A certificated repair station must retain records in English that demonstrate compliance with the requirements of part 43. The records must be retained in a format acceptable to the FAA.

(b) A certificated repair station must provide a copy of the maintenance release to the owner or operator of the article on which the maintenance, preventive maintenance, or alteration was performed.

(c) A certificated repair station must retain the records required by this section for at least 2 years from the date the article was approved for return to service.

(d) A certificated repair station must make all required records available for inspection by the FAA and the National Transportation Safety Board.

#### § 145.221 Service difficulty reports.

(a) A certificated repair station must report to the FAA within 96 hours after it discovers any serious failure, malfunction, or defect of an article. The report must be in a format acceptable to the FAA.

(b) The report required under paragraph (a) of this section must include as much of the following information as is available:

(1) Aircraft registration number;

(2) Type, make, and model of the article;

(3) Date of the discovery of the failure, malfunction, or defect;

(4) Nature of the failure, malfunction, or defect;

(5) Time since last overhaul, if applicable;

(6) Apparent cause of the failure, malfunction, or defect; and

**§ 145.223**

(7) Other pertinent information that is necessary for more complete identification, determination of seriousness, or corrective action.

(c) The holder of a repair station certificate that is also the holder of a part 121, 125, or 135 certificate; type certificate (including a supplemental type certificate); parts manufacturer approval; or technical standard order authorization, or that is the licensee of a type certificate holder, does not need to report a failure, malfunction, or defect under this section if the failure, malfunction, or defect has been reported under parts 21, 121, 125, or 135 of this chapter.

(d) A certificated repair station may submit a service difficulty report for the following:

(1) A part 121 certificate holder, provided the report meets the requirements of part 121 of this chapter, as appropriate.

(2) A part 125 certificate holder, provided the report meets the requirements of part 125 of this chapter, as appropriate.

(3) A part 135 certificate holder, provided the report meets the requirements of part 135 of the chapter, as appropriate.

(e) A certificated repair station authorized to report a failure, malfunction, or defect under paragraph (d) of this section must not report the same failure, malfunction, or defect under paragraph (a) of this section. A copy of the report submitted under paragraph (d) of this section must be forwarded to the certificate holder.

[Doc. No. FAA-1999-5836, 66 FR 41117, Aug. 6, 2001, as amended by Amdt. 22, 68 FR 75382, Dec. 30, 2003; Amdt. 145-26, 70 FR 76979, Dec. 29, 2005]

**§ 145.223 FAA inspections.**

(a) A certificated repair station must allow the FAA to inspect that repair station at any time to determine compliance with this chapter.

(b) A certificated repair station may not contract for the performance of a maintenance function on an article with a noncertificated person unless it provides in its contract with the noncertificated person that the FAA may make an inspection and observe the

**14 CFR Ch. I (1-1-08 Edition)**

performance of the noncertificated person's work on the article.

(c) A certificated repair station may not return to service any article on which a maintenance function was performed by a noncertificated person if the noncertificated person does not permit the FAA to make the inspection described in paragraph (b) of this section.

**PART 147—AVIATION MAINTENANCE TECHNICIAN SCHOOLS**

**Subpart A—General**

Sec.

- 147.1 Applicability.
- 147.3 Certificate required.
- 147.5 Application and issue.
- 147.7 Duration of certificates.

**Subpart B—Certification Requirements**

- 147.11 Ratings.
- 147.13 Facilities, equipment, and material requirements.
- 147.15 Space requirements.
- 147.17 Instructional equipment requirements.
- 147.19 Materials, special tools, and shop equipment requirements.
- 147.21 General curriculum requirements.
- 147.23 Instructor requirements.

**Subpart C—Operating Rules**

- 147.31 Attendance and enrollment, tests, and credit for prior instruction or experience.
- 147.33 Records.
- 147.35 Transcripts and graduation certificates.
- 147.36 Maintenance of instructor requirements.
- 147.37 Maintenance of facilities, equipment, and material.
- 147.38 Maintenance of curriculum requirements.
- 147.38a Quality of instruction.
- 147.39 Display of certificate.
- 147.41 Change of location.
- 147.43 Inspection.
- 147.45 Advertising.

APPENDIX A TO PART 147—CURRICULUM REQUIREMENTS

APPENDIX B TO PART 147—GENERAL CURRICULUM SUBJECTS

APPENDIX C TO PART 147—AIRFRAME CURRICULUM SUBJECTS

APPENDIX D TO PART 147—POWERPLANT CURRICULUM SUBJECTS

AUTHORITY: 49 U.S.C. 106(g), 40113, 44701-44702, 44707-44709.

**Federal Aviation Administration, DOT**

**§ 147.15**

SOURCE: Docket No. 1157, 27 FR 6669 July 13, 1962, unless otherwise noted.

**Subpart A—General**

**§ 147.1 Applicability.**

This part prescribes the requirements for issuing aviation maintenance technician school certificates and associated ratings and the general operating rules for the holders of those certificates and ratings.

**§ 147.3 Certificate required.**

No person may operate as a certificated aviation maintenance technician school without, or in violation of, an aviation maintenance technician school certificate issued under this part.

[Doc. No. 15196, 41 FR 47230, Oct. 28, 1976]

**§ 147.5 Application and issue.**

(a) An application for a certificate and rating, or for an additional rating, under this part is made on a form and in a manner prescribed by the Administrator, and submitted with—

- (1) A description of the proposed curriculum;
- (2) A list of the facilities and materials to be used;
- (3) A list of its instructors, including the kind of certificate and ratings held and the certificate numbers; and
- (4) A statement of the maximum number of students it expects to teach at any one time.

(b) An applicant who meets the requirements of this part is entitled to an aviation maintenance technician school certificate and associated ratings prescribing such operations specifications and limitations as are necessary in the interests of safety.

[Docket No. 1157, 27 FR 6669, July 13, 1962, as amended by Amdt. 147-5, 57 FR 28959, June 29, 1992]

**§ 147.7 Duration of certificates.**

(a) An aviation maintenance technician school certificate or rating is effective until it is surrendered, suspended, or revoked.

(b) The holder of a certificate that is surrendered, suspended, or revoked, shall return it to the Administrator.

[Doc. No. 1157, 27 FR 6669, July 19, 1962, as amended by Amdt. 147-3, 41 FR 47230, Oct. 28, 1976]

**Subpart B—Certification Requirements**

**§ 147.11 Ratings.**

The following ratings are issued under this part:

- (a) Airframe.
- (b) Powerplant.
- (c) Airframe and powerplant.

**§ 147.13 Facilities, equipment, and material requirements.**

An applicant for an aviation maintenance technician school certificate and rating, or for an additional rating, must have at least the facilities, equipment, and materials specified in §§147.15 to 147.19 that are appropriate to the rating he seeks.

**§ 147.15 Space requirements.**

An applicant for an aviation maintenance technician school certificate and rating, or for an additional rating, must have such of the following properly heated, lighted, and ventilated facilities as are appropriate to the rating he seeks and as the Administrator determines are appropriate for the maximum number of students expected to be taught at any time:

- (a) An enclosed classroom suitable for teaching theory classes.
- (b) Suitable facilities, either central or located in training areas, arranged to assure proper separation from the working space, for parts, tools, materials, and similar articles.
- (c) Suitable area for application of finishing materials, including paint spraying.
- (d) Suitable areas equipped with washtank and degreasing equipment with air pressure or other adequate cleaning equipment.
- (e) Suitable facilities for running engines.
- (f) Suitable area with adequate equipment, including benches, tables, and test equipment, to disassemble, service, and inspect.

## § 147.17

(1) Ignition, electrical equipment, and appliances;

(2) Carburetors and fuel systems; and

(3) Hydraulic and vacuum systems for aircraft, aircraft engines, and their appliances.

(g) Suitable space with adequate equipment, including tables, benches, stands, and jacks, for disassembling, inspecting, and rigging aircraft.

(h) Suitable space with adequate equipment for disassembling, inspecting, assembling, troubleshooting, and timing engines.

[Amdt. 147-2, 35 FR 5533, Apr. 3, 1970, as amended by Amdt. 147-5, 57 FR 28959, June 29, 1992]

### § 147.17 Instructional equipment requirements.

(a) An applicant for a mechanic school certificate and rating, or for an additional rating, must have such of the following instructional equipment as is appropriate to the rating he seeks:

(1) Various kinds of airframe structures, airframe systems and components, powerplants, and powerplant systems and components (including propellers), of a quantity and type suitable to complete the practical projects required by its approved curriculums.

(2) At least one aircraft of a type currently certificated by FAA for private or commercial operation, with powerplant, propeller, instruments, navigation and communications equipment, landing lights, and other equipment and accessories on which a maintenance technician might be required to work and with which the technician should be familiar.

(b) The equipment required by paragraph (a) of this section need not be in an airworthy condition. However, if it was damaged, it must have been repaired enough for complete assembly.

(c) Airframes, powerplants, propellers, appliances, and components thereof, on which instruction is to be given, and from which practical working experience is to be gained, must be so diversified as to show the different methods of construction, assembly, inspection, and operation when installed in an aircraft for use. There must be enough units so that not more than

## 14 CFR Ch. I (1-1-08 Edition)

eight students will work on any one unit at a time.

(d) If the aircraft used for instructional purposes does not have retractable landing gear and wing flaps, the school must provide training aids, or operational mock-ups of them.

[Doc. No. 1157, 27 FR 6669, July 19, 1962, as amended by Amdt. 147-5, 57 FR 28959, June 29, 1992]

### § 147.19 Materials, special tools, and shop equipment requirements.

An applicant for an aviation maintenance technician school certificate and rating, or for an additional rating, must have an adequate supply of material, special tools, and such of the shop equipment as are appropriate to the approved curriculum of the school and are used in constructing and maintaining aircraft, to assure that each student will be properly instructed. The special tools and shop equipment must be in satisfactory working condition for the purpose for which they are to be used.

[Amdt. 147-5, 57 FR 28959, June 29, 1992]

### § 147.21 General curriculum requirements.

(a) An applicant for an aviation maintenance technician school certificate and rating, or for an additional rating, must have an approved curriculum that is designed to qualify his students to perform the duties of a mechanic for a particular rating or ratings.

(b) The curriculum must offer at least the following number of hours of instruction for the rating shown, and the instruction unit hour shall not be less than 50 minutes in length—

(1) Airframe—1,150 hours (400 general plus 750 airframe).

(2) Powerplant—1,150 hours (400 general plus 750 powerplant).

(3) Combined airframe and powerplant—1,900 hours (400 general plus 750 airframe and 750 powerplant).

(c) The curriculum must cover the subjects and items prescribed in appendixes B, C, or D, as applicable. Each item must be taught to at least the indicated level of proficiency, as defined in appendix A.

(d) The curriculum must show—

(1) The required practical projects to be completed;

(2) For each subject, the proportions of theory and other instruction to be given; and

(3) A list of the minimum required school tests to be given.

(e) Notwithstanding the provisions of paragraphs (a) through (d) of this section and §147.11, the holder of a certificate issued under subpart B of this part may apply for and receive approval of special courses in the performance of special inspection and preventive maintenance programs for a primary category aircraft type certificated under §21.24(b) of this chapter. The school may also issue certificates of competency to persons successfully completing such courses provided that all other requirements of this part are met and the certificate of competency specifies the aircraft make and model to which the certificate applies.

[Doc. No. 1157, 27 FR 6669, July 13, 1962 as amended by Amdt. 147-1, 32 FR 5770 Apr. 11, 1967; Amdt. 147-5, 57 FR 28959, June 29, 1992; Amdt. 147-6, 57 FR 41370, Sept. 9, 1992]

#### § 147.23 Instructor requirements.

An applicant for an aviation maintenance technician school certificate and rating, or for an additional rating, must provide the number of instructors holding appropriate mechanic certificates and ratings that the Administrator determines necessary to provide adequate instruction and supervision of the students, including at least one such instructor for each 25 students in each shop class. However, the applicant may provide specialized instructors, who are not certificated mechanics, to teach mathematics, physics, basic electricity, basic hydraulics, drawing, and similar subjects. The applicant is required to maintain a list of the names and qualifications of specialized instructors, and upon request, provide a copy of the list to the FAA.

[Amdt. 147-5, 57 FR 28959, June 29, 1992]

### Subpart C—Operating Rules

#### § 147.31 Attendance and enrollment, tests, and credit for prior instruction or experience.

(a) A certificated aviation maintenance technician school may not require any student to attend classes of instruction more than 8 hours in any day or more than 6 days or 40 hours in any 7-day period.

(b) Each school shall give an appropriate test to each student who completes a unit of instruction as shown in that school's approved curriculum.

(c) A school may not graduate a student unless he has completed all of the appropriate curriculum requirements. However, the school may credit a student with instruction or previous experience as follows:

(1) A school may credit a student with instruction satisfactorily completed at—

(i) An accredited university, college, junior college;

(ii) An accredited vocational, technical, trade or high school;

(iii) A military technical school;

(iv) A certificated aviation maintenance technician school.

(2) A school may determine the amount of credit to be allowed—

(i) By an entrance test equal to one given to the students who complete a comparable required curriculum subject at the crediting school;

(ii) By an evaluation of an authenticated transcript from the student's former school; or

(iii) In the case of an applicant from a military school, only on the basis of an entrance test.

(3) A school may credit a student with previous aviation maintenance experience comparable to required curriculum subjects. It must determine the amount of credit to be allowed by documents verifying that experience, and by giving the student a test equal to the one given to students who complete the comparable required curriculum subject at the school.

(4) A school may credit a student seeking an additional rating with previous satisfactory completion of the general portion of an AMTS curriculum.

### § 147.33

(d) A school may not have more students enrolled than the number stated in its application for a certificate, unless it amends its application and has it approved.

(e) A school shall use an approved system for determining final course grades and for recording student attendance. The system must show hours of absence allowed and show how the missed material will be made available to the student.

[Amdt. 147-2, 35 FR 5534, Apr. 3, 1970, as amended by Amdt. 147-4, 43 FR 22643, May 25, 1978; Amdt. 147-5, 57 FR 28959, June 29, 1992]

### § 147.33 Records.

(a) Each certificated aviation maintenance technician school shall keep a current record of each student enrolled, showing—

(1) His attendance, tests, and grades received on the subjects required by this part;

(2) The instruction credited to him under § 147.31(c), if any; and

(3) The authenticated transcript of his grades from that school.

It shall retain the record for at least two years after the end of the student's enrollment, and shall make each record available for inspection by the Administrator during that period.

(b) Each school shall keep a current progress chart or individual progress record for each of its students, showing the practical projects or laboratory work completed, or to be completed, by the student in each subject.

[Doc. No. 1157, 27 FR 6669, July 13, 1962]

### § 147.35 Transcripts and graduation certificates.

(a) Upon request, each certificated aviation maintenance technician school shall provide a transcript of the student's grades to each student who is graduated from that school or who leaves it before being graduated. An official of the school shall authenticate the transcript. The transcript must state the curriculum in which the student was enrolled, whether the student satisfactorily completed that curriculum, and the final grades the student received.

(b) Each school shall give a graduation certificate or certificate of com-

### 14 CFR Ch. I (1-1-08 Edition)

pletion to each student that it graduates. An official of the school shall authenticate the certificate. The certificate must show the date of graduation and the approved curriculum title.

[Doc. No. 1157, 27 FR 6669, July 13, 1962, as amended by Amdt. 147-5, 57 FR 28959, June 29, 1992]

### § 147.36 Maintenance of instructor requirements.

Each certificated aviation maintenance technician school shall, after certification or addition of a rating, continue to provide the number of instructors holding appropriate mechanic certificates and ratings that the Administrator determines necessary to provide adequate instruction to the students, including at least one such instructor for each 25 students in each shop class. The school may continue to provide specialized instructors who are not certificated mechanics to teach mathematics, physics, drawing, basic electricity, basic hydraulics, and similar subjects.

[Amdt. 147-5, 57 FR 28959, June 29, 1992]

### § 147.37 Maintenance of facilities, equipment, and material.

(a) Each certificated aviation maintenance technician school shall provide facilities, equipment, and material equal to the standards currently required for the issue of the certificate and rating that it holds.

(b) A school may not make a substantial change in facilities, equipment, or material that have been approved for a particular curriculum, unless that change is approved in advance.

### § 147.38 Maintenance of curriculum requirements.

(a) Each certificated aviation maintenance technician school shall adhere to its approved curriculum. With FAA approval, curriculum subjects may be taught at levels exceeding those shown in appendix A of this part.

(b) A school may not change its approved curriculum unless the change is approved in advance.

[Amdt. 147-2, 35 FR 5534, Apr. 3, 1970, as amended by Amdt. 147-5, 57 FR 28960, June 29, 1992]

**§ 147.38a Quality of instruction.**

Each certificated aviation maintenance technician school shall provide instruction of such quality that, of its graduates of a curriculum for each rating who apply for a mechanic certificate or additional rating within 60 days after they are graduated, the percentage of those passing the applicable FAA written tests on their first attempt during any period of 24 calendar months is at least the percentage figured as follows:

(a) For a school graduating fewer than 51 students during that period—the national passing norm minus the number 20.

(b) For a school graduating at least 51, but fewer than 201, students during that period—the national passing norm minus the number 15.

(c) For a school graduating more than 200 students during that period—the national passing norm minus the number 10.

As used in this section, “national passing norm” is the number representing the percentage of all graduates (of a curriculum for a particular rating) of all certificated aviation maintenance technician schools who apply for a mechanic certificate or additional rating within 60 days after they are graduated and pass the applicable FAA written tests on their first attempt during the period of 24 calendar months described in this section.

[Amdt. 147-2, 35 FR 5534, Apr. 3, 1970, as amended by Amdt. 147-3, 41 FR 47230, Oct. 28, 1976]

**§ 147.39 Display of certificate.**

Each holder of an aviation maintenance technician school certificate and ratings shall display them at a place in the school that is normally accessible to the public and is not obscured. The certificate must be available for inspection by the Administrator.

**§ 147.41 Change of location.**

The holder of an aviation maintenance technician school certificate may not make any change in the school's location unless the change is approved in advance. If the holder desires to change the location he shall notify the Administrator, in writing,

at least 30 days before the date the change is contemplated. If he changes its location without approval, the certificate is revoked.

**§ 147.43 Inspection.**

The Administrator may, at any time, inspect an aviation maintenance technician school to determine its compliance with this part. Such an inspection is normally made once each six months to determine if the school continues to meet the requirements under which it was originally certificated. After such an inspection is made, the school is notified, in writing, of any deficiencies found during the inspection. Other informal inspections may be made from time to time.

**§ 147.45 Advertising.**

(a) A certificated aviation maintenance technician school may not make any statement relating to itself that is false or is designed to mislead any person considering enrollment therein.

(b) Whenever an aviation maintenance technician school indicates in advertising that it is a certificated school, it shall clearly distinguish between its approved courses and those that are not approved.

APPENDIX A TO PART 147—CURRICULUM  
REQUIREMENTS

This appendix defines terms used in appendices B, C, and D of this part, and describes the levels of proficiency at which items under each subject in each curriculum must be taught, as outlined in appendices B, C, and D.

(a) *Definitions.* As used in appendices B, C, and D:

(1) *Inspect* means to examine by sight and touch.

(2) *Check* means to verify proper operation.

(3) *Troubleshoot* means to analyze and identify malfunctions.

(4) *Service* means to perform functions that assure continued operation.

(5) *Repair* means to correct a defective condition. Repair of an airframe or powerplant system includes component replacement and adjustment, but not component repair.

(6) *Overhaul* means to disassemble, inspect, repair as necessary, and check.

(b) *Teaching levels.* (1) Level 1 requires:

(i) Knowledge of general principles, but no practical application.

(ii) No development of manipulative skill.

(iii) Instruction by lecture, demonstration, and discussion.

**Pt. 147, App. B**

**14 CFR Ch. I (1-1-08 Edition)**

- (2) Level 2 requires:
- (i) Knowledge of general principles, and limited practical application.
  - (ii) Development of sufficient manipulative skill to perform basic operations.
  - (iii) Instruction by lecture, demonstration, discussion, and limited practical application.
- (3) Level 3 requires:
- (i) Knowledge of general principles, and performance of a high degree of practical application.
  - (ii) Development of sufficient manipulative skills to simulate return to service.
  - (iii) Instruction by lecture, demonstration, discussion, and a high degree of practical application.
- (c) *Teaching materials and equipment.* The curriculum may be presented utilizing currently accepted educational materials and equipment, including, but not limited to: calculators, computers, and audio-visual equipment.

[Amdt. 147-2, 35 FR 5534, Apr. 3, 1970, as amended by Amdt. 147-5, 57 FR 28960, June 29, 1992]

**APPENDIX B TO PART 147—GENERAL CURRICULUM SUBJECTS**

This appendix lists the subjects required in at least 400 hours in general curriculum subjects.

The number in parentheses before each item listed under each subject heading indicates the level of proficiency at which that item must be taught.

- |                |  |
|----------------|--|
| Teaching level | <p style="text-align: center;">A. BASIC ELECTRICITY</p> <p>(2) 1. Calculate and measure capacitance and inductance.</p> <p>(2) 2. Calculate and measure electrical power.</p> <p>(3) 3. Measure voltage, current, resistance, and continuity.</p> <p>(3) 4. Determine the relationship of voltage, current, and resistance in electrical circuits.</p> <p>(3) 5. Read and interpret aircraft electrical circuit diagrams, including solid state devices and logic functions.</p> <p>(3) 6. Inspect and service batteries.</p> <p style="text-align: center;">B. AIRCRAFT DRAWINGS</p> <p>(2) 7. Use aircraft drawings, symbols, and system schematics.</p> <p>(3) 8. Draw sketches of repairs and alterations.</p> <p>(3) 9. Use blueprint information.</p> <p>(3) 10. Use graphs and charts.</p> <p style="text-align: center;">C. WEIGHT AND BALANCE</p> <p>(2) 11. Weigh aircraft.</p> <p>(3) 12. Perform complete weight-and-balance check and record data.</p> <p style="text-align: center;">D. FLUID LINES AND FITTINGS</p> <p>(3) 13. Fabricate and install rigid and flexible fluid lines and fittings.</p> |
|----------------|--|

- |                |  |
|----------------|--|
| Teaching level | <p style="text-align: center;">E. MATERIALS AND PROCESSES</p> <p>(1) 14. Identify and select appropriate nondestructive testing methods.</p> <p>(2) 15. Perform dye penetrant, eddy current, ultrasonic, and magnetic particle inspections.</p> <p>(1) 16. Perform basic heat-treating processes.</p> <p>(3) 17. Identify and select aircraft hardware and materials.</p> <p>(3) 18. Inspect and check welds.</p> <p>(3) 19. Perform precision measurements.</p> <p style="text-align: center;">F. GROUND OPERATION AND SERVICING</p> <p>(2) 20. Start, ground operate, move, service, and secure aircraft and identify typical ground operation hazards.</p> <p>(2) 21. Identify and select fuels.</p> <p style="text-align: center;">G. CLEANING AND CORROSION CONTROL</p> <p>(3) 22. Identify and select cleaning materials.</p> <p>(3) 23. Inspect, identify, remove, and treat aircraft corrosion and perform aircraft cleaning.</p> <p style="text-align: center;">H. MATHEMATICS</p> <p>(3) 24. Extract roots and raise numbers to a given power.</p> <p>(3) 25. Determine areas and volumes of various geometrical shapes.</p> <p>(3) 26. Solve ratio, proportion, and percentage problems.</p> <p>(3) 27. Perform algebraic operations involving addition, subtraction, multiplication, and division of positive and negative numbers.</p> <p style="text-align: center;">I. MAINTENANCE FORMS AND RECORDS</p> <p>(3) 28. Write descriptions of work performed including aircraft discrepancies and corrective actions using typical aircraft maintenance records.</p> <p>(3) 29. Complete required maintenance forms, records, and inspection reports.</p> <p style="text-align: center;">J. BASIC PHYSICS</p> <p>(2) 30. Use and understand the principles of simple machines; sound, fluid, and heat dynamics; basic aerodynamics; aircraft structures; and theory of flight.</p> <p style="text-align: center;">K. MAINTENANCE PUBLICATIONS</p> <p>(3) 31. Demonstrate ability to read, comprehend, and apply information contained in FAA and manufacturers' aircraft maintenance specifications, data sheets, manuals, publications, and related Federal Aviation Regulations, Airworthiness Directives, and Advisory material.</p> <p>(3) 32. Read technical data.</p> <p style="text-align: center;">L. MECHANIC PRIVILEGES AND LIMITATIONS</p> <p>(3) 33. Exercise mechanic privileges within the limitations prescribed by part 65 of this chapter.</p> |
|----------------|--|

[Amdt. 147-2, 35 FR 5534, Apr. 3, 1970, as amended by Amdt. 147-5, 57 FR 28960, June 29, 1992]

**APPENDIX C TO PART 147—AIRFRAME CURRICULUM SUBJECTS**

This appendix lists the subjects required in at least 750 hours of each airframe curriculum, in addition to at least 400 hours in general curriculum subjects.

The number in parentheses before each item listed under each subject heading indicates the level of proficiency at which that item must be taught.

- I. AIRFRAME STRUCTURES**
- Teach-  
ing  
level
- A. WOOD STRUCTURES
- (1) 1. Service and repair wood structures.  
(1) 2. Identify wood defects.  
(1) 3. Inspect wood structures.
- B. AIRCRAFT COVERING
- (1) 4. Select and apply fabric and fiberglass covering materials.  
(1) 5. Inspect, test, and repair fabric and fiberglass.
- C. AIRCRAFT FINISHES
- (1) 6. Apply trim, letters, and touchup paint.  
(2) 7. Identify and select aircraft finishing materials.  
(2) 8. Apply finishing materials.  
(2) 9. Inspect finishes and identify defects.
- D. SHEET METAL AND NON-METALLIC STRUCTURES
- (2) 10. Select, install, and remove special fasteners for metallic, bonded, and composite structures.  
(2) 11. Inspect bonded structures.  
(2) 12. Inspect, test, and repair fiberglass, plastics, honeycomb, composite, and laminated primary and secondary structures.  
(2) 13. Inspect, check, service, and repair windows, doors, and interior furnishings.  
(3) 14. Inspect and repair sheet-metal structures.  
(3) 15. Install conventional rivets.  
(3) 16. Form, lay out, and bend sheet metal.
- E. WELDING
- (1) 17. Weld magnesium and titanium.  
(1) 18. Solder stainless steel.  
(1) 19. Fabricate tubular structures.  
(2) 20. Solder, braze, gas-weld, and arc-weld steel.  
(1) 21. Weld aluminum and stainless steel.
- F. ASSEMBLY AND RIGGING
- (1) 22. Rig rotary-wing aircraft.  
(2) 23. Rig fixed-wing aircraft.  
(2) 24. Check alignment of structures.  
(3) 25. Assemble aircraft components, including flight control surfaces.  
(3) 26. Balance, rig, and inspect movable primary and secondary flight control surfaces.  
(3) 27. Jack aircraft.
- G. AIRFRAME INSPECTION
- (3) 28. Perform airframe conformity and airworthiness inspections.

- II. AIRFRAME SYSTEMS AND COMPONENTS**
- Teach-  
ing  
level
- A. AIRCRAFT LANDING GEAR SYSTEMS
- (3) 29. Inspect, check, service, and repair landing gear, retraction systems, shock struts, brakes, wheels, tires, and steering systems.
- B. HYDRAULIC AND PNEUMATIC POWER SYSTEMS
- (2) 30. Repair hydraulic and pneumatic power systems components.  
(3) 31. Identify and select hydraulic fluids.

- II. AIRFRAME SYSTEMS AND COMPONENTS—  
Continued**
- Teach-  
ing  
level
- (3) 32. Inspect, check, service, troubleshoot, and repair hydraulic and pneumatic power systems.
- C. CABIN ATMOSPHERE CONTROL SYSTEMS
- (1) 33. Inspect, check, troubleshoot, service, and repair heating, cooling, air conditioning, pressurization systems, and air cycle machines.  
(1) 34. Inspect, check, troubleshoot, service, and repair heating, cooling, air-conditioning, and pressurization systems.  
(2) 35. Inspect, check, troubleshoot, service and repair oxygen systems.
- D. AIRCRAFT INSTRUMENT SYSTEMS
- (1) 36. Inspect, check, service, troubleshoot, and repair electronic flight instrument systems and both mechanical and electrical heading, speed, altitude, temperature, pressure, and position indicating systems to include the use of built-in test equipment.  
(2) 37. Install instruments and perform a static pressure system leak test.
- E. COMMUNICATION AND NAVIGATION SYSTEMS
- (1) 38. Inspect, check, and troubleshoot autopilot, servos and approach coupling systems.  
(1) 39. Inspect, check, and service aircraft electronic communication and navigation systems, including VHF passenger address interphones and static discharge devices, aircraft VOR, ILS, LORAN, Radar beacon transponders, flight management computers, and GPWS.  
(2) 40. Inspect and repair antenna and electronic equipment installations.
- F. AIRCRAFT FUEL SYSTEMS
- (1) 41. Check and service fuel dump systems.  
(1) 42. Perform fuel management transfer, and defueling.  
(1) 43. Inspect, check, and repair pressure fueling systems.  
(2) 44. Repair aircraft fuel system components.  
(2) 45. Inspect and repair fluid quantity indicating systems.  
(2) 46. Troubleshoot, service, and repair fluid pressure and temperature warning systems.  
(3) 47. Inspect, check, service, troubleshoot, and repair aircraft fuel systems.
- G. AIRCRAFT ELECTRICAL SYSTEMS
- (2) 48. Repair and inspect aircraft electrical system components; crimp and splice wiring to manufacturers' specifications; and repair pins and sockets of aircraft connectors.  
(3) 49. Install, check, and service airframe electrical wiring, controls, switches, indicators, and protective devices.  
(3) 50.a. Inspect, check, troubleshoot, service, and repair alternating and direct current electrical systems.  
(1) 50.b. Inspect, check, and troubleshoot constant speed and integrated speed drive generators.
- H. POSITION AND WARNING SYSTEMS
- (2) 51. Inspect, check, and service speed and configuration warning systems, electrical brake controls, and anti-skid systems.  
(3) 52. Inspect, check, troubleshoot, and service landing gear position indicating and warning systems.

**Pt. 147, App. D**

**14 CFR Ch. I (1–1–08 Edition)**

**II. AIRFRAME SYSTEMS AND COMPONENTS—  
Continued**

- |                        |  |
|------------------------|--|
| Teach-<br>ing<br>level |  |
|                        | I. ICE AND RAIN CONTROL SYSTEMS  |
| (2)                    | 53. Inspect, check, troubleshoot, service, and repair airframe ice and rain control systems.             |
|                        | J. FIRE PROTECTION SYSTEMS   |
| (1)                    | 54. Inspect, check, and service smoke and carbon monoxide detection systems.                             |
| (3)                    | 55. Inspect, check, service, troubleshoot, and repair aircraft fire detection and extinguishing systems. |

[Amdt. 147–2, 35 FR 5535, Apr. 3, 1970, as amended by Amdt. 147–5, 57 FR 28960, June 29, 1992]

**APPENDIX D TO PART 147—POWERPLANT  
CURRICULUM SUBJECTS**

This appendix lists the subjects required in at least 750 hours of each powerplant curriculum, in addition to at least 400 hours in general curriculum subjects.

The number in parentheses before each item listed under each subject heading indicates the level of proficiency at which that item must be taught.

**I. POWERPLANT THEORY AND MAINTENANCE**

- |                        |  |
|------------------------|--|
| Teach-<br>ing<br>level |  |
|                        | A. RECIPROCATING ENGINES   |
| (1)                    | 1. Inspect and repair a radial engine.   |
| (2)                    | 2. Overhaul reciprocating engine.  |
| (3)                    | 3. Inspect, check, service, and repair reciprocating engines and engine installations.   |
| (3)                    | 4. Install, troubleshoot, and remove reciprocating engines.                              |
|                        | B. TURBINE ENGINES   |
| (2)                    | 5. Overhaul turbine engine.  |
| (3)                    | 6. Inspect, check, service, and repair turbine engines and turbine engine installations. |
| (3)                    | 7. Install, troubleshoot, and remove turbine engines.                                    |
|                        | C. ENGINE INSPECTION   |
| (3)                    | 8. Perform powerplant conformity and air worthiness inspections.                         |

**II. POWERPLANT SYSTEMS AND COMPONENTS**

- |                        |  |
|------------------------|--|
| Teach-<br>ing<br>level |  |
|                        | A. ENGINE INSTRUMENT SYSTEMS   |
| (2)                    | 9. Troubleshoot, service, and repair electrical and mechanical fluid rate-of-flow indicating systems.  |
| (3)                    | 10. Inspect, check, service, troubleshoot, and repair electrical and mechanical engine temperature, pressure, and r.p.m. indicating systems. |
|                        | B. ENGINE FIRE PROTECTION SYSTEMS  |
| (3)                    | 11. Inspect, check, service, troubleshoot, and repair engine fire detection and extinguishing systems.                                       |

**II. POWERPLANT SYSTEMS AND COMPONENTS—  
Continued**

- |                        |  |
|------------------------|--|
| Teach-<br>ing<br>level |  |
|                        | C. ENGINE ELECTRICAL SYSTEMS   |
| (2)                    | 12. Repair engine electrical system components.  |
| (3)                    | 13. Install, check, and service engine electrical wiring, controls, switches, indicators, and protective devices.                                |
|                        | D. LUBRICATION SYSTEMS   |
| (2)                    | 14. Identify and select lubricants.  |
| (2)                    | 15. Repair engine lubrication system components.   |
| (3)                    | 16. Inspect, check, service, troubleshoot, and repair engine lubrication systems.  |
|                        | E. IGNITION AND STARTING SYSTEMS   |
| (2)                    | 17. Overhaul magneto and ignition harness.   |
| (2)                    | 18. Inspect, service, troubleshoot, and repair reciprocating and turbine engine ignition systems and components.                                 |
| (3)                    | 19.a. Inspect, service, troubleshoot, and repair turbine engine electrical starting systems.   |
| (1)                    | 19.b. Inspect, service, and troubleshoot turbine engine pneumatic starting systems.  |
|                        | F. FUEL METERING SYSTEMS   |
| (1)                    | 20. Troubleshoot and adjust turbine engine fuel metering systems and electronic engine fuel controls.  |
| (2)                    | 21. Overhaul carburetor.   |
| (2)                    | 22. Repair engine fuel metering system components.   |
| (3)                    | 23. Inspect, check, service, troubleshoot, and repair reciprocating and turbine engine fuel metering systems.                                    |
|                        | G. ENGINE FUEL SYSTEMS   |
| (2)                    | 24. Repair engine fuel system components.  |
| (3)                    | 25. Inspect, check, service, troubleshoot, and repair engine fuel systems.   |
|                        | H. INDUCTION AND ENGINE AIRFLOW SYSTEMS  |
| (2)                    | 26. Inspect, check, troubleshoot, service, and repair engine ice and rain control systems.   |
| (1)                    | 27. Inspect, check, service, troubleshoot and repair heat exchangers, superchargers, and turbine engine airflow and temperature control systems. |
| (3)                    | 28. Inspect, check, service, and repair carburetor air intake and induction manifolds.   |
|                        | I. ENGINE COOLING SYSTEMS  |
| (2)                    | 29. Repair engine cooling system components.   |
| (3)                    | 30. Inspect, check, troubleshoot, service, and repair engine cooling systems.  |
|                        | J. ENGINE EXHAUST AND REVERSER SYSTEMS   |
| (2)                    | 31. Repair engine exhaust system components.   |
| (3)                    | 32.a. Inspect, check, troubleshoot, service, and repair engine exhaust systems.  |
| (1)                    | 32.b. Troubleshoot and repair engine thrust reverser systems and related components.   |
|                        | K. PROPELLERS  |
| (1)                    | 33. Inspect, check, service, and repair propeller synchronizing and ice control systems.   |
| (2)                    | 34. Identify and select propeller lubricants.  |
| (1)                    | 35. Balance propellers.  |
| (2)                    | 36. Repair propeller control system components.  |
| (3)                    | 37. Inspect, check, service, and repair fixed-pitch, constant-speed, and feathering propellers, and propeller governing systems.                 |
| (3)                    | 38. Install, troubleshoot, and remove propellers.  |
| (3)                    | 39. Repair aluminum alloy propeller blades.  |

**Federal Aviation Administration, DOT**

**Pt. 147, App. D**

**II. POWERPLANT SYSTEMS AND COMPONENTS—  
Continued**

(Sec. 6(c), Dept. of Transportation Act; 49 U.S.C. 1655(c))

Teach-  
ing  
level

[Amdt. 147-2, 35 FR 5535, Apr. 3, 1970, as amended by Amdt. 147-5, 57 FR 28961, June 29, 1992]

L. UNDUCTED FANS

- (1) 40. Inspect and troubleshoot unducted fan systems and components.

M. AUXILIARY POWER UNITS

- (1) 41. Inspect, check, service, and troubleshoot turbine-driven auxiliary power units.

## SUBCHAPTER I—AIRPORTS

### PART 150—AIRPORT NOISE COMPATIBILITY PLANNING

#### Subpart A—General Provisions

- Sec.  
150.1 Scope and purpose.  
150.3 Applicability.  
150.5 Limitations of this part.  
150.7 Definitions.  
150.9 Designation of noise systems.  
150.11 Identification of land uses.  
150.13 Incorporations by reference.

#### Subpart B—Development of Noise Exposure Maps and Noise Compatibility Programs

- 150.21 Noise exposure maps and related descriptions.  
150.23 Noise compatibility programs.

#### Subpart C—Evaluations and Determinations of Effects of Noise Compatibility Programs

- 150.31 Preliminary review: Acknowledgments.  
150.33 Evaluation of programs.  
150.35 Determinations; publications; effectivity.

APPENDIX A TO PART 150—NOISE EXPOSURE MAPS

APPENDIX B TO PART 150—NOISE COMPATIBILITY PROGRAMS

AUTHORITY: 49 U.S.C. 106(g), 40113, 44715, 47101, 47501–47504.

SOURCE: Docket No. 18691, 49 FR 49269, Dec. 18, 1984, unless otherwise noted.

#### Subpart A—General Provisions

##### § 150.1 Scope and purpose.

This part prescribes the procedures, standards, and methodology governing the development, submission, and review of airport noise exposure maps and airport noise compatibility programs, including the process for evaluating and approving or disapproving those programs. It prescribes single systems for—(a) measuring noise at airports and surrounding areas that generally provides a highly reliable relationship between projected noise exposure and surveyed reaction of people to noise; and (b) determining exposure of individuals to noise that results

from the operations of an airport. This part also identifies those land uses which are normally compatible with various levels of exposure to noise by individuals. It provides technical assistance to airport operators, in conjunction with other local, State, and Federal authorities, to prepare and execute appropriate noise compatibility planning and implementation programs.

##### § 150.3 Applicability.

This part applies to the airport noise compatibility planning activities of the operators of “public use airports,” including heliports, as that term is used in section 47501(2) as amended (49 U.S.C. 47501 *et seq.*) and as defined in section 47102(17) of 49 U.S.C.

[Doc. No. FAA–2004–19158, 69 FR 57625, Sept. 24, 2004]

##### § 150.5 Limitations of this part.

(a) Pursuant to 49 U.S.C. 47501 *et seq.*, this part provides for airport noise compatibility planning and land use programs necessary to the purposes of those provisions. No submittal of a map, or approval or disapproval, in whole or part, of any map or program submitted under this part is a determination concerning the acceptability or unacceptability of that land use under Federal, State, or local law.

(b) Approval of a noise compatibility program under this part is neither a commitment by the FAA to financially assist in the implementation of the program, nor a determination that all measures covered by the program are eligible for grant-in-aid funding from the FAA.

(c) Approval of a noise compatibility program under this part does not by itself constitute an FAA implementing action. A request for Federal action or approval to implement specific noise compatibility measures may be required, and an FAA decision on the request may require an environmental assessment of the proposed action, pursuant to the National Environmental Policy Act (42 U.S.C. 4332 *et seq.*) and guidelines.

(d) Acceptance of a noise exposure map does not constitute an FAA determination that any specific parcel of land lies within a particular noise contour. Responsibility for interpretation of the effects of noise contours upon subjacent land uses, including the relationship between noise contours and specific properties, rests with the sponsor or with other state or local government.

[Doc. No. 18691, 49 FR 49269, Dec. 18, 1984, as amended by Amdt. 150-4, 69 FR 57625, Sept. 24, 2004]

#### § 150.7 Definitions.

As used in this part, unless the context requires otherwise, the following terms have the following meanings.

*Airport* means any public use airport, including heliports, as defined by the ASNA Act, including: (a) Any airport which is used or to be used for public purposes, under the control of a public agency, the landing area of which is publicly owned; (b) any privately owned reliever airport; and (c) any privately owned airport which is determined by the Secretary to enplane annually 2,500 or more passengers and receive scheduled passenger service of aircraft, which is used or to be used for public purposes.

*Airport noise compatibility program and program* mean that program, and all revisions thereto, reflected in documents (and revised documents) developed in accordance with appendix B of this part, including the measures proposed or taken by the airport operator to reduce existing noncompatible land uses and to prevent the introduction of additional noncompatible land uses within the area.

*Airport Operator* means, the operator of an airport as defined in the ASNA Act.

*ASNA Act* means 49 U.S.C. 47501 *et seq.*

*Average sound level* means the level, in decibels, of the mean-square, A-weighted sound pressure during a specified period, with reference to the square of the standard reference sound pressure of 20 micropascals.

*Compatible land use* means the use of land that is identified under this part as normally compatible with the outdoor noise environment (or an adequately attenuated noise level reduc-

tion for any indoor activities involved) at the location because the yearly day-night average sound level is at or below that identified for that or similar use under appendix A (Table 1) of this part.

*Day-night average sound level (DNL)* means the 24-hour average sound level, in decibels, for the period from midnight to midnight, obtained after the addition of ten decibels to sound levels for the periods between midnight and 7 a.m., and between 10 p.m., and midnight, local time. The symbol for DNL is  $L_{dn}$ .

*Noise exposure map* means a scaled, geographic depiction of an airport, its noise contours, and surrounding area developed in accordance with section A150.1 of Appendix A of this part, including the accompanying documentation setting forth the required descriptions of forecast aircraft operations at that airport during the fifth calendar year (or later) beginning after submission of the map, together with the ways, if any, those operations will affect the map (including noise contours and the forecast land uses).

*Noise level reduction (NLR)* means the amount of noise level reduction in decibels achieved through incorporation of noise attenuation (between outdoor and indoor levels) in the design and construction of a structure.

*Noncompatible land use* means the use of land that is identified under this part as normally not compatible with the outdoor noise environment (or an adequately attenuated noise reduction level for the indoor activities involved at the location) because the yearly day-night average sound level is above that identified for that or similar use under appendix A (Table 1) of this part.

*Regional Airports Division Manager* means the Airports Division Manager having responsibility for the geographic area in which the airport in question is located.

*Restriction affecting flight procedures* means any requirement, limitation, or other action affecting the operation of aircraft, in the air or on the ground.

*Sound exposure level* means the level, in decibels, of the time integral of squared A-weighted sound pressure during a specified period or event, with reference to the square of the standard reference sound pressure of 20

## § 150.9

micropascals and a duration of one second.

*Yearly day-night average sound level* (YDNL) means the 365-day average, in decibels, day-night average sound level. The symbol for YDNL is also  $L_{dn}$ .

[Doc. No. 18691, 49 FR 49269, Dec. 18, 1984, as amended by Amdt. 150-1, 53 FR 8724, Mar. 16, 1988; 53 FR 9726, Mar. 24, 1988; Amdt. 150-2, 54 FR 39295, Sept. 25, 1989; Amdt. 150-4, 69 FR 57625, Sept. 24, 2004]

### § 150.9 Designation of noise systems.

For purposes of this part, the following designations apply:

(a) The noise at an airport and surrounding areas covered by a noise exposure map must be measured in A-weighted sound pressure level ( $L_A$ ) in units of decibels (dBA) in accordance with the specifications and methods prescribed under appendix A of this part.

(b) The exposure of individuals to noise resulting from the operation of an airport must be established in terms of yearly day-night average sound level (YDNL) calculated in accordance with the specifications and methods prescribed under appendix A of this part.

(c) Uses of computer models to create noise contours must be in accordance with the criteria prescribed under appendix A of this part.

### § 150.11 Identification of land uses.

For the purposes of this part, uses of land which are normally compatible or noncompatible with various noise exposure levels to individuals around airports must be identified in accordance with the criteria prescribed under appendix A of this part. Determination of land use must be based on professional planning criteria and procedures utilizing comprehensive, or master, land use planning, zoning, and building and site designing, as appropriate. If more than one current or future land use is permissible, determination of compatibility must be based on that use most adversely affected by noise.

### § 150.13 Incorporations by reference.

(a) *General.* This part prescribes certain standards and procedures which are not set forth in full text in the rule. Those standards and procedures are hereby incorporated by reference

## 14 CFR Ch. I (1-1-08 Edition)

and were approved for incorporation by reference by the Director of the Federal Register under 5 U.S.C. 552(a) and 1 CFR part 51.

(b) *Changes to incorporated matter.* Incorporated matter which is subject to subsequent change is incorporated by reference according to the specific reference and to the identification statement. Adoption of any subsequent change in incorporated matter that affects compliance with standards and procedures of this part will be made under 14 CFR part 11 and 1 CFR part 51.

(c) *Identification statement.* The complete title or description which identifies each published matter incorporated by reference in this part is as follows:

*International Electrotechnical Commission (IEC) Publication No. 179*, entitled "Precision Sound Level Meters," dated 1973.

(d) *Availability for purchase.* Published material incorporated by reference in this part may be purchased at the price established by the publisher or distributor at the following mailing addresses.

#### *IEC publications:*

(1) The Bureau Central de la Commission Electrotechnique, Internationale, 1, rue de Varembe, Geneva, Switzerland.

(2) American National Standards Institute, 1430 Broadway, New York, NY 10018.

(e) *Availability for inspection.* A copy of each publication incorporated by reference in this part is available for public inspection at the following locations:

(1) FAA Office of the Chief Counsel, Rules Docket, AGC-200, Federal Aviation Administration Headquarters Building, 800 Independence Avenue, SW., Washington, DC 20591.

(2) The respective Regional Offices of the Federal Aviation Administration as follows. The most current mailing address, phone numbers, and States covered by each region are available on the FAA's Web site at <http://www.faa.gov/arp/index.cfm?nav=hq>.

(i) New England Regional Office, 12 New England Executive Park, Burlington, Massachusetts 01803.

(ii) Eastern Regional Office, Airports Division, 1 Aviation Plaza, Jamaica, NY 11434-4809.

## Federal Aviation Administration, DOT

## § 150.21

(iii) Southern Regional Office, Federal Aviation Administration, ATTN: ASO-600, P.O. Box 20636, Atlanta, GA 30320-0631.

(iv) Great Lakes Regional Office, 2300 East Devon, Des Plaines, Illinois 60018.

(v) Central Regional Office, Federal Aviation Administration, ACE-600, 901 Locust, Kansas City, MO 64106-2325.

(vi) Southwest Regional Office, Federal Aviation Administration, 2601 Meacham Blvd., Fort Worth, TX 76137-4298.

(vii) Northwest Mountain Regional Office, Federal Aviation Administration, Airports Division, 1601 Lind Avenue SW., Suite 315, Renton, WA 98055-4056.

(viii) Western Pacific Regional Office, 15000 Aviation Boulevard, Hawthorne, California (P.O. Box 92007, Worldway Postal Center, Los Angeles) 90009.

(ix) Alaskan Regional Office, 222 W. 7th Avenue #14, Anchorage, AK 9951.

(3) National Archives and Records Administration (NARA). For information on the availability of this material at NARA, call 202-741-6030, or go to: [http://www.archives.gov/federal\\_register/code\\_of\\_federal\\_regulations/ibr\\_locations.html](http://www.archives.gov/federal_register/code_of_federal_regulations/ibr_locations.html).

[Doc. No. 18691, 49 FR 49269, Dec. 18, 1984, as amended by Amdt. 150-2, 54 FR 39295, Sept. 25, 1989; 69 FR 18803, Apr. 9, 2004; Amdt. 150-4, 69 FR 57625, Sept. 24, 2004; 72 FR 68475, Dec. 5, 2007]

### Subpart B—Development of Noise Exposure Maps and Noise Compatibility Programs

#### § 150.21 Noise exposure maps and related descriptions.

(a) Each airport operator may after completion of the consultations and public procedure specified under paragraph (b) of this section submit to the Regional Airports Division Manager five copies of the noise exposure map (or revised map) which identifies each noncompatible land use in each area depicted on the map, as of the date of submission, and five copies of a map each with accompanying documentation setting forth—

(1) The noise exposure based on forecast aircraft operations at the airport

for a forecast period that is at least 5 years in the future, beginning after the date of submission (based on reasonable assumptions concerning future type and frequency of aircraft operations, number of nighttime operations, flight patterns, airport layout including any planned airport development, planned land use changes, and demographic changes in the surrounding areas); and

(2) The nature and extent, if any, to which those forecast operations will affect the compatibility and land uses depicted on the map.

(b) Each map, and related documentation submitted under this section must be developed and prepared in accordance with appendix A of this part, or an FAA approved equivalent, and in consultation with states, and public agencies and planning agencies whose area, or any portion of whose area, of jurisdiction is within the  $L_{dn}$  65 dB contour depicted on the map, FAA regional officials, and other Federal officials having local responsibility for land uses depicted on the map. This consultation must include regular aeronautical users of the airport. The airport operator shall certify that it has afforded interested persons adequate opportunity to submit their views, data, and comments concerning the correctness and adequacy of the draft noise exposure map and descriptions of forecast aircraft operations. Each map and revised map must be accompanied by documentation describing the consultation accomplished under this paragraph and the opportunities afforded the public to review and comment during the development of the map. One copy of all written comments received during consultation shall also be filed with the Regional Airports Division Manager.

(c) The Regional Airports Division Manager acknowledges receipt of noise exposure maps and descriptions and indicates whether they are in compliance with the applicable requirements. The Regional Airports Division Manager publishes in the FEDERAL REGISTER a notice of compliance for each such noise exposure map and description, identifying the airport involved. Such notice includes information as to when

**§ 150.21**

**14 CFR Ch. I (1-1-08 Edition)**

and where the map and related documentation are available for public inspection.

(d) The airport operator shall, in accordance with this section, promptly prepare and submit a revised noise exposure map.

(1) If, after submission of a noise exposure map under paragraph (a) of this section, any change in the operation of the airport would create any “substantial, new noncompatible use” in any area depicted on the map beyond that which is forecast for a period of at least five years after the date of submission, the airport operator shall, in accordance with this section, promptly prepare and submit a revised noise exposure map. A change in the operation of an airport creates a substantial new noncompatible use if that change results in an increase in the yearly day-night average sound level of 1.5 dB or greater in either a land area which was formerly compatible but is thereby made noncompatible under Appendix A (Table 1), or in a land area which was previously determined to be noncompatible under that Table and whose noncompatibility is now significantly increased.

(2) If, after submission of a noise exposure map under paragraph (a) of this section, any change in the operation of the airport would significantly reduce noise over existing noncompatible uses that is not reflected in either the existing conditions or forecast noise exposure map on file with the FAA, the airport operator shall, in accordance with this section, promptly prepare and submit a revised noise exposure map. A change in the operation of the airport creates a significant reduction in noise over existing noncompatible uses if that change results in a decrease in the yearly day-night average sound level of 1.5 dB or greater in a land area which was formerly noncompatible but is thereby made compatible under Appendix A (Table 1).

(3) Such updating of the map shall include a reassessment of those areas excluded under section A150.101(e)(5) of Appendix A because of high ambient noise levels.

(4) If the forecast map is based on assumptions involving recommendations in a noise compatibility program which

are subsequently disapproved by the FAA, a revised map must be submitted if revised assumptions would create a substantial, new noncompatible use not indicated on the forecast map. Revised noise exposure maps are subject to the same requirements and procedures as initial submissions of noise exposure maps under this part.

(e) Each map, or revised map, and description of consultation and opportunity for public comment, submitted to the FAA, must be certified as true and complete under penalty of 18 U.S.C. 1001.

(f)(1) Title 49, section 47506 provides that no person who acquires property or an interest therein after the date of enactment of the Act in an area surrounding an airport with respect to which a noise exposure map has been submitted under section 47503 of the Act shall be entitled to recover damages with respect to the noise attributable to such airport if such person had actual or constructive knowledge of the existence of such noise exposure map unless, in addition to any other elements for recovery of damages, such person can show that—

No person who acquires property or an interest therein after the date of enactment of the Act in an area surrounding an airport with respect to which a noise exposure map has been submitted under section 103 of the Act shall be entitled to recover damages with respect to the noise attributable to such airport if such person had actual or constructive knowledge of the existence of such noise exposure map unless, in addition to any other elements for recovery of damages, such person can show that—

(i) A significant change in the type or frequency of aircraft operations at the airport; or

(ii) A significant change in the airport layout; or

(iii) A significant change in the flight patterns; or

(iv) A significant increase in nighttime operations; occurred after the date of the acquisition of such property or interest therein and that the damages for which recovery is sought have resulted from any such change or increase.”

(f)(2) Title 49 section 47506(b) further provides:

That for this purpose, “constructive knowledge” shall be imputed, at a minimum, to

any person who acquires property or an interest therein in an area surrounding an airport after the date of enactment of the Act if—

(i) Prior to the date of such acquisition, notice of the existence of a noise exposure map for such area was published at least three times in a newspaper of general circulation in the county in which such property is located; or

(ii) A copy of such noise exposure map is furnished to such person at the time of such acquisition.

(g) For this purpose, the term *significant* in paragraph (f) of this section means that change or increase in one or more of the four factors which results in a “substantial new noncompatible use” as defined in §150.21(d), affecting the property in issue. Responsibility for applying or interpreting this provision with respect to specific properties rests with local government.

[Doc. No. 18691, 49 FR 49269, Dec. 1, 1984; 50 FR 5063, Feb. 6, 1985; Amdt. 150-2, 54 FR 39295, Sept. 25, 1989; Amdt. 150-4, 69 FR 57626, Sept. 24, 2004]

#### § 150.23 Noise compatibility programs.

(a) Any airport operator who has submitted an acceptable noise exposure map under §150.21 may, after FAA notice of acceptability and other consultation and public procedure specified under paragraphs (b) and (c) of this section, as applicable, submit to the Regional Airports Division Manager five copies of a noise compatibility program.

(b) An airport operator may submit the noise compatibility program at the same time as the noise exposure map. In this case, the Regional Airports Division Manager will not begin the statutory 180-day review period (for the program) until after FAA reviews the noise exposure map and finds that it and its supporting documentation are in compliance with the applicable requirements.

(c) Each noise compatibility program must be developed and prepared in accordance with appendix B of this part, or an FAA approved equivalent, and in consultation with FAA regional officials, the officials of the state and of any public agencies and planning agencies whose area, or any portion of whose area, of jurisdiction within the  $L_{dn}$  65 dB noise contours is depicted on

the noise exposure map, and other Federal officials having local responsibility of land uses depicted on the map. Consultation with FAA regional officials shall include, to the extent practicable, informal agreement from FAA on proposed new or modified flight procedures. For air carrier airports, consultation must include any air carriers and, to the extent practicable, other aircraft operators using the airport. For other airports, consultation must include, to the extent practicable, aircraft operators using the airport.

(d) Prior to and during the development of a program, and prior to submission of the resulting draft program to the FAA, the airport operator shall afford adequate opportunity for the active and direct participation of the States, public agencies and planning agencies in the areas surrounding the airport, aeronautical users of the airport, the airport operator, and the general public to submit their views, data, and comments on the formulation and adequacy of that program. Prior to submitting the program to the FAA, the airport operator shall also provide notice and the opportunity for a public hearing.

(e) Each noise compatibility program submitted to the FAA must consist of at least the following:

(1) A copy of the noise exposure map and its supporting documentation as found in compliance with the applicable requirements by the FAA, per §150.21(c).

(2) A description and analysis of the alternative measures considered by the airport operator in developing the program, together with a discussion of why each rejected measure was not included in the program.

(3) Program measures proposed to reduce or eliminate present and future noncompatible land uses and a description of the relative contribution of each of the proposed measures to the overall effectiveness of the program.

(4) A description of public participation and the consultation with officials of public agencies and planning agencies in areas surrounding the airport, FAA regional officials and other Federal officials having local responsibility for land uses depicted on the

**§ 150.31**

map, any air carriers and other users of the airport.

(5) The actual or anticipated effect of the program on reducing noise exposure to individuals and noncompatible land uses and preventing the introduction of additional noncompatible uses within the area covered by the noise exposure map. The effects must be based on expressed assumptions concerning the type and frequency of aircraft operations, number of nighttime operations, flight patterns, airport layout including planned airport development, planned land use changes, and demographic changes within the  $L_{dn}$  65 dB noise contours.

(6) A description of how the proposed future actions may change any noise control or compatibility plans or actions previously adopted by the airport proprietor.

(7) A summary of the comments at any public hearing on the program and a copy of all written material submitted to the operator under paragraphs (c) and (d) of this section, together with the operator's response and disposition of those comments and materials to demonstrate the program is feasible and reasonably consistent with obtaining the objectives of airport noise compatibility planning under this part.

(8) The period covered by the program, the schedule for implementation of the program, the persons responsible for implementation of each measure in the program, and, for each measure, documentation supporting the feasibility of implementation, including any essential governmental actions, costs, and anticipated sources of funding, that will demonstrate that the program is reasonably consistent with achieving the goals of airport noise compatibility planning under this part.

(9) Provision for revising the program if made necessary by revision of the noise exposure map.

[Doc. No. 18691, 49 FR 49269, Dec. 18, 1984; 50 FR 5063, Feb. 6, 1985; Amdt. 150-2, 54 FR 39295, Sept. 25, 1989; Amdt. 150-4, 69 FR 57626, Sept. 24, 2004]

**Subpart C—Evaluations and Determinations of Effects of Noise Compatibility Programs**

**§ 150.31 Preliminary review: Acknowledgments.**

(a) Upon receipt of a noise compatibility program submitted under § 150.23, the Regional Airports Division Manager acknowledges to the airport operator receipt of the program and conducts a preliminary review of the submission.

(b) If, based on the preliminary review, the Regional Airports Division Manager finds that the submission does not conform to the requirements of this part, he disapproves and returns the unacceptable program to the airport operator for reconsideration and development of a program in accordance with this part.

(c) If, based on the preliminary review, the Regional Airports Division Manager finds that the program conforms to the requirements of this part, the Regional Airports Division Manager publishes in the FEDERAL REGISTER a notice of receipt of the program for comment which indicates the following:

(1) The airport covered by the program, and the date of receipt.

(2) The availability of the program for examination in the offices of the Regional Airports Division Manager and the airport operator.

(3) That comments on the program are invited and, will be considered by the FAA.

(d) The date of signature of the published notice of receipt starts the 180-day approval period for the program.

[Doc. No. 18691, 49 FR 49269, Dec. 18, 1984, as amended by Amdt. 150-2, 54 FR 39295, Sept. 25, 1989]

**§ 150.33 Evaluation of programs.**

(a) The FAA conducts an evaluation of each noise compatibility program and, based on that evaluation, either approves or disapproves the program. The evaluation includes consideration of proposed measures to determine whether they—

(1) May create an undue burden on interstate or foreign commerce (including unjust discrimination);

## Federal Aviation Administration, DOT

## § 150.35

(2) Are reasonably consistent with obtaining the goal of reducing existing noncompatible land uses and preventing the introduction of additional noncompatible land uses; and

(3) Include the use of new or modified flight procedures to control the operation of aircraft for purposes of noise control, or affect flight procedures in any way.

(b) The evaluation may also include an evaluation of those proposed measures to determine whether they may adversely affect the exercise of the authority and responsibilities of the Administrator under the Federal Aviation Act of 1958, as amended.

(c) To the extent considered necessary, the FAA may—

(1) Confer with the airport operator and other persons known to have information and views material to the evaluation;

(2) Explore the objectives of the program and the measures, and any alternative measures, for achieving the objectives.

(3) Examine the program for developing a range of alternatives that would eliminate the reasons, if any, for disapproving the program.

(4) Convene an informal meeting with the airport operator and other persons involved in developing or implementing the program for the purposes of gathering all facts relevant to the determination of approval or disapproval of the program and of discussing any needs to accommodate or modify the program as submitted.

(d) If requested by the FAA, the airport operator shall furnish all information needed to complete FAA's review under (c).

(e) An airport operator may, at any time before approval or disapproval of a program, withdraw or revise the program. If the airport operator withdraws or revises the program or indicates to the Regional Airports Division Manager, in writing, the intention to revise the program, the Regional Airports Division Manager terminates the evaluation and notifies the airport operator of that action. That termination cancels the 180-day review period. The FAA does not evaluate a second program for any airport until any previously submitted program has been

withdrawn or a determination on it is issued. A new evaluation is commenced upon receipt of a revised program, and a new 180-day approval period is begun, unless the Regional Airports Division Manager finds that the modification made, in light of the overall revised program, can be integrated into the unmodified portions of the revised program without exceeding the original 180-day approval period or causing undue expense to the government.

[Doc. No. 18691, 49 FR 49269, Dec. 18, 1984, as amended by Amdt. 150-2, 54 FR 39295, Sept. 25, 1989]

### **§ 150.35 Determinations; publications; effectivity.**

(a) The FAA issues a determination approving or disapproving each airport noise compatibility program (and revised program). Portions of a program may be individually approved or disapproved. No conditional approvals will be issued. A determination on a program acceptable under this part is issued within 180 days after the program is received under §150.23 of this part or it may be considered approved, except that this time period may be exceeded for any portion of a program relating to the use of flight procedures for noise control purposes. A determination on portions of a program covered by the exceptions to the 180-day review period for approval will be issued within a reasonable time after receipt of the program. Determinations relating to the use of any flight procedure for noise control purposes may be issued either in connection with the determination on other portions of the program or separately. Except as provided by this paragraph, no approval of any noise compatibility program, or any portion of a program, may be implied in the absence of the FAA's express approval.

(b) The Administrator approves programs under this part, if—

(1) It is found that the program measures to be implemented would not create an undue burden on interstate or foreign commerce (including any unjust discrimination) and are reasonably consistent with achieving the goals of reducing existing noncompatible land

uses around the airport and of preventing the introduction of additional noncompatible land uses;

(2) The program provides for revision if made necessary by the revision of the noise map; and

(3) Those aspects of programs relating to the use of flight procedures for noise control can be implemented within the period covered by the program and without—

(i) Reducing the level of aviation safety provided;

(ii) Derogating the requisite level of protection for aircraft, their occupants and persons and property on the ground;

(iii) Adversely affecting the efficient use and management of the Navigable Airspace and Air Traffic Control Systems; or

(iv) Adversely affecting any other powers and responsibilities of the Administrator prescribed by law or any other program, standard, or requirement established in accordance with law.

(c) When a determination is issued, the Regional Airports Division Manager notifies the airport operator and publishes a notice of approval or disapproval in the FEDERAL REGISTER identifying the nature and extent of the determination.

(d) Approvals issued under this part for a program or portion thereof become effective as specified therein and may be withdrawn when one of the following occurs:

(1) The program or portion thereof is required to be revised under this part or under its own terms, and is not so revised;

(2) If a revision has been submitted for approval, a determination is issued on the revised program or portion thereof, that is inconsistent with the prior approval.

(3) A term or condition of the program, or portion thereof, or its approval is violated by the responsible government body.

(4) A flight procedure or other FAA action upon which the approved program or portion thereof is dependent is subsequently disapproved, significantly altered, or rescinded by the FAA.

(5) The airport operator requests rescission of the approval.

(6) Impacts on flight procedures, air traffic management, or air commerce occur which could not be foreseen at the time of approval.

A determination may be sooner rescinded or modified for cause with at least 30 days written notice to the airport operator of the FAA's intention to rescind or modify the determination for the reasons stated in the notice. The airport operator may, during the 30-day period, submit to the Regional Airports Division Manager for consideration any reasons and circumstances why the determination should not be rescinded or modified on the basis stated in the notice of intent. Thereafter, the FAA either rescinds or modifies the determination consistent with the notice or withdraws the notice of intent and terminates the action.

(e) Determinations may contain conditions which must be satisfied prior to implementation of any portion of the program relating to flight procedures affecting airport or aircraft operations.

(f) Noise exposure maps for current and forecast year map conditions that are submitted and approved with noise compatibility programs are considered to be the new FAA accepted noise exposure maps for purposes of part 150.

[Doc. No. 18691, 49 FR 49269, Dec. 18, 1984, as amended by Amdt. 150-2, 54 FR 39295, Sept. 25, 1989; Amdt. 150-4, 69 FR 57626, Sept. 24, 2004]

#### APPENDIX A TO PART 150—NOISE EXPOSURE MAPS

##### PART A—GENERAL

Sec. A150.1 Purpose.

Sec. A150.3 Noise descriptors.

Sec. A150.5 Noise measurement procedures and equipment.

##### PART B—NOISE EXPOSURE MAP DEVELOPMENT

Sec. A150.101 Noise contours and land uses.

Sec. A150.103 Use of computer prediction model.

Sec. A150.105 Identification of public agencies and planning agencies.

##### PART C—MATHEMATICAL DESCRIPTIONS

Sec. A150.201 General.

Sec. A150.203 Symbols.

Sec. A150.205 Mathematical computations.

## PART A—GENERAL

*Sec. A150.1 Purpose.*

(a) This appendix establishes a uniform methodology for the development and preparation of airport noise exposure maps. That methodology includes a single system of measuring noise at airports for which there is a highly reliable relationship between projected noise exposure and surveyed reactions of people to noise along with a separate single system for determining the exposure of individuals to noise. It also identifies land uses which, for the purpose of this part are considered to be compatible with various exposures of individuals to noise around airports.

(b) This appendix provides for the use of the FAA's Integrated Noise Model (INM) or an FAA approved equivalent, for developing standardized noise exposure maps and predicting noise impacts. Noise monitoring may be utilized by airport operators for data acquisition and data refinement, but is not required by this part for the development of noise exposure maps or airport noise compatibility programs. Whenever noise monitoring is used, under this part, it should be accomplished in accordance with Sec. A150.5 of this appendix.

*Sec. A150.3 Noise descriptors.*

(a) *Airport Noise Measurement.* The A-Weighted Sound Level, measured, filtered and recorded in accordance with Sec. A150.5 of this appendix, must be employed as the unit for the measurement of single event noise at airports and in the areas surrounding the airports.

(b) *Airport Noise Exposure.* The yearly day-night average sound level (YDNL) must be employed for the analysis and characterization of multiple aircraft noise events and for determining the cumulative exposure of individuals to noise around airports.

*Sec. A150.5 Noise measurement procedures and equipment.*

(a) Sound levels must be measured or analyzed with equipment having the "A" frequency weighting, filter characteristics, and the "slow response" characteristics as defined in International Electrotechnical Commission (IEC) Publication No. 179, entitled "Precision Sound Level Meters" as incorporated by reference in part 150 under §150.11. For purposes of this part, the tolerances allowed for general purpose, type 2 sound level meters in IEC 179, are acceptable.

(b) Noise measurements and documentation must be in accordance with accepted acoustical measurement methodology, such as those described in American National Standards Institute publication ANSI S1.13, dated 1971 as revised 1979, entitled "ANS-

Methods for the Measurement of Sound Pressure Levels"; ARP No. 796, dated 1969, entitled "Measurement of Aircraft Exterior Noise in the Field"; "Handbook of Noise Measurement," Ninth Ed. 1980, by Arnold P.G. Peterson; or "Acoustic Noise Measurement," dated Jan., 1979, by J.R. Hassell and K. Zaveri. For purposes of this part, measurements intended for comparison to a State or local standard or with another transportation noise source (including other aircraft) must be reported in maximum A-weighted sound levels ( $L_{AM}$ ); for computation or validation of the yearly day-night average level ( $L_{dn}$ ), measurements must be reported in sound exposure level ( $L_{AE}$ ), as defined in Sec. A150.205 of this appendix.

## PART B—NOISE EXPOSURE MAP DEVELOPMENT

*Sec. A150.101 Noise contours and land usages.*

(a) To determine the extent of the noise impact around an airport, airport proprietors developing noise exposure maps in accordance with this part must develop  $L_{dn}$  contours. Continuous contours must be developed for YDNL levels of 65, 70, and 75 (additional contours may be developed and depicted when appropriate). In those areas where YDNL values are 65 YDNL or greater, the airport operator shall identify land uses and determine land use compatibility in accordance with the standards and procedures of this appendix.

(b) Table 1 of this appendix describes compatible land use information for several land uses as a function of YDNL values. The ranges of YDNL values in Table 1 reflect the statistical variability for the responses of large groups of people to noise. Any particular level might not, therefore, accurately assess an individual's perception of an actual noise environment. Compatible or non-compatible land use is determined by comparing the predicted or measured YDNL values at a site with the values given. Adjustments or modifications of the descriptions of the land-use categories may be desirable after consideration of specific local conditions.

(c) Compatibility designations in Table 1 generally refer to the major use of the site. If other uses with greater sensitivity to noise are permitted by local government at a site, a determination of compatibility must be based on that use which is most adversely affected by noise. When appropriate, noise level reduction through incorporation of sound attenuation into the design and construction of a structure may be necessary to achieve compatibility.

(d) For the purpose of compliance with this part, all land uses are considered to be compatible with noise levels less than  $L_{dn}$  65 dB. Local needs or values may dictate further delineation based on local requirements or determinations.

(e) Except as provided in (f) below, the noise exposure maps must also contain and identify:

- (1) Runway locations.
- (2) Flight tracks.
- (3) Noise contours of  $L_{dn}$  65, 70, and 75 dB resulting from aircraft operations.
- (4) Outline of the airport boundaries.
- (5) Noncompatible land uses within the noise contours, including those within the  $L_{dn}$  65 dB contours. (No land use has to be identified as noncompatible if the self-generated noise from that use and/or the ambient noise from other nonaircraft and nonairport uses is equal to or greater than the noise from aircraft and airport sources.)
- (6) Location of noise sensitive public buildings (such as schools, hospitals, and health care facilities), and properties on or eligible for inclusion in the National Register of Historic Places.
- (7) Locations of any aircraft noise monitoring sites utilized for data acquisition and refinement procedures.
- (8) Estimates of the number of people residing within the  $L_{dn}$  65, 70, and 75 dB contours.

(9) Depiction of the required noise contours over a land use map of a sufficient scale and quality to discern streets and other identifiable geographic features.

(f) Notwithstanding any other provision of this part, noise exposure maps prepared in connection with studies which were either Federally funded or Federally approved and which commenced before October 1, 1981, are not required to be modified to contain the following items:

- (1) Flight tracks depicted on the map.
- (2) Use of ambient noise to determine land use compatibility.
- (3) The  $L_{dn}$  70 dB noise contour and data related to  $L_{dn}$  70 dB contour. When determinations on land use compatibility using Table 1 differ between  $L_{dn}$  65-70 dB and the  $L_{dn}$  70-75 dB, determinations should either use the more conservative  $L_{dn}$  70-75 dB column or reflect determinations based on local needs and values.
- (4) Estimates of the number of people residing within the  $L_{dn}$  65, 70, and 75 dB contours.

TABLE 1—LAND USE COMPATIBILITY\* WITH YEARLY DAY-NIGHT AVERAGE SOUND LEVELS

Land use	Yearly day-night average sound level ( $L_{dn}$ ) in decibels					
	Below 65	65-70	70-75	75-80	80-85	Over 85
<b>RESIDENTIAL</b>						
Residential, other than mobile homes and transient lodgings.	Y	N(1)	N(1)	N	N	N
Mobile home parks .....	Y	N	N	N	N	N
Transient lodgings .....	Y	N(1)	N(1)	N(1)	N	N
<b>PUBLIC USE</b>						
Schools .....	Y	N(1)	N(1)	N	N	N
Hospitals and nursing homes .....	Y	25	30	N	N	N
Churches, auditoriums, and concert halls .....	Y	25	30	N	N	N
Governmental services .....	Y	Y	25	30	N	N
Transportation .....	Y	Y	Y(2)	Y(3)	Y(4)	Y(4)
Parking .....	Y	Y	Y(2)	Y(3)	Y(4)	N
<b>COMMERCIAL USE</b>						
Offices, business and professional .....	Y	Y	25	30	N	N
Wholesale and retail—building materials, hardware and farm equipment.	Y	Y	Y(2)	Y(3)	Y(4)	N
Retail trade—general .....	Y	Y	25	30	N	N
Utilities .....	Y	Y	Y(2)	Y(3)	Y(4)	N
Communication .....	Y	Y	25	30	N	N
<b>MANUFACTURING AND PRODUCTION</b>						
Manufacturing, general .....	Y	Y	Y(2)	Y(3)	Y(4)	N
Photographic and optical .....	Y	Y	25	30	N	N
Agriculture (except livestock) and forestry .....	Y	Y(6)	Y(7)	Y(8)	Y(8)	Y(8)
Livestock farming and breeding .....	Y	Y(6)	Y(7)	N	N	N
Mining and fishing, resource production and extraction.	Y	Y	Y	Y	Y	Y
<b>RECREATIONAL</b>						
Outdoor sports arenas and spectator sports ...	Y	Y(5)	Y(5)	N	N	N
Outdoor music shells, amphitheaters .....	Y	N	N	N	N	N
Nature exhibits and zoos .....	Y	Y	N	N	N	N
Amusements, parks, resorts and camps .....	Y	Y	Y	N	N	N
Golf courses, riding stables and water recreation.	Y	Y	25	30	N	N

Numbers in parentheses refer to notes.

\*The designations contained in this table do not constitute a Federal determination that any use of land covered by the program is acceptable or unacceptable under Federal, State, or local law. The responsibility for determining the acceptable and permissible land uses and the relationship between specific properties and specific noise contours rests with the local authorities. FAA determinations under part 150 are not intended to substitute federally determined land uses for those determined to be appropriate by local authorities in response to locally determined needs and values in achieving noise compatible land uses.

## KEY TO TABLE 1

SLUCM=Standard Land Use Coding Manual.

Y (Yes)=Land Use and related structures compatible without restrictions.

N (No)=Land Use and related structures are not compatible and should be prohibited.

NLR=Noise Level Reduction (outdoor to indoor) to be achieved through incorporation of noise attenuation into the design and construction of the structure.

25, 30, or 35=Land use and related structures generally compatible; measures to achieve NLR of 25, 30, or 35 dB must be incorporated into design and construction of structure.

## NOTES FOR TABLE 1

(1) Where the community determines that residential or school uses must be allowed, measures to achieve outdoor to indoor Noise Level Reduction (NLR) of at least 25 dB and 30 dB should be incorporated into building codes and be considered in individual approvals. Normal residential construction can be expected to provide a NLR of 20 dB, thus, the reduction requirements are often stated as 5, 10 or 15 dB over standard construction and normally assume mechanical ventilation and closed windows year round. However, the use of NLR criteria will not eliminate outdoor noise problems.

(2) Measures to achieve NLR 25 dB must be incorporated into the design and construction of portions of these buildings where the public is received, office areas, noise sensitive areas or where the normal noise level is low.

(3) Measures to achieve NLR of 30 dB must be incorporated into the design and construction of portions of these buildings where the public is received, office areas, noise sensitive areas or where the normal noise level is low.

(4) Measures to achieve NLR 35 dB must be incorporated into the design and construction of portions of these buildings where the public is received, office areas, noise sensitive areas or where the normal level is low.

(5) Land use compatible provided special sound reinforcement systems are installed.

(6) Residential buildings require an NLR of 25.

(7) Residential buildings require an NLR of 30.

(8) Residential buildings not permitted.

*Sec. A150.103 Use of computer prediction model.*

(a) The airport operator shall acquire the aviation operations data necessary to develop noise exposure contours using an FAA approved methodology or computer program, such as the Integrated Noise Model (INM) for airports or the Heliport Noise Model (HNM) for heliports. In considering approval of a methodology or computer program, key factors include the demonstrated capability to produce the required output and the public availability of the program or methodology to provide interested parties the opportunity to substantiate the results.

(b) Except as provided in paragraph (c) of this section, the following information must be obtained for input to the calculation of noise exposure contours:

(1) A map of the airport and its environs at an adequately detailed scale (not less than 1 inch to 2,000 feet) indicating runway length, alignments, landing thresholds, takeoff start-of-roll points, airport boundary, and flight tracks out to at least 30,000 feet from the end of each runway.

(2) Airport activity levels and operational data which will indicate, on an annual average-daily-basis, the number of aircraft, by type of aircraft, which utilize each flight track, in both the standard daytime (0700-2200 hours local) and nighttime (2200-0700 hours local) periods for both landings and takeoffs.

(3) For landings—glide slopes, glide slope intercept altitudes, and other pertinent information needed to establish approach profiles along with the engine power levels needed to fly that approach profile.

(4) For takeoffs—the flight profile which is the relationship of altitude to distance from

start-of-roll along with the engine power levels needed to fly that takeoff profile; these data must reflect the use of noise abatement departure procedures and, if applicable, the takeoff weight of the aircraft or some proxy for weight such as stage length.

(5) Existing topographical or airspace restrictions which preclude the utilization of alternative flight tracks.

(6) The government furnished data depicting aircraft noise characteristics (if not already a part of the computer program's stored data bank).

(7) Airport elevation and average temperature.

(c) For heliports, the map scale required by paragraph (b)(1) of this section shall not be less than 1 inch to 2,000 feet and shall indicate heliport boundaries, takeoff and landing pads, and typical flight tracks out to at least 4,000 feet horizontally from the landing pad. Where these flight tracks cannot be determined, obstructions or other limitations on flight tracks in and out of the heliport shall be identified within the map areas out to at least 4,000 feet horizontally from the landing pad. For static operation (hover), the helicopter type, the number of daily operations based on an annual average, and the duration in minutes of the hover operation shall be identified. The other information required in paragraph (b) shall be furnished in a form suitable for input to the HNM or other FAA approved methodology or computer program.

*Sec. A150.105 Identification of public agencies and planning agencies.*

(a) The airport proprietor shall identify each public agency and planning agency whose jurisdiction or responsibility is either

**Pt. 150, App. B**

**14 CFR Ch. I (1-1-08 Edition)**

wholly or partially within the  $L_{dn}$  65 dB boundary.

(b) For those agencies identified in (a) that have land use planning and control authority, the supporting documentation shall identify their geographic areas of jurisdiction.

**PART C—MATHEMATICAL DESCRIPTIONS**

*Sec. A150.201 General.*

The following mathematical descriptions provide the most precise definition of the yearly day-night average sound level ( $L_{dn}$ ), the data necessary for its calculation, and the methods for computing it.

*Sec. A150.203 Symbols.*

The following symbols are used in the computation of  $L_{dn}$ :

Measure (in dB)	Symbol
Average Sound Level, During Time T .....	$L_T$
Day-Night Average Sound Level (individual day) ...	$L_{dni}$
Yearly Day-Night Average Sound Level .....	$L_{dn}$
Sound Exposure Level .....	$L_{AE}$

*Sec. A150.205 Mathematical computations.*

(a) Average sound level must be computed in accordance with the following formula:

$$L_{dn} = 10 \log_{10} \left[ \frac{1}{86400} \left( \int_{0000}^{0700} 10^{[L_A(t)+10]/10} dt + \int_{0700}^{2200} 10^{L_A(t)/10} dt + \int_{2200}^{2400} 10^{[L_A(t)+10]/10} dt \right) \right] \quad (3)$$

Time is in seconds, so the limits shown in hours and minutes are actually interpreted in seconds. It is often convenient to compute day-night average sound level from the one-hour average sound levels obtained during successive hours.

(c) Yearly day-night average sound level must be computed in accordance with the following formula:

$$L_{dn} = 10 \log_{10} \frac{1}{365} \sum_{i=1}^{365} 10^{L_{dni}/10} \quad (4)$$

where  $L_{dni}$  is the day-night average sound level for the  $i$ -th day out of one year.

(d) Sound exposure level must be computed in accordance with the following formula:

$$L_{AE} = 10 \log_{10} \left( \frac{1}{t_2 - t_1} \int_{t_1}^{t_2} 10^{L_A(t)/10} dt \right) \quad (5)$$

$$L_T = 10 \log_{10} \left[ \frac{1}{T} \int_0^T 10^{L_A(t)/10} dt \right] \quad (1)$$

where  $T$  is the length of the time period, in seconds, during which the average is taken;  $L_A(t)$  is the instantaneous time varying A-weighted sound level during the time period  $T$ .

NOTE: When a noise environment is caused by a number of identifiable noise events, such as aircraft flyovers, average sound level may be conveniently calculated from the sound exposure levels of the individual events occurring within a time period  $T$ :

$$L_T = 10 \log_{10} \left[ \frac{1}{T} \sum_{i=1}^n 10^{L_{AEi}/10} \right] \quad (2)$$

where  $L_{AEi}$  is the sound exposure level of the  $i$ -th event, in a series of  $n$  events in time period  $T$ , in seconds.

NOTE: When  $T$  is one hour,  $L_T$  is referred to as one-hour average sound level.

(b) Day-night average sound level (individual day) must be computed in accordance with the following formula:

where  $t_0$  is one second and  $L_A(t)$  is the time-varying A-weighted sound level in the time interval  $t_1$  to  $t_2$ .

The time interval should be sufficiently large that it encompasses all the significant sound of a designated event.

The requisite integral may be approximated with sufficient accuracy by integrating  $L_A(t)$  over the time interval during which  $L_A(t)$  lies within 10 decibels of its maximum value, before and after the maximum occurs.

[Doc. No. 18691, 49 FR 49269, Dec. 18, 1984; 50 FR 5064, Feb. 6, 1985, as amended by Amdt. 150-1, 53 FR 8724, Mar. 16, 1988; Amdt. 150-4, 69 FR 57626, Sept. 24, 2004]

**APPENDIX B TO PART 150—NOISE COMPATIBILITY PROGRAMS**

- Sec. B150.1 Scope and purpose.
- Sec. B150.3 Requirement for noise map.
- Sec. B150.5 Program standards.

## Federal Aviation Administration, DOT

## Pt. 150, App. B

Sec. B150.7 Analysis of program alternatives.

Sec. B150.9 Equivalent programs.

### *Sec. B150.1 Scope and purpose.*

(a) This appendix prescribes the content and the methods for developing noise compatibility programs authorized under this part. Each program must set forth the measures which the airport operator (or other person or agency responsible) has taken, or proposes to take, for the reduction of existing noncompatible land uses and the prevention of the introduction of additional noncompatible land uses within the area covered by the noise exposure map submitted by the operator.

(b) The purpose of a noise compatibility program is:

(1) To promote a planning process through which the airport operator can examine and analyze the noise impact created by the operation of an airport, as well as the costs and benefits associated with various alternative noise reduction techniques, and the responsible impacted land use control jurisdictions can examine existing and forecast areas of noncompatibility and consider actions to reduce noncompatible uses.

(2) To bring together through public participation, agency coordination, and overall cooperation, all interested parties with their respective authorities and obligations, thereby facilitating the creation of an agreed upon noise abatement plan especially suited to the individual airport location while at the same time not unduly affecting the national air transportation system.

(3) To develop comprehensive and implementable noise reduction techniques and land use controls which, to the maximum extent feasible, will confine severe aircraft YDNL values of  $L_{dn}$  75 dB or greater to areas included within the airport boundary and will establish and maintain compatible land uses in the areas affected by noise between the  $L_{dn}$  65 and 75 dB contours.

### *Sec. B150.3 Requirement for noise map.*

(a) It is required that a current and complete noise exposure map and its supporting documentation as found in compliance with the applicable requirements by the FAA, per §150.21(c) be included in each noise compatibility program:

(1) To identify existing and future noncompatible land uses, based on airport operation and off-airport land uses, which have generated the need to develop a program.

(2) To identify changes in noncompatible uses to be derived from proposed program measures.

(b) If the proposed noise compatibility program would yield maps differing from those previously submitted to FAA, the program shall be accompanied by appropriately re-

vised maps. Such revisions must be prepared in accordance with the requirements of Sec. A150.101(e) of appendix A and will be accepted by FAA in accordance with §150.35(f).

### *Sec. B150.5 Program standards.*

Based upon the airport noise exposure and noncompatible land uses identified in the map, the airport operator shall evaluate the several alternative noise control actions and develop a noise compatibility program which—

(a) Reduces existing noncompatible uses and prevents or reduces the probability of the establishment of additional noncompatible uses;

(b) Does not impose undue burden on interstate and foreign commerce;

(c) Provides for revision in accordance with §150.23 of this part.

(d) Is not unjustly discriminatory.

(e) Does not derogate safety or adversely affect the safe and efficient use of airspace.

(f) To the extent practicable, meets both local needs and needs of the national air transportation system, considering tradeoffs between economic benefits derived from the airport and the noise impact.

(g) Can be implemented in a manner consistent with all of the powers and duties of the Administrator of FAA.

### *Sec. B150.7 Analysis of program alternatives.*

(a) Noise control alternatives must be considered and presented according to the following categories:

(1) Noise abatement alternatives for which the airport operator has adequate implementation authority.

(2) Noise abatement alternatives for which the requisite implementation authority is vested in a local agency or political subdivision governing body, or a state agency or political subdivision governing body.

(3) Noise abatement options for which requisite authority is vested in the FAA or other Federal agency.

(b) At a minimum, the operator shall analyze and report on the following alternatives, subject to the constraints that the strategies are appropriate to the specific airport (for example, an evaluation of night curfews is not appropriate if there are no night flights and none are forecast):

(1) Acquisition of land and interests therein, including, but not limited to air rights, easements, and development rights, to ensure the use of property for purposes which are compatible with airport operations.

(2) The construction of barriers and acoustic shielding, including the soundproofing of public buildings.

(3) The implementation of a preferential runway system.

(4) The use of flight procedures (including the modifications of flight tracks) to control

the operation of aircraft to reduce exposure of individuals (or specific noise sensitive areas) to noise in the area around the airport.

(5) The implementation of any restriction on the use of airport by any type or class of aircraft based on the noise characteristics of those aircraft. Such restrictions may include, but are not limited to—

(i) Denial of use of the airport to aircraft types or classes which do not meet Federal noise standards;

(ii) Capacity limitations based on the relative noisiness of different types of aircraft;

(iii) Requirement that aircraft using the airport must use noise abatement takeoff or approach procedures previously approved as safe by the FAA;

(iv) Landing fees based on FAA certificated or estimated noise emission levels or on time of arrival; and

(v) Partial or complete curfews.

(6) Other actions or combinations of actions which would have a beneficial noise control or abatement impact on the public.

(7) Other actions recommended for analysis by the FAA for the specific airport.

(c) For those alternatives selected for implementation, the program must identify the agency or agencies responsible for such implementation, whether those agencies have agreed to the implementation, and the approximate schedule agreed upon.

*Sec. B150.9 Equivalent programs.*

(a) Notwithstanding any other provision of this part, noise compatibility programs prepared in connection with studies which were either Federally funded or Federally approved and commenced before October 1, 1981, are not required to be modified to contain the following items:

(1) Flight tracks.

(2) A noise contour of  $L_{dn}$  70 dB resulting from aircraft operations and data related to the  $L_{dn}$  70 dB contour. When determinations on land use compatibility using Table 1 of appendix A differ between  $L_{dn}$  65–70 dB and  $L_{dn}$  70–75 dB, the determinations should either use the more conservative  $L_{dn}$  70–75 dB column or reflect determinations based on local needs and values.

(3) The categorization of alternatives pursuant to Sec. B150.7(a), although the persons responsible for implementation of each measure in the program must still be identified in accordance with §150.23(e)(8).

(4) Use of ambient noise to determine land use compatibility.

(b) Previously prepared noise compatibility program documentation may be supplemented to include these and other program requirements which have not been excepted.

## PART 151—FEDERAL AID TO AIRPORTS

### Subpart A—General Requirements

Sec.

151.1 Applicability.

151.3 National Airport Plan.

151.5 General policies.

151.7 Grants of funds: General policies.

151.9 Runway clear zones: General.

151.11 Runway clear zones; requirements.

151.13 Federal-aid Airport Program: Policy affecting landing aid requirements.

151.15 Federal-aid Airport Program: Policy affecting runway or taxiway remarking.

### Subpart B—Rules and Procedures for Airport Development Projects

151.21 Procedures: Application; general information.

151.23 Procedures: Application; funding information.

151.24 Procedures: Application; information on estimated project costs.

151.25 Procedures: Application; information as to property interests.

151.26 Procedures: Applications; compatible land use information; consideration of local community interest; relocation of displaced persons.

151.27 Procedures: Application, plans, specifications, and appraisals.

151.29 Procedures: Offer, amendment, and acceptance.

151.31 Procedures: Grant agreement.

151.33 Cosponsorship and agency.

151.35 Airport development and facilities to which subparts B and C apply.

151.37 Sponsor eligibility.

151.39 Project eligibility.

151.41 Project costs.

151.43 United States share of project costs.

151.45 Performance of construction work: General requirements.

151.47 Performance of construction work: Letting of contracts.

151.49 Performance of construction work: Contract requirements.

151.51 Performance of construction work: Sponsor force account.

151.53 Performance of construction work: Labor requirements.

151.54 Equal employment opportunity requirements: Before July 1, 1968.

151.54a Equal employment opportunity requirements: After June 30, 1968.

151.55 Accounting and audit.

151.57 Grant payments: General.

151.59 Grant payments: Land acquisition.

151.61 Grant payments: Partial.

151.63 Grant payments: Semifinal and final.

151.65 Memoranda and hearings.

151.67 Forms.

## Federal Aviation Administration, DOT

## § 151.5

### Subpart C—Project Programing Standards

- 151.71 Applicability.
- 151.72 Incorporation by reference of technical guidelines in Advisory Circulars.
- 151.73 Land acquisition.
- 151.75 Preparation of site.
- 151.77 Runway paving: General rules.
- 151.79 Runway paving: Second runway; wind conditions.
- 151.80 Runway paving: Additional runway; other conditions.
- 151.81 Taxiway paving.
- 151.83 Aprons.
- 151.85 Special treatment areas.
- 151.86 Lighting and electrical work: General.
- 151.87 Lighting and electrical work: Standards.
- 151.89 Roads.
- 151.91 Removal of obstructions.
- 151.93 Buildings; utilities; sidewalks; parking areas; and landscaping.
- 151.95 Fences; distance markers; navigational and landing aids; and offsite work.
- 151.97 Maintenance and repair.
- 151.99 Modifications of programing standards.

### Subpart D—Rules and Procedures for Advance Planning and Engineering Proposals

- 151.111 Advance planning proposals: General.
- 151.113 Advance planning proposals: Sponsor eligibility.
- 151.115 Advance planning proposals: Cosponsorship and agency.
- 151.117 Advance planning proposals: Procedures; application.
- 151.119 Advance planning proposals: Procedures; funding.
- 151.121 Procedures: Offer; sponsor assurances.
- 151.123 Procedures: Offer; amendment; acceptance; advance planning agreement.
- 151.125 Allowable advance planning costs.
- 151.127 Accounting and audit.
- 151.129 Payments.
- 151.131 Forms.

APPENDIX A TO PART 151  
APPENDIX B TO PART 151  
APPENDIX C TO PART 151  
APPENDIX D TO PART 151  
APPENDIX E TO PART 151  
APPENDIX F TO PART 151  
APPENDIX G TO PART 151  
APPENDIX H TO PART 151  
APPENDIX I TO PART 151

### Subpart A—General Requirements

AUTHORITY: 49 U.S.C. 106(g), 40113, 47151, 47153.

### § 151.1 Applicability.

This part prescribes the policies and procedures for administering the Federal-aid Airport Program under the Federal Airport Act, as amended (49 U.S.C. 1101 et seq.).

[Doc. No. 1329, 27 FR 12349, Dec. 13, 1962]

### § 151.3 National Airport Plan.

(a) Under the Federal Airport Act, the FAA prepares each year a “National Airport Plan” for developing public airports in the United States, Puerto Rico, the Virgin Islands, and Guam. In terms of general location and type of development, the National Airport Plan specifies the maximum limits of airport development that is necessary to provide a system of public airports adequate to anticipate and meet the needs of civil aeronautics.

(b) If, within the forecast period, an airport will have a substantial aeronautical necessity, it may be included in the National Airport Plan. Only work on an airport included in the current Plan is eligible for inclusion in the Federal-aid Airport Program to be undertaken within currently available appropriations and authorizations. However, the inclusion of an airport in the National Airport Plan does not commit the United States to include it in the Federal-aid Airport Program. In addition, the local community concerned is not required to proceed with planning or development of an airport included in the National Airport Plan.

[Amdt. 151-8, 30 FR 8039, June 23, 1965]

### § 151.5 General policies.

(a) *Airport layout plan.* As used in this part, “airport layout plan” means the basic plan for the layout of an eligible airport that shows, as a minimum—

(1) The present boundaries of the airport and of the offsite areas that the sponsor owns or controls for airport purposes, and of their proposed additions;

(2) The location and nature of existing and proposed airport facilities (such as runways, taxiways, aprons, terminal buildings, hangars, and roads) and of their proposed modifications and extensions; and

§ 151.7

14 CFR Ch. I (1-1-08 Edition)

(3) The location of existing and proposed non-aviation areas, and of their existing improvements.

All airport development under the Federal-aid Airport Program must be done in accordance with an approved airport layout plan. Each airport layout plan, and any change in it, is subject to FAA approval. The Administrator's signature on the face of an original airport layout plan, or of any change in it, indicates FAA approval. The FAA approves an airport layout plan only if the airport development is sound and meets applicable requirements.

(b) *Safe, useful, and usable unit.* Except as provided in paragraph (d) of this section, each advance planning and engineering proposal or airport development project must provide for the planning or development of—

(1) An airport or unit of an airport that is safe, useful, and usable; or

(2) An additional facility that increases the safety, usefulness, or usability of an airport.

(c) *National defense needs.* The needs of national defense are fully considered in administering the Federal-aid Airport Program. However, approval of an advance planning and engineering proposal or a project application is limited to planning or airport development necessary for civil aviation.

(d) *Stage development.* In any case in which airport development can be accomplished more economically under stage construction, federal funds may be programmed in advance for the development over two or more years under two or more grant agreements. In such a case, the FAA makes a tentative allocation of funds for both the current and future fiscal years, rather than allocating the entire federal share in one fiscal year. A grant agreement is made only during the fiscal year in which funds are authorized to be obligated. Advance planning and engineering grants are not made under this paragraph.

[Amdt. 151-8, 30 FR 8039, June 23, 1965]

§ 151.7 Grants of funds: General policies.

(a) *Compliance with sponsorship requirements.* The FAA authorizes the expenditure of funds under the Federal-aid Airport Program for airport plan-

ning and engineering or for airport development only if the Administrator is satisfied that the sponsor has met or will meet the requirements established by existing and proposed agreements with the United States with respect to any airport that the sponsor owns or controls.

(1) Agreements with the United States to which this requirement of compliance applies include—

(i) Any grant agreement made under the Federal-aid Airport Program;

(ii) Any covenant in a conveyance under section 16 of the Federal Airport Act;

(iii) Any covenant in a conveyance of surplus airport property either under section 13(g) of the Surplus Property Act (50 U.S.C. App. 1622(g)) or under Regulation 16 of the War Assets Administration; and

(iv) Any AP-4 agreement made under the terminated Development Landing Areas National Defense Program and the Development Civil Landing Areas Program.

This requirement does not apply to assurances required under section 602 of the Civil Rights Act of 1964 (42 U.S.C. 2000d-1) and §15.7 of the Federal Aviation Regulations (14 CFR 15.7).

(2) If it appears that a sponsor has failed to comply with a requirement of an agreement with the United States with respect to an airport, the FAA notifies him of this fact and affords him an opportunity to submit materials to refute the allegation of noncompliance or to achieve compliance.

(3) If a project is otherwise eligible under the Federal-aid Airport Program, a grant may be made to a sponsor who has not complied with an agreement if the sponsor shows—

(i) That the noncompliance is caused by factors beyond his control; or

(ii) That the following circumstances exist:

(a) The noncompliance consisted of a failure, through mistake or ignorance, to perform minor conditions in old agreements with the Federal Government; and

(b) The sponsor is taking reasonable action promptly to correct the deficiency or the deficiency relates to an obligation that is no longer required

## Federal Aviation Administration, DOT

## § 151.11

for the safe and efficient use of the airport under existing law and policy.

(b) *Small proposals and projects.* Unless there is otherwise a special need for U.S. participation, the FAA includes an advance planning and engineering proposal or an airport development project in the Federal-aid Airport Program only if—

(1) The advance planning and engineering proposal involves more than \$1,000 in United States funds; and

(2) The project application involves more than \$5,000 in U.S. funds.

Whenever possible, the sponsor must consolidate small projects on a single airport in one grant agreement even though the airport development is to be accomplished over a period of years.

(c) *Previously obligated work.* Unless the Administrator specifically authorizes it, no advance planning and engineering proposal or project application may include any planning, engineering, or construction work included in a prior agreement with the United States obligating the sponsor or any other non-U.S. public agency to do the work, and entitling the sponsor or any other non-United States public agency to payment of U.S. funds for all or part of the work.

(Secs. 1-15, 17-21, 60 Stat. 170, 49 U.S.C. 1120)

[Amdt. 151-8, 30 FR 8039, June 23, 1965, as amended by Amdt. 151-17, 31 FR 16524, Dec. 28, 1966; Amdt. 151-19, 32 FR 9220, June 29, 1967]

### § 151.9 Runway clear zones: General.

(a) Whenever funds are allocated for developing new runways or landing strips, or to improve or repair existing runways, the sponsor must own, acquire, or agree to acquire, runway clear zones. Exceptions are considered (on the basis of a full statement of facts by the sponsor) upon a showing of uneconomical acquisition costs, or lack of necessity for the acquisition.

(b) For the purpose of this part, a runway clear zone is an area at ground level which begins at the end of each primary surface defined in § 77.27(a) and extends with the width of each approach surface defined in § 77.27 (b) and (c), to terminate directly below each approach surface slope at the point, or points, where the slope reaches a

height of 50 feet above the elevation of the runway or 50 feet above the terrain at the outer extremity of the clear zone, whichever distance is shorter.

(c) For the purposes of this section, an airport operator or owner is considered to have an adequate property interest if it has an easement (or a covenant running with the land) giving it enough control to rid the clear zone of all obstructions (objects so far as they project above the approach surfaces established by § 77.27 (b) and (c) of part 77 of this chapter), and to prevent the creation of future obstructions; together with the right of entrance and exit for those purposes, to ensure the safe and unrestricted passage of aircraft in and over the area.

[Doc. No. 1329, 27 FR 12349, Dec. 13, 1962, as amended by Amdt. 151-7, 30 FR 7484, June 8, 1965; Amdt. 151-21, 33 FR 258, Jan. 9, 1968]

### § 151.11 Runway clear zones; requirements.

(a) In projects involving grants-in-aid under the Federal-aid Airport Program, a sponsor must own, acquire, or agree to acquire an adequate property interest in runway clear zone areas as prescribed in paragraph (b), (c), (d), or (e) of this section, as applicable. Property interests that a sponsor acquires to meet the requirements of this section are eligible for inclusion in the Program.

(b) On new airports, the sponsor must own, acquire, or agree to acquire adequate property interests in runway clear zone areas (in connection with initial land acquisition) for all eligible runways or landing strips, without substantial deviation from standard configuration and length.

(c) On existing airports where new runways or landing strips are developed, the sponsor must own, acquire, or agree to acquire adequate property interests in runway clear zone areas for each runway and landing strip to be developed or extended, to the extent that the Administrator determines practical and feasible considering all facts presented by the airport owner or operator, preferably without substantial deviation from standard configuration and length.

(d) On existing airports where improvements are made to runways or

## § 151.13

landing strips, the sponsor must own, acquire, or agree to acquire adequate property interests in runway clear zone areas for each runway or landing strip that is to be improved to the extent that the Administrator determines is practical and feasible with regard to standard configuration, length, and property interests, considering all facts presented by the airport owner or operator. Any development that improves a specific runway or landing strip is considered to be a runway improvement, including runway lighting and the developing or lighting of taxiways serving a runway.

(e) On existing airports where substantial improvements are made that do not benefit a specific runway or landing strip, such as overall grading or drainage, terminal area or building developments, the sponsor must own, acquire, or agree to acquire adequate property interests in runway clear zone areas for the dominant runway or landing strip to the extent that the Administrator determines is practical and feasible, with regard to standard configuration, length, and property interests, considering all facts presented by the airport owner or operator.

(f) If a sponsor or other public agency shows that it is legally able to prevent the future erection or creation of obstructions in the runway clear zone area, and adopts protective measures to prohibit their future erection or creation, that showing is acceptable for the purposes of paragraphs (d) and (e) of this section in place of an adequate property interest (except for rights required for removing existing obstructions). In such a case, there must be an agreement between the FAA and the sponsor for removing or marking or lighting (to be determined in each case) any existing obstruction to air navigation. In each case, the sponsor must furnish information as to the specific height limitations established and as to the current and foreseeable future use of the property to which they apply. The information must include an acceptable legal opinion of the validity of the measures adopted, including a conclusion that the height limitations are not unreasonable in view of current and foreseeable future use of the property, and are a reasonable ex-

## 14 CFR Ch. I (1-1-08 Edition)

ercise of the police power, together with the reasons or basis supporting the opinion.

(g) The authority exercised by the Administrator under paragraphs (b), (c), (d), and (e) of this section to allow a deviation from, or the extent of conformity to, standard configuration or length of runway clear zones, or to determine the adequacy of property interests therein, is also exercised by Regional Directors.

[Doc. No. 1329, 27 FR 12350, Dec. 13, 1962, as amended by Amdt. 151-22, 33 FR 8267, June 4, 1968; Amdt. 151-25, 33 FR 14535, Sept. 27, 1968]

### § 151.13 Federal-aid Airport Program: Policy affecting landing aid requirements.

(a) *Landing aid requirements.* No project for developing or improving an airport may be approved for the Program unless it provides for acquiring or installing such of the following landing aids as the Administrator determines are needed for the safe and efficient use of the airport by aircraft, considering the category of the airport and the type and volume of traffic using it:

- (1) Land needed for installing approach lighting systems (ALS).
- (2) In-runway lighting.
- (3) High intensity runway lighting.
- (4) Runway distance markers.

For the purposes of this section “approach lighting system (ALS)” is a standard configuration of aeronautical ground lights in the approach area to a runway or channel to assist a pilot in making an approach to the runway or channel.

(b) *Specific landing aid requirements.* The landing aids set forth in paragraphs (a) (1) through (4) of this section are required for the safe and efficient use of airports by aircraft in the following cases:

(1) Lands for installing approach lighting systems are required as part of a project if the installing of the components of the system on the airport is in an approved FAA budget, unless the sponsor has already acquired the land necessary for the system or is otherwise undertaking to acquire that land. If the sponsor is otherwise undertaking to acquire the land, the grant agreement for the project must obligate the sponsor to complete the acquisition

within a time limit prescribed by the Administrator. The Administrator immediately notifies a sponsor when a budget is approved providing for installing an approach lighting system at the airport concerned.

(2) In-runway lighting is required as part of a project:

(i) If the project includes:

(a) Construction of a new runway designated by the FAA as an instrument landing runway for which the installation of an IFR precision approach system including ALS and ILS, has been programmed by the FAA with funds then available therefor;

(b) An extension of 3,000 feet or more (usable for landing purposes) of the approach end of a designated instrument landing runway equipped, or programed by the FAA, with funds then available therefor, to be equipped, with an IFR precision approach system including ALS and ILS;

(c) Reconstruction of a designated instrument landing runway equipped, or programed by the FAA, with funds then available therefor, to be equipped with an IFR precision approach system including ALS and ILS, if the reconstruction requires the closing of the runway; or

(d) Any other airport development on an airport whose designated instrument landing runway is equipped, or programed by the FAA, with funds then available therefor, to be equipped with an IFR precision approach system including ALS and ILS; and

(ii) Only if a study of the airport shows that in-runway lighting is required for the safe and efficient use of the airport by aircraft, after the Administrator considers the following:

(a) The type and volume of flight activity;

(b) Other existing or planned navigational aids;

(c) Airport environmental factors such as local weather conditions and adjacent geographic profiles;

(d) Approach and departure paths;

(e) Effect on landing and takeoff minima; and

(f) In the case of projects under paragraph (b)(2)(i)(d) of this section, whether installing in-runway lighting requires closing the runway for so long a time that the adverse effect on safety

of its closing would outweigh the contribution to safety that would be gained by the in-runway lights or whether it would unduly interfere with the efficiency of aircraft operations.

(3) High intensity runway edge lighting on the designated instrument landing runway is required as a part of a project whenever that runway is equipped or programmed for the installation of an ILS and high intensity runway edge lights are not then installed on the runway or included in another project. A project for extending a runway that has high intensity runway edge lights on the existing runway requires, as a part of the project, the extension of the high intensity runway edge lights.

(4) Runway distance markers whose design standards have been approved and published by the FAA are required as a part of a project on a case-by-case basis if, after reviewing the pertinent facts and circumstances of the case, the Administrator determines that they are needed for the safe and efficient use of the airport by aircraft.

[Doc. No. 1329, 27 FR 12350, Dec. 13, 1962, as amended by Amdt. 151-3, 28 FR 12613, Nov. 27, 1963; Amdt. 151-33, 34 FR 9708, June 21, 1969]

**§ 151.15 Federal-aid Airport Program: Policy affecting runway or taxiway remarking.**

No project for developing or improving an airport may be approved for the Program unless it provides for runway or taxiway remarking if the present marking is obliterated by construction, alteration or repair work included in a FAAP project or by the required routing of construction equipment used therein.

[Amdt. 151-17, 31 FR 16524, Dec. 28, 1966]

**Subpart B—Rules and Procedures for Airport Development Projects**

AUTHORITY: 49 U.S.C. 106(g), 40113, 47151, 47153.

SOURCE: Docket No. 1329, 27 FR 12351, Dec. 13, 1962, unless otherwise noted.

**§ 151.21 Procedures: Application; general information.**

(a) An eligible sponsor that desires to obtain Federal aid for eligible airport

## § 151.23

development must submit to the Area Manager of the area in which the sponsor is located (hereinafter in this part referred to as the "Area Manager"), a request on FAA Form 5100-3, accompanied by—

(1) The sponsor's written statement as to whether the proposed project involves the displacement and relocation of persons residing on land physically acquired or to be acquired for the project development; and

(2) The sponsor's written assurance, if the project involves displacement and relocation of such persons, that adequate replacement housing will be available or provided for (built, if necessary), without regard to their race, color, religion, sex, or national origin, before the execution of a grant agreement for the project.

(b) A proposed project is selected for inclusion in a program only if the sponsor has submitted a written assurance when required by paragraph (a)(2) of this section, or if the Administrator has determined that the project does not involve the displacement and relocation of persons residing on land to be physically acquired or to be acquired for the project development. If the Administrator selects a proposed project for inclusion in a program, a tentative allocation of funds is made for it and the sponsor is notified of the allocation. The tentative allocation may be withdrawn if the sponsor fails to submit an acceptable project application as provided in paragraph (c) of this section or fails to proceed diligently with the project, or if adequate replacement housing is not available or provided for in accordance with a written assurance when required by paragraph (a)(2) of this section.

(c) As soon as practicable after receiving notice of the tentative allocation, the sponsor must submit a project application on FAA Form 1624 to the Area Manager, without changing the language of the form, unless the change is approved in advance by the Administrator. In the case of a joint project, each sponsor executes only those provisions of the project application that apply to it. A sponsor who has executed a grant agreement for a project for the development of an airport under the Program, may, in the

## 14 CFR Ch. I (1-1-08 Edition)

Administrator's discretion, submit additional project applications on FAA Form 1624 for further development of that airport.

(49 U.S.C. 1120, 1655(c); sec. 6(c), Dept. of Transportation Act; sec. 1.4(b)(1) of the regulations of the Office of the Secretary of Transportation; Federal Airport Act, as amended)

[Doc. No. 1329, 27 FR 12351, Dec. 13, 1962, as amended by Amdt. 151-11, 31 FR 6686, May 5, 1966; Amdt. 151-32, 34 FR 9617, June 19, 1969; Amdt. 151-39, 35 FR 5536, Apr. 3, 1970]

### § 151.23 Procedures: Application; funding information.

Each sponsor must state in its application that it has on hand, or show that it can obtain as needed, funds to pay all estimated costs of the proposed project that are not borne by the United States or by another sponsor. If any of the funds are to be furnished to a sponsor, or used to pay project costs on behalf of a sponsor, by a State agency or any other public agency that is not a sponsor of the project, that agency may, instead of the sponsor, submit evidence that the funds will be provided if the project is approved.

[Doc. No. 1329, 27 FR 12351, Dec. 13, 1962, as amended by Amdt. 151-34, 34 FR 12883, Aug. 8, 1969]

### § 151.24 Procedures: Application; information on estimated project costs.

(a) If any part of the estimated project costs consists of the value of donated land, labor, materials, or equipment, or of the value of a property interest in land acquired at a cost that (as represented by the sponsor) is not the actual cost or the amount of an award in eminent domain proceedings, the sponsor must so state in the application, indicating the nature of the donation or other transaction and the value it places on it.

(b) If, after the grant agreement is executed and before the final payment of the allowable project costs is made under § 151.63, it appears that the sponsor inadvertently or unknowingly failed to comply with paragraph (a) of this section as to any item, the Administrator—

(1) Makes or obtains an appraisal of the item, and if the appraised value is less than the value placed on the item

## Federal Aviation Administration, DOT

## § 151.26

in the project application, notifies the sponsor that it may, within a stated time, ask in writing for reconsideration of the appraisal and submit statements of pertinent facts and opinion; and

(2) Adjusts the U.S. share of the project costs to reflect any decrease in value of the item below that stated in the project application.

[Amdt. 151-34, 34 FR 12883, Aug. 8, 1969]

### **§ 151.25 Procedures: Application; information as to property interests.**

(a) Each sponsor must state in its application all of the property interests that he holds in the lands to be developed or used as part of, or in connection with, the airport as it will be when the project is completed. Each project application contains a covenant on the part of the sponsor to acquire, before starting construction work, or within a reasonable time if not needed for the construction, property interests satisfactory to the Administrator in all the lands in which it does not hold those property interests at the time it submits the application. In the case of a joint project, any one or more of the sponsors may hold or acquire the necessary property interests. In such a case, each sponsor may show on its application only those property interests that it holds or is to acquire.

(b) Each sponsor of a project must send with its application a property map (designated as Exhibit A) or incorporate such a map by reference to one in a previous application that was approved. The sponsor must clearly identify on the map all property interests required in paragraph (a) of this section, showing prior and proposed acquisitions for which United States aid is requested under the project.

(c) For the purposes of paragraphs (a) and (b) of this section, the property interest that the sponsor must have or agree to obtain, is—

(1) Title free and clear of any reversionary interest, lien, easement, lease, or other encumbrance that, in the opinion of the Administrator, would create an undue risk that it might deprive the sponsor of possession or control, interfere with its use for public airport purposes, or make it impossible for the sponsor to carry out the agree-

ments and covenants in the application;

(2) A lease of not less than 20 years granted to the sponsor by another public agency that has title as described in paragraph (c)(1) of this section, on terms that the Administrator considers satisfactory; or

(3) In the case of an offsite area an agreement, easement, leasehold, or other right or property interest that, in the Administrator's opinion, provides reasonable assurance that the sponsor will not be deprived of its right to use the land for the intended purpose during the period necessary to meet the requirements of the grant agreement.

(d) For the purposes of this section, the word "land" includes landing areas, building areas, runway clear zones, clearways and approach zones, and areas required for offsite construction, entrance roads, drainage, protection of approaches, installation of air navigation facilities, or other airport purposes.

### **§ 151.26 Procedures: Applications; compatible land use information; consideration of local community interest; relocation of displaced persons.**

(a) Each sponsor must state in its application the action that it has taken to restrict the use of land adjacent to or in the immediate vicinity of the airport to activities and purposes compatible with normal airport operations including landing and take-off of aircraft. The sponsor's statement must include information on—

(1) Any property interests (such as airspace easements or title to airspace) acquired by the sponsor to assure compatible land use, or to protect or control aerial approaches;

(2) Any zoning laws enacted or in force restricting the use of land adjacent to or in the vicinity of the airport, or assuring protection or control of aerial approaches, whether or not enacted by the sponsor; and

(3) Any action taken by the sponsor to induce the appropriate government authority to enact zoning laws restricting the use of land adjacent to or

**§ 151.27**

**14 CFR Ch. I (1-1-08 Edition)**

in the vicinity of the airport, or assuring protection or control of aerial approaches, when the sponsor lacks the power to zone the land.

(b) Each sponsor must submit with his application—

(1) A written statement—

(i) Specifying what consideration has been given to the interest of all communities in or near which the project is located; and

(ii) Containing the substance of any objection to, or approval of, the proposed project made known to the sponsor by any local individual, group or community; and

(2) A written statement showing that adequate replacement housing that is open to all persons, regardless of race, color, religion, sex, or national origin, is available and has been offered on the same nondiscriminatory basis to persons who have resided on land physically acquired or to be acquired for the project development and who will be displaced thereby.

[Amdt. 151-8, 30 FR 8039, June 23, 1965, as amended by Amdt. 151-17, 31 FR 16524, Dec. 28, 1966; Amdt. 151-39, 35 FR 5537, Apr. 3, 1970]

**§ 151.27 Procedures: Application, plans, specifications, and appraisals.**

(a) Except as provided in paragraph (b) of this section, each sponsor shall incorporate by reference in its project application the final plans and specifications, describing the items of airport development for which it requests United States aid. It must submit the plans and specifications with the application unless they were previously submitted or are submitted with that of another sponsor of the project.

(b) In special cases, the Administrator authorizes the postponement of the submission of final plans and specifications until a later date to be specified in the grant agreement, if the sponsor has submitted—

(1) An airport layout plan approved by the Administrator; and

(2) Preliminary plans and specifications in enough detail to identify all items of development included in the project, and prepared so as to provide for accomplishing the project in accordance with the master plan layout,

the rules in subparts B and C and applicable local laws and regulations.

(c) If the project involves acquiring a property interest in land by donation, or at a cost that (as represented by the sponsor) is not the actual cost or the amount of an award in eminent domain proceedings, the Administrator, before passing on the eligibility of the project makes or obtains an appraisal of the interest. If the appraised value is less than the value placed on the interest by the sponsor (§151.23), the Administrator notifies the sponsor that he may within a stated time, ask in writing for reconsideration of the appraisal and submit statements of pertinent facts and opinion.

[Doc. No. 1329, 27 FR 12351, Dec. 13, 1962 as amended by Amdt. 151-8, 30 FR 8039, June 23, 1965; Amdt. 151-17, 31 FR 16524, Dec. 28, 1966]

**§ 151.29 Procedures: Offer, amendment, and acceptance.**

(a) Upon approving a project, the Administrator makes an offer to the sponsor to pay the United States share of the allowable project costs. The offer states a definite amount as the maximum obligation of the United States, and is subject to change or withdrawal by the Administrator, in his discretion, at any time before it is accepted.

(b) If, before the sponsor accepts the offer, it is determined that the maximum obligation of the United States stated in the offer is not enough to pay the United States share of the allowable project costs, the sponsor may request an increase in the amount in the offer, through the Area Manager.

(c) An official of the sponsor must accept the offer for the sponsor within the time prescribed in the offer, and in the required number of counterparts, by signing it in the space provided. The signing official must have been authorized to sign the acceptance by a resolution or ordinance adopted by the sponsor's governing body. The resolution or ordinance must, as appropriate under the local law—

(1) Set forth the terms of the offer at length; or

(2) Have a copy of the offer attached to the resolution or ordinance and incorporated into it by reference.

The sponsor must attach a certified copy of the resolution to each executed

copy of an accepted offer or grant agreement that it is required to send to the Area Manager.

**§ 151.31 Procedures: Grant agreement.**

(a) An offer by the Administrator, and acceptance by the sponsor, as set forth in §151.29, constitute a grant agreement between the sponsor and the United States. Except as provided in §151.41(c)(3), the United States does not pay, and is not obligated to pay, any part of the project costs that have been or may be incurred, before the grant agreement is executed.

(b) The Administrator and the sponsor may agree to a change in a grant agreement if—

(1) The change does not increase the maximum obligation of the United States under the grant agreement by more than 10 percent;

(2) The change provides only for airport development that meets the requirements of subparts B and C; and

(3) The change does not prejudice the interests of the United States.

(c) When a change is agreed to, the Administrator issues a supplemental agreement incorporating the change. The sponsor must accept the supplemental agreement in the manner provided in §151.29(c).

[Doc. No. 1329, 27 FR 12351, Dec. 13, 1962, as amended by Amdt. 151-8, 30 FR 8040, June 23, 1965]

**§ 151.33 Cosponsorship and agency.**

(a) Any two or more public agencies that desire to participate either in accomplishing development under a project or in maintaining or operating the airport, may cosponsor it if they meet the requirements of subparts B and C, including—

(1) The eligibility requirements of §151.37; and

(2) The submission of a single project application, executed by each sponsor, clearly stating the certifications, representations, warranties, and obligations made or assumed by each, or a separate application by each that does not meet all the requirements of subparts B and C if in the Administrator's opinion, the applications collectively meet the requirements of subparts B and C as applied to a project with a single sponsor.

(b) A public agency that desires to participate in a project only by contributing funds to a sponsor need not become a sponsor or an agent of the sponsor, as provided in this section. However, any funds that it contributes are considered as funds of the sponsor for the purposes of the Federal Airport Act and this part.

(c) If the sponsors of a joint project are not each willing to assume, jointly and severally, the obligations that subparts B and C requires a sponsor to assume, they must send a true copy of an agreement between them, satisfactory to the Administrator, to be incorporated into the grant agreement. Each agreement must state—

(1) The responsibilities of each sponsor to the others with respect to accomplishing the proposed development and operating and maintaining the airport;

(2) The obligations that each will assume to the United States; and

(3) The name of the sponsor or sponsors who will accept, receipt for, and disburse grant payments.

If an offer is made to the sponsors of a joint project, as provided in §151.29, it contains a specific condition that it is made in accordance with the agreement between the sponsors (and the agreement is incorporated therein by reference) and that, by accepting the offer, each sponsor assumes only its respective obligations as set forth in the agreement.

(d) A public agency may, if it is authorized by local law, act as agent of the public agency that is to own and operate the airport, with or without participating financially and without becoming a sponsor. The terms and conditions of the agency and the agent's authority to act for the sponsor must be set forth in an agency agreement that is satisfactory to the Administrator. The sponsor must submit a true copy of the agreement with the project application. Such an agent may accept, on behalf of the sponsor, an offer made under §151.29, only if that acceptance has been specifically and legally authorized by the sponsor's governing body and the authority is specifically set forth in the agency agreement.

## § 151.35

(e) When the cosponsors of an airport are not located in the same area, they must submit a joint request to the Area Manager of the area in which the airport development will be located.

[Doc. No. 1329, 27 FR 12351, Dec. 13, 1962, as amended by Amdt. 151-8, 30 FR 8040, June 23, 1965; Amdt. 151-11, 31 FR 6686, May 5, 1966]

### § 151.35 Airport development and facilities to which subparts B and C apply.

(a) Subparts B and C applies to the following kinds of airport development:

(1) Any work involved in constructing, improving, or repairing a public airport or part thereof, including the constructing, altering, or repairing of only those buildings or parts thereof that are intended to house facilities or activities directly related to the safety of persons at the airport.

(2) Removing, lowering, relocating, marking, and lighting of airport hazards as defined in § 151.39(b).

(3) Acquiring land or an interest therein, or any easement through or other interest in air space, that is necessary to allow any work covered by paragraph (a)(1) or (2) of this section, or to remove or mitigate, or prevent or limit the establishment of, airport hazards as defined in § 151.39(b).

It does not apply to the constructing, altering, or repair of airport hangars or public parking facilities for passenger automobiles.

(b) The airport facilities to which subparts B and C applies are those structures, runways, or other items, on or at an airport, that are—

(1) Used or intended to be used, in connection with the landing, takeoff, or maneuvering of aircraft, or for or in connection with operating and maintaining the airport itself; or

(2) Required to be located at the airport for use by the users of its aeronautical facilities or by airport operators, concessionaires, and other users of the airport in connection with providing services or commodities to the users of those aeronautical facilities.

(c) For the purposes of subparts B and C, “public airport” means an airport used for public purposes, under the control of a public agency named in

## 14 CFR Ch. I (1-1-08 Edition)

§ 151.37(a), with a publicly owned landing area.

[Doc. No. 1329, 27 FR 12351, Dec. 13, 1962, as amended by Amdt. 151-8, 30 FR 8040, June 23, 1965]

### § 151.37 Sponsor eligibility.

To be eligible to apply for an individual or joint project for development with respect to a particular airport a sponsor must—

(a) Be a public agency, which includes for the purposes of this part only, a State, the District of Columbia, Puerto Rico, the Virgin Islands, Guam or an agency of any of them; a municipality or other political subdivision; a tax-supported organization; or the United States or an agency thereof;

(b) Be legally, financially, and otherwise able to—

(1) Make the certifications, representations, and warranties in the application form prescribed in § 151.67(a);

(2) Make, keep, and perform the assurances, agreements, and covenants in that form; and

(3) Meet the other applicable requirements of the Federal Airport Act and subparts B and C;

(c) Have, or be able to obtain, enough funds to meet the requirements of § 151.23; and

(d) Have, or be able to obtain, property interests that meet the requirements of § 151.25(a).

For the purpose of paragraph (a) of this section, the United States, or an agency thereof, is not eligible for a project under subparts B and C, unless the project—

(1) Is located in Puerto Rico, the Virgin Islands, or Guam;

(2) Is in or is in close proximity to a national park, a national recreation area, or a national monument; or

(3) Is in a national forest or a special reservation for United States purposes.

[Doc. No. 1329, 27 FR 12351, Dec. 13, 1962, as amended by Amdt. 151-8, 30 FR 8040, June 23, 1965]

### § 151.39 Project eligibility.

(a) A project for construction or land acquisition may not be approved under subparts B and C unless—

(1) It is an item of airport development described in § 151.35(a);

**Federal Aviation Administration, DOT**

**§ 151.39**

(2) The airport development is within the scope of the current National Airport Plan;

(3) The airport development is, in the opinion of the Administrator, reasonably necessary to provide a needed civil airport facility;

(4) The Administrator is satisfied that the project is reasonably consistent with existing plans of public agencies for the development of the area in which the airport is located and will contribute to the accomplishment of the purposes of the Federal-aid Airport Program;

(5) The Administrator is satisfied, after considering the pertinent information including the sponsor's statements required by §151.26(b), that—

(i) Fair consideration has been given to the interest of all communities in or near which the project is located; and

(ii) Adequate replacement housing that is open to all persons, regardless of race, color, religion, sex, or national origin, is available and has been offered on the same nondiscriminatory basis to persons who have resided on land physically acquired or to be acquired for the project development and have been or will be displaced thereby;

(6) The project provides for installing such of the landing aids specified in section 10(d) of the Federal Airport Act (49 U.S.C. 1109(d)) as the Administrator considers are needed for the safe and efficient use of the airport by aircraft, based on the category of the airport and the type and volume of its traffic.

(b) Only the following kinds of airport development described in §151.35(a) are eligible to be included in a project under subparts B and C:

(1) Preparing all or part of an airport site, including clearing, grubbing filling and grading.

(2) Dredging of seaplane anchorages and channels.

(3) Drainage work, on or off the airport or airport site.

(4) Constructing, altering, or repairing airport buildings or parts thereof to the extent that it is covered by §151.35(a).

(5) Constructing, altering, or repairing runways, taxiways, and aprons, including—

(i) Bituminous resurfacing of pavements with a minimum of 100 pounds of

plant-mixed material for each square yard;

(ii) Applying bituminous surface treatment on a pavement (in accordance with FAA Specification P-609), the existing surface of which consists of that kind of surface treatment; and

(iii) Resealing a runway that has been substantially extended or partially reconstructed, if that resealing is necessary for the uniform color and appearance of the runway.

(6) Fencing, erosion control, seeding and sodding of an airport or airport site.

(7) Installing, altering, or repairing airport markers and runway, taxiway and apron lighting facilities and equipment.

(8) Constructing, altering, or repairing entrance roads and airport service roads.

(9) Constructing, installing, or connecting utilities, either on or off the airport or airport site.

(10) Removing, lowering, relocating marking, or lighting any airport hazard.

(11) Clearing, grading, and filling to allow the installing of landing aids.

(12) Relocating structures, roads, and utilities necessary to allow eligible airport development.

(13) Acquiring land or an interest therein, or any easement through or other interest in airspace, when necessary to—

(i) Allow other airport development to be made, whether or not a part of the Federal-aid Airport Program;

(ii) Prevent or limit the establishment of airport hazards;

(iii) Allow the removal, lowering, relocation, marking, and lighting of existing airport hazards;

(iv) Allow the installing of landing aids; or

(v) Allow the proper use, operation, maintenance, and management of the airport as a public facility.

(14) Any other airport development described in §151.35(a) that is specifically approved by the Administrator.

For the purposes of paragraph (b)(10) of this section, an airport hazard is any structure or object of natural growth located on or in the vicinity of a public airport, or any use of land in the vicinity of the airport, that obstructs the

## § 151.41

## 14 CFR Ch. I (1-1-08 Edition)

airspace needed for the landing or takeoff of aircraft or is otherwise hazardous to the landing or takeoff of aircraft. For the purposes of paragraph (b)(13) of this section, land acquisition includes the acquiring of land that is already developed as a private airport and the structures, fixtures, and improvements that are a part of realty (other than hangars, other ineligible structures and parts thereof, fixtures, and improvements).

(c) A project for acquiring land that has been or will be donated to the sponsor is not eligible for inclusion in the Federal-aid Airport Program, unless the project also includes other items of airport development that would require a sponsor's contribution equal to or more than the United States share of the value of the donated land as appraised by the Administrator.

[Doc. No. 1329, 27 FR 12351, Dec. 13, 1962, as amended by Amdt. 151-8, 30 FR 8040, June 23, 1965; Amdt. 151-17, 31 FR 16524, Dec. 28, 1966; Amdt. 151-37, 35 FR 5112, Mar. 26, 1970; Amdt. 151-39, 35 FR 5537, Apr. 3, 1970]

### § 151.41 Project costs.

(a) For the purposes of subparts B and C, project costs consist of any costs involved in accomplishing a project, including those of—

- (1) Making field surveys;
- (2) Preparing plans and specifications;
- (3) Accomplishing or procuring the accomplishing of the work;
- (4) Supervising and inspecting construction work;
- (5) Acquiring land, or an interest therein, or any easement through or other interest in airspace; and
- (6) Administrative and other incidental costs incurred specifically in connection with accomplishing a project, and that would not have otherwise been incurred.

(b) The costs described in paragraph (a) of this section, including the value of land, labor, materials, and equipment donated or loaned to the sponsor and appropriated to the project by the sponsor, are eligible for consideration as to their allowability, except for—

- (1) That part of the cost of rehabilitation or repair for which funds have been appropriated under section 17 of

the Federal Airport Act (49 U.S.C. 1116);

(2) That part of the cost of acquiring an existing private airport that represents the cost of acquiring passenger automobile parking facilities, buildings to be used as hangars, living quarters, or for nonairport purposes, at the airport, and those buildings or parts of buildings the construction of which is not airport development within the meaning of § 151.35(a);

(3) The cost of materials and supplies owned by the sponsor or furnished from a source of supply owned by the sponsor if—

(i) Those materials and supplies were used for airport development before the grant agreement was executed; or

(ii) The cost is not supported by proper evidence of quantity and value;

(4) The cost of nonexpendable machinery, tools, or equipment owned by the sponsor and used under a project by the sponsor's force account, except to the extent of the fair rental value of that machinery, tools, or equipment for the period it is used on the project;

(5) The costs of general area, urban, or statewide planning of airports, as distinguished from planning a specific project;

(6) The value of any land, including improvements, donated to the sponsor by another public agency; and

(7) Any costs incurred in connection with raising funds by the sponsor, including interest and premium charges and administrative expenses involved in conducting bond elections and in the sale of bonds.

(c) To be an allowable project cost, for the purposes of computing the amount of a grant, an item that is paid or incurred must, in the opinion of the Administrator—

(1) Have been necessary to accomplish airport development in conformity with the approved plans and specifications for an approved project and with the terms of the grant agreement for the project;

(2) Be reasonable in amount (or be subject to partial disallowance under section 13(a)(3) of the Federal Airport Act (49 U.S.C. 1112(a)(3)));

(3) Have been incurred after the date the grant agreement was executed, except that costs of land acquisition,

**Federal Aviation Administration, DOT**

**§ 151.45**

field surveys, planning, preparing plans and specifications, and administrative and incidental costs, may be allowed even though they were incurred before that date, if they were incurred after May 13, 1946; and

(4) Be supported by satisfactory evidence.

[Doc. No. 1329, 27 FR 12351, Dec. 13, 1962, as amended by Amdt. 151-8, 30 FR 8040, June 23, 1965; Amdt. 151-14, 31 FR 11747, Sept. 8, 1966]

**§ 151.43 United States share of project costs.**

(a) The United States share of the allowable costs of a project is stated in the grant agreement for the project, to be paid from appropriations made under the Federal Airport Act.

(b) Except as provided in paragraphs (c) and (d) of this section and in subpart C of this part, the United States share of the costs of an approved project for airport development (regardless of its size or location) is 50 percent of the allowable costs of the project.

(c) The U.S. share of the costs of an approved project for airport development in a State in which the unappropriated and unreserved public lands and nontaxable Indian lands (individual and tribal) is more than 5 percent of its total land, is the percentage set forth in the following table:

State	Percent
Alaska .....	62.50
Arizona .....	60.80
California .....	53.72
Colorado .....	52.98
Idaho .....	55.80
Montana .....	52.99
Nevada .....	62.50
New Mexico .....	56.14
Oregon .....	55.64
South Dakota .....	52.53
Utah .....	60.65
Washington .....	51.53
Wyoming .....	56.33

(d) The United States share of the costs of an approved project, representing the costs of any of the following, is 75 percent:

(1) The costs of installing high intensity runway edge lighting on a designated instrument landing runway or other runway with an approved straight-in approach procedure.

(2) The costs of installing in-runway lighting (touchdown zone lighting system, and centerline lighting system).

(3) The costs of installing runway distance markers.

(4) The costs of acquiring land, or a suitable property interest in land or in or over water, needed for installing operating, and maintaining an ALS (as described in § 151.13).

(5) The costs of any project in the Virgin Islands.

[Doc. No. 1329, 27 FR 12351, Dec. 13, 1962 as amended by Amdt. 151-17, 31 FR 16524, Dec. 28, 1966; Amdt. 151-20, 32 FR 17471; Dec. 6, 1967; Amdt. 151-35, 34 FR 13699, Aug. 27, 1969; Amdt. 151-36, 34 FR 19501 Dec. 10, 1969]

**§ 151.45 Performance of construction work: General requirements.**

(a) All construction work under a project must be performed under contract, except in a case where the Administrator determines that the project, or a part of it, can be more effectively and economically accomplished on a force account basis by the sponsor or by another public agency acting for or as agent of the sponsor.

(b) Each contract under a project must meet the requirements of local law.

(c) No sponsor may issue any change order under any of its construction contracts or enter into a supplemental agreement unless three copies of that order or agreement have been sent to and approved by the Area Manager. §§ 151.47 and 151.49 apply to supplemental agreements as well as to original contracts.

(d) This section and §§ 151.47 through 151.49 do not apply to contracts with the owners of airport hazards, (as described in § 151.39(b)), buildings, pipe lines, power lines, or other structures or facilities, for installing, extending, changing, removing, or relocating that structure or facility. However, the sponsor must obtain the approval of the Area Manager before entering into such a contract.

(e) No sponsor may allow a contractor or subcontractor to begin work under a project until—

(1) The sponsor has furnished three conformed copies of the contract to the Area Manager; and

## § 151.47

## 14 CFR Ch. I (1-1-08 Edition)

(2) The Area Manager agrees to the issuance of a notice to proceed with the work to the contractor. However, the Area Manager does not agree to the issuance of such a notice unless he is satisfied that adequate replacement housing is available and has been offered to affected persons, as required for project eligibility by § 151.39(a)(5).

(f) Except when the Area Manager determines that the sponsor has previously demonstrated satisfactory engineering and construction supervision and inspection, no sponsor may allow a contractor or subcontractor to begin work, nor may the sponsor begin force account work, until the sponsor has notified the Area Manager in writing that engineering and construction supervision and inspection have been arranged to insure that construction will conform to FAA approved plans and specifications, and that the sponsor has caused a review to be made of the qualifications of personnel who will be performing such supervision and inspection and is satisfied that they are qualified to do so.

[Doc. No. 1329, 27 FR 12351, Dec. 13, 1962, as amended by Amdt. 151-31, 34 FR 4885, Mar. 6, 1969; Amdt. 151-39, 35 FR 5537, Apr. 3, 1970]

### **§ 151.47 Performance of construction work: Letting of contracts.**

(a) *Advertising required; exceptions.* Unless the Administrator approves another method for use on a particular airport development project, each contract for construction work on a project in the amount of more than \$2,000 must be awarded on the basis of public advertising and open competitive bidding under the local law applicable to the letting of public contracts. Any oral or written agreement or understanding between a sponsor and another public agency that is not a sponsor of the project, under which that public agency undertakes construction work for or as agent of the sponsor, is not considered to be a construction contract for the purposes of this section, or §§ 151.45, 151.49, and 151.51.

(b) *Advertisement; conditions and contents.* There may be no advertisement for bids on, or negotiation of, a construction contract until the Administrator has approved the plans and specifications. The advertisement shall in-

form the bidders of the contract and reporting provisions required by § 151.54. Unless the estimated contract price or construction cost is \$2,000 or less, there may be no advertisement for bids or negotiation until the Administrator has given the sponsor a copy of a decision of the Secretary of Labor establishing the minimum wage rates for skilled and unskilled labor under the proposed contract. In each case, a copy of the wage determination decision must be set forth in the initial invitation for bids or proposed contract or incorporated therein by reference to a copy set forth in the advertised or negotiated specifications.

(c) *Procedure for the Secretary of Labor's wage determinations.* At least 60 days before the intended date of advertising or negotiating under paragraph (b) of this section, the sponsor shall send to the Area Manager, completed Department of Labor Form DB-11, with only the classifications needed in the performance of the work checked. General entries (such as "entire schedule" or "all applicable classifications") may not be used. Additional necessary classifications not on the form may be typed in the blank spaces or on an attached separate list. A classification that can be fitted into classifications on the form, or a classification that is not generally recognized in the area or in the industry, may not be used. Except in areas where the wage patterns are clearly established, the Form must be accompanied by any available pertinent wage payment or locally prevailing fringe benefit information.

(d) *Use and effectiveness of the Secretary of Labor's wage determinations.* (1) Wage determinations are effective only for 120 days from the date of the determinations. If it appears that a determination may expire between bid opening and award, the sponsor shall so advise the FAA as soon as possible. If he wishes a new request for wage determination to be made and if any pertinent circumstances have changed, he shall submit a new Form DB-11 and accompanying information. If he claims that the determination expires before award and after bid opening due to unavoidable circumstances, he shall submit proof of the facts which he claims support a finding to that effect.

(2) The Secretary of Labor may modify any wage determination before the award of the contract or contracts for which it was sought. If the proposed contract is awarded on the basis of public advertisement and open competitive bidding, any modification that the FAA receives less than 10 days before the opening of bids is not effective, unless the Administrator finds that there is reasonable time to notify bidders. A modification may not continue in effect beyond the effective period of the wage determination to which it relates. The Administrator sends any modification to the sponsor as soon as possible. If the modification is effective, it must be incorporated in the invitation for bids, by issuing an addendum to the specifications or otherwise.

(e) *Requirements for awarding construction contracts.* A sponsor may not award a construction contract without the written concurrence of the Administrator (through the Area Manager) that the contract prices are reasonable and that the contract conforms to the sponsor's grant agreement with the United States. A sponsor that awards contracts on the basis of public advertising and open competitive bidding, shall, after the bids are opened, send a tabulation of the bids and its recommendations for award to the Area Manager. The allowable project costs of the work, on which the Federal participation is computed, may not be more than the bid of the lowest responsible bidder. The sponsor may not accept a bid by a contractor whose name appears on the current list of ineligible contractors published by the Comptroller General of the United States under § 5.6(b) of Title 29 of the regulations of the Secretary of Labor (29 CFR part 5), or a bid by any firm, corporation, partnership, or association in which that contractor has a substantial interest.

(f) *Secretary of Labor's interpretations apply.* Where applicable by their terms, the regulations of the Secretary of Labor (29 CFR 5.20-5.32) interpreting the fringe benefit provisions of the Davis-Bacon Act apply to this section.

[Amdt. 151-6, 29 FR 18001, Dec. 18, 1964]

**§ 151.49 Performance of construction work: Contract requirements.**

(a) *Contract provisions.* In addition to any other provisions necessary to ensure completion of the work in accordance with the grant agreement, each sponsor entering into a construction contract for an airport development project shall insert in the contract the provisions required by the Secretary of Labor, as set forth in appendix H of this part. The Director, Airports Service, may amend any provision in appendix H from time to time to accord with rule-making action of the Secretary of Labor. The provisions in the following paragraphs also must be inserted in the contract:

(1) *Federal Aid to Airport Program Project.* The work in this contract is included in Federal-aid Airport Project No. \_\_, which is being undertaken and accomplished by the [insert sponsor's name] in accordance with the terms and conditions of a grant agreement between the [insert sponsor's name] and the United States, under the Federal Airport Act (49 U.S.C. 1101) and part 151 of the Federal Aviation Regulations (14 CFR part 151), pursuant to which the United States has agreed to pay a certain percentage of the costs of the project that are determined to be allowable project costs under that Act. The United States is not a party to this contract and no reference in this contract to the FAA or any representative thereof, or to any rights granted to the FAA or any representative thereof, or the United States, by the contract, makes the United States a party to this contract.

(2) *Consent to assignment.* The contractor shall obtain the prior written consent of the [insert sponsor's name] to any proposed assignment of any interest in or part of this contract.

(3) *Convict labor.* No convict labor may be employed under this contract.

(4) *Veterans' preference.* In the employment of labor (except in executive, administrative, and supervisory positions), preference shall be given to qualified individuals who have served in the military service of the United States (as defined in section 101(1) of the Soldiers' and Sailors' Civil Relief Act of 1940) and have been honorably discharged from that service, except that preference may be given only where that labor is available locally and is qualified to perform the work to which the employment relates.

(5) *Withholding: Sponsor from contractor.* Whether or not payments or advances to the [insert sponsor's name] are withheld or suspended by the FAA, the [insert sponsor's name] may withhold or cause to be withheld

## § 151.51

from the contractor so much of the accrued payments or advances as may be considered necessary to pay laborers and mechanics employed by the contractor or any subcontractor on the work the full amount of wages required by this contract.

(6) *Nonpayment of wages.* If the contractor or subcontractor fails to pay any laborer or mechanic employed or working on the site of the work any of the wages required by this contract the [insert sponsor's name] may, after written notice to the contractor, take such action as may be necessary to cause the suspension of any further payment or advance of funds until the violations cease.

(7) *FAA inspection and review.* The contractor shall allow any authorized representative of the FAA to inspect and review any work or materials used in the performance of this contract.

(8) *Subcontracts.* The contractor shall insert in each of his subcontracts the provisions contained in paragraphs [insert designations of 6 paragraphs of contract corresponding to paragraphs (1), (3), (4), (5), (6) and (7) of this paragraph], and also a clause requiring the subcontractors to include these provisions in any lower tier subcontracts which they may enter into, together with a clause requiring this insertion in any further subcontracts that may in turn be made.

(9) *Contract termination.* A breach of paragraphs [insert designation of 3 paragraphs corresponding to paragraphs (6), (7) and (8) of this paragraph] may be grounds for termination of the contract.

(b) *Exemption of certain contracts.* Appendix H to this part and paragraph (a)(5) of this section do not apply to prime contracts of \$2,000 or less.

(c) *Adjustment in liquidated damages.* A contractor or subcontractor who has become liable for liquidated damages under paragraph G of appendix H and who claims that the amount administratively determined as liquidated damages under section 104(a) of the Contract Work Hours Standards Act is incorrect or that he violated inadvertently the Contract Work Hours Standards Act notwithstanding the exercise of due care, may—

(1) If the amount determined is more than \$100, apply to the Administrator for a recommendation to the Secretary of Labor that an appropriate adjustment be made or that he be relieved of liability for such liquidated damages; or

(2) If the amount determined is \$100 or less, apply to the Administrator for an appropriate adjustment in liq-

## 14 CFR Ch. I (1-1-08 Edition)

uidated damages or for release from liability for the liquidated damages.

(d) *Corrected wage determinations.* The Secretary of Labor corrects any wage determination included in any contract under this section whenever the wage determination contains clerical errors. A correction may be made at the Administrator's request or on the initiative of the Secretary of Labor.

(e) *Secretary of Labor's interpretations apply.* Where applicable by their terms, the regulations of the Secretary of Labor (29 CFR 5.20-5.32) interpreting the "fringe benefit provisions" of the Davis-Bacon Act apply to the contract provisions in appendix H, and to this section.

[Amdt. 151-6, 29 FR 18001, Dec. 18, 1964, as amended by Amdt. 151-7, 30 FR 7484, June 6, 1965]

### § 151.51 Performance of construction work: Sponsor force account.

(a) Before undertaking any force account construction work, the sponsor (or any public agency acting as agent for the sponsor) must obtain the written consent of the Administrator through the Area Manager. In requesting that consent, the sponsor must submit—

(1) Adequate plans and specifications showing the nature and extent of the construction work to be performed under that force account;

(2) A schedule of the proposed construction and of the construction equipment that will be available for the project;

(3) Assurance that adequate labor, material, equipment, engineering personnel, as well as supervisory and inspection personnel as required by § 151.45(f), will be provided; and

(4) A detailed estimate of the cost of the work, broken down for each class of costs involved, such as labor, materials, rental of equipment, and other pertinent items of cost.

(b) [Reserved]

[Doc. No. 1329, 27 FR 12351, Dec. 13, 1962, as amended by Amdt. 151-17, 31 FR 16525, Dec. 28, 1966; Amdt. 151-31, 34 FR 4885, Mar. 6, 1969]

### § 151.53 Performance of construction work: Labor requirements.

A sponsor who is required to include in a construction contract the labor

provisions required by § 151.49 shall require the contractor to comply with those provisions and shall cooperate with the FAA in effecting that compliance. For this purpose the sponsor shall—

(a) Keep, and preserve, for a three-year period beginning on the date the contract is completed, each affidavit and payroll copy furnished by the contractor, and make those affidavits and copies available to the FAA, upon request, during that period;

(b) Have each of those affidavits and payrolls examined by its resident engineer (or any other of its employees or agents who are qualified to make the necessary determinations), as soon as possible after receiving it, to the extent necessary to determine whether the contractor is complying with the labor provisions required by § 151.49 and particularly with respect to whether the contractor's employees are correctly classified;

(c) Have investigations made during the performance of work under the contract, to the extent necessary to determine whether the contractor is complying with those labor provisions, particularly with respect to whether the contractor's employees are correctly classified, including in the investigations, interviews with employees and examinations of payroll information at the work site by the sponsor's resident engineer (or any other of its employees or agents who are qualified to make the necessary determinations); and

(d) Keep the Area Manager fully advised of all examinations and investigations made under this section, all determinations made on the basis of those examinations and investigations, and all efforts made to obtain compliance with the labor provisions of the contract.

For the purposes of paragraph (c) of this section, the sponsor shall give priority to complaints of alleged violations, and shall treat as confidential any written or oral statements made by any employee. The sponsor may not disclose an employee's statement to a contractor without the employee's consent.

**§ 151.54 Equal employment opportunity requirements: Before July 1, 1968.**

In conformity with Executive Order 11246 of September 24, 1965 (30 FR 12319, 3 CFR, 1965 Supp., p. 167) the regulations of the former President's Committee on Equal Employment Opportunity, 41 CFR part 60-1 (28 FR 9812, 11305), as adopted "to the extent not inconsistent with Executive Order 11246" by the Secretary of Labor ("Transfer of Functions," Oct. 19, 1965, 30 FR 13441), are incorporated by reference into subparts B and C of this part as set forth below. They are referred to in this section by section numbers of part 60-1 of title 41.

(a) *Equal employment opportunity requirements.* There are hereby incorporated by reference into subparts B and C, as requirements, the provisions of § 60-1.3(b)(1). The FAA is primarily responsible for the sponsor's compliance.

(b) *Equal employment opportunity requirements in construction contracts.* The sponsor shall cause the "equal opportunity clause" in § 60-1.3(b)(1) to be incorporated into all prime contracts and subcontracts as required by § 60-1.3(c).

(c) *Reporting requirements for contractors and subcontractors.* The sponsor shall cause the filing of compliance reports by contractors and subcontractors as provided in § 60-1.6(a) and the furnishing of such other information as may be required under that provision.

(d) *Bidders' reports.* (1) The sponsor shall include in his invitations for bids or negotiations for contracts, and shall require his contractors to include in their invitations for bids or negotiations for subcontracts, the following provisions based on § 60-1.6(b)(1):

Each bidder, prospective contractor or proposed subcontractor shall state as an initial part of the bid or negotiations of the contract whether he has participated in any previous contract or subcontract subject to the equal opportunity clause and, if so, whether he has filed with the Office of Federal Contract Compliance in the United States Department of Labor or the contracting or administering agency all compliance reports due under applicable instructions. In any case in which a bidder or prospective contractor or proposed subcontractor who has participated in a previous contract or subcontract subject to the equal opportunity

## § 151.54a

clause has not filed a compliance report due under applicable instructions, such bidder, prospective contractor or proposed subcontractors shall submit a compliance report prior to the award of the proposed contract or subcontract. When a determination has been made to award a contract to a specific contractor, such contractor shall, prior to award, furnish such other pertinent information regarding his own employment policies and practices as well as those of his proposed subcontractors as the FAA, the sponsor, or the Director of the Office of Federal Contract Compliance may require.

(2) The sponsor or his contractors shall give express notice of the requirements of this paragraph (d) in all invitations for bids or negotiations for contracts.

(e) *Enforcement.* The FAA conducts compliance reviews, handles complaints and, where appropriate, conducts hearings and imposes, or recommends to the Office of Federal Contract Compliance, sanctions, as provided in subpart B—General Enforcement; Complaint Procedure of part 60-1.

(f) *Exempted contracts.* Except for subcontracts for the performance of construction work at the site of construction, the requirements of this section do not apply to subcontracts below the second tier (§60-1.3(c)). The requirements of this section do not apply to contracts and subcontracts exempted by §60-1.4.

(g) *Meaning of terms.* The term “applicant” in the provisions of part 60-1 incorporated by reference in this section means the sponsor, except where part 60-1 refers to an applicant for employment, and the term “administering agency” therein means the FAA.

(h) *Applicability to existing agreements and contracts.* This section applies to grant agreements made after December 20, 1964, and before July 1, 1968. Except as provided in §151.54A(b), it applies to contracts and subcontracts as defined in §60-1.2 (i) and (k) of Title 41 made in accordance with a grant agreement to which this section applies.

(E.O. 11246, 30 FR 13441, 31 FR 6921; sec. 307, 72 Stat. 752, 49 U.S.C. 1348)

[Amdt. 151-5, 29 FR 15569, Nov. 20, 1964, as amended by Amdt. 151-8, 30 FR 8040, June 23, 1965; Amdt. 151-12, 31 FR 10261, July 29, 1966; Amdt. 151-23, 33 FR 9543, June 29, 1968]

## 14 CFR Ch. I (1-1-08 Edition)

### § 151.54a Equal employment opportunity requirements: After June 30, 1968.

(a) *Incorporation by reference.* There are hereby incorporated by reference into this part the regulations issued by the Secretary of Labor on May 21, 1968, and published in the FEDERAL REGISTER on May 28, 1968 (41 CFR part 60-1, 33 FR 7804), except for the following provisions:

(1) Paragraph (a), “Government contracts”, of §60-1.4, “Equal opportunity clause”.

(2) Section 60-1.6, “Duties of agencies”.

(b) *Applicability and effectiveness.* The regulations incorporated by reference in paragraph (a) of this section apply to grant agreements made after June 30, 1968. They also apply to contracts, as defined in §60-1.3(f) of Title 41, entered into under any grant agreement made before or after that date, as provided in §60-1.47 of Title 41.

(Sec. 307, 72 Stat. 752, 49 U.S.C. 1348)

[Amdt. 151-23, 33 FR 9543, June 29, 1968]

### § 151.55 Accounting and audit.

(a) Each sponsor shall establish and maintain, for each individual project, an adequate accounting record to allow appropriate personnel of the FAA to determine all funds received (including funds of the sponsor and funds received from the United States or other sources), and to determine the allowability of all incurred costs of the project. The sponsor shall segregate and group project costs so that it can furnish, on due notice, cost information in the following cost classifications:

- (1) Purchase price or value of land.
- (2) Incidental costs of land acquisition.
- (3) Costs of contract construction.
- (4) Costs of force account construction.
- (5) Engineering costs of plans and designs.
- (6) Engineering costs of supervision and inspection.
- (7) Other administrative costs.

(b) The sponsor shall obtain and retain in its files for a period of three years after the date of the final grant payment, documentary evidence such

## Federal Aviation Administration, DOT

## § 151.61

as invoices, cost estimates, and payrolls supporting each item of project costs.

(c) The sponsor shall retain, for a period of three years after the date of the final grant payment, evidence of all payments for items of project costs including vouchers, cancelled checks or warrants, and receipts for cash payments.

(d) The sponsor shall allow the Administrator and the Comptroller General of the United States, or an authorized representative of either of them, access to any of its books, documents, papers, and records that are pertinent to grants received under the Federal-aid Airport Program for the purposes of accounting and audit. Appropriate FAA personnel may make progress audits at any time during the project, upon notice to the sponsor. If work is suspended on the project for an appreciable period of time, an audit will be made before any semi-final payment is made. In each case an audit is made before the final payment.

[Doc. No. 1329, 27 FR 12351, Dec. 13, 1962, as amended by Amdt. 151-8, 30 FR 8040, June 23, 1965]

### § 151.57 Grant payments: General.

(a) An application for a grant payment is made on FAA Form 5100-6, accompanied by—

(1) A summary of project costs on Form FAA-1630;

(2) A periodic cost estimate on Form FAA-1629 for each contract representing costs for which payment is requested; and

(3) Any supporting information, including appraisals of property interests, that the FAA needs to determine the allowability of any costs for which payment is requested.

(b) Contractor's certifications. Each application that involves work performed by a contractor must contain, in the contractor's certification in the periodic cost estimate, a statement that "there has been full compliance with all labor provisions included in the contract identified above and in all subcontracts made under that contract", and, in the case of a substantial dispute as to the nature of the contractor's or a subcontractor's obligation under the labor provisions of the con-

tract or a subcontract, and additional phrase "except insofar as a substantial dispute exists with respect to these provisions".

(c) If a contractor or subcontractor fails or refuses to comply with the labor provisions of the contract with the sponsor, further grant payments to the sponsor are suspended until the violations stop, until the Administrator determines the allowability of the project costs to which the violations related, or, to the extent that the violations consist of underpayments to labor, until the sponsor furnishes satisfactory assurances to the FAA that restitution has been or will be made to the affected employees.

(d) If, upon final determination of the allowability of all project costs of a project, it is found that the total of grant payments to the sponsor was more than the total United States share of the allowable costs of the project, the sponsor shall promptly return the excess to the FAA.

[Doc. No. 1329, 27 FR 12351, Dec. 13, 1962, as amended by Amdt. 151-4, 29 FR 11336, Aug. 6, 1964; Amdt. 151-8, 30 FR 8040, June 23, 1965; Amdt. 151-17, 31 FR 16525, Dec. 28, 1966; Amdt. 151-32, 34 FR 9617, June 19, 1969]

### § 151.59 Grant payments: Land acquisition.

If an approved project includes land acquisition as an item of airport development, the sponsor may, at any time after executing the grant agreement and after title evidence has been approved by the Administrator for the property interest for which payment is requested, apply to the FAA, through the Area Manager, for payment of the United States share of the allowable project costs of the acquisition, including any acquisition that is completed before executing the grant agreement and is part of the airport development included in the project.

### § 151.61 Grant payments: Partial.

(a) Subject to the final determination of allowable project costs as provided in §151.63 partial grant payments for project costs may be made to a sponsor upon application. Unless previously agreed otherwise, a sponsor may apply for partial payments on a monthly basis. The payments may be

**§ 151.63**

**14 CFR Ch. I (1-1-08 Edition)**

paid, upon application, on the basis of the costs of airport development that is accomplished or on the basis of the estimated cost of airport development expected to be accomplished.

(b) Except as otherwise provided, partial grant payments are made in amounts large enough to bring the aggregate amount of all partial payments to the estimated United States share of the project costs of the airport development accomplished under the project as of the date of the sponsor's latest application for payment. In addition, if the sponsor applies, a partial grant payment is made as an advance payment in an amount large enough to bring the aggregate amount of all partial payments to the estimated United States share of the estimated project costs of the airport development expected to be accomplished within 30 days after the date of the sponsor's application for advance payment. However, no partial payment may be made in an amount that would bring the aggregate amount of all partial payments for the project to more than 90 percent of the estimated United States share of the total estimated cost of all airport development included in the project, but not including contingency items, or 90 percent of the maximum obligation of the United States as stated in the grant agreement, whichever amount is the lower. In determining the amount of a partial grant payment, those project costs that the Administrator considers to be of questionable allowability are deducted both from the amount of project costs incurred and from the amount of the estimated total project cost.

**§ 151.63 Grant payments: Semifinal and final.**

(a) Whenever airport development on a project is delayed or suspended for an appreciable period of time for reasons beyond the sponsor's control and the allowability of the project costs of all airport development completed has been determined on the basis of an audit and review of all costs, a semifinal grant payment may be made in an amount large enough to bring the aggregate amount of all partial grant payments for the project to the United States share of all allowable project

costs incurred, even if the amount is more than the 90 percent limitation prescribed in §151.61(b). However, it may not be more than the maximum obligation of the United States as stated in the grant agreement.

(b) Whenever the project is completed in accordance with the grant agreement, the sponsor may apply for final payment. The final payment is made to the sponsor if—

(1) A final inspection of all work at the airport site has been made jointly by the Area Manager and representatives of the sponsor and the contractor, unless the Area Manager agrees to a different procedure for final inspection.

(2) A final audit of the project account has been completed by appropriate personnel of the FAA; and

(3) The sponsor has furnished final "as constructed" plans, unless otherwise agreed to by the Administrator.

(c) Based upon the final inspection, the final audit, the plans, and the documents and supporting information required by §151.57(a), the Administrator determines the total amount of the allowable project costs and pays the sponsor the United States' share, less the total amount of all prior payments.

**§ 151.65 Memoranda and hearings.**

(a) At any time before the FAA issues a grant offer for a project, any public agency or person having a substantial interest in the disposition of the project application may file a memorandum supporting or opposing it with the Area Manager of the area in which the project is located. In addition, that public agency or person may request a public hearing on the location of the airport to be developed. If, in the Administrator's opinion, that public agency or person has a substantial interest in the matter, a public hearing is held.

(b) The Administrator sets the time and place of each hearing under this section, to avoid undue delay in disposing of the application, to afford reasonable time for all parties concerned to prepare for it, and to hold it at a place convenient to the sponsor. Notice of the time and place is mailed to the public agency or person filing the memorandum, the sponsor, and any other necessary persons.

(c) The purpose of the hearing is to help the Administrator discover facts relating to the location of the airport that is proposed to be developed under an application pending before him. There are no adverse parties or interests and no defendant or respondent. They are not hearings for the purposes of 5 U.S.C. 554, 556, and 557, and do not terminate in an adjudication as defined in that Act.

(d) Each hearing under this section is conducted by a hearing officer designated by the Administrator. The hearing officer decides the length of the hearing, the kind of testimony to be heard, and all other matters respecting the conduct of the hearing. The hearing is recorded in a manner determined by the hearing officer and the record becomes a part of the record of the project application. The Administrator's decision is not made solely on the basis of the hearing, but on all relevant facts.

[Doc. No. 1329, 27 FR 12351, Dec. 13, 1962, as amended by Amdt. 151-11, 31 FR 6686, May 5, 1966; Amdt. 151-35, 34 FR 13699, Aug. 27, 1969]

#### § 151.67 Forms.

(a) The various forms used for the purposes of subparts B and C are as follows:

(1) Requests for Federal-aid, FAA Form 5100-3: Contains a statement requesting Federal-aid in carrying out a project under the Federal Airport Act, with appropriate spaces for inserting information needed for considering the request, including the location of the airport, the amount of funds available to the sponsor, a description of the proposed work, and its estimated cost.

(2) Project application, Form FAA-1624: A formal application for Federal-aid to carry out a project under this part. It contains four parts:

(i) Part I—For pertinent information regarding the airport and proposed work included in the project.

(ii) Part II—For incorporating the representations of the sponsor relating to its legal authority to undertake the project, the availability of funds for its share of the project costs, approvals of other non-United States agencies, the existence of any default on the compliance requirements of §151.77(a), possible disabilities, and the ownership of

lands and interests in lands to be used in carrying out the project and operating the airport.

(iii) Part III—For incorporating the sponsor's assurances regarding the operation and maintenance of the airport, further development of the airport, and the acquisition of any additional interests in lands that may be needed to carry out the project or for operating the airport.

(iv) Part IV—For a statement of the sponsor's acceptance, to be executed by the sponsor and certificated by its attorney.

(3) [Reserved]

(4) Grant agreement, Form FAA-1632:

(i) Part I—Offer by the United States to pay a specified percentage of the allowable costs of the project, as described therein, on specified terms relating to the undertaking and carrying out of the project, determination of allowability of costs, payment of the United States share, and operation and maintenance of the airport in accordance with assurances in the project application.

(ii) Part II—Acceptance of the offer by the sponsor, execution of the acceptance by the sponsor, and certification by its attorney.

(5) Periodic cost estimate, Form FAA-1629: a certification to be executed by the contractor, with space for information regarding the progress of construction work as of a specific date, and the value of the completed work.

(6) Application for grant payment, FAA Form 5100-6: Application for payment under a grant agreement for work completed as of a specific date or to be completed by a specific date, with space for an appropriate breakdown of project costs among the categories shown therein, and certification provisions to be executed by the sponsor and the Area Manager.

(7) Summary of project costs, Form FAA-1630: For inserting the latest revised estimate of total project costs, the total costs incurred as of a specific date, an estimate of the aggregate of those total costs incurred to date and those to be incurred before a specific date in the future.

(b) Copies of the forms named in this section, and assistance in completing

## § 151.71

and executing them, are available from the Area Manager.

[Doc. No. 1329, 27 FR 12351, Dec. 13, 1962, as amended by Amdt. 151-8, 30 FR 8040, June 23, 1965; Amdt. 151-11, 31 FR 6686, May 5, 1966; Amdt. 151-17, 31 FR 16525, Dec. 28, 1966; Amdt. 151-25, 33 FR 14535, Sept. 27, 1968; Amdt. 151-34, 34 FR 12883, Aug. 8, 1969]

### Subpart C—Project Programming Standards

AUTHORITY: 49 U.S.C. 106(g), 40113, 47151, 47153.

SOURCE: Docket No. 1329, 27 FR 12357 Dec. 13, 1962, unless otherwise noted.

#### § 151.71 Applicability.

(a) This subpart prescribes programming and design and construction standards for projects under the Federal-Aid Airport Program to assure the most efficient use of Program funds and to assure that the most important elements of a national system of airports are provided.

(b) Except for the standards made mandatory by § 151.72(a), the standards prescribed in this subpart that apply to any particular project are those in effect on the date the sponsor accepts the Administrator's offer under § 151.29(c). The standards of § 151.72(a) applicable to a project are those in effect on the date written on the notification of tentative allocation of funds (§ 151.21(b)). Standards that become effective after that date may be applied to the project by agreement between the sponsor and the Administrator.

(Secs. 1-15, 17-21, 60 Stat. 170, 49 U.S.C. 1120)

[Amdt. 151-19, 32 FR 9220, June 29, 1967]

#### § 151.72 Incorporation by reference of technical guidelines in Advisory Circulars.

(a) *Provisions incorporated; mandatory standards.* The technical guidelines in the Advisory Circulars, or parts of Circulars, listed in appendix I of this part, are incorporated into this subpart by reference. Guidelines so incorporated are mandatory standards and apply in addition to the other standards in this subpart. No provision so incorporated and made mandatory supersedes any provision of this part 151 (other than of App. I) or of any other part of the Fed-

## 14 CFR Ch. I (1-1-08 Edition)

eral Aviation Regulations. Each Circular is incorporated with all amendments outstanding at any time unless the entry in appendix I of this part states otherwise.

(b) *Amendments of Appendix I.* The Director, Airports Service, may add to, or delete from, appendix I of this part any Advisory Circular or part thereof.

(c) *Availability of Advisory Circulars.* The Advisory Circulars listed in appendix I of this part may be inspected and copied at any FAA Regional Office, Area Office, or Airports District Office. Copies of the Circulars that are available free of charge may be obtained from any of the offices or from the Federal Aviation Administration, Printing Branch, HQ-438, Washington, D.C. 20553. Copies of the Circulars that are for sale may be bought from the Superintendent of Documents, U.S. Government Printing Office, Washington, D.C. 20402 for the price listed.

[Amdt. 151-13, 31 FR 11605, Sept. 2, 1966, as amended by Doc. No. 8084, 32 FR 5769, Apr. 11, 1967]

#### § 151.73 Land acquisition.

(a) The acquisition of land or any interest therein, or of any easement or other interest in airspace, is eligible for inclusion in a project if it was made after May 13, 1946, and is necessary—

(1) To allow the initial development of the airport;

(2) For improvement indicated in the current National Airport Plan;

(3) For ultimate development of the airport, as indicated in the current approved airport layout plan to the extent consistent with the National Airport Plan;

(4) For approach protection meeting the standards of § 77.23 as applied to §§ 77.25 and 77.27 of this chapter;

(5) To allow installing an ALS (as described in § 151.13), in which case the costs of acquiring land needed for it are eligible for 75 percent United States participation if the need is shown in the National Airport Plan, based on the best information available to the FAA for the forecast period;

(6) To allow proper use, operation, or maintenance of the airport as a public facility, including offsite lands needed for locating necessary parts of the utility systems serving the airport;

(7) To allow installing navigational aids by the FAA, if the land is within the airport boundaries; or

(8) To allow relocation of navigational aids.

(b) Appendix A of this part sets forth typical eligible and ineligible items of land acquisition as covered by this section.

[Doc. No. 1329, 27 FR 12357, Dec. 13, 1962, as amended by Amdt. 151-7, 30 FR 7484, June 8, 1965; Amdt. 151-8, 30 FR 8040, June 23, 1965]

#### § 151.75 Preparation of site.

(a) Grading, drainage, and associated items of site preparation are eligible for inclusion in a project, but only with respect to one landing strip at any airport, unless the airport qualifies for more than one runway, based on traffic volume or wind conditions (as outlined in § 151.77) and the overall site preparation required for development in accordance with the airport layout plan. The complete clearance of runway clear zone areas is desirable, but, as a minimum, all obstructions as determined by § 77.23 as applied to § 77.27 (b) and (c) of this chapter must be removed. Grading in runway clear zones is eligible only to remove terrain that is an obstruction. The clear zone is not a graded overrun area. Specific site preparation for an airport terminal building is eligible on the same basis as the building itself. The site preparation cost is prorated based on eligible and ineligible building space. Appendix B of this part sets forth typical eligible and ineligible items of site preparation as covered by this section.

(b) For the purposes of this section, eligible drainage work off the airport site includes drainage outfalls, drainage disposal, and interception ditches. If there is damage to adjacent property, its correction is an eligible item for inclusion in the project.

[Doc. No. 1329, 27 FR 12357, Dec. 13, 1962, as amended by Amdt. 151-7, 30 FR 7484, June 8, 1965; Amdt. 151-8, 30 FR 8040, June 23, 1965]

#### § 151.77 Runway paving: General rules.

(a) On any airport, paving of the designated instrument landing runway (or dominant runway if there is no designated instrument runway) is eligible for inclusion in a project, within the limits of the current National Airport

Plan. Program participation in constructing, reconstructing or resurfacing is limited to a single runway at each airport, unless more than one runway is eligible under a standard in § 151.79 or § 151.80.

(b) The kinds of runway paving that are eligible for inclusion in a project include pavement construction and reconstruction, and include runway grooving to improve skid resistance, and resurfacing to increase the load bearing capacity of the runway or to provide a leveling course to correct major irregularities in the pavement. Runway resealing or refilling joints as an ordinary maintenance matter are not eligible items, except for bituminous resurfacing consisting of at least 100 pounds of plant-mixed material for each square yard, and except for the application of a bituminous surface treatment (two applications of material and cover aggregate as prescribed in FAA Specification P-609) on a pavement the current surface of which consists of that kind of a bituminous surface treatment.

(c) On new pavement construction, the applying of a bituminous seal coat on plant hot-mix bituminous surfaces only, is an eligible item only if initial engineering analysis and design indicate the need for a seal coat. However, any delay in applying it that is caused other than by construction difficulties, makes the application a maintenance item that is not eligible.

(d) In any case in which the need for a seal coat is necessary for a new runway extension or partial reconstruction of a runway, the entire runway may be sealed.

(e) Appendix C to this part sets forth typical eligible and ineligible items of runway paving.

(49 U.S.C. 1120)

[Doc. No. 1329, 27 FR 12357, Dec. 13, 1962, as amended by Amdt. 151-17, 31 FR 16525, Dec. 28, 1966; Amdt. 151-29, 34 FR 1634, Feb. 4, 1969]

#### § 151.79 Runway paving: Second runway; wind conditions.

(a) *All airports.* Paving a second runway on the basis of wind conditions is eligible for inclusion in a project only if the sponsor shows that—

## § 151.80

(1) The airport meets the applicable standards of paragraph (b), (c), or (d) of this section;

(2) The operational experience, and the economic factors of air traffic at the location, justify an additional runway for the airport; and

(3) The second runway is oriented with the existing paved runway to achieve the maximum wind coverage, with due consideration to the airport noise factor, topography, soil conditions, and other pertinent factors affecting the economy and efficiency of the runway development.

(b) *Airports serving large and small aircraft.* The airport serves both large and small aircraft and the existing paved runway is subject to a crosswind component of more than 15 miles per hour (13 knots) more than 5 percent of the time.

(c) *Airports serving small aircraft only.* The airport serves small aircraft exclusively, and—

(1) The airport has 10,000, or more, aircraft operations each year; and

(2) The existing paved runway is subject to a crosswind component of more than 12 miles per hour (10.5 knots) more than 5 percent of the time.

(d) *Airports serving aircraft of less than 8,000 pounds only.* The airport serves small aircraft of less than 8,000 pounds maximum certificated takeoff weight exclusively and—

(1) The airport has 5,000, or more, aircraft operations each year; and

(2) The existing paved runway is subject to a crosswind component of more than 12 miles per hour (10.5 knots) more than 5 percent of the time.

[Amdt. 151-17, 31 FR 16525, Dec. 28, 1966, as amended by Amdt. 151-28, 34 FR 551, Jan. 15, 1969]

### § 151.80 Runway paving; Additional runway; other conditions.

Paving an additional runway on an airport that does not qualify for a second runway under § 151.79 is eligible if the Administrator, upon consideration on a case-to-case basis, is satisfied that—

(a) The volume of traffic justifies an additional paved runway and the layout and orientation of the additional runway will expedite traffic; or

## 14 CFR Ch. I (1-1-08 Edition)

(b) A combination of traffic volume and aircraft noise problems justifies an additional paved runway for that airport.

[Amdt. 151-17, 31 FR 16525, Dec. 28, 1966]

### § 151.81 Taxiway paving.

(a) The construction, alteration, and repair of taxiways needed to expedite the flow of ground traffic between runways and aircraft parking areas available for general public use are eligible items under the program. Taxiways to serve an area or facility that is primarily for the exclusive or near exclusive use of a tenant or operator that does not furnish aircraft servicing to the public are not eligible. In addition, the policies on resealing or refilling joints, as set forth in § 151.77, apply also to taxiway paving.

(b) Appendix D of this part sets forth typical eligible and ineligible items of taxiway paving.

### § 151.83 Aprons.

(a) The construction, alteration, and repair of aprons are eligible program items upon being shown that they are needed as public use facilities. An apron to serve an area that is primarily for the exclusive or near exclusive use of a tenant or operator who does not furnish aircraft servicing to the public is not eligible. In addition, the policies on resealing or refilling joints, as set forth in § 151.77 apply also to apron paving.

(b) In determining public use for the purposes of this section, the current use being made of a hangar governs, unless there is definite information regarding its future use. In the case of an apron area being built for future hangars, it should be shown that early hangar development is assured and that the hangars will be public facilities.

(c) Appendix E of this part sets forth typical eligible and ineligible items of apron paving.

### § 151.85 Special treatment areas.

The following special treatment for areas adjacent to pavement is eligible for inclusion in a project in cases where, due to the operation of turbojet powered aircraft, it may be necessary

to treat those areas adjacent to runway ends, holding aprons, and taxiways to prevent erosion from the blast effects of the turbojet:

(a) Runway ends—a stabilized area the width of the runway and extending 100 to 150 feet from the end of the runway.

(b) Holding aprons—a stabilized area up to 50 feet from the edge of the pavement.

(c) Taxiway intersections—a stabilized area 25 feet on each side of the taxiway and extending 300 feet from the intersection.

(d) Taxiway (continuous movement of aircraft)—dense turf 25 feet on each side of the taxiway, or in a geographic area where dense turf cannot be established, stabilization.

**§ 151.86 Lighting and electrical work: General.**

(a) The installing of lighting facilities and related electrical work, as provided in § 151.87, is eligible for inclusion in a project only if the Administrator determines, for the particular airport involved, that they are needed to ensure—

(1) Its safe and efficient use by aircraft under § 151.13; or

(2) Its continued operation and adequate maintenance, and it has a large enough volume (actual or potential) of night operations.

(b) Before the Administrator makes a grant offer to the sponsor of a project that includes installing lighting facilities and related electrical work under paragraph (a) of this section, the sponsor must—

(1) Provide in the project for removing, relocating, or adequately marking and lighting, each obstruction in the approach and turning zones, as provided in § 151.91(a);

(2) Acknowledge its awareness of the cost of operating and maintaining airport lighting; and

(3) Agree to operate the airport lighting installed—

(i) Throughout each night of the year; or

(ii) According to a satisfactory plan of operation, submitted under paragraph (c) of this section.

(c) The sponsor of a project that includes installing airport lighting and

related electrical work, under paragraph (a) of this section, may—

(1) Submit to the Administrator a proposed plan of operation of the airport lighting installed for periods less than throughout each night of the year;

(2) Specify, in the proposed plan, the times when the airport lighting installed will be operated; and

(3) Satisfy the Administrator that the proposed plan provides for safety in air commerce, and justifies the investment of Program funds.

(d) Paragraph (b)(3) of this section also applies to each sponsor of a project that includes installing airport lighting and related electrical work if that sponsor has not entered into a grant agreement for the project before September 5, 1968.

(e) If it agrees to comply with paragraph (b)(3) of this section, the sponsor of a project that includes installing airport lighting facilities and related electrical work that has entered into a grant agreement for that project before September 5, 1968, may—

(1) Surrender its air navigation certificate authorizing operation of a “true light” issued before that date; or

(2) Terminate its application for authority to operate a “true light” made before that date.

(Secs. 307, 606, 72 Stat. 749, 779; 49 U.S.C. 1120, 1348, 1426)

[Amdt. 151-24, 33 FR 12545, Sept. 5, 1968]

**§ 151.87 Lighting and electrical work: Standards.**

(a)–(b) [Reserved]

(c) The number of runways that are eligible for lighting is the same as the number eligible for paving under § 151.77, § 151.79, or § 151.80.

(d) The installing of high intensity runway edge lighting is eligible on a designated instrument landing runway and any other runway with approved straight-in approach procedures. A runway that is eligible for lighting, but does not meet the requirements for 75 percent U.S. participation under § 151.43(d), is eligible for 50 percent U.S. participation in the costs of high intensity runway edge lighting (or the allowable percentage in § 151.43(c) for public land States), if the airport is served by a navigational aid that will

**§ 151.89**

**14 CFR Ch. I (1-1-08 Edition)**

allow using instrument approach procedures. If a runway is not eligible for 75 or 50 percent Federal participation in high intensity runway edge lighting but is otherwise eligible for runway lighting, the U.S. share of the cost of runway edge lighting is 50 percent of the cost of the lighting installed but not more than 50 percent of the cost of medium intensity lighting.

(e) In-runway lighting (touchdown zone lighting system, and centerline lighting system) is eligible on the designated instrument landing runway.

(f) Taxiways to eligible runways on airports served by transport aircraft are eligible for lighting. On airports serving only general aviation, the lighting of connecting taxiways is eligible if the runway served is lighted or is programmed to be lighted. The lighting of a parallel taxiway is eligible if the taxiway is eligible for paving. Lighting of other taxiways is eligible or not, depending on the complexity of the taxiway system.

(g) Floodlighting of aprons is eligible if there is a proven need for it, including a showing of night operations where the runway is lighted.

(h) Any airport that is eligible to participate in the costs of runway lighting is eligible for the installing of an airport beacon, lighted wind indicator, obstruction lights, lighting control equipment, and other components of basic airport lighting, including separate transformer vaults and connection to the nearest available power source.

(i) The interconnection of two or more power sources on an airport property, the providing of second sources of power, and the installing of standby engine generators of reasonable capacity, are eligible under the program.

(j) Economy approach lighting aids are eligible for inclusion in a project at an airport that will not qualify within the next three years for approach lighting aids installed by FAA under the Facilities and Equipment Program if the economy approach lighting aids—

- (1) Will correct a visual deficiency on one of the lighted runways of the airport; or
- (2) Will permit operations at an airport at lower minimums.

“Economy approach lighting aids” includes a medium intensity approach lighting system (MALS) that may include a sequence flasher (SF); a runway end identifier lights system (REILS); and an abbreviated visual approach slope indicator (AVASI).

(k) Appendix F of this part sets forth typical eligible and ineligible items of airport lighting covered by §151.86 and this section.

(Secs. 307, 606, 72 Stat. 749, 799; 49 U.S.C. 1120, 1348, 1426)

[Doc. No. 1329, 27 FR 12357, Dec. 13, 1962, as amended by Amdt. 151-8, 30 FR 8040, June 23, 1965; Amdt. 151-17, 31 FR 16525, Dec. 28, 1966; Amdt. 151-22, 33 FR 8267, June 4, 1968; Amdt. 151-24, 33 FR 12545, Sept. 5, 1968; Amdt. 151-35, 34 FR 13699, Aug. 27, 1969]

**§ 151.89 Roads.**

(a) Federal-aid Airport Program funds may not be used to resolve highway problems. Only those airport entrance roads that are definitely needed and are intended only as a way in and out of the airport are eligible.

(b) The construction, alteration, and repair of airport roads and streets that are entirely within the airport boundaries are eligible under the program, if needed for operating and maintaining the airport. In the case of an entrance road, a strip right-of-way joining the main body of the airport to the nearest public road may be considered a part of the normal boundary of the airport if—

- (1) Adequate title is obtained;
- (2) It was acquired to provide an airport entrance road and was not, before the existence of the airport, a public thoroughfare;
- (3) The entrance road is intended only as a way in and out of the airport; and
- (4) The entrance road extends only to the nearest public highway, road, or street.

(c) An entrance road may be joined to an existing highway or street with a normal fillet connection. However, acceleration-deceleration strips or grade separations are not eligible.

(d) Offsite road or street relocation needed to allow airport development or to remove an obstruction, and is not for entrance road purposes, is eligible.

(e) Appendix G sets forth typical eligible and ineligible items of road construction covered by this section.

**§ 151.91 Removal of obstructions.**

(a) The removal or relocation, or both, of obstructions, as defined in Technical Standard Order N18 is eligible under the Program in cases where definite arrangements are made to prevent the obstruction from being recreated. In a case where removal is not feasible, the cost of marking or lighting it is eligible. The removal and relocation of structures necessary for essential airport development is eligible. The removal of structures that are not obstructions under § 77.23 of this chapter as applied to § 77.27 of this chapter are eligible when they are located within a runway clear zone.

(b) The removal and relocation of an airport hangar that is an airport hazard (as described in § 151.39(b)) is eligible, if the reerected hangar will be substantially identical to the disassembled one.

(c) Whenever a hangar must be relocated (either for clearance of the site for other airport development or to remove a hazard) and the existing structure is to be relocated with or without disassembly, the cost of the relocation is an eligible item of project costs, including costs incidental to the relocation such as necessary footings and floors. However, if the existing structure is to be demolished and a new hangar is to be built, only the cost of demolishing the existing hangar is an eligible item.

[Doc. No. 1329, 27 FR 12357, Dec. 13, 1962, as amended by Amdt. 151-22, 33 FR 8267, June 4, 1968]

**§ 151.93 Buildings; utilities; sidewalks; parking areas; and landscaping.**

(a) Only buildings or parts of buildings intended to house facilities or activities directly related to the safety of persons at the airport, including fire and rescue equipment buildings, are eligible items under the Federal-aid Airport Program. To the extent they are necessary to house snow removal and abrasive spreading equipment, and to provide minimum protection for abrasive materials, field maintenance equipment buildings are eligible items

in any airport development project for an airport in a location having a mean daily minimum temperature of zero degrees Fahrenheit, or less, for at least 20 days each year for the 5 years preceding the year when Federal aid is requested under § 151.21(a), based on the statistics of the U.S. Department of Commerce Weather Bureau if available, or other evidence satisfactory to the Administrator.

(b) Airport utility construction, installation, and connection are eligible under the Federal-aid Airport Program as follows:

(1) An airport utility serving only eligible areas and facilities is eligible; and

(2) An airport utility serving both eligible and ineligible airport areas and facilities is eligible only to the extent of the additional cost of providing the capacity needed for eligible areas and facilities over and above the capacity necessary for the ineligible areas and facilities.

However, a water system is eligible only to the extent necessary to provide fire protection for aircraft operations, and to provide water for a fire and rescue equipment building.

(c) No part of the constructing, altering, or repairing (including grading, drainage, and other site preparation work) of a facility or area that is to be used as a public parking facility for passenger automobiles is eligible for inclusion in a project.

(d) Landscaping is not eligible for inclusion in a project. However, the establishment of turf on graded areas and special treatment to prevent slope erosion is eligible to the extent of the eligibility of the facilities or areas served, preserved, or protected by the turf or treatment. In the case of turfing or treatment for an area or facility that is partly eligible and partly ineligible, the eligibility of the turfing or treatment is established on a pro rata basis.

(e) The construction of sidewalks is not eligible for inclusion in a project.

[Doc. No. 1329, 27 FR 12357, Dec. 13, 1962, as amended by Amdt. 151-17, 31 FR 16525, Dec. 28, 1966; Amdt. 151-26, 33 FR 18434, Dec. 12, 1968]

## § 151.95

### **§ 151.95 Fences; distance markers; navigational and landing aids; and offsite work.**

(a) Boundary or perimeter fences for security purposes are eligible for inclusion in a project.

(b) A blast fence is eligible for inclusion in a project whenever—

(1) It is necessary for safety at a runway end or a holding area near the end of a runway and its installation would be more economical than the acquiring of additional property interests; or

(2) Its installation for safety at a turbojet-passenger gate will result in less separation being needed for gate positions, thereby reducing the need for apron expansion, and it is more economical to build the fence than to expand the apron.

(c) The eligibility of runway distance markers for inclusion in a project is decided on a case-by-case basis.

(d) The relocation of navigational aids is eligible for inclusion in a project whenever necessitated by development on the airport under a Program project and the sponsor is responsible under FAA Order OA 6030.1 (Agency Order 53).

(e) The installation of any of the following landing aids is eligible for inclusion in a project:

(1) Segmented circle.

(2) Wind and landing direction indicators.

(3) Boundary markers.

(f) The initial marking of runway and taxiway systems is eligible for inclusion in a project. The remarking of existing runways or taxiways is eligible if—

(1) Present marking is obsolete under current FAA standards; or

(2) Present marking is obliterated by construction, alteration or repair work included in a FAAP project or by the required routing of construction equipment used therein.

However, apron marking that is not allied with runway and taxiway marking systems, is not eligible.

(g) The following offsite work performed outside of the boundaries of an airport or airport site is eligible for inclusion in a project:

(1) Removal of obstruction as provided in § 151.91.

## 14 CFR Ch. I (1–1–08 Edition)

(2) Outfall drainage ditches, and the correction of any damage resulting from their construction.

(3) Relocating of roads and utilities that are airport hazards as defined in § 151.39(b).

(4) Clearing, grading, and grubbing to allow installing of navigational aids.

(5) Constructing and installing utilities.

(6) Lighting of obstructions.

[Doc. No. 1329, 27 FR 12359, Dec. 13, 1962, as amended by Amdt. 151–8, 30 FR 8040, June 23, 1965; Amdt. 151–17, 31 FR 16525, Dec. 28, 1966]

### **§ 151.97 Maintenance and repair.**

(a) Maintenance work is not airport development as defined in the Federal Airport Act and is not eligible for inclusion in the Program. Therefore, it is necessary in many cases that a determination be made whether particular proposed development is maintenance or repair. For the purpose of these determinations, maintenance includes any regular or recurring work necessary to preserve existing airport facilities in good condition, any work involved in cleaning or caring for existing airport facilities, and any incidental or minor repair work on existing airport facilities, such as—

(1) Mowing and fertilizing of turfed areas;

(2) Trimming and replacing of landscaping material;

(3) Cleaning of drainage systems including ditches, pipes, catch basins, and replacing and restoring eroded areas, except when caused by act of God or improper design;

(4) Painting of buildings (inside and outside) and replacement of damaged items normally anticipated;

(5) Repairing and replacing burned out or broken fixtures and cables, unless major reconstruction is needed;

(6) Paving repairs in localized areas, except where the size of the work is such that it constitutes a major repair item or is part of a reconstruction project; and

(7) Refilling joints and resealing surface of pavements.

(b) Repair includes any work not included in paragraph (a) of this section that is necessary to restore existing airport facilities to good condition or preserve them in good condition.

**§ 151.99 Modifications of programming standards.**

The Director, Airports, Service, or the Regional Director concerned may, on individual projects, when necessary for adaptation to meet local conditions, modify any standard set forth in or incorporated into this subpart, if he determines that the modification will provide an acceptable level of safety, economy, durability, or workmanship.

[Amdt. 151-13, 31 FR 11605, Sept. 2, 1966]

**Subpart D—Rules and Procedures for Advance Planning and Engineering Proposals**

AUTHORITY: 49 U.S.C. 106(g), 40113, 47151, 47153.

SOURCE: Docket No. 6227, 30 FR 8040, June 23, 1965, unless otherwise noted.

**§ 151.111 Advance planning proposals: General.**

(a) Each advance planning and engineering proposal must relate to an airport layout plan or plans and specifications for the development of a new airport, or the further development of an existing airport. Each proposal must relate to a specific airport, either existing or planned, and may not be for general area planning.

(b) Each proposal for the development or further development of an airport must have as its objective either the development of an airport layout plan, under §151.5(a), or the development of plans designed to lead to a project application, under §§ 151.21(c) and 151.27, or both.

(c) Each proposal must relate to planning and engineering for an airport that—

(1) Is in a location shown on the National Airport Plan; and

(2) Is not served by scheduled air carrier service and located in a large or medium hub, as identified in the current edition of "Airport Activity Statistics of Certificated Route Air Carriers" (published jointly by FAA and the Civil Aeronautics Board), that is available for inspection at any FAA Area or Regional Office, or for sale by the Superintendent of Documents, Government Printing Office, Washington, D.C. 20402.

(d) Each proposal must relate to future airport development projects eligible under subparts B and C.

(49 U.S.C. 1115; sec. 308, 72 Stat. 750, 49 U.S.C. 1349)

[Doc. No. 6227, 30 FR 8040, June 23, 1965, as amended by Amdt. 151-24, 33 FR 12545, Sept. 5, 1968]

**§ 151.113 Advance planning proposals: Sponsor eligibility.**

The sponsor of an advance planning and engineering proposal must be a public agency, as defined in §151.37(a), and must be legally, financially, and otherwise able to—

(a) Make the certifications, representations, and warranties required in the advance planning proposal, FAA Form 3731;

(b) Enter into and perform the advance planning agreement;

(c) Provide enough funds to pay all estimated proposal costs not borne by the United States; and

(d) Meet any other applicable requirements of the Federal Airport Act and this subpart.

**§ 151.115 Advance planning proposals: Cosponsorship and agency.**

Any two or more public agencies desiring to jointly participate in an advance planning proposal may cosponsor it. The cosponsorship and agency requirements and procedures set forth in §151.33, except §151.33(a)(1), also apply to advance planning proposals. In addition, the sponsor eligibility requirements set forth in §151.113 must be met by each participating public agency.

**§ 151.117 Advance planning proposals: Procedures; application.**

(a) Each eligible sponsor desiring to obtain Federal aid for the purpose of advance planning and engineering must submit a completed FAA Form 3731, "Advance Planning Proposal", to the Area Manager.

(b) The airport layout plan, if in existence, must accompany the advance planning proposal. If the advance planning proposal includes preparation of plans and specifications, enough details to identify the items of development to be covered by the plans and

## § 151.119

specifications must be shown. The proposal must be accompanied by evidentiary material establishing the basis for the estimated costs under the proposal, such as an offer from an engineering firm containing a schedule of services and charges therefor.

[Doc. No. 6227, 30 FR 8040, June 23, 1965 as amended by Amdt. 151-11, 31 FR 6686, May 5, 1966]

### § 151.119 Advance planning proposals: Procedures; funding.

The funding information required by § 151.23, except the last sentence, also is required in connection with an advance planning proposal. The sponsor's share of estimated proposal costs may not consist of or include the value of donated labor, materials, or equipment.

### § 151.121 Procedures: Offer; sponsor assurances.

Each sponsor must adopt the following covenant implementing the exclusive rights provisions of section 308(a) of the Federal Aviation Act of 1958, that is incorporated by reference into Part I of the Advance Planning Agreement:

The sponsor—

(a) Will not grant or permit any exclusive right forbidden by section 308(a) of the Federal Aviation Act of 1958 (49 U.S.C. 1349(a)) at the airport, or at any other airport now or hereafter owned or controlled by it;

(b) Agrees that, in furtherance of the policy of the FAA under this covenant, unless authorized by the Administrator, it will not, either directly or indirectly, grant or permit any person, firm or corporation the exclusive right at the airport, or at any other airport now or hereafter owned or controlled by it, to conduct any aeronautical activities, including, but not limited to, charter flights, pilot training, aircraft rental and sight-seeing, aerial photography, crop dusting, aerial advertising and surveying, air carrier operations, aircraft sales and services, sale of aviation petroleum products whether or not conducted in conjunction with other aeronautical activity, repair and maintenance of aircraft, sale of aircraft parts, and any other activities which because of their direct relationship to the operation of aircraft can be regarded as an aeronautical activity;

(c) Agrees that it will terminate any existing exclusive right to engage in the sale of gasoline or oil, or both, granted before July 17, 1962, at such an airport, at the earliest renewal, cancellation, or expiration date appli-

## 14 CFR Ch. I (1-1-08 Edition)

cable to the agreement that established the exclusive right; and

(d) Agrees that it will terminate any other exclusive right to conduct any aeronautical activity now existing at such an airport before the grant of any assistance under the Federal Airport Act.

[Amdt. 151-30, 34 FR 3656, Mar. 1, 1969 as amended by Amdt. 151-32, 34 FR 9617, June 19, 1969]

### § 151.123 Procedures: Offer; amendment; acceptance; advance planning agreement.

(a) The procedures and requirements of § 151.29 also apply to approved advance planning proposals. FAA's offer and the sponsor's acceptance constitute an advance planning grant agreement between the sponsor and the United States. The United States does not pay any of the advance planning costs incurred before the advance planning grant agreement is executed.

(b) No grant is made unless the sponsor intends to begin airport development within three years after the date of sponsor's written acceptance of a grant offer. The sponsor's intention must be evidenced by an appropriate written statement in the proposal.

### § 151.125 Allowable advance planning costs.

(a) The United States' share of the allowable costs of an advance planning proposal is stated in the advance planning grant agreement, but is not more than 50 percent of the total cost of the necessary and reasonable planning and engineering services.

(b) The allowable advance planning costs consist of planning and engineering expenses necessarily incurred in effecting the advance planning proposal. Allowable cost items include—

(1) Location surveys, such as preliminary topographic and soil exploration;

(2) Site evaluation;

(3) Preliminary engineering, such as stage construction outlines, cost estimates, and cost/benefit evaluation reports;

(4) Contract drawings and specifications;

(5) Testing; and

(6) Incidental costs incurred to accomplish the proposal, that would not have been incurred otherwise.

(c) To qualify as allowable, the advance planning costs paid or incurred by the sponsor must be—

- (1) Reasonably necessary and directly related to the planning or engineering included in the proposal as approved by FAA;
- (2) Reasonable in amount; and
- (3) Verified by sufficient evidence.

#### § 151.127 Accounting and audit.

The requirements of § 151.55 relating to accounting and audit of project costs are also applicable to advance planning proposal costs. However, the requirement of segregating and grouping costs applies only to § 151.55(a) (5) and (7) classifications.

#### § 151.129 Payments.

(a) The United States' share of advance planning costs is paid in two installments unless the advance planning grant agreement provides otherwise. Upon request by sponsor, the first payment may be made in an amount not more than 50 percent of the maximum obligation of the United States stipulated in the advance planning grant agreement upon certification by sponsor that 50 percent or more of the proposed work has been completed. The final payment is made upon the sponsor's request after—

- (1) The conditions of the advance planning grant agreement have been met;
- (2) Evidence of cost of each item has been submitted; and
- (3) Audit of submitted evidence or audit of sponsor's records, if considered desirable by FAA, has been made.

(b) When the advance planning proposal relates to the selection of an airport site, the advance planning grant agreement provides that Federal funds are paid to the sponsor only after the site is selected and the Administrator is satisfied that the site selected for the airport is reasonably consistent with existing plans of public agencies for development of the area in which the site is located, and will contribute to the accomplishment of the purposes of the Federal-aid Airport Program.

#### § 151.131 Forms.

The forms used for the purpose of obtaining an advance planning and engineering grant are as follows:

(a) *Advance planning proposal, FAA Form 3731—(1) Part I.* This part of the form contains a request for the grant of Federal funds under the Federal Airport Act for the purpose of aiding in financing a proposal for the development of an airport layout plan or plans, or both, designed to lead to a project application, with spaces provided for inserting information needed for considering the request, including the location of the airport, a description of the plan or plans to be developed, and the estimate of planning and engineering costs.

(2) *Part II.* This part of the form includes the sponsor's representation that it will comply with the provisions of part 15 of the Federal Aviation Regulations (14 CFR part 15), and representations concerning its legal authority to undertake the proposal, the availability of funds for its share of the proposal costs, its intention to initiate construction of a safe, useful and usable airport facility shown on an airport layout plan developed under the proposal, or initiate the construction of the item or items of airport development shown on the plans developed under the proposal and designed to lead to a project application, or both, within three years after the date of acceptance of the offer. It also includes the sponsor's representation as to the method of financing the intended construction, approval of other agencies, defaults, possible disabilities, and a statement concerning acceptance to be executed by the sponsor and certified by its attorney.

(b) *Advance planning agreement, FAA Form 3732—(1) Part I.* This part of the form contains an offer by the United States to pay a specified percentage not to exceed 50% of the allowable proposal costs, as described therein, on specific terms relating to the carrying out of the proposal, allowability of costs, payment of the United States' share and sponsor's agreement to comply with the exclusive rights provision of section 308(a) of the Federal Aviation Act of 1958.

**Pt. 151, App. A**

(2) *Part II.* This part of the form contains the acceptance of the offer by the sponsor, execution of the acceptance by the sponsor, and the certification by the sponsor's attorney.

**APPENDIX A TO PART 151**

There is set forth below an itemization of typical eligible and ineligible items of land acquisition as covered by §151.73:

*Typical Eligible Items*

1. Land for:
  - (a) Initial acquisition for entire airport developments, including building areas as delineated on the approved airport layout plan.
  - (b) Expansion of airport facilities.
  - (c) Clear zones at ends of eligible runways.
  - (d) Approach lights (land for ALS eligible for 75 percent participation will be limited to an area 3200' x 400' for a Standard ALS and to an area 1700' x 400' for a short ALS located symmetrically about the runway centerline extended, beginning at the end of the runway).
  - (e) Approach protection.
  - (f) Airport utilities.
2. Easements for:
  - (a) Use of air space by aircraft.
  - (b) Storm-water run-off.
  - (c) Powerlines to serve offsite obstruction lights.
  - (d) Airport utilities.
3. Extinguishment of easements which interfere with airport development.

*Typical Ineligible Items*

1. Land required only for:
  - (a) Industrial and other non-airport purposes.

[Doc. No. 1329, 27 FR 12359, Dec. 13, 1962, as amended by Amdt. 151-8, 30 FR 8040, June 23, 1965; Amdt. 151-17, 31 FR 16525, Dec. 28, 1966]

**APPENDIX B TO PART 151**

There is set forth below an itemization of typical eligible and ineligible items of site preparation as covered by §151.75 of this chapter:

*Typical Eligible Items*

1. General site preparation:
  - (a) Clearing of site.
  - (b) Grubbing of site.
  - (c) Grading of site.
  - (d) Storm drainage of site.
2. Erosion control.
3. Grading to remove obstructions.
4. Grading for installing navigation aids on airport property.
5. Dredging of seaplane anchorages and channels.

**14 CFR Ch. I (1-1-08 Edition)**

*Typical Ineligible Items*

1. Specific site preparation (not a part of an over-all site preparation project) for:
  - (a) Hangars and other buildings ineligible under the Act.
  - (b) Public parking facilities for passenger automobiles.
  - (c) Industrial and other non-airport purposes.

[Doc. No. 1329, 27 FR 12359, Dec. 13, 1962]

**APPENDIX C TO PART 151**

There is set forth below an itemization of typical eligible and ineligible items of runway paving as covered by §151.77 of this chapter:

*Typical Eligible Items*

1. New runways for specified loadings.
2. Runway widening of extensions for specified loadings.
3. Reconstruction of existing runways for specified loadings.
4. Resurfacing runways for specified strength or for smoothness.
5. Runway grooving to improve skid resistance.

*Typical Ineligible Items*

1. Maintenance-type work, including:
  - (a) Seal coats.
  - (b) Crack filling.
  - (c) Resealing joints.
  - (d) Runway patching.
  - (e) Isolated repair.

[Doc. No. 1329, 27 FR 12360, Dec. 13, 1962, as amended by Amdt. 151-29, 34 FR 1634, Feb. 4, 1969]

**APPENDIX D TO PART 151**

There is set forth below an itemization of typical eligible and ineligible items of taxiway paving as covered by §151.81 of this chapter:

*Typical Eligible Items*

1. Basic types of pavement listed as eligible under §151.77.
2. Taxiway providing access to ends and intermediate points of eligible runways.
3. Bleed-off taxiways.
4. Bypass taxiways.
5. Run-up pads.
6. Primary taxiway systems providing access to hangar areas and other building areas delineated on approved airport layout plan.
7. Secondary taxiways providing access to groups of individual storage hangars and/or multiple-unit tee hangars.

*Typical Ineligible Items*

1. Basic types of pavement listed as ineligible under §151.77.

## Federal Aviation Administration, DOT

## Pt. 151, App. H

2. Taxiways providing access to an area not offering aircraft storage and/or service to the public.

3. Lead-ins to individual storage hangars.

[Doc. No. 1329, 27 FR 12360, Dec. 13, 1962, as amended by Amdt. 151-8, 30 FR 8040, June 23, 1965]

### APPENDIX E TO PART 151

There is set forth below an itemization of typical eligible and ineligible items of apron paving as covered by §151.83 of this chapter:

#### *Typical Eligible Items*

1. Basic types of pavement listed as eligible under §151.77.
2. Loading ramps.
3. Aprons available for public parking, storage, and service or a combination of any of the three.
4. Aprons serving hangars used for public storage of aircraft or service to the public, or both.
5. Aprons for cargo buildings used for public storage or service to the public, or both.

#### *Typical Ineligible Items*

1. Basic types of pavement listed as ineligible under §151.77.
2. Aprons serving installations for non-public use.
3. Paving inside a hangar or on the proposed site of a hangar.
4. Aprons for cargo buildings not under Item 5 of the "Typical Eligible Items".
5. Apron services (pits or pipes for chemicals) will not be eligible.

[Doc. No. 1329, 27 FR 12360, Dec. 13, 1962, as amended by Amdt. 151-17, 31 FR 16525, Dec. 28, 1966]

### APPENDIX F TO PART 151

There is set forth below an itemization of typical eligible and ineligible items of airport lighting covered by §§151.86 and 151.87 of this chapter:

#### *Typical Eligible Items*

1. Runway edge lights (high intensity, medium intensity, and low intensity).
2. In-runway lighting (touchdown zone lighting system, centerline lighting system, and exit taxiway lighting system).
3. Taxiway lights.
4. Taxiway guidance signs.
5. Obstruction lights.
6. Apron floodlights.
7. Beacons.
8. Wind and landing direction indicators.
9. Electrical ducts and manholes.
10. Transformer or generator vaults.
11. Control panels for field lighting.
12. Control equipment for field lighting.
13. Auxiliary power.

14. Lighting offsite obstructions.
15. Electrical vaults for field lighting.

#### *Typical Ineligible Items*

1. Electronic navigation aids.
2. Approach lights.
3. Horizon lights.
4. Isolated repair and reconstruction of airport lighting.
5. Lighting of public parking area for passenger automobiles.
6. Street or road lighting.

[Doc. No. 1329, 27 FR 12360, Dec. 13, 1962, as amended by Amdt. 151-24, 33 FR 12545, Sept. 5, 1968; Amdt. 151-35, 34 FR 13699, Aug. 27, 1969]

### APPENDIX G TO PART 151

There is set forth below an itemization of typical eligible and ineligible items of road construction covered by §151.89 of this chapter:

#### *Typical Eligible Items*

1. Entrance roads.
2. Service roads for access to public areas.
3. Service roads for airport maintenance (including perimeter airport service road within airport boundary and not for general public access).
4. Relocation of roads to permit airport development or expansion or to remove obstructions.

#### *Typical Ineligible Items*

1. Offsite roads.
2. Roads to areas of exclusive use.

[Doc. No. 1329, 27 FR 12360, Dec. 13, 1962]

### APPENDIX H TO PART 151

There is set forth below the contract provision required by the regulations of the Secretary of Labor in part 5 of title 29 of the Code of Federal Regulations. Section 151.49(a) requires sponsors to insert this provision in full in each construction contract.

#### PROVISION REQUIRED BY THE REGULATIONS OF THE SECRETARY OF LABOR

*A. Minimum wages.* (1) All mechanics and laborers employed or working upon the site of the work will be paid unconditionally and not less often than once a week, and without subsequent deduction or rebate on any account (except such payroll deductions as are permitted by regulations issued by the Secretary of Labor under the Copeland Act [29 CFR part 3]), the full amounts due at time of payment computed at wage rates not less than those contained in the wage determination decision(s) of the Secretary of Labor which is (are) attached hereto and made a

part hereof, regardless of any contractual relationship which may be alleged to exist between the contractor and such laborers and mechanics; and the wage determination decision(s) shall be posted by the contractor at the site of the work in a prominent place where it (they) can be easily seen by the workers. For the purpose of this paragraph, contributions made or costs reasonably anticipated under section 1(b)(2) of the Davis-Bacon Act on behalf of laborers or mechanics are considered wages paid to such laborers or mechanics, subject to the provisions of subparagraph (4) below. Also for the purpose of this paragraph, regular contributions made or costs incurred for more than a weekly period under plans, funds, or programs, but covering the particular weekly period, are deemed to be constructively made or incurred during such weekly period (29 CFR 5.5(a)(1)(i)).

(2) Any class of laborers or mechanics which is not listed in the wage determination(s) and which is to be employed under the contract, shall be classified or reclassified conformably to the wage determination(s), and a report of the action taken shall be sent by the [insert sponsor's name] to the FAA for approval and transmittal to the Secretary of Labor. In the event that the interested parties cannot agree on the proper classification or reclassification of a particular class of laborers and mechanics to be used, the question accompanied by the recommendation of the FAA shall be referred to the Secretary of Labor for final determination (29 CFR 5.5(a)(1)(ii)).

(3) Whenever the minimum wage rate prescribed in the contract for a class of laborers or mechanics includes a fringe benefit which is not expressed as an hourly wage rate and the contractor is obligated to pay a cash equivalent of such a fringe benefit, an hourly cash equivalent thereof shall be established. In the event the interested parties cannot agree upon a cash equivalent of the fringe benefit, the question, accompanied by the recommendation of the FAA shall be referred to the Secretary of Labor for determination (29 CFR 5.5(a)(1)(iii)).

(4) If the contractor does not make payments to a trustee or other third person, he may consider as part of the wages of any laborer or mechanic the amount of any costs reasonably anticipated in providing benefits under a plan or program of a type expressly listed in the wage determination decision of the Secretary of Labor which is a part of this contract: *Provided, however*, The Secretary of Labor has found, upon the written request of the contractor, that the applicable standards of the Davis-Bacon Act have been met. The Secretary of Labor may require the contractor to set aside in a separate account assets for the meeting of obligations under the plan or program.

*B. Withholding: FAA from sponsor.* Pursuant to the terms of the grant agreement between the United States and [insert sponsor's name], relating to Federal-aid Airport Project No. \_\_\_\_, and part 151 of the Federal Aviation Regulations (14 CFR part 151), the FAA may withhold or cause to be withheld from the [insert sponsor's name] so much of the accrued payments or advances as may be considered necessary to pay laborers and mechanics employed by the contractor or any subcontractor on the work the full amount of wages required by this contract. In the event of failure to pay any laborer or mechanic employed or working on the site of the work all or part of the wages required by this contract, the FAA may, after written notice to the [insert sponsor's name], take such action as may be necessary to cause the suspension of any further payment or advance of funds until such violations have ceased (29 CFR 5.5(a)(2)).

*C. Payrolls and basic records.* (1) Payrolls and basic records relating thereto will be maintained during the course of the work and preserved for a period of three years thereafter for all laborers and mechanics working at the site of the work. Such records will contain the name and address of each such employee, his correct classification, rates of pay (including rates of contributions or costs anticipated of the types described in section 1(b)(2) of the Davis-Bacon Act), daily and weekly number of hours worked, deductions made and actual wages paid. Whenever the Secretary of Labor has found, under 29 CFR 5.5(a)(1)(iv) (see subparagraph (4) of subparagraph (A) above), that the wages of any laborer or mechanic include the amount of any costs reasonably anticipated in providing benefits under a plan or program described in section 1(b)(2)(B) of the Davis-Bacon Act, the contractor shall maintain records which show that the commitment to provide such benefits is enforceable, that the plan or program is financially responsible, and that the plan or program has been communicated in writing to the laborers or mechanics affected, and records which show the costs anticipated or the actual cost incurred in providing such benefits (29 CFR 5.5(a)(3)(i)).

(2) The contractor will submit weekly a copy of all payrolls to the [insert sponsor's name] for transmission to the FAA, as required by §151.53(a). The copy shall be accompanied by a statement signed by the employer or his agent indicating that the payrolls are correct and complete, that the wage rates contained therein are not less than those determined by the Secretary of Labor and that the classifications set forth for each laborer or mechanic conform with the work he performed. A submission of a "Weekly Statement of Compliance" which is required under this contract and the Copeland regulations of the Secretary of Labor (29 CFR part

3) and the filing with the initial payroll or any subsequent payroll of a copy of any findings by the Secretary of Labor, under 29 CFR 5.5(a)(1)(iv) (see subparagraph (4) of paragraph (A) above), shall satisfy this requirement. The prime contractor shall be responsible for the submission of copies of payrolls of all subcontractors. The contractor will make the records required under the labor standards clauses of the contract available for inspection by authorized representatives of the FAA and the Department of Labor, and will permit such representatives to interview employees during working hours on the job (29 CFR 5.5(a)(3)(ii)).

*D. Apprentices.* Apprentices will be permitted to work as such only when they are registered, individually, under a bona fide apprenticeship program registered with a State apprenticeship agency which is recognized by the Bureau of Apprenticeship and Training, United States Department of Labor; or, if no such recognized agency exists in a State, under a program registered with the Bureau of Apprenticeship and Training, United States Department of Labor. The allowable ratio of apprentices to journeymen in any craft classification shall not be greater than the ratio permitted to the contractor as to his entire work force under the registered program. Any employee listed on a payroll at an apprentice wage rate, who is not registered as above, shall be paid the wage rate determined by the Secretary of Labor for the classification of work he actually performed. The contractor or subcontractor will be required to furnish to the [insert sponsor's name] written evidence of the registration of his program and apprentices as well as of the appropriate ratios and wage rates, for the area of construction prior to using any apprentices on the contract work (29 CFR 5.5(a)(4)).

*E. Compliance with Copeland Regulations.* The contractor shall comply with the Copeland Regulations (29 CFR part 3) of the Secretary of Labor which are herein incorporated by reference (29 CFR 5.5(a)(5)).

*F. Overtime requirements.* No contractor or subcontractor contracting for any part of the contract work which may require or involve the employment of laborers or mechanics shall require or permit any laborer or mechanic in any workweek in which he is employed on such work to work in excess of eight hours in any calendar day or in excess of forty hours in such workweek unless such laborer or mechanic received compensation at a rate not less than one and one-half times his basic rate of pay for all hours worked in excess of eight hours in any calendar day or in excess of forty hours in such workweek, as the case may be (29 CFR 5.5(c)(1)).

*G. Violations; liability for unpaid wages; liquidated damages.* In the event of any violation of paragraph F of this provision, the

contractor and any subcontractor responsible therefore shall be liable to any affected employee for his unpaid wages. In addition, such contractor and subcontractor shall be liable to the United States for liquidated damages. Such liquidated damages shall be computed, with respect to each individual laborer or mechanic employed in violation of said paragraph F of this provision, in the sum of \$10 for each calendar day on which such employee was required or permitted to work in excess of eight hours or in excess of the standard workweek of forty hours without payment of the overtime wages required by said paragraph F of this provision (29 CFR 5.5(c)(2)).

*H. Withholding for unpaid wages and liquidated damages, and priority of payment* (1) The FAA may withhold or cause to be withheld, from any moneys payable on account of work performed by the contractor or subcontractor, such sums as may administratively be determined to be necessary to satisfy any liabilities of such contractor or subcontractor for unpaid wages and liquidated damages as provided in paragraph G of this provision (29 CFR 5.5(c)(3)).

(2) In the event of failure or refusal of the contractor or any subcontractor to comply with overtime pay requirements of the Contract Work Hours Standards Act, if the funds withheld by the FAA for the violations are not sufficient to pay fully both the unpaid wages due laborers and mechanics and the liquidated damages due the United States, the available funds shall be used first to compensate the laborers and mechanics for the wages to which they are entitled (or an equitable portion thereof when the funds are not adequate for this purpose); and the balance, if any, shall be used for the payment of liquidated damages (29 CFR 5.14(d)(2)).

*I. Subcontracts.* The contractor will insert in each of his subcontracts the clauses contained in paragraphs A through H and J of this provision, and also a clause requiring the subcontractors to include these provisions in any lower tier subcontracts which they may enter into, together with a clause requiring this insertion in any further subcontracts that may in turn be made (29 CFR 5.5(a)(6), 5.5(c)(4)).

*J. Contract termination; debarment.* A breach of paragraphs A through I of this provision may be grounds for termination of the contract. A breach of paragraphs A through E and I may also be grounds for debarment as provided in 29 CFR 5.6 of the regulations of the Secretary of Labor (29 CFR 5.5(a)(8)).

[Doc. No. 6387, 29 FR 18002, Dec. 18, 1964, as amended by Amdt. 151-9, 30 FR 14197, Nov. 11, 1965; Amdt. 151-38, 35 FR 5112, Mar. 26, 1970]

Pt. 151, App. I

14 CFR Ch. I (1-1-08 Edition)

APPENDIX I TO PART 151

[Lists of Advisory Circulars incorporated by § 151.72: (a)  
Circulars available free of charge.]

Number	Subject
AC 150/5300-3 .....	Adaptation of TSO-N18 Criterion to Clearways and Stopways.
AC 150/5325-2A .....	Airport Surface Areas Gradient Standards.
AC 150/5325-4 .....	Runway Length Requirements for Airport Design.
AC 150/5330-2 .....	Runway/Taxiway Widths and Clearances.
AC 150/5335-1 .....	Airway Taxiways.
AC 150/5340-1A .....	Marking of Serviceable Runways and Taxiways.
AC 150/5340-3 .....	Configuration Details of In-Runway Lighting: Touchdown Zone, Runway Centerline, and Taxiway Turnoff Lighting Systems.
AC 150/5340-4A .....	Installation Details for Centerline and Touchdown Zone Lighting Systems.
AC 150/5340-5 .....	Segmented Circle Airport Marker System.
AC 150/5340-7 .....	Marking of Deceptive, Closed, and Hazardous Areas on Airports.
AC 150/5340-13 .....	High Intensity Lighting System.
AC 150/5340-14 .....	Economy Approach Lighting Aids.
AC 150/5340-15 .....	Taxiway Lighting System.
AC 150/5345-1A .....	Approved Airport Lighting Equipment.
AC 150/5345-2 .....	Specification for L-810 Obstruction Light.
AC 150/5345-3 .....	Specification for L-821 Airport Lighting Panel for Remote Control of Airport Lighting.
AC 150/5345-4 .....	Specification for L-829 Internally Lighted Airport Taxi Guidance Sign.
AC 150/5345-5 .....	Specification for L-847 Circuit Selector Switch, 5000 Volt 20 Ampere.
AC 150/5345-6 .....	Specification for L-809 Airport Light Base and Transformer Housing.
AC 150/5345-7 .....	Specification for L-824 Underground Electrical Cables for Airport Lighting Circuits.
AC 150/5345-8 .....	Specification for L-840 Low Intensity Runway, Landing Strip and Taxiway Light.
AC 150/5345-9A .....	Specification for L-819 Fixed Focus Bidirectional High Intensity Runway Light.
AC 150/5345-10A .....	Specification for L-828 Constant Current Regulator with Stepless Brightness Control.
AC 150/5345-11 .....	Specification for L-812 Static Indoor Type Constant Current Regulator Assembly, 4 KW and 7½ KW, with Brightness Control for Remote Operation.
AC 150/5345-12 .....	Specification for L-801 Beacon for Small Airports.
AC 150/5345-13 .....	Specification for L-841 Auxiliary Relay Cabinet Assembly for Pilot Control of Airport Lighting Circuits.
AC 150/5345-14 .....	Specification for L-827 "A" Frame Hinged Support for 12-Foot Wind Cone.
AC 150/5345-15 .....	Specification for L-842 Airport Centerline Light.
AC 150/5345-16 .....	Specification for L-843 Airport In-Runway Touchdown Zone Light.
AC 150/5345-17 .....	Specification for L-845 Semiflush Inset Prismatic Airport Light.

[Lists of Advisory Circulars incorporated by § 151.72: (a)  
Circulars available free of charge.]

Number	Subject
AC 150/5345-18 .....	Specification for L-811 Static Indoor Type Constant Current Regulator Assembly, 4 KW; With Brightness Control and Runway Selection for Direct Operation.
AC 150/5345-19 .....	Specification for L-838 Semiflush Prismatic Airport Light.
AC 150/5345-20 .....	Specification for L-802 Runway and Strip Light.
AC 150/5345-21 .....	Specification for L-813 Static Indoor Type Constant Current Regulator Assembly, 4 KW and 7½ KW; for Remote Operation of Taxiway Lights.
AC 150/5345-22 .....	Specification for L-834 Individual Lamp Series-to-Series Type Insulating Transformer for 5,000 Volt Series Circuit.
AC 150/5345-23 .....	Specification for L-822 Taxiway Edge Light.
AC 150/5345-24 .....	Specification for L-849 Condenser Discharge Type Flashing Light.
AC 150/5345-25 .....	Specification for L-848 Medium Intensity Approach Light Bar Assembly.
AC 150/5345-26 .....	Specification for L-823 Plug and Receptacle, Cable Connectors.
AC 150/5345-27 .....	Specification for L-807 Eight-Foot Illuminated Wind Cone.
AC 150/5345-30 .....	Specification for L-846 Electrical Wire for Lighting Circuits To Be Installed in Airport Pavements.
AC 150/5345-31 .....	Specification for L-833 Individual Lamp Series-to-Series Type Insulating Transformer for 600 Volt or 3,000 Volt Series Circuits.
AC 150/5345-32 .....	Specification for L-837 Large-Size Light Base and Transformer Housing.
AC 150/5345-33 .....	Specification for L-844 Individual Lamp Series-to-Series Type Insulating Transformer for 5,000 Volt Series Circuit 20/6.6 Amperes 200 Watt.
AC 150/5345-34 .....	Specification for L-839 Individual Lamp Series-to-Series Type Insulating Transformer for 5,000 Volt Series Circuit 6.6/20 Amperes 300 Watt.
AC 150/5345-35 .....	Specification for L-816 Circuit Selector Cabinet Assembly for 600 Volt Series Circuits.
AC 150/5345-36 .....	Specification for L-808 Lighted Wind Tee.
AC 150/5345-37A .....	FAA Specification L-850, Light Assembly, Airport Runway, Centerline.
AC 150/5370-3 .....	Materials and Tests Required by AC 150/5370-1, Standard Specifications for Construction of Airports.
AC 150/5310-1 .....	Preparation of Airport Layout Plans.
(b) Circulars for sale at the price stated.	
AC 150/5370-1 .....	Standard Specifications for Construction of Airports; \$2.75.
AC 150/5370-1, CH 1	Standard Specifications for Construction of Airports; \$0.35.

**Federal Aviation Administration, DOT**

**§ 152.3**

[Amdt. 151-13, 31 FR 11606, Sept. 2, 1966, as amended by Amdt. 151-15, 31 FR 13423, Oct. 18, 1966]

**PART 152—AIRPORT AID PROGRAM**

**Subpart A—General**

Sec.

- 152.1 Applicability.
- 152.3 Definitions.
- 152.5 Exemptions.
- 152.7 Certifications.
- 152.9 Forms.
- 152.11 Incorporation by reference.

**Subpart B—Eligibility Requirements and Application Procedures**

- 152.101 Applicability.
- 152.103 Sponsors: Airport development.
- 152.105 Sponsors and planning agencies: Airport planning.
- 152.107 Project eligibility: Airport development.
- 152.109 Project eligibility: Airport planning.
- 152.111 Application requirements: Airport development.
- 152.113 Application requirements: Airport planning.
- 152.115 Grant agreement: Offer, acceptance, and amendment.
- 152.117 Public hearings.
- 152.119 Contract requirements and procurement standards.

**Subpart C—Funding of Approved Projects**

- 152.201 Applicability.
- 152.203 Allowable project costs.
- 152.205 United States share of project costs.
- 152.207 Proceeds from disposition of land.
- 152.209 Grant payments: General.
- 152.211 Grant payments: Land acquisition.
- 152.213 Grant closeout requirements.

**Subpart D—Accounting and Reporting Requirements**

- 152.301 Applicability.
- 152.303 Financial management system.
- 152.305 Accounting records.
- 152.307 Retention of records.
- 152.309 Availability of sponsor's records.
- 152.311 Availability of contractor's records.
- 152.313 Property management standards.
- 152.315 Reporting on accrual basis.
- 152.317 Report of Federal cash transactions.
- 152.319 Monitoring and reporting of program performance.
- 152.321 Notice of delay or acceleration.
- 152.323 Budget revision: Airport development.
- 152.325 Financial status report: Airport planning.

**Subpart E—Nondiscrimination in Airport Aid Program**

- 152.401 Applicability.
- 152.403 Definitions.
- 152.405 Assurances.
- 152.407 Affirmative action plan: General.
- 152.409 Affirmative action plan standards.
- 152.411 Affirmative action steps.
- 152.413 Notice requirement.
- 152.415 Records and reports.
- 152.417 Monitoring employment.
- 152.419 Minority business.
- 152.421 Public accommodations, services, and benefits.
- 152.423 Investigation and enforcement.
- 152.425 Effect of subpart.

**Subpart F—Suspension and Termination of Grants**

- 152.501 Applicability.
- 152.503 Suspension of grant.
- 152.505 Termination for cause.
- 152.507 Termination for convenience.
- 152.509 Request for reconsideration.

**Subpart G—Energy Conservation in Airport Aid Program**

- 152.601 Purpose.
- 152.603 Applicability.
- 152.605 Definitions.
- 152.607 Building design requirements.
- 152.609 Energy conservation practices.

APPENDIX A TO PART 152—CONTRACT AND LABOR PROVISIONS

APPENDIX B TO PART 152—LIST OF ADVISORY CIRCULARS INCORPORATED BY § 152.11

APPENDIX C TO PART 152—PROCUREMENT PROCEDURES AND REQUIREMENTS

APPENDIX D TO PART 152—ASSURANCES

AUTHORITY: 49 U.S.C. 106(g), 47106, 47127.

SOURCE: Docket No. 19430, 45 FR 34784, May 22, 1980, unless otherwise noted.

**Subpart A—General**

**§ 152.1 Applicability.**

This part applies to airport planning and development under the Airport and Airway Development Act of 1970, as amended (49 U.S.C. 1701 *et seq.*).

**§ 152.3 Definitions.**

The following are definitions of terms used throughout this part:

*ADA* means the Airport and Airway Development Act of 1970, as amended (49 U.S.C. 1701 *et seq.*).

*Air carrier airport* means—

(1) An existing public airport regularly served, or a new public airport

§ 152.3

14 CFR Ch. I (1-1-08 Edition)

that the Administrator determines will be regularly served, by an air carrier, other than a charter air carrier, certificated by the Civil Aeronautics Board under section 401 of the Federal Aviation Act of 1958; and

(2) A commuter service airport.

*Airport* means—

(1) Any area of land or water that is used, or intended for use, for the landing and takeoff of aircraft;

(2) Any appurtenant areas that are used, or intended for use, for airport buildings, other airport facilities, or rights-of-way; and

(3) All airport buildings and facilities located on the areas specified in this definition.

*Airport development* means—

(1) Any work involved in constructing, improving, or repairing a public airport or portion thereof, including the removal, lowering, relocation, and marking and lighting or airport hazards, and including navigation aids used by aircraft landing at, or taking off from, a public airport, and including safety equipment required by rule or regulation for certification of the airport under section 612 of the Federal Aviation Act of 1958, and security equipment required of the sponsor by the FAA by rule or regulation for the safety and security of persons or property on the airport, and including snow removal equipment, and including the purchase of noise suppressing equipment, the construction of physical barriers, and landscaping for the purpose of diminishing the effect of aircraft noise on any area adjacent to a public airport.

(2) Any acquisition of land or of any interest therein, or of any easement through or other interest in airspace, including land for future airport development, which is necessary to permit any such work or to remove or mitigate or prevent or limit the establishment of, airport hazards; and

(3) Any acquisition of land or of any interest therein necessary to insure that such land is used only for purposes which are compatible with the noise levels of the operation of a public airport.

*Airport hazard* means any structure or object of natural growth located on or in the vicinity of a public airport, or

any use of land near a public airport, that—

(1) Obstructs the airspace required for the flight of aircraft landing or taking off at the airport; or

(2) Is otherwise hazardous to aircraft landing or taking off at the airport.

*Airport layout plan* means a plan for the layout of an airport, showing existing and proposed airport facilities.

*Airport master planning* means the development for planning purposes of information and guidance to determine the extent, type, and nature of development needed at a specific airport.

*Airport system planning* means the development for planning purposes of information and guidance to determine the extent, type, nature, location, and timing of airport development needed in a specific area to establish a viable and balanced system of public airports.

*Audit* means the examination and verification of part or all of the documentary evidence supporting an item of project cost in accordance with Attachment P of Office of Management and Budget Circular A-102 (44 FR 60958).

*Commuter service airport* means an air carrier airport—

(1) That is not served by an air carrier certificated under section 401 of the Federal Aviation Act of 1958;

(2) That is regularly served by one or more air carriers operating under an exemption granted by the Civil Aeronautics Board from section 401(a) of the Federal Aviation Act of 1958; and

(3) At which not less than 2,500 passengers were enplaned during the preceding calendar year by air carriers operating under an exemption from section 401(a).

*Force account* means—

(1) The sponsor's or planning agency's own labor force; or

(2) The labor force of another public agency acting as an agent of the sponsor or planning agency.

*General aviation airport* means a public airport other than an air carrier airport.

*Landing area* means an area used, or intended to be used, for the landing, takeoff, or surface maneuvering of aircraft.

*NASP* means the National Airport System Plan.

*National Airport System Plan* means the plan for the development of public airports in the United States formulated by the Administrator under section 12 of the AADA.

*Nonrevenue producing public-use areas* means areas that are directly related to the movement of passengers and baggage in air commerce within the boundaries of the airport.

*Passengers enplaned* means—

(1) United States domestic, territorial, and international revenue passenger enplanements in scheduled and nonscheduled service of air carriers; and

(2) Revenue passenger enplanements by foreign air carriers in intrastate and interstate commerce.

*Planning agency* means a planning agency designated by the Administrator that is authorized by the laws of a State, the Commonwealth of Puerto Rico, the Virgin Islands, American Samoa, the Trust Territory of the Pacific Islands, or Guam, or by the laws of a political subdivision of any of those entities, to engage in areawide planning for the areas in which assistance under this part is to be used.

*Project* means a project for the accomplishment of airport development, airport master planning, or airport system planning.

*Project costs* means any costs involved in accomplishing a project.

*Project formulation costs* means, with respect to projects for airport development, any necessary costs of formulating a project including—

(1) The costs of field surveys and the preparation of plans and specifications;

(2) The acquisition of land or interests in land, or easement through or other interests in airspace; and

(3) Any necessary administrative or other incidental costs incurred by the sponsor specifically in connection with the accomplishment of a project for airport development, that would not have been incurred otherwise.

*Public agency* means—

(1) A state, the Commonwealth of Puerto Rico, the Virgin Islands, American Samoa, the Trust Territory of the Pacific Islands, the Government of the Northern Marianas, Guam, or any agency of those entities;

(2) A municipality or other political subdivision;

(3) A tax-supported organization; or

(4) An Indian tribe or pueblo.

*Public airport* means any airport that—

(1) Is used, or intended to be used, for public purposes;

(2) Is under the control of a public agency; and

(3) Has a property interest satisfactory to the Administrator in the landing area.

*Reliever airport* means a general aviation airport designated by the Administrator as having the primary function of relieving congestion at an air carrier airport by diverting from that airport general aviation traffic.

*Runway clear zone* means an area at ground level underlying a portion of the approach surface specified in the standards incorporated into this part by §152.11.

*Satisfactory property interest* means—

(1) Title free and clear of any reversionary interest, lien, easement, lease, or other encumbrance that, in the opinion of the Administrator would—

(i) Create an undue risk that it might deprive the sponsor of possession or control;

(ii) Interfere with the use of the airport for public airport purposes; or

(iii) Make it impossible for the sponsor to carry out the agreements and covenants in its grant application;

(2) Unless a shorter term is authorized by the Administrator, a lease of not less than 20 years granted to the sponsor by another public agency, or the United States, that has title as described in paragraph (1) of this definition, on terms that the Administrator considers satisfactory;

(3) In the case of an off-airport area, title or an agreement, easement, leasehold or other right or property interest that, in the Administrator's opinion, provides reasonable assurance that the sponsor will not be deprived of its right to use the land for the intended purpose during the period necessary to meet the requirements of the grant agreement; or

(4) In the case of a runway clear zone, an easement or a covenant running with the land, giving the airport operator or owner enough control to rid the

## § 152.5

## 14 CFR Ch. I (1-1-08 Edition)

clear zone of all airport hazards and prevent the creation of future airport hazards.

*Sponsor* means any public agency that, whether individually or jointly with one or more other public agencies, submits to the Administrator, in accordance with this part, an application for financial assistance.

*Stage development* means airport development accomplished under stage construction over not less than two years where the sponsor assures that any development not funded under the initial grant agreement will be completed with or without Federal funds.

*State* means a State of the United States or the District of Columbia.

*Terminal development* means airport development in the nonrevenue producing public-use areas which are associated with the terminal and which are directly related to the movement of passengers and baggage in air commerce within the boundaries of the airport, including, but not limited to, vehicles for the movement of passengers between terminal facilities and aircraft.

*Unified Planning Work Program* means a single document prepared by a local areawide planning agency that identifies all transportation and related planning activities that will be undertaken within the metropolitan area during a one-year or two-year period.

### § 152.5 Exemptions.

(a) Except as provided in paragraph (b) of this section, any interested person may petition the Regional Director concerned for a temporary or permanent exemption from any requirement of this part.

(b) The Regional Director concerned does not issue an exemption from any rule of this part if the grant of exemption would be inconsistent with a specific provision of, or the purpose of, the AADA, or any other applicable Federal law.

(c) Each petition filed under this section must—

(1) Unless otherwise authorized by the Regional Director concerned, be submitted not less than 60 days before the proposed effective date of the exemption;

(2) Be submitted in duplicate to the FAA Regional Office or Airports District Office having jurisdiction over the area in which the airport is located;

(3) Contain the text or substance of the rule from which the exemption is sought;

(4) Explain the nature and extent of the relief sought; and

(5) Contain any information, views, or arguments in support of the exemption.

(d) The Regional Director concerned either grants or denies the exemption and notifies the petitioner of the decision. The FAA publishes a summary of the grant or denial of petition for exemption in the FEDERAL REGISTER.

The summary includes—

(1) The docket number of the petition;

(2) The name of the petitioner;

(3) A citation of each rule from which relief is requested;

(4) A brief description of the general nature of the relief requested; and

(5) The disposition of the petition.

(e) Official FAA records, including grants and denials of exemptions, relating to petitions for exemption are maintained in current docket form in the Office of the Regional Counsel for the region concerned.

(f) Any interested person may—

(1) Examine any docketed material at the Office of the Regional Counsel, at any time after the docket is established, except material that is ordered withheld from the public under section 1104 of the Federal Aviation Act of 1958 (49 U.S.C. 1504); and

(2) Obtain a photostatic or similar copy of docketed material upon paying the same fee as that prescribed in 49 CFR part 7.

### § 152.7 Certifications.

(a) Subject to such terms and conditions as the Administrator may prescribe, a sponsor or a planning agency may submit, with respect to any provision of this part implementing a statutory or administrative requirement imposed on the sponsor or planning agency under the AADA, a certification that the sponsor or planning agency has complied or will comply with the

provision, instead of making the showing required.

(b) The Administrator exercises discretion in determining whether to accept a certification.

(c) Acceptance by the Administrator of a certification from a sponsor or planning agency may be rescinded by the Administrator at any time if, in the Administrator's opinion, it is necessary to do so.

(d) If the Administrator determines that it is necessary, the sponsor or planning agency, on request, shall show compliance with any requirement for which a certification was accepted.

#### § 152.9 Forms.

Any form needed to comply with this part may be obtained at any FAA Regional Office or Airports District Office.

#### § 152.11 Incorporation by reference.

(a) *Mandatory standards.* The advisory circulars listed in appendix B to this part are incorporated into this part by reference. The Director, Office of Airport Standards, determines the scope and content of the technical standards to be included in each advisory circular in appendix B, and may add to, or delete from, appendix B any advisory circular or part thereof. Except as provided in paragraph (c) of this section, these guidelines are mandatory standards.

(b) *Modification of standards.* When necessary to meet local conditions, any technical standard set forth in appendix B may be modified for individual projects, if it is determined that the modifications will provide an acceptable level of safety, economy, durability, and workmanship. The determination and modification may be made by the Director, Office of Airport Standards, or the appropriate Regional Director, in instances where the authority has not been specifically reserved by the Director, Office of Airport Standards.

(c) *State standards.* Standards established by a state for airport development at general aviation airports in the state may be the standards applicable to those airports when they have been approved by the Director, Office of Airport Standards, or the appro-

priate Regional Director, in instances where approval authority has not been specifically reserved by the Director, Office of Airport Standards.

(d) *Availability of advisory circulars.* The advisory circulars listed in appendix B may be inspected and copied at any FAA Regional Office or Airports District Office. Copies of the circulars that are available free of charge may be obtained from any of those offices or from the FAA Distribution Unit, M-443.1, Washington, DC 20590. Copies of the circulars that are for sale may be bought from the Superintendent of Documents, U.S. Government Printing Office, Washington, DC 20402.

### Subpart B—Eligibility Requirements and Application Procedures

SOURCE: Docket No. 19430, 45 FR 34786, May 22, 1980, unless otherwise noted.

#### § 152.101 Applicability.

This subpart contains requirements and application procedures applicable to airport development and planning projects.

#### § 152.103 Sponsors: Airport development.

(a) To be eligible to apply for a project for airport development with respect to a particular airport the following requirements must be met:

(1) Each sponsor must be a public agency authorized by law to submit the project application;

(2) If a sponsor is the holder of an airport operating certificate issued for the airport under part 139 of this chapter, it must be in compliance with the requirements of part 139.

(3) When any of the following agreements is applicable to an airport which the sponsor owns or controls, the sponsor must have complied with the agreement, or show to the satisfaction of the Administrator that it will comply or, for reasons beyond its control, cannot comply with the agreement:

(i) Each grant agreement made with it under the Federal Airport Act (49 U.S.C. 1101 *et seq.*), or the AADA.

(ii) Each covenant in a conveyance to it under section 16 of the Federal Airport Act or section 23 of the AADA.

**§ 152.105**

**14 CFR Ch. I (1-1-08 Edition)**

(iii) Each covenant in a conveyance to it of surplus airport property under section 13(a) of the Surplus Property Act (50 U.S.C. App 1622(g)) or under Regulation 16 of the War Assets Administration.

(4) The sponsor, in the case of a single sponsor, or one or more of the co-sponsors must have, or be able to obtain—

(i) Funds to pay all estimated costs of the project that are not to be born by the United States; and

(ii) Satisfactory property interests in the lands to be developed or used as part of, or in connection with, the airport as it will be after the project is completed.

(b) Another public agency may act as agent of the public agency that is to own and operate the airport, for the purpose of channeling grant funds in accordance with state or local law, without becoming a sponsor.

**§ 152.105 Sponsors and planning agencies: Airport planning.**

(a) To be eligible to apply for a project for airport planning—

(1) If the project is for airport master planning—

(i) Each sponsor must be a public agency and meet the requirements of § 152.103(a)(3); and

(ii) The sponsor, in the case of a single sponsor, or one or more cosponsors must be legally able to implement the planning, within the existing or proposed airport boundaries, that results from the project study.

(2) If the project is for airport system planning, each sponsor must be a planning agency.

(b) Another public agency or planning agency may act as agent of another public agency or planning agency, for the purpose of channeling grant funds in accordance with state or local law, without becoming a sponsor.

**§ 152.107 Project eligibility: Airport development.**

(a) Except in the case of approved stage development, each project for airport development must provide for—

(1) Development of an airport or unit of an airport that is safe, useful, and usable; or,

(2) An additional facility that increases the safety, usefulness, and usability of an airport.

(b) Unless otherwise authorized by the Administrator, a project for airport development must involve more than \$25,000 in United States funds.

(c) The development included in a project for airport development must—

(1) In the opinion of the Administrator, be “airport development” as defined in § 152.3;

(2) Be identified as airport development in the mandatory standards incorporated into this part by § 152.11; and

(3) Be described in an approved airport layout plan.

(d) The airport involved in a project for airport development must be included in the current NASP.

(e) In complying with paragraph (a) of this section, the sponsor must—

(1) Own, acquire, or agree to acquire control over, or a property interest in, runway clear zones that the Administrator considers adequate; and

(2) Provide for approach and runway lighting systems satisfactory to the Administrator.

**§ 152.109 Project eligibility: Airport planning.**

(a) *Airport master planning.* A proposed project for airport master planning is not approved unless—

(1) The location of the existing or proposed airport is included in the current NASP;

(2) In the opinion of the Administrator, the proposed planning would promote the effective location of public airports and the development of an adequate NASP;

(3) The project is airport master planning as defined in § 152.3;

(4) If the project has been determined to have areawide significance by an appropriate areawide agency, it has been incorporated into a unified planning work program; and

(5) In the case of a proposed project for airport master planning in a large or medium air traffic hub, in the opinion of the Administrator—

(i) There is an appropriate system plan identifying the need for the airport;

(ii) The absence of a system plan is due to the failure of the responsible planning agency to proceed with its preparation; or

(iii) An existing system plan is not acceptable.

(b) *Airport system planning.* A proposed project for airport system planning is not approved unless—

(1) In the opinion of the Administrator, the project promotes the effective location of public airports;

(2) In the opinion of the Administrator, the project promotes the development of an adequate NASP;

(3) The project is airport system planning as defined in § 152.3; and

(4) When the project encompasses a metropolitan area that includes a large or medium hub airport, the project is incorporated in a unified planning work program.

**§ 152.111 Application requirements: Airport development.**

(a) An eligible sponsor that desires to obtain Federal aid for eligible airport development must apply to the FAA in accordance with this section. The sponsor must apply on a form and in a manner prescribed by the Administrator, through the FAA Airports District Office or Airports Field Office having jurisdiction over the area where the sponsor is located or, where there is no such office, the Regional Office having that jurisdiction.

(b) *Preapplication for Federal assistance.* A preapplication for Federal assistance must be submitted unless—

(1) The Federal fund request is for \$100,000 or less; or,

(2) The project does not include construction, land acquisition, or land improvement.

(c) Unless otherwise authorized by the Administrator, the preapplication required by paragraph (b) of this section must be accompanied by the following:

(1) A list of the items of airport development requested for programming, together with an itemized estimated cost of the work involved.

(2) A sketch or sketches of the airport layout indicating the location for each item of work proposed, using the same item numbers used in the list re-

quired by paragraph (c)(1) of this section.

(3) If the proposed project involves the displacement of persons or the acquisition of real property, the assurances required by §§ 25.57 and 25.59, as applicable, of the Regulations of the Office of the Secretary of Transportation (49 CFR 25.57 and 25.59), whether or not reimbursement is being requested for the costs of displacement or real property acquisition.

(4) Any comments or statements required by appendix E, Procedures Implementing Office of Management and Budget Circular A-95, to this part, with a showing that they have been considered by the sponsor.

(5) If the proposed development involves the construction of eligible airport buildings or the acquisition of eligible fixed equipment to be contained in those buildings, a statement whether the proposed development will be in an area of the community that has been identified by the Department of Housing and Urban Development as an area of special flood hazard as defined in the Flood Disaster Protection Act of 1973 (42 U.S.C. 4002 *et seq.*).

(6) If the proposed development is in an area of special flood hazard, a statement whether the community is participating in the National Flood Insurance Program (42 U.S.C. 4011 *et seq.*).

(7) The sponsor's environmental assessment prepared in conformance with appendix 6 of FAA Order 1050.1C, "Policies and Procedures for Considering Environmental Impacts" (45 FR 2244; Jan. 10, 1980), and FAA Order 5050.4, "Airport Environmental Handbook" (45 FR 56624; Aug. 24, 1980), if an assessment is required by Order 5050.4. Copies of these orders may be examined in the Rules Docket, Office of the Chief Counsel, FAA, Washington, D.C., and may be obtained on request at any FAA regional office headquarters or any airports district office.

(8) A showing that the sponsor has complied with the public hearing requirements in § 152.117.

(9) In the case of a proposed new airport serving any area that does not include a metropolitan area, a showing that each community in which the proposed airport is to be located has approved the proposed airport site

through the body having general legislative jurisdiction over it.

(10) In the case of a proposed project at an air carrier airport, a statement that the sponsor, in making the decision to undertake the project, has consulted with air carriers using the airport.

(11) In the case of a proposed project at a general aviation airport, a statement that the sponsor, in making the decision to undertake the project, has consulted with fixed-base operators using the airport.

(12) In the case of terminal development, a certification that the airport has, or will have, all safety and security equipment required for certification of the airport under part 139 and has provided, or will provide, for access to the passenger enplaning and deplaning area to passengers enplaning or deplaning from aircraft other than air carrier aircraft.

(d) *Allocation of funds.* If the proposed project for airport development is selected by the Administrator for inclusion in a program, a tentative allocation of funds is made for the project and the sponsor is notified of the allocation. The tentative allocation may be withdrawn if the sponsor does not submit a project application in accordance with paragraph (f) of this section.

(e) *Application for Federal assistance.* As soon as practicable after receiving notice of a tentative allocation or, if a preapplication is not required (as provided in paragraph (b) of this section), an application for Federal assistance must be submitted.

(f) Unless otherwise authorized by the Administrator, the application required by paragraph (e) of this section must be accompanied by the following:

(1) When a preapplication has not been previously submitted, the information required by paragraph (c) of this section.

(2) A property map of the airport showing—

(i) The property interests of each sponsor in all the lands to be developed or used as part of, or in connection with, the airport as it will be when the project is completed; and

(ii) All property interests acquired or to be acquired, for which U.S. aid is requested under the project.

(3) With respect to all lands to be developed or used as a part of, or in connection with, the airport (as it will be when the project is completed) in which a satisfactory property interest is not held by a sponsor, a covenant by the sponsor that it will obtain a satisfactory property interest before construction is begun or within a reasonable time if not needed for construction.

(4) If the proposed project involves the displacement of persons, the relocation plan required by §25.55 of the Regulations of the Office of the Secretary of Transportation.

(5) When the project involves an airport location, a runway location, or a major runway extension, a written certification from the Governor of the state in which the project may be located (or a delegatee), providing reasonable assurance that the project will be located, designed, constructed, and operated so as to comply with applicable air and water quality standards.

(6) A statement whether any building, installation, structure, location, or site of operations to be utilized in the performance of the grant or any contract made pursuant to the grant appears on the list of violating facilities distributed by the Environmental Protection Agency under the provisions of the Clean Air Act and Federal Water Pollution Control Act (40 CFR part 15).

(7) The assurances on Civil Rights required by §21.7 of the Regulations of the Office of the Secretary of Transportation (49 CFR 21.7) and §152.405.

(8) Plans and specifications for the proposed development in accordance with the design and construction standards listed in appendix B to this part.

(9) The applicable assurances required by appendix D to this part.

(10) If cosponsors are not willing to assume, jointly and severally, the obligations imposed on them by this part and the grant agreement, a statement satisfactory to the Administrator indicating—

(i) The responsibilities of each sponsor with respect to the accomplishment of the proposed project and the operation and maintenance of the airport;

(ii) The obligations each will assume to the United States; and

(iii) The name of the sponsor or sponsors who will accept, receipt for, and disburse grant payments.

(g) *Additional documentation.* The Administrator may request additional documentation as needed to support specific items of development or to comply with other Federal and local requirements as they pertain to the requested development.

(Secs. 303, 307, 308, 312, and 313, Federal Aviation Act of 1958 (49 U.S.C. 1344, 1348, 1349, 1353, and 1354); sec. 6(c), Dept. of Transportation Act (49 U.S.C. 1655(c)); Airport and Airway Development Act of 1970, as amended (49 U.S.C. 1701 et seq.); sec. 1.47(f)(1), Regulations of the Office of the Secretary of Transportation (49 CFR 1.47(1)); OMB Circular A-95, Revised (41 FR 2052; Jan. 13, 1976))

[Doc. No. 19430, 45 FR 34784, May 22, 1980, as amended by Amdt. 152-11, 45 FR 56622, Aug. 25, 1980; 45 FR 58107, Sept. 2, 1980; Amdt. 152-13, 46 FR 30809, June 11, 1981]

**§ 152.113 Application requirements: Airport planning.**

(a) *Application for Federal assistance.* An eligible sponsor or planning agency that desires to obtain Federal aid for eligible airport master planning or airport system planning must submit an application for Federal assistance, on a form and in a manner prescribed by the Administrator, to the appropriate FAA Airports District Office or Airports Field Office having jurisdiction over the area where the sponsor or planning agency is located or, where there is no such office, the Regional Office having that jurisdiction.

(b) Unless otherwise authorized by the Administrator, the application required by paragraph (a) of this section must be accompanied by the following:

(1) Any comments or statements required by appendix E, Procedures Implementing Office of Management and Budget Circular A-95, to this part.

(2) Budget (project costs) information subdivided into the following functions, as appropriate, and the basis for computation of these costs:

- (i) Third party contracts.
- (ii) Sponsor force account costs.
- (iii) Administrative costs.

(3) A program narrative describing the proposed planning project including—

(i) The objective;

(ii) The results and benefits expected;

(iii) A Work Statement including—

(A) A detailed description of each work element;

(B) A list of each organization, consultant, and key individual who will work on the planning project, and the nature of the contribution of each; and

(C) A proposed schedule of work accomplishment; and

(iv) The geographic location of the airport or the boundaries of the planning area.

(4) If the sponsor proposes to accomplish the project with its own forces or those of another public or planning agency—

(i) An assurance that adequate, competent personnel are available to satisfactorily accomplish the proposed planning project, and

(ii) A description of the qualifications of the key personnel.

(5) If cosponsors are not willing to assume, jointly, and severally, the obligations imposed on them by this part and the grant agreement, a statement satisfactory to the Administrator indicating—

(i) The responsibilities of each sponsor with respect to the accomplishment of the proposed project;

(ii) The obligations each will assume to the United States; and

(iii) The name of the sponsor or sponsors who will accept, receipt for, and disburse grant payments.

(6) The assurances on Civil Rights required by §21.7 of the Regulations of the Office of the Secretary of Transportation (49 CFR 21.7).

(7) The applicable assurances required by appendix D of this part.

(c) *Additional documentation.* The Administrator may request additional documentation as needed to support a

## § 152.115

master plan or system plan, or to comply with other Federal and local requirements as they pertain to the requested plan.

(Secs. 303, 307, 308, 312, and 313, Federal Aviation Act of 1958 (49 U.S.C. 1344, 1348, 1349, 1353, and 1354); sec. 6(c), Dept. of Transportation Act (49 U.S.C. 1655(c)); Airport and Airway Development Act of 1970, as amended (49 U.S.C. 1701 et seq.); sec. 1.47(f)(1), Regulations of the Office of the Secretary of Transportation (49 CFR 1.47(1)); OMB Circular A-95, Revised (41 FR 2052; Jan. 13, 1976))

[Doc. No. 19430, 45 FR 34784, May 22, 1980, as amended by Amdt. 152-13, 46 FR 30809, June 11, 1981]

### § 152.115 Grant agreement: Offer, acceptance, and amendment.

(a) *Offer.* Upon approving a project for airport development, airport master planning, or airport system planning, the Administrator issues a written offer that sets forth the terms, limitations, and requirements of the proposed agreement.

(b) *Acceptance.* The acceptance of an offer or an amendment to a grant agreement must be in writing. The sponsor's or planning agency's attorney must certify that the acceptance complies with all applicable law, and constitutes a legal and binding obligation of the sponsor or planning agency.

(c) *Amendment: Airport development grants.* The maximum obligation of the United States under a grant agreement for an airport development project may be increased by an amendment if—

(1) Except as otherwise provided by the Uniform Relocation Assistance and Real Property Acquisition Policies Act of 1970, the maximum obligation of the United States is not increased by more than 10 percent;

(2) Funds are available for the increase;

(3) The sponsor shows that the increase is justified; and

(4) The change does not prejudice the interest of the United States.

(d) *Reduction of U.S. Share: Airport development grants.* When project work for which costs have been incurred is deleted from a grant agreement, the Administrator reduces the maximum obligation of the United States proportionately, based on the cost or value of the deleted work as shown on the project application.

## 14 CFR Ch. I (1-1-08 Edition)

(e) *Amendment: Airport planning.* A grant agreement for airport planning may be changed if—

(1) The change does not increase the maximum obligation of the United States under the grant agreement; and

(2) The change does not prejudice the interest of the United States.

### § 152.117 Public hearings.

(a) Before submitting a preapplication for Federal assistance for an airport development project involving the location of an airport, an airport runway, or a runway extension, the sponsor must give notice of opportunity for a public hearing, in accordance with paragraph (b) of this section, for the purpose of—

(1) Considering the economic, social, and environmental effects of the location of the airport, the airport runway, or the runway extension; and

(2) Determining the consistency of the location with the goals and objectives of any urban planning that has been carried out by the community.

(b) The notice of opportunity for public hearing must—

(1) Include a concise statement of the proposed development;

(2) Be published in a newspaper of general circulation in the communities in or near which the project may be located;

(3) Provide a minimum of 30 days from the date of the notice for submission of requests for a hearing by persons having an interest in the economic, social, or environmental effects of the project; and

(4) State that a copy is available of the sponsor's environmental assessment, if one is required by appendix 6 of FAA Order 1050.1C, "Policies and Procedures for Considering Environmental Impacts" (45 FR 2244; Jan. 10, 1980), and FAA Order 5050.4, "Airport Environmental Handbook" (45 FR 56624; Aug. 25, 1980), and will remain available, at the sponsor's place of business for examination by the public for a minimum of 30 days, beginning with the date of the notice, before any hearing held under the notice.

(c) A public hearing must be provided if requested. If a public hearing is to be held, the sponsor must publish a notice of that fact, in the same newspaper in

which the notice of opportunity for a hearing was published.

(d) The notice required by paragraph (c) of this section must—

(1) Be published not less than 15 days before the date set for the hearing;

(2) Specify the date, time, and place of the hearings;

(3) Contain a concise description of the proposed project; and

(4) Indicate where and at what time more detailed information may be obtained.

(e) If a public hearing is held, the sponsor must—

(1) Provide the Administrator a summary of the issues raised, the alternatives considered, the conclusion reached, and the reasons for that conclusion; and

(2) If requested by the Administrator before the hearing, prepare a verbatim transcript of the hearing for submission to the Administrator.

(f) If a hearing is not held the sponsor must submit with its preapplication a certification that notice of opportunity for a hearing has been provided in accordance with this section and that no request for a public hearing has been received.

[Doc. No. 19430, 45 FR 34784, May 22, 1980, as amended by Amdt. 152-11, 45 FR 56622, Aug. 25, 1980]

#### § 152.119 Contract requirements and procurement standards.

To the extent applicable, all grant agreements, contracts, and subcontracts involving airport development projects or airport planning must be in accordance with the contract requirements in appendices A and C, as applicable, and the procurement standards in Attachment O of Office of Management and Budget Circular A-102 (42 FR 45828).

### Subpart C—Funding of Approved Projects

SOURCE: Docket No. 19430, 45 FR 34789, May 22, 1980, unless otherwise noted.

#### § 152.201 Applicability.

This subpart contains the requirements for funding projects for airport development, airport master planning, and airport system planning.

#### § 152.203 Allowable project costs.

(a) *Airport development.* To be an allowable project cost, for the purposes of computing the amount of an airport development grant, an item that is paid or incurred must, in the opinion of the Administrator—

(1) Have been necessary to accomplish airport development in conformity with—

(i) The approved plans and specifications for an approved project; and

(ii) The terms of the grant agreement for the project;

(2) Be reasonable in amount (subject to partial disallowance to the extent the Administrator determines it is unreasonable);

(3) Have been incurred after the date the grant agreement was executed, except that project formulation costs may be allowed even though they were incurred before that date;

(4) Be supported by satisfactory evidence;

(5) Have not been included in an airport planning grant; and

(6) Be a cost determined in accordance with the cost principles for State and local governments in Federal Management Circular 74-4 (39 FR 27133; 43 FR 50977).

(b) *Airport Planning.* To be an allowable project cost, for the purposes of computing the amount of an airport planning grant, an item that is paid or incurred must, in the opinion of the Administrator—

(1) Have been necessary to accomplish airport planning in conformity with an approved project and the terms of the grant agreement for the project;

(2) Be reasonable in amount;

(3) Have been incurred after the date the grant agreement was entered into, except for substantiated and reasonable costs incurred in designing the study effort;

(4) Be supported by satisfactory evidence; and

(5) Be figured in accordance with Federal Management Circular 74-4 (39 FR 27133; 43 FR 50977).

#### § 152.205 United States share of project costs.

(a) *Airport development.* Except as provided in paragraphs (b) and (c) of this section, the following is the United

## § 152.207

States share of the allowable cost of an airport development project approved for the specified year:

(1) 90 percent in the case of grants made from funds for fiscal years 1976, 1977, and 1978, and grants from funds for fiscal year 1980 made after February 17, 1980, for—

(i) Each air carrier airport, other than a commuter service airport, which enplanes less than one quarter of one percent of the total annual passengers enplaned as determined for purposes of making the latest annual apportionment under section 15(a)(3) of the AADA;

(ii) Each commuter service airport; and

(iii) Each general aviation or reliever airport.

(2) 80 percent in the case of grants made from funds for fiscal year 1979 and grants from funds for fiscal year 1980 made before February 18, 1980, for the airports specified in paragraph (a)(1) of this section.

(3) 75 percent in the case of grants made from funds for fiscal years 1976 through 1980 for airports other than those specified in paragraph (a)(1) of this section.

(b) In a State in which the unappropriated and unreserved public lands and nontaxable Indian lands, both individual and tribal, are more than five percent of the total land in that State, the United States' share under paragraph (a) of this section—

(1) Except as provided in paragraph (b)(2) of this section, shall be increased by the smaller of—

(i) 25 percent; or

(ii) A percentage (rounded to the nearest one-tenth of a percent) equal to one-half of the percentage which the area of those lands is of the total land area of the state; and

(2) May not exceed the greater of—

(i) The percentage share determined under paragraph (a) of this section; or

(ii) The percentage share applying on June 30, 1975, as determined under paragraph (b)(1) of this section.

(c) In the case of terminal development, the United States share shall be 50 percent.

(d) *Airport planning.* The United States share of the allowable project

## 14 CFR Ch. I (1-1-08 Edition)

costs of an airport planning project shall be—

(1) In the case of an airport master plan, that percent for which a project for airport development at that airport would be eligible;

(2) In the case of an airport system plan, 75 percent.

### § 152.207 Proceeds from disposition of land.

Unless otherwise authorized by the Administrator, when a release has been granted authorizing the sponsor to dispose of land acquired with assistance under part 151 of this chapter or this part, or through conveyances under the Surplus Property Act, the proceeds realized from the disposal may not be used as matching funds for any airport development project or airport planning grant, but may be used for any other airport purpose.

### § 152.209 Grant payments: General.

(a) An application for a grant payment is made on a form and in a manner prescribed by the Administrator, and must be accompanied by any supporting information, that the FAA needs to determine the allowability of any costs for which payment is requested.

(b) *Methods of payment.* Grant payments to sponsors and planning agencies will be made by—

(1) Letter of credit;

(2) Advance by Treasury check; or

(3) Reimbursement by Treasury checks.

(c) *Letter of credit funding.* Letter of credit funding may not be used unless—

(1) There is or will be a continuing relationship between a sponsor or planning agency and the FAA for at least a 12-month period and the total amount of advances to be received within that period is \$120,000 or more;

(2) The sponsor or planning agency has established or demonstrated to the FAA the willingness and ability to establish procedures that will minimize the time elapsing between the transfer of funds and their disbursement by the grantee; and

(3) The sponsor's or planning agency's financial management system meets the standards for fund control

and accountability prescribed in Attachment G of Office of Management and Budget Circular A-102 (42 FR 45828).

(d) *Advance by Treasury check.* Advance of funds by Treasury check may be made subject to the following conditions—

(1) The sponsor or planning agency meets the requirements of paragraphs (c) (2) and (3) of this section;

(2) The timing and amount of cash advances are as close as administratively feasible to actual disbursements by the sponsor or planning agency; and

(3) Except as provided in paragraph (e) of this section, in the case of an airport development project, advance payments do not exceed the estimated project costs of the airport development expected to be accomplished within 30 days after the date of the sponsor's application for the advance payment.

(e) No advance payment for airport development projects may be made in an amount that would bring the aggregate amount of all partial payments to more than the lower of the following:

(i) 90 percent of the estimated United States' share of the total estimated cost of all airport development included in the project, but not including contingency items; or

(ii) 90 percent of the maximum obligation of the United States as stated in the grant agreement.

(f) *Reimbursement by Treasury check.* Reimbursement by Treasury check will be made if the sponsor or planning agency does not meet the requirements of paragraphs (c) (2) and (3) of this section.

(g) *Withholding of payments.* Payment to the sponsor or planning agency may be withheld at any time during the grant period under the following circumstances:

(1) The sponsor or planning agency has failed to comply with the program objectives, grant award conditions, or Federal reporting requirements.

(2) The sponsor or planning agency is indebted to the United States and collection of the indebtedness will not impair accomplishment of the objectives of any grant program sponsored by the United States.

(3) The sponsor or planning agency has withheld payment to a contractor to assure satisfactory completion of work. Payment will be made to the sponsor or planning agency when it has made final payment to the contractor, including the amounts withheld.

(h) *Labor violations.* If a contractor or a subcontractor fails or refuses to comply with the labor provisions of a contract under a grant agreement for an airport development project, further grant payments to the sponsor are suspended until—

(1) The violations are corrected;

(2) The Administrator determines the allowability of the project costs to which the violations relate; or

(3) If the violations consist of underpayments to labor, the sponsor furnishes satisfactory assurances to the FAA that restitution has been or will be made to the affected employees.

(i) *Excess payments.* Upon determination of the allowability of all project costs of a project, if it is found that the total of grant payments to the sponsor or planning agency was more than the total United States share of the allowable costs of the project, the sponsor or planning agency shall promptly return the excess to FAA.

#### § 152.211 Grant payments: Land acquisition.

If an approved project for airport development includes land acquisition as an item for which payment is requested, the sponsor may apply to the FAA for payment of the United States share of the allowable project costs of the acquisition, after—

(a) The Administrator determines that the sponsor has acquired satisfactory title to the land; or

(b) In the case of a request for advance payment under § 152.209(d), the Administrator is assured that a satisfactory title will be acquired.

#### § 152.213 Grant closeout requirements.

(a) *Program income.* Sponsors or planning agencies that are units of local government shall return all interest earned on advances of grant-in-aid funds to the Federal Government in accordance with a decision of the Comptroller General (42 Comp. Gen. 289). All other program income (gross income)

## § 152.301

earned by grant-supported activities during the grant period shall be retained by the sponsor and, if required by the grant agreement—

(1) Be added to funds committed to the project by the FAA and the sponsor and used to further eligible program objectives; or

(2) Be deducted from the total project cost for the purpose of determining the net costs on which the Federal share of costs will be based.

(b) *Financial reports.* The sponsor or planning agency shall furnish, within 90 days after completion of all items in a grant, all reports, including financial performance reports, required as a condition of the grant.

(c) *Project completion.* When the project for airport development or planning is completed in accordance with the grant agreement, the sponsor or planning agency may apply for payment for all incurred costs, as follows:

(1) *Airport development.* When allowability of costs can be determined under §152.203, payment may be made to the sponsor if—

(i) A final inspection of all work at the airport site has been made jointly by the appropriate FAA office and representatives of the sponsor and the contractor, unless that office agrees to a different procedure for final inspection; and

(ii) The sponsor has furnished final “as constructed” plans, unless otherwise agreed to by the Administrator.

(2) *Airport planning.* When the final planning report has been received and accepted by the FAA.

(d) *Property accounting reports: Airport development projects.* The sponsor of an airport development project shall account for any property acquired with grant funds or received from the United States, in accordance with the provisions of Attachment N of Office of Management and Budget Circular A-102 (42 FR 45828).

(e) *Final determination of U.S. share.* Based upon an audit or other information considered sufficient in lieu of an audit, the Administrator determines the total amount of the allowable project costs and makes settlement for any adjustments to the Federal share of costs.

## 14 CFR Ch. I (1-1-08 Edition)

### Subpart D—Accounting and Reporting Requirements

SOURCE: Docket No. 19430, 45 FR 34791, May 22, 1980, unless otherwise noted.

#### § 152.301 Applicability.

This subpart contains accounting and reporting requirements applicable to—

(a) Each sponsor of a project for airport development;

(b) Each sponsor of a project for airport master planning; and

(c) Each planning agency conducting a project for airport system planning.

#### § 152.303 Financial management system.

Each sponsor or planning agency shall establish and maintain a financial management system that meets the standards of Attachment G of Office of Management and Budget Circular A-102 (42 FR 45828).

#### § 152.305 Accounting records.

(a) *Airport development.* Each sponsor of a project for airport development shall establish and maintain, for each individual project, an accounting record satisfactory to the Administrator which segregates cost information into the cost classifications set forth in Standard Form 271 (42 FR 45841).

(b) *Airport planning.* Each sponsor of a project for airport master planning and each planning agency conducting a project for airport system planning shall establish and maintain, for each planning project, an adequate accounting record that segregates and groups direct and indirect cost information in the following classifications:

(1) Third party contract costs.

(2) Force account costs.

(3) Administrative costs.

#### § 152.307 Retention of records.

Each sponsor or planning agency shall retain, for a period of 3 years after the date of submission of the final expenditure report—

(a) Documentary evidence, such as invoices, cost estimates, and payrolls, supporting each item of project costs; and

## Federal Aviation Administration, DOT

## § 152.319

(b) Evidence of all payments for items of project costs, including vouchers, cancelled checks or warrants, and receipts for cash payments.

### § 152.309 Availability of sponsor's records.

(a) The sponsor or planning agency shall allow any authorized representative of the Administrator, the Secretary of Transportation, or the Comptroller General of the United States access to any of its books, documents, papers, and records that are pertinent to grants received under this part for the purposes of accounting and audit.

(b) The sponsor or planning agency shall allow appropriate FAA or DOT representatives to make progress audits at any time during the project, upon reasonable notice to the sponsor or planning agency.

(c) If audit findings have not been resolved, the applicable records shall be retained by the sponsor or planning agency until those findings have been resolved.

(d) Records for nonexpendable property that was acquired with Federal funds shall be retained for three years after final disposition of the property.

(e) Microfilm copies of original records may be substituted for original records with the approval of the FAA.

(f) If the FAA determines that certain records have long-term retention value, the FAA may require transfer of custody of those records to the FAA.

### § 152.311 Availability of contractor's records.

The sponsor or planning agency shall include in each contract of the cost reimbursable type a clause that allows any authorized representative of the Administrator, the Secretary of Transportation, or the Comptroller General of the United States access to the contractor's records pertinent to the contract for the purposes of accounting and audit.

### § 152.313 Property management standards.

(a) The sponsor shall establish and maintain property management standards in accordance with Attachment N of Office of Management and Budget Circular A-102 (42 FR 45828) for the uti-

lization and disposition of property furnished by the Federal Government, or acquired in whole or in part by the sponsor with Federal funds.

(b) A sponsor may use its own property management standards and procedures as long as the standards required by paragraph (a) of this section are included.

### § 152.315 Reporting on accrual basis.

(a) Except as provided in paragraph (b) of this section each sponsor or planning agency shall submit all financial reports on an accrual basis.

(b) If records are not maintained on an accrual basis by a sponsor or planning agency, reports may be based on an analysis of records or best estimates.

### § 152.317 Report of Federal cash transactions.

When funds are advanced to a sponsor or planning agency by Treasury check, the sponsor or planning agency shall submit the report form prescribed by the Administrator within 15 working days following the end of the quarter in which check was received.

### § 152.319 Monitoring and reporting of program performance.

(a) The sponsor or planning agency shall monitor performance under the project to ensure that—

- (1) Time schedules are being met;
- (2) Work units projected by time periods are being accomplished; and,
- (3) Other performance goals are being achieved.

(b) Reviews shall be made for—

- (1) Each item of development or work element included in the project; and
- (2) All other work to be performed as a condition of the grant agreement.

(c) *Airport development.* Unless otherwise requested by the Administrator, the sponsor of a project for airport development shall submit a performance report, on an annual basis, that must include—

- (1) A comparison of actual accomplishments to the goals established for the period, made, if applicable, on a quantitative basis related to cost data for computation of unit costs;

## § 152.321

(2) The reasons for slippage in each case where an established goal was not met; and

(3) Other pertinent information including, when appropriate, an analysis and explanation of each cost overrun and high unit cost.

(d) *Airport planning.* The sponsor of a project for airport master planning or a planning agency conducting a project for airport system planning shall submit a performance report, on a quarterly basis, that must include:

(1) A comparison of actual accomplishments to the goals established for the period, made, if applicable, on a quantitative basis related to costs for computation of work element costs;

(2) Reasons for slippage in each case where an established goal was not met; and

(3) Other pertinent information including, when appropriate, an analysis and explanation of each cost overrun and high work element cost.

## § 152.321 Notice of delay or acceleration.

(a) The sponsor or planning agency shall promptly notify the FAA of each condition or event that may delay or accelerate accomplishment of the project.

(b) In the event that delay is anticipated, the notice required by paragraph (a) of this section must include—

(1) A statement of actions taken or contemplated; and

(2) Any Federal assistance needed.

## § 152.323 Budget revision: Airport development.

(a) If any performance review conducted by the sponsor discloses a need for change in the budget estimates, the sponsor shall submit a request for budget revision on a form prescribed by the Administrator.

(b) A request for prior approval for budget revision shall be made promptly by the sponsor whenever—

(1) The revision results from changes in the scope or objective of the project; or

(2) The revision increases the budgeted amounts of Federal funds needed to complete the project.

(c) The sponsor shall promptly notify the FAA whenever the amount of the

## 14 CFR Ch. I (1–1–08 Edition)

grant is expected to exceed the needs of the sponsor by more than \$5,000, or 5 percent of the grant amount, whichever is greater.

## § 152.325 Financial status report: Airport planning.

Each sponsor of a project for airport master planning and each planning agency conducting a project for airport system planning shall submit a financial status report on a form prescribed by the Administrator at the completion of the project.

## Subpart E—Nondiscrimination in Airport Aid Program

**AUTHORITY:** Sec. 30 of the Airport and Airway Development Act of 1970 (49 U.S.C. 1730); sec. 1.47(f)(1) of the Regulations of the Office of the Secretary of Transportation (49 CFR 1.47(f)(1)).

**SOURCE:** Docket No. 16419, 45 FR 10188, Feb. 14, 1980, unless otherwise noted.

## § 152.401 Applicability.

(a) This subpart is applicable to all grantees and other covered organizations under this part, and implements the requirements of section 30 of the Airport and Airway Development Act of 1970, which provides:

The Secretary shall take affirmative action to assure that no person shall, on the grounds of race, creed, color, national origin, or sex, be excluded from participating in any activity conducted with funds received from any grant made under this title. The Secretary shall promulgate such rules as he deems necessary to carry out the purposes of this section and may enforce this section, and any rules promulgated under this section, through agency and department provisions and rules which shall be similar to those established and in effect under Title VI of the Civil Rights Act of 1964. The provisions of this section shall be considered to be in addition to and not in lieu of the provisions of Title VI of the Civil Rights Act of 1964.

(b) Each grantee, covered organization, or covered suborganization under this part shall negotiate reformation of any contract, subcontract, lease, sublease, or other agreement to include any appropriate provision necessary to

effect compliance with this subpart by July 17, 1980.

**§ 152.403 Definitions.**

As used in this subpart—

*AADA* means the Airport and Airway Development Act of 1970, as amended (49 U.S.C. 1701 *et seq.*).

*Affirmative action plan* means a set of specific and result-oriented procedures to which a sponsor, planning agency, state, or the aviation related activity on an airport commits itself to achieve equal employment opportunity.

*Airport development* means—(1) Any work involved in constructing, improving, or repairing a public airport or portion thereof, including the removal, lowering, relocation, and marking and lighting of airport hazards, and including navigation aids used by aircraft landing at, or taking off from, a public airport, and including safety equipment required by rule or regulation for certification of the airport under section 612 of the Federal Aviation Act of 1958, and security equipment required of the sponsor by the Secretary by rule or regulation for the safety and security of persons and property on the airport, and including snow removal equipment, and including the purchase of noise suppressing equipment, the construction of physical barriers, and landscaping for the purpose of diminishing the effect of aircraft noise on any area adjacent to a public airport;

(2) Any acquisition of land or of any interest therein, or of any easement through or other interest in airspace, including land for future airport development, which is necessary to permit any such work or to remove or mitigate or prevent or limit the establishment of, airport hazards; and

(3) Any acquisition of land or of any interest therein necessary to insure that such land is used only for purposes which are compatible with the noise levels of the operation of a public airport.

*Aviation related activity* means a commercial enterprise—(1) Which is operated on the airport pursuant to an agreement with the grantee or airport operator or to a derivative subagreement;

(2) Which employs persons on the airport; and

(3) Which—(i) Is related primarily to the aeronautical activities on the airport;

(ii) Provides goods or services to the public which is attracted to the airport by aeronautical activities;

(iii) Provides services or supplies to other aeronautical related or public service airport businesses or to the airport; or

(iv) Performs construction work on the airport.

*Aviation workforce* includes, with respect to grantees, each person employed by the grantee on an airport or, for an aviation purpose, off the airport.

*Covered organization* means a grantee, a subgrantee, or an aviation related activity.

*Covered suborganization* is a subgrantee or sub-aviation related activity, of a covered organization.

*Department* means the United States Department of Transportation;

*Grant* means Federal financial assistance in the form of funds provided to a sponsor, planning agency, or state under this part;

*Grantee* means the recipient of a grant.

*Minority* means a person who is—(1) Black and not of Hispanic origin: A person having origins in any of the black racial groups of Africa;

(2) Hispanic: A person of Mexican, Puerto Rican, Cuban, Central or South American or other Spanish culture or origin, regardless of race;

(3) Asian or Pacific Islander: A person having origins in any of the original peoples of the Far East, Southeast Asia, the Indian subcontinent, or the Pacific Islands, including, but not limited to China, Japan, Korea, the Philippine Islands, and Samoa; or

(4) American Indian or Alaskan Native: A person having origins in any of the original peoples of North America who maintains cultural identification through tribal affiliation or community recognition.

*Planning agency* means any planning agency designated by the Secretary which is authorized by the laws of the State or States (including the Commonwealth of Puerto Rico, the Virgin Islands, American Samoa, the Trust Territory of the Pacific Islands, and

**§ 152.405**

**14 CFR Ch. I (1–1–08 Edition)**

Guam) or political subdivisions concerned to engage in areawide planning for the area in which assistance under this part is to be used;

*Secretary* means the Secretary of Transportation or an authorized representative of the Secretary within the Department of Transportation;

*SMSA* means Standard Metropolitan Statistical Area.

*Sponsor* means any public agency that, either individually or jointly with one or more other public agencies, submits to the Administrator, in accordance with this part, an application for financial assistance, or that conducts a project for airport development or airport master planning, funded under this part;

*Underutilization* means having fewer minorities or women in a particular job group than would reasonable be expected from their availability in—

(1) The SMSA; or

(2) In the absence of a defined SMSA, in the counties contiguous to the employer's location, or the location where the work is to be performed, and in the areas from which persons may reasonably be expected to commute.

**§ 152.405 Assurances.**

The following assurances shall be included in each application for financial assistance under this part:

(a) *Assurance.* The grantee assures that it will undertake an affirmative action program, as required by 14 CFR part 152, subpart E, to ensure that no person shall, on the grounds of race, creed, color, national origin, or sex, be excluded from participating in any employment, contracting, or leasing activities covered in 14 CFR part 152, subpart E. The grantee assures that no person shall be excluded, on these grounds, from participating in or receiving the services or benefits of any program or activity covered by this subpart. The grantee assures that it will require that its covered organizations provide assurances to the grantee that they similarly will undertake affirmative action programs and that they will require assurances from their suborganizations, as required by 14 CFR part 152, subpart E, to the same effect.

(b) *Assurance.* The grantee agrees to comply with any affirmative action plan or steps for equal employment opportunity required by 14 CFR part 152, subpart E, as part of the affirmative action program, and by any Federal, State, or local agency or court, including those resulting from a conciliation agreement, a consent decree, court order, or similar mechanism. The grantee agrees that State or local affirmative action plans will be used in lieu of any affirmative action plan or steps required by 14 CFR part 152, subpart E, only when they fully meet the standards set forth in 14 CFR 152.409. The grantee agrees to obtain a similar assurance from its covered organizations, and to cause them to require a similar assurance of their covered suborganizations, as required by 14 CFR part 152, subpart E.

**§ 152.407 Affirmative action plan: General.**

(a) Except as provided in paragraph (b) of this section, each of the following shall have an affirmative action plan that meets the requirements of § 152.409 and is kept on file for review by the FAA Office of Civil Rights:

(1) Each sponsor who employs 50 or more employees in its aviation workforce.

(2) Each planning Agency which employs 50 or more employees in its agency for aviation purposes.

(3) Each state political division, administering a grant under the AADA to develop standards for airport development at general aviation airports, which employs 50 or more employees in its aviation workforce.

(b) A grantee is in compliance with paragraph (a) of this section, if it is subject to, and keeps on file for review by the FAA Office of Civil Rights, one of the following:

(1) An affirmative action plan acceptable to another Federal agency.

(2) An affirmative action plan for a State or local agency that the covered organization certifies meets the standards in § 152.409.

(3) A conciliation agreement, consent decree, or court order which provides short and long-range goals for equal employment opportunity similar to those which would be established in an

affirmative action plan meeting the standards in §152.409.

(c) Each sponsor shall require each aviation related activity (other than construction contractors) which employs 50 or more employees on the airport to prepare, and keep on file for review by the FAA Office of Civil Rights, an affirmative action plan developed in accordance with the standards in §152.409, unless the activity is subject to one of the mechanisms described in paragraphs (b) (1) through (3) of this section.

(d) Each sponsor shall require each aviation related activity described in paragraph (c) of this section to similarly require each of its covered suborganizations (other than construction contractors) which employs 50 or more employees on the airport to prepare, and to keep on file for review by the FAA Office of Civil Rights, an affirmative action plan developed in accordance with the standards in §152.409, unless the suborganization is subject to one of the mechanisms described in paragraphs (b) (1) through (3) of this section.

**§ 152.409 Affirmative action plan standards.**

(a) Each affirmative action plan required by this subpart shall be developed in accordance with the following:

(1) An analysis of the employer's aviation workforce which groups employees into the following job categories:

- (i) Officials and managers.
- (ii) Professionals.
- (iii) Technicians.
- (iv) Sales workers.
- (v) Office and clerical workers.
- (vi) Craft workers (skilled).
- (vii) Operatives (semi-skilled).
- (viii) Laborers (unskilled).
- (ix) Service workers.

(2) A comparison separately made of the percent of minorities and women in the employer's present aviation workforce (in each of the job categories listed in paragraph (a)(1) of this section) with the percent of minorities and women in each of those categories in the total workforce located in the SMSA, or, in the absence of an SMSA, in the counties contiguous to the employer's location or the location where

the work is to be performed and in the areas from which persons may reasonably be expected to commute. This data on the total workforce of the applicable area will be supplied to grantees by the FAA. Grantees shall make this data available to the other organizations covered by this subpart. The comparison for minorities must be made only when minorities constitute at least 2 percent of the total workforce in the geographical area used for the comparison.

(3) A comparison, for the aviation workforce, of the total number of applicants and persons hired with the total number of minority and female applicants, and minorities and females hired, for the past year. Where this data is unavailable, the employer shall establish and maintain a system to provide the data, and shall make the comparison 120 days after establishing the data system.

(4) Where the percentage of minorities and women in the employer's aviation workforce, in each job category, is less than the minority and female percentage in any job category in the workforce of the geographical area used, an analysis, based on the comparison required by paragraph (a)(3) of this section, determining whether any of the following exists:

(i) Insufficient flow of minority and female applicants.

(ii) Disparate rejection of minority and female applicants. The FAA generally considers disparate rejection to exist whenever a selection rate for any race, sex, or ethnic group is less than 80 percent of the rate for the race, sex, or ethnic group with the highest selection rate.

(b) Each affirmative action plan required by this part shall be implemented through an action-oriented program with goals and timetables designed to eliminate obstacles to equal opportunity for women and minorities in recruitment and hiring, which shall include, but not be limited to:

(1) Where disparate rejection of minority and female applicants is indicated by the analysis required by paragraph (a)(4) of this section, validation

**§ 152.411**

**14 CFR Ch. I (1-1-08 Edition)**

of those portions of the testing or selection procedures which cause the disparity in accordance with the "Uniform Guidelines on Employee Selection" (43 FR 38290; August 25, 1978), within 120 days of the analysis.

(2) Where testing or selection procedures cannot be validated, discontinuation of their use.

(3) Where an insufficient flow of minority and female applicants (less than the percentage available) is indicated by the analysis required by paragraph (a)(4) of this section, good faith efforts to increase the flow of minority and female applicants through the following steps, as appropriate:

(i) Development or reaffirmation of an equal opportunity policy and dissemination of that policy internally and externally.

(ii) Contact with minority and women's organizations, schools with predominant minority or female enrollments, and other recruitment sources for minorities and women.

(iii) Encouragement of State and local employment agencies, unions, and other recruiting sources to ensure that minorities and women have ample information on, and opportunity to apply for, vacancies and to participate in examinations.

(iv) Participation in special employment programs such as Co-operative Education Programs with predominantly minority and women's colleges, "After School" or Work Study programs, and Summer Employment.

(v) Participation in "Job Fairs."

(vi) Participation of minority and female employees in Career Days, Youth Motivation Programs, and counseling and related activities in the community.

(vii) Encouragement of minority and female employees to refer applicants.

(viii) Motivation, training, and employment programs for minority and female hard-core unemployed.

**§ 152.411 Affirmative action steps.**

(a) Each grantee which is not described in § 152.407(a) and is not subject to an affirmative action plan, regulatory goals and timetables, or other mechanism providing for short and long-range goals for equal employment opportunity, shall make good faith ef-

forts to recruit and hire minorities and women for its aviation workforce as vacancies occur, by taking the affirmative action steps in § 152.409(b)(3), as follows:

(1) If it has 15 or more employees in its aviation workforce or employed for aviation purposes, by taking the affirmative action steps in § 152.409(b)(3), as appropriate; or

(2) If it has less than 15 employees in its aviation workforce or employed for aviation purposes, by taking the affirmative action steps in § 152.409(b)(3) (i) and (ii), as appropriate.

(b) Except as provided in paragraph (c) of this section, each sponsor shall require each of its aviation related activities on its airport, that is not subject to an affirmative action plan, regulatory goals and timetables, or other mechanism which provides short and long-range goals for equal employment opportunity, to take affirmative action steps and cause them to similarly require affirmative action steps of their covered suborganizations, as follows:

(1) Each aviation related activity or covered suborganization with less than 50 but more than 14 employees, must take the affirmative action steps enumerated in § 152.409(b)(3), as appropriate.

(2) Each aviation related activity or covered suborganization with less than 15 employees, must take the affirmative action steps enumerated in § 152.409(b)(3) (i) and (ii), as appropriate.

(c) Each sponsor shall require each construction contractor, that has a contract of \$10,000 or more on its airport and that is not subject to an affirmative action plan, regulatory goals or timetables, or other mechanism which provides short and long-range goals for equal employment opportunity, to take the following affirmative action steps:

(1) The contractor must establish and maintain a current list of minority and female recruitment sources; provide written notification to these recruitment sources and to community organizations when employment opportunities are available; and maintain a record of each organization's response.

(2) The contractor must maintain a current file of the names, addresses,

and telephone numbers of each minority and female walk-in applicant and each referral from a union, a recruitment source, or community organization and the action taken with respect to each individual. Where an individual is sent to the union hiring hall for referral, but not referred back to the contractor, or, if referred, not employed by the contractor, this shall be documented. The documentation shall include an explanation of, and information on, any additional actions that the contractor may have taken.

(3) The contractor must disseminate its equal employment opportunity policy internally—

(i) By providing notice of the policy to unions and training programs;

(ii) By including it in policy manuals and collective bargaining agreements;

(iii) By publicizing it in the company newspaper, report, or other publication; and

(iv) By specific review of the policy with all management personnel and with all employees at least once a year.

(4) The contractor must disseminate the contractor's equal employment opportunity policy externally—

(i) By stating it in each employment advertisement in the news media, including news media with high minority and female readership; and

(ii) By providing written notification to, or participating in discussions with, other contractors and subcontractors with whom the contractor does business.

(5) The contractor must direct its recruitment efforts to minority and female organizations, to schools with minority and female students, and to organizations which recruit and train minorities and women, in the contractor's recruitment area.

(6) The contractor must encourage present minority and female employees to recruit other minorities and women.

(7) The contractor must, where possible, provide after school, summer, and vacation employment to minority and female youth.

(d) Each sponsor shall require each of its prime construction contractors on its airport, with a contract of \$10,000 or more, to require each of the contractor's subcontractors on the airport to comply with the affirmative action

steps in paragraph (c) of this section, with which it does not already comply, unless the subcontractor is subject to an affirmative action plan, regulatory goals or timetables, or other mechanism which provides short and long-range goals for equal employment opportunity, or the subcontract is less than \$10,000.

#### § 152.413 Notice requirement.

Each grantee shall give adequate notice to employees and applicants for employment, through posters provided by the Secretary, that the FAA is committed to the requirements of section 30 of the AADA, to ensure that no person shall, on the grounds of race, creed, color, national origin, or sex, be excluded from participating in any activity conducted with funds authorized under this part.

#### § 152.415 Records and reports.

(a) Each grantee shall keep on file for a period of three years or for the period during which the Federal financial assistance is made available, whichever is longer, reports (other than those transmitted to the FAA), records, and affirmative action plans, if applicable, that will enable the FAA Office of Civil Rights to ascertain if there has been and is compliance with this subpart.

(b) Each sponsor shall require its covered organizations to keep on file, for the period set forth in paragraph (a) of this section, reports (other than those submitted to the FAA), records, and affirmative action plans, if applicable, that will enable the FAA Office of Civil Rights to ascertain if there has been and is compliance with this subpart, and shall cause them to require their covered suborganizations to keep similar records as applicable.

(c) Each grantee, employing 15 or more person, shall annually submit to the FAA a compliance report on a form provided by the FAA and a statistical report on a Form EEO-1 of the Equal Employment Opportunity Commission (EEOC) or any superseding EEOC form. If a grantee already is submitting a Form EEO-1 to another agency, the grantee may submit a copy of that form to the FAA as its statistical report. The information provided shall

## § 152.417

include goals and timetables, if established in compliance with the requirements of §152.409 or with the requirements of another Federal agency or a State or local agency.

(d) Each sponsor shall—

(1) Require each of its aviation-related activities (except construction contractors), employing 15 or more persons, to annually submit to the sponsor the reports required by paragraph (c) of this section, on the same basis as stated in paragraph (c) of this section, and shall cause each aviation-related activity to require its covered sub-organizations, with 15 or more employees, to annually submit the reports required by paragraph (c) of this section through the prime organization to the sponsor, for transmittal by the sponsor to the FAA.

(2) Annually collect from its aviation related activities employing less than 15 employees, and transmit to the FAA an aggregate employment report, that includes the employment of sponsors with less than 15 employees, on an EEO-1 or any superseding EEOC form.

(e) Each sponsor shall require each of its construction contractors on its airport, with a contract of \$10,000 or more, which is not subject to E.O. 11246 and the regulations of the Department of Labor (DOL), to submit to the sponsor, at the conclusion of the project, a compliance report on a form provided by the FAA and a statistical report on a DOL Form 257 or any superseding DOL form. For projects exceeding six months, the sponsor shall require a midway compliance report. The sponsor shall submit these reports to the FAA.

(f) Each sponsor shall cause each of its construction contractors on its airport to require each of the contractor's subcontractors, with a subcontract of \$10,000 or more, which are not subject to E.O. 11246 and the regulations of the DOL, to submit the reports required by paragraph (e) of this section to the prime contractor for submission to the sponsor. The sponsor shall transmit these reports to the FAA.

(g) Each organization required to prepare an affirmative action plan for the FAA under this subpart shall update it annually and as changed circumstances require. Each organization that has

## 14 CFR Ch. I (1-1-08 Edition)

prepared a plan in compliance with the requirements of another Federal agency or a State or local agency, shall update it in accordance with the requirements of that agency.

### § 152.417 Monitoring employment.

(a) Each grantee shall allow the FAA Office of Civil Rights to monitor its equal employment opportunity compliance with this subpart through on-site reviews and desk audits. Reviews or audits will include the records submitted under §152.415.

(b) As it deems necessary, the FAA Office of Civil Rights will conduct on-site or desk audits of covered aviation related activities on airports.

### § 152.419 Minority business.

Each person subject to this subpart is required to comply with the Minority Business Enterprise Regulations of the Department.

### § 152.421 Public accommodations, services, and benefits.

Requirements relating to the provision of public accommodations, services, and other benefits to beneficiaries under Title VI of the Civil Rights Act of 1964 (42 U.S.C. 2000d *et seq.*) and part 21 of the regulations of the Office of the Secretary of Transportation (49 CFR part 21) implementing Title VI are made applicable, where appropriate, to nondiscrimination and affirmative action on the basis of sex or creed, and shall be complied with by each applicant for assistance and each grantee.

### § 152.423 Investigation and enforcement.

(a) *Complaints.* Any person who believes that he or she has been subjected to discrimination prohibited by this subpart may personally, or through a representative, file a complaint with the Director of the Departmental Office of Civil Rights. A complaint must be in writing and filed not later than 180 days after the date of the alleged discrimination, unless the time for filing is extended by the Director.

(b) *Investigations and informal resolutions.* The Departmental Office of Civil Rights will make a prompt investigation whenever a complaint, compliance

review, report, or any other information indicates a possible failure to comply with this subpart. The procedures in 49 CFR part 21, augmented as appropriate by the investigative procedures of part 13 of this chapter, will be followed, except that—

(1) Compliance with a regulation of the Department applicable to minority business enterprise will be investigated and enforced through the procedures contained in that regulation; and

(2) Except as provided in paragraph (c) of this section, allegations of non-compliance with regulations governing equal employment opportunity of another Federal agency or a State or local agency, will be referred, for investigation and enforcement, to the Federal agency or, in the discretion of the Departmental Office of Civil Rights, to the State or local agency.

(c) When the FAA (under section 30 of the AADA) and another Federal agency, a referral agency recognized by the Equal Employment Opportunity Commission, or a court have concurrent jurisdiction over a matter—

(1) If the other agency or court makes a finding on the record that noncompliance or discrimination has occurred, the FAA will accept the finding, and determine what sanctions or remedies are appropriate under section 30 as a result of the finding, after permitting the party against whom the finding was made to be heard on the determination of the sanctions or remedies; or

(2) If it appears that delay, through referral to another agency, will result in the continued expenditure of Federal funds under this part without compliance with this subpart, the Secretary may—

(i) Investigate the matter;

(ii) Make a determination as to compliance with section 30; and

(iii) Impose appropriate sanctions and remedies.

(d) Nothing in this section shall preclude the Director of the Departmental Office of Civil Rights from initiating an investigation when it appears that the investigation of the complaint may reveal a pattern or practice of discrimination or noncompliance with the requirements of this subpart in the em-

ployment practices of a grantee or other covered organization.

#### § 152.425 Effect of subpart.

Nothing contained in this subpart diminishes or supersedes the obligations imposed by Title VI of the Civil Rights Act of 1964 (42 U.S.C. 2000d), Executive Order 11246 (42 U.S.C. 2000e (note)), or any other Federal law or Executive Order relating to civil rights.

### Subpart F—Suspension and Termination of Grants

SOURCE: Docket No. 19430, 45 FR 34792, May 22, 1980, unless otherwise noted.

#### § 152.501 Applicability.

This subpart contains procedures for suspending or terminating grants for airport development projects and airport planning.

#### § 152.503 Suspension of grant.

(a) If the sponsor or planning agency fails to comply with the conditions of the grant, the FAA may, by written notice to the sponsor or planning agency, suspend the grant and withhold further payments pending—

(1) Corrective action by the sponsor or planning agency; or

(2) A decision to terminate the grant.

(b) Except as provided in paragraph (c), after receipt of notice of suspension, the sponsor or planning agency may not incur additional obligations of grant funds during the suspension.

(c) All necessary and proper costs that the sponsor or planning agency could not reasonably avoid during the period of suspension will be allowed, if those costs are in accordance with appendix C of this part.

#### § 152.505 Termination for cause.

(a) If the sponsor or planning agency fails to comply with the conditions of the grant, the FAA may, by written notice to the sponsor or planning agency, terminate the grant in whole, or in part.

(b) The notice of termination will contain—

(1) The reasons for the termination, and

(2) The effective date of termination.

## § 152.507

(c) After receipt of the notice of termination, the sponsor or planning agency may not incur additional obligations of grant funds.

(d) Payments to be made to the sponsor or planning agency, or recoveries of payments by the FAA, under the grant shall be in accordance with the legal rights and liabilities of the parties.

### § 152.507 Termination for convenience.

(a) When the continuation of the project would not produce beneficial results commensurate with the further expenditure of funds, the grant may be terminated in whole, or in part, upon mutual agreement of the FAA and the sponsor or planning agency.

(b) If an agreement to terminate is made, the sponsor or planning agency—

(1) May not incur new obligations for the terminated portion after the effective date; and

(2) Shall cancel as many obligations, relating to the terminated portion, as possible.

(c) The sponsor or planning agency is allowed full credit for the Federal share of the noncancellable obligations that were properly incurred by the sponsor before the termination.

### § 152.509 Request for reconsideration.

If a grant is suspended or terminated under this subpart, the sponsor or planning agency may request the Administrator to reconsider the suspension or termination.

## Subpart G—Energy Conservation in Airport Aid Program

AUTHORITY: Secs. 1-27, 84 Stat. 220-223 (49 U.S.C. 1711-1727); sec. 1.47(g), Regulations of the Office of the Secretary of Transportation; 35 FR 17044; sec. 403(b), 92 Stat. 3318; E.O. 12185.

SOURCE: Docket No. 66, 45 FR 58035, Aug. 29, 1980, unless otherwise noted.

### § 152.601 Purpose.

This subpart implements section 403 of the Powerplant and Industrial Fuel Use Act of 1978 (92 Stat. 3318; Pub. L. 95-620) in order to encourage conservation of petroleum and natural gas by recipients of Federal financial assistance.

## 14 CFR Ch. I (1-1-08 Edition)

### § 152.603 Applicability.

This subpart applies to each recipient of Federal financial assistance from the Federal Aviation Administration through the Airport Development Aid Program (ADAP) unless otherwise excluded by definition.

### § 152.605 Definitions.

As used in this subpart—

*Building construction* means construction of any building which receives Federal assistance under the program, which will exceed \$200,000 in construction cost.

*Energy assessment* means an analysis of total energy requirements of a building, which, within the scope of the proposed construction activity, and at a level of detail appropriate to that scope, considers the following:

(a) Overall design of the facility or modification, and alternative designs;

(b) Materials and techniques used in construction or rehabilitation;

(c) Special or innovative conservation features that may be used;

(d) Fuel requirements for heating, cooling, and operations essential to the function of the structure, projected over the life of the facility and including projected costs of this fuel; and

(e) Kind of energy to be used, including—

(1) Consideration of opportunities for using fuels other than petroleum and natural gas, and

(2) Consideration of using alternative, renewable energy sources.

*Major building modification* means modification of any building which receives Federal assistance under the program, which will exceed \$200,000 in construction cost.

### § 152.607 Building design requirements.

Each sponsor shall perform an energy assessment for each federally-assisted building construction or major building modification project proposed at the airport. The building design, construction, and operation shall incorporate, to the extent consistent with good engineering practice, the most cost-effective energy conservation features identified in the energy assessment.

**§ 152.609 Energy conservation practices.**

Each sponsor shall require fuel and energy conservation practices in the operation and maintenance of the airport and shall encourage airport tenants to use these practices.

APPENDIX A TO PART 152—CONTRACT  
AND LABOR PROVISIONS

This appendix sets forth contract and labor provisions applicable to grants under the Airport and Airway Development Act of 1970.

This appendix does not apply to: (1) Any contract with the owner of airport hazards, buildings, pipelines, powerlines, or other structures or facilities, for installing, extending, changing, removing, or relocating that structure or facility, and (2) any written agreement or understanding between a sponsor and another public agency that is not a sponsor of the project, under which the public agency undertakes construction work for or as agent of the sponsor.

*I. Contract Provisions Required by the  
Regulations of the Secretary of Labor*

Each sponsor entering into a construction contract for an airport development project shall insert in the contract and any supplemental agreement:

- (1) The provisions required by the Secretary of Labor, as set forth in paragraphs A through K;
- (2) The provisions set forth in paragraph L, and
- (3) Any other provisions necessary to ensure completion of the work in accordance with the grant agreement.

The provisions in paragraphs A through K and provision (5) in paragraph L need not be included in prime contracts of \$2,000 or less.

*A. Minimum wages.* (1) All mechanics and laborers employed or working upon the site of the work will be paid unconditionally and not less often than once a week, and without subsequent deduction or rebate on any account (except such payroll deductions as are permitted by regulations issued by the Secretary of Labor under the Copeland Act [29 CFR part 3], the full amounts due at time of payment computed at wage rates not less than those contained in the wage determination decision(s) of the Secretary of Labor which is (are) attached hereto and made a part hereof, regardless of any contractual relationship which may be alleged to exist between the contractor and such laborers and mechanics; and the wage determination decision(s) shall be posted by the contractor at the site of the work in a prominent place where it (they) can be easily seen by the workers. For the purpose of this paragraph, contributions made or costs reasonably an-

icipated under section 1(b)(2) of the Davis-Bacon Act on behalf of laborers or mechanics are considered wages paid to such laborers or mechanics, subject to the provisions of paragraph (4) below. Also for the purpose of this paragraph, regular contributions made or costs incurred for more than a weekly period under plans, funds, or programs, but covering the particular weekly period, are deemed to be constructively made or incurred during such weekly period (29 CFR 5.5(a)(1)(i)).

(2) Any class of laborers or mechanics, including apprentices and trainees, which is not listed in the wage determination(s) and which is to be employed under the contract, shall be classified or reclassified conformably to the wage determination(s), and a report of the action taken shall be sent by the [insert sponsor's name] to the FAA for approval and transmittal to the Secretary of Labor. In the event that the interested parties cannot agree on the proper classification or reclassification of a particular class of laborers and mechanics, including apprentices and trainees, to be used, the question accompanied by the recommendation of the FAA shall be referred to the Secretary of Labor for final determination (29 CFR 5.5(a)(1)(ii)).

(3) Whenever the minimum wage rate prescribed in the contract for a class of laborers or mechanics includes a fringe benefit which is not expressed as an hourly wage rate and the contractor is obligated to pay a cash equivalent of such a fringe benefit, an hourly cash equivalent thereof shall be established. In the event the interested parties cannot agree upon a cash equivalent of the fringe benefit, the question accompanied by the recommendation of the FAA shall be referred to the Secretary of Labor for determination (29 CFR 5.5(a)(1)(iii)).

(4) If the contractor does not make payments to a trustee or other third person, he may consider as part of the wages of any laborer or mechanic the amount of any costs reasonably anticipated in providing benefits under a plan or program of a type expressly listed in the wage determination decision of the Secretary of Labor which is a part of this contract: *Provided, however,* the Secretary of Labor has found, upon written request of the contractor, that the applicable standards of the Davis-Bacon Act have been met. The Secretary of Labor may require the contractor to set aside in a separate account assets for the meeting of obligations under the plan or program (29 CFR 5.5(a)(1)(iv)).

*B. Withholding: FAA from sponsor.* Pursuant to the terms of the grant agreement between the United States and [insert sponsor's name], relating to Airport Development Aid Project No. \_\_, and part 152 of the Federal Aviation Regulations (14 CFR part 152), the FAA may withhold or cause to be withheld from the [insert sponsor's name] so much of the accrued payments or advances as may be

considered necessary to pay laborers and mechanics, including apprentices and trainees, employed by the contractor or any subcontractor on the work the full amount of wages required by this contract. In the event of failure to pay any laborer or mechanics, including any apprentice or trainee, employed or working on the site of the work all or part of the wages required by this contract, the FAA may, after written notice to the [insert sponsor's name], take such action as may be necessary to cause the suspension of any further payment or advance of funds until such violations have ceased (29 CFR 5.5(a)(2)).

*C. Payrolls and basic records.* (1) Payrolls and basic records relating thereto will be maintained during the course of the work and preserved for a period of 3 years thereafter for all laborers and mechanics working at the site of the work. Such records will contain the name and address of each such employee, his correct classification, rates of pay (including rates of contributions or costs anticipated of the types described in section 1(b)(2) of the Davis-Bacon Act), daily and weekly number of hours worked, deductions made and actual wages paid. Whenever the Secretary of Labor has found, under 29 CFR 5.5(a)(1)(iv) (see paragraph (4) of paragraph A above), that the wages of any laborer or mechanic include the amount of any costs reasonably anticipated in providing benefits under a plan or program described in section 1(b)(2)(B) of the Davis-Bacon Act, the contractor shall maintain records which show that the commitment to provide such benefits is enforceable, that the plan or program is financially responsible, and that the plan or program has been communicated in writing to the laborers or mechanics affected, and records which show the costs anticipated or the actual costs incurred in providing such benefits (29 CFR 5.5(a)(3)(i)).

(2) The contractor will submit weekly a copy of all payrolls to the [insert sponsor's name] for availability to the FAA. The copy shall be accompanied by a statement signed by the employer or his agent indicating that the payrolls are correct and complete, that the wage rates contained therein are not less than those determined by the Secretary of Labor and that the classifications set forth for each laborer or mechanic conform with the work he performed. A submission of a "Weekly Statement of Compliance" which is required under this contract and the Copeland regulations of the Secretary of Labor (29 CFR part 3) and the filing with the initial payroll or any subsequent payroll of a copy of any findings by the Secretary of Labor under 29 CFR 5.5(a)(1)(iv) (see paragraph (4) of paragraph A above), shall satisfy this requirement. The prime contractor shall be responsible for submission of copies of payrolls of all subcontractors. The contractor will make the records required under the labor standards clauses of the contract

available for inspection by authorized representatives of the FAA and the Department of Labor, and will permit such representatives to interview employees during working hours on the job. Contractors employing apprentices or trainees under approved programs shall include a notation on the first weekly certified payrolls submitted to the [insert sponsor's name] for availability to the FAA, that their employment is pursuant to an approved program and shall identify the program (29 CFR 5.5(a)(3)(ii)).

*D. Apprentices and trainees—(1) Apprentices.* Apprentices will be permitted to work at less than the predetermined rate for the work they performed when they are employed and individually registered in a bona fide apprenticeship program registered with the U.S. Department of Labor, Employment and Training Administration, Bureau of Apprenticeship and Training, or with a State Apprenticeship Agency recognized by the Bureau, or if a person is employed in his first 90 days of probationary employment as an apprentice in such an apprenticeship program, who is not individually registered in the program, but who has been certified by the Bureau of Apprenticeship and Training or a State Apprenticeship Agency (where appropriate) to be eligible for probationary employment as an apprentice. The allowable ratio of apprentices to journeymen in any craft classification shall not be greater than the ratio permitted to the contractor as to his entire work force under the registered program. Any employee listed on a payroll at an apprentice wage rate, who is not a trainee as defined in paragraph (2) of this paragraph or is not registered or otherwise employed as stated above, shall be paid the wage rate determined by the Secretary of Labor for the classification of work he actually performed. The contractor or subcontractor will be required to furnish to the [insert sponsor's name] or a representative of the Wage-Hour Division of the U.S. Department of Labor written evidence of the registration of his program and apprentices as well as the appropriate ratios and wage rates (expressed in percentages of the journeyman hourly rates), for the area of construction prior to using any apprentices on the contract work. The wage rate paid apprentices shall be not less than the appropriate percentage of the journeyman's rate contained in the applicable wage determination (29 CFR 5.5(a)(4)(i)).

(2) *Trainees.* Except as provided in 29 CFR 5.15 trainees will not be permitted to work at less than the predetermined rate for the work performed unless they are employed pursuant to and individually registered in a program which has received prior approval, evidenced by formal certification by the U.S. Department of Labor, Employment and Training Administration, Bureau of Apprenticeship and Training. The ratio of trainees

to journeymen shall not be greater than permitted under the plan approved by the Bureau of Apprenticeship and Training. Every trainee must be paid at not less than the rate specified in the approved program for his level of progress. Any employee listed on the payroll at a trainee rate who is not registered and participating in a training plan approved by the Bureau of Apprenticeship and Training shall be paid not less than the wage rate determined by the Secretary of Labor for the classification of work he actually performed. The contractor or subcontractor will be required to furnish the [insert sponsor's name] or a representative of the Wage-Hour Division of the U.S. Department of Labor written evidence of the certification of his program, the registration of the trainees, and the ratios and wage rates prescribed in that program. In the event the Bureau of Apprenticeship and Training withdraws approval of a training program, the contractor will no longer be permitted to utilize trainees at less than the applicable predetermined rate for the work performed until an acceptable program is approved (29 CFR 5.5(a)(4)(ii)).

(3) *Equal employment opportunity.* The utilization of apprentices, trainees and journeymen under this paragraph shall be in conformity with the equal employment opportunity requirements of Executive Order 11246, as amended, and 29 CFR part 30 (29 CFR 5.5(a)(4)(iii)).

(4) *Application of 29 CFR 5.5(a)(4).* On contracts in excess of \$2,000 the employment of all apprentices and trainees as defined in 29 CFR 5.2(c) shall be subject to the provisions of 29 CFR 5.5(a)(4) (see paragraph D(1), (2), and (3) above).

*E. Compliance with Copeland Regulations.* The contractor shall comply with the Copeland Regulations (29 CFR part 3) of the Secretary of Labor which are herein incorporated by reference (29 CFR 5.5(a)(5)).

*F. Overtime requirements.* No contractor or subcontractor contracting for any part of the contract work which may require or involve the employment of laborers or mechanics shall require or permit any laborer or mechanic in any workweek in which he is employed on such work to work in excess of 8 hours in any calendar day or in excess of 40 hours in such workweek unless such laborer or mechanic received compensation at a rate not less than 1½ times his basic rate of pay for all hours worked in excess of 8 hours in any calendar day or in excess of 40 hours in such workweek, as the case may be (29 CFR 5.5(c)(1)).

*G. Violations; liability for unpaid wages; liquidated damages.* In the event of any violation of paragraph F of this provision, the contractor and any subcontractor responsible therefor shall be liable to any affected employee for his unpaid wages. In addition, such contractor and subcontractor shall be

liable to the United States for liquidated damages. Such liquidated damages shall be computed, with respect to each individual laborer or mechanic employed in violation of said paragraph F of this provision, in the sum of \$10 for each calendar day on which such employee was required or permitted to work in excess of 8 hours or in excess of the standard workweek of 40 hours without payment of the overtime wages required by said paragraph F of this provision (29 CFR 5.5(c)(2)).

*H. Withholding for unpaid wages and liquidated damages.* The FAA may withhold or cause to be withheld, from any monies payable on account of work performed by the contractor or subcontractor, such sums as may administratively be determined to be necessary to satisfy any liabilities of such contractor or subcontractor for unpaid wages and liquidated damages as provided in paragraph G of this provision (29 CFR 5.5(c)(3)).

*I. Working conditions.* No contractor may require any laborer or mechanic employed in the performance of any contract to work in surroundings or under working conditions that are unsanitary, hazardous, or dangerous to his health or safety as determined under construction safety and health standards (29 CFR part 1926) and other occupational and health standards (29 CFR part 1910) issued by the Department of Labor.

*J. Subcontracts.* The contractor will insert in each of his subcontracts the clauses contained in paragraphs A through K of this provision, and also a clause requiring the subcontractors to include these provisions in any lower tier subcontracts which they may enter into, together with a clause requiring this insertion in any further subcontracts that may in turn be made (29 CFR 5.5(a)(6), 5.5(c)(4)).

*K. Contract termination debarment.* A breach of clause A, B, C, D, E, or J may be grounds for termination of the contract, and for debarment as provided in §5.6 of the Regulations of the Secretary of Labor as codified in 29 CFR 5.6 (29 CFR 5.5(a)(7)).

*L. Additional contract provisions—(1) Airport Development Aid Program Project.* The work in this contract is included in Airport Development Aid Program Project No. \_\_, which is being undertaken and accomplished by the [insert sponsor's name] in accordance with the terms and conditions of a grant agreement between the [insert sponsor's name] and the United States, under the Airport and Airway Development Act of 1970 (84 Stat. 219) and part 152 of the Federal Aviation Regulations (14 CFR part 152), pursuant to which the United States has agreed to pay a certain percentage of the costs of the project that are determined to be allowable project costs under that Act. The United States is not a party to this contract and no reference

in this contract to the FAA or any representative thereof, or to any rights granted to the FAA or any representative thereof, or the United States, by the contract, makes the United States a party to this contract.

(2) *Consent to assignment.* The contractor shall obtain the prior written consent of the [insert sponsor's name] to any proposed assignment of any interest in or part of this contract.

(3) *Convict labor.* No convict labor may be employed under this contract.

(4) *Veterans preference.* In the employment of labor (except in executive, administrative, and supervisory positions), preference shall be given to qualified individuals who have served in the military service of the United States (as defined in section 101(1) of the Soldiers' and Sailors' Civil Relief Act of 1940 (50 U.S.C. App. 501) and have been honorably discharged from the service, except that preference may be given only where that labor is available locally and is qualified to perform the work to which the employment relates.

(5) *Withholding: sponsor from contractor.* Whether or not payments or advances to the [insert sponsor's name] are withheld or suspended by the FAA, the [insert sponsor's name] may withhold or cause to be withheld from the contractor so much of the accrued payments or advances as may be considered necessary to pay laborers and mechanics employed by the contractor or any subcontractor on the work the full amount of wages required by this contract.

(6) *Nonpayment of wages.* If the contractor or subcontractor fails to pay any laborer or mechanic employed or working on the site of the work any of the wages required by this contract the [insert sponsor's name] may, after written notice to the contractor, take such action as may be necessary to cause the suspension of any further payment or advance of funds until the violations cease.

(7) *FAA inspection and review.* The contractor shall allow any authorized representative of the FAA to inspect and review any work or materials used in the performance of this contract.

(8) *Subcontracts.* The contractor shall insert in each of his subcontracts the provisions contained in paragraphs [insert designation of 6 paragraphs of contract corresponding to paragraphs (1), (3), (4), (5), (6), and (7) of this paragraph], and also a clause requiring the subcontractors to include these provisions in any lower tier subcontracts which they may enter into, together with a clause requiring this insertion in any further subcontracts that may in turn be made.

(9) *Contract termination.* A breach of paragraphs [insert designation of 3 paragraphs corresponding to paragraphs (6), (7), and (8) of this paragraph] may be grounds for termination of the contract.

### *II. Adjustment in Liquidated Damages*

A contractor or subcontractor who has become liable for liquidated damages under the provision set out in paragraph I.G of this appendix and who claims that the amount administratively determined as liquidated damages under section 104(a) of the Contract Work Hours and Safety Standards Act is incorrect or that he violated inadvertently the Contract Work Hours and Safety Standards Act, notwithstanding the exercise of due care, may—

(1) If the amount determined is more than \$100, apply to the Administrator for a recommendation to the Secretary of Labor that an appropriate adjustment be made or that he be relieved of liability for the liquidated damages; or

(2) If the amount determined is \$100 or less, apply to the Administrator for an appropriate adjustment in liquidated damages or for release from liability for the liquidated damages.

### *III. Corrected Wage Determinations*

The Secretary of Labor corrects any wage determination included in any contract under this appendix whenever the wage determination contains clerical errors. A correction may be made at the Administrator's request or on the initiative of the Secretary of Labor.

### *IV. Applicability of Interpretations of the Secretary of Labor*

When applicable by their terms, the regulations of the Secretary of Labor (29 CFR 5.20–5.32) interpreting the “fringe benefit provisions” of the Davis-Bacon Act apply to the contract provisions in this appendix.

### *V. Records*

A sponsor who is required to include in a construction contract the labor provisions required by this appendix shall require the contractor to comply with those provisions and shall cooperate with the FAA in effecting that compliance. For this purpose the sponsor shall—

(1) Keep, and preserve, the record described in paragraph IC for a 3-year period beginning on the date the contract is completed, each affidavit and payroll copy furnished by the contractor, and make those affidavits and copies available to the FAA, upon request, during that period;

(2) Have each of those affidavits and payrolls examined by its resident engineer (or any other of its employees or agents who is qualified to make the necessary determinations), as soon as possible after receiving it, to the extent necessary to determine whether the contractor is complying with the labor provisions required by this appendix and particularly with respect to whether the

contractor's employees are correctly classified;

(3) Have investigations made during the performance of work under the contract, to the extent necessary to determine whether the contractor is complying with those labor provisions, including in the investigations, interviews with employees and examinations of payroll information at the work site by the sponsor's resident engineer (or any other of its employees or agents who is qualified to make the necessary determinations);

(4) Keep the appropriate FAA office fully advised of all examinations and investigations made under this appendix, all determinations made on the basis of those examinations and investigations, and all efforts made to obtain compliance with the labor provisions of the contract; and

(5) Give priority to complaints of alleged violations, and treat as confidential any written or oral statements made by any employee in connection with a complaint, and not disclose an employee's statement made in connection with a complaint to a contractor without the employee's consent.

[Doc. No. 19430, 45 FR 34793, May 22, 1980]

APPENDIX B TO PART 152—LIST OF ADVISORY CIRCULARS INCORPORATED BY § 152.11

(a) *Circulars available free of charge.*

*Number and Subject*

150/5100-12—Electronic Navigational Aids Approved for Funding Under the Airport Development Aid Program (ADAP).  
 150/5190-3A—Model Airport Hazard Zoning Ordinance.  
 150/5210-7A—Aircraft Fire and Rescue Communications.  
 150/5210-10—Airport Fire and Rescue Equipment Building Guide.  
 150/5300-2C—Airport Design Standards—Site Requirements for Terminal Navigational Facilities.  
 150/5300-4B—Utility Airports—Air Access to National Transportation.  
 150/5300-6—Airport Design Standards—General Aviation Airports—Basic and General Transport.  
 150/5300-8—Planning and Design Criteria for Metropolitan STOL Ports.  
 150/5320-6B—Airport Pavement Design and Evaluation.  
 150/5320-10—Environmental Enhancement at Airports—Industrial Waste Treatment.  
 150/5320-12—Methods for the Design, Construction, and Maintenance of Skid Resistant Airport Pavement Surfaces.  
 150/5325-2C—Airport Design Standards—Airports Served by Air Carriers—Surface Gradient and Line-of-Sight.  
 150/5325-4—Runway Length Requirements for Airport Design.

150/5325-6A—Airport Design Standards—Effect and Treatment of Jet Blast.  
 150/5325-8—Compass Calibration Pad.  
 150/5335-1A—Airport Design Standards—Airports Served by Air Carriers—Taxiways.  
 150/5335-2—Airport Aprons.  
 150/5335-3—Airport Design Standards—Airports Served by Air Carriers—Bridges and Tunnels on Airports.  
 150/5335-4—Airport Design Standards—Airports Served by Air Carriers—Runway Geometrics.  
 150/5340-1D—Marking of Paved Areas on Airports.  
 150/5340-4C—Installation Details for Runway Centerline and Touchdown Zone Lighting Systems.  
 150/5340-5A—Segmented Circle Airport Marker System.  
 150/5340-8—Airport 51-foot Tubular Beacon Tower.  
 150/5340-14B—Economy Approach Lighting Aids.  
 150/5340-17A—Standby Power for Non-FAA Airport Lighting System.  
 150/5340-18—Taxiway Guidance Sign System.  
 150/5340-19—Taxiway Centerline Lighting System.  
 150/5340-20—Installation Details and Maintenance Standards for Reflective Markers for Airport Runway and Taxiway Centerlines.  
 150/5340-21—Airport Miscellaneous Lighting Visual Aids.  
 AC/5340-22—Maintenance Guide for Determining Degradation and Cleaning of Centerline and Touchdown Zone Lights.  
 150/5340-23A—Supplemental Wind Cones.  
 150/5340-24—Runway and Taxiway Edge Lighting System.  
 150/5340-25—Visual Approach Slope Indicator (VASI) Systems.  
 150/5345-1E—Approved Airport Lighting Equipment.  
 150/5345-2—Specification for L-810 Obstruction Light.  
 150/5345-3C—Specification for L-821 Panels for Remote Control of Airport Lighting.  
 150/5345-4—Specification for L-829 Internally Lighted Airport Taxi Guidance Sign.  
 150/5345-5—Specification for L-847 Circuit Selector Switch, 5,000 Volt 20 Ampere.  
 150/5345-7C—Specification for L-824 Underground Electrical Cable for Airport Lighting Circuits.  
 150/5345-10C—Specification for L-828 Constant Current Regulators.  
 150/5345-11—Specification for L-812 Static Indoor Type Constant Current Regulator Assembly; 4 KW and 7½ KW, With Brightness Control for Remote Operation.  
 150/5345-12A—Specification for L-801 Beacon.  
 150/5345-13—Specification for L-841 Auxiliary Relay Cabinet Assembly for Pilot Control of Airport Lighting Circuits.

- 150/5345-18—Specification for L-811 Static Indoor Type Constant Current Regulator Assembly, 4 KW; With Brightness Control and Runway Selection for Direct Operation.
- 150/5345-21—Specification for L-813 Static Indoor Type Constant Current Regulator Assembly; 4 KW and 7½ KW; for Remote Operation of Taxiway Lights.
- 150/5345-26A—Specification for L-823 Plug and Receptacle. Cable Connectors.
- 150/5345-27A—Specification for L-807 Eight-foot and Twelve-foot Unlighted or Externally Lighted Wind Cone Assemblies.
- 150/5345-28C—Specification for L-851 Visual Approach Slope Indicators and Accessories.
- 150/5345-36—Specification for L-808 Lighted Wind Tee.
- 150/5345-39A—FAA Specification for L-853, Runway and Taxiway Retroreflective Markers.
- 150/5345-42A—FAA Specification L-857, Airport Light Bases, Transformer Housings, and Junction Boxes.
- 150/5345-43B—FAA/DOD Specification L-856, High Intensity Obstruction Lighting Systems.
- 150/5345-44A—Specification for L-858 Retroreflective Taxiway Guidance Sign.
- 150/5345-45—Lightweight Approach Light Structure.
- 150/5345-46—Specification for Semiflush Airport Lights.
- 150/5345-47—Isolation Transformers for Airport Lighting Systems.
- 150/5345-48—Specification for Runway and Taxiway Edge Lights.
- 150/5360-6—Airport Terminal Building Development with Federal Participation.
- 150/5360-7—Planning and Design Considerations for Airport Terminal Building Development.
- 150/5370-7—Airport Construction Controls to Prevent Air and Water Pollution.
- 150/5370-9—Slip-Form Paving—Portland Cement Concrete.
- 150/5370-11—Use of Nondestructive Testing Devices in the Evaluation of Airport Pavements.

(b) *Circulars for sale.*

*Number and Subject*

- 150/5320-5B—Airport Drainage; \$1.30.
- 150/5370-10—Standards for Specifying Construction of Airports; \$7.25.
- 150/5390-1A—Heliport Design Guide; \$1.50.
- [Doc. No. 19430, 45 FR 34795, May 22, 1980]

APPENDIX C TO PART 152—PROCUREMENT PROCEDURES AND REQUIREMENTS

There is set forth below procurement procedures and requirements applicable to grants for airport development under the Airport and Airway Development Act of 1970.

1. *General.* Each contract under a project must meet the requirements of local law and

the requirements and standards contained in this appendix. The sponsor shall establish procedures for procurement of supplies, equipment, construction, and services funded under the project which meet the requirements of Attachment O of Office of Management and Budget (OMB) Circular A-102 (44 FR 47874) and of this appendix. Subject to funding and time limitations, the FAA reviews the sponsor's procurement system to determine whether it may be certified in accordance with Attachment O of OMB Circular A-102.

2. *Out-of-state labor.* No procedure or requirement shall be imposed by any grantee which will operate to discriminate against the employment of labor from any other State, possession, or territory of the United States in the construction of a project.

3. *Bid guarantee.* All bids for construction or facility improvement in excess of \$100,000 shall be accompanied by a bid guarantee consisting of a firm commitment such as a bid bond, certified check or other negotiable instrument equivalent to five percent of the bid price as assurance that the bidder will, upon acceptance of his bid, execute such contractual documents as may be required within the time specified.

4. *Construction work.* All construction work under a project must be performed under contract, except in a case where the Administrator determines that the project, or a part of it, can be more effectively and economically accomplished on a force account basis by the sponsor or by another public agency acting for or as agent of the sponsor.

5. *Change order.* Unless otherwise authorized by the Administrator, no sponsor may issue any change order under any of its construction contracts or enter into a supplemental agreement unless three copies of that order or agreement have been sent to, and approved by, the FAA.

6. *Beginning work.* No sponsor may allow a contractor or subcontractor to begin work under a project until—

a. The sponsor has furnished three conformed copies of the contract to the appropriate FAA office;

b. The sponsor has, if applicable, submitted a statement that comparable replacement housing, as defined in §25.15 of the Regulations of the Office of the Secretary of Transportation, will be available within a reasonable period of time before displacement.

c. The appropriate FAA office has agreed to the issuance of a notice to proceed with the work to the contractor.

7. *Supervision and inspection.* No work will be commenced until the sponsor has provided for adequate supervision and inspection of construction and advised the appropriate FAA office.

8. *Engineering and planning services.* Unless otherwise authorized by the Administrator, each proposal for engineering and planning

services shall be reviewed by FAA before the commencement of the development of design plans and specifications.

9. *Advertising general.* Unless the Administrator approves another method for use on a particular airport development project, each contract and supplemental agreement for construction work on a project in the amount of more than \$10,000 must be awarded on the basis of public advertising and open competitive bidding under the local law applicable to the letting of public contracts.

10. *Advertising: conditions and contents.* There may be no advertisement for bids on, or negotiation of, a construction contract or supplemental agreement until the Administrator has either approved the plans and specifications or accepted a certification in accordance with §152.7 that they meet all applicable standards prescribed by this part. The advertisement shall inform the bidders of the equal employment opportunity requirements of part 152. Unless the estimated contract price or construction cost in \$2,000 or less, there may be no advertisement for bids or negotiations until the Administrator has given the sponsor a copy of a decision of the Secretary of Labor establishing the minimum wage rates for skilled and unskilled labor under the proposed contract. In each case, a copy of the wage determination decision, including fringe benefits, must be set forth in the initial invitation for bids or proposed contract, or incorporated therein by reference to a copy set forth in the advertised or negotiated specifications.

11. *Procedures for obtaining wage determinations.* (a) *Specific request for wage determination.* At least 60 days before the intended date of advertising or negotiating of this section, the sponsor shall send to the appropriate FAA office, completed Department of Labor Form DB-11 or DB-11(a), as appropriate, with only the classifications needed in the performance of the work checked. General entries (such as "entire schedule" or "all applicable classifications") may not be used. Additional necessary classifications not on the form may be typed in the blank spaces or on an attached separate list. A classification that can be fitted into classifications on the form, or a classification that is not generally recognized in the area or in the industry, may not be used. Except in areas where the wage patterns are clearly established, the Form must be accompanied by any available pertinent wage payment or locally prevailing fringe benefit information.

(b) *General wage determination.* Whenever the wage patterns in a particular area for a particular type of construction are well settled and whenever it may be reasonably anticipated that there will be a large volume of procurement in that area for that type of construction, the Secretary of Labor, upon the request of a Federal agency or in his discretion, may issue a general wage deter-

mination when, after consideration of the facts and circumstances involved, he finds that the applicable statutory standards and those of part 1, 29 CFR, subtitle A, will be met. This general wage determination is used for all projects located in the area and for the type of construction covered by the general wage determination.

12. *Advertising: wage determinations.* (a) Wage determinations are effective only for 120 days from the date of the determinations. If it appears that a determination may expire between bid opening and award, the sponsor shall so advise the FAA as soon as possible. If it wishes a new request for wage determination to be made and if any pertinent circumstances have changed, it shall submit the appropriate form of the Department of Labor and accompanying information. If it claims that the determination expires before award and after bid opening due to unavoidable circumstances, it shall submit proof of the facts which it claims support a finding to that effect.

(b) The Secretary of Labor may modify any wage determination before the award of the contract or contracts for which it was sought. If the proposed contract is awarded on the basis of public advertisement and open competitive bidding, any modification that the FAA receives less than 10 days before the opening of bids is not effective, unless the Administrator finds that there is reasonable time to notify bidders. A modification may not continue in effect beyond the effective period of the wage determination to which it relates. The Administrator sends any modification to the sponsor as soon as possible. If the modification is effective, it must be incorporated in the invitation for bids, by issuing an addendum to the specifications or otherwise.

13. *Awarding contracts.* (a) A sponsor may not award a construction contract without the written concurrence of the Administrator (through the appropriate FAA office) that the contract prices are reasonable. A sponsor that awards contracts on the basis of public advertising and open competitive bidding, shall, after the bids are opened, send a tabulation of the bids and its recommendations for award to the appropriate FAA office. The sponsor may not accept a bid by a contractor whose name appears on the current list of ineligible contractors published by the Comptroller General of the United States under §5.6(b) of the regulations of the Secretary of Labor (29 CFR part 5), or a bid by any firm, corporation, partnership, or association in which an ineligible contractor has a substantial interest.

(b) A sponsor's proposed contract must have pre-award review and approval by the FAA in any of the following circumstances:

(1) The sponsor's procurement system is not in compliance with one or more significant aspects of Attachment O of OMB Circular A-102 or with the standards of this appendix.

(2) The procurement is expected to exceed \$10,000 and is to be awarded without competition or only one bid or offer is received in response to solicitation.

(3) The procurement is expected to exceed \$10,000 and specifies a "brand name" product.

(c) The FAA may require pre-award review and approval of a sponsor's proposed contract under any of the following circumstances:

(1) The sponsor's procurement system has not yet been reviewed by the FAA for compliance with OMB Circular A-102 and this appendix.

(2) The sponsor has requested pre-award assistance.

(3) The proposal is for automatic data processing in accordance with paragraph C1 of Attachment B to Federal Management Circular 74-4 (39 FR 27133; 43 FR 50977).

(4) The proposal is one of a series with the same firm.

(5) The proposal is to be performed outside the recipient's established procurement system or office.

(6) The proposal is for construction and is to be awarded through the negotiation procurement method or without competition.

14. *Force account work.* Before undertaking any force account construction work, the sponsor (or any public agency acting as agent for the sponsor) must obtain the written consent of the Administrator through the appropriate FAA office. In requesting that consent, the sponsor must submit—

(a) Adequate plans and specifications showing the nature and extent of the construction work to be performed under that force account;

(b) A schedule of the proposed construction and of the construction equipment that will be available for the project;

(c) Assurance that adequate labor, material, equipment, engineering personnel, as well as supervisory and inspection personnel as required by this appendix, will be provided; and

(d) A detailed estimate of the cost of the work, broken down for each class of costs involved, such as labor, materials, rental of equipment, and other pertinent items of cost.

15. *Each sponsor shall—*

(a) Include the equal opportunity clause required by 41 CFR 60-1.4(b) in each nonexempt construction contract and subcontract;

(b) Prior to the award of each nonexempt contract, require each prime contractor and subcontractor to submit the certification required by 41 CFR 60-1.8(b);

(c) Include the Notice of Requirement for Affirmative Action to Ensure Equal Employ-

ment Opportunity (Executive Order 11246) required by 41 CFR 60-4.2 in all solicitations for offers and bids on each nonexempt construction contract and subcontract;

(d) Include the Standard Federal Equal Employment Opportunity Construction Contract Specifications (Executive Order 11246) required by 41 CFR 60-4.3(a) in each nonexempt construction contract and subcontract.

16. *Exceptions.* (a) Paragraphs 1 through 5 and paragraphs 9 through 13 of this section do not apply to contracts with the owners of airport hazards, buildings, pipelines, powerlines, or other structures or facilities, for installing, extending, changing, removing, or relocating any of those structures or facilities. However, the sponsor must obtain the approval of the appropriate FAA office before entering into such a contract.

(b) Any oral or written agreement or understanding between a sponsor and another public agency that is not a sponsor of the project, under which that public agency undertakes construction work for or as agent of the sponsor, is not considered to be a construction contract for the purposes of this appendix.

[Doc. No. 19430, 45 FR 34796, May 22, 1980]

#### APPENDIX D TO PART 152—ASSURANCES

There is set forth below the assurances that the sponsor or planning agency must submit with its application in accordance with §§ 152.111 or 152.113, as applicable.

##### *I. General Assurance*

Each applicant for an airport development grant or an airport planning grant shall submit the following assurance:

The applicant hereby assures and certifies that it will comply with the regulations, policies, guidelines, and requirements, including Office of Management and Budget Circulars No. A-95 (41 FR 2052), A-102 (42 FR 45828), and FMC 74-4 (39 FR 27133; as amended by 43 FR 50977), as they relate to the application, acceptance, and use of Federal funds for this federally-assisted project.

##### *II. Airport Development*

A. *Assurances.* Each applicant for an airport development grant shall submit the following assurances:

1. *Authority of applicant.* It possesses legal authority to apply for the grant, and to finance and construct the proposed facilities; that a resolution, motion or similar action has been duly adopted or passed as an official act of the applicant's governing body, authorizing the filing of the application, including all understandings and assurances

contained therein, and directing and authorizing the person identified as the official representative of the applicant to act in connection with the application and to provide such additional information as may be required.

2. *E.O. 11296 and E.O. 11288.* It will comply with the provisions of: Executive Order 11296, relating to evaluation of flood hazards, and Executive Order 11288, relating to the prevention, control, and abatement of water pollution.

3. *Sufficiency of funds.* It will have sufficient funds available to meet the non-Federal share of the cost for construction projects. Sufficient funds will be available when construction is completed to assure effective operation and maintenance of the facility for the purposes constructed.

4. *Construction.* It will obtain approval by the appropriate Federal agency of the final working drawings and specifications before the project is advertised or placed on the market for bidding; that it will construct the project, or cause it to be constructed, to final completion in accordance with the application and approved plans and specifications; that it will submit to the appropriate Federal agency for prior approval changes that alter the costs of the project, use of space, or functional layout; that it will not enter into a construction contract(s) for the project or undertake other activities until the conditions of the construction grant program(s) have been met.

5. *Supervision, inspection, and reporting.* It will provide and maintain competent and adequate architectural engineering supervision and inspection at the construction site to insure that the completed work conforms with the approved plans and specifications; that it will furnish progress reports and such other information as the Federal grantor agency may require.

6. *Operation of facility.* It will operate and maintain the facility in accordance with the minimum standards as may be required or prescribed by the applicable Federal, State and local agencies for the maintenance and operation of such facilities.

7. *Access to records.* It will give the grantor agency and the Comptroller General through any authorized representative access to and the right to examine all records, books, papers, or documents related to the grant.

8. *Access for handicapped.* It will require the facility to be designed to comply with part 27, Nondiscrimination on the Basis of Handicap in Federally Assisted Programs and Activities Receiving or Benefiting from Federal Financial Assistance, of the Regulations of the Office of the Secretary of Transportation (49 CFR part 27). The applicant will be responsible for conducting inspections to insure compliance with these specifications by the contractor.

9. *Commencement and completion.* It will cause work on the project to be commenced

within a reasonable time after receipt of notification from the approving Federal agency that funds have been approved and that the project will be prosecuted to completion with reasonable diligence.

10. *Disposition of interest.* It will not dispose of or encumber its title or other interests in the site and facilities during the period of Federal interest or while the Government holds bonds, whichever is the longer.

11. *Civil Rights.* It will comply with Title VI of the Civil Rights Act of 1964 (Pub. L. 88-352) and in accordance with Title VI of that Act, no person in the United States shall, on the ground of race, color, or national origin, be excluded from participation in, be denied the benefits of, or be otherwise subjected to discrimination under any program or activity for which the applicant receives Federal financial assistance and will immediately take any measures necessary to effectuate this agreement. If any real property or structure thereon is provided or improved with the aid of Federal financial assistance extended to the Applicant, this assurance shall obligate the Applicant, or in the case of any transfer of such property, any transferee, for the period during which the real property or structure is used for a purpose for which the Federal financial assistance is extended or for another purpose involving the provision of similar services or benefits.

12. *Private gain.* It will establish safeguards to prohibit employees from using their positions for a purpose that is or gives the appearance of being motivated by a desire for private gain for themselves or others, particularly those with whom they have family, business, or other ties.

13. *Relocation assistance.* It will comply with the requirements of Title II and Title III of the Uniform Relocation Assistance and Real Property Acquisition Policies Act of 1970 (Pub. L. 91-646) which provides for fair and equitable treatment of persons displaced as a result of Federal and federally assisted programs.

14. *OMB Circular A-102.* It will comply with all requirements imposed by the Federal grantor agency concerning special requirements of law, program requirements, and other administrative requirements approved in accordance with Office of Management and Budget Circular No. A-102.

15. *Hatch Act.* It will comply with the provisions of the Hatch Act which limit the political activity of employees.

16. *Federal Fair Labor Standards Act.* It will comply with the minimum wage and maximum hours provisions of the Federal Fair Labor Standards Act, as they apply to hospital and educational institution employees of State and local governments.

17. *Effective date and duration.* These covenants shall become effective upon acceptance by the sponsor of an offer of Federal aid for the Project or any portion thereof, made

by the FAA and shall constitute a part of the Grant Agreement thus formed. These covenants shall remain in full force and effect throughout the useful life of the facilities developed under this Project, but in any event not to exceed twenty (20) years from the date of said acceptance of an offer of Federal aid for the Project. However, these limitations on the duration of the covenants do not apply to the covenant against exclusive rights and real property acquired with Federal funds. Any breach of these covenants on the part of the sponsor may result in the suspension or termination of, or refusal to grant Federal assistance under, FAA administered programs, or such other action which may be necessary to enforce the rights of the United States under this agreement.

18. *Conditions and limitations on airport use.* The Sponsor will operate the Airport as such for the use and benefit of the public. In furtherance of this covenant (but without limiting its general applicability and effect), the Sponsor specifically agrees that it will keep the Airport open to all types, kinds, and classes of aeronautical use on fair and reasonable terms without discrimination between such types, kinds, and classes. *Provided*, that the sponsor may establish such fair, equal, and not unjustly discriminatory conditions to be met by all users of the airport as may be necessary for the safe and efficient operation of the Airport; and *Provided further*, That the Sponsor may prohibit or limit any given type, kind, or class of aeronautical use of the Airport if such action is necessary for the safe operation of the Airport or necessary to serve the civil aviation needs of the public.

19. *Exclusive right.* The Sponsor—

a. Will not grant or permit any exclusive right forbidden by Section 308(a) of the Federal Aviation Act of 1958 (49 U.S.C. 1349(a)) at the Airport, or at any other airport now owned or controlled by it;

b. Agrees that, in furtherance of the policy of the FAA under this covenant, unless authorized by the Administrator, it will not, either directly or indirectly, grant or permit any person, firm or corporation the exclusive right at the Airport, or at any other airport now owned or controlled by it, to conduct any aeronautical activities, including, but not limited to charter flights, pilot training, aircraft rental and sightseeing, aerial photography, crop dusting, aerial advertising and surveying, air carrier operations, aircraft sales and services, sale of aviation petroleum products whether or not conducted in conjunction with other aeronautical activity, repair and maintenance of aircraft, sale of aircraft parts, and any other activities which because of their direct relationship to the operation of aircraft can be regarded as an aeronautical activity.

c. Agrees that it will terminate any existing exclusive right to engage in the sale of

gasoline or oil, or both, granted before July 17, 1962, at such an airport, at the earliest renewal, cancellation, or expiration date applicable to the agreement that established the exclusive right; and

d. Agrees that it will terminate any other exclusive right to conduct an aeronautical activity now existing at such an airport before the grant of any assistance under the Airport and Airway Development Act.

20. *Public use and benefit.* The Sponsor agrees that it will operate the Airport for the use and benefit of the public, on fair and reasonable terms, and without unjust discrimination. In furtherance of the covenant (but without limiting its general applicability and effect), the Sponsor specifically covenants and agrees:

a. That in its operation and the operation of all facilities on the Airport, neither it nor any person or organization occupying space or facilities thereon will discriminate against any person or class of persons by reason of race, color, creed, or national origin in the use of any of the facilities provided for the public on the Airport.

b. That in any agreement, contract, lease or other arrangement under which a right or privilege at the Airport is granted to any person, firm, or corporation to conduct or engage in any aeronautical activity for furnishing services to the public at the Airport, the Sponsor will insert and enforce provisions requiring the contractor—

(1) To furnish said service on a fair, equal, and not unjustly discriminatory basis to all users thereof, and

(2) To charge fair, reasonable, and not unjustly discriminatory prices for each unit or service; *Provided*, That the contractor may be allowed to make reasonable and non-discriminatory discounts, rebates, or other similar types of price reductions to volume purchasers.

c. That it will not exercise or grant any right or privilege which would operate to prevent any person, firm or corporation operating aircraft on the Airport from performing any services on its own aircraft with its own employees (including, but not limited to maintenance and repair) that it may choose to perform.

d. In the event the Sponsor itself exercises any of the rights and privileges referred to in subsection b, the services involved will be provided on the same conditions as would apply to the furnishing of such services by contractors or concessionaires of the Sponsor under the provisions of such subsection b.

21. *Nonaviation activities.* Nothing contained herein shall be construed to prohibit the granting or exercise of an exclusive right for the furnishing of nonaviation products and supplies or any service of a nonaeronautical nature or to obligate the Sponsor to furnish

any particular nonaeronautical service at the Airport.

22. *Operation and maintenance of the airport.* The Sponsor will operate and maintain in a safe and serviceable condition the Airport and all facilities thereon and connected therewith which are necessary to serve the aeronautical users of the Airport other than facilities owned or controlled by the United States, and will not permit any activity thereon which would interfere with its use for airport purposes; *Provided*, That nothing contained herein shall be construed to require that the Airport be operated for aeronautical uses during temporary periods when snow, flood, or other climatic conditions interfere with such operation and maintenance; and *Provided further*, That nothing herein shall be construed as requiring the maintenance, repair, restoration or replacement of any structure or facility which is substantially damaged or destroyed due to an act of God or other condition or circumstance beyond the control of the Sponsor. In furtherance of this covenant the sponsor will have in effect at all times arrangements for—

- a. Operating the airport's aeronautical facilities whenever required;
- b. Promptly marking and lighting hazards resulting from airport conditions, including temporary conditions; and
- c. Promptly notifying airmen of any condition affecting aeronautical use of the Airport.

23. *Airport Hazards.* Insofar as it is within its power and reasonable, the Sponsor will, either by the acquisition and retention of easements or other interests in or rights for the use of land or airspace or by the adoption and enforcement of zoning regulations, prevent the construction, erection, alteration, or growth of any structure, tree, or other object in the approach areas of the runways of the Airport, which would constitute an airport hazard.

In addition, the Sponsor will not erect or permit the erection of any permanent structure or facility which would interfere materially with the use, operation, or future development of the Airport, in any portion of a runway approach area in which the Sponsor has acquired, or hereafter acquires, property interests permitting it to so control the use made of the surface of the land.

24. *Use of adjacent land.* Insofar as it is within its power and reasonable, the Sponsor will, either by the acquisition and retention of easements or other interests in or rights for the use of land or airspace or by the adoption and enforcement of zoning regulations, take action to restrict the use of land adjacent to or in the immediate vicinity of the Airport to activities and purposes compatible with normal airport operations including landing and takeoff of aircraft.

25. *Airport layout plan.* The Sponsor will keep up to date at all times an airport layout plan of the Airport showing (1) boundaries of the Airport and all proposed additions thereto, together with the boundaries of all offsite areas owned or controlled by the Sponsor for airport purposes, and proposed additions thereto; (2) the location and nature of all existing and proposed airport facilities and structures (such as runways, taxiways, aprons, terminal buildings, hangars and roads), including all proposed extensions and reductions of existing airport facilities; and (3) the location of all existing and proposed nonaviation areas and of all existing improvements thereon. Such airport layout plan and each amendment, revision, or modification thereof, shall be subject to the approval of the FAA, which approval shall be evidenced by the signature of a duly authorized representative of the FAA on the face of the airport layout plan. The Sponsor will not make or permit any changes or alterations in the airport or in any of its facilities other than in conformity with the airport layout plan as so approved by the FAA, if such changes or alterations might adversely affect the safety, utility, or efficiency of the Airport.

26. *Federal use of facilities.* All facilities of the Airport developed with Federal aid and all those usable for the landing and taking off of aircraft, will be available to the United States at all times, without charge, for use by government aircraft in common with other aircraft, except that if the use by government aircraft is substantial, a reasonable share, proportional to such use, of the cost of operating and maintaining facilities so used, may be charged. Unless otherwise determined by the FAA, or otherwise agreed to by the Sponsor and the using agency, substantial use of an airport by government aircraft will be considered to exist when operations of such aircraft are in excess of those which, in the opinion of the FAA, would unduly interfere with use of the landing area by other authorized aircraft, or during any calendar month that—

- a. Five (5) or more government aircraft are regularly based at the airport or on land adjacent thereto; or
- b. The total number of movements (counting each landing as a movement and each takeoff as a movement) of government aircraft is 300 or more, or the gross accumulative weight of government aircraft using the Airport (the total movements of government aircraft multiplied by gross certified weights of such aircraft) is in excess of five million pounds.

27. *Areas for FAA Use.* Whenever so requested by the FAA, the Sponsor will furnish without cost to the Federal Government, for construction, operation, and maintenance of facilities for air traffic control activities, or

weather reporting activities and communication activities related to air traffic control, such areas of land or water, or estate therein, or rights in buildings of the Sponsor as the FAA may consider necessary or desirable for construction at Federal expense of space or facilities for such purposes. The approximate amounts of areas and the nature of the property interests and/or rights so required will be set forth in the Grant Agreement relating to the project. Such areas or any portion thereof will be made available as provided herein within 4 months after receipt of written requests from the FAA.

28. *Fee and rental structure.* The airport operator or owner will maintain a fee and rental structure for the facilities and services being provided the airport users which will make the Airport as self-sustaining as possible under the circumstances existing at the Airport, taking into account such factors as the volume of traffic and economy of collection.

29. *Reports to FAA.* The Sponsor will furnish the FAA with such annual or special airport financial and operational reports as may be reasonably requested. Such reports may be submitted on forms furnished by the FAA, or may be submitted in such manner as the Sponsor elects so long as the essential data are furnished. The Airport and all airport records and documents affecting the Airport, including deeds, leases, operation and use agreements, regulations, and other instruments, will be made available of inspection and audit by the Secretary and the Comptroller General of the United States, or their duly authorized representatives, upon reasonable request. The Sponsor will furnish to the FAA or to the General Accounting Office, upon request, a true copy of any such document.

30. *System of accounting.* All project accounts and records will be kept in accordance with a standard system of accounting if so prescribed by the Secretary.

31. *Interfering right.* If at any time it is determined by the FAA that there is any outstanding right or claim of right in or to the Airport property, other than those set forth in Part II of the Application for Federal Assistance, the existence of which creates an undue risk of interference with the operation of the Airport or the performance of the covenants of this part, the sponsor will acquire, extinguish, or modify such right or claim of right in a manner acceptable to the FAA.

32. *Performance obligation.* The Sponsor will not enter into any transaction which would operate to deprive it of any of the rights and powers necessary to perform any or all of the covenants made herein, unless by such transaction the obligation to perform all such covenants is assumed by another public agency found by the FAA to be eligible under the Act and Regulations to assume such obligations and having the power, authority, and

financial resources to carry out all such obligations. If an arrangement is made for management or operation of the Airport by any agency or person other than the Sponsor or an employee of the Sponsor, the Sponsor will reserve sufficient rights and authority to insure that the Airport will be operated and maintained in accordance with the Act, the Regulations, and these covenants.

33. *Meaning of terms.* Unless the context otherwise requires, all terms used in these covenants which are defined in the Act and the Regulations shall have the meanings assigned to them therein.

B. *Airport Layout Plan Approval.* A sponsor seeking FAA approval of a new or revised airport layout plan shall submit with the plan an environmental assessment prepared in conformance with Appendix 6 of FAA Order 1050.1C, "Policies and Procedures for Considering Environmental Impacts" (45 FR 2244; January 10, 1980) and FAA Order 5050.4 "Airport Environmental Handbook" (45 FR 56622; August 25, 1980), if an assessment is required by Order 5050.4.

### III. Airport Planning

Each applicant for an airport planning grant shall submit the assurances numbered 1 (except for the phrase "and to finance and construct the proposed facilities"), 7, 9, 11 (except for the last sentence), and 12, 14, 15, 30, and 33 of Part II of this appendix.

(Airport and Airway Development Act of 1970, as amended (49 U.S.C. 1701 *et seq.*); sec. 1.47(f)(1) Regulations of the Office of the Secretary of Transportation (49 CFR 1.47(f) (1))

[Doc. No. 19430, 45 FR 34797, May 22, 1980, as amended by Amdt. 152-11, 45 FR 56622, Aug. 25, 1980]

## PART 155—RELEASE OF AIRPORT PROPERTY FROM SURPLUS PROPERTY DISPOSAL RESTRICTIONS

Sec.

155.1 Applicability.

155.3 Applicable law.

155.5 Property and releases covered by this part.

155.7 General policies.

155.9 Release from war or national emergency restrictions.

155.11 Form and content of requests for release.

155.13 Determinations by FAA.

AUTHORITY: 49 U.S.C. 106(g), 40113, 47151-47153.

SOURCE: Docket No. 1329, 27 FR 12361, Dec. 13, 1962, unless otherwise noted.

**§ 155.1 Applicability.**

This part applies to releases from terms, conditions, reservations, or restrictions in any deed, surrender of leasehold, or other instrument of transfer or conveyance (in this part called "instrument of disposal") by which some right, title, or interest of the United States in real or personal property was conveyed to a non-Federal public agency under section 13 of the Surplus Property Act of 1944 (58 Stat. 765; 61 Stat. 678) to be used by that agency in developing, improving, operating, or maintaining a public airport or to provide a source of revenue from non-aviation business at a public airport.

**§ 155.3 Applicable law.**

(a) Section 4 of the Act of October 1, 1949 (63 Stat. 700) authorizes the Administrator to grant the releases described in §155.1, if he determines that—

(1) The property to which the release relates no longer serves the purpose for which it was made subject to the terms, conditions, reservations, or restrictions concerned; or

(2) The release will not prevent accomplishing the purpose for which the property was made subject to the terms, conditions, reservations, or restrictions, and is necessary to protect or advance the interests of the United States in civil aviation.

In addition, section 4 of that Act authorizes the Administrator to grant the releases subject to terms and conditions that he considers necessary to protect or advance the interests of the United States in civil aviation.

(b) Section 2 of the Act of October 1, 1949 (63 Stat. 700) provides that the restrictions against using structures for industrial purposes in any instrument of disposal issued under section 13(g)(2)(A) of the Surplus Property Act of 1944, as amended (61 Stat. 678) are considered to be extinguished. In addition, section 2 authorizes the Administrator to issue any instruments of release or conveyance necessary to remove, of record, such a restriction, without monetary consideration to the United States.

(c) Section 68 of the Atomic Energy Act of 1954, as amended (42 U.S.C. 2098) releases, remises, and quitclaims, to persons entitled thereto, all reserved rights of the United States in radioactive minerals in instruments of disposal of public or acquired lands. In addition, section 3 of the Act of October 1, 1949 (50 U.S.C. App. 1622b) authorizes the Administrator to issue instruments that he considers necessary to correct any instrument of disposal by which surplus property was transferred to a non-Federal public agency for airport purposes or to conform the transfer to the requirements of applicable law. Based on the laws cited in this paragraph, the Administrator issues appropriate instruments of correction upon the written request of persons entitled to ownership, occupancy, or use of the lands concerned.

**§ 155.5 Property and releases covered by this part.**

This part applies to—

(a) Any real or personal property that is subject to the terms, conditions, reservations, or restrictions in an instrument of disposal described in §155.1; and

(b) Any release from a term, condition, reservation, or restriction in such an instrument, including a release of—

(1) Personal property, equipment, or structures from any term, condition, reservation, or restriction so far as necessary to allow it to be disposed of for salvage purposes;

(2) Land, personal property, equipment or structures from any term, condition, reservation, or restriction requiring that it be used for airport purposes to allow its use, lease, or sale for nonairport use in place;

(3) Land, personal property, equipment, or structures from any term, condition, reservation, or restriction requiring its maintenance for airport use;

(4) Land, personal property, equipment, or structures from all terms, conditions, restrictions, or reservations to allow its use, lease, sale, or other disposal for nonairport purposes; and

(5) Land, personal property, equipment, or structures from the reservation of right of use by the United

## § 155.7

States in time of war or national emergency, to facilitate financing the operation and maintenance or further development of a public airport.

### § 155.7 General policies.

(a) Upon a request under § 155.11, the Administrator issues any instrument that is necessary to remove, of record, any restriction against the use of property for industrial purposes that is in an instrument of disposal covered by this part.

(b) The Administrator does not issue a release under this part if it would allow the sale of the property concerned to a third party, unless the public agency concerned has obligated itself to use the proceeds from the sale exclusively for developing, improving, operating, or maintaining a public airport.

(c) Except for a release from a restriction against using property for industrial purposes, the Administrator does not issue a release under this part unless it is justified under § 155.3(a) (1) or (2).

(d) The Administrator may issue a release from the terms, conditions, reservations, or restrictions of an instrument of disposal subject to any other terms or conditions that he considers necessary to protect or advance the interests of the United States in civil aviation. Such a term or condition, including one regarding the use of proceeds from the sale of property, is imposed as a personal covenant or obligation of the public agency concerned rather than as a term or condition to the release or as a covenant running with the land, unless the Administrator determines that the purpose of the term or condition would be better achieved as a condition or covenant running with the land.

(e) A letter or other document issued by the Administrator that merely grants consent to or approval of a lease, or to the use of the property for other than the airport use contemplated by the instrument of disposal, does not otherwise release the property from the terms, conditions, reservations, or restrictions of the instrument of disposal.

## 14 CFR Ch. I (1-1-08 Edition)

### § 155.9 Release from war or national emergency restrictions.

(a) The primary purpose of each transfer of surplus airport property under section 13 of the Surplus Property Act of 1944 was to make the property available for public or civil airport needs. However, it was also intended to ensure the availability of the property transferred, and of the entire airport, for use by the United States during a war or national emergency, if needed. As evidence of this purpose, most instruments of disposal of surplus airport property reserved or granted to the United States a right of exclusive possession and control of the airport during a war or emergency, substantially the same as one of the following:

(1) That during the existence of any emergency declared by the President or the Congress, the Government shall have the right without charge except as indicated below to the full, unrestricted possession, control, and use of the landing area, building areas, and airport facilities or any part thereof, including any additions or improvements thereto made subsequent to the declaration of the airport property as surplus: *Provided, however,* That the Government shall be responsible during the period of such use for the entire cost of maintaining all such areas, facilities, and improvements, or the portions used, and shall pay a fair rental for the use of any installations or structures which have been added thereto without Federal aid.

(2) During any national emergency declared by the President or by Congress, the United States shall have the right to make exclusive or nonexclusive use and have exclusive or nonexclusive control and possession, without charge, of the airport at which the surplus property is located or used or of such portion thereof as it may desire: *Provided, however,* That the United States shall be responsible for the entire cost of maintaining such part of the airport as it may use exclusively, or over which it may have exclusive possession and control, during the period of such use, possession, or control and shall be obligated to contribute a reasonable share, commensurate with the use made by it, of the cost of maintenance of such property as it may use

nonexclusively or over which it may have nonexclusive control and possession: *Provided further*, That the United States shall pay a fair rental for its use, control, or possession, exclusively or nonexclusively, of any improvements to the airport made without U.S. aid.

(b) A release from the terms, conditions, reservations, or restrictions of an instrument of disposal that might prejudice the needs or interests of the armed forces, is granted only after consultation with the Department of Defense.

**§ 155.11 Form and content of requests for release.**

(a) A request for the release of surplus airport property from a term, condition, reservation, or restriction in an instrument of disposal need not be in any special form, but must be in writing and signed by an authorized official of the public agency that owns the airport.

(b) A request for a release under this part must be submitted in triplicate to the District Airport Engineer in whose district the airport is located.

(c) Each request for a release must include the following information, if applicable and available:

(1) Identification of the instruments of disposal to which the property concerned is subject.

(2) A description of the property concerned.

(3) The condition of the property concerned.

(4) The purpose for which the property was transferred, such as for use as a part of, or in connection with, operating the airport or for producing revenues from nonaviation business.

(5) The kind of release requested.

(6) The purpose of the release.

(7) A statement of the circumstances justifying the release on the basis set forth in §155.3(a) (1) or (2) with supporting documents.

(8) Maps, photographs, plans, or similar material of the airport and the property concerned that are appropriate to determining whether the release is justified under §155.9.

(9) The proposed use or disposition of the property, including the terms and

conditions of any proposed sale or lease and the status of negotiations therefor.

(10) If the release would allow sale of any part of the property, a certified copy of a resolution or ordinance of the governing body of the public agency that owns the airport obligating itself to use the proceeds of the sale exclusively for developing, improving, operating, or maintaining a public airport.

(11) A suggested letter or other instrument of release that would meet the requirements of State and local law for the release requested.

(12) The sponsor's environmental assessment prepared in conformance with Appendix 6 of FAA Order 1050.1C, "Policies and Procedures for Considering Environmental Impacts" (45 FR 2244; Jan. 10, 1980), and FAA Order 5050.4, "Airport Environmental Handbook" (45 FR 56624; Aug. 25, 1980), if an assessment is required by Order 5050.4. Copies of these orders may be examined in the Rules Docket, Office of the Chief Counsel, FAA, Washington, D.C., and may be obtained on request at any FAA regional office headquarters or any airports district office.

[Doc. No. 1329, 27 FR 12361, Dec. 13, 1962, as amended by Amdt. 155-1, 45 FR 56622, Aug. 25, 1980]

**§ 155.13 Determinations by FAA.**

(a) An FAA office that receives a request for a release under this part, and supporting documents therefore, examines it to determine whether the request meets the requirements of the Act of October 1, 1949 (63 Stat. 700) so far as it concerns the interests of the United States in civil aviation and whether it might prejudice the needs and interests of the armed forces. Upon a determination that the release might prejudice those needs and interests, the Department of Defense is consulted as provided in §155.9(b).

(b) Upon completing the review, and receiving the advice of the Department of Defense if the case was referred to it, the FAA advises the airport owner as to whether the release or a modification of it, may be granted. If the release, or a modification of it acceptable to the owner, is granted, the FAA prepares the necessary instruments and delivers them to the airport owner.

**PART 156—STATE BLOCK GRANT  
PILOT PROGRAM**

Sec.

- 156.1 Applicability.
- 156.2 Letters of interest.
- 156.3 Application and grant process.
- 156.4 Airport and project eligibility.
- 156.5 Project cost allowability.
- 156.6 State program responsibilities.
- 156.7 Enforcement of State block grant agreements and other related grant assurances.

AUTHORITY: 49 U.S.C. 106(g), 47101, 47128; 49 CFR 1.47(f), (k).

SOURCE: Docket No. 35723, 53 FR 41303, Oct. 20, 1988, unless otherwise noted.

**§ 156.1 Applicability.**

(a) This part applies to grant applicants for the State block grant pilot program and to those States receiving block grants available under the Airport and Airway Improvement Act of 1982, as amended.

(b) This part sets forth—

- (1) The procedures by which a State may apply to participate in the State block grant pilot program;
- (2) The program administration requirements for a participating State;
- (3) The program responsibilities for a participating State; and
- (4) The enforcement responsibilities of a participating State.

**§ 156.2 Letters of interest.**

(a) Any state that desires to participate in the State block grant pilot program shall submit a letter of interest, by November 30, 1988, to the Associate Administrator for Airports, Federal Aviation Administration, 800 Independence Avenue SW., Room 1000E, Washington, DC 20591.

(b) A State's letter of interest shall contain the name, title, address, and telephone number of the individual who will serve as the liaison with the Administrator regarding the State block grant pilot program.

(c) The FAA will provide an application form and program guidance material to each State that submits a letter of interest to the Associate Administrator for Airports.

**§ 156.3 Application and grant process.**

(a) A State desiring to participate shall submit a completed application to the Associate Administrator for Airports.

(b) After review of the applications submitted by the States, the Administrator shall select three States for participation in the State block grant pilot program.

(c) The Administrator shall issue a written grant offer that sets forth the terms and conditions of the State block grant agreement to each selected State.

(d) A State's participation in the State block grant pilot program begins when a State accepts the Administrator's written grant offer in writing and within any time limit specified by the Administrator. The State shall certify, in its written acceptance, that the acceptance complies with all applicable Federal and State law, that the acceptance constitutes a legal and binding obligation of the State, and that the State has the authority to carry out all the terms and conditions of the written grant offer.

**§ 156.4 Airport and project eligibility.**

(a) A participating State shall use monies distributed pursuant to a State block grant agreement for airport development and airport planning, for airport noise compatibility planning, or to carry out airport noise compatibility programs, in accordance with the Airport and Airway Improvement Act of 1982, as amended.

(b) A participating State shall administer the airport development and airport planning projects for airports within the State.

(c) A participating State shall not use any monies distributed pursuant to a State block grant agreement for integrated airport system planning, projects related to any primary airport, or any airports—

- (1) Outside the State's boundaries; or
- (2) Inside the State's boundaries that are not included in the National Plan of Integrated Airport Systems.

**§ 156.5 Project cost allowability.**

(a) A participating State shall not use State block grant funds for reimbursement of project costs that would

## Federal Aviation Administration, DOT

## § 157.2

not be eligible for reimbursement under a project grant administered by the FAA.

(b) A participating State shall not use State block grant funds for reimbursement or funding of administrative costs incurred by the State pursuant to the State block grant program.

### § 156.6 State program responsibilities.

(a) A participating State shall comply with the terms of the State block grant agreement.

(b) A participating State shall ensure that each person or entity, to which the State distributes funds received pursuant to the State block grant pilot program, complies with any terms that the State block grant agreement requires to be imposed on a recipient for airport projects funded pursuant to the State block grant pilot program.

(c) Unless otherwise agreed by a participating State and the Administrator in writing, a participating State shall not delegate or relinquish, either expressly or by implication, any State authority, rights, or power that would interfere with the State's ability to comply with the terms of a State block grant agreement.

### § 156.7 Enforcement of State block grant agreements and other related grant assurances.

The Administrator may take any action, pursuant to the authority of the Airport and Airway Improvement Act of 1982, as amended, to enforce the terms of a State block grant agreement including any terms imposed upon subsequent recipients of State block agreement funds.

## PART 157—NOTICE OF CONSTRUCTION, ALTERATION, ACTIVATION, AND DEACTIVATION OF AIRPORTS

Sec.

- 157.1 Applicability.
- 157.2 Definition of terms.
- 157.3 Projects requiring notice.
- 157.5 Notice of intent.
- 157.7 FAA determinations.
- 157.9 Notice of completion.

AUTHORITY: 49 U.S.C. 106(g), 40103, 40113, 44502.

SOURCE: Docket No. 25708, 56 FR 33996, July 24, 1991, unless otherwise noted.

### § 157.1 Applicability.

This part applies to persons proposing to construct, alter, activate, or deactivate a civil or joint-use (civil/military) airport or to alter the status or use of such an airport. Requirements for persons to notify the Administrator concerning certain airport activities are prescribed in this part. This part does not apply to projects involving:

(a) An airport subject to conditions of a Federal agreement that requires an approved current airport layout plan to be on file with the Federal Aviation Administration; or

(b) An airport at which flight operations will be conducted under visual flight rules (VFR) and which is used or intended to be used for a period of less than 30 consecutive days with no more than 10 operations per day.

(c) The intermittent use of a site that is not an established airport, which is used or intended to be used for less than one year and at which flight operations will be conducted only under VFR. For the purposes of this part, *intermittent use of a site* means:

(1) The site is used or is intended to be used for no more than 3 days in any one week; and

(2) No more than 10 operations will be conducted in any one day at that site.

### § 157.2 Definition of terms.

For the purpose of this part:

*Airport* means any airport, heliport, helistop, vertiport, gliderport, seaplane base, ultralight flightpark, manned balloon launching facility, or other aircraft landing or takeoff area.

*Heliport* means any landing or takeoff area intended for use by helicopters or other rotary wing type aircraft capable of vertical takeoff and landing profiles.

*Private use* means available for use by the owner only or by the owner and other persons authorized by the owner.

*Private use of public lands* means that the landing and takeoff area of the proposed airport is publicly owned and the proponent is a non-government entity, regardless of whether that landing and takeoff area is on land or on water and whether the controlling entity be local, State, or Federal Government.

### § 157.3

*Public use* means available for use by the general public without a requirement for prior approval of the owner or operator.

*Traffic pattern* means the traffic flow that is prescribed for aircraft landing or taking off from an airport, including departure and arrival procedures utilized within a 5-mile radius of the airport for ingress, egress, and noise abatement.

#### § 157.3 Projects requiring notice.

Each person who intends to do any of the following shall notify the Administrator in the manner prescribed in § 157.5:

(a) Construct or otherwise establish a new airport or activate an airport.

(b) Construct, realign, alter, or activate any runway or other aircraft landing or takeoff area of an airport.

(c) Deactivate, discontinue using, or abandon an airport or any landing or takeoff area of an airport for a period of one year or more.

(d) Construct, realign, alter, activate, deactivate, abandon, or discontinue using a taxiway associated with a landing or takeoff area on a public-use airport.

(e) Change the status of an airport from private use to public use or from public use to another status.

(f) Change any traffic pattern or traffic pattern altitude or direction.

(g) Change status from IFR to VFR or VFR to IFR.

#### § 157.5 Notice of intent.

(a) Notice shall be submitted on FAA Form 7480-1, copies of which may be obtained from an FAA Airport District/Field Office or Regional Office, to one of those offices and shall be submitted at least—

(1) In the cases prescribed in paragraphs (a) through (d) of § 157.3, 90 days in advance of the day that work is to begin; or

(2) In the cases prescribed in paragraphs (e) through (g) of § 157.3, 90 days in advance of the planned implementation date.

(b) Notwithstanding paragraph (a) of this section—

(1) In an emergency involving essential public service, public health, or public safety or when the delay arising

### 14 CFR Ch. I (1-1-08 Edition)

from the 90-day advance notice requirement would result in an unreasonable hardship, a proponent may provide notice to the appropriate FAA Airport District/Field Office or Regional Office by telephone or other expeditious means as soon as practicable in lieu of submitting FAA Form 7480-1. However, the proponent shall provide full notice, through the submission of FAA Form 7480-1, when otherwise requested or required by the FAA.

(2) notice concerning the deactivation, discontinued use, or abandonment of an airport, an airport landing or takeoff area, or associated taxiway may be submitted by letter. Prior notice is not required; except that a 30-day prior notice is required when an established instrument approach procedure is involved or when the affected property is subject to any agreement with the United States requiring that it be maintained and operated as a public-use airport.

#### § 157.7 FAA determinations.

(a) The FAA will conduct an aeronautical study of an airport proposal and, after consultations with interested persons, as appropriate, issue a determination to the proponent and advise those concerned of the FAA determination. The FAA will consider matters such as the effects the proposed action would have on existing or contemplated traffic patterns of neighboring airports; the effects the proposed action would have on the existing airspace structure and projected programs of the FAA; and the effects that existing or proposed manmade objects (on file with the FAA) and natural objects within the affected area would have on the airport proposal. While determinations consider the effects of the proposed action on the safe and efficient use of airspace by aircraft and the safety of persons and property on the ground, the determinations are only advisory. Except for an objectionable determination, each determination will contain a determination-void date to facilitate efficient planning of the use of the navigable airspace. A determination does not relieve the proponent of responsibility for compliance

with any local law, ordinance or regulation, or state or other Federal regulation. Aeronautical studies and determinations will not consider environmental or land use compatibility impacts.

(b) An airport determination issued under this part will be one of the following:

(1) *No objection.*

(2) *Conditional.* A conditional determination will identify the objectionable aspects of a project or action and specify the conditions which must be met and sustained to preclude an objectionable determination.

(3) *Objectionable.* An objectionable determination will specify the FAA's reasons for issuing such a determination.

(c) *Determination void date.* All work or action for which notice is required by this sub-part must be completed by the determination void date. Unless otherwise extended, revised, or terminated, an FAA determination becomes invalid on the day specified as the determination void date. Interested persons may, at least 15 days in advance of the determination void date, petition the FAA official who issued the determination to:

(1) Revise the determination based on new facts that change the basis on which it was made; or

(2) Extend the determination void date. Determinations will be furnished to the proponent, aviation officials of the state concerned, and, when appropriate, local political bodies and other interested persons.

#### **§ 157.9 Notice of completion.**

Within 15 days after completion of any airport project covered by this part, the proponent of such project shall notify the FAA Airport District Office or Regional Office by submission of FAA Form 5010-5 or by letter. A copy of FAA Form 5010-5 will be provided with the FAA determination.

## **PART 158—PASSENGER FACILITY CHARGES (PFC'S)**

### **Subpart A—General**

Sec.

- 158.1 Applicability.
- 158.3 Definitions.
- 158.5 Authority to impose PFC's.

- 158.7 Exclusivity of authority.
- 158.9 Limitations.
- 158.11 Public agency request not to require collection of PFC's by a class of air carriers or foreign air carriers or for service to isolated communities.
- 158.13 Use of PFC revenue.
- 158.15 Project eligibility at PFC levels of \$1, \$2, or \$3.
- 158.17 Project eligibility at PFC levels of \$4 or \$4.50.
- 158.18 Use of PFC revenue to pay for debt service for non-eligible projects.
- 158.19 Requirement for competition plans.
- 158.20 Submission of required documents.

### **Subpart B—Application and Approval**

- 158.21 General.
- 158.23 Consultation with air carriers and foreign air carriers.
- 158.24 Notice and opportunity for public comment.
- 158.25 Applications.
- 158.27 Review of applications.
- 158.29 The Administrator's decision.
- 158.30 PFC Authorization at Non-Hub Airports.
- 158.31 Duration of authority to impose a PFC after project implementation.
- 158.33 Duration of authority to impose a PFC before project implementation.
- 158.35 Extension of time to submit application to use PFC revenue.
- 158.37 Amendment of approved PFC.
- 158.39 Use of excess PFC revenue.

### **Subpart C—Collection, Handling, and Remittance of PFC's**

- 158.41 General.
- 158.43 Public agency notification to collect PFC's.
- 158.45 Collection of PFC's on tickets issued in the U.S.
- 158.47 Collection of PFC's on tickets issued outside the U.S.
- 158.49 Handling of PFC's.
- 158.51 Remittance of PFC's.
- 158.53 Collection compensation.

### **Subpart D—Reporting, Recordkeeping and Audits**

- 158.61 General.
- 158.63 Reporting requirements: Public agency.
- 158.65 Reporting requirements: Collecting air carriers.
- 158.67 Recordkeeping and auditing: Public agency.
- 158.69 Recordkeeping and auditing: Collecting carriers.
- 158.71 Federal oversight.

### **Subpart E—Termination**

- 158.81 General.

## § 158.1

- 158.83 Informal resolution.
- 158.85 Termination of authority to impose PFC's.
- 158.87 Loss of Federal airport grant funds.

### Subpart F—Reduction in Airport Improvement Program Apportionments

- 158.91 General.
- 158.93 Public agencies subject to reduction.
- 158.95 Implementation of reduction.

#### APPENDIX A TO PART 158—ASSURANCES

AUTHORITY: 49 U.S.C. 106(g), 40116–40117, 47106, 47111, 47114–47116, 47524, 47526.

SOURCE: Docket No. 26385, 56 FR 24278, May 29, 1991, unless otherwise noted.

### Subpart A—General

#### § 158.1 Applicability.

This part applies to passenger facility charges (PFC's) as may be approved by the Administrator of the Federal Aviation Administration (FAA) and imposed by a public agency that controls a commercial service airport. This part also describes the procedures for reducing funds to a large or medium hub airport that imposes a PFC.

[Doc. No. FAA-2000-7402, 65 FR 34540, May 30, 2000]

#### § 158.3 Definitions.

The following definitions apply in this part:

*Airport* means any area of land or water, including any heliport, that is used or intended to be used for the landing and takeoff of aircraft, and any appurtenant areas that are used or intended to be used for airport buildings or other airport facilities or rights-of-way, together with all airport buildings and facilities located thereon.

*Airport capital plan* means a capital improvement program that lists airport-related planning, development or noise compatibility projects expected to be accomplished with anticipated available funds.

*Airport layout plan (ALP)* means a plan showing the existing and proposed airport facilities and boundaries in a form prescribed by the Administrator.

*Airport revenue* means revenue generated by a public airport (1) through any lease, rent, fee, PFC or other charge collected, directly or indirectly, in connection with any aeronautical

## 14 CFR Ch. I (1–1–08 Edition)

activity conducted on an airport that it controls; or (2) In connection with any activity conducted on airport land acquired with Federal financial assistance, or with PFC revenue under this part, or conveyed to such public agency under the provisions of any Federal surplus property program or any provision enacted to authorize the conveyance of Federal property to a public agency for airport purposes.

*Air travel ticket* includes all documents, electronic records, boarding passes, and any other ticketing medium about a passenger's itinerary necessary to transport a passenger by air, including passenger manifests.

*Allowable cost* means the reasonable and necessary costs of carrying out an approved project including costs incurred prior to and subsequent to the approval to impose a PFC, and making payments for debt service on bonds and other indebtedness incurred to carry out such projects. Allowable costs include only those costs incurred on or after November 5, 1990. Costs of terminal development incurred after August 1, 1986, at an airport that did not have more than .25 percent of the total annual passenger boardings in the U.S. in the most recent calendar year for which data is available and at which total passenger boardings declined by at least 16 percent between calendar year 1989 and calendar year 1997 are allowable.

*Approved project* means a project for which the FAA has approved using PFC revenue under this part. The FAA may also approve specific projects contained in a single or multi-phased project or development described in an airport capital plan separately. This includes projects acknowledged by the FAA under § 158.30 of this part.

*Bond financing costs* means the costs of financing a bond and includes such costs as those associated with issuance, underwriting discount, original issue discount, capitalized interest, debt service reserve funds, initial credit enhancement costs, and initial trustee and paying agent fees.

*Charge effective date* means the date on which carriers are obliged to collect a PFC.

*Charge expiration date* means the date on which carriers are to cease to collect a PFC.

*Collecting carrier* means an issuing carrier or other carrier collecting a PFC, whether or not such carrier issues the air travel ticket.

*Collection* means the acceptance of payment of a PFC from a passenger.

*Commercial service airport* means a public airport that annually enplanes 2,500 or more passengers and receives scheduled passenger service of aircraft.

*Covered air carrier* means an air carrier that files for bankruptcy protection or has an involuntary bankruptcy proceeding started against it after December 12, 2003. An air carrier that is currently in compliance with PFC remittance requirements and has an involuntary bankruptcy proceeding commenced against it has 90 days from the date such proceeding was filed to obtain dismissal of the involuntary petition before becoming a covered air carrier. An air carrier ceases to be a covered air carrier when it emerges from bankruptcy protection.

*Covered airport* means a medium or large hub airport at which one or two air carriers control more than 50 percent of passenger boardings.

*Debt service* means payments for such items as principal and interest, sinking funds, call premiums, periodic credit enhancement fees, trustee and paying agent fees, coverage, and remarketing fees.

*Exclusive long-term lease or use agreement* means an exclusive lease or use agreement between a public agency and an air carrier or foreign air carrier with a term of 5 years or more.

*FAA Airports office* means a regional, district or field office of the Federal Aviation Administration that administers Federal airport-related matters.

*Financial need* means that a public agency cannot meet its operational or debt service obligations and does not have at least a 2-month capital reserve fund.

*Frequent flier award coupon* means a zero-fare award of air transportation that an air carrier or foreign air carrier provides to a passenger in exchange for accumulated travel mileage credits in a customer loyalty program, whether or not the term "frequent

flier" is used in the definition of that program. The definition of "frequent flier award coupon" does not extend to redemption of accumulated credits for awards of additional or upgraded service on trips for which the passenger has paid a published fare, "two-for-the-price-of-one" and similar marketing programs, or to air transportation purchased for a passenger by other parties.

*Ground support equipment* means service and maintenance equipment used at an airport to support aeronautical operations and related activities. Baggage tugs, belt loaders, cargo loaders, forklifts, fuel trucks, lavatory trucks, and pushback tractors are among the types of vehicles that fit this definition.

*Implementation of an approved project* means: (1) With respect to construction, issuance to a contractor of notice to proceed or the start of physical construction; (2) with respect to non-construction projects other than property acquisition, commencement of work by a contractor or public agency to carry out the statement of work; or (3) with respect to property acquisition projects, commencement of title search, surveying, or appraisal for a significant portion of the property to be acquired.

*Issuing carrier* means any air carrier or foreign air carrier that issues an air travel ticket or whose imprinted ticket stock is used in issuing such ticket by an agent.

*Medium or large hub airport* means a commercial service airport that has more than 0.25 percent of the total number of passenger boardings at all such airports in the U.S. for the prior calendar year, as determined by the Administrator.

*Non-hub airport* means a commercial service airport (as defined in 49 U.S.C. 47102) that has less than 0.05 percent of the passenger boardings in the U.S. in the prior calendar year on an aircraft in service in air commerce.

*Nonrevenue passenger* means a passenger receiving air transportation from an air carrier or foreign air carrier for which remuneration is not received by the air carrier or foreign air carrier as defined under Department of

## § 158.5

## 14 CFR Ch. I (1–1–08 Edition)

Transportation Regulations or as otherwise determined by the Administrator. Air carrier employees or others receiving air transportation against whom token service charges are levied are considered nonrevenue passengers. Infants for whom a token fare is charged are also considered nonrevenue passengers.

*Notice of intent (to impose or use PFC revenue)* means a notice under §158.30 from a public agency controlling a non-hub airport that it intends to impose a PFC and/or use PFC revenue. Except for §§158.25 through 30, “notice of intent” can be used interchangeably with “application.”

*One-way trip* means any trip that is not a round trip.

*Passenger enplaned* means a domestic, territorial or international revenue passenger enplaned in the States in scheduled or nonscheduled service on aircraft in intrastate, interstate, or foreign commerce.

*PFC* means a passenger facility charge covered by this part imposed by a public agency on passengers enplaned at a commercial service airport it controls.

*PFC administrative support costs* means the reasonable and necessary costs of developing a PFC application or amendment, issuing and maintaining the required PFC records, and performing the required audit of the public agency’s PFC account. These costs may include reasonable monthly financial account charges and transaction fees.

*Project* means airport planning, airport land acquisition or development of a single project, a multi-phased development program, (including but not limited to development described in an airport capital plan) or a new airport for which PFC financing is sought or approved under this part.

*Public agency* means a State or any agency of one or more States; a municipality or other political subdivision of a State; an authority created by Federal, State or local law; a tax-supported organization; an Indian tribe or pueblo that controls a commercial service airport; or for the purposes of this part, a private sponsor of an airport approved to participate in the

Pilot Program on Private Ownership of Airports.

*Round trip* means a trip on a complete air travel itinerary which terminates at the origin point.

*Significant business interest* means an air carrier or foreign air carrier that:

(1) Had no less than 1.0 percent of passenger boardings at that airport in the prior calendar year,

(2) Had at least 25,000 passenger boardings at the airport in that prior calendar year, or

(3) Provides scheduled service at that airport.

*State* means a State of the United States, the District of Columbia, the Commonwealth of Puerto Rico, the Virgin Islands, American Samoa, the Commonwealth of the Northern Mariana Islands, and Guam.

*Unliquidated PFC revenue* means revenue received by a public agency from collecting carriers but not yet used on approved projects.

[Doc. No. 26385, 56 FR 24278, May 29, 1991, as amended by Amdt. 158–2, 65 FR 34540, May 30, 2000; Amdt. 158–3, 70 FR 14934, Mar. 23, 2005; Amdt. 158–4, 72 FR 28847, May 23, 2007]

### § 158.5 Authority to impose PFC’s.

Subject to the provisions of this part, the Administrator may grant authority to a public agency that controls a commercial service airport to impose a PFC of \$1, \$2, \$3, \$4, or \$4.50 on passengers enplaned at such an airport. No public agency may impose a PFC under this part unless authorized by the Administrator. No State or political subdivision or agency thereof that is not a public agency may impose a PFC covered by this part.

[Doc. No. 26385, 56 FR 24278, May 29, 1991, as amended by Amdt. 158–2, 65 FR 34541, May 30, 2000]

### § 158.7 Exclusivity of authority.

(a) A State, political subdivision of a State, or authority of a State or political subdivision that is not the eligible public agency may not tax, regulate, prohibit, or otherwise attempt to control in any manner the imposition or collection of a PFC or the use of PFC revenue.

(b) No contract or agreement between an air carrier or foreign air carrier and a public agency may impair

the authority of such public agency to impose a PFC or use the PFC revenue in accordance with this part.

[Doc. No. 26385, 56 FR 24278, May 29, 1991, as amended by Amdt. 158-2, 65 FR 34541, May 30, 2000]

#### § 158.9 Limitations.

(a) No public agency may impose a PFC on any passenger—

(1) For more than 2 boardings on a one-way trip or in each direction of a round trip;

(2) On any flight to an eligible point on an air carrier that receives essential air service compensation on that route. The Administrator makes available a list of carriers and eligible routes determined by the Department of Transportation for which PFC's may not be imposed under this section;

(3) Who is a nonrevenue passenger or obtained the ticket for air transportation with a frequent flier award coupon;

(4) On flights, including flight segments, between 2 or more points in Hawaii;

(5) In Alaska aboard an aircraft having a certificated seating capacity of fewer than 60 passengers; or

(6) Enplaning at an airport if the passenger did not pay for the air transportation that resulted in the enplanement due to Department of Defense charter arrangements and payments.

(b) No public agency may require a foreign airline that does not serve a point or points in the U.S. to collect a PFC from a passenger.

[Doc. No. 26385, 56 FR 24278, May 29, 1991, as amended by Amdt. 158-2, 65 FR 34541, May 30, 2000; Amdt. 158-4, 72 FR 28847, May 23, 2007]

#### § 158.11 Public agency request not to require collection of PFC's by a class of air carriers or foreign air carriers or for service to isolated communities.

(a) Subject to the requirements of this part, a public agency may request that collection of PFC's not be required for—

(1) Passengers enplaned by any class of air carrier or foreign air carrier if the number of passengers enplaned by the carriers in the class constitutes not more than one percent of the total

number of passengers enplaned annually at the airport at which the fee is imposed; or

(2) Passengers enplaned on a flight to an airport—

(i) That has fewer than 2,500 passenger boardings each year and receives scheduled passenger service; or

(ii) In a community that has a population of less than 10,000 and is not connected by a land highway or vehicular way to the land-connected National Highway System within a State.

(b) The public agency may request this exclusion authority under paragraph (a)(1) or (a)(2) of this section or both.

[Doc. No. FAA-2000-7402, 65 FR 34541, May 30, 2000]

#### § 158.13 Use of PFC revenue.

PFC revenue, including any interest earned after such revenue has been remitted to a public agency, may be used only to finance the allowable costs of approved projects at any airport the public agency controls.

(a) *Total cost.* PFC revenue may be used to pay all or part of the allowable cost of an approved project.

(b) *PFC administrative support costs.* Public agencies may use PFC revenue to pay for allowable administrative support costs. Public agencies must submit these costs as a separate project in each PFC application.

(c) *Maximum cost for certain low-emission technology projects.* If a project involves a vehicle or ground support equipment using low emission technology eligible under §158.15(b), the FAA will determine the maximum cost that may be financed by PFC revenue. The maximum cost for a new vehicle is the incremental amount between the purchase price of a new low emission vehicle and the purchase price of a standard emission vehicle, or the cost of converting a standard emission vehicle to a low emission vehicle.

(d) *Bond-associated debt service and financing costs.* (1) Public agencies may use PFC revenue to pay debt service and financing costs incurred for a bond issued to carry out approved projects.

(2) If the public agency's bond documents require that PFC revenue be commingled in the general revenue stream of the airport and pledged for

**§ 158.15**

**14 CFR Ch. I (1-1-08 Edition)**

the benefit of holders of obligations, the FAA considers PFC revenue to have paid the costs covered in §158.13(d)(1) if—

(i) An amount equal to the part of the proceeds of the bond issued to carry out approved projects is used to pay allowable costs of such projects; and

(ii) To the extent the PFC revenue collected in any year exceeds the debt service and financing costs on such bonds during that year, an amount equal to the excess is applied as required by §158.39.

(e) *Exception providing for the use of PFC revenue to pay for debt service for non-eligible projects.* The FAA may authorize a public agency under §158.18 to impose a PFC for payments for debt service on indebtedness incurred to carry out an airport project that is not eligible if the FAA determines that such use is necessary because of the financial need of the airport.

(f) *Combination of PFC revenue and Federal grant funds.* A public agency may combine PFC revenue and airport grant funds to carry out an approved project. These projects are subject to the record keeping and auditing requirements of this part, as well as the reporting, record keeping and auditing requirements imposed by the Airport and Airway Improvement Act of 1982 (AAIA).

(g) *Non-Federal share.* Public agencies may use PFC revenue to meet the non-Federal share of the cost of projects funded under the Federal airport grant program or the FAA “Program to Permit Cost-Sharing of Air Traffic Modernization Projects” under 49 U.S.C. 44517.

(h) *Approval of project following approval to impose a PFC.* The public agency may not use PFC revenue or interest earned thereon except on an approved project.

[Docket No. 26385, 56 FR 24278, May 29, 1991, as amended by Amdt. 158-4, 72 FR 28847, May 23, 2007]

**§ 158.15 Project eligibility at PFC levels of \$1, \$2, or \$3.**

(a) To be eligible, a project must—

(1) Preserve or enhance safety, security, or capacity of the national air transportation system;

(2) Reduce noise or mitigate noise impacts resulting from an airport; or

(3) Furnish opportunities for enhanced competition between or among air carriers.

(b) Eligible projects are any of the following projects—

(1) Airport development eligible under subchapter I of chapter 471 of 49 U.S.C.;

(2) Airport planning eligible under subchapter I of chapter 471 of 49 U.S.C.;

(3) Terminal development as described in 49 U.S.C. 47110(d);

(4) Airport noise compatibility planning as described in 49 U.S.C. 47505;

(5) Noise compatibility measures eligible for Federal assistance under 49 U.S.C. 47504, without regard to whether the measures are approved under 49 U.S.C. 47504;

(6) Construction of gates and related areas at which passengers are enplaned or deplaned and other areas directly related to the movement of passengers and baggage in air commerce within the boundaries of the airport. These areas do not include restaurants, car rental and automobile parking facilities, or other concessions. Projects required to enable added air service by an air carrier with less than 50 percent of the annual passenger boardings at an airport have added eligibility. Such projects may include structural foundations and floor systems, exterior building walls and load-bearing interior columns or walls, windows, door and roof systems, building utilities (including heating, air conditioning, ventilation, plumbing, and electrical service), and aircraft fueling facilities next to the gate;

(7) A project approved under the FAA’s “Program to Permit Cost-Sharing of Air Traffic Modernization Projects” under 49 U.S.C. 44517; or

(8) If the airport is in an air quality nonattainment area (as defined by section 171(2) of the Clean Air Act (42 U.S.C. 7501(2))) or a maintenance area referred to in section 175A of such Act (42 U.S.C. 7505a), and the project will result in the airport receiving appropriate emission credits as described in 49 U.S.C. 47139, a project for:

(i) Converting vehicles eligible under §158.15(b)(1) and ground support equipment powered by a diesel or gasoline

## Federal Aviation Administration, DOT

## § 158.20

engine used at a commercial service airport to low-emission technology certified or verified by the Environmental Protection Agency to reduce emissions or to use cleaner burning conventional fuels; or

(ii) Acquiring for use at a commercial service airport vehicles eligible under §158.15(b)(1) and, subject to §158.13(c), ground support equipment that include low-emission technology or use cleaner burning fuels.

(c) An eligible project must be adequately justified to qualify for PFC funding.

[Doc. No. 26385, 56 FR 24278, May 29, 1991; 56 FR 37127, Aug. 2, 1991; Amdt. 158-2, 65 FR 34541, May 30, 2000; Amdt. 158-4, 72 FR 28848, May 23, 2007]

### § 158.17 Project eligibility at PFC levels of \$4 or \$4.50.

(a) A project for any airport is eligible for PFC funding at levels of \$4 or \$4.50 if—

(1) The project meets the eligibility requirements of §158.15;

(2) The project costs requested for collection at \$4 or \$4.50 cannot be paid for from funds reasonably expected to be available for the programs referred to in 49 U.S.C. 48103; and

(3) In the case of a surface transportation or terminal project, the public agency has made adequate provision for financing the airside needs of the airport, including runways, taxiways, aprons, and aircraft gates.

(b) In addition, a project for a medium or large airport is only eligible for PFC funding at levels of \$4 or \$4.50 if the project will make a significant contribution to improving air safety and security, increasing competition among air carriers, reducing current or anticipated congestion, or reducing the impact of aviation noise on people living near the airport.

[Doc. No. FAA-2000-7402, 65 FR 34541, May 30, 2000]

### § 158.18 Use of PFC revenue to pay for debt service for non-eligible projects.

(a) The FAA may authorize a public agency to impose a PFC to make payments for debt service on indebtedness incurred to carry out at the airport a project that is not eligible if the FAA

determines it is necessary because of the financial need of the airport. The FAA defines financial need in §158.3.

(b) A public agency may request authority to impose a PFC and use PFC revenue under this section using the PFC application procedures in §158.25. The public agency must document its financial position and explain its financial recovery plan that uses all available resources.

(c) The FAA reviews the application using the procedures in §158.27. The FAA will issue its decision on the public agency's request under §158.29.

[Doc. No. FAA-2006-23730, 72 FR 28848, May 23, 2007]

### § 158.19 Requirement for competition plans.

(a) Beginning in fiscal year 2001, no public agency may impose a PFC with respect to a covered airport unless the public agency has submitted a written competition plan. This requirement does not apply to PFC authority approved prior to April 5, 2000.

(b) The Administrator will review any plan submitted under paragraph (a) of this section to ensure that it meets the requirements of 49 U.S.C. 47106(f) and periodically will review its implementation to ensure that each covered airport successfully implements its plan.

[Doc. No. FAA-2000-7402, 65 FR 34541, May 30, 2000]

## Subpart B—Application and Approval

### § 158.20 Submission of required documents.

(a) Letters and reports required by this part may be transmitted to the appropriate recipient (the public agency, air carrier, and/or the FAA) via e-mail, courier, facsimile, or U.S. Postal Service.

(1) Documents sent electronically to the FAA must be prepared in a format readable by the FAA. Interested parties can obtain the format at their local FAA Airports Office.

(2) Any transmission to FAA Headquarters, using regular U.S. Postal Service, is subject to inspection that

## § 158.21

may result in delay and damage due to the security process.

(b) Once the database development is completed with air carrier capability, public agencies and air carriers may use the FAA's national PFC database to post their required quarterly reports, and, in that case, do not have to distribute the reports in any other way.

[Doc. No. FAA-2006-23730, 72 FR 28848, May 23, 2007]

### § 158.21 General.

This subpart specifies the consultation and application requirements under which a public agency may obtain approval to impose a PFC and use PFC revenue on a project. This subpart also establishes the procedure for the Administrator's review and approval of applications and amendments and establishes requirements for use of excess PFC revenue.

### § 158.23 Consultation with air carriers and foreign air carriers.

(a) *Notice by public agency.* A public agency must provide written notice to air carriers and foreign air carriers having a significant business interest at the airport where the PFC is proposed. A public agency must provide this notice before the public agency files an application with the FAA for authority to impose a PFC under § 158.25(b). In addition, public agencies must provide this notice before filing an application with the FAA for authority to use PFC revenue under § 158.25(c). Public agencies must also provide this notice before filing a notice of intent to impose and/or use a PFC under § 158.30. Finally, a public agency must provide this notice before filing a request to amend the FAA's decision with respect to an approved PFC as discussed in § 158.37(b)(1). The notice shall include:

- (1) Descriptions of projects being considered for funding by PFC's;
- (2) The PFC level for each project, the proposed charge effective date, the estimated charge expiration date, and the estimated total PFC revenue;
- (3) For a request by a public agency that any class or classes of carriers not be required to collect the PFC—

## 14 CFR Ch. I (1-1-08 Edition)

(i) The designation of each such class,

(ii) The names of the carriers belonging to each such class, to the extent the names are known,

(iii) The estimated number of passengers enplaned annually by each such class, and

(iv) The public agency's reasons for requesting that carriers in each such class not be required to collect the PFC; and

(4) Except as provided in § 158.25(c)(2), the date and location of a meeting at which the public agency will present such projects to air carriers and foreign air carriers operating at the airport.

(b) *Meeting.* The meeting required by paragraph (a)(4) of this section shall be held no sooner than 30 days nor later than 45 days after issuance of the written notice required by paragraph (a) of this section. At or before the meeting, the public agency shall provide air carriers and foreign air carriers with—

- (1) A description of projects;
- (2) An explanation of the need for the projects; and

(3) A detailed financial plan for the projects, including—

(i) The estimated allowable project costs allocated to major project elements;

(ii) The anticipated total amount of PFC revenue that will be used to finance the projects; and

(iii) The source and amount of other funds, if any, needed to finance the projects.

(c) *Requirements of air carriers and foreign air carriers.* (1) Within 30 days following issuance of the notice required by paragraph (a) of this section, each carrier must provide the public agency with a written acknowledgement that it received the notice.

(2) Within 30 days following the meeting, each carrier must provide the public agency with a written certification of its agreement or disagreement with the proposed project. A certification of disagreement shall contain the reasons for such disagreement. The absence of such reasons shall void a certification of disagreement.

(3) If a carrier fails to provide the public agency with timely acknowledgement of the notice or timely certification of agreement or disagreement with the proposed project, the carrier is considered to have certified its agreement.

[Doc. No. 26385, 56 FR 24278, May 29, 1991, as amended by Amdt. 158-2, 65 FR 34541, May 30, 2000; Amdt. 158-3, 70 FR 14934, Mar. 23, 2005]

**§ 158.24 Notice and opportunity for public comment.**

(a)(1) *Notice by public agency.* A public agency must provide written notice and an opportunity for public comment before:

(i) Filing an application with the FAA for authority to impose a PFC under § 158.25(b);

(ii) Filing an application with the FAA for authority to use PFC revenue under § 158.25(c);

(iii) Filing a notice of intent to impose and/or use a PFC under § 158.30; and

(iv) Filing a request to amend a previously approved PFC as discussed in § 158.37(b)(1).

(2) The notice must allow the public to file comments for at least 30 days, but no more than 45 days, after the date of publication of the notice or posting on the public agency's Web site, as applicable.

(b)(1) *Notice contents.* The notice required by § 158.24(a) must include:

(i) A description of the project(s) the public agency is considering for funding by PFC's;

(ii) A brief justification for each project the public agency is considering for funding by PFC's;

(iii) The PFC level for each project;

(iv) The estimated total PFC revenue the public agency will use for each project;

(v) The proposed charge effective date for the application or notice of intent;

(vi) The estimated charge expiration date for the application or notice of intent;

(vii) The estimated total PFC revenue the public agency will collect for the application or notice of intent; and

(viii) The name of and contact information for the person within the public

agency to whom comments should be sent.

(2) The public agency must make available a more detailed project justification or the justification documents to the public upon request.

(c) *Distribution of notice.* The public agency must make the notice available to the public and interested agencies through one or more of the following methods:

(1) Publication in local newspapers of general circulation;

(2) Publication in other local media;

(3) Posting the notice on the public agency's Internet Web site; or

(4) Any other method acceptable to the Administrator.

[Doc. No. FAA-2004-17999, 70 FR 14934, Mar. 23, 2005]

**§ 158.25 Applications.**

(a) *General.* This section specifies the information the public agency must file when applying for authority to impose a PFC and for authority to use PFC revenue on a project. A public agency may apply for such authority at any commercial service airport it controls. The public agency must use the proposed PFC to finance airport-related projects at that airport or at any existing or proposed airport that the public agency controls. A public agency may apply for authority to impose a PFC before or concurrent with an application to use PFC revenue. If a public agency chooses to apply, it must do so by using FAA Form 5500-1, PFC Application (latest edition) and all applicable Attachments. The public agency must provide the information required under paragraphs (b) or (c), or both, of this section.

(b) *Application for authority to impose a PFC.* This paragraph sets forth the information to be submitted by all public agencies seeking authority to impose a PFC. A separate application shall be submitted for each airport at which a PFC is to be imposed. The application shall be signed by an authorized official of the public agency, and, unless otherwise authorized by the Administrator, must include the following:

(1) The name and address of the public agency.

**§ 158.25**

**14 CFR Ch. I (1–1–08 Edition)**

(2) The name and telephone number of the official submitting the application on behalf of the public agency.

(3) The official name of the airport at which the PFC is to be imposed.

(4) The official name of the airport at which a project is proposed.

(5) A copy of the airport capital plan or other documentation of planned improvements for each airport at which a PFC financed project is proposed.

(6) A description of each project proposed.

(7) The project justification, including the extent to which the project achieves one or more of the objectives set forth in §158.15(a) and (if a PFC level above \$3 is requested) the requirements of §158.17. In addition—

(i) For any project for terminal development, including gates and related areas, the public agency shall discuss any existing conditions that limit competition between and among air carriers and foreign air carriers at the airport, any initiatives it proposes to foster opportunities for enhanced competition between and among such carriers, and the expected results of such initiatives; or

(ii) For any terminal development project at a covered airport, the public agency shall submit a competition plan in accordance with §158.19.

(8) The charge to be imposed for each project.

(9) The proposed charge effective date.

(10) The estimated charge expiration date.

(11) Information on the consultation with air carriers and foreign air carriers having a significant business interest at the airport and the public comment process, including:

(i) A list of such carriers and those notified;

(ii) A list of carriers that acknowledged receipt of the notice provided under §158.23(a);

(iii) Lists of carriers that certified agreement and that certified disagreement with the project;

(iv) Information on which method under §158.24(b) the public agency used to meet the public notice requirement; and

(v) A summary of substantive comments by carriers contained in any cer-

tifications of disagreement with each project and disagreements with each project provided by the public, and the public agency's reasons for continuing despite such disagreements.

(12) If the public agency is also filing a request under §158.11—

(i) The request;

(ii) A copy of the information provided to the carriers under §158.23(a)(3);

(iii) A copy of the carriers' comments with respect to such information;

(iv) A list of any class or classes of carriers that would not be required to collect a PFC if the request is approved; and

(v) The public agency's reasons for submitting the request in the face of opposing comments.

(13) A copy of information regarding the financing of the project presented to the carriers and foreign air carriers under §158.23 of this part and as revised during the consultation.

(14) A copy of all comments received as a result of the carrier consultation and public comment processes.

(15) For an application not accompanied by a concurrent application for authority to use PFC revenue:

(i) A description of any alternative methods being considered by the public agency to accomplish the objectives of the project;

(ii) A description of alternative uses of the PFC revenue to ensure such revenue will be used only on eligible projects in the event the proposed project is not ultimately approved for use of PFC revenue;

(iii) A timetable with projected dates for completion of project formulation activities and submission of an application to use PFC revenue; and

(iv) A projected date of project implementation and completion.

(16) A signed statement certifying that the public agency will comply with the assurances set forth in Appendix A to this part.

(17) Such additional information as the Administrator may require.

(c) *Application for authority to use PFC revenue.* A public agency may use PFC revenue only for projects approved under this paragraph. This paragraph sets forth the information that a public agency shall submit, unless otherwise authorized by the Administrator, when

applying for the authority to use PFC revenue to finance specific projects.

(1) An application submitted concurrently with an application for the authority to impose a PFC, must include:

(i) The information required under paragraphs (b)(1) through (15) of this section;

(ii) An FAA Form 5500-1, Attachment G, Airport Layout Plan, Airspace, and Environmental Findings (latest edition) providing the following information:

(A) For projects required to be shown on an ALP, the ALP depicting the project has been approved by the FAA and the date of such approval;

(B) All environmental reviews required by the National Environmental Policy Act (NEPA) of 1969 have been completed and a copy of the final FAA environmental determination with respect to the project has been approved, and the date of such approval, if such determination is required; and

(C) The final FAA airspace determination with respect to the project has been completed, and the date of such determination, if an airspace study is required.

(iii) The information required by §§ 158.25(b)(16) and 158.25(b)(17).

(2) An application where the authority to impose a PFC has been previously approved:

(i) Must not be filed until the public agency conducts further consultation with air carriers and foreign air carriers under § 158.23. However, the meeting required under § 158.23(a)(4) is optional if there are no changes to the projects after approval of the impose authority and further opportunity for public comment under § 158.24; and

(ii) Must include a summary of further air carrier consultation and the public agency's response to any disagreements submitted under the air carrier consultation and public comment processes conducted under paragraph (c)(2)(i) of this section;

(iii) Must include the following, updated and changed where appropriate:

(A) FAA Form 5500-1 without attachments except as required below;

(B) For any projects where there have been no changes since the FAA approved authority to impose a PFC for those projects, a list of projects in-

cluded in this application for use authority. The FAA will consider the information on these projects, filed with the impose authority application, incorporated by reference; and

(C) For any project that has changed since receiving impose authority, the public agency must file an Attachment B for that project clearly describing the changes to the project.

(iv) An FAA Form 5500-1, Attachment G, Airport Layout Plan, Airspace, and Environmental Findings (latest edition) providing the following information:

(A) For projects required to be shown on an ALP, the ALP depicting the project has been approved by the FAA and the date of such approval;

(B) All environmental reviews required by the National Environmental Policy Act (NEPA) of 1969 have been completed and a copy of the final FAA environmental determination with respect to the project has been approved, and the date of such approval, if such determination is required; and

(C) The final FAA airspace determination with respect to the project has been completed, and the date of such determination, if an airspace study is required; and

(v) The information required by §§ 158.25(b)(16) and 158.25(b)(17).

[Doc. No. FAA-2004-17999, 70 FR 14935, Mar. 23, 2005]

#### § 158.27 Review of applications.

(a) *General.* This section describes the process for review of all applications filed under § 158.25 of this part.

(b) *Determination of completeness.* Within 30 days after receipt of an application by the FAA Airports office, the Administrator determines whether the application substantially complies with the requirements of § 158.25.

(c) *Process for substantially complete application.* If the Administrator determines the application is substantially complete, the following procedures apply:

(1) The Administrator advises the public agency by letter that its application is substantially complete.

(2) The Administrator may opt to publish a notice in the FEDERAL REGISTER advising that the Administrator intends to rule on the application and

inviting public comment, as set forth in paragraph (e) of this section. If the Administrator publishes a notice, the Administrator will provide a copy of the notice to the public agency.

(3) If the Administrator publishes a notice, the public agency—

(i) Shall make available for inspection, upon request, a copy of the application, notice, and other documents germane to the application, and

(ii) May publish the notice in a newspaper of general circulation in the area where the airport covered by the application is located.

(4) After reviewing the application and any public comments received from a FEDERAL REGISTER notice, the Administrator issues a final decision approving or disapproving the application, in whole or in part, before 120 days after the FAA Airports office received the application.

(d) *Process for applications not substantially complete.* If the Administrator determines an application is not substantially complete, the following procedures apply:

(1) The Administrator notifies the public agency in writing that its application is not substantially complete. The notification will list the information required to complete the application.

(2) Within 15 days after the Administrator sends such notification, the public agency shall advise the Administrator in writing whether it intends to supplement its application.

(3) If the public agency declines to supplement the application, the Administrator follows the procedures for review of an application set forth in paragraph (c) of this section and issues a final decision approving or disapproving the application, in whole or in part, no later than 120 days after the application was received by the FAA Airports office.

(4) If the public agency supplements its application, the original application is deemed to be withdrawn for purposes of applying the statutory deadline for the Administrator's decision. Upon receipt of the supplement, the Administrator issues a final decision approving or disapproving the supplemented application, in whole or in part, no later

than 120 days after the supplement was received by the FAA Airports office.

(e) *The Federal Register notice.* The FEDERAL REGISTER notice includes the following information:

(1) The name of the public agency and the airport at which the PFC is to be imposed;

(2) A brief description of the PFC project, the level of the proposed PFC, the proposed charge effective date, the proposed charge expiration date and the total estimated PFC revenue;

(3) The address and telephone number of the FAA Airports office at which the application may be inspected;

(4) The Administrator's determination on whether the application is substantially complete and any information required to complete the application; and

(5) The due dates for any public comments.

(f) *Public comments.* (1) Interested persons may file comments on the application within 30 days after publication of the Administrator's notice in the FEDERAL REGISTER.

(2) Three copies of these comments shall be submitted to the FAA Airports office identified in the FEDERAL REGISTER notice.

(3) Commenters shall also provide one copy of their comments to the public agency.

(4) Comments from air carriers and foreign air carriers may be in the same form as provided to the public agency under § 158.23.

[Doc. No. 26385, 56 FR 24278, May 29, 1991; 56 FR 30867, July 8, 1991, as amended by Amdt. 158-3, 70 FR 14936, Mar. 23, 2005]

#### § 158.29 The Administrator's decision.

(a) *Authority to impose a PFC.* (1) An application to impose a PFC will be approved in whole or in part only after a determination that—

(i) The amount and duration of the PFC will not result in revenue that exceeds amounts necessary to finance the project;

(ii) The project will achieve the objectives and criteria set forth in § 158.15 except for those projects approved under § 158.18.

(iii) If a PFC level above \$3 is being approved, the project meets the criteria set forth in § 158.17;

(iv) The collection process, including any request by the public agency not to require a class of carriers to collect PFC's, is reasonable, not arbitrary, nondiscriminatory, and otherwise in compliance with the law;

(v) The public agency has not been found to be in violation of 49 U.S.C. 47524 and 47526;

(vi) The public agency has not been found to be in violation of 49 U.S.C. 47107(b) governing the use of airport revenue;

(vii) If the public agency has not applied for authority to use PFC revenue, a finding that there are alternative uses of the PFC revenue to ensure that such revenue will be used on approved projects; and

(viii) If applicable, the public agency has submitted a competition plan in accordance with § 158.19.

(2) The Administrator notifies the public agency in writing of the decision on the application. The notification will list the projects and alternative uses that may qualify for PFC financing under § 158.15, and (if a PFC level above \$3 is being approved) § 158.17, PFC level, total approved PFC revenue including the amounts approved at \$3 and less, \$4, and/or \$4.50, duration of authority to impose and earliest permissible charge effective date.

(b) *Authority to use PFC revenue on an approved project.* (1) An application for authority to use PFC revenue will be approved in whole or in part only after a determination that—

(i) The amount and duration of the PFC will not result in revenue that exceeds amounts necessary to finance the project;

(ii) The project will achieve the objectives and criteria set forth in § 158.15 except for those projects approved under § 158.18.

(iii) If a PFC level above \$3 is being approved, the project meets the criteria set forth in § 158.17; and

(iv) All applicable requirements pertaining to the ALP for the airport, airspace studies for the project, and the National Environmental Policy Act of 1969 (NEPA), have been satisfied.

(2) The Administrator notifies the public agency in writing of the decision on the application. The notification will list the approved projects, PFC

level, total approved PFC revenue, total approved for collection, including the amounts approved at \$3 and less, \$4, and/or \$4.50, and any limit on the duration of authority to impose a PFC as prescribed under § 158.33.

(3) Approval to use PFC revenue to finance a project shall be construed as approval of that project.

(c) *Disapproval of application.* (1) If an application is disapproved, the Administrator notifies the public agency in writing of the decision and the reasons for the disapproval.

(2) A public agency reapplying for approval to impose or use a PFC must comply with §§ 158.23, 158.24, and 158.25.

(d) The Administrator publishes a monthly notice of PFC approvals and disapprovals in the FEDERAL REGISTER.

[Doc. No. 26385, 56 FR 24278, May 29, 1991; 56 FR 30867, July 8, 1991, as amended by Amdt. 158-2, 65 FR 34542, May 30, 2000; Amdt. 158-3, 70 FR 14936, Mar. 23, 2005; Amdt. 158-4, 72 FR 28848, May 23, 2007]

### § 158.30 PFC Authorization at Non-Hub Airports.

(a) *General.* This section specifies the procedures a public agency controlling a non-hub airport must follow when notifying the FAA of its intent to impose a PFC and to use PFC revenue on a project under this section. In addition, this section describes the FAA's rules for reviewing and acknowledging a notice of intent filed under this section. A public agency may notify the FAA of its intent to impose a PFC before or concurrent with a notice of intent to use PFC revenue. A public agency must file a notice of intent in the manner and form prescribed by the Administrator and must include the information required under paragraphs (b), (c), or both, of this section.

(b) *Notice of intent to impose a PFC.* This paragraph sets forth the information a public agency must file to notify the FAA of its intent to impose a PFC under this section. The public agency must file a separate notice of intent for each airport at which the public agency plans on imposing a PFC. An authorized official of the public agency must sign the notice of intent and, unless authorized by the Administrator, must include:

## § 158.30

## 14 CFR Ch. I (1–1–08 Edition)

(1) A completed FAA Form 5500–1, PFC Application (latest edition) without attachments except as required below;

(2) Project information (in the form and manner prescribed by the FAA) including the project title, PFC funds sought, PFC level sought, and, if an existing Airport Improvement Program (AIP) grant already covers this project, the grant agreement number.

(3) If an existing AIP grant does not cover this project, the notice of intent must include the information in paragraph (b)(2) of this section as well as the following:

(i) Additional information describing the proposed schedule for the project,

(ii) A description of how this project meets one of the PFC objectives in § 158.15(a), and

(iii) A description of how this project meets the adequate justification requirement in § 158.15(c).

(4) A copy of any comments received by the public agency during the air carrier consultation and public comment processes (§§ 158.23 and 158.24) and the public agency's response to any disagreements.

(5) If applicable, a request to exclude a class of carriers from the requirement to collect the PFC (§ 158.11).

(6) A signed statement certifying that the public agency will comply with the assurances set forth in Appendix A to this part.

(7) Any additional information the Administrator may require.

(c) *Notice of intent to use PFC revenue.* A public agency may use PFC revenue only for projects included in notices filed under this paragraph or approved under § 158.29. This paragraph sets forth the information that a public agency must file, unless otherwise authorized by the Administrator, in its notice of intent to use PFC revenue to finance specific projects under this section.

(1) A notice of intent to use PFC revenue filed concurrently with a notice of intent to impose a PFC must include:

(i) The information required under paragraphs (b)(1) through (7) of this section;

(ii) A completed FAA Form 5500–1, Attachment G, Airport Layout Plan, Airspace, and Environmental Findings (latest edition) for all projects not in-

cluded in an existing Federal airport program grant.

(2) A notice of intent to use PFC revenue where the FAA has previously acknowledged a notice of intent to impose a PFC must:

(i) Be preceded by further consultation with air carriers and the opportunity for public comment under §§ 158.23 and 158.24 of this part. However, a meeting with the air carriers is optional if all information is the same as that provided with the impose authority notice;

(ii) Include a copy of any comments received by the public agency during the air carrier consultation and public comment processes (§§ 158.23 and 158.24) and the public agency's response to any disagreements or negative comments; and

(iii) Include any updated and changed information:

(A) Required by paragraphs (b)(1), (2), (5), (6), and (7) of this section; and

(B) Required by paragraph (c)(1)(ii) of this section.

(d) *FAA review of notices of intent.* (1) The FAA will review the notice of intent to determine that:

(A) The amount and duration of the PFC will not result in revenue that exceeds the amount necessary to finance the project(s);

(B) Each proposed project meets the requirements of § 158.15;

(C) Each project proposed at a PFC level above \$3.00 meets the requirements of § 158.17(a)(2) and (3);

(D) All applicable airport layout plan, airspace, and environmental requirements have been met for each project;

(E) Any request by the public agency to exclude a class of carriers from the requirement to collect the PFC is reasonable, not arbitrary, nondiscriminatory, and otherwise complies with the law; and

(F) The consultation and public comment processes complied with §§ 158.23 and 158.24.

(2) The FAA will also make a determination regarding the public agency's compliance with 49 U.S.C. 47524 and 47526 governing airport noise and access restrictions and 49 U.S.C. 47107(b) governing the use of airport revenue.

Finally, the FAA will review all comments filed during the air carrier consultation and public comment processes.

(e) *FAA acknowledgment of notices of intent.* Within 30 days of receipt of the public agency's notice of intent about its PFC program, the FAA will issue a written acknowledgment of the public agency's notice. The FAA's acknowledgment may concur with all proposed projects, may object to some or all proposed projects, or may object to the notice of intent in its entirety. The FAA's acknowledgment will include the reason(s) for any objection(s).

(f) Public agency actions following issuance of FAA acknowledgment letter. If the FAA does not object to either a project or the notice of intent in its entirety, the public agency may implement its PFC program. The public agency's implementation must follow the information specified in its notice of intent. If the FAA objects to a project, the public agency may not collect or use PFC revenue on that project. If the FAA objects to the notice of intent in its entirety, the public agency may not implement the PFC program proposed in that notice. When implementing a PFC under this section, except for § 158.25, a public agency must comply with all sections of part 158.

(g) *Acknowledgment not an order.* An FAA acknowledgment issued under this section is not considered an order issued by the Secretary for purposes of 49 U.S.C. 46110 (Judicial Review).

(h) *Sunset provision.* This section will expire May 9, 2008.

[Doc. No. FAA-2004-17999, 70 FR 14936, Mar. 23, 2005]

**§ 158.31 Duration of authority to impose a PFC after project implementation.**

A public agency that has begun implementing an approved project may impose a PFC until—

(a) The charge expiration date is reached;

(b) The total PFC revenue collected plus interest earned thereon equals the allowable cost of the approved project;

(c) The authority to collect the PFC is terminated by the Administrator under subpart E of this part; or

(d) The public agency is determined by the Administrator to be in violation of 49 U.S.C. 47524 and 47526, and the authority to collect the PFC is terminated under that statute's implementing regulations under this title.

[Doc. No. 26385, 56 FR 24278, May 29, 1991, as amended by Amdt. 158-2, 65 FR 34542, May 30, 2000; Amdt. 158-4, 72 FR 28849, May 23, 2007]

**§ 158.33 Duration of authority to impose a PFC before project implementation.**

(a) A public agency shall not impose a PFC beyond the lesser of the following—

(1) 2 years after approval to use PFC revenue on an approved project if the project has not been implemented, or

(2) 5 years after the charge effective date; or

(3) 5 years after the FAA's decision on the application (if the charge effective date is more than 60 days after the decision date) if an approved project is not implemented.

(b) If, in the Administrator's judgment, the public agency has not made sufficient progress toward implementation of an approved project within the times specified in paragraph (a) of this section, the Administrator begins termination proceedings under subpart E of this part.

(c) The authority to impose a PFC following approval shall automatically expire without further action by the Administrator on the following dates:

(1) 3 years after the charge effective date; or 3 years after the FAA's decision on the application if the charge effective date is more than 60 days after the decision date unless—

(i) The public agency has filed an application for approval to use PFC revenue for an eligible project that is pending before the FAA;

(ii) An application to use PFC revenue has been approved; or

(iii) A request for extension (not to exceed 2 years) to submit an application for project approval, under § 158.35, has been granted; or

(2) 5 years after the charge effective date; or 5 years after the FAA's decision on the application (if the charge effective date is more than 60 days

## § 158.35

## 14 CFR Ch. I (1–1–08 Edition)

after the decision date) unless the public agency has obtained project approval.

(d) If the authority to impose a PFC expires under paragraph (c) of this section, the public agency must provide the FAA with a list of the air carriers and foreign air carriers operating at the airport and all other collecting carriers that have remitted PFC revenue to the public agency in the preceding 12 months. The FAA notifies each of the listed carriers to terminate PFC collection no later than 30 days after the date of notification by the FAA.

(e) Restriction on reauthorization to impose a PFC. Whenever the authority to impose a PFC has expired or been terminated under this section, the Administrator will not grant new approval to impose a PFC in advance of implementation of an approved project.

[Doc. No. 26385, 56 FR 24278, May 29, 1991; 56 FR 37127, Aug. 2, 1991; Amdt. 158–4, 72 FR 28849, May 23, 2007]

### § 158.35 Extension of time to submit application to use PFC revenue.

(a) A public agency may request an extension of time to submit an application to use PFC revenue after approval of an application to impose PFC's. At least 30 days prior to submitting such request, the public agency shall publish notice of its intention to request an extension in a local newspaper of general circulation and shall request comments. The notice shall include progress on the project, a revised schedule for obtaining project approval and reasons for the delay in submitting the application.

(b) The request shall be submitted at least 120 days prior to the charge expiration date and, unless otherwise authorized by the Administrator, shall be accompanied by the following:

(1) A description of progress on the project application to date.

(2) A revised schedule for submitting the application.

(3) An explanation of the reasons for delay in submitting the application.

(4) A summary financial report depicting the total amount of PFC revenue collected plus interest, the projected amount to be collected during the period of the requested extension, and any public agency funds used on

the project for which reimbursement may be sought.

(5) A summary of any further consultation with air carriers and foreign air carriers operating at the airport.

(6) A summary of comments received in response to the local notice.

(c) The Administrator reviews the request for extension and accompanying information, to determine whether—

(1) The public agency has shown good cause for the delay in applying for project approval;

(2) The revised schedule is satisfactory; and

(3) Further collection will not result in excessive accumulation of PFC revenue.

(d) The Administrator, upon determining that the agency has shown good cause for the delay and that other elements of the request are satisfactory, grants the request for extension to the public agency. The Administrator advises the public agency in writing not more than 90 days after receipt of the request. The duration of the extension shall be as specified in § 158.33 of this part.

### § 158.37 Amendment of approved PFC.

(a)(1) A public agency may amend the FAA's decision with respect to an approved PFC to:

(i) Increase or decrease the level of PFC the public agency wants to collect from each passenger,

(ii) Increase or decrease the total approved PFC revenue,

(iii) Change the scope of an approved project,

(iv) Delete an approved project, or

(v) Establish a new class of carriers under § 158.11 or amend any such class previously approved.

(2) A public agency may not amend the FAA's decision with respect to an approved PFC to add projects, change an approved project to a different facility type, or alter an approved project to accomplish a different purpose.

(b) The public agency must file a request to the Administrator to amend the FAA's decision with respect to an approved PFC. The request must include or demonstrate:

(1)(i) Further consultation with the air carriers and foreign air carriers and seek public comment in accordance

with §§158.23 and 158.24 when applying for those requests to:

(A) Amend the approved PFC amount for a project by more than 25 percent of the original approved amount if the amount was \$1,000,000 or greater,

(B) Amend the approved PFC amount for a project by any percentage if the original approved amount was below \$1,000,000 and the amended approved amount is \$1,000,000 or greater,

(C) Change the scope of a project, or

(D) Increase the PFC level to be collected from each passenger.

(ii) No further consultation with air carriers and foreign air carriers or public comment is required by a public agency in accordance with §§158.23 and 158.24 when applying for an amendment in the following situations:

(A) To institute a decrease in the level of PFC to be collected from each passenger;

(B) To institute a decrease in the total PFC revenue;

(C) To institute an increase of 25 percent or less of the original approved amount if the amount was more than \$1,000,000; or

(D) To institute an increase of any amount if the original approved amount of the project was less than \$1,000,000 and if the amended approved amount of the project remains below \$1,000,000; or

(E) To establish a new class of carriers under §158.11 or amend any such class previously approved; or

(F) To delete an approved project.

(2) A copy of any comments received from the processes in paragraph (b)(1)(A) of this section for the carrier consultation and the opportunity for public comment in accordance with §§158.23 and 158.24;

(3) The public agency's reasons for continuing despite any objections;

(4) A description of the proposed amendment;

(5) Justification, if the amendment involves an increase in the PFC amount for a project by more than 25 percent of the original approved amount if that amount is \$1,000,000 or greater, an increase in the PFC amount by any percentage if the original approved amount was less than \$1,000,000 and the amended approved amount is \$1,000,000 or greater, a change in the ap-

proved project scope, or any increase in the approved PFC level to be collected from each passenger.

(6) A description of how each project meets the requirements of §158.17(b), for each project proposed for an increase of the PFC level above \$3.00 at a medium or large hub airport;

(7) A signed statement certifying that the public agency has met the requirements of §158.19, if applicable, for any amendment proposing to increase the PFC level above \$3.00 at a medium or large hub airport; and

(8) Any other information the Administrator may require.

(c) The Administrator will approve, partially approve or disapprove the amendment request and notify the public agency of the decision within 30 days of receipt of the request. If a PFC level of more than \$3.00 is approved, the Administrator must find the project meets the requirements of §§158.17 and 158.19, if applicable, before the public agency can implement the new PFC level.

(d) The public agency must notify the carriers of any change to the FAA's decision with respect to an approved PFC resulting from an amendment. The effective date of any new PFC level must be no earlier than the first day of a month which is at least 30 days from the date the public agency notifies the carriers.

[Doc. No. FAA-2004-17999, 70 FR 14937, Mar. 23, 2005, as amended by Amdt. 158-4, 72 FR 28849, May 23, 2007]

#### § 158.39 Use of excess PFC revenue.

(a) If the PFC revenue remitted to the public agency, plus interest earned thereon, exceeds the allowable cost of the project, the public agency must use the excess funds for approved projects or to retire outstanding PFC-financed bonds.

(b) For bond-financed projects, any excess PFC revenue collected under debt servicing requirements shall be retained by the public agency and used for approved projects or retirement of outstanding PFC-financed bonds.

(c) When the authority to impose a PFC has expired or has been terminated, accumulated PFC revenue shall

## § 158.41

be used for approved projects or retirement of outstanding PFC-financed bonds.

(d) Within 30 days after the authority to impose a PFC has expired or been terminated, the public agency must present a plan to the appropriate FAA Airports office to begin using accumulated PFC revenue. The plan must include a timetable for submitting any necessary application under this part. If the public agency fails to submit such a plan, or if the plan is not acceptable to the Administrator, the Administrator may reduce Federal airport grant program apportioned funds.

[Docket No. 26385, 56 FR 24278, May 29, 1991, as amended by Amdt. 158-4, 72 FR 28849, May 23, 2007]

### Subpart C—Collection, Handling, and Remittance of PFC's

#### § 158.41 General.

This subpart contains the requirements for notification, collection, handling and remittance of PFC's.

#### § 158.43 Public agency notification to collect PFC's.

(a) Following approval of an application to impose a PFC under subpart B of this part, the public agency shall notify the air carriers and foreign air carriers required to collect PFC's at its airport of the Administrator's approval. Each notified carrier shall notify its agents, including other issuing carriers, of the collection requirement.

(b) The notification shall be in writing and contain at a minimum the following information:

(1) The level of PFC to be imposed.

(2) The total revenue to be collected.

(3) The charge effective date will always be the first day of the month; however, it must be at least 30 days after the date the public agency notified the air carriers of the FAA's approval to impose the PFC.

(4) The proposed charge expiration date.

(5) A copy of the Administrator's notice of approval.

(6) The address where remittances and reports are to be filed by carriers.

(c) The public agency must notify air carriers required to collect PFCs at its airport and the FAA of changes in the

## 14 CFR Ch. I (1-1-08 Edition)

charge expiration date at least 30 days before the existing charge expiration date or new charge expiration date, whichever comes first. Each notified air carrier must notify its agents, including other issuing carriers, of such changes.

(d) The public agency shall provide a copy of the notification to the appropriate FAA Airports office.

[Docket No. 26385, 56 FR 24278, May 29, 1991, as amended by Amdt. 158-4, 72 FR 28849, May 23, 2007]

#### § 158.45 Collection of PFC's on tickets issued in the U.S.

(a) On and after the charge effective date, tickets issued in the U.S. shall include the required PFC except as provided in paragraphs (c) and (d) of this section.

(1) Issuing carriers shall be responsible for all funds from time of collection to remittance.

(2) The appropriate charge is the PFC in effect at the time the ticket is issued.

(3) Issuing carriers and their agents shall collect PFCs based on the itinerary at the time of issuance.

(i) Any change in itinerary initiated by a passenger that requires an adjustment to the amount paid by the passenger is subject to collection or refund of the PFC as appropriate.

(ii) Failure to travel on a nonrefundable or expired ticket is not a change in itinerary. If the ticket purchaser is not permitted any fare refund on the unused ticket, the ticket purchaser is not permitted a refund of any PFC associated with that ticket.

(b) Issuing carriers and their agents shall note as a separate item on each air travel ticket upon which a PFC is shown, the total amount of PFC's paid by the passenger and the airports for which the PFC's are collected.

(c) For each one-way trip shown on the complete itinerary of an air travel ticket, issuing air carriers and their agents shall collect a PFC from a passenger only for the first two airports where PFC's are imposed. For each round trip, a PFC shall be collected only for enplanements at the first two enplaning airports and the last two enplaning airports where PFC's are imposed.

(d) In addition to the restriction in paragraph (c) of this section, issuing carriers and their agents shall not collect PFC's from a passenger covered by any of the other limitations described in §158.9(a).

(e) Collected PFC's shall be distributed as noted on the air travel ticket.

(f) Issuing carriers and their agents shall stop collecting the PFC's on the charge expiration date stated in a notice from the public agency, or as required by the Administrator.

[Doc. No. 26385, 56 FR 24278, May 29, 1991, as amended by Amdt. 158-2, 65 FR 34542, May 30, 2000; Amdt. 158-4, 72 FR 28849, May 23, 2007]

**§ 158.47 Collection of PFC's on tickets issued outside the U.S.**

(a) For tickets issued outside the U.S., an air carrier or foreign air carrier may follow the requirements of either §158.45 or this section, unless the itinerary is for travel wholly within the U.S. Air carriers and foreign air carriers must comply with §158.45 where the itinerary is for travel wholly within the U.S. regardless of where the ticket is issued.

(b) Notwithstanding any other provisions of this part, no foreign airline is required to collect a PFC on air travel tickets issued on its own ticket stock unless it serves a point or points in the U.S.

(c) If an air carrier or foreign air carrier elects not to comply with §158.45 for tickets issued outside the U.S.—

(1) The carrier is required to collect PFC's on such tickets only for the public agency controlling the last airport at which the passenger is enplaned prior to departure from the U.S.

(2) The carrier may collect the PFC either at the time the ticket is issued or at the time the passenger is last enplaned prior to departure from the U.S. The carrier may vary the method of collection among its flights.

(3) The carrier shall provide a written record to the passenger that a PFC has been collected. Such a record shall appear on or with the air travel ticket and shall include the same information as required by §158.45(b), but need not be preprinted on the ticket stock.

(4) Issuing carriers and their agents shall collect PFCs based on the itinerary at the time of issuance.

(i) Any change in itinerary initiated by a passenger that requires an adjustment to the amount paid by the passenger is subject to collection or refund of the PFC as appropriate.

(ii) Failure to travel on a nonrefundable or expired ticket is not a change in itinerary. If the ticket purchaser is not permitted any fare refund on the unused ticket, the ticket purchaser is not permitted a refund of any PFC associated with that ticket.

(d) With respect to a flight on which the air carrier or foreign air carrier chooses to collect the PFC at the time the air travel ticket is issued—

(1) The carrier and its agents shall collect the required PFC on tickets issued on or after the charge effective date.

(2) The carrier is not required to collect PFC's at the time of enplanement for tickets sold by other air carriers or foreign air carriers or their agents.

(e) With respect to a flight on which the air carrier or foreign air carrier chooses to collect the PFC at the time of enplanement, the carrier shall examine the air travel ticket of each passenger enplaning at the airport on and after the charge effective date and shall collect the PFC from any passenger whose air travel ticket does not include a written record indicating that the PFC was collected at the time of issuance.

(f) Collected PFC's shall be distributed as noted on the written record provided to the passenger.

(g) Collecting carriers shall be responsible for all funds from time of collection to remittance.

(h) Collecting carriers and their agents shall stop collecting the PFC on the charge expiration date stated in a notice from the public agency, or as required by the Administrator.

[Doc. No. 26385, 56 FR 24278, May 29, 1991; 56 FR 37127, Aug. 2, 1991; Amdt. 158-4, 72 FR 28849, May 23, 2007]

**§ 158.49 Handling of PFC's.**

(a) Collecting carriers shall establish and maintain a financial management system to account for PFC's in accordance with the Department of Transportation's Uniform System of Accounts and Reports (14 CFR part 241). For carriers not subject to 14 CFR part 241,

such carriers shall establish and maintain an accounts payable system to handle PFC revenue with subaccounts for each public agency to which such carrier remits PFC revenue.

(b) Collecting carriers must account for PFC revenue separately. PFC revenue may be commingled with the air carrier's other sources of revenue except for covered air carriers discussed in paragraph (c) of this section. PFC revenues held by an air carrier or an agent of the air carrier after collection are held in trust for the beneficial interest of the public agency imposing the PFC. Such air carrier or agent holds neither legal nor equitable interest in the PFC revenues except for any handling fee or interest collected on unremitted proceeds as authorized in § 158.53.

(c)(1) A covered air carrier must segregate PFC revenue in a designated separate PFC account. Regardless of the amount of PFC revenue in the covered air carrier's account at the time the bankruptcy petition is filed, the covered air carrier must deposit into the separate PFC account an amount equal to the average monthly liability for PFCs collected under this section by such air carrier or any of its agents.

(i) The covered air carrier is required to create one PFC account to cover all PFC revenue it collects. The designated PFC account is solely for PFC transactions and the covered air carrier must make all PFC transactions from that PFC account. The covered air carrier is not required to create separate PFC accounts for each airport where a PFC is imposed.

(ii) The covered air carrier must transfer PFCs from its general accounts into the separate PFC account in an amount equal to the average monthly liability for PFCs as the "PFC reserve." The PFC reserve must equal a one-month average of the sum of the total PFCs collected by the covered air carrier, net of any credits or handling fees allowed by law, during the past 12-month period of PFC collections immediately before entering bankruptcy.

(iii) The minimum PFC reserve balance must never fall below the fixed amount defined in paragraph (c)(1)(ii) of this section.

(iv) A covered air carrier may continue to deposit the PFCs it collects into its general operating accounts combined with ticket sales revenue. However, at least once every business day, the covered air carrier must remove all PFC revenue (Daily PFC amount) from those accounts and transfer it to the new PFC account. An estimate based on  $\frac{1}{30}$  of the PFC reserve balance is permitted in substitution of the Daily PFC amount.

(A) In the event a covered air carrier ceases operations while still owing PFC remittances, the PFC reserve fund may be used to make those remittances. If there is any balance in the PFC reserve fund after all PFC remittances are made, that balance will be returned to the covered air carrier's general account.

(B) In the event a covered air carrier emerges from bankruptcy protection and ceases to be a covered air carrier, any balance remaining in the PFC reserve fund after any outstanding PFC obligations are met will be returned to the air carrier's general account.

(v) If the covered air carrier uses an estimate rather than the daily PFC amount, the covered air carrier shall reconcile the estimated amount with the actual amount of PFCs collected for the prior month (Actual Monthly PFCs). This reconciliation must take place no later than the 20th day of the month (or the next business day if the date is not a business day). In the event the Actual Monthly PFCs are greater than the aggregate estimated PFC amount, the covered air carrier will, within one business day of the reconciliation, deposit the difference into the PFC account. If the Actual Monthly PFCs are less than the aggregate estimated PFC amount, the covered air carrier will be entitled to a credit in the amount of the difference to be applied to the daily PFC amount due.

(vi) The covered air carrier is permitted to recalculate and reset the PFC reserve and daily PFC amount on each successive anniversary date of its bankruptcy petition using the methodology described above.

(2) If a covered air carrier or its agent fails to segregate PFC revenue in

violation of paragraph (c)(1) of this section, the trust fund status of such revenue shall not be defeated by an inability of any party to identify and trace the precise funds in the accounts of the air carrier.

(3) A covered air carrier and its agents may not grant to any third party any security or other interest in PFC revenue.

(4) A covered air carrier that fails to comply with any requirement of paragraph (c) of this section, or causes an eligible public agency to spend funds to recover or retain payment of PFC revenue, must compensate that public agency for those cost incurred to recover the PFCs owed.

(5) The provisions of paragraph (b) of this section that allow the commingling of PFCs with other air carrier revenue do not apply to a covered air carrier.

(d) All collecting air carriers must disclose the existence and amount of PFC funds regarded as trust funds in their financial statements.

[Doc. No. 26385, 56 FR 24278, May 29, 1991, as amended by Amdt. 158-2, 65 FR 34542, May 30, 2000; Amdt. 158-4, 72 FR 28850, May 23, 2007]

#### § 158.51 Remittance of PFC's.

Passenger facility charges collected by carriers shall be remitted to the public agency on a monthly basis. PFC revenue recorded in the accounting system of the carrier, as set forth in § 158.49 of this part, shall be remitted to the public agency no later than the last day of the following calendar month (or if that date falls on a weekend or holiday, the first business day thereafter).

#### § 158.53 Collection compensation.

(a) As compensation for collecting, handling, and remitting the PFC revenue, the collecting air carrier is entitled to:

(1) \$0.11 of each PFC collected.

(2) Any interest or other investment return earned on PFC revenue between the time of collection and remittance to the public agency.

(b) A covered air carrier that fails to designate a separate PFC account is prohibited from collecting interest on the PFC revenue. Where a covered air carrier maintains a separate PFC ac-

count in compliance with § 158.49(c), it will receive the interest on PFC accounts as described in paragraph (a)(2) of this section.

(c)(1) Collecting air carriers may provide collection cost data periodically to the FAA after the agency issues a notice in the FEDERAL REGISTER that specifies the information and deadline for filing the information. Submission of the information is voluntary. The requested information must include data on interest earned by the air carriers on PFC revenue and air carrier collection, handling, and remittance costs in the following categories:

- (i) Credit card fees;
- (ii) Audit fees;
- (iii) PFC disclosure fees;
- (iv) Reservations costs;
- (v) Passenger service costs;
- (vi) Revenue accounting, data entry, accounts payable, tax, and legal fees;
- (vii) Corporate property department costs;
- (viii) Training for reservations agents, ticket agents, and other departments;
- (ix) Ongoing carrier information systems costs;
- (x) Ongoing computer reservations systems costs; and
- (xi) Airline Reporting Corporation fees.

(2) The FAA may determine a new compensation level based on an analysis of the data provided under paragraph (c)(1) of this section, if the data is submitted by carriers representing at least 75 percent of PFCs collected nationwide.

(3) Any new compensation level determined by the FAA under paragraph (c)(2) of this section will replace the level identified in paragraph (a)(1) of this section.

[Doc. No. FAA-2006-23730, 72 FR 28850, May 23, 2007; Amdt. 158-4, 72 FR 31714, June 8, 2007]

### Subpart D—Reporting, Recordkeeping and Audits

#### § 158.61 General.

This subpart contains the requirements for reporting, recordkeeping and auditing of accounts maintained by collecting carriers and by public agencies.

**§ 158.63**

**14 CFR Ch. I (1–1–08 Edition)**

**§ 158.63 Reporting requirements: Public agency.**

(a) The public agency must provide quarterly reports to air carriers collecting PFCs for the public agency with a copy to the appropriate FAA Airports Office. The quarterly report must include:

- (1) Actual PFC revenue received from collecting air carriers, interest earned, and project expenditures for the quarter;
- (2) Cumulative actual PFC revenue received, interest earned, project expenditures, and the amount committed for use on currently approved projects, including the quarter;
- (3) The PFC level for each project; and
- (4) Each project's current schedule.

(b) The report shall be provided on or before the last day of the calendar month following the calendar quarter or other period agreed by the public agency and collecting carrier.

(c) For medium and large hub airports, the public agency must provide to the FAA, by July 1 of each year, an estimate of PFC revenue to be collected for each airport in the following fiscal year.

[Doc. No. 26385, 56 FR 24278, May 29, 1991, as amended by Amdt. 158–2, 65 FR 34542, May 30, 2000; Amdt. 158–4, 72 FR 28851, May 23, 2007]

**§ 158.65 Reporting requirements: Collecting air carriers.**

(a) Each air carrier collecting PFCs for a public agency must provide quarterly reports to the public agency unless otherwise agreed by the collecting air carrier and public agency, providing an accounting of funds collected and funds remitted.

(1) Unless otherwise agreed by the collecting air carrier and public agency, reports must state:

- (i) The collecting air carrier and airport involved,
- (ii) The total PFC revenue collected,
- (iii) The total PFC revenue refunded to passengers,
- (iv) The collected revenue withheld for reimbursement of expenses under § 158.53, and
- (v) The dates and amounts of each remittance for the quarter.

(2) The report must be filed by the last day of the month following the

calendar quarter or other period agreed by the collecting carrier and public agency for which funds were collected.

(b) A covered air carrier must provide the FAA with:

(1) A copy of its quarterly report by the established schedule under paragraph (a) of this section; and

(2) A monthly PFC account statement delivered not later than the fifth day of the following month. This monthly statement must include:

- (i) The balance in the account on the first day of the month,
- (ii) The total funds deposited during the month,
- (iii) The total funds disbursed during the month, and
- (iv) The closing balance in the account.

[Doc. No. FAA–2006–23730, 72 FR 28851, May 23, 2007]

**§ 158.67 Recordkeeping and auditing: Public agency.**

(a) Each public agency shall keep any unliquidated PFC revenue remitted to it by collecting carriers on deposit in an interest bearing account or in other interest bearing instruments used by the public agency's airport capital fund. Interest earned on such PFC revenue shall be used, in addition to the principal, to pay the allowable costs of PFC-funded projects. PFC revenue may only be commingled with other public agency airport capital funds in deposits or interest bearing instruments.

(b) Each public agency shall establish and maintain for each approved application a separate accounting record. The accounting record shall identify the PFC revenue received from the collecting carriers, interest earned on such revenue, the amounts used on each project, and the amount reserved for currently approved projects.

(c) At least annually during the period the PFC is collected, held or used, each public agency shall provide for an audit of its PFC account. The audit shall be performed by an accredited independent public accountant and may be of limited scope. The accountant shall express an opinion of the fairness and reasonableness of the public agency's procedures for receiving, holding, and using PFC revenue. The accountant shall also express an opinion

on whether the quarterly report required under §158.63 fairly represents the net transactions within the PFC account. The audit may be—

(1) Performed specifically for the PFC account; or

(2) Conducted as part of an audit under Office of Management and Budget Circular A-133 (the Single Audit Act of 1984, Pub. L. 98-502, and the Single Audit Act Amendments of 1996, Pub. L. 104-156) provided the auditor specifically addresses the PFC.

(3) Upon request, a copy of the audit shall be provided to each collecting carrier that remitted PFC revenue to the public agency in the period covered by the audit and to the Administrator.

[Docket No. 26385, 56 FR 24278, May 29, 1991, as amended by Amdt. 158-4, 72 FR 28851, May 23, 2007]

**§ 158.69 Recordkeeping and auditing: Collecting carriers.**

(a) Collecting carriers shall establish and maintain for each public agency for which they collect a PFC an accounting record of PFC revenue collected, remitted, refunded and compensation retained under §158.53(a) of this part. The accounting record shall identify the airport at which the passengers were enplaned.

(b) Each collecting carrier that collects more than 50,000 PFC's annually shall provide for an audit at least annually of its PFC account.

(1) The audit shall be performed by an accredited independent public accountant and may be of limited scope. The accountant shall express an opinion on the fairness and reasonableness of the carrier's procedures for collecting, holding, and dispersing PFC revenue. The opinion shall also address whether the quarterly reports required under §158.65 fairly represent the net transactions in the PFC account.

(2) For the purposes of an audit under this section, collection is defined as the point when agents or other intermediaries remit PFC revenue to the carrier.

(3) Upon request, a copy of the audit shall be provided to each public agency for which a PFC is collected.

**§ 158.71 Federal oversight.**

(a) The Administrator may periodically audit and/or review the use of PFC revenue by a public agency. The purpose of the audit or review is to ensure that the public agency is in compliance with the requirements of this part and 49 U.S.C. 40117.

(b) The Administrator may periodically audit and/or review the collection and remittance by the collecting carriers of PFC revenue. The purpose of the audit or review is to ensure collecting carriers are in compliance with the requirements of this part and 49 U.S.C. 40117.

(c) Public agencies and carriers shall allow any authorized representative of the Administrator, the Secretary of Transportation, or the Comptroller General of the U.S., access to any of its books, documents, papers, and records pertinent to PFC's

[Doc. No. 26385, 56 FR 24278, May 29, 1991, as amended by Amdt. 158-2, 65 FR 34543, May 30, 2000]

**Subpart E—Termination**

**§ 158.81 General.**

This subpart contains the procedures for termination of PFCs or loss of Federal airport grant funds for violations of this part or 49 U.S.C. 40117. This subpart does not address the circumstances under which the authority to collect PFCs may be terminated for violations of 49 U.S.C. 47523 through 47528.

[Doc. No. FAA-2006-23730, 72 FR 28851, May 23, 2007]

**§ 158.83 Informal resolution.**

The Administrator shall undertake informal resolution with the public agency or any other affected party if, after review under §158.71, the Administrator cannot determine that PFC revenue is being used for the approved projects in accordance with the terms of the Administrator's approval to impose a PFC for those projects or with 49 U.S.C. 40117.

[Doc. No. 26385, 56 FR 24278, May 29, 1991, as amended by Amdt. 158-2, 65 FR 34543, May 30, 2000]

## § 158.85

### § 158.85 Termination of authority to impose PFC's.

(a) The FAA begins proceedings to terminate the public agency's authority to impose a PFC only if the Administrator determines that informal resolution is not successful.

(b) The Administrator publishes a notice of proposed termination in the FEDERAL REGISTER and supplies a copy to the public agency. This notice will state the scope of the proposed termination, the basis for the proposed action and the date for filing written comments or objections by all interested parties. This notice will also identify any corrective actions the public agency can take to avoid further proceedings. The due date for comments and corrective action shall be no less than 60 days after publication of the notice.

(c) If corrective action has not been taken as prescribed by the Administrator, the FAA holds a public hearing, and notice is given to the public agency and published in the FEDERAL REGISTER at least 30 days prior to the hearing. The hearing will be in a form determined by the Administrator to be appropriate to the circumstances and to the matters in dispute.

(d) The Administrator publishes the final decision in the FEDERAL REGISTER. Where appropriate, the Administrator may prescribe corrective action, including any corrective action the public agency may yet take. A copy of the notice is also provided to the public agency.

(e) Within 10 days of the date of publication of the notice of the Administrator's decision, the public agency shall—

(1) Advise the FAA in writing that it will complete any corrective action prescribed in the decision within 30 days; or

(2) Provide the FAA with a listing of the air carriers and foreign air carriers operating at the airport and all other issuing carriers that have remitted PFC revenue to the public agency in the preceding 12 months.

(f) When the Administrator's decision does not provide for corrective action or the public agency fails to complete such action, the FAA provides a copy of the FEDERAL REGISTER notice to

## 14 CFR Ch. I (1-1-08 Edition)

each air carrier and foreign air carrier identified in paragraph (e) of this section. Such carriers are responsible for terminating or modifying PFC collection no later than 30 days after the date of notification by the FAA.

### § 158.87 Loss of Federal airport grant funds.

(a) If the Administrator determines that revenue derived from a PFC is excessive or is not being used as approved, the Administrator may reduce the amount of funds otherwise payable to the public agency under 49 U.S.C. 47114. Such a reduction may be made as a corrective action under § 158.83 or § 158.85 of this part.

(b) The amount of the reduction under paragraph (a) of this section shall equal the excess collected, or the amount not used in accordance with this part.

(c) A reduction under paragraph (a) of this section shall not constitute a withholding of approval of a grant application or the payment of funds under an approved grant within the meaning of 49 U.S.C. 47111(d).

[Doc. No. 26385, 56 FR 24278, May 29, 1991, as amended by Amdt. 158-2, 65 FR 34543, May 30, 2000]

## Subpart F—Reduction in Airport Improvement Program Apportionment

### § 158.91 General.

This subpart describes the required reduction in funds apportioned to a large or medium hub airport that imposes a PFC.

### § 158.93 Public agencies subject to reduction.

The funds apportioned under 49 U.S.C. 47114 to a public agency for a specific primary commercial service airport that it controls are reduced if—

(a) Such airport enplanes 0.25 percent or more of the total annual enplanements in the U.S., and

(b) The public agency imposes a PFC at such airport.

[Doc. No. 26385, 56 FR 24278, May 29, 1991, as amended by Amdt. 158-2, 65 FR 34543, May 30, 2000]

**§ 158.95 Implementation of reduction.**

(a) A reduction in apportioned funds will not take effect until the first fiscal year following the year in which the collection of the PFC is begun and will be applied in each succeeding fiscal year in which the public agency imposes the PFC.

(b) The reduction in apportioned funds is calculated at the beginning of each fiscal year and shall be an amount equal to—

(1) In the case of a fee of \$3 or less, 50 percent of the projected revenues from the fee in the fiscal year but not by more than 50 percent of the amount that otherwise would be apportioned under this section; and

(2) In the case of a fee of more than \$3, 75 percent of the projected revenues from the fee in the fiscal year but not by more than 75 percent of the amount that otherwise would be apportioned under this section.

(c) If the projection of PFC revenue in a fiscal year is inaccurate, the reduction in apportioned funds may be increased or decreased in the following fiscal year, except that any further reduction shall not cause the total reduction to exceed 50 percent of such apportioned amount as would otherwise be apportioned in any fiscal year.

[Doc. No. 26385, 56 FR 24278, May 29, 1991, as amended by Amdt. 158-2, 65 FR 34543, May 30, 2000]

## APPENDIX A TO PART 158—ASSURANCES

*A. General.*

1. These assurances shall be complied with in the conduct of a project funded with passenger facility charge (PFC) revenue.

2. These assurances are required to be submitted as part of the application for approval of authority to impose a PFC under the provisions of 49 U.S.C. 40117.

3. Upon approval by the Administrator of an application, the public agency is responsible for compliance with these assurances.

*B. Public agency certification.* The public agency hereby assures and certifies, with respect to this project that:

1. Responsibility and authority of the public agency. It has legal authority to impose a PFC and to finance and carry out the proposed project; that a resolution, motion or similar action has been duly adopted or passed as an official act of the public agency's governing body authorizing the filing of the application, including all understandings and assurances contained therein, and di-

recting and authorizing the person identified as the official representative of the public agency to act in connection with the application.

2. Compliance with regulation. It will comply with all provisions of 14 CFR part 158.

3. Compliance with state and local laws and regulations. It has complied, or will comply, with all applicable State and local laws and regulations.

4. Environmental, airspace and airport layout plan requirements. It will not use PFC revenue on a project until the FAA has notified the public agency that—

(a) Any actions required under the National Environmental Policy Act of 1969 have been completed;

(b) The appropriate airspace finding has been made; and

(c) The FAA Airport Layout Plan with respect to the project has been approved.

5. Nonexclusivity of contractual agreements. It will not enter into an exclusive long-term lease or use agreement with an air carrier or foreign air carrier for projects funded by PFC revenue. Such leases or use agreements will not preclude the public agency from funding, developing, or assigning new capacity at the airport with PFC revenue.

6. Carryover provisions. It will not enter into any lease or use agreement with any air carrier or foreign air carrier for any facility financed in whole or in part with revenue derived from a passenger facility charge if such agreement for such facility contains a carryover provision regarding a renewal option which, upon expiration of the original lease, would operate to automatically extend the term of such agreement with such carrier in preference to any potentially competing air carrier or foreign air carrier seeking to negotiate a lease or use agreement for such facilities.

7. Competitive access. It agrees that any lease or use agreements between the public agency and any air carrier or foreign air carrier for any facility financed in whole or in part with revenue derived from a passenger facility charge will contain a provision that permits the public agency to terminate the lease or use agreement if—

(a) The air carrier or foreign air carrier has an exclusive lease or use agreement for existing facilities at such airport; and

(b) Any portion of its existing exclusive use facilities is not fully utilized and is not made available for use by potentially competing air carriers or foreign air carriers.

8. Rates, fees and charges.

(a) It will not treat PFC revenue as airport revenue for the purpose of establishing a rate, fee or charge pursuant to a contract with an air carrier or foreign air carrier.

(b) It will not include in its rate base by means of depreciation, amortization, or any other method, that portion of the capital

costs of a project paid for by PFC revenue for the purpose of establishing a rate, fee or charge pursuant to a contract with an air carrier or foreign air carrier.

(c) Notwithstanding the limitation provided in subparagraph (b), with respect to a project for terminal development, gates and related areas, or a facility occupied or used by one or more air carriers or foreign air carriers on an exclusive or preferential basis, the rates, fees, and charges payable by such carriers that use such facilities will be no less than the rates, fees, and charges paid by such carriers using similar facilities at the airport that were not financed by PFC revenue.

9. Standards and specifications. It will carry out the project in accordance with FAA airport design, construction and equipment standards and specifications contained in advisory circulars current on the date of project approval.

10. Recordkeeping and Audit. It will maintain an accounting record for audit purposes for 3 years after physical and financial completion of the project. All records must satisfy the requirements of 14 CFR part 158 and contain documentary evidence for all items of project costs.

11. Reports. It will submit reports in accordance with the requirements of 14 CFR part 158, subpart D, and as the Administrator may reasonably request.

12. Compliance with 49 U.S.C. 47523 through 47528. It understands 49 U.S.C. 47524 and 47526 require that the authority to impose a PFC be terminated if the Administrator determines the public agency has failed to comply with those sections of the United States Code or with the implementing regulations published under the Code.

[Doc. No. 26385, 56 FR 24278, May 29, 1991, as amended by Amdt. 158–2, 65 FR 34543, May 30, 2000; Amdt. 158–4, 72 FR 28851, May 23, 2007]

## PART 161—NOTICE AND APPROVAL OF AIRPORT NOISE AND ACCESS RESTRICTIONS

### Subpart A—General Provisions

Sec.

- 161.1 Purpose.
- 161.3 Applicability.
- 161.5 Definitions.
- 161.7 Limitations.
- 161.9 Designation of noise description methods.
- 161.11 Identification of land uses in airport noise study area.

### Subpart B—Agreements

- 161.101 Scope.
- 161.103 Notice of the proposed restriction.
- 161.105 Requirements for new entrants.

- 161.107 Implementation of the restriction.
- 161.109 Notice of termination of restriction pursuant to an agreement.
- 161.111 Availability of data and comments on a restriction implemented pursuant to an agreement.
- 161.113 Effect of agreements; limitation on reevaluation.

### Subpart C—Notice Requirements for Stage 2 Restrictions

- 161.201 Scope.
- 161.203 Notice of proposed restriction.
- 161.205 Required analysis of proposed restriction and alternatives.
- 161.207 Comment by interested parties.
- 161.209 Requirements for proposal changes.
- 161.211 Optional use of 14 CFR part 150 procedures.
- 161.213 Notification of a decision not to implement a restriction.

### Subpart D—Notice, Review, and Approval Requirements for Stage 3 Restrictions

- 161.301 Scope.
- 161.303 Notice of proposed restrictions.
- 161.305 Required analysis and conditions for approval of proposed restrictions.
- 161.307 Comment by interested parties.
- 161.309 Requirements for proposal changes.
- 161.311 Application procedure for approval of proposed restriction.
- 161.313 Review of application.
- 161.315 Receipt of complete application.
- 161.317 Approval or disapproval of proposed restriction.
- 161.319 Withdrawal or revision of restriction.
- 161.321 Optional use of 14 CFR part 150 procedures.
- 161.323 Notification of a decision not to implement a restriction.
- 161.325 Availability of data and comments on an implemented restriction.

### Subpart E—Reevaluation of Stage 3 Restrictions

- 161.401 Scope.
- 161.403 Criteria for reevaluation.
- 161.405 Request for reevaluation.
- 161.407 Notice of reevaluation.
- 161.409 Required analysis by reevaluation petitioner.
- 161.411 Comment by interested parties.
- 161.413 Reevaluation procedure.
- 161.415 Reevaluation action.
- 161.417 Notification of status of restrictions and agreements not meeting conditions-of-approval criteria.

### Subpart F—Failure To Comply With This Part

- 161.501 Scope.
- 161.503 Informal resolution; notice of apparent violation.

161.505 Notice of proposed termination of airport grant funds and passenger facility charges.

AUTHORITY: 49 U.S.C. 106(g), 47523-47527, 47533.

SOURCE: Docket No. 26432, 56 FR 48698, Sept. 25, 1991, unless otherwise noted.

### Subpart A—General Provisions

#### § 161.1 Purpose.

This part implements the Airport Noise and Capacity Act of 1990 (49 U.S.C. App. 2153, 2154, 2155, and 2156). It prescribes:

(a) Notice requirements and procedures for airport operators implementing Stage 3 aircraft noise and access restrictions pursuant to agreements between airport operators and aircraft operators;

(b) Analysis and notice requirements for airport operators proposing Stage 2 aircraft noise and access restrictions;

(c) Notice, review, and approval requirements for airport operators proposing Stage 3 aircraft noise and access restrictions; and

(d) Procedures for Federal Aviation Administration reevaluation of agreements containing restrictions on Stage 3 aircraft operations and of aircraft noise and access restrictions affecting Stage 3 aircraft operations imposed by airport operators.

#### § 161.3 Applicability.

(a) This part applies to airports imposing restrictions on Stage 2 aircraft operations proposed after October 1, 1990, and to airports imposing restrictions on Stage 3 aircraft operations that became effective after October 1, 1990.

(b) This part also applies to airports enacting amendments to airport noise and access restrictions in effect on October 1, 1990, but amended after that date, where the amendment reduces or limits aircraft operations or affects aircraft safety.

(c) The notice, review, and approval requirements set forth in this part apply to all airports imposing noise or access restrictions as defined in § 161.5 of this part.

#### § 161.5 Definitions.

For the purposes of this part, the following definitions apply:

*Agreement* means a document in writing signed by the airport operator; those aircraft operators currently operating at the airport that would be affected by the noise or access restriction; and all affected new entrants planning to provide new air service within 180 days of the effective date of the restriction that have submitted to the airport operator a plan of operations and notice of agreement to the restriction.

*Aircraft operator*, for purposes of this part, means any owner of an aircraft that operates the aircraft, i.e., uses, causes to use, or authorizes the use of the aircraft; or in the case of a leased aircraft, any lessee that operates the aircraft pursuant to a lease. As used in this part, aircraft operator also means any representative of the aircraft owner, or in the case of a leased aircraft, any representative of the lessee empowered to enter into agreements with the airport operator regarding use of the airport by an aircraft.

*Airport* means any area of land or water, including any heliport, that is used or intended to be used for the landing and takeoff of aircraft, and any appurtenant areas that are used or intended to be used for airport buildings or other airport facilities or rights-of-way, together with all airport buildings and facilities located thereon.

*Airport noise study area* means that area surrounding the airport within the noise contour selected by the applicant for study and must include the noise contours required to be developed for noise exposure maps specified in 14 CFR part 150.

*Airport operator* means the airport proprietor.

*Aviation user class* means the following categories of aircraft operators: air carriers operating under parts 121 or 129 of this chapter; commuters and other carriers operating under part 135 of this chapter; general aviation, military, or government operations.

*Day-night average sound level (DNL)* means the 24-hour average sound level, in decibels, for the period from midnight to midnight, obtained after the addition of ten decibels to sound levels

## § 161.7

## 14 CFR Ch. I (1-1-08 Edition)

for the periods between midnight and 7 a.m., and between 10 p.m. and midnight, local time, as defined in 14 CFR part 150. (The scientific notation for DNL is  $L_{dn}$ ).

*Noise or access restrictions* means restrictions (including but not limited to provisions of ordinances and leases) affecting access or noise that affect the operations of Stage 2 or Stage 3 aircraft, such as limits on the noise generated on either a single-event or cumulative basis; a limit, direct or indirect, on the total number of Stage 2 or Stage 3 aircraft operations; a noise budget or noise allocation program that includes Stage 2 or Stage 3 aircraft; a restriction imposing limits on hours of operations; a program of airport-use charges that has the direct or indirect effect of controlling airport noise; and any other limit on Stage 2 or Stage 3 aircraft that has the effect of controlling airport noise. This definition does not include peak-period pricing programs where the objective is to align the number of aircraft operations with airport capacity.

*Stage 2 aircraft* means an aircraft that has been shown to comply with the Stage 2 requirements under 14 CFR part 36.

*Stage 3 aircraft* means an aircraft that has been shown to comply with the Stage 3 requirements under 14 CFR part 36.

[Doc. No. 26432, 56 FR 48698, Sept. 25, 1991, as amended by Amdt. 161-2, 66 FR 21067, Apr. 27, 2001]

### § 161.7 Limitations.

(a) Aircraft operational procedures that must be submitted for adoption by the FAA, such as preferential runway use, noise abatement approach and departure procedures and profiles, and flight tracks, are not subject to this part. Other noise abatement procedures, such as taxiing and engine runups, are not subject to this part unless the procedures imposed limit the total number of Stage 2 or Stage 3 aircraft operations, or limit the hours of Stage 2 or Stage 3 aircraft operations, at the airport.

(b) The notice, review, and approval requirements set forth in this part do not apply to airports with restrictions

as specified in 49 U.S.C. App. 2153(a)(2)(C):

(1) A local action to enforce a negotiated or executed airport aircraft noise or access agreement between the airport operator and the aircraft operator in effect on November 5, 1990.

(2) A local action to enforce a negotiated or executed airport aircraft noise or access restriction the airport operator and the aircraft operators agreed to before November 5, 1990.

(3) An intergovernmental agreement including airport aircraft noise or access restriction in effect on November 5, 1990.

(4) A subsequent amendment to an airport aircraft noise or access agreement or restriction in effect on November 5, 1990, where the amendment does not reduce or limit aircraft operations or affect aircraft safety.

(5) A restriction that was adopted by an airport operator on or before October 1, 1990, and that was stayed as of October 1, 1990, by a court order or as a result of litigation, if such restriction, or a part thereof, is subsequently allowed by a court to take effect.

(6) In any case in which a restriction described in paragraph (b)(5) of this section is either partially or totally disallowed by a court, any new restriction imposed by an airport operator to replace such disallowed restriction, if such new restriction would not prohibit aircraft operations in effect on November 5, 1990.

(7) A local action that represents the adoption of the final portion of a program of a staged airport aircraft noise or access restriction, where the initial portion of such program was adopted during calendar year 1988 and was in effect on November 5, 1990.

(c) The notice, review, and approval requirements of subpart D of this part with regard to Stage 3 aircraft restrictions do not apply if the FAA has, prior to November 5, 1990, formed a working group (outside of the process established by 14 CFR part 150) with a local airport operator to examine the noise impact of air traffic control procedure changes. In any case in which an agreement relating to noise reductions at such airport is then entered into between the airport proprietor and an air carrier or air carrier constituting a

majority of the air carrier users of such airport, the requirements of subparts B and D of this part with respect to restrictions on Stage 3 aircraft operations do apply to local actions to enforce such agreements.

(d) Except to the extent required by the application of the provisions of the Act, nothing in this part eliminates, invalidates, or supersedes the following:

(1) Existing law with respect to airport noise or access restrictions by local authorities;

(2) Any proposed airport noise or access regulation at a general aviation airport where the airport proprietor has formally initiated a regulatory or legislative process on or before October 1, 1990; and

(3) The authority of the Secretary of Transportation to seek and obtain such legal remedies as the Secretary considers appropriate, including injunctive relief.

**§ 161.9 Designation of noise description methods.**

For purposes of this part, the following requirements apply:

(a) The sound level at an airport and surrounding areas, and the exposure of individuals to noise resulting from operations at an airport, must be established in accordance with the specifications and methods prescribed under appendix A of 14 CFR part 150; and

(b) Use of computer models to create noise contours must be in accordance with the criteria prescribed under appendix A of 14 CFR part 150.

**§ 161.11 Identification of land uses in airport noise study area.**

For the purposes of this part, uses of land that are normally compatible or noncompatible with various noise-exposure levels to individuals around airports must be identified in accordance with the criteria prescribed under appendix A of 14 CFR part 150. Determination of land use must be based on professional planning, zoning, and building and site design information and expertise.

**Subpart B—Agreements**

**§ 161.101 Scope.**

(a) This subpart applies to an airport operator's noise or access restriction on the operation of Stage 3 aircraft that is implemented pursuant to an agreement between an airport operator and all aircraft operators affected by the proposed restriction that are serving or will be serving such airport within 180 days of the date of the proposed restriction.

(b) For purposes of this subpart, an agreement shall be in writing and signed by:

(1) The airport operator;

(2) Those aircraft operators currently operating at the airport who would be affected by the noise or access restriction; and

(3) All new entrants that have submitted the information required under § 161.105(a) of this part.

(c) This subpart does not apply to restrictions exempted in § 161.7 of this part.

(d) This subpart does not limit the right of an airport operator to enter into an agreement with one or more aircraft operators that restricts the operation of Stage 2 or Stage 3 aircraft as long as the restriction is not enforced against aircraft operators that are not party to the agreement. Such an agreement is not covered by this subpart except that an aircraft operator may apply for sanctions pursuant to subpart F of this part for restrictions the airport operator seeks to impose other than those in the agreement.

**§ 161.103 Notice of the proposed restriction.**

(a) An airport operator may not implement a Stage 3 restriction pursuant to an agreement with all affected aircraft operators unless there has been public notice and an opportunity for comment as prescribed in this subpart.

(b) In order to establish a restriction in accordance with this subpart, the airport operator shall, at least 45 days before implementing the restriction, publish a notice of the proposed restriction in an areawide newspaper or newspapers that either singly or together has general circulation throughout the airport vicinity or airport

## § 161.105

## 14 CFR Ch. I (1-1-08 Edition)

noise study area, if one has been delineated; post a notice in the airport in a prominent location accessible to airport users and the public; and directly notify in writing the following parties:

(1) Aircraft operators providing scheduled passenger or cargo service at the airport; affected operators of aircraft based at the airport; potential new entrants that are known to be interested in serving the airport; and aircraft operators known to be routinely providing non-scheduled service;

(2) The Federal Aviation Administration;

(3) Each Federal, state, and local agency with land use control jurisdiction within the vicinity of the airport, or the airport noise study area, if one has been delineated;

(4) Fixed-base operators and other airport tenants whose operations may be affected by the proposed restriction; and

(5) Community groups and business organizations that are known to be interested in the proposed restriction.

(c) Each direct notice provided in accordance with paragraph (b) of this section shall include:

(1) The name of the airport and associated cities and states;

(2) A clear, concise description of the proposed restriction, including sanctions for noncompliance and a statement that it will be implemented pursuant to a signed agreement;

(3) A brief discussion of the specific need for and goal of the proposed restriction;

(4) Identification of the operators and the types of aircraft expected to be affected;

(5) The proposed effective date of the restriction and any proposed enforcement mechanism;

(6) An invitation to comment on the proposed restriction, with a minimum 45-day comment period;

(7) Information on how to request copies of the restriction portion of the agreement, including any sanctions for noncompliance;

(8) A notice to potential new entrant aircraft operators that are known to be interested in serving the airport of the requirements set forth in §161.105 of this part; and

(9) Information on how to submit a new entrant application, comments, and the address for submitting applications and comments to the airport operator, including identification of a contact person at the airport.

(d) The Federal Aviation Administration will publish an announcement of the proposed restriction in the FEDERAL REGISTER.

[Docket No. 26432, 56 FR 48698, Sept. 25, 1991; 56 FR 51258, Oct. 10, 1991]

### § 161.105 Requirements for new entrants.

(a) Within 45 days of the publication of the notice of a proposed restriction by the airport operator under §161.103(b) of this part, any person intending to provide new air service to the airport within 180 days of the proposed date of implementation of the restriction (as evidenced by submission of a plan of operations to the airport operator) must notify the airport operator if it would be affected by the restriction contained in the proposed agreement, and either that it—

- (1) Agrees to the restriction; or
- (2) Objects to the restriction.

(b) Failure of any person described in §161.105(a) of this part to notify the airport operator that it objects to the proposed restriction will constitute waiver of the right to claim that it did not consent to the agreement and render that person ineligible to use lack of signature as ground to apply for sanctions under subpart F of this part for two years following the effective date of the restriction. The signature of such a person need not be obtained by the airport operator in order to comply with §161.107(a) of this part.

(c) All other new entrants are also ineligible to use lack of signature as ground to apply for sanctions under subpart F of this part for two years.

### § 161.107 Implementation of the restriction.

(a) To be eligible to implement a Stage 3 noise or access restriction under this subpart, an airport operator shall have the restriction contained in an agreement as defined in §161.101(b) of this part.

(b) An airport operator may not implement a restriction pursuant to an

agreement until the notice and comment requirements of §161.103 of this part have been met.

(c) Each airport operator must notify the Federal Aviation Administration of the implementation of a restriction pursuant to an agreement and must include in the notice evidence of compliance with §161.103 and a copy of the signed agreement.

**§ 161.109 Notice of termination of restriction pursuant to an agreement.**

An airport operator must notify the FAA within 10 days of the date of termination of a restriction pursuant to an agreement under this subpart.

**§ 161.111 Availability of data and comments on a restriction implemented pursuant to an agreement.**

The airport operator shall retain all relevant supporting data and all comments relating to a restriction implemented pursuant to an agreement for as long as the restriction is in effect. The airport operator shall make these materials available for inspection upon request by the FAA. The information shall be made available for inspection by any person during the pendency of any petition for reevaluation found justified by the FAA.

**§ 161.113 Effect of agreements; limitation on reevaluation.**

(a) Except as otherwise provided in this subpart, a restriction implemented by an airport operator pursuant to this subpart shall have the same force and effect as if it had been a restriction implemented in accordance with subpart D of this part.

(b) A restriction implemented by an airport operator pursuant to this subpart may be subject to reevaluation by the FAA under subpart E of this part.

**Subpart C—Notice Requirements for Stage 2 Restrictions**

**§ 161.201 Scope.**

(a) This subpart applies to:

(1) An airport imposing a noise or access restriction on the operation of Stage 2 aircraft, but not Stage 3 aircraft, proposed after October 1, 1990.

(2) An airport imposing an amendment to a Stage 2 restriction, if the

amendment is proposed after October 1, 1990, and reduces or limits Stage 2 aircraft operations (compared to the restriction that it amends) or affects aircraft safety.

(b) This subpart does not apply to an airport imposing a Stage 2 restriction specifically exempted in §161.7 or a Stage 2 restriction contained in an agreement as long as the restriction is not enforced against aircraft operators that are not parties to the agreement.

**§ 161.203 Notice of proposed restriction.**

(a) An airport operator may not implement a Stage 2 restriction within the scope of §161.201 unless the airport operator provides an analysis of the proposed restriction, prepared in accordance with §161.205, and a public notice and opportunity for comment as prescribed in this subpart. The notice and analysis required by this subpart shall be completed at least 180 days prior to the effective date of the restriction.

(b) Except as provided in §161.211, an airport operator must publish a notice of the proposed restriction in an areawide newspaper or newspapers that either singly or together has general circulation throughout the airport noise study area; post a notice in the airport in a prominent location accessible to airport users and the public; and directly notify in writing the following parties:

(1) Aircraft operators providing scheduled passenger or cargo service at the airport; operators of aircraft based at the airport; potential new entrants that are known to be interested in serving the airport; and aircraft operators known to be routinely providing nonscheduled service that may be affected by the proposed restriction;

(2) The Federal Aviation Administration;

(3) Each Federal, state, and local agency with land-use control jurisdiction within the airport noise study area;

(4) Fixed-base operators and other airport tenants whose operations may be affected by the proposed restriction; and

**§ 161.205**

**14 CFR Ch. I (1–1–08 Edition)**

(5) Community groups and business organizations that are known to be interested in the proposed restriction.

(c) Each notice provided in accordance with paragraph (b) of this section shall include:

(1) The name of the airport and associated cities and states;

(2) A clear, concise description of the proposed restriction, including a statement that it will be a mandatory Stage 2 restriction, and where the complete text of the restriction, and any sanctions for noncompliance, are available for public inspection;

(3) A brief discussion of the specific need for, and goal of, the restriction;

(4) Identification of the operators and the types of aircraft expected to be affected;

(5) The proposed effective date of the restriction, the proposed method of implementation (e.g., city ordinance, airport rule, lease), and any proposed enforcement mechanism;

(6) An analysis of the proposed restriction, as required by § 161.205 of this subpart, or an announcement of where the analysis is available for public inspection;

(7) An invitation to comment on the proposed restriction and analysis, with a minimum 45-day comment period;

(8) Information on how to request copies of the complete text of the proposed restriction, including any sanctions for noncompliance, and the analysis (if not included with the notice); and

(9) The address for submitting comments to the airport operator, including identification of a contact person at the airport.

(d) At the time of notice, the airport operator shall provide the FAA with a full text of the proposed restriction, including any sanctions for noncompliance.

(e) The Federal Aviation Administration will publish an announcement of the proposed Stage 2 restriction in the FEDERAL REGISTER.

**§ 161.205 Required analysis of proposed restriction and alternatives.**

(a) Each airport operator proposing a noise or access restriction on Stage 2 aircraft operations shall prepare the

following and make it available for public comment:

(1) An analysis of the anticipated or actual costs and benefits of the proposed noise or access restriction;

(2) A description of alternative restrictions; and

(3) A description of the alternative measures considered that do not involve aircraft restrictions, and a comparison of the costs and benefits of such alternative measures to costs and benefits of the proposed noise or access restriction.

(b) In preparing the analyses required by this section, the airport operator shall use the noise measurement systems and identify the airport noise study area as specified in §§ 161.9 and 161.11, respectively; shall use currently accepted economic methodology; and shall provide separate detail on the costs and benefits of the proposed restriction with respect to the operations of Stage 2 aircraft weighing less than 75,000 pounds if the restriction applies to this class. The airport operator shall specify the methods used to analyze the costs and benefits of the proposed restriction and the alternatives.

(c) The kinds of information set forth in § 161.305 are useful elements of an adequate analysis of a noise or access restriction on Stage 2 aircraft operations.

**§ 161.207 Comment by interested parties.**

Each airport operator shall establish a public docket or similar method for receiving and considering comments, and shall make comments available for inspection by interested parties upon request. Comments must be retained as long as the restriction is in effect.

**§ 161.209 Requirements for proposal changes.**

(a) Each airport operator shall promptly advise interested parties of any changes to a proposed restriction, including changes that affect non-compatible land uses, and make available any changes to the proposed restriction and its analysis. Interested parties include those that received direct notice under § 161.203(b), or those that were required to be consulted in accordance with the procedures in

§161.211 of this part, and those that have commented on the proposed restriction.

(b) If there are substantial changes to the proposed restriction or the analysis during the 180-day notice period, the airport operator shall initiate new notice following the procedures in §161.203 or, alternatively, the procedures in §161.211. A substantial change includes, but is not limited to, a proposal that would increase the burden on any aviation user class.

(c) In addition to the information in §161.203(c), new notice must indicate that the airport operator is revising a previous notice, provide the reason for making the revision, and provide a new effective date (if any) for the restriction. The effective date of the restriction must be at least 180 days after the date the new notice and revised analysis are made available for public comment.

**§ 161.211 Optional use of 14 CFR part 150 procedures.**

(a) An airport operator may use the procedures in part 150 of this chapter, instead of the procedures described in §§161.203(b) and 161.209(b), as a means of providing an adequate public notice and comment opportunity on a proposed Stage 2 restriction.

(b) If the airport operator elects to use 14 CFR part 150 procedures to comply with this subpart, the operator shall:

(1) Ensure that all parties identified for direct notice under §161.203(b) are notified that the airport's 14 CFR part 150 program will include a proposed Stage 2 restriction under part 161, and that these parties are offered the opportunity to participate as consulted parties during the development of the 14 CFR part 150 program;

(2) Provide the FAA with a full text of the proposed restriction, including any sanctions for noncompliance, at the time of the notice;

(3) Include the information in §161.203(c)(2) through (c)(5) and 161.205 in the analysis of the proposed restriction for the part 14 CFR part 150 program;

(4) Wait 180 days following the availability of the above analysis for review by the consulted parties and compliance with the above notice require-

ments before implementing the Stage 2 restriction; and

(5) Include in its 14 CFR part 150 submission to the FAA evidence of compliance with paragraphs (b)(1) and (b)(4) of this section, and the analysis in paragraph (b)(3) of this section, together with a clear identification that the 14 CFR part 150 program includes a proposed Stage 2 restriction under part 161.

(c) The FAA determination on the 14 CFR part 150 submission does not constitute approval or disapproval of the proposed Stage 2 restriction under part 161.

(d) An amendment of a restriction may also be processed under 14 CFR part 150 procedures in accordance with this section.

**§ 161.213 Notification of a decision not to implement a restriction.**

If a proposed restriction has been through the procedures prescribed in this subpart and the restriction is not subsequently implemented, the airport operator shall so advise the interested parties. Interested parties are described in §161.209(a).

**Subpart D—Notice, Review, and Approval Requirements for Stage 3 Restrictions**

**§ 161.301 Scope.**

(a) This subpart applies to:

(1) An airport imposing a noise or access restriction on the operation of Stage 3 aircraft that first became effective after October 1, 1990.

(2) An airport imposing an amendment to a Stage 3 restriction, if the amendment becomes effective after October 1, 1990, and reduces or limits Stage 3 aircraft operations (compared to the restriction that it amends) or affects aircraft safety.

(b) This subpart does not apply to an airport imposing a Stage 3 restriction specifically exempted in §161.7, or an agreement complying with subpart B of this part.

(c) A Stage 3 restriction within the scope of this subpart may not become effective unless it has been submitted to and approved by the FAA. The FAA will review only those Stage 3 restrictions that are proposed by, or on behalf

**§ 161.303**

**14 CFR Ch. I (1–1–08 Edition)**

of, an entity empowered to implement the restriction.

**§ 161.303 Notice of proposed restrictions.**

(a) Each airport operator or aircraft operator (hereinafter referred to as applicant) proposing a Stage 3 restriction shall provide public notice and an opportunity for public comment, as prescribed in this subpart, before submitting the restriction to the FAA for review and approval.

(b) Except as provided in § 161.321, an applicant shall publish a notice of the proposed restriction in an areawide newspaper or newspapers that either singly or together has general circulation throughout the airport noise study area; post a notice in the airport in a prominent location accessible to airport users and the public; and directly notify in writing the following parties:

(1) Aircraft operators providing scheduled passenger or cargo service at the airport; operators of aircraft based at the airport; potential new entrants that are known to be interested in serving the airport; and aircraft operators known to be routinely providing nonscheduled service that may be affected by the proposed restriction;

(2) The Federal Aviation Administration;

(3) Each Federal, state, and local agency with land-use control jurisdiction within the airport noise study area;

(4) Fixed-base operators and other airport tenants whose operations may be affected by the proposed restriction; and

(5) Community groups and business organizations that are known to be interested in the proposed restriction.

(c) Each notice provided in accordance with paragraph (b) of this section shall include:

(1) The name of the airport and associated cities and states;

(2) A clear, concise description of the proposed restriction (and any alternatives, in order of preference), including a statement that it will be a mandatory Stage 3 restriction; and where the complete text of the restriction, and any sanctions for noncompliance, are available for public inspection;

(3) A brief discussion of the specific need for, and goal of, the restriction;

(4) Identification of the operators and types of aircraft expected to be affected;

(5) The proposed effective date of the restriction, the proposed method of implementation (e.g., city ordinance, airport rule, lease, or other document), and any proposed enforcement mechanism;

(6) An analysis of the proposed restriction, in accordance with § 161.305 of this part, or an announcement regarding where the analysis is available for public inspection;

(7) An invitation to comment on the proposed restriction and the analysis, with a minimum 45-day comment period;

(8) Information on how to request a copy of the complete text of the restriction, including any sanctions for noncompliance, and the analysis (if not included with the notice); and

(9) The address for submitting comments to the airport operator or aircraft operator proposing the restriction, including identification of a contact person.

(d) Applicants may propose alternative restrictions, including partial implementation of any proposal, and indicate an order of preference. If alternative restriction proposals are submitted, the requirements listed in paragraphs (c)(2) through (c)(6) of this section should address the alternative proposals where appropriate.

**§ 161.305 Required analysis and conditions for approval of proposed restrictions.**

Each applicant proposing a noise or access restriction on Stage 3 operations shall prepare and make available for public comment an analysis that supports, by substantial evidence, that the six statutory conditions for approval have been met for each restriction and any alternatives submitted. The statutory conditions are set forth in 49 U.S.C. App. 2153(d)(2) and paragraph (e) of this section. Any proposed restriction (including alternatives) on Stage 3 aircraft operations that also affects the operation of Stage 2 aircraft must include analysis of the proposals in a manner that permits the

proposal to be understood in its entirety. (Nothing in this section is intended to add a requirement for the issuance of restrictions on Stage 2 aircraft to those of subpart C of this part.) The applicant shall provide:

(a) The complete text of the proposed restriction and any submitted alternatives, including the proposed wording in a city ordinance, airport rule, lease, or other document, and any sanctions for noncompliance;

(b) Maps denoting the airport geographic boundary, and the geographic boundaries and names of each jurisdiction that controls land use within the airport noise study area;

(c) An adequate environmental assessment of the proposed restriction or adequate information supporting a categorical exclusion in accordance with FAA orders and procedures regarding compliance with the National Environmental Policy Act of 1969 (42 U.S.C. 4321);

(d) A summary of the evidence in the submission supporting the six statutory conditions for approval; and

(e) An analysis of the restriction, demonstrating by substantial evidence that the statutory conditions are met. The analysis must:

(1) Be sufficiently detailed to allow the FAA to evaluate the merits of the proposed restriction; and

(2) Contain the following essential elements needed to provide substantial evidence supporting each condition for approval:

(i) *Condition 1: The restriction is reasonable, nonarbitrary, and nondiscriminatory.* (A) Essential information needed to demonstrate this condition includes the following:

(1) Evidence that a current or projected noise or access problem exists, and that the proposed action(s) could relieve the problem, including:

(i) A detailed description of the problem precipitating the proposed restriction with relevant background information on factors contributing to the proposal and any court-ordered action or estimated liability concerns; a description of any noise agreements or noise or access restrictions currently in effect at the airport; and measures taken to achieve land-use compatibility, such as controls or restrictions

on land use in the vicinity of the airport and measures carried out in response to 14 CFR part 150; and actions taken to comply with grant assurances requiring that:

(A) Airport development projects be reasonably consistent with plans of public agencies that are authorized to plan for the development of the area around the airport; and

(B) The sponsor give fair consideration to the interests of communities in or near where the project may be located; take appropriate action, including the adoption of zoning laws, to the extent reasonable, to restrict the use of land near the airport to activities and purposes compatible with normal airport operations; and not cause or permit any change in land use, within its jurisdiction, that will reduce the compatibility (with respect to the airport) of any noise compatibility program measures upon which federal funds have been expended.

(ii) An analysis of the estimated noise impact of aircraft operations with and without the proposed restriction for the year the restriction is expected to be implemented, for a forecast timeframe after implementation, and for any other years critical to understanding the noise impact of the proposed restriction. The analysis of noise impact with and without the proposed restriction including:

(A) Maps of the airport noise study area overlaid with noise contours as specified in §§161.9 and 161.11 of this part;

(B) The number of people and the noncompatible land uses within the airport noise study area with and without the proposed restriction for each year the noise restriction is analyzed;

(C) Technical data supporting the noise impact analysis, including the classes of aircraft, fleet mix, runway use percentage, and day/night breakout of operations; and

(D) Data on current and projected airport activity that would exist in the absence of the proposed restriction.

(2) Evidence that other available remedies are infeasible or would be less cost-effective, including descriptions of any alternative aircraft restrictions that have been considered and rejected, and the reasons for the rejection; and

of any land use or other nonaircraft controls or restrictions that have been considered and rejected, including those proposed under 14 CFR part 150 and not implemented, and the reasons for the rejection or failure to implement.

(3) Evidence that the noise or access standards are the same for all aviation user classes or that the differences are justified, such as:

(i) A description of the relationship of the effect of the proposed restriction on airport users (by aviation user class); and

(ii) The noise attributable to these users in the absence of the proposed restriction.

(B) At the applicant's discretion, information may also be submitted as follows:

(1) Evidence not submitted under paragraph (e)(2)(ii)(A) of this section (Condition 2) that there is a reasonable chance that expected benefits will equal or exceed expected cost; for example, comparative economic analyses of the costs and benefits of the proposed restriction and aircraft and non-aircraft alternative measures. For detailed elements of analysis, see paragraph (e)(2)(ii)(A) of this section.

(2) Evidence not submitted under paragraph (e)(2)(ii)(A) of this section that the level of any noise-based fees that may be imposed reflects the cost of mitigating noise impacts produced by the aircraft, or that the fees are reasonably related to the intended level of noise impact mitigation.

(ii) *Condition 2: The restriction does not create an undue burden on interstate or foreign commerce.* (A) Essential information needed to demonstrate this statutory condition includes:

(1) Evidence, based on a cost-benefit analysis, that the estimated potential benefits of the restriction have a reasonable chance to exceed the estimated potential cost of the adverse effects on interstate and foreign commerce. In preparing the economic analysis required by this section, the applicant shall use currently accepted economic methodology, specify the methods used and assumptions underlying the analysis, and consider:

(i) The effect of the proposed restriction on operations of aircraft by avia-

tion user class (and for air carriers, the number of operations of aircraft by carrier), and on the volume of passengers and cargo for the year the restriction is expected to be implemented and for the forecast timeframe.

(ii) The estimated costs of the proposed restriction and alternative non-aircraft restrictions including the following, as appropriate:

(A) Any additional cost of continuing aircraft operations under the restriction, including reasonably available information concerning any net capital costs of acquiring or retrofitting aircraft (net of salvage value and operating efficiencies) by aviation user class; and any incremental recurring costs;

(B) Costs associated with altered or discontinued aircraft operations, such as reasonably available information concerning loss to carriers of operating profits; decreases in passenger and shipper consumer surplus by aviation user class; loss in profits associated with other airport services or other entities; and/or any significant economic effect on parties other than aviation users.

(C) Costs associated with implementing nonaircraft restrictions or nonaircraft components of restrictions, such as reasonably available information concerning estimates of capital costs for real property, including redevelopment, soundproofing, noise easements, and purchase of property interests; and estimates of associated incremental recurring costs; or an explanation of the legal or other impediments to implementing such restrictions.

(D) Estimated benefits of the proposed restriction and alternative restrictions that consider, as appropriate, anticipated increase in real estate values and future construction cost (such as sound insulation) savings; anticipated increase in airport revenues; quantification of the noise benefits, such as number of people removed from noise contours and improved work force and/or educational productivity, if any; valuation of positive safety effects, if any; and/or other qualitative benefits, including improvements in quality of life.

(B) At the applicant's discretion, information may also be submitted as follows:

(1) Evidence that the affected carriers have a reasonable chance to continue service at the airport or at other points in the national airport system.

(2) Evidence that other air carriers are able to provide adequate service to the airport and other points in the system without diminishing competition.

(3) Evidence that comparable services or facilities are available at another airport controlled by the airport operator in the market area, including services available at other airports.

(4) Evidence that alternative transportation service can be attained through other means of transportation.

(5) Information on the absence of adverse evidence or adverse comments with respect to undue burden in the notice process required in §161.303, or alternatively in §161.321, of this part as evidence that there is no undue burden.

(iii) *Condition 3: The proposed restriction maintains safe and efficient use of the navigable airspace.* Essential information needed to demonstrate this statutory condition includes evidence that the proposed restriction maintains safe and efficient use of the navigable airspace based upon:

(A) Identification of airspace and obstacles to navigation in the vicinity of the airport; and

(B) An analysis of the effects of the proposed restriction with respect to use of airspace in the vicinity of the airport, substantiating that the restriction maintains or enhances safe and efficient use of the navigable airspace. The analysis shall include a description of the methods and data used.

(iv) *Condition 4: The proposed restriction does not conflict with any existing Federal statute or regulation.* Essential information needed to demonstrate this condition includes evidence demonstrating that no conflict is presented between the proposed restriction and any existing Federal statute or regulation, including those governing:

(A) Exclusive rights;

(B) Control of aircraft operations; and

(C) Existing Federal grant agreements.

(v) *Condition 5: The applicant has provided adequate opportunity for public comment on the proposed restriction.* Essential information needed to demonstrate this condition includes evidence that there has been adequate opportunity for public comment on the restriction as specified in §161.303 or §161.321 of this part.

(vi) *Condition 6: The proposed restriction does not create an undue burden on the national aviation system.* Essential information needed to demonstrate this condition includes evidence that the proposed restriction does not create an undue burden on the national aviation system such as:

(A) An analysis demonstrating that the proposed restriction does not have a substantial adverse effect on existing or planned airport system capacity, on observed or forecast airport system congestion and aircraft delay, and on airspace system capacity or workload;

(B) An analysis demonstrating that nonaircraft alternative measures to achieve the same goals as the proposed subject restrictions are inappropriate;

(C) The absence of comments with respect to imposition of an undue burden on the national aviation system in response to the notice required in §161.303 or §161.321.

#### **§ 161.307 Comment by interested parties.**

(a) Each applicant proposing a restriction shall establish a public docket or similar method for receiving and considering comments, and shall make comments available for inspection by interested parties upon request. Comments must be retained as long as the restriction is in effect.

(b) Each applicant shall submit to the FAA a summary of any comments received. Upon request by the FAA, the applicant shall submit copies of the comments.

#### **§ 161.309 Requirements for proposal changes.**

(a) Each applicant shall promptly advise interested parties of any changes to a proposed restriction or alternative restriction that are not encompassed in the proposals submitted, including changes that affect noncompatible land

## § 161.311

## 14 CFR Ch. I (1–1–08 Edition)

uses or that take place before the effective date of the restriction, and make available these changes to the proposed restriction and its analysis. For the purpose of this paragraph, interested parties include those who received direct notice under §161.303(b) of this part, or those who were required to be consulted in accordance with the procedures in §161.321 of this part, and those who commented on the proposed restriction.

(b) If there are substantial changes to a proposed restriction or the analysis made available prior to the effective date of the restriction, the applicant proposing the restriction shall initiate new notice in accordance with the procedures in §161.303 or, alternatively, the procedures in §161.321. These requirements apply to substantial changes that are not encompassed in submitted alternative restriction proposals and their analyses. A substantial change to a restriction includes, but is not limited to, any proposal that would increase the burden on any aviation user class.

(c) In addition to the information in §161.303(c), a new notice must indicate that the applicant is revising a previous notice, provide the reason for making the revision, and provide a new effective date (if any) for the restriction.

(d) If substantial changes requiring a new notice are made during the FAA's 180-day review of the proposed restriction, the applicant submitting the proposed restriction shall notify the FAA in writing that it is withdrawing its proposal from the review process until it has completed additional analysis, public review, and documentation of the public review. Resubmission to the FAA will restart the 180-day review.

### § 161.311 Application procedure for approval of proposed restriction.

Each applicant proposing a Stage 3 restriction shall submit to the FAA the following information for each restriction and alternative restriction submitted, with a request that the FAA review and approve the proposed Stage 3 noise or access restriction:

(a) A summary of evidence of the fulfillment of conditions for approval, as specified in §161.305;

(b) An analysis as specified in §161.305, as appropriate to the proposed restriction;

(c) A statement that the entity submitting the proposal is the party empowered to implement the restriction, or is submitting the proposal on behalf of such party; and

(d) A statement as to whether the airport requests, in the event of disapproval of the proposed restriction or any alternatives, that the FAA approve any portion of the restriction or any alternative that meets the statutory requirements for approval. An applicant requesting partial approval of any proposal should indicate its priorities as to portions of the proposal to be approved.

### § 161.313 Review of application.

(a) *Determination of completeness.* The FAA, within 30 days of receipt of an application, will determine whether the application is complete in accordance with §161.311. Determinations of completeness will be made on all proposed restrictions and alternatives. This completeness determination is not an approval or disapproval of the proposed restriction.

(b) *Process for complete application.* When the FAA determines that a complete application has been submitted, the following procedures apply:

(1) The FAA notifies the applicant that it intends to act on the proposed restriction and publishes notice of the proposed restriction in the FEDERAL REGISTER in accordance with §161.315. The 180-day period for approving or disapproving the proposed restriction will start on the date of original FAA receipt of the application.

(2) Following review of the application, public comments, and any other information obtained under §161.317(b), the FAA will issue a decision approving or disapproving the proposed restriction. This decision is a final decision of the Administrator for purpose of judicial review.

(c) *Process for incomplete application.* If the FAA determines that an application is not complete with respect to any submitted restriction or alternative restriction, the following procedures apply:

(1) The FAA shall notify the applicant in writing, returning the application and setting forth the type of information and analysis needed to complete the application in accordance with § 161.311.

(2) Within 30 days after the receipt of this notice, the applicant shall advise the FAA in writing whether or not it intends to resubmit and supplement its application.

(3) If the applicant does not respond in 30 days, or advises the FAA that it does not intend to resubmit and/or supplement the application, the application will be denied. This closes the matter without prejudice to later application and does not constitute disapproval of the proposed restriction.

(4) If the applicant chooses to resubmit and supplement the application, the following procedures apply:

(i) Upon receipt of the resubmitted application, the FAA determines whether the application, as supplemented, is complete as set forth in paragraph (a) of this section.

(ii) If the application is complete, the procedures set forth in § 161.315 shall be followed. The 180-day review period starts on the date of receipt of the last supplement to the application.

(iii) If the application is still not complete with respect to the proposed restriction or at least one submitted alternative, the FAA so advises the applicant as set forth in paragraph (c)(1) of this section and provides the applicant with an additional opportunity to supplement the application as set forth in paragraph (c)(2) of this section.

(iv) If the environmental documentation (either an environmental assessment or information supporting a categorical exclusion) is incomplete, the FAA will so notify the applicant in writing, returning the application and setting forth the types of information and analysis needed to complete the documentation. The FAA will continue to return an application until adequate environmental documentation is provided. When the application is determined to be complete, including the environmental documentation, the 180-day period for approval or disapproval will begin upon receipt of the last supplement to the application.

(v) Following review of the application and its supplements, public comments, and any other information obtained under § 161.317(b), the FAA will issue a decision approving or disapproving the application. This decision is a final decision of the Administrator for the purpose of judicial review.

(5) The FAA will deny the application and return it to the applicant if:

(i) None of the proposals submitted are found to be complete;

(ii) The application has been returned twice to the applicant for reasons other than completion of the environmental documentation; and

(iii) The applicant declines to complete the application. This closes the matter without prejudice to later application, and does not constitute disapproval of the proposed restriction.

**§ 161.315 Receipt of complete application.**

(a) When a complete application has been received, the FAA will notify the applicant by letter that the FAA intends to act on the application.

(b) The FAA will publish notice of the proposed restriction in the FEDERAL REGISTER, inviting interested parties to file comments on the application within 30 days after publication of the FEDERAL REGISTER notice.

**§ 161.317 Approval or disapproval of proposed restriction.**

(a) Upon determination that an application is complete with respect to at least one of the proposals submitted by the applicant, the FAA will act upon the complete proposals in the application. The FAA will not act on any proposal for which the applicant has declined to submit additional necessary information.

(b) The FAA will review the applicant's proposals in the preference order specified by the applicant. The FAA may request additional information from aircraft operators, or any other party, and may convene an informal meeting to gather facts relevant to its determination.

(c) The FAA will evaluate the proposal and issue an order approving or disapproving the proposed restriction and any submitted alternatives, in

## § 161.319

whole or in part, in the order of preference indicated by the applicant. Once the FAA approves a proposed restriction, the FAA will not consider any proposals of lower applicant-stated preference. Approval or disapproval will be given by the FAA within 180 days after receipt of the application or last supplement thereto under § 161.313. The FAA will publish its decision in the FEDERAL REGISTER and notify the applicant in writing.

(d) The applicant's failure to provide substantial evidence supporting the statutory conditions for approval of a particular proposal is grounds for disapproval of that proposed restriction.

(e) The FAA will approve or disapprove only the Stage 3 aspects of a restriction if the restriction applies to both Stage 2 and Stage 3 aircraft operations.

(f) An order approving a restriction may be subject to requirements that the applicant:

(1) Comply with factual representations and commitments in support of the restriction; and

(2) Ensure that any environmental mitigation actions or commitments by any party that are set forth in the environmental documentation provided in support of the restriction are implemented.

## § 161.319 Withdrawal or revision of restriction.

(a) The applicant may withdraw or revise a proposed restriction at any time prior to FAA approval or disapproval, and must do so if substantial changes are made as described in § 161.309. The applicant shall notify the FAA in writing of a decision to withdraw the proposed restriction for any reason. The FAA will publish a notice in the FEDERAL REGISTER that it has terminated its review without prejudice to resubmission. A resubmission will be considered a new application.

(b) A subsequent amendment to a Stage 3 restriction that was in effect after October 1, 1990, or an amendment to a Stage 3 restriction previously approved by the FAA, is subject to the procedures in this subpart if the amendment will further reduce or limit aircraft operations or affect aircraft safety. The applicant may, at its op-

## 14 CFR Ch. I (1-1-08 Edition)

tion, revise or amend a restriction previously disapproved by the FAA and resubmit it for approval. Amendments are subject to the same requirements and procedures as initial submissions.

## § 161.321 Optional use of 14 CFR part 150 procedures.

(a) An airport operator may use the procedures in part 150 of this chapter, instead of the procedures described in §§ 161.303(b) and 161.309(b) of this part, as a means of providing an adequate public notice and opportunity to comment on proposed Stage 3 restrictions, including submitted alternatives.

(b) If the airport operator elects to use 14 CFR part 150 procedures to comply with this subpart, the operator shall:

(1) Ensure that all parties identified for direct notice under § 161.303(b) are notified that the airport's 14 CFR part 150 program submission will include a proposed Stage 3 restriction under part 161, and that these parties are offered the opportunity to participate as consulted parties during the development of the 14 CFR part 150 program;

(2) Include the information required in § 161.303(c) (2) through (5) and § 161.305 in the analysis of the proposed restriction in the 14 CFR part 150 program submission; and

(3) Include in its 14 CFR part 150 submission to the FAA evidence of compliance with the notice requirements in paragraph (b)(1) of this section and include the information required for a part 161 application in § 161.311, together with a clear identification that the 14 CFR part 150 submission includes a proposed Stage 3 restriction for FAA review and approval under §§ 161.313, 161.315, and 161.317.

(c) The FAA will evaluate the proposed part 161 restriction on Stage 3 aircraft operations included in the 14 CFR part 150 submission in accordance with the procedures and standards of this part, and will review the total 14 CFR part 150 submission in accordance with the procedures and standards of 14 CFR part 150.

(d) An amendment of a restriction, as specified in § 161.319(b) of this part, may also be processed under 14 CFR part 150 procedures.

**§ 161.323 Notification of a decision not to implement a restriction.**

If a Stage 3 restriction has been approved by the FAA and the restriction is not subsequently implemented, the applicant shall so advise the interested parties specified in §161.309(a) of this part.

**§ 161.325 Availability of data and comments on an implemented restriction.**

The applicant shall retain all relevant supporting data and all comments relating to an approved restriction for as long as the restriction is in effect and shall make these materials available for inspection upon request by the FAA. This information shall be made available for inspection by any person during the pendency of any petition for reevaluation found justified by the FAA.

**Subpart E—Reevaluation of Stage 3 Restrictions****§ 161.401 Scope.**

This subpart applies to an airport imposing a noise or access restriction on the operation of Stage 3 aircraft that first became effective after October 1, 1990, and had either been agreed to in compliance with the procedures in subpart B of this part or approved by the FAA in accordance with the procedures in subpart D of this part. This subpart does not apply to Stage 2 restrictions imposed by airports. This subpart does not apply to Stage 3 restrictions specifically exempted in §161.7.

**§ 161.403 Criteria for reevaluation.**

(a) A request for reevaluation must be submitted by an aircraft operator.

(b) An aircraft operator must demonstrate to the satisfaction of the FAA that there has been a change in the noise environment of the affected airport and that a review and reevaluation pursuant to the criteria in §161.305 is therefore justified.

(1) A change in the noise environment sufficient to justify reevaluation is either a DNL change of 1.5 dB or greater (from the restriction's anticipated target noise level result) over noncompatible land uses, or a change

of 17 percent or greater in the non-compatible land uses, within an airport noise study area. For approved restrictions, calculation of change shall be based on the divergence of actual noise impact of the restriction from the estimated noise impact of the restriction predicted in the analysis required in §161.305(e)(2)(i)(A)(I)(ii). The change in the noise environment or in the non-compatible land uses may be either an increase or decrease in noise or in non-compatible land uses. An aircraft operator may submit to the FAA reasons why a change that does not fall within either of these parameters justifies reevaluation, and the FAA will consider such arguments on a case-by-case basis.

(2) A change in the noise environment justifies reevaluation if the change is likely to result in the restriction not meeting one or more of the conditions for approval set forth in §161.305 of this part for approval. The aircraft operator must demonstrate that such a result is likely to occur.

(c) A reevaluation may not occur less than 2 years after the date of the FAA approval. The FAA will normally apply the same 2-year requirement to agreements under subpart B of this part that affect Stage 3 aircraft operations. An aircraft operator may submit to the FAA reasons why an agreement under subpart B of this part should be reevaluated in less than 2 years, and the FAA will consider such arguments on a case-by-case basis.

(d) An aircraft operator must demonstrate that it has made a good faith attempt to resolve locally any dispute over a restriction with the affected parties, including the airport operator, before requesting reevaluation by the FAA. Such demonstration and certification shall document all attempts of local dispute resolution.

[Docket No. 26432, 56 FR 48698, Sept. 25, 1991; 56 FR 51258, Oct. 10, 1991]

**§ 161.405 Request for reevaluation.**

(a) A request for reevaluation submitted to the FAA by an aircraft operator must include the following information:

(1) The name of the airport and associated cities and states;

(2) A clear, concise description of the restriction and any sanctions for non-compliance, whether the restriction was approved by the FAA or agreed to by the airport operator and aircraft operators, the date of the approval or agreement, and a copy of the restriction as incorporated in a local ordinance, airport rule, lease, or other document;

(3) The quantified change in the noise environment using methodology specified in this part;

(4) Evidence of the relationship between this change and the likelihood that the restriction does not meet one or more of the conditions in § 161.305;

(5) The aircraft operator's status under the restriction (e.g., currently affected operator, potential new entrant) and an explanation of the aircraft operator's specific objection; and

(6) A description and evidence of the aircraft operator's attempt to resolve the dispute locally with the affected parties, including the airport operator.

(b) The FAA will evaluate the aircraft operator's submission and determine whether or not a reevaluation is justified. The FAA may request additional information from the airport operator or any other party and may convene an informal meeting to gather facts relevant to its determination.

(c) The FAA will notify the aircraft operator in writing, with a copy to the affected airport operator, of its determination.

(1) If the FAA determines that a reevaluation is not justified, it will indicate the reasons for this decision.

(2) If the FAA determines that a reevaluation is justified, the aircraft operator will be notified to complete its analysis and to begin the public notice procedure, as set forth in this subpart.

**§ 161.407 Notice of reevaluation.**

(a) After receiving an FAA determination that a reevaluation is justified, an aircraft operator desiring continuation of the reevaluation process shall publish a notice of request for reevaluation in an areawide newspaper or newspapers that either singly or together has general circulation throughout the airport noise study area (or the airport vicinity for agreements where an airport noise study area has not

been delineated); post a notice in the airport in a prominent location accessible to airport users and the public; and directly notify in writing the following parties:

(1) The airport operator, other aircraft operators providing scheduled passenger or cargo service at the airport, operators of aircraft based at the airport, potential new entrants that are known to be interested in serving the airport, and aircraft operators known to be routinely providing non-scheduled service;

(2) The Federal Aviation Administration;

(3) Each Federal, State, and local agency with land-use control jurisdiction within the airport noise study area (or the airport vicinity for agreements where an airport noise study area has not been delineated);

(4) Fixed-base operators and other airport tenants whose operations may be affected by the agreement or the restriction;

(5) Community groups and business organizations that are known to be interested in the restriction; and

(6) Any other party that commented on the original restriction.

(b) Each notice provided in accordance with paragraph (a) of this section shall include:

(1) The name of the airport and associated cities and states;

(2) A clear, concise description of the restriction, including whether the restriction was approved by the FAA or agreed to by the airport operator and aircraft operators, and the date of the approval or agreement;

(3) The name of the aircraft operator requesting a reevaluation, and a statement that a reevaluation has been requested and that the FAA has determined that a reevaluation is justified;

(4) A brief discussion of the reasons why a reevaluation is justified;

(5) An analysis prepared in accordance with § 161.409 of this part supporting the aircraft operator's reevaluation request, or an announcement of where the analysis is available for public inspection;

(6) An invitation to comment on the analysis supporting the proposed reevaluation, with a minimum 45-day comment period;

(7) Information on how to request a copy of the analysis (if not in the notice); and

(8) The address for submitting comments to the aircraft operator, including identification of a contact person.

**§ 161.409 Required analysis by reevaluation petitioner.**

(a) An aircraft operator that has petitioned the FAA to reevaluate a restriction shall assume the burden of analysis for the reevaluation.

(b) The aircraft operator's analysis shall be made available for public review under the procedures in §161.407 and shall include the following:

(1) A copy of the restriction or the language of the agreement as incorporated in a local ordinance, airport rule, lease, or other document;

(2) The aircraft operator's status under the restriction (e.g., currently affected operator, potential new entrant) and an explanation of the aircraft operator's specific objection to the restriction;

(3) The quantified change in the noise environment using methodology specified in this part;

(4) Evidence of the relationship between this change and the likelihood that the restriction does not meet one or more of the conditions in §161.305; and

(5) Sufficient data and analysis selected from §161.305, as applicable to the restriction at issue, to support the contention made in paragraph (b)(4) of this section. This is to include either an adequate environmental assessment of the impacts of discontinuing all or part of a restriction in accordance with the aircraft operator's petition, or adequate information supporting a categorical exclusion under FAA orders implementing the National Environmental Policy Act of 1969 (42 U.S.C. 4321).

(c) The amount of analysis may vary with the complexity of the restriction, the number and nature of the conditions in §161.305 that are alleged to be unsupported, and the amount of previous analysis developed in support of the restriction. The aircraft operator may incorporate analysis previously developed in support of the restriction, including previous environmental doc-

umentation to the extent applicable. The applicant is responsible for providing substantial evidence, as described in §161.305, that one or more of the conditions are not supported.

**§ 161.411 Comment by interested parties.**

(a) Each aircraft operator requesting a reevaluation shall establish a docket or similar method for receiving and considering comments and shall make comments available for inspection to interested parties specified in paragraph (b) of this section upon request. Comments must be retained for two years.

(b) Each aircraft operator shall promptly notify interested parties if it makes a substantial change in its analysis that affects either the costs or benefits analyzed, or the criteria in §161.305, differently from the analysis made available for comment in accordance with §161.407. Interested parties include those who received direct notice under paragraph (a) of §161.407 and those who have commented on the reevaluation. If an aircraft operator revises its analysis, it shall make the revised analysis available to an interested party upon request and shall extend the comment period at least 45 days from the date the revised analysis is made available.

**§ 161.413 Reevaluation procedure.**

(a) Each aircraft operator requesting a reevaluation shall submit to the FAA:

(1) The analysis described in §161.409;

(2) Evidence that the public review process was carried out in accordance with §§161.407 and 161.411, including the aircraft operator's summary of the comments received; and

(3) A request that the FAA complete a reevaluation of the restriction and issue findings.

(b) Following confirmation by the FAA that the aircraft operator's documentation is complete according to the requirements of this subpart, the FAA will publish a notice of reevaluation in the FEDERAL REGISTER and provide for a 45-day comment period during which

## § 161.415

interested parties may submit comments to the FAA. The FAA will specifically solicit comments from the affected airport operator and affected local governments. A submission that is not complete will be returned to the aircraft operator with a letter indicating the deficiency, and no notice will be published. No further action will be taken by the FAA until a complete submission is received.

(c) The FAA will review all submitted documentation and comments pursuant to the conditions of §161.305. To the extent necessary, the FAA may request additional information from the aircraft operator, airport operator, and others known to have information material to the reevaluation, and may convene an informal meeting to gather facts relevant to a reevaluation finding.

### § 161.415 Reevaluation action.

(a) Upon completing the reevaluation, the FAA will issue appropriate orders regarding whether or not there is substantial evidence that the restriction meets the criteria in §161.305 of this part.

(b) If the FAA's reevaluation confirms that the restriction meets the criteria, the restriction may remain as previously agreed to or approved. If the FAA's reevaluation concludes that the restriction does not meet the criteria, the FAA will withdraw a previous approval of the restriction issued under subpart D of this part to the extent necessary to bring the restriction into compliance with this part or, with respect to a restriction agreed to under subpart B of this part, the FAA will specify which criteria are not met.

(c) The FAA will publish a notice of its reevaluation findings in the FEDERAL REGISTER and notify in writing the aircraft operator that petitioned the FAA for reevaluation and the affected airport operator.

### § 161.417 Notification of status of restrictions and agreements not meeting conditions-of-approval criteria.

If the FAA has withdrawn all or part of a previous approval made under subpart D of this part, the relevant portion of the Stage 3 restriction must be rescinded. The operator of the affected

## 14 CFR Ch. I (1–1–08 Edition)

airport shall notify the FAA of the operator's action with regard to a restriction affecting Stage 3 aircraft operations that has been found not to meet the criteria of §161.305. Restrictions in agreements determined by the FAA not to meet conditions for approval may not be enforced with respect to Stage 3 aircraft operations.

## Subpart F—Failure To Comply With This Part

### § 161.501 Scope.

(a) This subpart describes the procedures to terminate eligibility for airport grant funds and authority to impose or collect passenger facility charges for an airport operator's failure to comply with the Airport Noise and Capacity Act of 1990 (49 U.S.C. App. 2151 *et seq.*) or this part. These procedures may be used with or in addition to any judicial proceedings initiated by the FAA to protect the national aviation system and related Federal interests.

(b) Under no conditions shall any airport operator receive revenues under the provisions of the Airport and Airway Improvement Act of 1982 or impose or collect a passenger facility charge under section 1113(e) of the Federal Aviation Act of 1958 if the FAA determines that the airport is imposing any noise or access restriction not in compliance with the Airport Noise and Capacity Act of 1990 or this part. Rescission of, or a commitment in writing signed by an authorized official of the airport operator to rescind or permanently not enforce, a noncomplying restriction will be treated by the FAA as action restoring compliance with the Airport Noise and Capacity Act of 1990 or this part with respect to that restriction.

### § 161.503 Informal resolution; notice of apparent violation.

Prior to the initiation of formal action to terminate eligibility for airport grant funds or authority to impose or collect passenger facility charges under this subpart, the FAA shall undertake informal resolution with the airport operator to assure compliance with the Airport Noise and Capacity Act of 1990 or this part upon receipt of a complaint or other evidence that an

airport operator has taken action to impose a noise or access restriction that appears to be in violation. This shall not preclude a FAA application for expedited judicial action for other than termination of airport grants and passenger facility charges to protect the national aviation system and violated federal interests. If informal resolution is not successful, the FAA will notify the airport operator in writing of the apparent violation. The airport operator shall respond to the notice in writing not later than 20 days after receipt of the notice, and also state whether the airport operator will agree to defer implementation or enforcement of its noise or access restriction until completion of the process under this subpart to determine compliance.

**§ 161.505 Notice of proposed termination of airport grant funds and passenger facility charges.**

(a) The FAA begins proceedings under this section to terminate an airport operator's eligibility for airport grant funds and authority to impose or collect passenger facility charges only if the FAA determines that informal resolution is not successful.

(b) The following procedures shall apply if an airport operator agrees in writing, within 20 days of receipt of the FAA's notice of apparent violation under § 161.503, to defer implementation or enforcement of a noise or access restriction until completion of the process under this subpart to determine compliance.

(1) The FAA will issue a notice of proposed termination to the airport operator and publish notice of the proposed action in the FEDERAL REGISTER. This notice will state the scope of the proposed termination, the basis for the proposed action, and the date for filing written comments or objections by all interested parties. This notice will also identify any corrective action the airport operator can take to avoid further proceedings. The due date for comments and corrective action by the airport operator shall be specified in the notice of proposed termination and shall not be less than 60 days after publication of the notice.

(2) The FAA will review the comments, statements, and data supplied

by the airport operator, and any other available information, to determine if the airport operator has provided satisfactory evidence of compliance or has taken satisfactory corrective action. The FAA will consult with the airport operator to attempt resolution and may request additional information from other parties to determine compliance. The review and consultation process shall take not less than 30 days. If the FAA finds satisfactory evidence of compliance, the FAA will notify the airport operator in writing and publish notice of compliance in the FEDERAL REGISTER.

(3) If the FAA determines that the airport operator has taken action to impose a noise or access restriction in violation of the Airport Noise and Capacity Act of 1990 or this part, the FAA will notify the airport operator in writing of such determination. Where appropriate, the FAA may prescribe corrective action, including corrective action the airport operator may still need to take. Within 10 days of receipt of the FAA's determination, the airport operator shall—

(i) Advise the FAA in writing that it will complete any corrective action prescribed by the FAA within 30 days; or

(ii) Provide the FAA with a list of the domestic air carriers and foreign air carriers operating at the airport and all other issuing carriers, as defined in § 158.3 of this chapter, that have remitted passenger facility charge revenue to the airport in the preceding 12 months.

(4) If the FAA finds that the airport operator has taken satisfactory corrective action, the FAA will notify the airport operator in writing and publish notice of compliance in the FEDERAL REGISTER. If the FAA has determined that the airport operator has imposed a noise or access restriction in violation of the Airport Noise and Capacity Act of 1990 or this part and satisfactory corrective action has not been taken, the FAA will issue an order that—

(i) Terminates eligibility for new airport grant agreements and discontinues payments of airport grant funds, including payments of costs incurred prior to the notice; and

(ii) Terminates authority to impose or collect a passenger facility charge or, if the airport operator has not received approval to impose a passenger facility charge, advises the airport operator that future applications for such approval will be denied in accordance with § 158.29(a)(1)(v) of this chapter.

(5) The FAA will publish notice of the order in the FEDERAL REGISTER and notify air carriers of the FAA's order and actions to be taken to terminate or modify collection of passenger facility charges in accordance with § 158.85(f) of this chapter.

(c) The following procedures shall apply if an airport operator does not agree in writing, within 20 days of receipt of the FAA's notice of apparent violation under § 161.503, to defer implementation or enforcement of its noise or access restriction until completion of the process under this subpart to determine compliance.

(1) The FAA will issue a notice of proposed termination to the airport operator and publish notice of the proposed action in the FEDERAL REGISTER. This notice will state the scope of the proposed termination, the basis for the proposed action, and the date for filing written comments or objections by all interested parties. This notice will also identify any corrective action the airport operator can take to avoid further proceedings. The due date for comments and corrective action by the airport operator shall be specified in the notice of proposed termination and shall not be less than 30 days after publication of the notice.

(2) The FAA will review the comments, statements, and data supplied by the airport operator, and any other available information, to determine if the airport operator has provided satisfactory evidence of compliance or has taken satisfactory corrective action. If the FAA finds satisfactory evidence of compliance, the FAA will notify the airport operator in writing and publish notice of compliance in the FEDERAL REGISTER.

(3) If the FAA determines that the airport operator has taken action to impose a noise or access restriction in violation of the Airport Noise and Capacity Act of 1990 or this part, the pro-

cedures in paragraphs (b)(3) through (b)(5) of this section will be followed.

## **PART 169—EXPENDITURE OF FEDERAL FUNDS FOR NONMILITARY AIRPORTS OR AIR NAVIGATION FACILITIES THEREON**

Sec.

169.1 Applicability.

169.3 Application for recommendation and certification.

169.5 FAA determination.

AUTHORITY: 49 U.S.C. 106(g), 40101–40107, 40113–40114, 44501–44502, 46104, 47122, 47151–47153, 47302–47306.

### **§ 169.1 Applicability.**

(a) This part prescribes the requirements for issuing a written recommendation and certification that a proposed project is reasonably necessary for use in air commerce or in the interests of national defense. The first two sentences of section 308(a) of the Federal Aviation Act of 1958 (49 U.S.C. 1349(a)): (1) Require such a recommendation and certification where Federal funds are to be expended for nonmilitary purposes for airports or air navigation facilities thereon; and (2) provide that any interested person may apply to the Administrator, under regulations prescribed by him, for a recommendation and certification.

(b) This part does not apply to projects for the expenditure of Federal funds for military purposes or for airports, or air navigation facilities thereon, operated by the Federal Aviation Administration.

[Doc. No. 9256, 34 FR 5718, Mar. 27, 1969]

### **§ 169.3 Application for recommendation and certification.**

(a) Any interested person may apply to the Administrator for a recommendation and certification with respect to a proposed project for the acquisition, establishment, construction, alteration, repair, maintenance, or operation of an airport or an air navigation facility thereon by or in his interests, on which Federal funds are proposed to be expended for nonmilitary purposes. The application

shall be filed with the Regional Airports Division or Airports District Office, whichever is appropriate, in whose geographical area the airport is located. The application must state—

(1) The name and address of the applicant, the owner of the airport, and the individual responsible for its operation and maintenance, and the interest of the applicant in the matter;

(2) The location of the airport, and of any air navigation facilities thereon;

(3) A technical description of the project;

(4) The information contained in the notice required by §157.3 of this chapter; and

(5) All available pertinent data relating to the necessity of the airport or air navigation facility for use in air commerce including where applicable—

(i) The number and type of aircraft that use or would use the airport or facility;

(ii) The present and expected level of activity;

(iii) Any special use of the airport or facility such as its providing access to places of recreation as national forests or parks or to isolated communities where access by other means is not available or is curtailed by climatic condition; and

(iv) In the case of an airport or air navigation facility owned, operated, or maintained by a Federal agency other than the FAA, the relationship of the airport or facility to the performance of that agency's functions.

(b) Each of the following has the effect of a recommendation and certification, and a separate application under this part with respect thereto is not required:

(1) Approval of a project under section 16 of the Airport and Airway Development Act of 1970 (49 U.S.C. 1701).

(2) Inclusion of an airport in the National Airport System Plan, if—

(i) Notice of construction or alteration required by §157.3 of this chapter has been given; and

(ii) The Administrator has determined that there is no objection to the proposed construction or alteration.

[Doc. No. 9256, 34 FR 5718, Mar. 27, 1969, as amended by Amdt. 169-1, 37 FR 21322, Oct. 7, 1972; Amdt. 169-2, 54 FR 39295, Sept. 25, 1989]

#### § 169.5 FAA determination.

(a) The Administrator issues a recommendation and certification if he finds that the airport or facility is reasonably necessary for use in air commerce or in the interests of national defense; that it conforms to all applicable plans and policies for, and allocations of, airspace; and that it otherwise complies with requirements of Federal law properly considered by the Administrator. The Administrator may grant the recommendation and certification subject to conditions that ensure conformity of the airport or facility with these standards.

(b) A recommendation and certification under this part, express or implied, does not extend to a modified version of an airport or facility to which it applies, or to an additional area or facility at the same airport.

(c) If the application is denied the Administrator notifies the applicant of the grounds for the denial. The Administrator may revoke a recommendation and certification for proper cause.

(d) The authority of the Administrator under this part is exercised by Regional Airports Division Managers as to airports or facilities within their respective regions.

[Doc. No. 9256, 34 FR 5718, Mar. 27, 1969, as amended by Amdt. 169-1, 37 FR 21322, Oct. 7, 1972; Amdt. 169-2, 54 FR 39295, Sept. 25, 1989]

## SUBCHAPTER J—NAVIGATIONAL FACILITIES

### PART 170—ESTABLISHMENT AND DISCONTINUANCE CRITERIA FOR AIR TRAFFIC CONTROL SERVICES AND NAVIGATIONAL FACILITIES

#### Subpart A—General

Sec.

170.1 Scope.

170.3 Definitions.

#### Subpart B—Airport Traffic Control Towers

170.11 Scope.

170.13 Airport Traffic Control Tower (ATCT) establishment criteria.

170.15 ATCT discontinuance criteria.

#### Subpart C—LORAN-C

170.21 Scope.

170.23 LORAN-C establishment criteria.

170.25 LORAN-C discontinuance criteria.

AUTHORITY: 49 U.S.C. 106(g), 40103-40107, 40113, 44502, 44701-44702, 44708-44709, 44719, 44721-44722, 46308.

SOURCE: 56 FR 341, Jan. 3, 1991, unless otherwise noted.

#### Subpart A—General

##### § 170.1 Scope.

This subpart sets forth establishment and discontinuance criteria for navigation aids operated and maintained by the United States.

##### § 170.3 Definitions.

For purposes of this subpart—

*Air navigation facility* (NAVAID) means any facility used, available for use, or designated for use in the aid of air navigation. Included are landing areas; lights; signaling, radio direction-finding, or radio or other electronic communication; and any other structure or mechanism having a similar purpose of guiding or controlling flight or the landing or takeoff of aircraft.

*Air traffic clearance* means an authorization by air traffic control for an aircraft to proceed under specified traffic conditions within controlled airspace for the purpose of preventing collision between known aircraft.

*Air traffic control* (ATC) means a service that promotes the safe, orderly, and

expeditious flow of air traffic, including airport, approach, departure, and en route air traffic control.

*Air traffic controller* means a person authorized to provide air traffic service, specifically en route and terminal control personnel.

*Aircraft operations* means the airborne movement of aircraft in controlled or noncontrolled airport terminal areas, and counts at en route fixes or other points where counts can be made. There are two types of operations: local and itinerant.

(1) *Local operations* mean operations performed by aircraft which:

(i) Operate in the local traffic pattern or within sight of the airport;

(ii) Are known to be departing for, or arriving from flight in local practice areas located within a 20-mile radius of the airport; or

(iii) Execute simulated instrument approaches or low passes at the airport.

(2) *Itinerant operations* mean all aircraft operations other than local operations.

*Airport traffic control tower* means a terminal facility, which through the use of air/ground communications, visual signaling, and other devices, provides ATC services to airborne aircraft operating in the vicinity of an airport and to aircraft operating on the airport area.

*Alternate airport* means an airport, specified on a flight plan, to which a flight may proceed when a landing at the point of first intended landing becomes inadvisable.

*Approach* means the flight path established by the FAA to be used by aircraft landing on a runway.

*Approach control facility* means a terminal air traffic control facility providing approach control service.

*Arrival* means any aircraft arriving at an airport.

*Benefit-cost ratio* means the quotient of the discounted life cycle benefits of an air traffic control service or navigation aid facility (i.e., ATCT) divided by the discounted life cycle costs.

*Ceiling* means the vertical distance between the ground or water and the

lowest layer of clouds or obscuring phenomena that is reported as “broken,” “overcast,” or “obstruction.”

*Control Tower*—See Airport Traffic Control Tower.

*Criteria* means the standards used by the FAA for the determination of establishment or discontinuance of a service or facility at an airport.

*Departure* means any aircraft taking off from an airport.

*Discontinuance* means the withdrawal of a service and/or facility from an airport.

*Establishment* means the provision of a service or facility at a candidate airport.

*Instrument approach* means a series of predetermined maneuvers for the orderly transfer of an aircraft under instrument flight conditions from the beginning of the initial approach to a landing, or to a point from which a landing may be made visually. It is prescribed and approved for a specific airport by competent authority.

*Instrument flight rules (IFR)* means rules governing the procedures for conducting flight under instrument meteorological conditions (IMC) instrument flight.

*Instrument landing system (ILS)* means an instrument landing system whereby the pilot guides his approach to a runway solely by reference to instruments in the cockpit. In some instances, the signals received from the ground can be fed into the automatic pilot for automatically controlled approaches.

*Instrument meteorological conditions (IMC)* means weather conditions below the minimums prescribed for flight under Visual Flight Rules (VFR).

*Instrument operation* means an aircraft operation in accordance with an IFT flight plan or an operation where IFR separation between aircraft is provided by a terminal control facility or air route traffic control center (ARTCC).

*Life cycle benefits* means the value of services provided to aviation users over the life span of a facility or service.

*Life cycle costs* means the value of research and development costs, investment costs, operation costs, maintenance costs, and termination costs over the life span of a facility or service.

*LORAN-C* means an electronic navigational system by which hyperbolic lines of position are determined by measuring differences in time of reception of synchronized pulse signals from two fixed transmitters.

*Maintenance costs* means the costs incurred in servicing and maintaining a facility after establishment.

*Mean sea level (MSL)* means the base commonly used in measuring altitudes.

*Microwave landing system (MLS)* means a landing system which enables equipped aircraft to make curved and closely spaced approaches to properly instrumented airports.

*Noncommercial traffic* means all aircraft operations that are conducted free of compensation.

*Nonprecision approach procedure* means an FAA standard for approaching an IFR runway where no electronic glide slope is available.

*Nonscheduled commercial service* means the carriage by aircraft in air commerce of persons or property for compensation or hire that are not operated in regularly scheduled service such as charter flights.

*Present value (PV)* means the value of a stream of future benefits or costs that are discounted to the present.

*PVB* or *BPV* means the discounted value of life cycle benefits.

*PVC* or *CPV* means the discounted value of life cycle benefits.

*PVCM* or *CMPV* means the discounted value of operations and maintenance costs less termination costs over a facility’s remaining life cycle.

*Runway* means a defined rectangular area on a land airport prepared for the landing and takeoff of aircraft along its length.

*Runway visual range* means an instrumentally derived value based on standard calibrations that represent the horizontal distance a pilot will see down the runway from the approach end.

*Scheduled commercial service* means the carriage by aircraft in air commerce under parts 121 and 135 of persons or property for compensation or hire based on published flight schedules.

*Separation* means the spacing of aircraft in flight and while landing and taking off to achieve their safe and orderly movement.

## § 170.11

## 14 CFR Ch. I (1-1-08 Edition)

*Takeoff clearance* means authorization by an airport traffic control tower for an aircraft to take off.

*Tower cab* means an ATC facility located at an airport. Controllers at these facilities direct ground traffic, takeoffs, and landings.

*Traffic advisories* means advisories issued to alert pilots to other known or observed air traffic which may be in such proximity to the position or intended route of flight of their aircraft to warrant attention.

*Traffic pattern* means the flow of aircraft operating on and in the vicinity of an airport during specified wind conditions as established by appropriate authority.

*VFR traffic* means aircraft operated solely in accordance with Visual Flight Rules.

*Visual flight rules (VFR)* means rules that govern the procedures for conducting flight under visual conditions. The term “VFR” is also used in the United States to indicate weather conditions that are equal to or greater than minimum VFR requirements. In addition, “VFR” is used by pilots and controllers to indicate the type of flight plan.

*Visual meteorological conditions (VMC)* means meteorological conditions expressed in terms of visibility, distance from clouds, and ceiling equal to or better than specified minima.

[56 FR 341, Jan. 3, 1991, as amended by Amdt. 170-3, 66 FR 21067, Apr. 27, 2001]

### Subpart B—Airport Traffic Control Towers

#### § 170.11 Scope.

This subpart sets forth establishment and discontinuance criteria for Airport Traffic Control Towers.

#### § 170.13 Airport Traffic Control Tower (ATCT) establishment criteria.

(a) The following criteria along with general facility establishment standards must be met before an airport can qualify for an ATCT:

(1) The airport, whether publicly or privately owned, must be open to and available for use by the public as defined in the Airport and Airway Improvement Act of 1982;

(2) The airport must be recognized by and contained within the National Plan of Integrated Airport Systems;

(3) The airport owners/authorities must have entered into appropriate assurances and covenants to guarantee that the airport will continue in operation for a long enough period to permit the amortization of the ATCT investment;

(4) The FAA must be furnished appropriate land without cost for construction of the ATCT; and

(5) The airport must meet the benefit-cost ratio criteria specified herein utilizing three consecutive FAA annual counts and projections of future traffic during the expected life of the tower facility. (An FAA annual count is a fiscal year or a calendar year activity summary. Where actual traffic counts are unavailable or not recorded, adequately documented FAA estimates of the scheduled and nonscheduled activity may be used.)

(b) An airport meets the establishment criteria when it satisfies paragraphs (a)(1) through (a)(5) of this section and its benefit-cost ratio equals or exceeds one. As defined in § 170.3 of this part, the benefit-cost ratio is the ratio of the present value of the ATCT life cycle benefits (BPV) to the present value of ATCT life cycle costs (CPV).

BPV/CPV $\geq$ 1.0

(c) The satisfaction of all the criteria listed in this section does not guarantee that the airport will receive an ATCT.

#### § 170.15 ATCT discontinuance criteria.

An ATCT will be subject to discontinuance when the continued operation and maintenance costs less termination costs (CMPV) of the ATCT exceed the present value of its remaining life-cycle benefits (BPV):

BPV/CMPV $<$ 1.0

### Subpart C—LORAN-C

SOURCE: Amdt. 170-1, 58 FR 42817, Aug. 11, 1993, unless otherwise noted.

**§ 170.21 Scope.**

This subpart sets forth establishment and discontinuance criteria for LORAN-C.

**§ 170.23 LORAN-C establishment criteria.**

(a) The criteria in paragraphs (a)(1) through (a)(6) of this section, along with general facility and navigational aid establishment requirements, must be met before a runway can be eligible for LORAN-C approach.

(1) A runway must have landing surfaces judged adequate by the FAA to accommodate aircraft expected to use the approach and meet all FAA-required airport design criteria for non-precision runways.

(2) A runway must be found acceptable for instrument flight rules operations as a result of an airport airspace analysis conducted in accordance with the current FAA regulations and provisions.

(3) The LORAN-C signal must be of sufficient quality and accuracy to pass an FAA flight inspection.

(4) It must be possible to remove, mark, or light all approach obstacles in accordance with FAA marking and lighting provisions.

(5) Appropriate weather information must be available.

(6) Air-to-ground communications must be available at the initial approach fix minimum altitude and at the missed approach altitude.

(b) A runway meets the establishment criteria for a LORAN-C approach when it satisfies paragraphs (a)(1) through (a)(6) of this section and the estimated value of benefits associated with the LORAN-C approach equals or exceeds the estimated costs (benefit-cost ratio equals or exceeds one). As defined in §170.3 of this part, the benefit-cost ratio is the ratio of the present value of the LORAN-C life-cycle benefits (PVB) to the present value of LORAN-C life-cycle costs (PVC):

$$PVB/PVC \geq 1.0$$

(c) The criteria do not cover all situations that may arise and are not used as a sole determinant in denying or granting the establishment of non-precision LORAN-C approach for which

there is a demonstrated operational or air traffic control requirement.

**§ 170.25 LORAN-C discontinuance criteria.**

A LORAN-C nonprecision approach may be subject to discontinuance when the present value of the continued maintenance costs (PVCM) of the LORAN-C approach exceed the present value of its remaining life-cycle benefits (PVB):

$$PVB/PVCM < 1.0$$

**PART 171—NON-FEDERAL NAVIGATION FACILITIES****Subpart A—VOR Facilities**

Sec.

- 171.1 Scope.
- 171.3 Requests for IFR procedure.
- 171.5 Minimum requirements for approval.
- 171.7 Performance requirements.
- 171.9 Installation requirements.
- 171.11 Maintenance and operations requirements.
- 171.13 Reports.

**Subpart B—Nondirectional Radio Beacon Facilities**

- 171.21 Scope.
- 171.23 Requests for IFR procedure.
- 171.25 Minimum requirements for approval.
- 171.27 Performance requirements.
- 171.29 Installation requirements.
- 171.31 Maintenance and operations requirements.
- 171.33 Reports.

**Subpart C—Instrument Landing System (ILS) Facilities**

- 171.41 Scope.
- 171.43 Requests for IFR procedure.
- 171.45 Minimum requirements for approval.
- 171.47 Performance requirements.
- 171.49 Installation requirements.
- 171.51 Maintenance and operations requirements.
- 171.53 Reports.

**Subpart D—True Lights**

- 171.61 Air navigation certificate: Revocation and termination.

**Subpart E—General**

- 171.71 Materials incorporated by reference.
- 171.73 Alternative forms of reports.
- 171.75 Submission of requests.

## § 171.1

## 14 CFR Ch. I (1–1–08 Edition)

### Subpart F—Simplified Directional Facility (SDF)

- 171.101 Scope.
- 171.103 Requests for IFR procedure.
- 171.105 Minimum requirements for approval.
- 171.107 Definition.
- 171.109 Performance requirements.
- 171.111 Ground standards and tolerances.
- 171.113 Installation requirements.
- 171.115 Maintenance and operations requirements.
- 171.117 Reports.

### Subpart G—Distance Measuring Equipment (DME)

- 171.151 Scope.
- 171.153 Requests for IFR procedure.
- 171.155 Minimum requirements for approval.
- 171.157 Performance requirements.
- 171.159 Installation requirements.
- 171.161 Maintenance and operations requirements.
- 171.163 Reports.

### Subpart H—VHF Marker Beacons

- 171.201 Scope.
- 171.203 Requests for IFR procedure.
- 171.205 Minimum requirements for approval.
- 171.207 Performance requirements.
- 171.209 Installation requirements.
- 171.211 Maintenance and operations requirements.
- 171.213 Reports.

### Subpart I—Interim Standard Microwave Landing System (ISMLS)

- 171.251 Scope.
- 171.253 Definitions.
- 171.255 Requests for IFR procedures.
- 171.257 Minimum requirements for approval.
- 171.259 Performance requirements: General.
- 171.261 Localizer performance requirements.
- 171.263 Localizer automatic monitor system.
- 171.265 Glide path performance requirements.
- 171.267 Glide path automatic monitor system.
- 171.269 Marker beacon performance requirements.
- 171.271 Installation requirements.
- 171.273 Maintenance and operations requirements.
- 171.275 Reports.

### Subpart J—Microwave Landing System (MLS)

- 171.301 Scope.
- 171.303 Definitions.
- 171.305 Requests for IFR procedure.
- 171.307 Minimum requirements for approval.
- 171.309 General requirements.

- 171.311 Signal format requirements.
- 171.313 Azimuth performance requirements.
- 171.315 Azimuth monitor system requirements.
- 171.317 Approach elevation performance requirements.
- 171.319 Approach elevation monitor system requirements.
- 171.321 DME and marker beacon performance requirements.
- 171.323 Fabrication and installation requirements.
- 171.325 Maintenance and operations requirements.
- 171.327 Operational records.

AUTHORITY: 49 U.S.C. 106(g), 40103–40107, 40109, 40113, 44502, 44701–44702, 44708–44709, 44711, 44719–44721, 45303, 46308.

SOURCE: Docket No. 5034, 29 FR 11337, Aug. 6, 1964, unless otherwise noted.

### Subpart A—VOR Facilities

#### § 171.1 Scope.

This subpart sets forth minimum requirements for the approval and operation on non-Federal VOR facilities that are to be involved in the approval of instrument flight rules and air traffic control procedures related to those facilities.

[Doc. No. 5034, 29 FR 11337, Aug. 6, 1964, as amended by Amdt. 171–2, 31 FR 5408, Apr. 6, 1966; Amdt. 171–7, 35 FR 12711, Aug. 11, 1970]

#### § 171.3 Requests for IFR procedure.

(a) Each person who requests an IFR procedure based on a VOR facility that he owns must submit the following information with that request:

(1) A description of the facility and evidence that the equipment meets the performance requirements of § 171.7 and is installed in accordance with § 171.9.

(2) A proposed procedure for operating the facility.

(3) A proposed maintenance organization and maintenance manual that meets the requirements of § 171.11.

(4) A statement of intention to meet the requirements of this subpart.

(5) A showing that the facility has an acceptable level of operational reliability and an acceptable standard of performance. Previous equivalent operational experience with a facility with identical design and operational characteristics will be considered in showing compliance with this paragraph.

(b) After the FAA inspects and evaluates the facility, it advises the owner of the results and of any required changes in the facility or the maintenance manual or maintenance organization. The owner must then correct the deficiencies, if any, and operate the facility for an in-service evaluation by the FAA.

[Doc. No. 5034, 29 FR 11337, Aug. 6, 1964, as amended by Amdt. 171-7, 35 FR 12711, Aug. 11, 1970]

**§ 171.5 Minimum requirements for approval.**

(a) The following are the minimum requirements that must be met before the FAA will approve an IFR procedure for a non-Federal VOR:

(1) The facility's performance, as determined by air and ground inspection, must meet the requirements of § 171.7.

(2) The installation of the equipment must meet the requirements of § 171.9.

(3) The owner must agree to operate and maintain the facility in accordance with § 171.11.

(4) The owner must agree to furnish periodic reports, as set forth in § 171.13, and must agree to allow the FAA to inspect the facility and its operation whenever necessary.

(5) The owner must assure the FAA that he will not withdraw the facility from service without the permission of the FAA.

(6) The owner must bear all costs of meeting the requirements of this section and of any flight or ground inspections made before the facility is commissioned, except that the Federal Aviation Administration may bear certain of these costs subject to budgetary limitations and policy established by the Administrator.

(b) If the applicant for approval meets the requirements of paragraph (a) of this section, the FAA commissions the facility as a prerequisite to its approval for use in an IFR procedure. The approval is withdrawn at any time the facility does not continue to meet those requirements.

[Doc. No. 5034, 29 FR 11337, Aug. 6, 1964, as amended by Amdt. 171-6, 35 FR 10288, June 24, 1970]

**§ 171.7 Performance requirements.**

(a) The VOR must perform in accordance with the "International Standards and Recommended Practices, Aeronautical Telecommunications," Part I, paragraph 3.3 (Annex 10 to the Convention on International Civil Aviation), except that part of paragraph 3.3.2.1 specifying a radio frequency tolerance of 0.005 percent, and that part of paragraph 3.3.7 requiring removal of only the bearing information. In place thereof, the frequency tolerance of the radio frequency carrier must not exceed plus or minus 0.002 percent, and all radiation must be removed during the specified deviations from established conditions and during periods of monitor failure.

(b) Ground inspection consists of an examination of the design features of the equipment to determine that there will not be conditions that will allow unsafe operations because of component failure or deterioration.

(c) The monitor is checked periodically, during the in-service test evaluation period, for calibration and stability. The tests are made with a standard "Reference and variable phase signal generator" and associated test equipment, including an oscilloscope and portable field detector. In general, the ground check is conducted in accordance with section 8.4 of FAA Handbook AF P 6790.9 "Maintenance Instruction for VHF Omnidirections", adapted for the facility concerned.

(d) Flight tests to determine the facility's adequacy for operational requirements and compliance with applicable "Standards and Recommended Practices" are conducted in accordance with the "U.S. Standard Flight Inspection Manual", particularly section 201.

(e) After January 1, 1975, the owner of the VOR shall modify the facility to perform in accordance with paragraph 3.3.5.7 of Annex 10 to the Convention on International Civil Aviation within 180 days after receipt of notice from the Administrator that 50 kHz channel spacing is to be implemented in the area and that a requirement exists for suppression of 9960 Hz subcarrier harmonics.

[Doc. No. 5034, 29 FR 11337, Aug. 6, 1964, as amended by Amdt. 171-7, 35 FR 12711, Aug. 11, 1970; Amdt. 171-9, 38 FR 28557, Oct. 15, 1973]

## § 171.9

### § 171.9 Installation requirements.

(a) The facility must be installed according to accepted good engineering practices, applicable electric and safety codes, and the installation must meet at least the Federal Communication Commission's licensing requirements.

(b) The facility must have a reliable source of suitable primary power, either from a power distribution system or locally generated, with a supplemental standby system, if needed.

(c) Dual transmitting equipment with automatic changeover is preferred and may be required to support certain IFR procedures.

(d) There must be a means for determining, from the ground, the performance of the equipment, including the antenna, initially and periodically.

(e) A facility intended for use as an instrument approach aid for an airport must have or be supplemented by (depending on circumstances) the following ground-air or landline communications services:

(1) At facilities outside of and not immediately adjacent to controlled airspace, there must be ground-air communications from the airport served by the facility. Separate communications channels are acceptable.

(2) At facilities within or immediately adjacent to controlled airspace, there must be the ground-air communications required by paragraph (e)(1) of this section and reliable communications (at least a landline telephone) from the airport to the nearest FAA air traffic control or communication facility.

Paragraphs (e) (1) and (2) of this section are not mandatory at airports where an adjacent FAA facility can communicate with aircraft on the ground at the airport and during the entire proposed instrument approach procedure. In addition, at low traffic density airports within or immediately adjacent to controlled airspace and where extensive delays are not a factor, the requirements of paragraphs (e) (1) and (2) of this section may be reduced to reliable communications (at least a landline telephone) from the airport to the nearest FAA air traffic control or communication facility, if an adjacent FAA facility can commu-

## 14 CFR Ch. I (1-1-08 Edition)

nicate with aircraft during the proposed instrument approach procedure, at least down to the minimum en route altitude for the controlled airspace area.

[Doc. No. 5034, 29 FR 11337, Aug. 6, 1964, as amended by Amdt. 171-7, 35 FR 12711, Aug. 11, 1970; Amdt. 171-16, 56 FR 65664, Dec. 17, 1991]

### § 171.11 Maintenance and operations requirements.

(a) The owner of the facility must establish an adequate maintenance system and provide qualified maintenance personnel to maintain the facility at the level attained at the time it was commissioned. Each person who maintains a facility must meet at least the Federal Communications Commission's licensing requirements and show that he has the special knowledge and skills needed to maintain the facility including proficiency in maintenance procedures and the use of specialized test equipment.

(b) The owner must prepare, and obtain FAA approval of, an operations and maintenance manual that sets forth mandatory procedures for operations, preventive maintenance, and emergency maintenance, including instructions on each of the following:

(1) Physical security of the facility.

(2) Maintenance and operations by authorized persons only.

(3) FCC licensing requirements for operating and maintenance personnel.

(4) Posting of licenses and signs.

(5) Relations between the facility and FAA air traffic control facilities, with a description of the boundaries of controlled airspace over or near the facility, instructions for relaying air traffic control instructions and information (if applicable), and instructions for the operation of an air traffic advisory service if the VOR is located outside of controlled airspace.

(6) Notice to the Administrator of any suspension of service.

(7) Detailed and specific maintenance procedures and servicing guides stating the frequency of servicing.

(8) Air-ground communications, if provided, expressly written or incorporating appropriate sections of FAA manuals by reference.

(9) Keeping of station logs and other technical reports, and the submission of reports required by § 171.13.

(10) Monitoring of the facility.

(11) Inspections by United States personnel.

(12) Names, addresses, and telephone numbers of persons to be notified in an emergency.

(13) Shutdowns for routine maintenance and issue of "Notices to Airmen" for routine or emergency shutdowns (private use facilities may omit the "Notices to Airmen").

(14) An explanation of the kinds of activity (such as construction or grading) in the vicinity of the facility that may require shutdown or recertification of the facility by FAA flight check.

(15) Procedures for conducting a ground check of course accuracy.

(16) Commissioning of the facility.

(17) An acceptable procedure for amending or revising the manual.

(18) The following information concerning the facility:

(i) Location by latitude and longitude to the nearest second, and its position with respect to airport layouts.

(ii) The type, make, and model of the basic radio equipment that will provide the service.

(iii) The station power emission and frequency.

(iv) The hours of operation.

(v) Station identification call letters and method of station identification, whether by Morse code or recorded voice announcement, and the time spacing of the identification.

(vi) A description of the critical parts that may not be changed, adjusted, or repaired without an FAA flight check to confirm published operations.

(c) The owner shall make a ground check of course accuracy each month in accordance with procedures approved by the FAA at the time of commissioning, and shall report the results of the checks as provided in § 171.13.

(d) If the owner desires to modify the facility, he must submit the proposal to the FAA and may not allow any modifications to be made without specific approval.

(e) The owner's maintenance personnel must participate in initial in-

spections made by the FAA. In the case of subsequent inspections, the owner or his representative shall participate.

(f) Whenever it is required by the FAA, the owner shall incorporate improvements in VOR maintenance brought about by progress in the state of the art. In addition, he shall provide a stock of spare parts, including vacuum tubes, of such a quantity to make possible the prompt replacement of components that fail or deteriorate in service.

(g) The owner shall provide all approved test instruments needed for maintenance of the facility.

(h) The owner shall close the facility upon receiving two successive pilot reports of its malfunctioning.

[Doc. No. 5034, 29 FR 11337, Aug. 6, 1964, as amended by Amdt. 171-2, 31 FR 5408, Apr. 6, 1966]

#### § 171.13 Reports.

The owner of each facility to which this subpart applies shall make the following reports on forms furnished by the FAA, at the times indicated, to the FAA Regional office for the area in which the facility is located:

(a) *Record of meter readings and adjustments (Form FAA-198)*. To be filled out by the owner with the equipment adjustments and meter readings as of the time of commissioning, with one copy to be kept in the permanent records of the facility and two copies to the appropriate Regional office of the FAA. The owner shall revise the form after any major repair, modernization, or returning, to reflect an accurate record of facility operation and adjustment.

(b) *Facility maintenance log (FAA Form 6003-1)*. This form is a permanent record of all equipment malfunctioning met in maintaining the facility, including information on the kind of work and adjustments made, equipment failures, causes (if determined), and corrective action taken. The owner shall keep the original of each report at the facility and send a copy to the appropriate Regional office of the FAA at the end of the month in which it is prepared.

(c) *Radio equipment operation record (Form FAA-418)*. To contain a complete record of meter readings, recorded on each scheduled visit to the facility.

## § 171.21

## 14 CFR Ch. I (1–1–08 Edition)

The owner shall keep the original of each month's record at the facility and send a copy of it to the appropriate Regional office of the FAA.

(d) [Reserved]

(e) *VOR ground check error data (Forms FAA-2396 and 2397)*. To contain results of the monthly course accuracy ground check in accordance with FAA Handbook AF P 6790.9 "Maintenance Instructions for VHF Omnidirectional Radio Beacons". The owner shall keep the originals in the facility and send a copy of each form to the appropriate Regional office of the FAA on a monthly basis.

(49 U.S.C. 1348)

[Doc. No. 5034, 29 FR 11337, Aug. 6, 1964, as amended by Amdt. 171-5, 34 FR 15245, Sept. 30, 1969; Amdt. 171-10, 40 FR 36110, Aug. 19, 1975]

### Subpart B—Nondirectional Radio Beacon Facilities

#### § 171.21 Scope.

(a) This subpart sets forth minimum requirements for the approval and operation of non-Federal, nondirectional radio beacon facilities that are to be involved in the approval of instrument flight rules and air traffic control procedures related to those facilities.

(b) A nondirectional radio beacon ("H" facilities domestically—NDB facilities internationally) radiates a continuous carrier of approximately equal intensity at all azimuths. The carrier is modulated at 1020 cycles per second for station identification purposes.

[Doc. No. 5034, 29 FR 11337, Aug. 6, 1964, as amended by Amdt. 171-2, 31 FR 5408, Apr. 6, 1966; Amdt. 171-7, 35 FR 12711, Aug. 11, 1970]

#### § 171.23 Requests for IFR procedure.

(a) Each person who requests an IFR procedure based on a nondirectional radio beacon facility that he owns must submit the following information with that request:

(1) A description of the facility and evidence that the equipment meets the performance requirements of §171.27 and is installed in accordance with §171.29.

(2) A proposed procedure for operating the facility.

(3) A proposed maintenance arrangement and a maintenance manual that meets the requirements of §171.31.

(4) A statement of intention to meet the requirements of this subpart.

(5) A showing that the facility has an acceptable level of operational reliability and an acceptable standard of performance. Previous equivalent operational experience with a facility with identical design and operational characteristics will be considered in showing compliance with this subparagraph.

(b) After the FAA inspects and evaluates the facility, it advises the owner of the results and of any required changes in the facility or the maintenance manual or maintenance organization. The owner must then correct the deficiencies, if any, and operate the facility for an in-service evaluation by the FAA.

[Doc. No. 5034, 29 FR 11337, Aug. 6, 1964, as amended by Amdt. 171-7, 35 FR 12711, Aug. 11, 1970]

#### § 171.25 Minimum requirements for approval.

(a) The following are the minimum requirements that must be met before the FAA will approve an IFR procedure for a non-Federal, nondirectional radio beacon facility under this subpart:

(1) The facility's performances, as determined by air and ground inspection, must meet the requirements of §171.27.

(2) The installation of the equipment must meet the requirements of §171.29.

(3) The owner must agree to operate and maintain the facility in accordance with §171.31.

(4) The owner must agree to furnish periodic reports, as set forth in §171.33, and agree to allow the FAA to inspect the facility and its operation whenever necessary.

(5) The owner must assure the FAA that he will not withdraw the facility from service without the permission of the FAA.

(6) The owner must bear all costs of meeting the requirements of this section and of any flight or ground inspections made before the facility is commissioned, except that the Federal Aviation Administration may bear certain of these costs subject to budgetary limitations and policy established by the Administrator.

(b) If the applicant for approval meets the requirements of paragraph (a) of this section, the FAA commissions the facility as a prerequisite to its approval for use in an IFR procedure. The approval is withdrawn at any time the facility does not continue to meet those requirements. In addition, the facility may be de-commissioned whenever the frequency channel is needed for higher priority common system service.

[Doc. No. 5034, 29 FR 11337, Aug. 6, 1964, as amended by Amdt. 171-6, 35 FR 10288, June 24, 1970]

#### § 171.27 Performance requirements.

(a) The facility must meet the performance requirements set forth in the "International Standards and Recommended Practices, Aeronautical Telecommunications, Part I, paragraph 3.4" (Annex 10 to the Convention on International Civil Aviation), except that identification by on-off keying of a second carrier frequency, separated from the main carrier by 1020 Hz plus or minus 50 Hz, is also acceptable.

(b) The facility must perform in accordance with recognized and accepted good electronic engineering practices for the desired service.

(c) Ground inspection consists of an examination of the design features of the equipment to determine (based on recognized and accepted good engineering practices) that there will not be conditions that will allow unsafe operations because of component failure or deterioration.

(d) Flight tests to determine the facility's adequacy for operational requirements and compliance with applicable "Standards and Recommended Practices" are conducted in accordance with the "U.S. Standard Flight Inspection Manual", particularly section 207. The original test is made by the FAA and later tests shall be made under arrangements, satisfactory to the FAA, that are made by the owner.

[Doc. No. 5034, 29 FR 11337, Aug. 6, 1964, as amended by Amdt. 171-7, 35 FR 12711, Aug. 11, 1970]

#### § 171.29 Installation requirements.

(a) The facility must be installed according to accepted good engineering practices, applicable electric and safe-

ty codes, and FCC licensing requirements.

(b) The facility must have a reliable source of suitable primary power.

(c) Dual transmitting equipment may be required to support some IFR procedures.

(d) A facility intended for use as an instrument approach aid for an airport must have or be supplemented by (depending on the circumstances) the following ground-air or landline communications services:

(1) At facilities outside of and not immediately adjacent to controlled airspace, there must be ground-air communications from the airport served by the facility. Voice on the aid controlled from the airport is acceptable.

(2) At facilities within or immediately adjacent to controlled airspace, there must be the ground-air communications required by paragraph (d)(1) of this section and reliable communications (at least a landline telephone) from the airport to the nearest FAA air traffic control or communication facility.

Paragraphs (d) (1) and (2) of this section are not mandatory at airports where an adjacent FAA facility can communicate with aircraft on the ground at the airport and during the entire proposed instrument approach procedure. In addition, at low traffic density airports within or immediately adjacent to controlled airspace, and where extensive delays are not a factor, the requirements of paragraphs (d) (1) and (2) of this section may be reduced to reliable communications (at least a landline telephone) from the airport to the nearest FAA air traffic control or communications facility, if an adjacent FAA facility can communicate with aircraft during the proposed instrument approach procedure, at least down to the minimum en route altitude for the controlled airspace area.

[Doc. No. 5034, 29 FR 11337, Aug. 6, 1964, as amended by Amdt. 171-16, 56 FR 65664, Dec. 17, 1991]

#### § 171.31 Maintenance and operations requirements.

(a) The owner of the facility must establish an adequate maintenance system and provide qualified maintenance

**§ 171.33**

**14 CFR Ch. I (1-1-08 Edition)**

personnel to maintain the facility at the level attained at the time it was commissioned. Each person who maintains a facility must meet at least the Federal Communications Commission's licensing requirements and show that he has the special knowledge and skills needed to maintain the facility including proficiency in maintenance procedures and the use of specialized test equipment.

(b) The owner must prepare, and obtain approval of, an operations and maintenance manual that sets forth mandatory procedures for operations, preventive maintenance, and emergency maintenance, including instructions on each of the following:

- (1) Physical security of the facility.
- (2) Maintenance and operations by authorized persons only.
- (3) FCC licensing requirements for operating and maintenance personnel.
- (4) Posting of licenses and signs.
- (5) Relations between the facility and FAA air traffic control facilities, with a description of the boundaries of controlled airspace over or near the facility, instructions for relaying air traffic control instructions and information (if applicable), and instructions for the operation of an air traffic advisory service if the facility is located outside of controlled airspace.
- (6) Notice to the Administrator of any suspension of service.
- (7) Detailed arrangements for maintenance flight inspection and servicing stating the frequency of servicing.
- (8) Air-ground communications, if provided, expressly written or incorporating appropriate sections of FAA manuals by reference.
- (9) Keeping of station logs and other technical reports, and the submission of reports required by § 171.33.
- (10) Monitoring of the facility, at least once each half hour, to assure continuous operation.
- (11) Inspections by United States personnel.
- (12) Names, addresses, and telephone numbers of persons to be notified in an emergency.
- (13) Shutdowns for routine maintenance and issue of "Notices to Airmen" for routine or emergency shutdowns (private use facilities may omit the "Notices to Airmen").

- (14) Commissioning of the facility.
- (15) An acceptable procedure for amending or revising the manual.
- (16) The following information concerning the facility:
  - (i) Location by latitude and longitude to the nearest second, and its position with respect to airport layouts.
  - (ii) The type, make, and model of the basic radio equipment that will provide the service.
  - (iii) The station power emission and frequency.
  - (iv) The hours of operation.
  - (v) Station identification call letters and method of station identification, whether by Morse code or recorded voice announcement, and the time spacing of the identification.
- (c) If the owner desires to modify the facility, he must submit the proposal to the FAA and meet applicable requirements of the FCC.
- (d) The owner's maintenance personnel must participate in initial inspections made by the FAA. In the case of subsequent inspections, the owner or his representative shall participate.
- (e) The owner shall provide a stock of spare parts, including vacuum tubes, of such a quantity to make possible the prompt replacement of components that fail or deteriorate in service.
- (f) The owner shall close the facility upon receiving two successive pilot reports of its malfunctioning.

[Doc. No. 5034, 29 FR 11337, Aug. 6, 1964, as amended by Amdt. 171-2, 31 FR 5408, Apr. 6, 1966]

**§ 171.33 Reports.**

The owner of each facility to which this subpart applies shall make the following reports, at the times indicated, to the FAA Regional office for the area in which the facility is located:

- (a) *Record of meter readings and adjustments (Form FAA-198)*. To be filled out by the owner or his maintenance representative with the equipment adjustments and meter readings as of the time of commissioning, with one copy to be kept in the permanent records of the facility and two copies to the appropriate Regional Office of the FAA. The owner shall revise the form after

any major repair, modernization, or re-turning, to reflect an accurate record of facility operation and adjustment.

(b) *Facility maintenance log (FAA Form 6030-1)*. This form is a permanent record of all equipment malfunctioning met in maintaining the facility, including information on the kind of work and adjustments made, equipment failures, causes (if determined), and corrective action taken. The owner shall keep the original of each report at the facility and send a copy to the appropriate Regional Office of the FAA at the end of the month in which it is prepared.

(c) *Radio equipment operation record (Form FAA-418)*. To contain a complete record of meter readings, recorded on each scheduled visit to the facility. The owner shall keep the original of each month's record at the facility and send a copy of it to the appropriate Regional Office of the FAA.

[Doc. No. 5034, 29 FR 11337, Aug. 6, 1964, as amended by Amdt. 171-10, 40 FR 36110, Aug. 19, 1975]

### Subpart C—Instrument Landing System (ILS) Facilities

#### § 171.41 Scope.

This subpart sets forth minimum requirements for the approval and operation of non-Federal Instrument Landing System (ILS) Facilities that are to be involved in the approval of instrument flight rules and air traffic control procedures related to those facilities.

[Doc. No. 5034, 29 FR 11337, Aug. 6, 1964, as amended by Amdt. 171-2, 31 FR 5408, Apr. 6, 1966; Amdt. 171-7, 35 FR 12711, Aug. 11, 1970]

#### § 171.43 Requests for IFR procedure.

(a) Each person who requests an IFR procedure based on an ILS facility that he owns must submit the following information with that request:

(1) A description of the facility and evidence that the equipment meets the performance requirements of §171.47 and is installed in accordance with §171.49.

(2) A proposed procedure for operating the facility.

(3) A proposed maintenance organization and a maintenance manual that meets the requirements of §171.51.

(4) A statement of intent to meet the requirements of this subpart.

(5) A showing that the facility has an acceptable level of operational reliability and an acceptable standard of performance. Previous equivalent operational experience with a facility with identical design and operational characteristics will be considered in showing compliance with this subparagraph.

(b) After the FAA inspects and evaluates the facility, it advises the owner of the results and of any required changes in the facility or the maintenance manual or maintenance organization. The owner must then correct the deficiencies, if any, and operate the facility for an in-service evaluation by the FAA.

[Doc. No. 5034, 29 FR 11337, Aug. 6, 1964, as amended by Amdt. 171-7, 35 FR 12711, Aug. 11, 1970]

#### § 171.45 Minimum requirements for approval.

(a) The following are the minimum requirements that must be met before the FAA will approve an IFR procedure for a non-Federal Instrument Landing System:

(1) The facility's performance, as determined by air and ground inspection, must meet the requirements of §171.47.

(2) The installation of the equipment must meet the requirements of §171.49.

(3) The owner must agree to operate and maintain the facility in accordance with §171.51.

(4) The owner must agree to furnish periodic reports, as set forth in §171.53 and agree to allow the FAA to inspect the facility and its operation whenever necessary.

(5) The owner must assure the FAA that he will not withdraw the facility from service without the permission of the FAA.

(6) The owner must bear all costs of meeting the requirements of this section and of any flight or ground inspections made before the facility is commissioned, except that the Federal Aviation Administration may bear certain of these costs subject to budgetary limitations and policy established by the Administrator.

(b) If the applicant for approval meets the requirements of paragraph

## § 171.47

(a) of this section, the FAA commissions the facility as a prerequisite to its approval for use in an IFR procedure. The approval is withdrawn at any time the facility does not continue to meet those requirements. In addition, the facility may be de-commissioned whenever the frequency channel is needed for higher priority common system service.

[Doc. No. 5034, 29 FR 11337, Aug. 6, 1964, as amended by Amdt. 171-6, 35 FR 10288, June 24, 1970]

### § 171.47 Performance requirements.

(a) The Instrument Landing System must perform in accordance with the "International Standards and Recommended Practices, Aeronautical Telecommunications, Part I, Paragraph 3.1" (Annex 10 to the Convention on International Civil Aviation) except as follows:

(1) The first part of paragraph 3.1.3, relating to suppression of radiation wholly or in part in any or all directions outside the 20-degree sector centered on the course line to reduce localizer does not apply.

(2) Radiation patterns must conform to limits specified in 3.1.3.3 and 3.1.3.4, but this does not mean that suppression of radiation to the rear of the antenna array to satisfy difficult siting positions (as per 3.1.3.1.4) is not allowed. For example, if a reflector screen for the antenna array is required to overcome a siting problem, the area to the rear of the localizer may be made unusable and should be so advertised.

(3) A third marker beacon (inner marker) is not required.

(4) The frequency tolerance of the radio frequency carrier must not exceed plus or minus 0.002 percent.

(b) Ground inspection consists of an examination of the design features of the equipment to determine that there will not be conditions that will allow unsafe operations because of component failure or deterioration.

(c) The monitor is checked periodically, during the in-service test evaluation period, for calibration and stability. These tests, and ground checks of glide slope and localizer radiation characteristics, are conducted in accordance with FAA Handbooks AF P

## 14 CFR Ch. I (1-1-08 Edition)

6750.1 and AF P 6750.2 "Maintenance Instructions for ILS Localizer Equipment" and "Maintenance Instructions for ILS Glide Slope Equipment".

(d) Flight tests to determine the facility's adequacy for operational requirements and compliance with applicable "Standards and Recommended Practices" are conducted in accordance with the "U.S. Standard Flight Inspection Manual", particularly section 217.

[Doc. No. 5034, 29 FR 11337, Aug. 6, 1974, as amended by Amdt. 171-9, 38 FR 28557, Oct. 15, 1973]

### § 171.49 Installation requirements.

(a) The facility must be of a permanent nature, located, constructed, and installed according to ICAO Standards (Annex 10), accepted good engineering practices, applicable electric and safety codes, and FCC licensing requirements.

(b) The facility must have a reliable source of suitable primary power, either from a power distribution system or locally generated. A determination by the Administrator as to whether a facility will be required to have standby power for the localizer, glide slope and monitor accessories to supplement the primary power, will be made for each airport based upon operational minimums and density of air traffic.

(c) A determination by the Administrator as to whether a facility will be required to have dual transmitting equipment with automatic changeover for localizer and glide slope components, will be made for each airport based upon operational minimums and density of air traffic.

(d) There must be a means for determining, from the ground, the performance of the equipment (including antennae), initially and periodically.

(e) The facility must have, or be supplemented by (depending on the circumstances) the following ground-air or landline communications services:

(1) At facilities outside of and not immediately adjacent to controlled airspace, there must be ground-air communications from the airport served by the facility. The utilization of voice on the ILS frequency should be determined by the facility operator on an individual basis.

(2) At facilities within or immediately adjacent to controlled airspace, there must be the ground-air communications required by paragraph (e)(1) of this section and reliable communications (at least a landline telephone) from the airport to the nearest FAA air traffic control or communications facility.

Paragraphs (e)(1) and (e)(2) of this section are not mandatory at airports where an adjacent FAA facility can communicate with aircraft on the ground at the airport and during the entire proposed instrument approach procedure. In addition, at low traffic density airports within or immediately adjacent to controlled airspace, and where extensive delays are not a factor, the requirements of paragraphs (e)(1) and (e)(2) of this section may be reduced to reliable communications (at least a landline telephone) from the airport to the nearest FAA air traffic control or communications facility, if an adjacent FAA facility can communicate with aircraft during the proposed instrument approach procedure down to the airport surface or at least to the minimum approach altitude.

[Doc. No. 5034, 29 FR 11337, Aug. 6, 1964, as amended by Amdt. 171-6, 35 FR 10288, June 24, 1970; Amdt. 171-16, 56 FR 65664, Dec. 17, 1991]

**§ 171.51 Maintenance and operations requirements.**

(a) The owner of the facility must establish an adequate maintenance system and provide qualified maintenance personnel to maintain the facility at the level attained at the time it was commissioned. Each person who maintains a facility must meet at least the Federal Communications Commission's licensing requirements and show that he has the special knowledge and skills needed to maintain the facility including proficiency in maintenance procedures and the use of specialized test equipment.

(b) The owner must prepare, and obtain approval of, an operations and maintenance manual that sets forth mandatory procedures for operations, preventive maintenance, and emergency maintenance, including instructions on each of the following:

(1) Physical security of the facility.

(2) Maintenance and operations by authorized persons only.

(3) FCC licensing requirements for operating and maintenance personnel.

(4) Posting of licenses and signs.

(5) Relation between the facility and FAA air traffic control facilities, with a description of the boundaries of controlled airspace over or near the facility, instructions for relaying air traffic control instructions and information (if applicable), and instructions for the operations of an air traffic advisory service if the facility is located outside of controlled airspace.

(6) Notice to the Administrator of any suspension of service.

(7) Detailed and specific maintenance procedures and servicing guides stating the frequency of servicing.

(8) Air-ground communications, if provided, expressly written or incorporating appropriate sections of FAA manuals by reference.

(9) Keeping of station logs and other technical reports, and the submission of reports required by § 171.53.

(10) Monitoring of the facility.

(11) Inspections by United States personnel.

(12) Names, addresses, and telephone numbers of persons to be notified in an emergency.

(13) Shutdowns for routine maintenance and issue of "Notices to Airmen" for routine or emergency shutdowns (private use facilities may omit the "Notices to Airmen").

(14) Commissioning of the facility.

(15) An acceptable procedure for amending or revising the manual.

(16) An explanation of the kinds of activities (such as construction or grading) in the vicinity of the facility that may require shutdown or recertification of the facility by FAA flight check.

(17) Procedures for conducting a ground check or localizer course alignment width, and clearance, and glide slope elevation angle and width.

(18) The following information concerning the facility:

(i) Facility component locations with respect to airport layout, instrument runway, and similar areas.

(ii) The type, make, and model of the basic radio equipment that will provide the service.

## § 171.53

(iii) The station power emission and frequencies of the localizer, glide slope, markers, and associated compass locators, if any.

(iv) The hours of operation.

(v) Station identification call letters and method of station identification and the time spacing of the identification.

(vi) A description of the critical parts that may not be changed, adjusted, or repaired without an FAA flight check to confirm published operations.

(c) The owner shall make a ground check of the facility each month in accordance with procedures approved by the FAA at the time of commissioning, and shall report the results of the checks as provided in § 171.53.

(d) If the owner desires to modify the facility, he must submit the proposal to the FAA and may not allow any modifications to be made without specific approval.

(e) "The owner's maintenance personnel must participate in initial inspections made by the FAA. In the case of subsequent inspections, the owner or his representative shall participate."

(f) Whenever it is required by the FAA, the owner shall incorporate improvements in ILS maintenance brought about by progress in the state of the art. In addition, he shall provide a stock of spare parts, including vacuum tubes, of such a quantity to make possible the prompt replacement of components that fail or deteriorate in service.

(g) The owner shall provide FAA approved test instruments needed for maintenance of the facility.

(h) The owner shall close the facility upon receiving two successive pilot reports of its malfunctioning.

[Doc. No. 5034, 29 FR 11337, Aug. 6, 1964, as amended by Amdt. 171-2, 31 FR 5408, Apr. 6, 1966]

### § 171.53 Reports.

The owner of each facility to which this subpart applies shall make the following reports, at the times indicated, to the FAA Regional Office for the area in which the facility is located:

(a) *Record of meter readings and adjustments (Form FAA-198)*. To be filled out by the owner or his maintenance representative with the equipment adjust-

## 14 CFR Ch. I (1-1-08 Edition)

ments and meter readings as of the time of commissioning, with one copy to be kept in the permanent records of the facility and two copies to the appropriate Regional Office of the FAA. The owner shall revise the form after any major repair, modernization, or re-tuning, to reflect an accurate record of facility operation and adjustment.

(b) *Facility maintenance log (Form FAA 6030-1)*. This form is a permanent record of all equipment malfunctioning met in maintaining the facility, including information on the kind of work and adjustments made, equipment failures, causes (if determined), and corrective action taken. The owner shall keep the original of each report at the facility and send a copy to the appropriate Regional Office of the FAA at the end of each month in which it is prepared.

(c) *Radio equipment operation record (Form FAA-418)*. To contain a complete record of meter readings, recorded on each scheduled visit to the facility. The owner shall keep the original of each month's record at the facility and send a copy of it to the appropriate Regional Office of the FAA.

[Doc. No. 5034, 29 FR 11337, Aug. 6, 1964, as amended by Amdt. 171-5, 34 FR 15245, Sept. 30, 1969; Amdt. 171-10, 40 FR 36110, Aug. 19, 1975]

## Subpart D—True Lights

### § 171.61 Air navigation certificate: Revocation and termination.

(a) Except as provided in paragraph (b) of this section, each air navigation certificate of "Lawful Authority to Operate a True Light" is hereby revoked, and each application therefor is hereby terminated.

(b) Paragraph (a) of this section does not apply to—

(1) A certificate issued to a Federal-Aid Airport Program sponsor who was required to apply for that certificate under regulations then in effect, and who has not surrendered that certificate under § 151.86(e) of this chapter; or

(2) An application made by a Federal-Aid Airport Program sponsor who was required to make that application under regulations then in effect, and

## Federal Aviation Administration, DOT

## § 171.103

who has not terminated that application under § 151.86(e) of this chapter.

(49 U.S.C. 1101-1120; sec. 307, 72 Stat. 749, 49 U.S.C. 1348)

[Amdt. 171-4, 33 FR 12545, Sept. 5, 1968]

### Subpart E—General

#### § 171.71 Materials incorporated by reference.

Copies of standards, recommended practices and documents incorporated by reference in this part are available for the use of interested persons at any FAA Regional Office and FAA Headquarters. An historical file of these materials is maintained at Headquarters, Federal Aviation Administration, 800 Independence Avenue SW., Washington, DC 20590.

[Amdt. 171-8, 36 FR 5584, Mar. 25, 1971]

#### § 171.73 Alternative forms of reports.

On a case-by-case basis, a Regional Administrator may accept any report in a format other than the FAA form required by this part if he is satisfied that the report contains all the information required on the FAA form and can be processed by FAA as conveniently as the FAA form.

(49 U.S.C. 1348)

[Amdt. 171-5, 34 FR 15245, Sept. 30, 1969, as amended by Amdt. 171-15, 54 FR 39296, Sept. 25, 1989]

#### § 171.75 Submission of requests.

(a) Requests for approval of facilities not having design and operational characteristics identical to those of facilities currently approved under this part, including requests for deviations from this part for such facilities, must be submitted to the Director, Advanced Systems Design Service.

(b) The following requests must be submitted to the Regional Administrator of the region in which the facility is located:

(1) Requests for approval of facilities that have design and operational characteristics identical to those of facilities currently approved under this part, including requests for deviations from this part for such facilities.

(2) Requests for deviations from this part for facilities currently approved under this part.

(3) Requests for modification of facilities currently approved under this part.

[Amdt. 171-7, 35 FR 12711, Aug. 11, 1970, as amended by Amdt. 171-15, 54 FR 39296, Sept. 25, 1989]

### Subpart F—Simplified Directional Facility (SDF)

SOURCE: Docket No. 10116, 35 FR 12711, Aug. 11, 1970, unless otherwise noted.

#### § 171.101 Scope.

This subpart sets forth minimum requirements for the approval and operation of non-Federal Simplified Directional Facilities (SDF) that are to be involved in the approval of instrument flight rules and air traffic control procedures related to those facilities.

#### § 171.103 Requests for IFR procedure.

(a) Each person who requests an IFR procedure based on an SDF that he owns must submit the following information with that request:

(1) A description of the facility and evidence that the equipment meets the performance requirements of § 171.109 and the standards and tolerances of § 171.111, and is installed in accordance with § 171.113.

(2) A proposed procedure for operating the facility.

(3) A proposed maintenance organization and a maintenance manual that meets the requirements of § 171.115.

(4) A statement of intent to meet the requirements of this subpart.

(5) A showing that the facility has an acceptable level of operational reliability as prescribed in § 171.111(k), and an acceptable standard of performance. Previous equivalent operational experience with a facility with identical design and operational characteristics will be considered in showing compliance with this paragraph.

(b) After the Federal Aviation Administration inspects and evaluates the facility, it advises the owner of the results and of any required changes in the facility or the maintenance manual or maintenance organization. The

## § 171.105

owner must then correct the deficiencies, if any, and operate the facility for an in-service evaluation by the Federal Aviation Administration.

### § 171.105 Minimum requirements for approval.

(a) The following are the minimum requirements that must be met before the Federal Aviation Administration will approve an IFR procedure for a non-Federal Simplified Directional Facility:

(1) A suitable frequency channel must be available.

(2) The facility's performance, as determined by air and ground inspection, must meet the requirements of §§ 171.109 and 171.111.

(3) The installation of the equipment must meet the requirements of § 171.113.

(4) The owner must agree to operate and maintain the facility in accordance with § 171.115.

(5) The owner must agree to furnish periodic reports as set forth in § 171.117, and agree to allow the FAA to inspect the facility and its operation whenever necessary.

(6) The owner must assure the FAA that he will not withdraw the facility from service without the permission of the FAA.

(7) The owner must bear all costs of meeting the requirements of this section and of any flight or ground inspections made before the facility is commissioned, except that the FAA may bear certain of these costs subject to budgetary limitations and policy established by the Administrator.

(b) If the applicant for approval meets the requirements of paragraph (a) of this section, the FAA commissions the facility as a prerequisite to its approval for use in an IFR procedure. The approval is withdrawn at any time the facility does not continue to meet those requirements. In addition, the facility is licensed by the Federal Communications Commission. The Federal Aviation Administration recommends cancellation or nonrenewal of the Federal Communications Commission license whenever the frequency channel is needed for higher priority common system service.

## 14 CFR Ch. I (1-1-08 Edition)

### § 171.107 Definition.

As used in this subpart:

*SDF* (simplified directional facility) means a directional aid facility providing only lateral guidance (front or back course) for approach from a final approach fix.

*DDM* (difference in depth of modulation) means the percentage modulation depth of the larger signal minus the percentage modulation depth of the smaller signal, divided by 100.

*Angular displacement sensitivity* means the ratio of measured DDM to the corresponding angular displacement from the appropriate reference line.

*Back course sector* means the course sector on the opposite end of the runway from the front course sector.

*Course line* means the locus of points along the final approach course at which the DDM is zero.

*Course sector* means a sector in a horizontal plane containing the course line and limited by the loci of points nearest to the course line at which the DDM is 0.155.

*Displacement sensitivity* means the ratio of measured DDM to the corresponding lateral displacement from the appropriate reference line.

*Front course sector* means the course sector centered on the course line in the direction from the runway in which a normal final approach is made.

*Half course sector* means the sector in a horizontal plane containing the course line and limited by the loci of points nearest to the course line, at which the DDM is 0.0775.

*Point A* means a point on the front course in the approach direction a distance of 4 nautical miles from the threshold.

*Point A1* means a point on the front course in the approach direction a distance of 1 statute mile from the threshold.

*Point A2* means a point on the front course at the threshold.

*Reference datum* means a point at a specified height located vertically above the intersection of the course and the threshold.

*Missed approach point* means the point on the final approach course, not farther from the final approach fix

than Point "A2", at which the approach must be abandoned, if the approach and subsequent landing cannot be safely completed by visual reference, whether or not the aircraft has descended to the minimum descent altitude.

**§ 171.109 Performance requirements.**

(a) The Simplified Directional Facility must perform in accordance with the following standards and practices:

(1) The radiation from the SDF antenna system must produce a composite field pattern which is amplitude modulated by a 90 Hz and a 150 Hz tone. The radiation field pattern must produce a course sector with the 90 Hz tone predominating on one side of the course and with the 150 Hz tone predominating on the opposite side.

(2) When an observer faces the SDF from the approach end of runway, the depth of modulation of the radio frequency carrier due to the 150 Hz tone must predominate on his right hand and that due to the 90 Hz tone must predominate on his left hand.

(3) All horizontal angles employed in specifying the SDF field patterns must originate from the center of the antenna system which provides the signals used in the front course sector.

(4) The SDF must operate on odd tenths or odd tenths plus a twentieth MHz within the frequency band 108.1 MHz to 111.95 MHz. The frequency tolerance of the radio frequency carrier must not exceed plus or minus 0.002 percent.

(5) The radiated emission from the SDF must be horizontally polarized. The vertically polarized component of the radiation on the course line must not exceed that which corresponds to an error one-twentieth of the course sector width when an aircraft is positioned on the course line and is in a roll attitude of 20° from the horizontal.

(6) The SDF must provide signals sufficient to allow satisfactory operation of a typical aircraft installation within the sector which extends from the center of the SDF antenna system to distances of 18 nautical miles within a plus or minus 10° sector and 10 nautical miles within the remainder of the coverage when alternative navigational facilities provide satisfactory coverage

within the intermediate approach area. SDF signals must be receivable at the distances specified at and above a height of 1,000 feet above the elevation of the threshold, or the lowest altitude authorized for transition, whichever is higher. Such signals must be receivable, to the distances specified, up to a surface extending outward from the SDF antenna and inclined at 7° above the horizontal.

(7) The modulation tones must be phase-locked so that within the half course sector, the demodulated 90 Hz and 150 Hz wave forms pass through zero in the same direction within 20° of phase relative to the 150 Hz component, every half cycle of the combined 90 Hz and 150 Hz wave form. However, the phase need not be measured within the half course sector.

(8) The angle of convergence of the final approach course and the extended runway centerline must not exceed 30°. The final approach course must be aligned to intersect the extended runway centerline between points A1 and the runway threshold. When an operational advantage can be achieved, a final approach course that does not intersect the runway or that intersects it at a distance greater than point A1 from the threshold, may be established, if that course lies within 500 feet laterally of the extended runway centerline at a point 3,000 feet outward from the runway threshold. The mean course line must be maintained within ±10 percent of the course sector width.

(9) The nominal displacement sensitivity within the half course sector must be 50 microamperes/degree. The nominal course sector width must be 6°. When an operational advantage can be achieved, a nominal displacement sensitivity of 25 microamperes/degree may be established, with a nominal course sector width of 12° with proportional displacement sensitivity. The lateral displacement sensitivity must be adjusted and maintained within the limits of plus or minus 17 percent of the nominal value.

(10) The off-course (clearance) signal must increase at a substantially linear rate with respect to the angular displacement from the course line up to an angle on either side of the course

line where 175 microamperes of deflection is obtained. From that angle to  $\pm 10^\circ$ , the off-course deflection must not be less than 175 microamperes. From  $\pm 10^\circ$  to  $\pm 35^\circ$  the off-course deflection must not be less than 150 microamperes. With the course adjusted to cause any of several monitor alarm conditions, the aforementioned values of 175 microamperes in the sector  $10^\circ$  each side of course and 150 microamperes in the sector  $\pm 10^\circ$  to  $\pm 35^\circ$  may be reduced to 160 microamperes and 135 microamperes, respectively. These conditions must be met at a distance of 18 nautical miles from the SDF antenna within the sector  $10^\circ$  each side of course line and 10 nautical miles from the SDF antenna within the sector  $\pm 10^\circ$  to  $\pm 35^\circ$  each side of course line.

(11) The SDF may provide a ground-to-air radiotelephone communication channel to be operated simultaneously with the navigation and identification signals, if that operation does not interfere with the basic function. If a channel is provided, it must conform with the following standards:

(i) The channel must be on the same radio frequency carrier or carriers as used for the SDF function, and the radiation must be horizontally polarized. Where two carriers are modulated with speech, the relative phases of the modulations on the two carriers must avoid the occurrence of nulls within the coverage of the SDF.

(ii) On centerline, the peak modulation depth of the carrier or carriers due to the radiotelephone communications must not exceed 50 percent but must be adjusted so that the ratio of peak modulation depth due to the radiotelephone communications to that due to the identification signal is approximately 9:1.

(iii) The audio frequency characteristics of the radiotelephone channel must be flat to within 3 db relative to the level at 1,000 Hz over the range from 300 Hz to 3,000 Hz.

(12)(i) The SDF must provide for the simultaneous transmission of an identification signal, specific to the runway and approach direction, on the same radio frequency carrier or carriers as used for the SDF function. The transmission of the identification signal

must not interfere in any way with the basic SDF function.

(ii) The identification signal must be produced by Class A2 modulation of the radio frequency carrier or carriers using a modulation tone of 1020 Hz within  $\pm 50$  Hz. The depth of modulation must be between the limits of 5 and 15 percent except that, where a radiotelephone communication channel is provided, the depth of modulation must be adjusted so that the ratio of peak modulation depth due to radiotelephone communications to that due to the identification signal modulation is approximately 9:1. The emissions carrying the identification signal must be horizontally polarized.

(iii) The identification signal must employ the International Morse Code and consist of three letters.

(iv) The identification signal must be transmitted at a speed corresponding to approximately seven words per minute, and must be repeated at approximately equal intervals, not less than six times per minute. When SDF transmission is not available for operational use, including periods of removal of navigational components or during maintenance or test transmissions, the identification signal must be suppressed.

(b) It must be shown during ground inspection of the design features of the equipment that there will not be conditions that will allow unsafe operations because of component failure or deterioration.

(c) The monitor must be checked periodically during the in-service test evaluation period for calibration and stability. These tests, and ground checks of SDF radiation characteristics must be conducted in accordance with the maintenance manual required by §171.115(c) and must meet the standards and tolerances contained in §171.111(j).

(d) The monitor system must provide a warning to the designated control point(s) when any of the conditions of §171.111(j) occur, within the time periods specified in that paragraph.

(e) Flight inspection to determine the adequacy of the facility's operational performance and compliance

with applicable performance requirements must be conducted in accordance with the "U.S. Standard Flight Inspection Manual." Tolerances contained in the U.S. Standard Flight Inspection Manual, section 217, must be complied with except as stated in paragraph (f) of this section.

(f) Flight inspection tolerances specified in section 217 of the "U.S. Standard Flight Inspection Manual" must be complied with except as follows:

(1) *Course sector width.* The nominal course sector width must be 6°. When an operational advantage can be achieved, a nominal course sector width of 12° may be established. Course sector width must be adjusted and maintained within the limits of ±17 percent of the nominal value.

(2) *Course alignment.* The mean course line must be adjusted and maintained within the limits of ±10 percent of the nominal course sector width.

(3) *Course structure.* Course deviations due to roughness, scalloping, or bends must be within the following limitations:

(i) *Front course.* (a) Course structure from 18 miles from runway threshold to Point A must not exceed ±40 microamperes;

(b) Point A to Point A-1—linear decrease from not more than ±40 microamperes at Point A to not more than ±20 microamperes at Point A-1;

(c) Point A-1 to Missed Approach Point—not more than ±20 microamperes;

(d) Monitor tolerances: width ±17 percent of nominal; alignment—±10 percent of nominal course sector width.

(ii) *Back course.* (a) Course structure 18 miles from runway threshold to 4 miles from runway threshold must not exceed ±40 microamperes. Four miles to 1 mile from R/W must not exceed ±40 microamperes decreasing to not more than ±20 microamperes, at a linear rate.

(b) Monitor tolerances: width—±17 percent of nominal; alignment—±10 percent of nominal course sector width.

[Doc. No. 10116, 35 FR 12711, Aug. 11, 1970, as amended by Amdt. 171-9, 38 FR 28557, Oct. 15, 1973]

#### § 171.111 Ground standards and tolerances.

Compliance with this section must be shown as a condition to approval and must be maintained during operation of the SDF.

(a) *Frequency.* (1) The SDF must operate on odd tenths or odd tenths plus a twentieth MHz within the frequency band 108.1 MHz to 111.95 MHz. The frequency tolerance of the radio frequency carrier must not exceed plus or minus 0.002 percent.

(2) The modulating tones must be 90 Hz and 150 Hz within ±2.5 percent.

(3) The identification signal must be 1020 Hz within ±50 Hz.

(4) The total harmonic content of the 90 Hz tone must not exceed 10 percent.

(5) The total harmonic content of the 150 Hz tone must not exceed 10 percent.

(b) *Power output.* The normal carrier power output must be of a value which will provide coverage requirements of § 171.109(a)(6) when reduced by 3 dB to the monitor RF power reduction alarm point specified in § 171.111(j)(3).

(c) *VSWR.* (1) The VSWR of carrier and sideband feedlines must be a nominal value of 1/1 and must not exceed 1.2/1.

(2) The sponsor will also provide additional manufacturer's ground standards and tolerances for all VSWR parameters peculiar to the equipment which can effect performance of the facility in meeting the requirements specified in §§ 171.109 and 171.111.

(d) *Insulation resistance.* The insulation resistance of all coaxial feedlines must be greater than 20 megohms.

(e) *Depth of modulation.* (1) The depth of modulation of the radio frequency carrier due to each of the 90 Hz and 150 Hz tones must be 20 percent ±2 percent along the course line.

(2) The depth of modulation of the radio frequency carrier due to the 1020 Hz identification signal must be within 5 percent to 15 percent.

(f) *Course sector width.* The standard course sector width must be 6° or 12°. The course sector must be maintained with ±17 percent of the standard.

(g) *Course alignment.* Course alignment must be as specified in § 171.109(a)(8).

(h) *Back course alignment and width.* If a back course is provided, standards

## § 171.113

and tolerances for back course sector width and alignment must be the same as course sector width and course alignment specified in paragraphs (f) and (g) of this section.

(i) *Clearance*. Clearance must be as specified in §171.109(a)(10).

(j) *Monitor standards and tolerances*.

(1) The monitor system must provide a warning to the designated control point(s) when any of the conditions described in this paragraph occur, within the time periods specified in paragraph (j)(6) of this section.

(2) Course shift alarm: The monitor must alarm and cause radiation to cease, or identification and navigation signals must be removed, if the course alignment deviates from standard alignment by 10 percent or more of the standard course sector width.

(3) RF power reduction alarm: The monitor must alarm and cause radiation to cease, or identification and navigation signals must be removed, if the output power is reduced by 3 db or more from normal.

(4) Modulation level alarm: The monitor must alarm and cause radiation to cease, or identification and navigation signals must be removed, if the 90 Hz and 150 Hz modulation levels decrease by 17 percent or more.

(5) Course sector width alarm: The monitor must alarm and cause radiation to cease, or identification and navigation signals must be removed, for a change in course sector width to a value differing by  $\pm 17$  percent or more from the standard.

(6) Monitor delay before shutdown: Radiation must cease, or identification and navigation signals must be removed, within 10 seconds after a fault is detected by the monitor, and no attempt must be made to resume radiation for a period of at least 20 seconds. If an automatic recycle device is used, not more than three successive recycles may be permitted before a complete SDF shutdown occurs.

(k) *Mean time between failures*. The mean time between failures must not be less than 800 hours. This measure is applied only to equipment failures (monitor or transmitting equipment, including out of tolerance conditions) which result in facility shutdown. It

## 14 CFR Ch. I (1-1-08 Edition)

does not relate to the responsiveness of the maintenance organization.

(1) *Course alignment stability*. Drift of the course alignment must not exceed one-half the monitor limit in a 1-week period.

[Doc. No. 10116, 35 FR 12711, Aug. 11, 1970, as amended by Amdt. 171-9, 38 FR 28558, Oct. 15, 1973]

### § 171.113 Installation requirements.

(a) The facility must be installed according to accepted good engineering practices, applicable electric and safety codes, and FCC requirements.

(b) The SDF facility must have the following basic components:

(1) VHF SDF equipment and associated monitor system;

(2) Remote control, and indicator equipment (remote monitor) when required by the FAA;

(3) A final approach fix; and

(4) Compass locator (COMLO) or marker if suitable fixes and initial approach routes are not available from existing facilities.

(c) The facility must have a reliable source of suitable primary power, either from a power distribution system or locally generated. Also, adequate power capacity must be provided for operation of test and working equipment at the SDF. A determination by the Federal Aviation Administration as to whether a facility will be required to have standby power for the SDF and monitor accessories to supplement the primary power will be made for each airport based upon operational minimums and density of air traffic.

(d) A determination by the Federal Aviation Administration as to whether a facility will be required to have dual transmitting equipment with automatic changeover for the SDF will be made for each airport based upon operational minimums and density of air traffic.

(e) There must be a means for determining, from the ground, the performance of the equipment (including antennae), initially and periodically.

(f) The facility must have the following ground-air or landline communication services:

(1) At facilities outside of and not immediately adjacent to controlled airspace, there must be ground-air communications from the airport served by the facility. The utilization of voice on the SDF should be determined by the facility operator on an individual basis.

(2) At facilities within or immediately adjacent to controlled airspace, there must be ground/air communications required by paragraph (b)(1) of this section and reliable communications (at least a landline telephone) from the airport to the nearest Federal Aviation Administration air traffic control or communications facility.

Compliance with paragraphs (f) (1) and (2) of this section need not be shown at airports where an adjacent Federal Aviation Administration facility can communicate with aircraft on the ground at the airport and during the entire proposed instrument approach procedure. In addition, at low traffic density airports within or immediately adjacent to controlled airspace, and where extensive delays are not a factor, the requirements of paragraphs (f) (1) and (2) of this section may be reduced to reliable communications (at least a landline telephone) from the airport to the nearest Federal Aviation Administration air traffic control or communications facility, if an adjacent Federal Aviation Administration facility can communicate with aircraft during the proposed instrument approach procedure down to the airport surface or at least down to the minimum approach altitude.

(g) At those locations where two separate SDF facilities serve opposite ends of a single runway, an interlock must insure that only the facility serving the approach direction in use can radiate, except where no operationally harmful interference results.

(h) At those locations where, in order to alleviate frequency congestion, the SDF facilities serving opposite ends of one runway employ identical frequencies, an interlock must insure that the facility not in operational use cannot radiate.

(i) Provisions for maintenance and operations by authorized persons only.

(j) Where an operational advantage exists, the installation may omit a back course.

[Doc. No. 10116, 35 FR 12711, Aug. 11, 1970, as amended by Amdt. 171-16, 56 FR 65664, Dec. 17, 1991]

**§ 171.115 Maintenance and operations requirements.**

(a) The owner of the facility shall establish an adequate maintenance system and provide qualified maintenance personnel to maintain the facility at the level attained at the time it was commissioned. Each person who maintains a facility shall meet at a minimum the Federal Communications Commission's licensing requirements and show that he has the special knowledge and skills needed to maintain the facility, including proficiency in maintenance procedures and the use of specialized test equipment.

(b) The SDF must be designed and maintained so that the probability of operation within the performance requirements specified is high enough to insure an adequate level of safety. In the event out-of-tolerance conditions develop, the facility shall be removed from operation, and the designated control point notified.

(c) The owner must prepare, and obtain approval of, and each person operating or maintaining the facility shall comply with, an operations and maintenance manual that sets forth procedures for operations, preventive maintenance, and emergency maintenance, including instructions on each of the following:

(1) Physical security of the facility. This includes provisions for designating critical areas relative to the facility and preventing or controlling movements within the facility that may adversely affect SDF operations.

(2) Maintenance and operations by authorized persons only.

(3) Federal Communications Commission requirements for operating personnel and maintenance personnel.

(4) Posting of licenses and signs.

(5) Relation between the facility and Federal Aviation Administration air traffic control facilities, with a description of the boundaries of controlled airspace over or near the facility, instructions for relaying air traffic

**§ 171.117**

**14 CFR Ch. I (1-1-08 Edition)**

control instructions and information (if applicable), and instructions for the operation of an air traffic advisory service if the facility is located outside of controlled airspace.

(6) Notice to the Administrator of any suspension of service.

(7) Detailed and specific maintenance procedures and servicing guides stating the frequency of servicing.

(8) Air-ground communications, if provided, expressly written or incorporating appropriate sections of Federal Aviation Administration manuals by reference.

(9) Keeping of station logs and other technical reports, and the submission of reports required by § 171.117.

(10) Monitoring of the facility.

(11) Names, addresses, and telephone numbers of persons to be notified in an emergency.

(12) Inspection by U.S. personnel.

(13) Shutdowns for routine maintenance and issue of "Notices to Airmen" for routine or emergency shutdowns, except that private use facilities may omit "Notices to Airmen."

(14) Commissioning of the facility.

(15) An acceptable procedure for amending or revising the manual.

(16) An explanation of the kinds of activities (such as construction or grading) in the vicinity of the facility that may require shutdown or certification of the facility by Federal Aviation Administration flight check.

(17) Procedure for conducting a ground check of SDF course alignment, width and clearance.

(18) The following information concerning the facility:

(i) Facility component locations with respect to airport layout, instrument runway, and similar areas;

(ii) The type, make, and model of the basic radio equipment that will provide the service;

(iii) The station power emission and frequencies of the SDF, markers and associated COMLOs, if any;

(iv) The hours of operation;

(v) Station identification call letters and method of station identification and the time spacing of the identification;

(vi) A description of the critical parts that may not be changed, adjusted, or repaired without a Federal Aviation

Administration flight check to confirm published operations.

(d) The owner shall make a ground check of the facility each month in accordance with procedures approved by the Federal Aviation Administration at the time of commissioning, and shall report the results of the checks as provided in § 171.117.

(e) If the owner desires to modify the facility, he shall submit the proposal to the Federal Aviation Administration and may not allow any modifications to be made without specific approval.

(f) The owner's maintenance personnel shall participate in initial inspections made by the Federal Aviation Administration. In the case of subsequent inspections, the owner or his representatives shall participate.

(g) Whenever it is required by the Federal Aviation Administration, the owner shall incorporate improvements in SDF maintenance. In addition, he shall provide a stock of spare parts, of such a quantity, to make possible the prompt replacement of components that fail or deteriorate in service.

(h) The owner shall provide Federal Aviation Administration approved test instruments needed for maintenance of the facility.

(i) The owner shall close the facility by ceasing radiation and shall issue a "Notice to Airmen" that the facility is out of service (except that private use facilities may omit "Notices to Airmen"), upon receiving two successive pilot reports of its malfunctioning.

**§ 171.117 Reports.**

The owner of each facility to which this subpart applies shall make the following reports, at the time indicated, to the Federal Aviation Administration Regional Office for the area in which the facility is located:

(a) Record of meter readings and adjustments (Form FAA-198). To be filled out by the owner or his maintenance representative with the equipment adjustments and meter readings as of the time of commissioning, with one copy to be kept in the permanent records of the facility and two copies to the appropriate Regional Office of the Federal Aviation Administration. The owner shall revise the form after any

major repair, modification, or retuning, to reflect an accurate record of facility operation and adjustment.

(b) Facility maintenance log (FAA Form 6030-1) This form is a permanent record of all equipment malfunctioning met in maintaining the facility, including information on the kind of work and adjustments made, equipment failures, causes (if determined), and corrective action taken. The owner shall keep the original of each report at the facility and send a copy to the appropriate Regional Office of the Federal Aviation Administration at the end of each month in which it is prepared.

(c) Radio equipment operation record (Form FAA-418), containing a complete record of meter readings, recorded on each scheduled visit to the facility. The owner shall keep the original of each month's record at the facility and send a copy of it to the appropriate Regional Office of the Federal Aviation Administration.

[Doc. No. 10116, 35 FR 12711, Aug. 11, 1970, as amended by Amdt. 171-10, 40 FR 36110, Aug. 19, 1975]

### Subpart G—Distance Measuring Equipment (DME)

SOURCE: Docket No. 10116, 35 FR 12715, Aug. 11, 1970, unless otherwise noted.

#### § 171.151 Scope.

This subpart sets forth minimum requirements for the approval and operation of non-Federal DME facilities that are to be involved in the approval of instrument flight rules and air traffic control procedures related to those facilities.

#### § 171.153 Requests for IFR procedure.

(a) Each person who requests an IFR procedure based on a DME facility that he owns must submit the following information with that request:

(1) A description of the facility and evidence that the equipment meets the performance requirements of §171.157 and is installed in accordance with §171.159.

(2) A proposed procedure for operating the facility.

(3) A proposed maintenance organization and maintenance manual that meets the requirement of §171.161.

(4) A statement of intention to meet the requirements of this subpart.

(5) A showing that the facility has an acceptable level of operational reliability and an acceptable standard of performance. Previous equivalent operational experience with a facility with identical design and operational characteristics will be considered in showing compliance with this paragraph.

(b) After the Federal Aviation Administration inspects and evaluates the facility, it advises the owner of the results and of any required changes in the facility or the maintenance manual or maintenance organization. The owner must then correct the deficiencies, if any, and operate the facility for an in-service evaluation by the Federal Aviation Administration.

#### § 171.155 Minimum requirements for approval.

(a) The following are the minimum requirements that must be met before the Federal Aviation Administration will approve an IFR procedure for a non-Federal DME:

(1) A suitable frequency channel must be available.

(2) The facility's performance, as determined by air and ground inspection, must meet the requirements of §171.157.

(3) The installation of the equipment must meet the requirements of §171.159.

(4) The owner must agree to operate and maintain the facility in accordance with §171.161.

(5) The owner must agree to furnish periodic reports, as set forth in §171.163, and must agree to allow the Federal Aviation Administration to inspect the facility and its operation whenever necessary.

(6) The owner must assure the Federal Aviation Administration that he will not withdraw the facility from service without the permission of the Federal Aviation Administration.

(7) The owner must bear all costs of meeting the requirements of this section and of any flight or ground inspections made before the facility is commissioned, except that the Federal

## § 171.157

## 14 CFR Ch. I (1–1–08 Edition)

Aviation Administration may bear certain of these costs subject to budgetary limitations and policy established by the Administrator.

(b) If the applicant for approval meets the requirements of paragraph (a) of this section, the Federal Aviation Administration commissions the facility as a prerequisite to its approval for use in an IFR procedure. The approval is withdrawn at any time the facility does not continue to meet those requirements.

### § 171.157 Performance requirements.

(a) The DME must meet the performance requirements set forth in the “International Standards and Recommended Practices. Aeronautical Telecommunications, Part I, Paragraph 3.5” (Annex 10 to the Convention of International Civil Aviation).

(b) It must be shown during ground inspection of the design features of the equipment that there will not be conditions that will allow unsafe operations because of component failure or deterioration.

(c) The monitor must be checked periodically, during the in-service test evaluation period, for calibration and stability. These tests and ground tests of the functional and performance characteristics of the DME transponder must be conducted in accordance with the maintenance manual required by § 171.161(b).

(d) Flight inspection to determine the adequacy of the facility’s operational performance and compliance with applicable “Standards and Recommended Practices” must be accomplished in accordance with the “U.S. Standard Flight Inspection Manual.”

[Docket No. 10116, 35 FR 12715, Aug. 11, 1970, as amended by Amdt. 171-13, 50 FR 4875, Nov. 27, 1985]

### § 171.159 Installation requirements.

(a) The facility must be installed according to accepted good engineering practices, applicable electric and safety codes, and Federal Communications Commission requirements.

(b) The facility must have a reliable source of suitable primary power, either from a power distribution system or locally generated, with a supplemental standby system, if needed.

(c) Dual transmitting equipment with automatic changeover is preferred and may be required to support certain IFR procedures.

(d) There must be a means for determining from the ground, the performance of the equipment, initially and periodically.

(e) A facility intended for use as an instrument approach aid for an airport must have or be supplemented by the following ground air or landline communications services:

(1) At facilities outside of and not immediately adjacent to controlled airspace, there must be ground-air communications from the airport served by the facility. Separate communications channels are acceptable.

(2) At facilities within or immediately adjacent to controlled airspace, there must be the ground-air communications required by paragraph (e)(1) of this section and reliable communications (at least a landline telephone) from the airport to the nearest Federal Aviation Administration air traffic control or communications facility. Separate communications channels are acceptable.

Compliance with paragraphs (e) (1) and (2) of this section need not be shown at airports where an adjacent Federal Aviation Administration facility can communicate with aircraft on the ground at the airport and during the entire proposed instrument approach procedure. In addition, at low traffic density airports within or immediately adjacent to controlled airspace, and where extensive delays are not a factor, the requirements of paragraphs (e) (1) and (2) of this section may be reduced to reliable communications (at least a landline telephone) from the airport to the nearest Federal Aviation Administration air traffic control or communications facility, if an adjacent Federal Aviation Administration facility can communicate with aircraft during the proposed instrument approach procedure, at least down to the minimum en route altitude for the controlled airspace area.

[Doc. No. 10116, 35 FR 12715, Aug. 11, 1970, as amended by Amdt. 171-16, 56 FR 65665, Dec. 17, 1991]

**§ 171.161 Maintenance and operations requirements.**

(a) The owner of the facility shall establish an adequate maintenance system and provide qualified maintenance personnel to maintain the facility at the level attained at the time it was commissioned. Each person who maintains a facility shall meet at a minimum the Federal Communications Commission's licensing requirements and show that he has the special knowledge and skills needed to maintain the facility, including proficiency in maintenance procedures and the use of specialized test equipment.

(b) The owner must prepare and obtain Federal Aviation Administration approval of, and each person operating or maintaining the facility shall comply with, an operations and maintenance manual that sets forth procedures for operations, preventive maintenance, and emergency maintenance, including instructions on each of the following:

- (1) Physical security of the facility.
- (2) Maintenance and operations by authorized persons only.
- (3) Federal Communications Commission's requirements and maintenance personnel.
- (4) Posting of licenses and signs.
- (5) Relations between the facility and Federal Aviation Administration air traffic control facilities, with a description of the boundaries of controlled airspace over or near the facility, instructions for relaying air traffic control instructions and information (if applicable), and instructions for the operation of an air traffic advisory service if the DME is located outside of controlled airspace.
- (6) Notice to the Administrator of any suspension of service.
- (7) Detailed and specific maintenance procedures and servicing guides stating the frequency of servicing.
- (8) Air-ground communications, if provided, expressly written or incorporating appropriate sections of Federal Aviation Administration manuals by reference.
- (9) Keeping of station logs and other technical reports, and the submission of reports required by § 171.163.
- (10) Monitoring of the facility.
- (11) Inspections by U.S. personnel.

(12) Names, addresses, and telephone numbers of persons to be notified in an emergency.

(13) Shutdowns for routine maintenance and issue of "Notices to Airmen" for routine or emergency shutdowns, except that private use facilities may omit the "Notices to Airmen."

(14) An explanation of the kinds of activity (such as construction or grading) in the vicinity of the facility that may require shutdown or reapproval of the facility by Federal Aviation Administration flight check.

(15) Commissioning of the facility.

(16) An acceptable procedure for amending or revising the manual.

(17) The following information concerning the facility:

(i) Location by latitude and longitude to the nearest second, and its position with respect to airport layouts.

(ii) The type, make, and model of the basic radio equipment that will provide the service.

(iii) The station power emission and frequency.

(iv) The hours of operation.

(v) Station identification call letters and methods of station identification, whether by Morse code or recorded voice announcement, and the time spacing of the identification.

(vi) A description of the critical parts that may not be changed, adjusted, or repaired without an FAA flight check to confirm published operations.

(c) The owner shall make a monthly ground operational check in accordance with procedures approved by the FAA at the time of commissioning, and shall report the results of the checks as provided in § 171.163.

(d) If the owner desires to modify the facility, he shall submit the proposal to the FAA and may not allow any modifications to be made without specific approval.

(e) The owner's maintenance personnel shall participate in initial inspections made by the FAA. In the case of subsequent inspections, the owner or his representative shall participate.

(f) Whenever it is required by the FAA, the owner shall incorporate improvements in DME maintenance.

(g) The owner shall provide a stock of spare parts of such a quantity to make

## § 171.163

possible the prompt replacement of components that fail or deteriorate in service.

(h) The owner shall provide FAA-approved test instruments needed for maintenance of the facility.

(i) The owner shall shut down the facility (i.e., cease radiation and issue a NOTAM that the facility is out-of-service) upon receiving two successive pilot reports of its malfunctioning.

### § 171.163 Reports.

The owner of each facility to which this subpart applies shall make the following reports on forms furnished by the FAA, at the time indicated, to the FAA Regional office for the area in which the facility is located:

(a) Record of meter readings and adjustments (Form FAA-198). To be filled out by the owner with the equipment adjustments and meter readings as of the time of commissioning, with one copy to be kept in the permanent records of the facility and two copies to the appropriate Regional office of the FAA. The owner shall revise the form after any major repair, modification, or returning, to reflect an accurate record of facility operation and adjustment.

(b) Facility maintenance log (FAA Form 6030-1). This form is a permanent record of all equipment malfunctioning met in maintaining the facility, including information on the kind of work and adjustments made, equipment failures, causes (if determined), and corrective action taken. The owner shall keep the original of each report at the facility and send a copy to the appropriate Regional Office of the Federal Aviation Administration at the end of the month in which it is prepared.

(c) Radio equipment operation record (Form FAA-418), containing a complete record of meter readings, recorded on each scheduled visit to the facility. The owner shall keep the original of each month's record at the facility and send a copy of it to the appropriate Regional Office of the Federal Aviation Administration.

[Doc. No. 10116, 35 FR 12715, Aug. 11, 1970, as amended by Amdt. 171-10, 40 FR 36110, Aug. 19, 1975]

## 14 CFR Ch. I (1-1-08 Edition)

### Subpart H—VHF Marker Beacons

SOURCE: Docket No. 10116, 35 FR 12716, Aug. 11, 1970, unless otherwise noted.

#### § 171.201 Scope.

(a) This subpart sets forth minimum requirements for the approval and operation of non-Federal VHF marker beacon facilities that are to be involved in the approval of instrument flight rules and air traffic control procedures related to those facilities.

(b) [Reserved]

#### § 171.203 Requests for IFR procedure.

(a) Each person who requests an IFR procedure which will incorporate the use of a VHF marker beacon facility that he owns must submit the following information with that request:

(1) A description of the facility and evidence that the equipment meets the performance requirements of §171.207 and is installed in accordance with §171.209.

(2) A proposed procedure for operating the facility.

(3) A proposed maintenance organization and a maintenance manual that meets the requirements of §171.211.

(4) A statement of intent to meet the requirement of this subpart.

(5) A showing that the facility has an acceptable level of operational reliability, and an acceptable standard of performance. Previous equivalent operational experience may be shown to comply with this subparagraph.

(b) After the Federal Aviation Administration inspects and evaluates the facility, it advises the owner of the results and of any required changes in the facility or the maintenance manual or maintenance organization. The owner shall then correct the deficiencies, if any, and operate the facility for an in-service evaluation by the Federal Aviation Administration.

#### § 171.205 Minimum requirements for approval.

(a) The following are the minimum requirements that must be met before the Federal Aviation Administration will approve an IFR procedure which incorporates the use of a non-Federal VHF marker beacon facility under this subpart:

(1) The facility's performances, as determined by air and ground inspection, must meet the requirements of § 171.207.

(2) The installation of the equipment must meet the requirements of § 171.209.

(3) The owner must agree to operate and maintain the facility in accordance with § 171.211.

(4) The owner must agree to furnish periodic reports, as set forth in § 171.213, and agree to allow the Federal Aviation Administration to inspect the facility and its operation whenever necessary.

(5) The owner must assure the Federal Aviation Administration that he will not withdraw the facility from service without the permission of the Federal Aviation Administration.

(6) The owner must bear all costs of meeting the requirements of this section and of any flight or ground inspections made before the facility is commissioned, except that the Federal Aviation Administration may bear certain of these costs subject to budgetary limitations and policy established by the Administrator.

(b) If the applicant for approval meets the requirements of paragraph (a) of this section, the Federal Aviation Administration commissions the facility as a prerequisite to its approval for use in an IFR procedure. The approval is withdrawn at any time the facility does not continue to meet those requirements.

#### § 171.207 Performance requirements.

(a) VHF Marker Beacons must meet the performance requirements set forth in the "International Standards and Recommended Practices, Aeronautical Telecommunications, Part I, paragraphs 3.1.6 and 3.6." (Annex 10 to the Convention on International Civil Aviation) except those portions that pertain to identification. Identification of a marker beacon (75 MHz) must be in accordance with "U.S. Standard Flight Inspection Manual," § 219.

(b) The facility must perform in accordance with recognized and accepted good electronic engineering practices for the desired service. The facility must be checked periodically during the in-service test evaluation period

for calibration and stability. These tests and ground tests of the marker radiation characteristics must be conducted in accordance with the maintenance manual required by § 171.211(b).

(c) It must be shown during ground inspection of the design features of the equipment that there will not be conditions that will allow unsafe operations because of component failure or deterioration.

(d) Flight inspection to determine the adequacy of the facility's operational performance and compliance with applicable "Standards and Recommended Practices" are conducted in accordance with the "U.S. Standard Flight Inspection Manual." The original test is made by the Federal Aviation Administration and later tests must be made under arrangements, satisfactory to the Federal Aviation Administration, that are made by the owner.

#### § 171.209 Installation requirements.

(a) The facility must be installed according to accepted good engineering practices, applicable electric and safety codes, and Federal Communications Commission requirements.

(b) The facility must have a reliable source of suitable primary power.

(c) Dual transmitting equipment may be required, if applicable, to support certain IFR procedures.

(d) At facilities within or immediately adjacent to controlled airspace and that are intended for use as instrument approach aids for an airport, there must be ground-air communications or reliable communications (at least a landline telephone) from the airport to the nearest Federal Aviation Administration air traffic control or communication facility. Compliance with this paragraph need not be shown at airports where an adjacent Federal Aviation Administration facility can communicate with aircraft on the ground at the airport and during the entire proposed instrument approach procedure. In addition, at low traffic density airports within or immediately adjacent to controlled airspace, and where extensive delays are not a factor, the requirements of this paragraph may be reduced to reliable communications (at least a landline telephone)

## § 171.211

## 14 CFR Ch. I (1-1-08 Edition)

from the airport to the nearest Federal Aviation Administration air traffic control or communications facility, if an adjacent Federal Aviation Administration facility can communicate with aircraft during the proposed instrument approach procedure, at least down to the minimum en route altitude for the controlled airspace area.

[Doc. No. 10116, 35 FR 12716, Aug. 11, 1970, as amended by Amdt. 171-16, 56 FR 65665, Dec. 17, 1991]

### § 171.211 Maintenance and operations requirements.

(a) The owner of the facility shall establish an adequate maintenance system and provide qualified maintenance personnel to maintain the facility at the level attained at the time it was commissioned. Each person who maintains a facility shall meet at a minimum the Federal Communications Commission's licensing requirements and show that he has the special knowledge and skills needed to maintain the facility, including proficiency in maintenance procedures and the use of specialized test equipment.

(b) The owner must prepare, and obtain approval of, and each person who operates or maintains the facility shall comply with, an operations and maintenance manual that sets forth procedures for operations, preventive maintenance, and emergency maintenance, including instructions on each of the following:

- (1) Physical security of the facility.
- (2) Maintenance and operations by authorized persons only.
- (3) Federal Communications Commission's requirements for operating and maintenance personnel.
- (4) Posting of licenses and signs.
- (5) Relations between the facility and Federal Aviation Administration air traffic control facilities, with a description of the boundaries of controlled airspace over or near the facility, instructions for relaying air traffic control instructions and information (if applicable).
- (6) Notice to the Administrator of any suspension of service.
- (7) Detailed arrangements for maintenance, flight inspection, and servicing, stating the frequency of servicing.

(8) Keeping of station logs and other technical reports, and the submission of reports required by § 171.213.

(9) Monitoring of the facility, at least once each half hour, to assure continuous operation.

(10) Inspections by U.S. personnel.

(11) Names, addresses, and telephone numbers of persons to be notified in an emergency.

(12) Shutdowns for routine maintenance and issue of "Notices to Airmen" for routine or emergency shutdowns (private use facilities may omit the "Notice to Airmen").

(13) Commissioning of the facility.

(14) An acceptable procedure for amending or revising the manual.

(15) The following information concerning the facility:

(i) Location by latitude and longitude to the nearest second, and its position with respect to airport layouts.

(ii) The type, make, and model of the basic radio equipment that will provide the service.

(iii) The station power emission and frequency.

(iv) The hours of operation.

(v) Station identification call letters and methods of station identification, whether by Morse Code or recorded voice announcement, and the time spacing of the identification.

(c) If the owner desires to modify the facility, he shall submit the proposal to the Federal Aviation Administration and meet applicable requirements of the Federal Communications Commission, and must not allow any modification to be made without specific approval by the Federal Aviation Administration.

(d) The owner's maintenance personnel shall participate in initial inspections made by the Federal Aviation Administration. In the case of subsequent inspections, the owner or his representative shall participate.

(e) The owner shall provide a stock of spare parts, of such a quantity to make possible the prompt replacement of components that fail or deteriorate in service.

(f) The owner shall shut down the facility by ceasing radiation, and shall

issue a "Notice to Airmen" that the facility is out of service (except that private use facilities may omit "Notices to Airmen") upon receiving two successive pilot reports of its malfunctioning.

#### § 171.213 Reports.

The owner of each facility to which this subpart applies shall make the following reports, at the times indicated, to the Federal Aviation Administration Regional Office for the area in which the facility is located:

(a) Record of meter readings and adjustments (Form FAA-198). To be filled out by the owner or his maintenance representative with the equipment adjustments and meter readings as of the time of commissioning, with one copy to be kept in the permanent records of the facility and two copies to the appropriate Regional Office of the Federal Aviation Administration. The owner must revise the form after any major repair, modification, or re-tuning, to reflect an accurate record of facility operation and adjustment.

(b) Facility maintenance log (FAA Form 6030-1). This form is a permanent record of all equipment malfunctioning met in maintaining the facility, including information on the kind of work and adjustments made, equipment failures, causes (if determined), and corrective action taken. The owner shall keep the original of each report at the facility and send a copy to the appropriate Regional Office of the Federal Aviation Administration at the end of the month in which it is prepared.

(c) Radio equipment operation record (Form FAA-418), containing a complete record of meter readings, recorded on each scheduled visit to the facility. The owner shall keep the original of each month's record at the facility and send a copy of it to the appropriate Regional Office of the Federal Aviation Administration.

[Doc. No. 10116, 35 FR 12716, Aug. 11, 1970, as amended by Amdt. 171-10, 40 FR 36110, Aug. 19, 1975]

### Subpart I—Interim Standard Microwave Landing System (ISMLS)

SOURCE: Docket No. 14120, 40 FR 36110, Aug. 19, 1975, unless otherwise noted.

#### § 171.251 Scope.

This subpart sets forth minimum requirements for the approval and operation of non-Federal Interim Standard Microwave Landing System (ISMLS) facilities that are to be involved in the approval of instrument flight rules and air traffic control procedures related to those facilities.

#### § 171.253 Definitions.

As used in this subpart:

*Angular displacement sensitivity* (Glide Slope) means the ratio of measured DDM to the corresponding angular displacement from the appropriate reference line.

*Collocated ground station* means the type of ground station which transmits two or more guidance signals simultaneously from a common location.

*Course line* means the locus of points nearest to the runway centerline in any horizontal plane at which the DDM is zero.

*Course sector (full)* means a sector in a horizontal plane containing the course line and limited by the loci of points nearest to the course line at which the DDM is 0.155.

*Course sector (half)* means the sector in a horizontal plane containing the course line and limited by the loci of points nearest to the course line at which DDM is 0.0775.

*DDM* means difference in depth of modulation. The percentage modulation depth of the larger signal minus the percentage modulation depth of the smaller signal, divided by 100.

*Displacement sensitivity* (Localizer) means the ratio of measured DDM to the corresponding lateral displacement from the appropriate reference line.

*Facility Performance Category I—ISMLS* means an ISMLS which provides guidance information from the coverage limit of the ISMLS to the point at which the localizer course line intersects the ISMLS glide path at a height

of 200 feet or less above the horizontal plane containing the threshold.

*Glide path* means that locus of points in the vertical plane containing the runway center line at which the DDM is zero, which, of all such loci, is the closest to the horizontal plane.

*Glide path angle* ( $\theta$ ) means the angle between a straight line which represents the mean of the ISMLS glide path and the horizontal.

*Glide path sector (full)* means the sector in the vertical plane containing the ISMLS glide path and limited by the loci of points nearest to the glide path at which the DDM is 0.175. The ISMLS glide path sector is located in the vertical plane containing the runway centerline, and is divided by the radiated glide path in two parts called upper sector and lower sector, referring respectively to the sectors above and below the glide path.

*Glide path sector (half)* means the sector in the vertical plane containing the ISMLS glide path and limited by the loci of points nearest to the glide path at which the DDM is 0.0875.

*ISMLS Point 'A'* means an imaginary point on the glide path/localizer course measured along the runway centerline extended, in the approach direction, four nautical miles from the runway threshold.

*ISMLS Point 'B'* means an imaginary point on the glide path/localizer course measured along the runway centerline extended, in the approach direction, 3500 feet from the runway threshold.

*ISMLS Point 'C'* means a point through which the downward extended straight portion of the glide path (at the commissioned angle) passes at a height of 100 feet above the horizontal plane containing the runway threshold.

*Interim standard microwave landing system (ISMLS)* means a ground station which transmits azimuth and elevation angle information which, when decoded and processed by the airborne unit, provides signal performance capable of supporting approach minima for V/STOL and CTOL operations and operates with the signal format and tolerances specified in §§171.259, 171.261, 171.263, 171.265, and 171.267.

*Integrity* means that quality which relates to the trust which can be placed

in the correctness of the information supplied by the facility.

*Mean corrective time* means the average time required to correct an equipment failure over a given period, after a service man reaches the facility.

*Mean time between failures* means the average time between equipment failure over a given period.

*Reference datum* means a point at a specified height located vertically above the intersection of the runway centerline and the threshold and through which the downward extended straight portion of the ISMLS glide path passes.

*Split type ground station* means the type of ground station in which the electronic components for the azimuth and elevation guidance are contained in separate housings or shelters at different locations, with the azimuth portion of the ground station located at the stop end of the runway, and the elevation guidance near the approach end of the runway.

#### § 171.255 Requests for IFR procedures.

(a) Each person who requests an IFR procedure based on an ISMLS facility that he owns must submit the following information with that request:

(1) A description of the facility and evidence that the equipment meets the performance requirements of §§171.259, 171.261, 171.263, 171.265, 171.267, and 171.269, and is installed in accordance with §171.271.

(2) A proposed procedure for operating the facility.

(3) A proposed maintenance organization and a maintenance manual that meets the requirements of §171.273.

(4) A statement of intent to meet the requirements of this subpart.

(5) A showing that the ISMLS facility has an acceptable level of operational reliability, maintainability and acceptable standard of performance. Previous equivalent operational experience with a facility with identical design and operational characteristics will be considered in showing compliance with this paragraph.

(b) After the FAA inspects and evaluates the ISMLS facility, it advises the owner of the results and of any required changes in the ISMLS facility

or in the maintenance manual or maintenance organization. The owner must then correct the deficiencies, if any, and operate the ISMLS facility for an inservice evaluation by the FAA.

**§ 171.257 Minimum requirements for approval.**

(a) The following are the minimum requirements that must be met before the FAA approves an IFR procedure for a non-Federal ISMLS facility:

(1) The performance of the ISMLS facility, as determined by flight and ground inspection conducted by the FAA, must meet the requirements of §§ 171.259, 171.261, 171.263, 171.265, 171.267, and 171.269.

(2) The installation of the equipment must meet the requirements of § 171.271.

(3) The owner must agree to operate and maintain the ISMLS facility in accordance with § 171.273.

(4) The owner must agree to furnish periodic reports as set forth in § 171.275 and agree to allow the FAA to inspect the facility and its operation whenever necessary.

(5) The owner must assure the FAA that he will not withdraw the ISMLS facility from service without the permission of the FAA.

(6) The owner must bear all costs of meeting the requirements of this section and of any flight or ground inspection made before the ISMLS facility is commissioned, except that the FAA may bear certain costs subject to budgetary limitations and policy established by the Administrator.

(b) If the applicant for approval meets the requirements of paragraph (a) of this section, the FAA approves the ISMLS facility for use in an IFR procedure. The approval is withdrawn at any time that the ISMLS facility does not continue to meet those requirements. In addition, the ISMLS facility may be de-commissioned whenever the frequency channel is needed for higher priority common system service.

**§ 171.259 Performance requirements: General.**

(a) The ISMLS consists of the following basic components:

(1) C-Band (5000 MHz–5030 MHz) localizer equipment, associated monitor system, and remote indicator equipment;

(2) C-Band (5220 MHz–5250 MHz) glide path equipment, associated monitor system, and remote indicator equipment;

(3) VHF marker beacons (75 MHz), associated monitor systems, and remote indicator equipment.

(4) An ISMLS airborne receiver or a VHF/UHF ILS receiver modified to be capable of receiving the ISMLS signals. This modification requires the addition of a C-Band antenna, a converter unit, a microwave/ILS mode control, and a VHF/UHF receiver modification kit.

(b) The electronic ground equipments in paragraph (a)(1), (2), and (3) of this section, must be designed to operate on a nominal 120/240 volt, 60 Hz, 3-wire single phase AC power source.

(c) ISMLS ground equipment must meet the following service conditions:

(1) AC line parameters, DC voltage, elevation, and duty:

120 V nominal value, 102 V to 138 V ( $\pm 1$  V).\*

208 V nominal value, 177 V to 239 V ( $\pm 2$  V).\*

240 V nominal value, 204 V to 276 V ( $\pm 0.2$  V).\*

AC line frequency (60 Hz), 57 Hz to 63 Hz ( $\pm 0.2$  Hz).\*

DC voltage (48 V), 44 V to 52 V ( $\pm 0.5$  V).\*

\*NOTE: Where discrete values of the above frequency or voltages are specified for testing purposes, the tolerances given in parentheses indicated by an asterisk apply to the test instruments used to measure these parameters.

Elevation, 0 to 10,000 ft. above sea level.

Duty, continuous, unattended.

(2) Ambient conditions for localizer and glide path equipment:

Temperature,  $-10^{\circ}\text{C}$  to  $+50^{\circ}\text{C}$ .

Relative humidity, 5% to 90%.

(3) Ambient conditions for marker beacon facilities and all other equipment installed outdoors (for example, antennae, field detectors, and shelters):

Temperature,  $-50^{\circ}\text{C}$ . to  $+70^{\circ}\text{C}$ .

Relative humidity, 5% to 100%.

(4) All equipment installed outdoors must operate satisfactorily under the following conditions:

Wind velocity, 0–100 MPH (not including gusts).

Hail stones,  $\frac{1}{2}$ " diameter.

§ 171.261

14 CFR Ch. I (1-1-08 Edition)

Rain, provide coverage through a distance of 5 nautical miles with rain falling at a rate of 50 millimeters per hour, and with rain falling at the rate of 25 millimeters per hour for the additional design performance range of the system.

Ice loading, encased in ½" radial thickness of clear ice.

(d) The ISMLS must perform in accordance with the following standards and practices for Facility Performance Category I operation:

(1) The ISMLS must be constructed and adjusted so that, at a specified distance from the threshold, similar instrumental indications in the aircraft represent similar displacements from the course line or ISMLS glide path, as appropriate, regardless of the particular ground installation in use.

(2) The localizer and glide path components listed in paragraphs (a)(1) and (a)(2) of this section which form part of an ISMLS, must comply at least with the standard performance requirements specified herein. The marker beacon components listed in paragraph (a)(3) of this section which form part of an ISMLS, must comply at least with the standard performance requirements specified in subpart H of this part.

(3) The ISMLS must be so designed and maintained that the probability of operation is within the performance requirements specified in § 171.273(k).

(e) The signal format and pairing of the runway localizer and glide path transmitter frequencies of an ISMLS must be in accordance with the frequency plan approved by the FAA, and must meet the following signal format requirements:

(1) The localizer and glide slope stations must transmit angular guidance information on a C-band microwave carrier on narrow, scanned antenna beams that are encoded to produce a modulation in space which, after averaging over several beam scans, is equivalent to the modulation used for conventional ILS as specified in subpart C of this part, except that the frequency tolerance may not exceed ±0.0001 percent.

(2) Guidance modulation must be impressed on the microwave carrier of the radiated signal in the form of a summation of 90 Hz and 150 Hz sinusoidal modulation corresponding to the point-

ing direction of the particular beam which radiates the signal.

(3) Each of the effective beam positions must be illuminated in a particular sequence for a short time interval. The modulation impressed on each beam must be a sample of the combined 90 Hz and 150 Hz waveform appropriate for that particular beam direction and time slot, and must be accomplished by appropriately varying the length of time the carrier is radiated during each beam illumination interval.

(4) For those cases where the scanning beam fills the coverage space in steps, the incremental step must not exceed 0.6 times the beam width where the beam is in the proportional guidance sector. In the clearance region, the step may not exceed 0.8 times the beam width.

(5) At least one pulse duration modulation (pdm) sample pulse per beam width of scan must be provided.

(6) The minimum pulse duration must be 40 microseconds.

(7) The minimum beam scan cycle must be 600 Hz.

(8) The minimum duty ratio detectable by a receiver located anywhere in the coverage areas defined by this specification may not be less than 0.1. Detected duty ratio means the ratio of the average energy per scan detected at a point in space to the average energy per scan transmitted in all directions through the transmitting antenna.

(9) The localizer must produce a C-band unmodulated reference frequency signal of sufficient strength to allow satisfactory operation of an aircraft receiver within the specified localizer and glide path coverage sectors. Pairing of this reference frequency with the localizer and glide slope frequencies must be in accordance with a frequency plan approved by the FAA.

**§ 171.261 Localizer performance requirements.**

This section prescribes the performance requirements for localizer equipment components of the ISMLS.

(a) The localizer antenna system must:

(1) Be located on the extension of the centerline of the runway at the stop end;

(2) Be adjusted so that the course line be on a vertical plane containing the centerline of the runway served;

(3) Have the minimum height necessary to comply with the coverage requirements prescribed in paragraph (j) of this section;

(4) Be located at a distance from the stop end of the runway that is consistent with safe obstruction clearance practices;

(5) Not obscure any light of the approach landing system; and

(6) Be installed on frangible mounts or beyond the 1000' light bar.

(b) On runways where limited terrain prevents the localizer antennae from being positioned on the runway centerline extended, and the cost of the land fill or a tall tower antenna support is prohibitive, the localizer antenna array may be offset, including a collocated ground station, so that the course intercepts the centerline at a point determined by the amount of the angular offset and the glide path angle. If other than a runway centerline localizer is used, the criteria in subpart C of part 97 of this chapter is applicable.

(c) At locations where two separate ISMLS facilities serve opposite ends of a single runway, an interlock must ensure that only the facility serving the approach direction being used will radiate.

(d) The radiation from the localizer antenna system must produce a composite field pattern which is pulse duration modulated, the time average equivalent to amplitude modulation by a 90 Hz and 150 Hz tone. The localizer station must transmit angular guidance information over a C-band microwave carrier on narrow, scanned antenna beams that are encoded to produce a modulation in space which, after averaging over several beam scans, is equivalent to the modulation used for conventional ILS as specified in subpart C of this part. The radiation field pattern must produce a course sector with one tone predominating on one side of the course and with the other tone predominating on the opposite side. When an observer faces the localizer from the approach end of the runway, the depth of modulation of the radio frequency carrier due to the 150 Hz tone must predominate on his right

hand and that due to the 90 Hz tone must predominate on his left hand.

(e) All horizontal angles employed in specifying the localizer field patterns must originate from the center of the localizer antenna system which provides the signals used in the front course sector.

(f) The ISMLS course sector angle must be adjustable between 3 degrees and 9 degrees. The applicable course sector angle will be established and approved on an individual basis.

(g) The ISMLS localizer must operate in the band 5000 MHz to 5030 MHz. The frequency tolerance may not exceed  $\pm 0.0001$  percent.

(h) The emission from the localizer must be vertically polarized. The horizontally polarized component of the radiation of the course line may not exceed that which corresponds to a DDM error of 0.016 when an aircraft is positioned on the course line and is in a roll attitude of 20 degrees from the horizontal.

(i) The localizer must provide signals sufficient to allow satisfactory operation of a typical aircraft installation within the localizer and glide path coverage sectors. The localizer coverage sector must extend from the center of the localizer antenna system to distances of 18 nautical miles minimum within  $\pm 10$  degrees from the front course line, and 10 nautical miles minimum between  $\pm 10$  degrees and  $\pm 35$  degrees from the front course line. The ISMLS localizer signals must be receivable at the distances specified up from a surface extending outward from the localizer antenna and within a sector in the elevation plane from 0.300 to 1.750 of the established glide path angle ( $\theta$ ).

(j) Except as provided in paragraph (k) of this section, in all parts of the coverage volume specified in paragraph (i) of this section, the peak field strength may not be less than  $-87$  dBW/m<sup>2</sup>, and must permit satisfactory operational usage of ISMLS localizer facilities.

(k) The minimum peak field strength on the ISMLS glide path and within the localizer course sector from a distance of 10 nautical miles to a height of

§ 171.261

14 CFR Ch. I (1-1-08 Edition)

100 feet (30 meters) above the horizontal plane containing the threshold, may not be less than +87 dBW/m<sup>2</sup>.

(l) Above 16 degrees, the ISMLS localizer signals must be reduced to as low a value as practicable.

(m) Bends in the course line may not have amplitudes which exceed the following:

Zone	Amplitude (DDM) (95 pct. probability)
Outer limit of coverage to: ISMLS point "A" ..... ISMLS point "A" to ISMLS point "B".	0.031. 0.031 at ISMLS point "A" decreasing at linear rate to 0.015 at ISMLS point "B".
ISMLS point "B" to ISMLS point "C".	0.015.

(n) The amplitudes referred to in paragraph (m) of this section are the DDMs due to bends as realized on the mean course line, when correctly adjusted.

(o) The radio frequency carrier must meet the following requirements:

(1) The nominal depth of modulation of the radio frequency carrier due to each of the 90 Hz and 150 Hz tones must be 20 percent along the course line.

(2) The depth of modulation of the radio frequency carrier due to each of the 90 Hz and 150 Hz tones must be between 18 and 22 percent.

(3) The frequency tolerance of the 90 Hz and 150 Hz modulated tones must be within ±25 percent.

(4) Total harmonic content of the 90 Hz tone may not exceed 10 percent.

(5) Total harmonic content of the 150 Hz tone may not exceed 10 percent. However, a 300 Hz tone may be transmitted for identification purposes.

(6) At every half cycle of the combined 90 Hz and 150 Hz wave form, the modulation tones must be phase-locked so that within the half course sector, the demodulated 90 Hz and 150 Hz wave forms pass through zero in the same direction within 20 degrees with phase relative to the 150 Hz component. However, the phase need not be measured within the half course sector.

(p) The mean course line must be adjusted and maintained within ±.015DDM from the runway centerline at the ISMLS reference datum.

(q) The nominal displacement sensitivity within the half course sector at

the ISMLS reference datum, must be 0.00145 DDM/meter (0.00044DDM/foot). However, where the specified nominal displacement sensitivity cannot be met, the displacement sensitivity must be adjusted as near as possible to that value.

(r) The lateral displacement sensitivity must be adjusted and maintained within 17 percent of the nominal value. Nominal sector width at the ISMLS reference datum is 210 meters (700 feet).

(s) The increase of DDM must be substantially linear with respect to angular displacement from the front course line where DDM is zero, up to angle on either side of the front course line where the DDM is 0.180. From that angle to ±10 degrees, the DDM may not be less than 0.180. From ±10 degrees to ±35 degrees, the DDM may not be less than 0.155.

(t) The localizer must provide for the simultaneous transmission of an identification signal which meets the following:

(1) It must be specific to the runway and approach direction, on the same radio frequency carrier, as used for the localizer function.

(2) Transmission of the identification signal may not interfere in any way with the basic localizer function.

(3) The signal must be produced by pulse duration modulation of the radio frequency carrier resulting in a detected audio tone in the airborne VHF receiver of 1020 Hz ±50Hz.

(4) The depth of modulation must be between the limits of 10 and 12 percent.

(5) The emissions carrying the identification signal must be vertically polarized.

(6) The identification signal must employ the International Morse Code and consist of three letters. It must be preceded by the International Morse Code signal of the letter "M" followed by a short pause where it is necessary to distinguish the ISMLS facility from other navigational facilities in the immediate area. At airports where both an ISMLS and an ILS are in operation, each facility must have a different identification call sign.

(7) The signal must be transmitted at a speed corresponding to approximately seven words per minute, and must be repeated at approximately

equal intervals, not less than six times per minute, during which time the localizer is available for operational use. When the localizer is not available for transmission, the identification signal must be suppressed.

**§ 171.263 Localizer automatic monitor system.**

(a) The ISMLS localizer equipment must provide an automatic monitor system that transmits a warning to designated local and remote control points when any of the following occurs:

(1) A shift of the mean course line of the localizer from the runway centerline equivalent to more than 0.015 DDM at the ISMLS reference datum.

(2) For localizers in which the basic functions are provided by the use of a single-frequency system, a reduction of power output to less than 50 percent of normal or a loss of ground station identification transmissions.

(3) Changes of displacement sensitivity to a value differing by more than 17 percent from nominal value for the localizer.

(4) Failure of any part of the monitor itself. Such failure must automatically produce the same results as the malfunctioning of the element being monitored.

(b) Within 10 seconds of the occurrence of any of the conditions prescribed in paragraph (a) of this section, including periods of zero radiation, localizer signal radiation must cease or the navigation and identification components must be removed.

**§ 171.265 Glide path performance requirements.**

This section prescribes the performance requirements for glide path equipment components of the ISMLS. These requirements are based on the assumption that the aircraft is heading directly toward the facility.

(a) The glide slope antenna system must be located near the approach end of the runway, and the equipment must be adjusted so that the vertical path line will be in a sloping horizontal plane containing the centerline of the runway being served, and satisfy the coverage requirements prescribed in paragraph (g) of this section. For the

purpose of obstacle clearance, location of the glide slope antenna system must be in accordance with the criteria specified in subpart C of part 97 of this chapter.

(b) The radiation from the glide path antenna system must produce a composite field pattern which is pulse duration modulated by a 90 Hz and a 150 Hz tone, which is the time average equivalent to amplitude modulation. The pattern must be arranged to provide a straight line descent path in the vertical plane containing the centerline of the runway, with the 150 Hz tone predominating below the path and the 90 Hz tone predominating above the path to at least an angle equal to  $1.75\theta$ . As used in this section  $\theta$ , denotes the nominal glide path angle. The glide path angle must be adjusted and maintained within 0.075 $\theta$ .

(c) The glide path equipment must be capable of producing a radiated glide path from 3 to 9 degrees with respect to the horizontal. However, ISMLS glide path angles in excess of 3 degrees may be used to satisfy instrument approach procedures or to overcome an obstruction clearance problem, only in accordance with the criteria specified in subpart C of part 97 of this chapter.

(d) The downward extended straight portion of the ISMLS glide path must pass through the ISMLS reference datum at a height ensuring safe guidance over obstructions and safe and efficient use of the runway served. The height of the ISMLS reference datum must be in accordance with subpart C of part 97 of this chapter.

(e) The glide path equipment must operate in the band 5220 MHz to 5250 MHz. The frequency tolerance may not exceed  $\pm 0.0001$  percent.

(f) The emission from the glide path equipment must be vertically polarized.

(g) The glide path equipment must provide signals sufficient to allow satisfactory operation of a typical aircraft installation in sectors of 8 degrees on each side of the centerline of the ISMLS glide path, to a distance of at least 10 nautical miles up to  $1.75\theta$  and down to 0.45 $\theta$  above the horizontal or to such lower angle at which 0.22 DDM is realized.

§ 171.267

14 CFR Ch. I (1-1-08 Edition)

(h) To provide the coverage for glide path performance specified in paragraph (g) of this section, the minimum peak field strength within this coverage sector must be  $-82$  dBW/m<sup>2</sup>. The peak field strength must be provided on the glide path down to a height of 30 meters (100 feet) above the horizontal plane containing the threshold.

(i) Bends in the glide path may not have amplitudes which exceed the following:

Zone	Amplitude (DDM) (95 pct. probability)
Outer limit of coverage to ISMLS point "C." .....	0.035.

The amplitude referred to is the DDM due to bends as realized on the mean ISMLS glide path correctly adjusted. In regions of the approach where ISMLS glide path curvature is significant, bend amplitude is calculated from the mean curved path, and not the downward extended straight line.

(j) Guidance modulation must be impressed on the microwave carrier of the radiated glide slope signal in the form of a unique summation of 90 Hz and 150 Hz sinusoidal modulation corresponding to the point direction of the particular beam which radiates the signal. Each of the effective beam positions must be illuminated in sequence for a short time interval. The scan rate must be synchronous with the 90 and 150 Hz tone base. The modulation impressed on each beam must be a sample of the combined 90 Hz and 150 Hz waveform appropriate for that particular beam direction and time slot. The actual modulation must be accomplished by appropriately varying the length of time the carrier is radiated during each beam illumination interval.

(k) The nominal depth of modulation of the radio frequency carrier due to each of the 90 Hz and 150 Hz tones must be 40 percent along the ISMLS glide path. The depth of modulation may not deviate outside the limits of 37.5 percent to 42.5 percent.

(1) The following tolerances apply to the frequencies of the modulating tones:

(1) The modulating tones must be 90 Hz and 150 Hz within 2.5 percent.

(2) The total harmonic content of the 90 Hz tone may not exceed 10 percent.

(3) The total harmonic content of the 150 Hz tone may not exceed 10 percent.

(m) At every half cycle of the combined 90 Hz and 150 Hz wave form, the modulation must be phase-locked so that, within the ISMLS half glide path sector, the demodulated 90 Hz and 150 Hz wave forms pass through zero in the same direction within 20 degrees of phase relative to the 150 Hz component. However, the phase need not be measured within the ISMLS half glide path sector.

(n) The nominal angular displacement sensitivity must correspond to a DDM of 0.0875 at an angular displacement above and below the glide path of 0.120. The glide path angular displacement sensitivity must be adjusted and maintained within  $\pm 25$  percent of the nominal value selected. The upper and lower sectors must be as symmetrical as practicable within the limits prescribed in this paragraph.

(o) The DDM below the ISMLS glide path must increase smoothly for decreasing angle until a value of 0.22 DDM is reached. This value must be achieved at an angle not less than 0.300 above the horizontal. However, if it is achieved at an angle above 0.450, the DDM value may not be less than 0.22 at least down to an angle of 0.450.

[Doc. No. 14120, 40 FR 36110, Aug. 19, 1975; 40 FR 41093, Sept. 5, 1975; 40 FR 43719, Sept. 23, 1975]

**§ 171.267 Glide path automatic monitor system.**

(a) The ISMLS glide path equipment must provide an automatic monitor system that transmits a warning to designated local and remote control points when any of the following occurs:

(1) A shift of the mean ISMLS glide path angle equivalent to more than 0.0750.

(2) For glide paths in which the basic functions are provided by the use of a single frequency system, a reduction of power output to less than 50 percent.

(3) A change of the angle between the glide path and the line below the glide path (150 Hz predominating), at which a DDM of 0.0875 is realized by more than  $\pm 0.03750$ .

(4) Lowering of the line beneath the ISMLS glide path at which a DDM of 0.0875 is realized to less than 0.750 from the horizontal.

(5) Failure of any part of the monitor itself. Such failure must automatically produce the same results as the malfunctioning of the element being monitored.

(b) At glide path facilities where the selected nominal angular displacement sensitivity corresponds to an angle below the ISMLS glide path, which is close to or at the maximum limits specified, an adjustment to the monitor operating limits may be made to protect against sector deviations below 0.750 from the horizontal.

(c) Within 10 seconds of the occurrence of any of the conditions prescribed in paragraph (a) of this section, including periods of zero radiation, glide path signal radiation must cease.

**§ 171.269 Marker beacon performance requirements.**

ISMLS marker beacon equipment must meet the performance requirements prescribed in subpart H of this part.

**§ 171.271 Installation requirements.**

(a) The ISMLS facility must be permanent in nature, located, constructed, and installed according to accepted good engineering practices, applicable electric and safety codes, FCC licensing requirements, and paragraphs (a) and (c) of § 171.261.

(b) The ISMLS facility must have a reliable source of suitable primary power, either from a power distribution system or locally generated. Adequate power capacity must be provided for the operation of test and working equipment of the ISMLS.

(c) The ISMLS facility must have a continuously engaged or floating battery power source for the ground station for continued normal operation if the primary power fails. A trickle charge must be supplied to recharge the batteries during the period of available primary power. Upon loss and subsequent restoration of power, the batteries must be restored to full charge within 24 hours. When primary power is applied, the state of the battery charge may not affect the operation of the

ISMLS ground station. The battery must permit continuation of normal operation for at least two hours under the normal operating conditions. The equipment must meet all specification requirements with or without batteries installed.

(d) There must be a means for determining, from the ground, the performance of the equipment including antennae, both initially and periodically.

(e) The facility must have, or be supplemented by, ground-air or landline communications services. At facilities within or immediately adjacent to controlled airspace and that are intended for use as instrument approach aids for an airport, there must be ground-air communications or reliable communications (at least a landline telephone) from the airport to the nearest Federal Aviation Administration air traffic control or communication facility. Compliance with this paragraph need not be shown at airports where an adjacent Federal Aviation Administration facility can communicate with aircraft on the ground at the airport and during the entire proposed instrument approach procedure. In addition, at low traffic density airports within or immediately adjacent to controlled airspace, and where extensive delays are not a factor, the requirements of this paragraph may be reduced to reliable communications (at least a landline telephone) from the airport to the nearest Federal Aviation Administration air traffic control or communications facility, if an adjacent Federal Aviation Administration facility can communicate with aircraft during the proposed instrument approach procedure, at least down to the minimum en route altitude for the controlled area.

(f) Except where no operationally harmful interference will result, at locations where two separate ISMLS facilities serve opposite ends of a single runway, an interlock must ensure that only the facility serving the approach direction in use can radiate.

[Doc. No. 14120, 40 FR 36110, Aug. 19, 1975, as amended by Amdt. 171-16, 56 FR 65665, Dec. 17, 1991]

**§ 171.273**

**14 CFR Ch. I (1-1-08 Edition)**

**§ 171.273 Maintenance and operations requirements.**

(a) The owner of the facility must establish an adequate maintenance system and provide qualified maintenance personnel to maintain the facility at the level attained at the time it was commissioned. Each person who maintains a facility must meet at least the Federal Communications Commission's licensing requirements and show that he has the special knowledge and skills needed to maintain the facility, including proficiency in maintenance procedures and the use of specialized test equipment.

(b) In the event of out-of-tolerance conditions or malfunctions, as evidenced by receiving two successive pilot reports, the owner must close the facility by ceasing radiation, and issue a "Notice to Airman" (NOTAM) that the facility is out of service.

(c) The owner must prepare, and obtain approval of, an operations and maintenance manual that sets forth mandatory procedures for operations, periodic maintenance, and emergency maintenance, including instructions on each of the following:

- (1) Physical security of the facility.
- (2) Maintenance and operations by authorized persons.
- (3) FCC licensing requirements for operations and maintenance personnel.
- (4) Posting of licenses and signs.
- (5) Relation between the facility and FAA air traffic control facilities, with a description of the boundaries of controlled airspace over or near the facility, instructions for relaying air traffic control instructions and information, if applicable, and instructions for the operation of an air traffic advisory service if the facility is located outside of controlled airspace.
- (6) Notice to the Administrator of any suspension of service.
- (7) Detailed and specific maintenance procedures and servicing guides stating the frequency of servicing.
- (8) Air-ground communications, if provided, expressly written or incorporating appropriate sections of FAA manuals by reference.
- (9) Keeping of station logs and other technical reports, and the submission of reports required by § 171.275.

(10) Monitoring of the ISMLS facility.

(11) Inspections by United States personnel.

(12) Names, addresses, and telephone numbers of persons to be notified in an emergency.

(13) Shutdowns for periodic maintenance and issue of "Notices to Airmen" for routine or emergency shutdowns.

(14) Commissioning of the ISMLS facility.

(15) An acceptable procedure for amending or revising the manual.

(16) An explanation of the kinds of activities (such as construction or grading) in the vicinity of the ISMLS facility that may require shutdown or recertification of the ISMLS facility by FAA flight check.

(17) Procedures for conducting a ground check of the localizer course alignment, width, and clearance, glide path elevation angle and course width, and marker beacon power, and modulation.

(18) The following information concerning the ISMLS facility:

(i) Facility component locations with respect to airport layout, instrument runways, and similar areas.

(ii) The type, make, and model of the basic radio equipment that provides the service.

(iii) The station power emission and frequencies of the ISMLS localizer, glide path, beacon markers, and associated compass locators, if any.

(iv) The hours of operation.

(v) Station identification call letters and method of station identification and the time spacing of the identification.

(vi) A description of the critical parts that may not be changed, adjusted, or repaired without an FAA flight check to confirm published operations.

(d) The owner or his maintenance representative must make a ground check of the ISMLS facility periodically in accordance with procedures approved by the FAA at the time of commissioning, and must report the results of the checks as provided in § 171.275.

(e) Modifications to an ISMLS facility may be made only after approval by the FAA of the proposed modification submitted by the owner.

(f) The owner or the owner's maintenance representative must participate in inspections made by the FAA.

(g) Whenever it is required by the FAA, the owner must incorporate improvements in ISMLS maintenance.

(h) The owner or his maintenance representative must provide a sufficient stock of spare parts, including solid state components, or modules to make possible the prompt replacement of components or modules that fail or deteriorate in service.

(i) FAA approved test instruments must be used for maintenance of the ISMLS facility.

(j) The mean corrective maintenance time of the ISMLS equipment may not exceed 0.5 hours, with a maximum corrective maintenance time of not greater than 1.5 hours. This measure applies to failures of the monitor, transmitter and associated antenna assemblies, limited to unscheduled outage and out-of-tolerance conditions.

(k) The mean time between failures of the ISMLS equipment may not be less than 1,500 hours. This measure applies to unscheduled outages, out-of-tolerance conditions, and failures of the monitor, transmitter, and associated antenna assemblies.

(l) Inspection consists of an examination of the ISMLS equipment to ensure that unsafe operating conditions do not exist.

(m) Monitoring of the ISMLS radiated signal must ensure a high degree of integrity and minimize the requirements for ground and flight inspection. The monitor must be checked periodically during the in-service test evaluation period for calibration and stability. These tests and ground checks of glide slope, localizer, and marker beacon radiation characteristics must be conducted in accordance with the maintenance requirements of this section.

#### § 171.275 Reports.

The owner of the ISMLS facility or his maintenance representative must make the following reports at the indicated time to the appropriate FAA Regional Office where the facility is located.

(a) *Facility Equipment Performance and Adjustment Data (FAA Form 198)*. The

FAA Form 198 shall be filled out by the owner or his maintenance representative with the equipment adjustments and meter readings as of the time of facility commissioning. One copy must be kept in the permanent records of the facility and two copies must be sent to the appropriate FAA Regional Office. The owner or his maintenance representative must revise the FAA Form 198 data after any major repair, modernization, or retuning to reflect an accurate record of facility operation and adjustment. In the event the data are revised, the owner or his maintenance representative shall notify the appropriate FAA Regional Office of such revisions, and forward copies of the revisions to the appropriate FAA Regional Office.

(b) *Facility Maintenance Log (FAA Form 6030-1)*. FAA Form 6030-1 is a permanent record of all the activities required to maintain the ISMLS facility. The entries must include all malfunctions met in maintaining the facility including information on the kind of work and adjustments made, equipment failures, causes (if determined) and corrective action taken. In addition, the entries must include completion of periodic maintenance required to maintain the facility. The owner or his maintenance representative must keep the original of each form at the facility and send a copy to the appropriate FAA Regional Office at the end of each month in which it is prepared. However, where an FAA approved remote monitoring system is installed which precludes the need for periodic maintenance visits to the facility, monthly reports from the remote monitoring system control point must be forwarded to the appropriate FAA Regional Office, and a hard copy retained at the control point.

(c) *Technical Performance Record (FAA Form 418)*. FAA Form 418 contains a record of system parameters, recorded on each scheduled visit to the facility. The owner or his maintenance representative shall keep the original of each month's record at the facility and send a copy of the form to the appropriate FAA Regional Office.

### Subpart J—Microwave Landing System (MLS)

SOURCE: Docket No. 20669, 51 FR 33177, Sept. 18, 1986, unless otherwise noted.

#### § 171.301 Scope.

This subpart sets forth minimum requirements for the approval, installation, operation and maintenance of non-Federal Microwave Landing System (MLS) facilities that provide the basis for instrument flight rules (IFR) and air traffic control procedures.

#### § 171.303 Definitions.

As used in this subpart:

*Auxiliary data* means data transmitted in addition to basic data that provide ground equipment siting information for use in refining airborne position calculations and other supplementary information.

*Basic data* means data transmitted by the ground equipment that are associated directly with the operation of the landing guidance system.

*Beam center* means the midpoint between the -3 dB points on the leading and trailing edges of the scanning beam main lobe.

*Beamwidth* means the width of the scanning beam main lobe measured at the -3 dB points and defined in angular units on the boresight, in the horizontal plane for the azimuth function and in the vertical plane for the elevation function.

*Clearance guidance sector* means the volume of airspace, inside the coverage sector, within which the azimuth guidance information provided is not proportional to the angular displacement of the aircraft, but is a constant fly-left or fly-right indication of the direction relative to the approach course the aircraft should proceed in order to enter the proportional guidance sector.

*Control Motion Noise (CMN)* means those fluctuations in the guidance which affect aircraft attitude, control surface motion, column motion, and wheel motion. Control motion noise is evaluated by filtering the flight error record with a band-pass filter which has corner frequencies at 0.3 radian/sec and 10 radians/sec for azimuth data and 0.5 radian/sec and 10 radians/sec for elevation data.

*Data rate* means the average number of times per second that transmissions occur for a given function.

*Differential Phase Shift Keying (DPSK)* means differential phase modulation of the radio frequency carrier with relative phase states of 0 degree or 180 degrees.

*Failure* means the inability of an item to perform within previously specified limits.

*Guard time* means an unused period of time provided in the transmitted signal format to allow for equipment tolerances.

*Integrity* means that quality which relates to the trust which can be placed in the correctness of the information supplied by the facility.

*Mean corrective time* means the average time required to correct an equipment failure over a given period, after a service technician reaches the facility.

*Mean course error* means the mean value of the azimuth error along a specified radial of the azimuth function.

*Mean glide path error* means the mean value of the elevation error along a specified glidepath of the elevation function.

*Mean-time-between-failures (MTBF)* means the average time between equipment failures over a given period.

*Microwave Landing System (MLS)* means the MLS selected by ICAO for international standardization.

*Minimum glidepath* means the lowest angle of descent along the zero degree azimuth that is consistent with published approach procedures and obstacle clearance criteria.

*MLS Approach Reference Datum* is a point at a specified height located vertically above the intersection of the runway centerline and the threshold.

*MLS back azimuth reference datum* means a point 15 meters (50 feet) above the runway centerline at the runway midpoint.

*MLS datum point* means a point defined by the intersection of the runway centerline with a vertical plane perpendicular to the centerline and passing through the elevation antenna phase center.

*Out of coverage indication (OCI)* means a signal radiated into areas outside the

intended coverage sector, where required, to specifically prevent invalid removal of an airborne warning indication in the presence of misleading guidance information.

*Path Following Error (PFE)* means the guidance perturbations which could cause aircraft displacement from the desired course or glidepath. It is composed of the path following noise and of the mean course error in the case of azimuth functions, or the mean glidepath error in the case of elevation functions. Path following errors are evaluated by filtering the flight error record with a second order low pass filter which has a corner frequency at 0.5 radian/sec for azimuth data or 1.5 radians/sec for elevation data.

*Path following noise (PFN)* means that portion of the guidance signal error which could cause displacement from the actual mean course line or mean glidepath as appropriate.

*Split-site ground station* means the type of ground station in which the azimuth portion of the ground station is located near the stop end of the runway, and the elevation portion is located near the approach end.

*Time division multiplex (TDM)* means that each function is transmitted on the same frequency in time sequence, with a distinct preamble preceding each function transmission.

#### § 171.305 Requests for IFR procedure.

(a) Each person who requests an IFR procedure based on an MLS facility which that person owns must submit the following information with that request:

(1) A description of the facility and evidence that the equipment meets the performance requirements of §§ 171.309, 171.311, 171.313, 171.315, 171.317, 171.319, and 171.321 and is fabricated and installed in accordance with § 171.323.

(2) A proposed procedure for operating the facility.

(3) A proposed maintenance organization and a maintenance manual that meets the requirements of § 171.325.

(4) A statement of intent to meet the requirements of this subpart.

(5) A showing that the facility has an acceptable level of operational reliability and an acceptable standard of performance. Previous equivalent oper-

ational experience with a facility with identical design and operational characteristics will be considered in showing compliance with this subparagraph.

(b) FAA inspects and evaluates the MLS facility; it advises the owner of the results, and of any required changes in the MLS facility or in the maintenance manual or maintenance organization. The owner must then correct the deficiencies, if any, and operate the MLS facility for an in-service evaluation by the FAA.

#### § 171.307 Minimum requirements for approval.

(a) The following are the minimum requirements that must be met before the FAA approves an IFR procedure for a non-Federal MLS facility:

(1) The performance of the MLS facility, as determined by flight and ground inspection conducted by the FAA, must meet the requirements of §§ 171.309, 171.311, 171.313, 171.315, 171.317, 171.319, and 171.321.

(2) The fabrication and installation of the equipment must meet the requirements of § 171.323.

(3) The owner must agree to operate and maintain the MLS facility in accordance with § 171.325.

(4) The owner must agree to furnish operational records as set forth in § 171.327 and agree to allow the FAA to inspect the facility and its operation whenever necessary.

(5) The owner must assure the FAA that he will not withdraw the MLS facility from service without the permission of the FAA.

(6) The owner must bear all costs of meeting the requirements of this section and of any flight or ground inspection made before the MLS facility is commissioned.

(b) [Reserved]

#### § 171.309 General requirements.

The MLS is a precision approach and landing guidance system which provides position information and various ground-to-air data. The position information is provided in a wide coverage sector and is determined by an azimuth angle measurement, an elevation angle measurement and a range (distance) measurement.

§ 171.309

14 CFR Ch. I (1-1-08 Edition)

(a) An MLS constructed to meet the requirements of this subpart must include:

(1) Approach azimuth equipment, associated monitor, remote control and indicator equipment.

(2) Approach elevation equipment, associated monitor, remote control and indicator equipment.

(3) A means for the encoding and transmission of essential data words, associated monitor, remote control and indicator equipment. Essential data are basic data words 1, 2, 3, 4, and 6 and auxiliary data words A1, A2 and A3.

(4) Distance measuring equipment (DME), associated monitor, remote control and indicator equipment.

(5) Remote controls for paragraphs (a) (1), (2), (3), and (4) of this section must include as a minimum on/off and reset capabilities and may be integrated in the same equipment.

(6) At locations where a VHF marker beacon (75 MHz) is already installed, it may be used in lieu of the DME equipment.

(b) In addition to the equipment required in paragraph (a) of this section the MLS may include:

(1) Back azimuth equipment, associated monitor, remote control and indicator equipment. When Back Azimuth is provided, a means for transmission of Basic Data Word 5 and Auxiliary Data Word A4 shall also be provided.

(2) A wider proportional guidance sector which exceeds the minimum specified in §§ 171.313 and 171.317.

(3) Precision DME, associated monitor, remote control and indicator equipment.

(4) VHF marker beacon (75 MHz), associated monitor, remote control and indicator equipment.

(5) The MLS signal format will accommodate additional functions (e.g., flare elevation) which may be included as desired. Remote controls for paragraphs (b) (1), (3) and (4) of this section must include as a minimum on/off and reset capabilities, and may be integrated in the same equipment.

(6) Provisions for the encoding and transmission of additional auxiliary data words, associated monitor, remote control and indicator equipment.

(c) MLS ground equipment must be designed to operate on a nominal 120/

240 volt, 60 Hz, 3-wire single phase AC power source and must meet the following service conditions:

(1) AC line parameters, DC voltage, elevation and duty:

120 VAC nominal value—102 V to 138 V ( $\pm 1$  V)\*

240 VAC nominal value—204 V to 276 V ( $\pm 2$  V)\*

60 Hz AC line frequency—57 Hz to 63 Hz ( $\pm 0.2$  Hz)\*

\*NOTE: Where discrete values of the above frequency or voltages are specified for testing purposes, the tolerances given in parentheses indicated by an asterisk apply to the test instruments used to measure these parameters.

Elevation—0 to 3000 meters (10,000 feet) above sea level

Duty—Continuous, unattended

(2) Ambient conditions within the shelter for electronic equipment installed in shelters are:

Temperature,  $-10^{\circ}\text{C}$  to  $+50^{\circ}\text{C}$

Relative humidity, 5% to 90%

(3) Ambient conditions for electronic equipment and all other equipment installed outdoors (for example, antenna, field detectors, and shelters):

Temperature,  $-50^{\circ}\text{C}$  to  $+70^{\circ}\text{C}$

Relative humidity, 5% to 100%

(4) All equipment installed outdoors must operate satisfactorily under the following conditions:

Wind Velocity: The ground equipment shall remain within monitor limits with wind velocities of up to 70 knots from such directions that the velocity component perpendicular to runway centerline does not exceed 35 knots. The ground equipment shall withstand winds up to 100 knots from any direction without damage.

Hail Stones: 1.25 centimeters ( $\frac{1}{2}$  inch) diameter.

Rain: Provide required coverage with rain falling at a rate of 50 millimeters (2 inches) per hour, through a distance of 9 kilometers (5 nautical miles) and with rain falling at the rate of 25 millimeters (1 inch) per hour for the additional 28 kilometers (15 nautical miles).

Ice Loading: Encased in 1.25 centimeters ( $\frac{1}{2}$  inch) radial thickness of clear ice.

Antenna Radome De-Icing: Down to  $-6^{\circ}\text{C}$  ( $20^{\circ}\text{F}$ ) and wind up to 35 knots.

(d) The transmitter frequencies of an MLS must be in accordance with the frequency plan approved by the FAA.

(e) The DME component listed in paragraph (a)(4) of this section must comply with the minimum standard performance requirements specified in subpart G of this part.

(f) The marker beacon components listed in paragraph (b)(4) of this section must comply with the minimum standard performance requirements specified in subpart H of this part.

**§ 171.311 Signal format requirements.**

The signals radiated by the MLS must conform to the signal format in which angle guidance functions and data functions are transmitted sequentially on the same C-band frequency. Each function is identified by a unique digital code which initializes the airborne receiver for proper processing. The signal format must meet the following minimum requirements:

(a) *Frequency assignment.* The ground components (except DME/Marker Beacon) must operate on a single frequency assignment or channel, using time division multiplexing. These components must be capable of operating on any one of the 200 channels spaced 300 KHz apart with center frequencies from 5031.0 MHz to 5090.7 MHz and with channel numbering as shown in Table 1a. The operating radio frequencies of all ground components must not vary

by more than ±10 KHz from the assigned frequency. Any one transmitter frequency must not vary more than ±50 Hz in any one second period. The MLS angle/data and DME equipment must operate on one of the paired channels as shown in Table 1b.

TABLE 1a—FREQUENCY CHANNEL PLAN

Channel No.	Frequency (MHz)
500	5031.0
501	5031.3
502	5031.6
503	5031.9
504	5032.2
505	5032.5
506	5032.8
507	5033.1
508	5033.4
509	5033.7
510	5034.0
511	5034.3
	* * * * *
598	5060.4
599	5060.7
600	5061.0
601	5061.3
	* * * * *
698	5090.4
699	5090.7

TABLE 1b—CHANNELS

Channel pairing				DME parameters					
DME No.	VHF freq. MHz	MLS angle freq. MHz	MLS Ch. No.	Interrogation			Reply		
				Freq. MHz	Pulse codes		Freq. MHz	Pulse codes μs	
					DME/N μs	IA μs			FA μs
* 1X				1025	12			962	12
** 1Y				1025	36			1088	30
* 2X				1026	12			963	12
** 2Y				1026	36			1089	30
* 3X				1027	12			964	12
** 3Y				1027	36			1090	30
* 4X				1028	12			965	12
** 4Y				1028	36			1091	30
* 5X				1029	12			966	12
** 5Y				1029	36			1092	30
* 6X				1030	12			967	12
** 6Y				1030	36			1093	30
* 7X				1031	12			968	12
** 7Y				1031	36			1094	30
* 8X				1032	12			969	12
** 8Y				1032	36			1095	30
* 9X				1033	12			970	12
** 9Y				1033	36			1096	30
* 10X				1034	12			971	12
** 10Y				1034	36			1097	30
* 11X				1035	12			972	12

TABLE 1b—CHANNELS—Continued

Channel pairing				DME parameters					
DME No.	VHF freq. MHz	MLS angle freq. MHz	MLS Ch. No.	Interrogation			Reply		
				Freq. MHz	Pulse codes		Freq. MHz	Pulse codes $\mu$ s	
					DME/N $\mu$ s	DME/P Mode			
		IA $\mu$ s	FA $\mu$ s						
**11Y				1035	36			1098	30
*12X				1036	12			973	12
**12Y				1036	36			1099	30
*13X				1037	12			974	12
**13Y				1037	36			1100	30
*14X				1038	12			975	12
**14Y				1038	36			1101	30
*15X				1039	12			976	12
**15Y				1039	36			1102	30
*16X				1040	12			977	12
**16Y				1040	36			1103	30
$\nabla$ 17X	108.00			1041	12			978	12
17Y	108.05	5043.0	540	1041	36	36	42	1104	30
17Z		5043.3	541	1041		21	27	1104	15
18X	108.10	5031.0	500	1042	12	12	18	979	12
18W		5031.3	501	1042		24	30	979	24
18Y	108.15	5043.6	542	1042	36	36	42	1105	30
18Z		5043.9	543	1042		21	27	1105	15
19X	108.20			1043	12			980	12
19Y	108.25	5044.2	544	1043	36	36	42	1106	30
19Z		5044.5	545	1043		21	27	1106	15
20X	108.30	5031.6	502	1044	12	12	18	981	12
20W		5031.9	503	1044		24	30	981	24
20Y	108.35	5044.8	546	1044	36	36	42	1107	30
20Z		5045.1	547	1044		21	27	1107	15
21X	108.40			1045	12			982	12
21Y	108.45	5045.4	548	1045	36	36	42	1108	30
21Z		5045.7	549	1045		21	27	1108	15
22X	108.50	5032.2	504	1046	12	12	18	983	12
22W		5032.5	505	1046		24	30	983	24
22Y	108.55	5046.0	550	1046	36	36	42	1109	30
22Z		5046.3	551	1046		21	27	1109	15
23X	108.60			1047	12			984	12
23Y	108.65	5046.6	552	1047	36	36	42	1110	30
23Z		5046.9	553	1047		21	27	1110	15
24X	108.70	5032.8	506	1048	12	12	18	985	12
24W		5033.1	507	1048		24	30	985	24
24Y	108.75	5047.2	554	1048	36	36	42	1111	30
24Z		5047.5	555	1048		21	27	1111	15
25X	108.80			1049	12			986	12
25Y	108.85	5047.8	556	1049	36	36	42	1112	30
25Z		5048.1	557	1049		21	27	1112	15
26X	108.90	5033.4	508	1050	12	12	18	987	12
26W		5033.7	509	1050		24	30	987	24
26Y	108.95	5048.4	558	1050	36	36	42	1113	30
26Z		5048.7	559	1050		21	27	1113	15
27X	109.00			1051	12			988	12
27Y	109.05	5049.0	560	1051	36	36	42	1114	30
27Z		5049.3	561	1051		21	27	1114	15
28X	109.10	5034.0	510	1052	12	12	18	989	12
28W		5034.3	511	1052		24	30	989	24
28Y	109.15	5049.6	562	1052	36	36	42	1115	30
28Z		5049.9	563	1052		21	27	1115	15
29X	109.20			1053	12			990	12
29Y	109.25	5050.2	564	1053	36	36	42	1116	30
29Z		5050.5	565	1043		21	27	1116	15
30X	109.30	5034.6	512	1054	12	12	18	991	12
30W		5034.9	513	1054		24	30	991	24
30Y	109.35	5050.8	566	1054	36	36	42	1117	30
30Z		5051.1	567	1054		21	27	1117	15
31X	109.40			1055	12			992	12
31Y	109.45	5051.4	568	1055	36	36	42	1118	30
31Z		5051.7	569	1055		21	27	1118	15
32X	109.50	5035.2	514	1056	12	12	18	993	12
32W		5035.5	515	1056		24	30	993	24

TABLE 1b—CHANNELS—Continued

Channel pairing				DME parameters					
DME No.	VHF freq. MHz	MLS angle freq. MHz	MLS Ch. No.	Interrogation			Reply		
				Freq. MHz	Pulse codes		Freq. MHz	Pulse codes $\mu$ s	
					DME/N $\mu$ s	DME/P Mode			
IA $\mu$ s	FA $\mu$ s								
32Y	109.55	5052.0	570	1056	36	36	42	1119	30
32Z		5052.3	571	1056		21	27	1119	15
33X	109.60			1057	12			994	12
33Y	109.65	5052.6	572	1057	36	36	42	1120	30
33Z		5052.9	573	1057		21	27	1120	15
34X	109.70	5035.8	516	1058	12	12	18	995	12
34W		5036.1	517	1058		24	30	995	24
34Y	109.75	5053.2	574	1058	36	36	42	1121	30
34Z		5053.5	575	1058		21	27	1121	15
35X	109.80			1059	12			996	12
35Y	109.85	5053.8	576	1059	36	36	42	1122	30
35Z		5054.1	577	1059		21	27	1122	15
36X	109.90	5036.4	518	1060	12	12	18	997	12
36W		5036.7	519	1060		24	30	997	24
36Y	109.95	5054.4	578	1060	36	36	42	1123	30
36Z		5054.7	579	1060		21	27	1123	15
37X	110.00			1061	12			998	12
37Y	110.05	5055.0	580	1061	36	36	42	1124	30
37Z		5055.3	581	1061		21	27	1124	15
38X	110.10	5037.0	520	1062	12	12	18	999	12
38W		5037.3	521	1062		24	30	999	24
38Y	110.15	5055.6	582	1062	36	36	42	1125	30
38Z		5055.9	583	1062		21	27	1125	15
39X	110.20			1063	12			1000	12
39Y	110.25	5056.2	584	1063	36	36	42	1126	30
39Z		5056.5	585	1063		21	27	1126	15
40X	110.30	5037.6	522	1064	12	12	18	1001	12
40W		5037.9	523	1064		24	30	1001	24
40Y	110.35	5056.8	586	1064	36	36	42	1127	30
40Z		5057.1	587	1064		21	27	1127	15
41X	110.40			1065	12			1002	12
41Y	110.45	5057.4	588	1065	36	36	42	1128	30
41Z		5057.7	589	1065		21	27	1128	15
42X	110.50	5038.2	524	1066	12	12	18	1003	12
42W		5038.5	525	1066		24	30	1003	24
42Y	110.55	5058.0	590	1066	36	36	42	1129	30
42Z		5058.3	591	1066		21	27	1129	15
43X	110.60			1067	12			1004	12
43Y	110.65	5058.6	592	1067	36	36	42	1130	30
43Z		5058.9	593	1067		21	27	1130	15
44X	110.70	5038.8	526	1068	12	12	18	1005	12
44W		5039.1	527	1068		24	30	1005	24
44Y	110.75	5059.2	594	1068	36	36	42	1131	30
44Z		5059.5	595	1068		21	27	1131	15
45X	110.80			1069	12			1006	12
45Y	110.85	5059.8	596	1069	36	36	42	1132	30
45Z		5060.1	597	1069		21	27	1132	15
46X	110.90	5039.4	528	1070	12	12	18	1007	12
46W		5039.7	529	1070		24	30	1007	24
46Y	110.95	5060.4	598	1070	36	36	42	1133	30
46Z		5060.7	599	1070		21	27	1133	15
47X	111.00			1071	12			1008	12
47Y	111.05	5061.0	600	1071	36	36	42	1134	30
47Z		5061.3	601	1071		21	27	1134	15
48X	111.10	5040.0	530	1072	12	12	18	1009	12
48W		5040.3	531	1072		24	30	1009	24
48Y	111.15	5061.6	602	1072	36	36	42	1135	30
48Z		5061.9	603	1072		21	27	1135	15
49X	111.20			1073	12			1010	12
49Y	111.25	5062.2	604	1073	36	36	42	1136	30
49Z		5062.5	605	1073		21	27	1136	15
50X	111.30	5040.6	532	1074	12	12	18	1011	12
50W		5040.9	533	1074		24	30	1011	24
50Y	111.35	5062.8	606	1074	36	36	42	1137	30
50Z		5063.1	607	1074		21	27	1137	15

TABLE 1b—CHANNELS—Continued

Channel pairing				DME parameters					
DME No.	VHF freq. MHz	MLS angle freq. MHz	MLS Ch. No.	Interrogation			Reply		
				Freq. MHz	Pulse codes		Freq. MHz	Pulse codes $\mu$ s	
					DME/N $\mu$ s	DME/P Mode			
				IA $\mu$ s	FA $\mu$ s				
51X	111.40			1075	12			1012	12
51Y	111.45	5063.4	608	1075	36	36	42	1138	30
51Z		5063.7	609	1075		21	27	1138	15
52X	111.50	5041.2	534	1076	12	12	18	1013	12
52W		5041.5	535	1076		24	30	1013	24
52Y	111.55	5064.0	610	1076	36	36	42	1139	30
52Z		5064.3	611	1076		21	27	1139	15
53X	111.60			1077	12			1014	12
53Y	111.65	5064.6	612	1077	36	36	42	1140	30
53Z		5064.9	613	1077		21	27	1140	15
54X	111.70	5041.8	536	1078	12	12	18	1015	12
54W		5042.1	537	1078		24	30	1015	24
54Y	111.75	5065.2	614	1078	36	36	42	1141	30
54Z		5065.5	615	1078		21	27	1141	15
55X	111.80			1079	12			1016	12
55Y	111.85	5065.8	616	1079	36	36	42	1142	30
55Z		5066.1	617	1079		21	27	1142	15
56X	111.90	5042.4	538	1080	12	12	18	1017	12
56W		5042.7	539	1080		24	30	1017	24
56Y	111.95	5066.4	618	1080	36	36	42	1143	30
56Z		5066.7	619	1080		21	27	1143	15
57X	112.00			1081	12			1018	12
57Y	112.05			1081	36			1144	30
58X	112.10			1082	12			1019	12
58Y	112.15			1082	36			1145	30
59X	112.20			1083	12			1020	12
59Y	122.25			1083	36			1146	30
**60X				1084	12			1021	12
**60Y				1084	36			1147	30
**61X				1085	12			1022	12
**61Y				1085	36			1148	30
**62X				1086	12			1023	12
**62Y				1086	36			1149	30
**63X				1037	12			1024	12
**63Y				1087	36			1150	30
**64X				1088	12			1151	12
**64Y				1088	36			1025	30
**65X				1089	12			1152	12
**65Y				1089	36			1026	30
**66X				1090	12			1153	12
**66Y				1090	36			1027	30
**67X				1091	12			1154	12
**67Y				1091	36			1028	30
**68X				1092	12			1155	12
**68Y				1092	36			1029	30
**69X				1093	12			1156	12
**69Y				1093	36			1030	30
70X	112.30			1094	12			1157	12
**70Y	112.35			1094	36			1031	30
71X	112.40			1095	12			1158	12
**71Y	112.45			1095	36			1032	30
72X	112.50			1096	12			1159	12
**72Y	112.55			1096	36			1033	30
73X	112.60			1097	12			1160	12
**73Y	112.65			1097	36			1034	30
74X	112.70			1098	12			1161	12
**74Y	112.75			1098	36			1035	30
75X	112.80			1099	12			1162	12
**75Y	112.85			1099	36			1036	30
76X	112.90			1100	12			1163	12
**76Y	112.95			1100	36			1037	30
77X	113.00			1101	12			1164	12
**77Y	113.05			1101	36			1038	30
78X	113.10			1102	12			1165	12
**78Y	113.15			1102	36			1039	30

TABLE 1b—CHANNELS—Continued

Channel pairing				DME parameters					
DME No.	VHF freq. MHz	MLS angle freq. MHz	MLS Ch. No.	Interrogation			Reply		
				Freq. MHz	Pulse codes		Freq. MHz	Pulse codes $\mu$ s	
					DME/N $\mu$ s	DME/P Mode			
IA $\mu$ s	FA $\mu$ s								
79X	113.20			1103	12			1166	12
**79Y	113.25			1103	36			1040	30
80X	113.30			1104	12			1167	12
80Y	113.35	5067.0	620	1104	36	36	42	1041	30
80Z		5067.3	621	1104		21	27	1041	15
81X	113.40			1105	12			1168	12
81Y	113.45	5067.6	622	1105	36	36	42	1042	30
81Z		5067.9	623	1005		21	27	1042	15
82X	113.50			1106	12			1169	12
82Y	113.55	5068.2	624	1106	36	36	42	1043	30
82Z		5068.5	625	1106		21	27	1043	15
83X	113.60			1107	12			1170	12
83Y	113.65	5068.8	626	1107	36	36	42	1044	30
83Z		5069.1	627	1107		21	27	1044	15
84X	113.70			1108	12			1171	12
84Y	113.75	5069.4	628	1108	36	36	42	1045	30
84Z		6069.7	629	1108		21	27	1045	15
85X	113.80			1109	12			1172	12
85Y	113.85	5070.0	630	1109	36	36	42	1046	30
85Z		5070.3	631	1109		21	27	1046	15
86X	113.90			1110	12			1173	12
86Y	113.95	5070.6	632	1110	36	36	42	1047	30
86Z		5070.9	633	1110		21	27	1047	15
87X	114.00			1111	12			1174	12
87Y	114.05	5071.2	634	1111	36	36	42	1048	30
87Z		5071.5	635	1111		21	27	1048	15
88X	114.10			1112	12			1175	12
88Y	114.15	5071.8	636	1112	36	36	42	1049	30
88Z		5072.1	637	1112		21	27	1049	15
89X	114.20			1113	12			1176	12
89Y	114.25	5072.4	638	1113	36	36	42	1050	30
89Z		5072.7	639	1113		21	27	1050	15
90X	114.30			1114	12			1177	12
90Y	114.35	5073.0	640	1114	36	36	42	1051	30
90Z		5073.3	641	1114		21	27	1051	15
91X	114.40			1115	12			1178	12
91Y	114.45	5073.6	642	1115	36	36	42	1052	30
91Z		5073.9	643	1115		21	27	1052	15
92X	114.50			1116	12			1179	12
92Y	114.55	5074.2	644	1116	36	36	42	1053	30
92Z		5074.5	645	1116		21	27	1053	15
93X	114.60			1117	12			1180	12
93Y	114.65	5074.8	646	1117	36	36	42	1054	30
93Z		5075.1	647	1117		21	27	1054	15
94X	114.70			1118	12			1181	12
94Y	114.75	5075.4	648	1118	36	36	42	1055	30
94Z		5075.7	649	1118		21	27	1055	15
95X	114.80			1119	12			1182	12
95Y	114.85	5076.0	650	1119	36	36	42	1056	30
95Z		5076.3	651	1119		21	27	1056	15
96X	114.90			1120	12			1183	12
96Y	114.95	5076.6	652	1120	36	36	42	1057	30
96Z		5076.9	653	1120		21	27	1057	15
97X	115.00			1121	12			1184	12
97Y	115.05	5077.2	654	1121	36	36	42	1058	30
97Z		5077.5	655	1121		21	27	1058	15
98X	115.10			1122	12			1185	12
98Y	115.15	5077.8	656	1122	36	36	42	1059	30
98Z		5078.1	657	1122		21	27	1059	15
99X	115.20			1123	12			1186	12
99Y	115.25	5078.4	658	1123	36	36	42	1060	30
99Z		5078.7	659	1123		21	27	1060	15
100X	115.30			1124	12			1187	12
100Y	115.35	5079.0	660	1124	36	36	42	1061	30
100Z		5079.3	661	1124		21	27	1061	15

TABLE 1b—CHANNELS—Continued

Channel pairing				DME parameters					
DME No.	VHF freq. MHz	MLS angle freq. MHz	MLS Ch. No.	Interrogation			Reply		
				Freq. MHz	Pulse codes		Freq. MHz	Pulse codes $\mu$ s	
					DME/N $\mu$ s	DME/P Mode			
		IA $\mu$ s	FA $\mu$ s						
101X	115.40			1125	12			1188	12
101Y	115.45	5079.6	662	1125	36	36	42	1062	30
101Z		5079.9	663	1125		21	27	1062	15
102X	115.50			1126	12			1189	12
102Y	115.55	5080.2	664	1126	36	36	42	1063	30
102Z		5080.5	665	1126		21	27	1063	15
103X	115.60			1127	12			1190	12
103Y	115.65	5080.B	666	1127	36	36	42	1064	30
103Z		5081.1	667	1127		21	27	1064	19
104X	115.70			1128	12			1191	12
104Y	115.75	5081.4	668	1128	36	36	42	1065	30
104Z		5081.7	669	1128		21	27	1065	19
105X	115.80			1129	12			1192	12
105Y	115.85	5082.0	670	1129	36	36	42	1066	30
105Z		5082.3	671	1129		21	27	1066	15
106X	115.90			1130	12			1193	12
106Y	115.95	5082.6	672	1130	36	36	42	1067	30
106Z		5082.9	673	1130		21	27	1067	15
107X	116.00			1131	12			1194	12
107Y	116.05	5083.2	674	1131	36	36	42	1068	30
107Z		5083.5	675	1131		21	27	1068	15
108X	116.10	508		1132	12			1195	12
108Y	116.15	5083.8	676	1132	36	36	42	1069	30
108Z		5084.1	677	1132		21	27	1069	15
109X	116.20			1133	12			1196	12
109Y	116.25	5084.4	678	1133	36	36	42	1070	30
109Z		5084.7	679	1133		21	27	1070	15
110X	116.30			1134	12			1197	12
110Y	116.35	5085.0	680	1134	36	36	42	1071	30
110Z		5085.3	681	1134		21	27	1071	15
111X	116.40			1135	12			1198	12
111Y	116.45	5086.6	682	1135	36	36	42	1072	30
111Z		5085.9	683	1135		21	27	1072	15
112X	116.50			1136	12			1199	12
112Y	116.55	5086.2	684	1136	36	36	42	1073	30
112Z		5086.5	685	1136		21	27	1073	15
113X	116.60			1137	12			1200	12
113Y	116.65	5086.8	686	1137	36	36	42	1074	30
113Z		5087.1	687	1137		21	27	1074	15
114X	116.70			1138	12			1201	12
114Y	116.75	5087.4	688	1138	36	36	42	1075	30
114Z		5087.7	689	1138		21	27	1075	15
115X	116.80			1139	12			1202	12
115Y	116.85	5088.0	690	1139	36	36	42	1076	30
115Z		5088.3	691	1139		21	27	1076	15
116X	116.90			1140	12			1203	12
116Y	116.95	5088.6	692	1140	36	36	42	1077	30
116Z		5088.9	693	1140		21	27	1077	15
117X	117.00			1141	12			1204	12
117Y	117.05	5089.2	694	1141	36	36	42	1078	30
117Z		5089.5	695	1141		21	27	1078	15
118X	117.10			1142	12			12.5	12
118Y	117.15	5089.8	696	1142	36	36	42	1079	30
118Z		5090.1	697	1142		21	27	1079	12
119X	117.20			1143	12			1206	12
119Y	117.25	5090.4	698	1143	36	36	42	1080	30
119Z		5090.7	699	1143		21	27	1080	15
120X	117.30			1144	12			1207	12
120Y	117.35			1144	36			1081	30
121X	117.40			1145	12			1208	12
121Y	117.45			1145	36			1082	30
122X	117.50			1146	12			1209	12
122Y	117.55			1146	36			1083	30
123X	117.60			1147	12			1210	12
123Y	117.65			1147	36			1084	30

TABLE 1b—CHANNELS—Continued

Channel pairing				DME parameters					
DME No.	VHF freq. MHz	MLS angle freq. MHz	MLS Ch. No.	Interrogation				Reply	
				Freq. MHz	Pulse codes		Freq. MHz	Pulse codes $\mu$ s	
					DME/N $\mu$ s	DME/P Mode			
		IA $\mu$ s	FA $\mu$ s						
124X .....	117.70	.....	.....	1148	12	.....	.....	1211	12
**124Y .....	117.75	.....	.....	1148	36	.....	.....	1085	30
125X .....	117.80	.....	.....	1149	12	.....	.....	1212	12
**125Y .....	117.85	.....	.....	1149	36	.....	.....	1086	30
126X .....	117.90	.....	.....	1150	12	.....	.....	1213	12
**126Y .....	117.95	.....	.....	1150	36	.....	.....	1087	30

Notes:  
 \* These channels are reserved exclusively for national allotments.  
 \*\* These channels may be used for national allotment on a secondary basis. The primary reason for reserving these channels is to provide protection for the secondary Surveillance Radar (SSR) system.  
 ∇ 108.0 MHz is not scheduled for assignment to ILS service. The associated DME operating channel No. 17X may be assigned to the emergency service.

(b) *Polarization.* (1) The radio frequency emissions from all ground equipment must be nominally vertically polarized. Any horizontally polarized radio frequency emission component from the ground equipment must not have incorrectly coded angle information such that the limits specified in paragraphs (b) (2) and (3) of this section are exceeded.

(2) Rotation of the receiving antenna thirty degrees from the vertically polarized position must not cause the path following error to exceed the allowed error at that location.

(c) *Modulation requirements.* Each function transmitter must be capable

of DPSK and continuous wave (CW) modulations of the RF carrier which have the following characteristics.

(1) DPSK. The DPSK signal must have the following characteristics:

- bit rate ..... 15.625 KHz
- bit length ..... 64 microseconds
- logic "0" ..... no phase transition
- logic "1" ..... phase transition
- phase transition ..... less than 10 microseconds
- phase tolerance .....  $\pm 10$  degrees

The phase shall advance (or retard) monotonically throughout the transition region. Amplitude modulation during the phase transition period shall not be used.

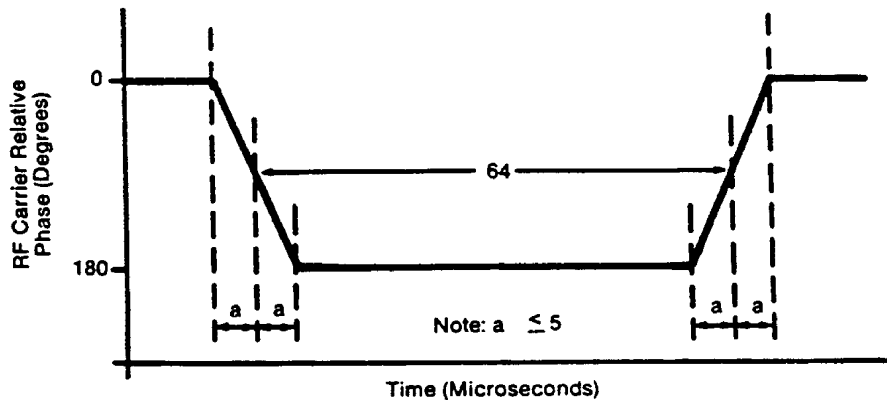

Figure 1.—DPSK Phase Characteristic

§ 171.311

14 CFR Ch. I (1-1-08 Edition)

(2) CW. The CW pulse transmissions and the CW angle transmissions as may be required in the signal format of any function must have characteristics such that the requirements of paragraph (d) of this section are met.

(d) *Radio frequency signal spectrum.* The transmitted signal must be such that during the transmission time, the mean power density above a height of 600 meters (2000 feet) does not exceed  $-100.5$  dBW/m<sup>2</sup> for angle guidance and  $-95.5$  dBW/m<sup>2</sup> for data, as measured in a 150 KHz bandwidth centered at a frequency of 840 KHz or more from the assigned frequency.

(e) *Synchronization.* Synchronization between the azimuth and elevation components is required and, in split-site configurations, would normally be accomplished by landline interconnections. Synchronization monitoring

must be provided to preclude function overlap.

(f) *Transmission rates.* Angle guidance and data signals must be transmitted at the following average repetition rates:

Function	Average data rate (Hertz)
Approach Azimuth .....	13 ±0.5
High Rate Approach Azimuth .....	<sup>1</sup> 39 ±1.5
Approach Elevation .....	39 ±1.5
Back Azimuth .....	6.5 ±0.25
Basic Data .....	( <sup>2</sup> )
Auxiliary Data .....	( <sup>3</sup> )

<sup>1</sup> The higher rate is recommended for azimuth scanning antennas with beamwidths greater than two degrees. It should be noted that the time available in the signal format for additional functions is limited when the higher rate is used.

<sup>2</sup> Refer to Table 8a.

<sup>3</sup> Refer to Table 8c.

(g) *Transmission sequences.* Sequences of angle transmissions which will generate the required repetition rates are shown in Figures 2 and 3.

Sequence #1	Time (ms)	Sequence #2
Approach Elevation	0	Approach Elevation
Flare	10	Flare
Approach Azimuth	20	Approach Azimuth
Flare	30	Flare
Approach Elevation		Approach Elevation
Flare		
Back Azimuth	50	Growth (18.2ms Max) (Note 2)
(Note 2)		
Approach Elevation	60	Approach Elevation
Flare	66.7	Flare
		66.8

(Note 3)

Notes:

1. When Back Azimuth is Provided, Basic Data Word # 2 Must Be Transmitted Only In This Position.
2. Data Words May Be Transmitted In Any Open Time Periods.
3. The Total Time Duration of Sequence #1 Plus Sequence #2 Must Not exceed 134 ms.

Figure 2. Transmission sequence pair which provides for all MLS angle guidance functions.

Sequence #1	Time (ms)	Sequence #2
Approach Elevation	0	Approach Elevation
High Rate Approach Azimuth	10	High Rate Approach Azimuth
Data Words (Note 1)	20	(Note 2)
High Rate Approach Azimuth	30	Back Azimuth
Approach Elevation	40	High Rate Approach Azimuth
High Rate Approach Azimuth	50	Approach Elevation
Approach Elevation	60	High Rate Approach Azimuth
Approach Elevation	64.9	Approach Elevation
	67.5	Approach Elevation

(Note 3)

Notes:

1. Data Words May Be Transmitted In Any Open Time Period.
2. When Back Azimuth Is Provided, Basic Data Word #2 Must Be Transmitted Only In This Position.
3. The Total Time Duration Of Sequence #1 Plus Sequence #2 Must Not Exceed 134 ms.

Figure 3. Transmission sequence pair which provides for the MLS high rate approach azimuth angle guidance function.

(h) *TDM cycle*. The time periods between angle transmission sequences must be varied so that exact repetitions do not occur within periods of less than 0.5 second in order to protect against synchronous interference. One

such combination of sequences is shown in Figure 4 which forms a full multiplex cycle. Data may be transmitted during suitable open times within or between the sequences.

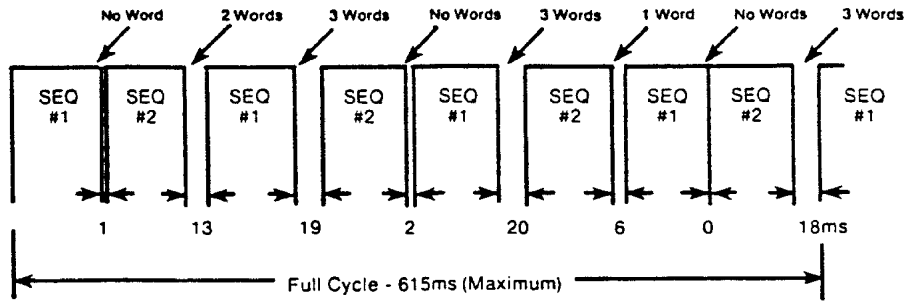

Note: Angle Sequence Are Those From Figure 2 Or 3. Do Not Mix Sequences.

Figure 4. A complete function multiplex cycle.

(i) *Function Formats (General)*. Each angle function must contain the following elements: a preamble; sector signals; and a TO and FRO angle scan organized as shown in Figure 5a. Each data function must contain a preamble and a data transmission period organized as shown in Figure 5b.

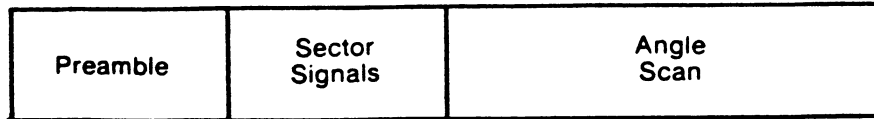

(a) Angle Function

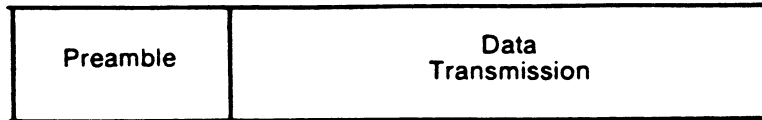

(b) Data Function

Figure 5 - Function format.

(1) *Preamble format*. The transmitted angle and date functions must use the preamble format shown in Figure 6. This format consists of a carrier acquisition period of unmodulated CW transmission followed by a receiver synchronization code and a function identification code. The preamble timing must be in accordance with Table 2.

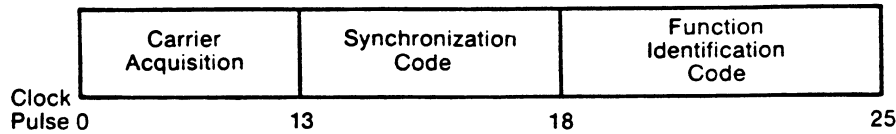

Figure 6 - Preamble organization.

(i) *Digital codes.* The coding used in the preamble for receiver synchronization is a Barker code logic 11101. The time of the last phase transition midpoint in the code shall be the receiver reference time (see Table 2). The function identification codes must be as shown in Table 3. The last two bits ( $I_{11}$  and  $I_{12}$ ) of the code are parity bits obeying the equations:

$$I_6 + I_7 + I_8 + I_9 + I_{10} + I_{11} = \text{Even}$$

$$I_6 + I_8 + I_{10} + I_{12} = \text{Even}$$

(ii) *Data modulation.* The digital code portions of the preamble must be DPSK modulated in accordance with §171.311(c)(1) and must be transmitted throughout the function coverage volume.

(2) *Angle function formats.* The timing of the angle transmissions must be in accordance with Tables 4a, 4b, and 5. The actual timing of the TO and FRO scans must be as required to meet the accuracy requirements of §§171.313 and 171.317.

(i) Preamble. Must be in accordance with requirements of §171.311(i)(1).

TABLE 2—PREAMBLE TIMING <sup>1</sup>

Event	Event time slot begins at—	
	15.625 kHz clock pulse (number)	Time (milliseconds)
Carrier acquisition: (CW transmission) .....	0	0
Receiver reference time code:		
$I_1=1$ .....	13	0.832
$I_2=1$ .....	14	0.896
$I_3=1$ .....	15	0.960
$I_4=0$ .....	16	1.024
$I_5=1$ .....	17	≥1.088
Function identification:		
$I_6$ .....	18	1.152
$I_7$ .....	19	1.216
$I_8$ .....	20	1.280
$I_9$ .....	21	1.344

TABLE 2—PREAMBLE TIMING <sup>1</sup>—Continued

Event	Event time slot begins at—	
	15.625 kHz clock pulse (number)	Time (milliseconds)
$I_{10}$ (see table 1) .....	22	1.408
$I_{11}$ .....	23	1.472
$I_{12}$ .....	24	1.536
END PREAMBLE .....	25	1.600

<sup>1</sup> Applies to all functions transmitted.

<sup>2</sup> Reference time for receiver synchronization for all function timing.

TABLE 3—FUNCTION IDENTIFICATION CODES

Function	Code						
	$I_6$	$I_7$	$I_8$	$I_9$	$I_{10}$	$I_{11}$	$I_{12}$
Approach azimuth .....	0	0	1	1	0	0	1
High rate approach azimuth .....	0	0	1	0	1	0	0
Approach elevation .....	1	1	0	0	0	0	1
Back azimuth .....	1	0	0	1	0	0	1
Basic data 1 .....	0	1	0	1	0	0	0
Basic data 2 .....	0	1	1	1	1	0	0
Basic data 3 .....	1	0	1	0	0	0	0
Basic data 4 .....	1	0	0	0	1	0	0
Basic data 5 .....	1	1	0	1	1	0	0
Basic data 6 .....	0	0	0	1	1	0	1
Auxiliary data A .....	1	1	1	0	0	1	0
Auxiliary data B .....	1	0	1	0	1	1	1
Auxiliary data C .....	1	1	1	1	0	0	0

(ii) *Sector signals.* In all azimuth formats, sector signals must be transmitted to provide Morse Code identification, airborne antenna selection, and system test signals. These signals are not required in the elevation formats. In addition, if the signal from an installed ground component results in a valid indication in an area where no valid guidance should exist, OCI signals must be radiated as provided for in the signal format (see Tables 4a, 4b, and 5). The sector signals are defined as follows:

(A) *Morse Code.* DPSK transmissions that will permit Morse Code facility

identification in the aircraft by a four letter code starting with the letter ‘‘M’’ must be included in all azimuth functions. They must be transmitted and repeated at approximately equal intervals, not less than six times per minute, during which time the ground subsystem is available for operational use. When the transmissions of the ground subsystem are not available, the identification signal must be suppressed. The audible tone in the aircraft is started by setting the Morse Code bit to logic ‘‘1’’ and stopped by a logic ‘‘0’’ (see Tables 4a and 4b). The identification code characteristics must conform to the following: the dot must be between 0.13 and 0.16 second in duration, and the dash between 0.39 and 0.48 second. The duration between dots and/or dashes must be one dot plus or minus 10%. The duration between characters (letters) must not be less than three dots. When back azimuth is provided, the code shall be transmitted by the approach azimuth and back azimuth within plus or minus 0.08 seconds.

(B) *Airborne antenna selection.* A signal for airborne antenna selection shall be transmitted as a ‘‘zero’’ DPSK signal lasting for a six-bit period (see Tables 4a and 4b).

TABLE 4a—APPROACH AZIMUTH FUNCTION TIMING

Event	Event time slot begins at—	
	15.625 kHz clock pulse (number)	Time (milliseconds)
Preamble .....	0	0
Morse code .....	25	1.600
Antenna select .....	26	1.664
Rear OCI .....	32	2.048
Left OCI .....	34	2.176
Right OCI .....	36	2.304
To test .....	38	2.432
To scan <sup>1</sup> .....	40	2.560
Pause .....	.....	8.760
Midscan point .....	.....	9.060
FRO scan <sup>1</sup> .....	.....	9.360
FRO test .....	.....	15.560
End Function (Airborne) .....	.....	15.688
End guard time; end function (ground) .....	.....	15.900

<sup>1</sup>AA<sup>1</sup>The actual commencement and completion of the TO and the FRO scan transmissions are dependent on the amount of proportional guidance provided. The time slots provided shall accommodate a maximum scan of plus or minus 62.0 degrees. Scan timing shall be compatible with accuracy requirements.

TABLE 4b—HIGH RATE APPROACH AZIMUTH AND BACK AZIMUTH FUNCTION TIMING

Event	Event time slot begins at—	
	15.625 kHz clock pulse (number)	Time (milliseconds)
Preamble .....	0	0
Morse Code .....	25	1.600
Antenna select .....	26	1.664
Rear OCI .....	32	2.048
Left OCI .....	34	2.176
Right OCI .....	36	2.304
To test .....	38	2.432
To scan <sup>1</sup> .....	40	2.560
Pause .....	.....	6.760
Midscan point .....	.....	7.060
FRO scan <sup>1</sup> .....	.....	7.360
FRO test pulse .....	.....	11.560
End function (airborne) .....	.....	11.688
End guard time; end function (ground) .....	.....	11.900

<sup>1</sup>The actual commencement and completion of the TO and the FRO scan transmissions are dependent on the amount of proportional guidance provided. The time slots provided will accommodate a maximum scan of plus or minus 42.0 degrees. Scan timing shall be compatible with accuracy requirements.

(C) *OCI.* Where OCI pulses are used, they must be: (1) greater than any guidance signal in the OCI sector; (2) at least 5 dB less than the level of the scanning beam within the proportional guidance sector; and (3) for azimuth functions with clearance signals, at least 5 dB less than the level of the left (right) clearance pulses within the left (right) clearance sector.

TABLE 5—APPROACH ELEVATION FUNCTION TIMING

Event	Event time slot begins at:	
	15.625 kHz clock pulse (number)	Time (milliseconds)
Preamble .....	0	0
Processor pause .....	25	1.600
OCI .....	27	1.728
To scan <sup>1</sup> .....	29	1.856
Pause .....	.....	3.406
Midscan point .....	.....	3.606
FRO scan <sup>1</sup> .....	.....	3.806
End function (airborne) .....	.....	5.356
End guard time; end function (ground) .....	.....	5.600

<sup>1</sup>The actual commencement and completion of the TO and FRO scan transmissions are dependent upon the amount of proportional guidance provided. The time slots provided will accommodate a maximum scan of -1.5 degrees to +29.5 degrees. Scan timing shall be compatible with accuracy requirements.

§ 171.311

14 CFR Ch. I (1-1-08 Edition)

The duration of each pulse measured at the half amplitude point shall be at least 100 microseconds, and the rise and fall times shall be less than 10 microseconds. It shall be permissible to sequentially transmit two pulses in each out-of-coverage indication time slot. Where pulse pairs are used, the duration of each pulse shall be at least 50 microseconds, and the rise and fall times shall be less than 10 microseconds. The transmission of out-of-coverage indication pulses radiated from antennas with overlapping coverage patterns shall be separated by at least 10 microseconds.

NOTE: If desired, two pulses may be sequentially transmitted in each OCI time slot. Where pulse pairs are used, the duration of each pulse must be 45 (±5) microseconds and the rise and fall times must be less than 10 microseconds.

(D) *System test.* Time slots are provided in Tables 4a and 4b to allow radiation of TO and FRO test pulses. However, radiation of these pulses is not required since the characteristics of these pulses have not yet been standardized.

(iii) *Angle encoding.* The encoding must be as follows:

(A) *General.* Azimuth and elevation angles are encoded by scanning a nar-

row beam between the limits of the proportional coverage sector first in one direction (the TO scan) and then in the opposite direction (the FRO scan). Angular information must be encoded by the amount of time separation between the beam centers of the TO and FRO scanning beam pulses. The TO and FRO transmissions must be symmetrically disposed about the midscan point listed in Tables 4a, 4b, 5, and 7. The midscan point and the center of the time interval between the TO and FRO scan transmissions must coincide with a tolerance of ±10 microseconds. Angular coding must be linear with angle and properly decoded using the formula:

$$\theta = \frac{V}{2}(T_0 - t)$$

where:

θ=Receiver angle in degrees.

V= Scan velocity in degrees per microsecond.

T<sub>0</sub>=Time separation in microseconds between TO and FRO beam centers corresponding to zero degrees.

t= Time separation in microseconds between TO and FRO beam centers.

The timing requirements are listed in Table 6 and illustrated in Figure 7.

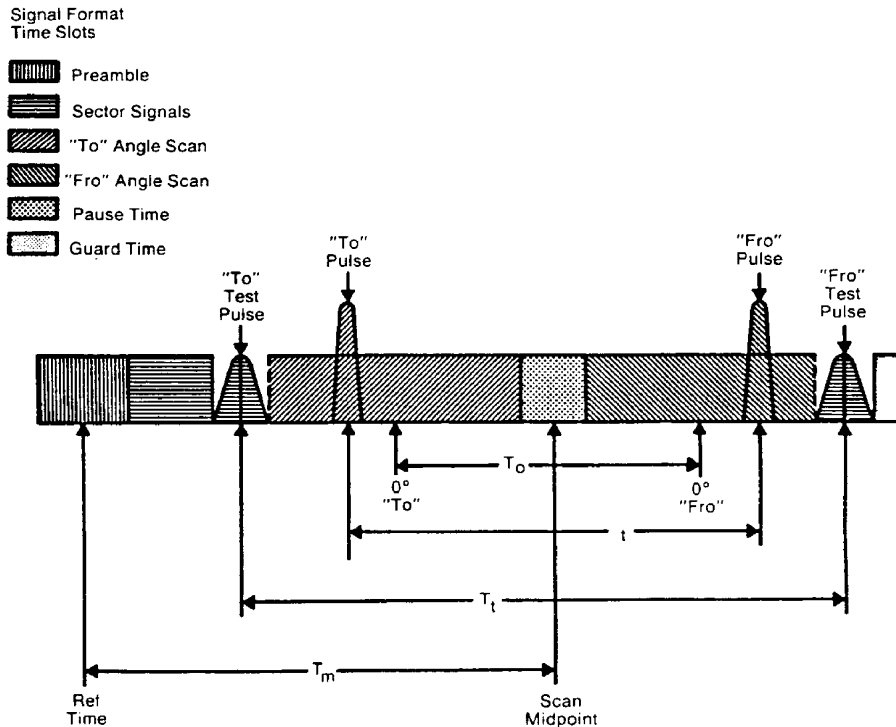

Figure 7. Azimuth Angle Scan Timing (Not to Scale)

(B) *Azimuth angle encoding.* Each guidance angle transmitted must consist of a clockwise TO scan followed by a counterclockwise FRO scan as viewed from above the antenna. For approach azimuth functions, increasing angle values must be in the direction of the TO scan; for the back azimuth function, increasing angle values must be in the direction of the FRO scan. The antenna has a narrow beam in the plane of the scan direction and a broad beam in the orthogonal plane which fills the vertical coverage.

(C) *Elevation angle encoding.* The radiation from elevation equipment must produce a beam which scans from the horizon up to the highest elevation angle and then scans back down to the horizon. The antenna has a narrow beam in the plane of the scan direction and a broad beam in the orthogonal plane which fills the horizontal cov-

erage. Elevation angles are defined from the horizontal plane containing the antenna phase center; positive angles are above the horizontal and zero angle is along the horizontal.

(iv) *Clearance guidance.* The timing of the clearance pulses must be in accordance with Figure 8. For azimuth elements with proportional coverage of less than  $\pm 40$  degrees ( $\pm 20$  degrees for back azimuth), clearance guidance information must be provided by transmitting pulses in a TO and FRO format adjacent to the stop/start times of the scanning beam signal. The fly-right clearance pulses must represent positive angles and the fly-left clearance pulses must represent negative angles. The duration of each clearance pulse must be 50 microseconds with a tolerance of  $\pm 5$  microseconds. The transmitter switching time between the clearance pulses and the scanning

beam transmissions must not exceed 10 microseconds. The rise time at the edge of each clearance pulse must be less than 10 microseconds. Within the fly-right clearance guidance section, the fly-right clearance guidance signal shall exceed scanning beam antenna sidelobes and other guidance and OCI signals by at least 5 dB; within the fly-left clearance guidance sector, the fly left clearance guidance signal shall exceed scanning beam antenna sidelobes and all other guidance and OCI signals by at least 5 dB; within the proportional guidance sector, the clearance guidance signals shall be at least 5dB below the proportional guidance signal. Optionally, clearance guidance may be provided by scanning throughout the approach guidance sector. For angles outside the approach azimuth proportional coverage limits as set in Basic Data Word One (Basic Data Word 5 for back azimuth), proper decode and display of clearance guidance must occur to the limits of the guidance region.

Where used, clearance pulses shall be transmitted adjacent to the scanning beam signals at the edges of proportional coverage as shown in Figure 8. The proportional coverage boundary shall be established at one beamwidth inside the scan start/stop angles, such that the transition between scanning beam and clearance signals occurs outside the proportional coverage sector. When clearance pulses are provided in conjunction with a narrow beamwidth (e.g., one degree) scanning antenna, the scanning beam antenna shall radiate for 15 microseconds while stationary at the scan start/stop angles.

(3) *Data function format.* Basic data words provide equipment characteristics and certain siting information. Basic data words must be transmitted from an antenna located at the approach azimuth or back azimuth site which provides coverage throughout the appropriate sector. Data function timing must be in accordance with Table 7a.

TABLE 6—ANGLE SCAN TIMING CONSTANTS

Function	Max value of $t_r$ (usec)	$T_a$ (usec)	V(deg/usec)	$T_m$ (usec)	Pause time (usec)	$T_i$ (usec)
Approach azimuth .....	13,000	6,800	0.02	7,972	600	13,128
High rate approach azimuth .....	9,000	4,800	0.02	5,972	600	9,128
Approach elevation .....	3,500	3,350	0.02	2,518	400	N/A
Back azimuth .....	9,000	4,800	-0.02	5,972	600	9,128

TABLE 7a—BASIC DATA FUNCTION TIMING

Event	Event time slot begins at: <sup>1</sup>	
	15,625 kHz clock pulse (number)	Time (milliseconds)
Preamble .....	0	0
Data transmission (bits I <sub>13</sub> –I <sub>30</sub> ) .....	25	1.600
Parity transmission (bits I <sub>31</sub> –I <sub>32</sub> ) .....	43	2.752
End function (airborne) .....	45	2.880
End guard time: end function (ground) .....	.....	3.100

<sup>1</sup> The previous event time slot ends at this time.

TABLE 7b—AUXILIARY DATA FUNCTION TIMING—(DIGITAL)

Event	Event time slot begins at:	
	15,625 kHz clock pulse (number)	Time (milliseconds)
Preamble .....	0	0
Address transmission (bits I <sub>13</sub> –I <sub>20</sub> ) .....	25	1.600
Data transmission: (bits I <sub>21</sub> –I <sub>69</sub> ) .....	33	2.112
Parity transmission (bits I <sub>70</sub> –I <sub>76</sub> ) .....	82	5.248
End function (airborne) .....	89	5.696
End guard time; end function (ground) .....	.....	5.900

TABLE 7c—AUXILIARY DATA FUNCTION TIMING—  
(ALPHANUMERIC)

Event	Event time slot begins at:	
	15.615 kHz clock pulse (number)	Time (milliseconds)
Preamble .....	0	0
Address transmission (bits I <sub>13</sub> –I <sub>20</sub> ) .....	25	1.600
Data transmission: (bits I <sub>21</sub> –I <sub>76</sub> ) .....	33	2.112
End function (airborne) .....	89	5.696
End guard time; (end function ground) .....	.....	5.900

(i) *Preamble*. Must be in accordance with requirements of §171.311(i)(1).

(ii) *Data transmissions*. Basic data must be transmitted using DPSK modulation. The content and repetition rate of each basic data word must be in accordance with Table 8a. For data containing digital information, binary number 1 must represent the lower range limit with increments in binary steps to the upper range limit shown in

Table 8a. Data containing digital information shall be transmitted with the least significant bit first.

(j) *Basic Data word requirements*. Basic Data shall consist of the items specified in Table 8a. Basic Data word contents shall be defined as follows:

(1) *Approach azimuth to threshold distance* shall represent the minimum distance between the Approach Azimuth antenna phase center and the vertical plane perpendicular to the centerline which contains the landing threshold.

(2) *Approach azimuth proportional coverage limit* shall represent the limit of the sector in which proportional approach azimuth guidance is transmitted.

(3) *Clearance signal type* shall represent the type of clearance when used. Pulse clearance is that which is in accordance with §171.311 (i) (2) (iv). Scanning Beam (SB) clearance indicates that the proportional guidance sector is limited by the proportional coverage limits set in basic data.

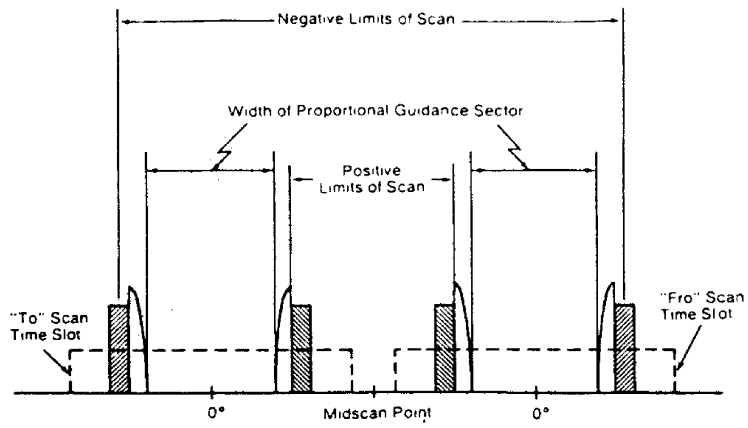

(a) APPROACH AZIMUTH

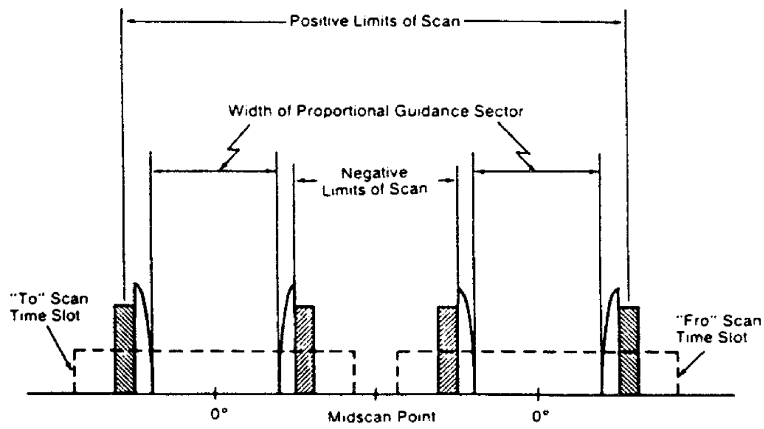

(b) BACK AZIMUTH

Legend





Clearance Pulses	Scanning Beam Pulses
 Fly-Left	 Start Scan
 Fly-Right	 Stop Scan

Figure 8. Clearance Pulse Timing for Azimuth Functions

TABLE 8a—BASIC DATA WORDS

Data bit #	Data item definition	LSB value	Data bit value
<b>Basic Data Word No. 1</b>			
1	Preamble .....	N/A	1
2	.....	1	1
3	.....	1	1
4	.....	0	0
5	.....	1	1
6	.....	0	0
7	.....	1	1
8	.....	0	0
9	.....	1	1
10	.....	0	0
11	.....	0	0
12	.....	0	0
13	Approach azimuth to threshold distance (Om – 630m).	100m	100m
14	.....	.....	200m
15	.....	.....	400m
16	.....	.....	800m
17	.....	.....	1600m
18	.....	.....	3200m
19	Approach azimuth proportional coverage limit (negative limit) (0° to –62°).	2°	–2°
20	.....	.....	–4°
21	.....	.....	–8°
22	.....	.....	–16°
23	.....	.....	–32°
24	Approach azimuth proportional coverage limit (positive limit) (0° to +62°).	2°	2°
25	.....	.....	4°
26	.....	.....	8°
27	.....	.....	16°
28	.....	.....	32°
29	Clearance signal type .....	N/A	0=pulse; 1=SB
30	Spare .....	.....	Transmit zero
31	Parity: (13+14+15. . .+30 +31=odd).	N/A	N/A
32	Parity: (14+16+18. . .+30 +32=odd).	N/A	N/A

*Note 1:* Transmit throughout the Approach Azimuth guidance sector at intervals of 1.0 seconds or less.  
*Note 2:* The all zero state of the data field represents the lower limit of the absolute value of the coded parameter unless otherwise noted.

Basic Data Word No. 2

1	Preamble .....	N/A	1
2	.....	1	1
3	.....	1	1
4	.....	0	0
5	.....	1	1
6	.....	0	0
7	.....	1	1
8	.....	1	1
9	.....	1	1
10	.....	1	1
11	.....	0	0
12	.....	0	0
13	Minimum glide path (2.0° to 14.7°).	0.1°	0.1°
14	.....	.....	0.2°
15	.....	.....	0.4°
16	.....	.....	0.8°

TABLE 8a—BASIC DATA WORDS—Continued

Data bit #	Data item definition	LSB value	Data bit value
17	.....	.....	1.6°
18	.....	.....	3.2°
19	.....	.....	6.4°
20	Back azimuth status .....	.....	see note 4
21	DME status .....	.....	see note 6
22	.....	.....	.....
23	Approach azimuth status .....	.....	see note 4
24	Approach azimuth status .....	.....	see note 4
25	Spare .....	.....	Transmit zero
26	.....do .....	.....	Do.
27	.....do .....	.....	Do.
28	.....do .....	.....	Do.
29	.....do .....	.....	Do.
30	.....do .....	.....	Do.
31	Parity: (13+14+15. . .+30 +31)=odd).	N/A	N/A
32	Parity: (14+16+18. . .+30 +32)=odd).	N/A	N/A

*Note 1:* Transmit throughout the Approach Azimuth guidance sector at intervals of 0.16 seconds or less.  
*Note 2:* The all zero state of the data field represents the lower limit of the absolute range of the coded parameter unless otherwise noted.

Basic Data Word No. 3

1	Preamble .....	N/A	1
2	.....	1	1
3	.....	1	1
4	.....	0	0
5	.....	1	1
6	.....	1	1
7	.....	0	0
8	.....	1	1
9	.....	0	0
10	.....	0	0
11	.....	0	0
12	.....	0	0
13	Approach azimuth beamwidth (0.5° – 4.0°) See note 7.	0.5°	0.5°
14	.....	.....	1.0°
15	.....	.....	2.0°
16	Approach elevation beamwidth (0.5° to 2.5°) See note 7.	0.5°	0.5°
17	.....	.....	1.0°
18	Note: values greater than 2.5° are invalid.	.....	2.0°
19	DME distance (Om to 6387.5m).	12.5m	12.5m
20	.....	.....	25.0m
21	.....	.....	50.0m
22	.....	.....	100.0m
23	.....	.....	200.0m
24	.....	.....	400.0m
25	.....	.....	800.0m
26	.....	.....	1600.0m
27	.....	.....	3200.0m
28	Spare .....	.....	Transmit zero
29	.....do .....	.....	Do.
30	.....do .....	.....	Do.
31	Parity: (13+14+15. . .+30 +31=odd).	.....	.....
32	Parity: (14+16+18. . .+30 +32=odd).	N/A	N/A

§ 171.311

14 CFR Ch. I (1-1-08 Edition)

TABLE 8a—BASIC DATA WORDS—Continued

Data bit #	Data item definition	LSB value	Data bit value
<i>Note 1:</i> Transmit throughout the Approach Azimuth guidance sector at intervals of 1.0 seconds or less.			
<i>Note 2:</i> The all zero state of the data field represents the lower limit of the absolute range of the coded parameter unless otherwise noted.			

**Basic Data Word No. 4**

Data bit #	Data item definition	LSB value	Data bit value
1	Preamble .....	N/A	1
2	.....	1	1
3	.....	1	1
4	.....	0	0
5	.....	1	1
6	.....	1	1
7	.....	0	0
8	.....	0	0
9	.....	0	0
10	.....	1	1
11	.....	0	0
12	.....	0	0
13	Approach azimuth magnetic orientation (0° to 359°).	1°	1°
14	.....	.....	2°
15	.....	.....	4°
16	.....	.....	8°
17	.....	.....	16°
18	.....	.....	32°
19	.....	.....	64°
20	.....	.....	128°
21	.....	.....	256°
22	Back azimuth magnetic orientation (0° to 359°).	1°	1°
23	.....	.....	2°
24	.....	.....	4°
25	.....	.....	8°
26	.....	.....	16°
27	.....	.....	32°
28	.....	.....	64°
29	.....	.....	128°
30	.....	.....	256°
31	Parity: (13+14+15. . .+30 +31=odd).	N/A	N/A
32	Parity: (14+16+18. . .+30 +32=odd).	N/A	N/A

*Note 1:* Transmit at intervals of 1.0 second or less throughout the Approach Azimuth guidance sector, except when Back Azimuth guidance is provided. See Note 8.

*Note 2:* The all zero state of the data field represents the lower limit of the absolute range of the coded parameter unless otherwise noted.

**Basic Data Word No. 5**

Data bit #	Data item definition	LSB value	Data bit value
1	Preamble .....	N/A	1
2	.....	1	1
3	.....	1	1
4	.....	0	0
5	.....	1	1
6	.....	1	1
7	.....	1	1
8	.....	0	0
9	.....	1	1
10	.....	1	1
11	.....	0	0
12	.....	0	0
13	Back azimuth proportional coverage negative limit (0° to -42°).	2°	-2°
14	.....	.....	-4°
15	.....	.....	-8°

TABLE 8a—BASIC DATA WORDS—Continued

Data bit #	Data item definition	LSB value	Data bit value
16	.....	.....	-16°
17	.....	.....	-32°
18	Back azimuth proportional coverage positive limit (0° to +42°).	2°	2°
19	.....	.....	4°
20	.....	.....	8°
21	.....	.....	16°
22	.....	.....	32°
23	Back azimuth beamwidth (0.5° to 4.0°) See note 7.	0.5°	0.5°
24	.....	.....	1.0°
25	.....	.....	2.0°
26	Back azimuth status .....	.....	See Note 10
27	.....do .....	.....	Do.
28	.....do .....	.....	Do.
29	.....do .....	.....	Do.
30	.....do .....	.....	Do.
31	Parity: (13+14+15. . .+30 +31=odd).	N/A	N/A
32	Parity: (14+16+18. . .+30 +32=odd).	N/A	N/A

**Basic Data Word No. 6**

Data bit #	Data item definition	LSB value	Data bit value
1	Preamble .....	N/A	1
2	.....	.....	1
3	.....	.....	1
4	.....	.....	0
5	.....	.....	1
6	.....	.....	0
7	.....	.....	0
8	.....	.....	0
9	.....	.....	1
10	.....	.....	1
11	.....	.....	0
12	.....	.....	1
(13-30)	MLS ground equipment identification (Note 3).	.....	.....
13	Character 2 .....	N/A	B1
14	.....	.....	B2
15	.....	.....	B3
16	.....	.....	B4
17	.....	.....	B5
18	.....	.....	B6
19	Character 3 .....	N/A	B1
20	.....	.....	B2
21	.....	.....	B3
22	.....	.....	B4
23	.....	.....	B5
24	.....	.....	B6
25	Character 4 .....	N/A	B1
26	.....	.....	B2
27	.....	.....	B3
28	.....	.....	B4
29	.....	.....	B5
30	.....	.....	B6
31	Parity: (13+14+15. . .+30 +31=odd).	N/A	N/A
32	Parity: (14+16+18. . .+30 +32=odd).	N/A	N/A

*Note 1:* Transmit only when Back Azimuth guidance is provided. See note 9.

*Note 2:* The all zero state of the data field represents the lower limit of the absolute range of the coded parameter unless otherwise noted.

*Note 1:* Transmit at intervals of 1.0 second or less throughout the Approach Azimuth guidance sector, except when Back Azimuth guidance is provided. See note 8.

Note 3: Characters are encoded using the International Alphabet Number 5, (IA-5):

Note 4: Coding for status bit:  
0=Function not radiated, or radiated in test mode (not reliable for navigation).

1=Function radiated in normal mode (for Back Azimuth, this also indicates that a Back Azimuth transmission follows).

Note 5: Data items which are not applicable to a particular ground equipment shall be transmitted as all zeros.

Note 6: Coding for status bits:

$l_{21}$	$l_{22}$	
0	0	DME transponder inoperative or not available.
1	0	Only IA mode or DME/N available.
0	0	FA mode, Standard 1, available.
1	1	FA mode, Standard 2, available.

Note 7: The value coded shall be the actual beamwidth (as defined in § 171.311 (j)(9) rounded to the nearest 0.5 degree.

Note 8: When back Azimuth guidance is provided, Data Words 4 and 6 shall be transmitted at intervals of 1.33 seconds or less throughout the Approach Azimuth coverage and 4 seconds or less throughout the Back Azimuth coverage.

Note 9: When Back Azimuth guidance is provided, Data Word 5 shall be transmitted at an interval of 1.33 seconds or less throughout the Back Azimuth coverage sector and 4 seconds or less throughout the Approach Azimuth coverage sector.

Note 10: Coding for status bit:  
0=Function not radiated, or radiated in test mode (not reliable for navigation).

1=Function radiated in normal mode.

(4) *Minimum glidepath* the lowest angle of descent along the zero degree azimuth that is consistent with published approach procedures and obstacle clearance criteria.

(5) *Back azimuth status* shall represent the operational status of the Back Azimuth equipment.

(6) *DME status* shall represent the operational status of the DME equipment.

(7) *Approach azimuth status* shall represent the operational status of the approach azimuth equipment.

(8) *Approach elevation status* shall represent the operational status of the approach elevation equipment.

(9) *Beamwidth* the width of the scanning beam main lobe measured at the -3 dB points and defined in angular units on the antenna boresight, in the horizontal plane for the azimuth function and in the vertical plane for the elevation function.

(10) *DME distance* shall represent the minimum distance between the DME antenna phase center and the vertical plane perpendicular to the runway centerline which contains the MLS datum point.

(11) *Approach azimuth magnetic orientation* shall represent the angle measured in the horizontal plane clockwise from Magnetic North to the zero-degree angle guidance radial originating from the approach azimuth antenna phase center. The vertex of the meas-

ured angle shall be at the approach azimuth antenna phase center.

NOTE: For example, this data item would be encoded 090 for an approach azimuth antenna serving runway 27 (assuming the magnetic heading is 270 degrees) when sited such that the zero degree radial is parallel to centerline.

(12) *Back azimuth magnetic orientation* shall represent the angle measured in the horizontal plane clockwise from Magnetic North to the zero-degree angle guidance radial originating from the Back Azimuth antenna. The vertex of the measured angle shall be at the Back Azimuth antenna phase center.

NOTE: For example, this data item would be encoded 270 for a Back Azimuth Antenna serving runway 27 (assuming the magnetic heading is 270 degrees) when sited such that the zero degree radial is parallel to centerline.

(13) *Back azimuth proportional coverage limit* shall represent the limit of the sector in which proportional back azimuth guidance is transmitted.

(14) *MLS ground equipment identification* shall represent the last three characters of the system identification specified in § 171.311(i)(2). The characters shall be encoded in accordance with International Alphabet No. 5 (IA-5) using bits  $b_1$  through  $b_6$ .

NOTE: Bit  $b_7$  of this code may be reconstructed in the airborne receiver by taking the complement of bit  $b_6$ .

(k) *Residual radiation*. The residual radiation of a transmitter associated with an MLS function during time intervals when it should not be transmitting shall not adversely affect the reception of any other function. The residual radiation of an MLS function at times when another function is radiating shall be at least 70 dB below the level provided when transmitting.

(l) *Symmetrical scanning*. The TO and FRO scan transmissions shall be symmetrically disposed about the mid-scan point listed in Tables 4a, 4b and 5. The mid-scan point and the center of the time interval between the TO and FRO scan shall coincide with a tolerance of plus or minus 10 microseconds.

(m) *Auxiliary data*—(1) *Addresses*. Three function identification codes are reserved to indicate transmission of Auxiliary Data A, Auxiliary Data B,

and Auxiliary Data C. Auxiliary Data A contents are specified below, Auxiliary Data B contents are reserved for future use, and Auxiliary Data C contents are reserved for national use. The address codes of the auxiliary data words shall be as shown in Table 8b.

(2) *Organization and timing.* The organization and timing of digital auxiliary data must be as specified in Table 7b. Data containing digital information must be transmitted with the least significant bit first. Alphanumeric data characters must be encoded in accordance with the 7-unit code character set as defined by the American National Standard Code for Information Interchange (ASCII). An even parity bit is added to each character. Alphanumeric data must be transmitted in the order in which they are to be read. The serial transmission of a character must be with the lower order bit transmitted first and the parity bit transmitted last. The timing for alphanumeric auxiliary data must be as shown in Table 7c.

(3) *Auxiliary Data A content:* The data items specified in Table 8c are defined as follows:

(i) *Approach azimuth antenna offset* shall represent the minimum distance between the Approach Azimuth antenna phase center and the vertical plane containing the runway centerline.

(ii) *Approach azimuth to MLS datum point distance* shall represent the minimum distance between the Approach Azimuth antenna phase center and the vertical plane perpendicular to the centerline which contains the MLS datum point.

(iii) *Approach azimuth alignment with runway centerline* shall represent the minimum angle between the approach azimuth antenna zero-degree guidance plane and the runway centerline.

(iv) *Approach azimuth antenna coordinate system* shall represent the coordinate system (planar or conical) of the angle data transmitted by the approach azimuth antenna.

(v) *Approach elevation antenna offset* shall represent the minimum distance between the elevation antenna phase center and the vertical plane containing the runway centerline.

(vi) *MLS datum point to threshold distance* shall represent the distance measured along the runway centerline from the MLS datum point to the runway threshold.

(vii) *Approach elevation antenna height* shall represent the height of the elevation antenna phase center relative to the height of the MLS datum point.

(viii) *DME offset* shall represent the minimum distance between the DME antenna phase center and the vertical plane containing the runway centerline.

(ix) *DME to MLS datum point distance* shall represent the minimum distance between the DME antenna phase center and the vertical plane perpendicular to the centerline which contains the MLS datum point.

(x) *Back azimuth antenna offset* shall represent the minimum distance between the back azimuth antenna phase center and the vertical plane containing the runway centerline.

(xi) *Back azimuth to MLS datum point distance* shall represent the minimum distance between the Back Azimuth antenna and the vertical plane perpendicular to the centerline which contains the MLS datum point.

(xii) *Back azimuth antenna alignment with runway centerline* shall represent the minimum angle between the back azimuth antenna zero-degree guidance plane and the runway centerline.

**§ 171.313 Azimuth performance requirements.**

This section prescribes the performance requirements for the azimuth equipment of the MLS as follows:

(a) *Approach azimuth coverage requirements.* The approach azimuth equipment must provide guidance information in at least the following volume of space (see Figure 9):

TABLE 8b—AUXILIARY DATA WORD ADDRESS CODES

No.	I <sub>13</sub>	I <sub>14</sub>	I <sub>15</sub>	I <sub>16</sub>	I <sub>17</sub>	I <sub>18</sub>	I <sub>19</sub>	I <sub>20</sub>
1.	0	0	0	0	0	1	1	1
2.	0	0	0	0	1	0	1	0
3.	0	0	0	0	1	1	0	1
4.	0	0	0	1	0	0	1	1
5.	0	0	0	1	0	1	0	0
6.	0	0	0	1	1	0	0	1
7.	0	0	0	1	1	1	1	0
8.	0	0	1	0	0	0	1	0

TABLE 8b—AUXILIARY DATA WORD ADDRESS CODES—Continued

No.	I <sub>13</sub>	I <sub>14</sub>	I <sub>15</sub>	I <sub>16</sub>	I <sub>17</sub>	I <sub>18</sub>	I <sub>19</sub>	I <sub>20</sub>
9.	0	0	1	0	0	1	0	1
10.	0	0	1	0	1	0	0	0
11.	0	0	1	0	1	1	1	1
12.	0	0	1	1	0	0	0	1
13.	0	0	1	1	0	1	1	0
14.	0	0	1	1	1	0	1	1
15.	0	0	1	1	1	1	0	0
16.	0	1	0	0	0	0	1	1
17.	0	1	0	0	0	1	0	0
18.	0	1	0	0	1	0	0	1
19.	0	1	0	0	1	1	1	0
20.	0	1	0	1	0	0	0	0
21.	0	1	0	1	0	1	1	1
22.	0	1	0	1	1	0	1	0
23.	0	1	0	1	1	1	0	1
24.	0	1	1	0	0	0	0	1
25.	0	1	1	0	0	1	1	0
26.	0	1	1	0	1	0	1	1
27.	0	1	1	0	1	1	0	0
28.	0	1	1	1	0	0	1	0
29.	0	1	1	1	0	1	0	1
30.	0	1	1	1	1	0	0	0
31.	0	1	1	1	1	1	1	1
32.	1	0	0	0	0	0	1	0
33.	1	0	0	0	0	1	0	1
34.	1	0	0	0	1	0	0	0
35.	1	0	0	0	1	1	1	1
36.	1	0	0	1	0	0	0	1
37.	1	0	0	1	0	1	1	0
38.	1	0	0	1	1	0	1	1
39.	1	0	0	1	1	1	0	0
40.	1	0	1	0	0	0	0	0

TABLE 8b—AUXILIARY DATA WORD ADDRESS CODES—Continued

No.	I <sub>13</sub>	I <sub>14</sub>	I <sub>15</sub>	I <sub>16</sub>	I <sub>17</sub>	I <sub>18</sub>	I <sub>19</sub>	I <sub>20</sub>
41.	1	0	1	0	0	1	1	1
42.	1	0	1	0	1	0	1	0
43.	1	0	1	0	1	1	0	1
44.	1	0	1	1	0	0	1	1
45.	1	0	1	1	0	1	0	0
46.	1	0	1	1	1	0	0	1
47.	1	0	1	1	1	1	1	0
48.	1	1	0	0	0	0	0	1
49.	1	1	0	0	0	1	1	0
50.	1	1	0	0	1	0	1	1
51.	1	1	0	0	1	1	0	0
52.	1	1	0	1	0	0	1	0
53.	1	1	0	1	0	1	0	1
54.	1	1	0	1	1	0	0	0
55.	1	1	0	1	1	1	1	1
56.	1	1	1	0	0	0	1	1
57.	1	1	1	0	0	1	0	0
58.	1	1	1	0	1	0	0	1
59.	1	1	1	0	1	1	1	0
60.	1	1	1	1	1	0	0	0
61.	1	1	1	1	0	1	1	1
62.	1	1	1	1	1	0	1	0
63.	1	1	1	1	1	1	0	1
64.	0	0	0	0	0	0	0	0

NOTE 1: Parity bits I<sub>19</sub> and I<sub>20</sub> are chosen to satisfy the equations:  
 $I_{13} + I_{14} + I_{15} + I_{16} + I_{17} + I_{18} + I_{19} = \text{EVEN}$   
 $I_{14} + I_{16} + I_{18} + I_{20} = \text{EVEN}$

TABLE 8c—AUXILIARY DATA

Word (See note 6)	Data content	Type of data	Maximum time between transmissions (Seconds)	Bits used	Range of values	Least significant bit
A1	Preamble	Digital	1.0	12		
	Address			8		
	Approach azimuth antenna offset			10	-511 m to +511 m (See note 3).	1 m
	Approach azimuth to MLS datum point distance.			13	0 m to 8 191 m	1 m
	Approach azimuth antenna alignment with runway centerline.			12	-20.47° to 20.47° (See note 3).	0.01°
	Approach azimuth antenna coordinate system.			1	(See note 2)	
	Spare				13	
A2	Parity			7	(See note 1)	
	Preamble	Digital	1.0	12		
	Address			8		
	Approach elevation antenna offset			10	-511 m to +511 m (See note 3).	1 m
	MLS datum point to threshold distance			10	0 m to 1 023 m	1 m
	Approach elevation antenna height			7	-6.3 m to +6.3 m (See note 3).	0.1 m
	Spare				22	
A3	Parity			7	(See note 1)	
	Preamble	Digital	(See note 4)	12		
	Address			8		
	DME offset			10	-511 m to +511 m	1 m
	DME to MLS datum point distance			14	-8 191 m to +8 191 m (See note 3).	1 m
	Spare				25	
	Parity				7	(See note 1)

TABLE 8C—AUXILIARY DATA—Continued

Word (See note 6)	Data content	Type of data	Maximum time between transmissions (Seconds)	Bits used	Range of values	Least significant bit
A4 .....	Preamble .....	Digital ...	(See note 5)	12	.....	.....
	Address .....	.....	.....	8	.....	.....
	Back azimuth antenna .....	.....	.....	10	-511 m to +511 m (See note 3).	1 m
	Back azimuth to MLS datum point distance.	.....	.....	11	0 m to 2 047 m .....	1 m
	Back azimuth antenna alignment with runway centerline.	.....	.....	12	-20.47° to 20.47° (See note 3).	0.01°
	Spare .....	.....	.....	16	.....	.....
	Parity .....	.....	.....	7	(See note 1) .....	.....

NOTE 1: Parity bits I<sub>70</sub> to I<sub>76</sub> are chosen to satisfy the equations which follow:

For BIT I<sub>70</sub>:

$$\text{Even} = (I_{13} + \dots + I_{18}) + I_{20} + I_{22} + I_{24} + I_{25} + I_{28} + I_{29} + I_{31} + I_{32} + I_{33} + I_{35} + I_{36} + I_{38} + I_{41} + I_{44} + I_{45} + I_{46} + I_{50} + (I_{52} + \dots + I_{55}) + I_{58} + I_{60} + I_{64} + I_{65} + I_{70}$$

For BIT I<sub>71</sub>:

$$\text{Even} = (I_{14} + \dots + I_{19}) + I_{21} + I_{23} + I_{25} + I_{26} + I_{29} + I_{30} + I_{32} + I_{33} + I_{34} + I_{36} + I_{37} + I_{39} + I_{42} + I_{45} + I_{46} + I_{47} + I_{51} + (I_{53} + \dots + I_{56}) + I_{59} + I_{61} + I_{65} + I_{66} + I_{71}$$

For BIT I<sub>72</sub>:

$$\text{Even} = (I_{15} + \dots + I_{20}) + I_{22} + I_{24} + I_{26} + I_{27} + I_{30} + I_{31} + I_{33} + I_{34} + I_{35} + I_{37} + I_{38} + I_{40} + I_{43} + I_{46} + I_{47} + I_{48} + I_{52} + (I_{54} + \dots + I_{57}) + I_{60} + I_{62} + I_{66} + I_{67} + I_{72}$$

For BIT I<sub>73</sub>:

$$\text{Even} = (I_{16} + \dots + I_{21}) + I_{23} + I_{25} + I_{27} + I_{28} + I_{31} + I_{32} + I_{34} + I_{35} + I_{36} + I_{38} + I_{39} + I_{41} + I_{44} + I_{47} + I_{48} + I_{49} + I_{53} + (I_{55} + \dots + I_{58}) + I_{61} + I_{63} + I_{67} + I_{68} + I_{73}$$

For BIT I<sub>74</sub>:

$$\text{Even} = (I_{17} + \dots + I_{22}) + I_{24} + I_{26} + I_{28} + I_{29} + I_{32} + I_{33} + I_{35} + I_{36} + I_{37} + I_{39} + I_{40} + I_{42} + I_{45} + I_{48} + I_{49} + I_{50} + I_{54} + (I_{56} + \dots + I_{59}) + I_{62} + I_{64} + I_{68} + I_{69} + I_{74}$$

For BIT I<sub>75</sub>:

$$\text{Even} = (I_{13} + \dots + I_{17}) + I_{19} + I_{21} + I_{23} + I_{24} + I_{27} + I_{28} + I_{30} + I_{31} + I_{32} + I_{34} + I_{35} + I_{37} + I_{40} + I_{43} + I_{44} + I_{45} + I_{49} + (I_{51} + \dots + I_{54}) + I_{57} + I_{59} + I_{63} + I_{64} + I_{69} + I_{75}$$

For BIT I<sub>76</sub>:

$$\text{Even} = I_{13} + I_{14} + \dots + I_{75} + I_{76}$$

NOTE 2: Code for I<sub>56</sub> is: 0 = conical; 1 = planar.

NOTE 3: The convention for the coding of negative numbers is as follows: - MSB is the sign bit; 0 = + ; 1 = - .

—Other bits represent the absolute value.

The convention for the antenna location is as follows: As viewed from the MLS approach reference datum looking toward the datum point, a positive number shall represent a location to the right of the runway centerline (lateral offset) or above the runway (vertical offset), or towards the stop end of the runway (longitudinal distance).

The convention for the antenna alignment is as follows: As viewed from above, a positive number shall represent clockwise rotation from the runway centerline to the respective zero-degree guidance plane.

NOTE 4: Data Word A3 is transmitted at intervals of 1.0 seconds or less throughout the approach Azimuth coverage sector, except when back Azimuth guidance is provided. Where back Azimuth is provided transmit at intervals of 1.33 seconds or less throughout the approach Azimuth sector and 4.0 seconds or less throughout the back Azimuth coverage sector.

NOTE 5: When back Azimuth guidance is provided, transmit at intervals of 1.33 seconds or less throughout the back Azimuth coverage sector and 4.0 seconds or less throughout the approach Azimuth coverage sector.

NOTE 6: The designation ‘‘A1’’ represents the function identification code for ‘‘Auxiliary Data A’’ and address code number 1.

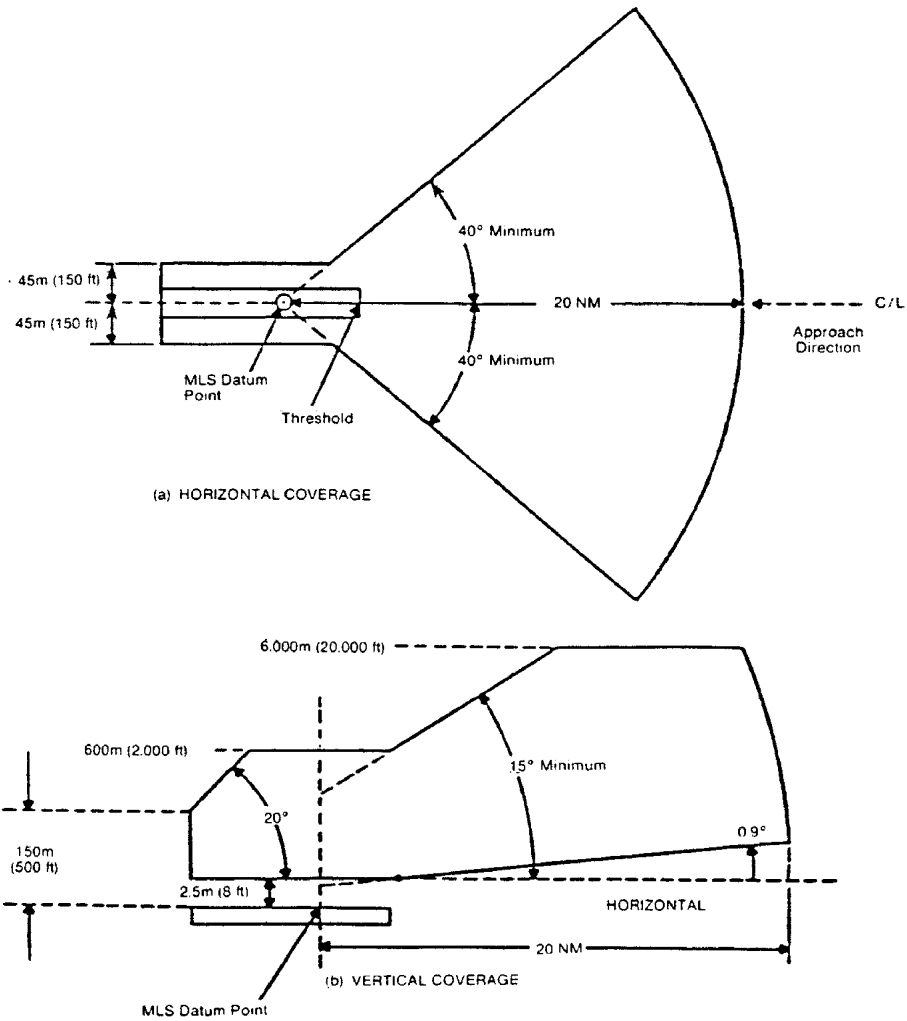

Figure 9. Approach Azimuth/Data Coverage

(1) Horizontally within a sector plus or minus 40 degrees about the runway centerline originating at the datum point and extending in the direction of the approach to 20 nautical miles from the runway threshold. The minimum proportional guidance sector must be plus or minus 10 degrees about the run-

way centerline. Clearance signals must be used to provide the balance of the required coverage, where the proportional sector is less than plus or minus 40 degrees. When intervening obstacles prevent full coverage, the  $\pm 40^\circ$  guidance sector can be reduced as required. For systems providing  $\pm 60^\circ$  lateral guidance

§ 171.313

14 CFR Ch. I (1-1-08 Edition)

the coverage requirement is reduced to 14 nm beyond  $\pm 40^\circ$ .

(2) Vertically between:

(i) A conical surface originating 2.5 meters (8 feet) above the runway centerline at threshold inclined at 0.9 degree above the horizontal.

(ii) A conical surface originating at the azimuth ground equipment antenna inclined at 15 degrees above the horizontal to a height of 6,000 meters (20,000 feet).

(iii) Where intervening obstacles penetrate the lower surface, coverage need be provided only to the minimum line of sight.

(3) Runway region:

(i) Proportional guidance horizontally within a sector 45 meters (150 feet) each side of the runway centerline beginning at the stop end and extending parallel with the runway centerline in the direction of the approach to join

the approach region. This requirement does not apply to offset azimuth installations.

(ii) Vertically between a horizontal surface which is 2.5 meters (8 feet) above the farthest point of runway centerline which is in line of sight of the azimuth antenna, and in a conical surface originating at the azimuth ground equipment antenna inclined at 20 degrees above the horizontal up to a height to 600 meters (2,000 feet). This requirement does not apply to offset azimuth installations.

(4) Within the approach azimuth coverage sector defined in paragraphs (a) (1), and (2) and (3) of this section, the power densities must not be less than those shown in Table 9 but the equipment design must also allow for:

(i) Transmitter power degradation from normal by -1.5 dB;

TABLE 9—MINIMUM POWER DENSITY WITHIN COVERAGE BOUNDARIES(DBW/M<sup>2</sup>)

Function	Data signals	Angle signals for various antenna beamwidths				Clearance signals
		1°	1.5°	2°	3°	
Approach azimuth .....	-89.5	-88	.....	-85.5	-82	-88
High rate approach azimuth .....	-89.5	-88	.....	-88	-86.5	-88
Back azimuth .....	-89.5	-88	.....	-85.5	-82	-88
Approach elevation .....	-89.5	-88	-88	-88	.....	.....

(ii) Rain loss of -2.2 dB at the longitudinal coverage extremes.

(b) *Siting requirements.* The approach azimuth antenna system must, except as allowed in paragraph (c) of this section:

(1) Be located on the extension of the centerline of the runway beyond the stop end;

(2) Be adjusted so that the zero degree azimuth plane will be a vertical plane which contains the centerline of the runway served;

(3) Have the minimum height necessary to comply with the coverage requirements prescribed in paragraph (a) of this section;

(4) Be located at a distance from the stop end of the runway that is consistent with safe obstruction clearance practices;

(5) Not obscure any light of an approach lighting system; and

(6) Be installed on frangible mounts or beyond the 300 meter (1,000 feet) light bar.

(c) On runways where limited terrain prevents the azimuth antenna from being positioned on the runway centerline extended, and the cost of the land fill or a tall tower antenna support is prohibitive, the azimuth antenna may be offset.

(d) *Antenna coordinates.* The scanning beams transmitted by the approach azimuth equipment within  $\pm 40^\circ$  of the centerline may be either conical or planar.

(e) *Approach azimuth accuracy.* (1) The system and subsystem errors shall not exceed those listed in Table 10 at the approach reference datum.

At the approach reference datum, temporal sinusoidal noise components shall not exceed 0.025 degree peak in the frequency band 0.01 Hz to 1.6 Hz, and the CMN shall not exceed 0.10 degree. From the approach reference

datum to the coverage limit, the PFE, PFN and CMN limits, expressed in angular terms, shall be allowed to linearly increase as follows:

(i) With distance along the runway centerline extended, by a factor of 1.2 for the PFE and PFN limits and to  $\pm 0.10$  degree for the CMN limits.

(ii) With azimuth angle, by a factor of 1.5 at the  $\pm 40$  degree and a factor of 2.0 at the  $\pm 60$  degree azimuth angles for the PFE, PFN and CMN limits.

(iii) With elevation angle from +9 degrees to +15 degrees, by a factor of 1.5 for the PFE and PFN limits.

(iv) Maximum angular limits. The PFE limits shall not exceed  $\pm 0.25$  degree in any coverage region below an elevation angle of +9 degrees nor exceed  $\pm 0.50$  degree in any coverage region above that elevation angle. The CMN limits shall not exceed  $\pm 0.10$  degree in any coverage region within  $\pm 10$  degrees of runway centerline extended nor exceed  $\pm 0.20$  degree in any other region within coverage.

NOTE: It is desirable that the CMN not exceed  $\pm 0.10$  degree throughout the coverage.

(f) Approach azimuth antenna characteristics are as follows:

(1) *Drift.* Any azimuth angle as encoded by the scanning beam at any point within the proportional coverage must not vary more than  $\pm 0.07$  degree over the range of service conditions specified in § 171.309(d) without the use of internal environmental controls. Multipath effects are excluded from this requirement.

(2) *Beam pointing errors.* The azimuth angle as encoded by the scanning beam at any point within  $\pm 0.5$  degree of the zero degree azimuth must not deviate from the true azimuth angle at that point by more than  $\pm 0.05$  degree. Multipath and drift effects are excluded from this requirement.

<sup>2</sup>The system PFN component must not exceed  $\pm 3.5$  meters (11.5 feet).

<sup>3</sup>The mean (bias) error component contributed by the ground equipment should not exceed  $\pm 10$  feet.

<sup>4</sup>The system control motion noise must not exceed 0.1 degree.

<sup>5</sup>The airborne subsystem angular errors are provided for information only.

(3) *Antenna alignment.* The antenna must be equipped with suitable optical, electrical or mechanical means or any combination of the three, to bring the zero degree azimuth radial into coincidence with the approach reference datum (for centerline siting) with a maximum error of 0.02 degree. Additionally, the azimuth antenna bias adjustment must be electronically steerable at least to the monitor limits in steps not greater than 0.005 degree.

(4) *Antenna far field patterns in the plane of scan.* On boresight, the azimuth antenna mainlobe pattern must conform to Figure 10, and the beamwidth must be such that, in the installed environment, no significant lateral reflections of the mainlobe exist along the approach course. In any case the beamwidth must not exceed three degrees. Anywhere within coverage the  $-3$  dB width of the antenna mainlobe, while scanning normally, must not be less than 25 microseconds (0.5 degree) or greater than 250 microseconds (5 degrees). The antenna mainlobe may be allowed to broaden from the value at boresight by a factor of  $1/\cos\theta$ , where  $\theta$  is the angle off boresight. The sidelobe levels must be as follows:

(i) *Dynamic sidelobe levels.* With the antenna scanning normally, the dynamic sidelobe level that is detected by a receiver at any point within the proportional coverage sector must be down at least 10 dB from the peak of the main beam. Outside the coverage sector, the radiation from the scanning beam antenna must be of such a nature that receiver warning will not be removed or suitable OCI signals must be provided.

(ii) *Effective sidelobe levels.* With the antenna scanning normally, the sidelobe levels in the plane of scan must be such that, in the installed environment, the CMN contributed by sidelobe reflections will not exceed the angular equivalent of 9 feet at approach reference datum over the required range of aircraft approach speeds.

TABLE 10—APPROACH AZIMUTH ACCURACIES AT THE APPROACH REFERENCE DATUM

Error type	System	Angular error (degrees)	
		Ground subsystem	Airborne subsystem
PFE .....	$\pm 20$ ft. (6.1m) <sup>1,2</sup>	$\pm 0.118^\circ$ <sup>3</sup> ..	$\pm 0.017^\circ$
CMN .....	$\pm 10.5$ ft. (3.2m) <sup>1,2,4</sup>	$\pm 0.030^\circ$ .....	$\pm 0.050^\circ$

Notes:  
<sup>1</sup>Includes errors due to ground and airborne equipment and propagation effects.

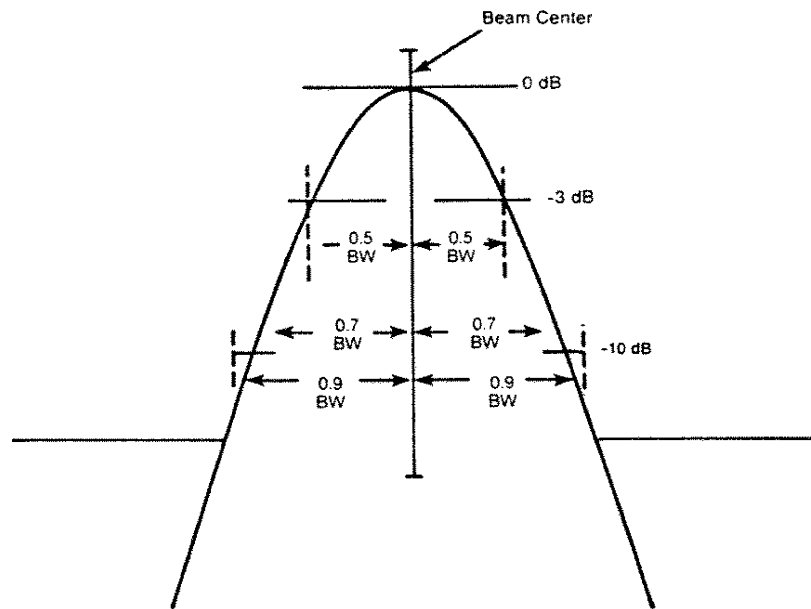

NOTES: 1. The beam envelope is smoothed by a 26 kHz video filter before measurement.  
 2. BW = Beamwidth.

Figure 10. Far Field Dynamic Signal in Space

(5) *Antenna far field pattern in the vertical plane.* The azimuth antenna free space radiation pattern below the horizon must have a slope of at least -8 dB/degree at the horizon and all sidelobes below the horizon must be at least 13 dB below the pattern peak. The antenna radiation pattern above the horizon must satisfy both the system

coverage requirements and the spurious radiation requirement.

(6) *Data antenna.* The data antenna must have horizontal and vertical patterns as required for its function.

(g) *Back azimuth coverage requirements.* The back azimuth equipment where used must provide guidance information in at least the following volume of space (see Figure 11):

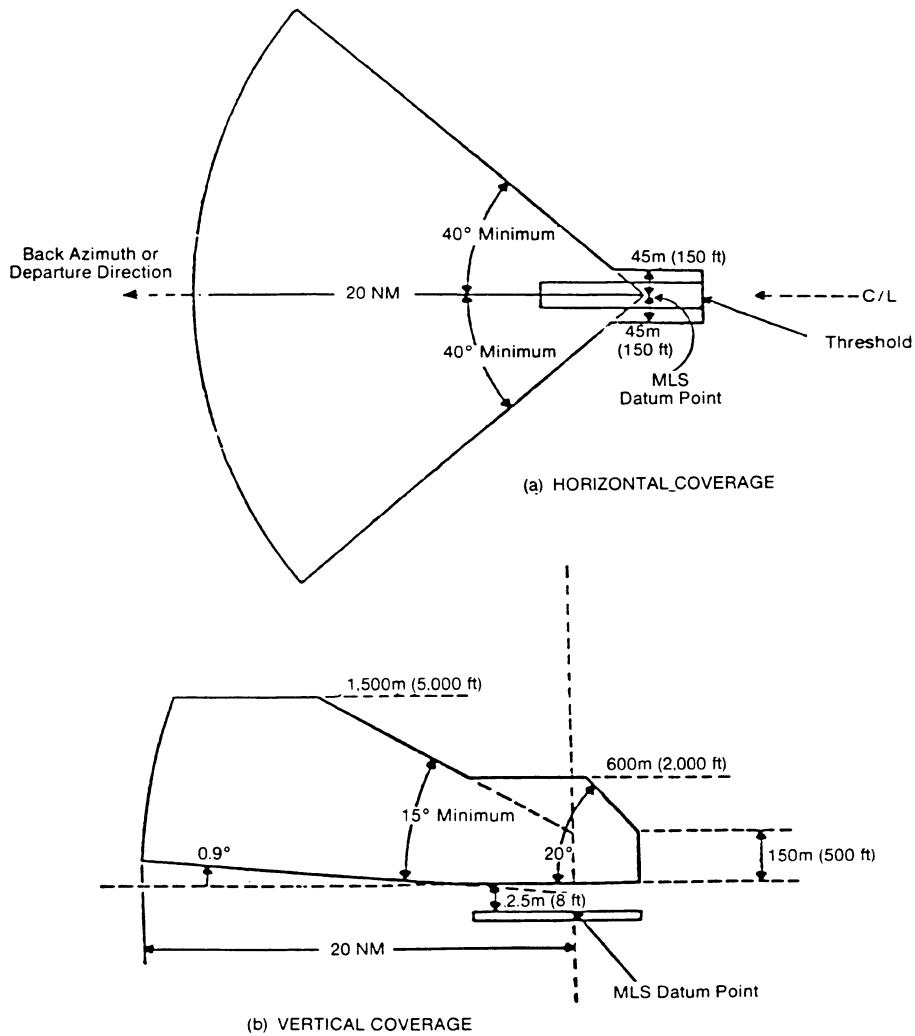

Figure 11. Back Azimuth/Data Coverage

(1) Horizontally within a sector  $\pm 40$  degrees about the runway centerline originating at the back azimuth ground equipment antenna and extending in the direction of the missed ap-

proach at least to 20 nautical miles from the runway stop end. The minimum proportional guidance sector must be  $\pm 10$  degrees about the runway centerline. Clearance signals must be

§ 171.313

14 CFR Ch. I (1-1-08 Edition)

used to provide the balance of the required coverage where the proportional sector is less than  $\pm 40$  degrees.

(2) Vertically in the runway region between:

(i) A horizontal surface 2.5 meters (8 feet) above the farthest point of runway centerline which is in line of sight of the azimuth antenna, and,

(ii) A conical surface originating at the azimuth ground equipment antenna inclined at 20 degrees above the horizontal up to a height of 600 meters (2000 feet).

(3) Vertically in the back azimuth region between:

(i) A conical surface originating 2.5 meters (8 feet) above the runway stop end, inclined at 0.9 degree above the horizontal, and,

(ii) A conical surface originating at the missed approach azimuth ground equipment antenna, inclined at 15 degrees above the horizontal up to a height of 1500 meters (5000 feet).

(iii) Where obstacles penetrate the lower coverage limits, coverage need be provided only to minimum line of sight.

(4) Within the back azimuth coverage sector defined in paragraph (q) (1), (2), and (3) of this section the power densities must not be less than those shown in Table 9, but the equipment design must also allow for:

(i) Transmitter power degradation from normal  $-1.5$  dB.

(ii) Rain loss of  $-2.2$  dB at the longitudinal coverage extremes.

(h) *Back azimuth siting.* The back azimuth equipment antenna must:

(1) Normally be located on the extension of the runway centerline at the threshold end;

(2) Be adjusted so that the vertical plane containing the zero degree course line contains the back azimuth reference datum;

(3) Have minimum height necessary to comply with the course requirements prescribed in paragraph (g) of this section;

(4) Be located at a distance from the threshold end that is consistent with safe obstruction clearance practices;

(5) Not obscure any light of an approach lighting system; and

(6) Be installed on frangible mounts or beyond the 300 meter (1000 feet) light bar.

(i) *Back azimuth antenna coordinates.* The scanning beams transmitted by the back azimuth equipment may be either conical or planar.

(j) *Back azimuth accuracy.* The requirements specified in §171.313(e) apply except that the reference point is the back azimuth reference datum.

(k) *Back azimuth antenna characteristics.* The requirements specified in §171.313(f) apply.

(1) *Scanning conventions.* Figure 12 shows the approach azimuth and back azimuth scanning conventions.

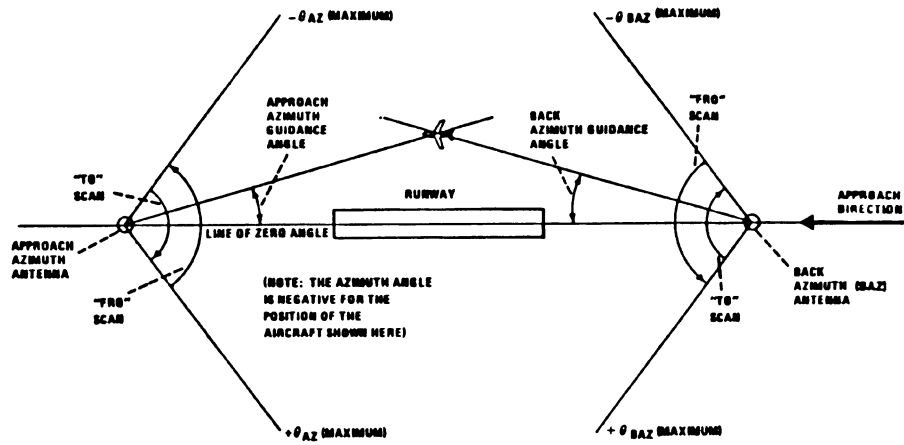

Figure 12. Azimuth Guidance Functions Scanning Conventions

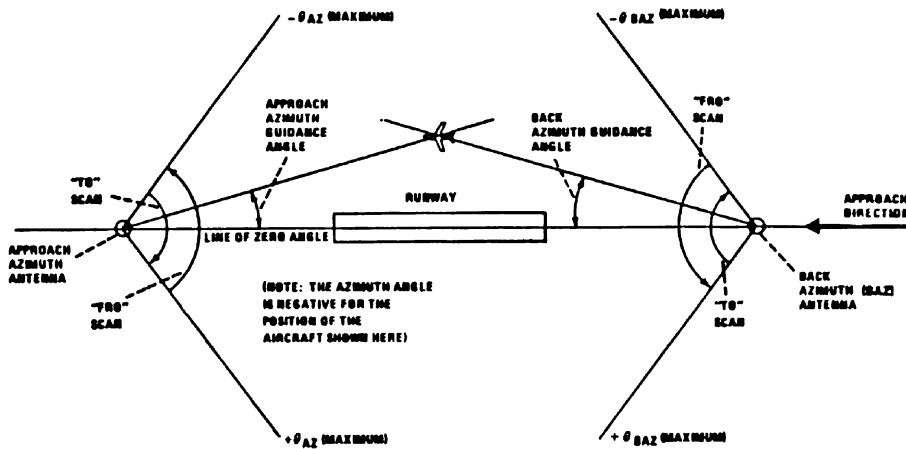

Figure 12. Azimuth Guidance Functions Scanning Conventions

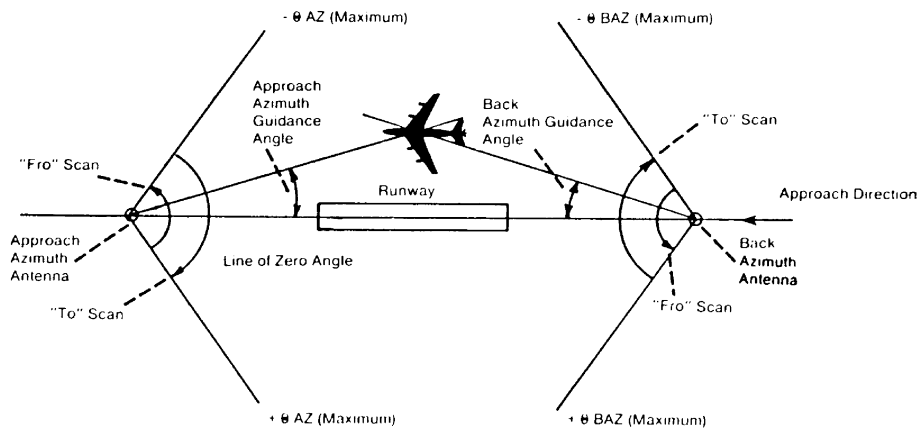

Figure 12. Azimuth Guidance Functions Scanning Conventions

(m) *False guidance.* False courses which can be acquired and tracked by an aircraft shall not exist anywhere either inside or outside of the MLS coverage sector. False courses which exist outside of the minimum coverage sector may be suppressed by the use of OCI.

NOTE: False courses may be due to (but not limited to) MLS airborne receiver acquisition of the following types of false guidance: reflections of the scanning beam, scanning beam antenna sidelobes and grating lobes, and incorrect clearance.

**§171.315 Azimuth monitor system requirements.**

(a) The approach azimuth or back azimuth monitor system must cause the radiation to cease and a warning must be provided at the designated control point if any of the following conditions persist for longer than the periods specified:

(1) There is a change in the ground equipment contribution to the mean course error component such that the path following error at the reference datum or in the direction of any azimuth radial, exceeds the limits specified in §§171.313(e)(1) or 171.313(j) for a period of more than one second.

NOTE: The above requirement and the requirement to limit the ground equipment mean error to ±10 ft. can be satisfied by the following procedure. The integral monitor alarm limit should be set to the angular

equivalent of ±10 ft. at the approach reference datum. This will limit the electrical component of the mean course error to ±10 ft. The field monitor alarm limit should be set such that with the mean course error at the alarm limit the total allowed PFE is not exceeded on any commissioned approach course from the limit of coverage to an altitude of 100 feet.

(2) There are errors in two consecutive transmissions of Basic Data Words 1, 2, 4 or 5.

(3) There is a reduction in the radiated power to a level not less than that specified in §§171.313(a)(4) or 171.313(g)(4) for a period of more than one second.

(4) There is an error in the preamble DPSK transmissions which occurs more than once in any one second period.

(5) There is an error in the time division multiplex synchronization of a particular azimuth function that the requirement specified in §171.311(e) is not satisfied and if this condition persists for more than one second.

(6) A failure of the monitor is detected.

(b) Radiation of the following functions must cease and a warning provided at the designated control point if there are errors in 2 consecutive transmissions:

- (1) Morse Code Identification,
- (2) Basic Data Words 3 and 6,
- (3) Auxiliary Data Words.

(c) The period during which erroneous guidance information is radiated must not exceed the periods specified in §171.315(a). If the fault is not cleared within the time allowed, the ground equipment must be shut down. After shutdown, no attempt must be made to restore service until a period of 20 seconds has elapsed.

**§ 171.317 Approach elevation performance requirements.**

This section prescribes the performance requirements for the elevation equipment components of the MLS as follows:

(a) *Elevation coverage requirements.* The approach elevation facility must provide proportional guidance information in at least the following volume of space (see Figure 13):

(1) Laterally within a sector originating at the datum point which is at least equal to the proportional guidance sector provided by the approach azimuth ground equipment.

(2) Longitudinally from 75 meters (250 feet) from the datum point to 20 nautical miles from threshold in the direction of the approach.

(3) Vertically within the sector bounded by:

(i) A surface which is the locus of points 2.5 meters (8 feet) above the runway surface;

(ii) A conical surface originating at the datum point and inclined 0.9 degree above the horizontal and,

(iii) A conical surface originating at the datum point and inclined at 15.0 degrees above the horizontal up to a height of 6000 meters (20,000 feet).

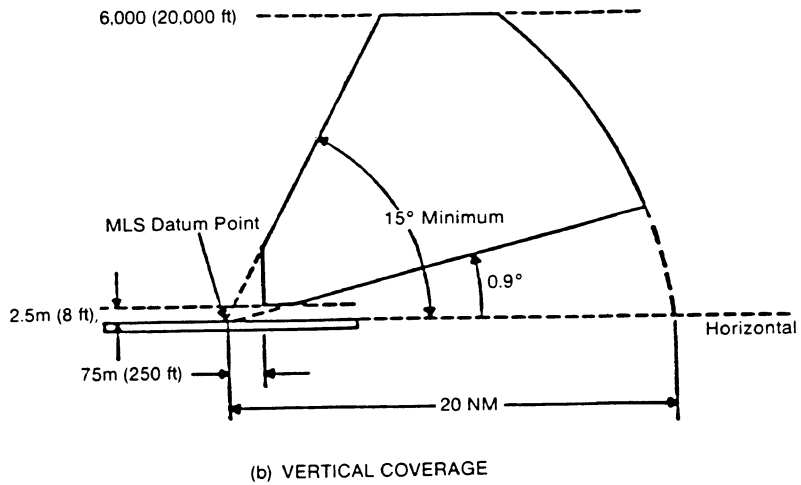
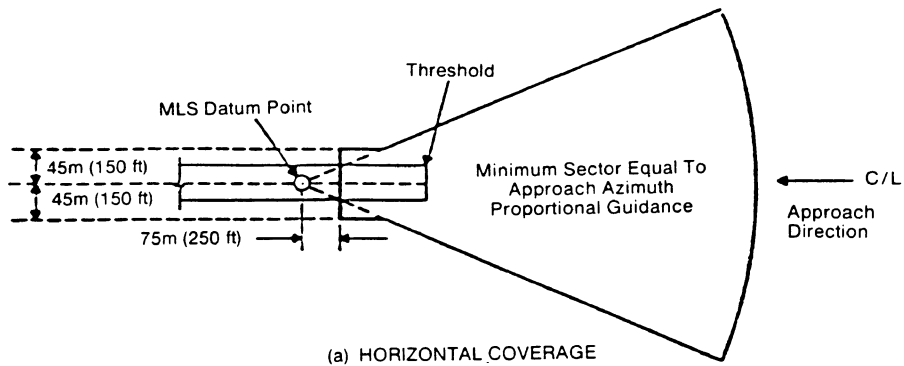

Figure 13. Approach Elevation Coverage

Where the physical characteristics of the approach region prevent the achievement of the standards under paragraphs (a) (1), (2), and (3) of this

section, guidance need not be provided below a conical surface originating at the elevation antenna and inclined 0.9 degree above the line of sight.

(4) Within the elevation coverage sector defined in paragraphs (a) (1), (2) and (3) of this section, the power densities must not be less than those shown in Table 9, but the equipment design must also allow for:

(i) Transmitter power degradation from normal by -1.5 dB.

(ii) Rain loss of -2.2 dB at the coverage extremes.

(b) *Elevation siting requirements.* The Elevation Antenna System must:

(1) Be located as close to runway centerline as possible (without violating obstacle clearance criteria).

(2) Be located near runway threshold such that the asymptote of the minimum glidepath crosses the threshold of the runway at the Approach Reference Datum height. Normally, the minimum glidepath should be 3 degrees and the Approach Reference Datum height should be 50 feet. However, there are circumstances where other glideslopes and reference datum heights are appropriate. Some of these instances are discussed in FAA Order 8260.34 (Glide Slope Threshold Crossing Height Requirements) and Order 8260.3 (IFR Approval of MLS.)

(3) Be located such that the MLS Approach Reference Datum and ILS Reference Datum heights are coincident within a tolerance of 3 feet when MLS is installed on a runway already served by an ILS. This requirement applies only if the ILS glide slope is sited such that the height of the reference datum meets the requirements of FAA Order 8260.34.

(c) *Antenna coordinates.* The scanning beams transmitted by the elevation subsystem must be conical.

(d) *Elevation accuracy.* (1) The accuracies shown in Table 13 are required at the approach reference datum. From the approach reference datum to the coverage limit, the PFE, PFN and CMN limits shall be allowed to linearly increase as follows:

(i) With distance along the runway centerline extended at the minimum glide path angle, by a factor of 1.2 for the PFE and PFN limits and to ±0.10 degree for the CMN limits;

(ii) With azimuth angle, from runway centerline extended to the coverage extreme, by a factor of 1.2 for the PFE

and PFN limits and by a factor of 2.0 for the CMN limits;

(iii) With increasing elevation angles from +3 degrees to +15 degrees, by a factor of 2.0 for the PFE and PFN limits;

TABLE 13—ELEVATION ACCURACIES AT THE APPROACH REFERENCE DATUM

Error type	System	Angular error (degrees)	
		Ground subsystem	Airborne subsystem <sup>4</sup>
PFE .....	1.2 ±0.133	( <sup>3</sup> )	±0.017
CMN .....	1±0.050	±0.020	±0.010

Notes:

<sup>1</sup> Includes errors due to ground and airborne equipment and propagation effects.

<sup>2</sup> The system PFN component must not exceed ±0.087 degree.

<sup>3</sup> The mean (bias) error component contributed by the ground equipment should not exceed ±0.067 degree.

<sup>4</sup> The airborne subsystem angular errors are provided for information only.

(iv) With decreasing elevation angle from +3 degrees (or 60% of the minimum glide path angle, whichever is less) to the coverage extreme, by a factor of 3 for the PFE, PFN and CMN limits; and

(v) Maximum angular limits. the CMN limits shall not exceed ±0.10 degree in any coverage region within ±10 degrees laterally of runway centerline extended which is above the elevation angle specified in (iv) above.

NOTE: It is desirable that the CMN not exceed ±0.10 degree throughout the coverage region above the elevation angle specified in paragraph (d)(1)(iv) of this section.

(2) The system and ground subsystem accuracies shown in Table 13 are to be demonstrated at commissioning as maximum error limits. Subsequent to commissioning, the accuracies are to be considered at 95% probability limits.

(e) Elevation antenna characteristics are as follows:

(1) *Drift.* Any elevation angle as encoded by the scanning beam at any point within the coverage sector must not vary more than 0.04 degree over the range of service conditions specified in §171.309(d) without the use of internal environmental controls. Multipath effects are excluded from this requirement.

(2) *Beam pointing errors.* The elevation angle as encoded by the scanning beam at any point within the coverage sector

must not deviate from the true elevation angle at that point by more than  $\pm 0.04$  degree for elevation angles from  $2.5^\circ$  to  $3.5^\circ$ . Above  $3.5^\circ$  these errors may linearly increase to  $\pm 0.1$  degree at  $7.5^\circ$ . Multipath and drift effects are excluded from this requirement.

(3) *Antenna alignment.* The antenna must be equipped with suitable optical, electrical, or mechanical means or any combination of the three, to align the lowest operationally required glidepath to the true glidepath angle with a maximum error of 0.01 degree. Additionally, the elevation antenna bias adjustment must be electronically steerable at least to the monitor limits in steps not greater than 0.005 degrees.

(4) *Antenna far field patterns in the plane of scan.* On the lowest operationally required glidepath, the antenna mainlobe pattern must conform to Figure 10, and the beamwidth must be such that in the installed environment, no significant ground reflections of the mainlobe exist. In any case, the beamwidth must not exceed 2 degrees. The antenna mainlobe may be allowed to broaden from the value at boresight by a factor of  $1/\cos\theta$ , where  $\theta$  is the angle of boresight. Anywhere within coverage, the  $-3$  dB width of the antenna mainlobe, while scanning normally, must not be less than 25 microseconds ( $0.5$  degrees) or greater than 250 microseconds ( $5$  degrees). The sidelobe levels must be as follows:

(i) *Dynamic sidelobe levels.* With the antenna scanning normally, the dynamic sidelobe level that is detected by a receiver at any point within the proportional coverage sector must be down at least 10 dB from the peak of the mainlobe. Outside the proportional coverage sector, the radiation from the scanning beam antenna must be of such a nature that receiver warnings will not be removed or a suitable OCI signal must be provided.

(ii) *Effective sidelobe levels.* With the antenna scanning normally, the sidelobe levels in the plane of scan must be such that, when reflected from the ground, the resultant PFE along any glidepath does not exceed 0.083 degrees.

(5) *Antenna far field pattern in the horizontal plane.* The horizontal pattern of the antenna must gradually de-empha-

size the signal away from antenna boresight. Typically, the horizontal pattern should be reduced by at least 3 dB at 20 degrees off boresight and by at least 6 dB at 40 degrees off boresight. Depending on the actual multipath conditions, the horizontal radiation patterns may require more or less de-emphasis.

(6) *Data antenna.* The data antenna must have horizontal and vertical patterns as required for its function.

(f) *False guidance.* False courses which can be acquired and tracked by an aircraft shall not exist anywhere either inside or outside of the MLS coverage sector. False courses which exist outside of the minimum coverage sector may be suppressed by the use of OCI.

NOTE: False courses may be due to (but not limited to) MLS airborne receiver acquisition of the following types of false guidance: reflections of the scanning beam and scanning beam antenna sidelobes and grating lobes.

#### § 171.319 Approach elevation monitor system requirements.

(a) The monitor system must act to ensure that any of the following conditions do not persist for longer than the periods specified when:

(1) There is a change in the ground component contribution to the mean glidepath error component such that the path following error on any glidepath exceeds the limits specified in § 171.317(d) for a period of more than one second.

NOTE: The above requirement and the requirement to limit the ground equipment mean error to  $\pm 0.067$  degree can be satisfied by the following procedure. The integral monitor alarm limit should be set to  $\pm 0.067$  degree. This will limit the electrical component of mean glidepath error to  $\pm 0.067$  degree. The field monitor alarm limit should be set such that with the mean glidepath error at the alarm limit the total allowed PFE is not exceeded on any commissioned glidepath from the limit of coverage to an altitude of 100 feet.

(2) There is a reduction in the radiated power to a level not less than that specified in § 171.317(a)(4) for a period of more than one second.

(3) There is an error in the preamble DPSK transmission which occurs more than once in any one second period.

(4) There is an error in the time division multiplex synchronization of a particular elevation function such that the requirement specified in §171.311(e) is not satisfied and this condition persists for more than one second.

(5) A failure of the monitor is detected.

(b) The period during which erroneous guidance information is radiated must not exceed the periods specified in §171.319(a). If the fault is not cleared within the time allowed, radiation shall cease. After shutdown, no attempt must be made to restore service until a period of 20 seconds has elapsed.

**§ 171.321 DME and marker beacon performance requirements.**

(a) The DME equipment must meet the performance requirements prescribed in subpart G of the part. This subpart imposes requirements that performance features must comply with International Standards and Recommended Practices, Aeronautical Telecommunications, Vol. I of Annex 10 to ICAO. It is available from ICAO, Aviation Building, 1080 University Street, Montreal 101, Quebec, Canada. Attention: Distribution Officer and also available for inspection at the National Archives and Records Administration (NARA). For information on the availability of this material at NARA, call 202-741-6030, or go to: [http://www.archives.gov/federal\\_register/code\\_of\\_federal\\_regulations/ibr\\_locations.html](http://www.archives.gov/federal_register/code_of_federal_regulations/ibr_locations.html).

(b) MLS marker beacon equipment must meet the performance requirements prescribed in subpart H of this part. This subpart imposes requirements that performance features must comply with International Standards and Recommended Practices, Aeronautical Telecommunications, Vol. I of Annex 10 to ICAO.

[Doc. No. 5034, 29 FR 11337, Aug. 6, 1964, as amended at 69 FR 18803, Apr. 9, 2004]

**§ 171.323 Fabrication and installation requirements.**

(a) The MLS facility must be permanent and must be located, constructed, and installed in accordance with best commercial engineering practices, using applicable electric and safety codes and Federal Communications

Commission (FCC) licensing requirements and siting requirements of §§171.313(b) and 171.317(b).

(b) The MLS facility components must utilize solid state technology except that traveling wave tube amplifiers (TWTA) may be used. A maximum level of common modularity must be provided along with diagnostics to facilitate maintenance and troubleshooting.

(c) An approved monitoring capability must be provided which indicates the status of the equipment at the site and at a remotely located maintenance area, with monitor capability that provides pre-alarm of impending system failures. This monitoring feature must be capable of transmitting the status and pre-alarm over standard phone lines to a remote section. In the event the sponsor requests the FAA to assume ownership of the facility, the monitoring feature must also be capable of interfacing with FAA remote monitoring requirements. This requirement may be complied with by the addition of optional software and/or hardware in space provided in the original equipment.

(d) The mean corrective maintenance time of the MLS equipment must be equal to or less than 0.5 hours with a maximum corrective maintenance time not to exceed 1.5 hours. This measure applies to correction of unscheduled failures of the monitor, transmitter and associated antenna assemblies, limited to unscheduled outage and out of tolerance conditions.

(e) The mean-time-between-failures of the MLS angle system must not be less than 1,500 hours. This measure applies to unscheduled outage, out-of-tolerance conditions, and failures of the monitor, transmitter, and associated antenna assemblies.

(f) The MLS facility must have a reliable source of suitable primary power, either from a power distribution system or locally generated. Adequate power capacity must be provided for the operation of the MLS as well as the test and working equipment of the MLS.

(g) The MLS facility must have a continuously engaged or floating battery power source for the continued normal operation of the ground station

**§ 171.325**

**14 CFR Ch. I (1-1-08 Edition)**

operation if the primary power fails. A trickle charge must be supplied to recharge the batteries during the period of available primary power. Upon loss and subsequent restoration of power, the battery must be restored to full charge within 24 hours. When primary power is applied, the state of the battery charge must not affect the operation of the MLS ground station. The battery must allow continuation of normal operation of the MLS facility for at least 2 hours without the use of additional sources of power. When the system is operating from the battery supply without prime power, the radome deicers and the environmental system need not operate. The equipment must meet all specification requirements with or without batteries installed.

(h) There must be a means for determining, from the ground, the performance of the system including antenna, both initially and periodically.

(i) The facility must have, or be supplemented by, ground, air, or landline communications services. At facilities within or immediately adjacent to controlled airspace, that are intended for use as instrument approach aids for an airport, there must be ground air communications or reliable communications (at least a landline telephone) from the airport to the nearest FAA air traffic control or communication facility. Compliance with this paragraph need not be shown at airports where an adjacent FAA facility can communicate with aircraft on the ground at the airport and during the entire proposed instrument approach procedure. In addition, at low traffic density airports within or immediately adjacent to controlled airspace, and where extensive delays are not a factor, the requirements of this paragraph may be reduced to reliable communications from the airport to the nearest FAA air traffic control or communications facility. If the adjacent FAA facility can communicate with aircraft during the proposed instrument approach procedure down to the airport surface or at least down to the minimum en route altitude, this would require at least a landline telephone.

(j) The location of the phase center for all antennas must be clearly marked on the antenna enclosures.

(k) The latitude, longitude and mean sea level elevation of all MLS antennas, runway threshold and runway stop end must be determined by survey with an accuracy of  $\pm 3$  meters ( $\pm 10$  feet) laterally and  $\pm 0.3$  meter ( $\pm 1.0$  foot) vertically. The relative lateral and vertical offsets of all antenna phase centers, and both runway ends must be determined with an accuracy of  $\pm 0.3$  meter ( $\pm 1.0$  foot) laterally and  $\pm 0.03$  meter ( $\pm 0.1$  foot) vertically. The owner must bear all costs of the survey. The results of this survey must be included in the "operations and maintenance" manual required by section 171.325 of this subpart and will be noted on FAA Form 198 required by § 171.327.

[Doc. No. 20669, 51 FR 33177, Sept. 18, 1986, as amended by Amdt. 171-16, 56 FR 65665, Dec. 17, 1991]

**§ 171.325 Maintenance and operations requirements.**

(a) The owner of the facility must establish an adequate maintenance system and provide MLS qualified maintenance personnel to maintain the facility at the level attained at the time it was commissioned. Each person who maintains a facility must meet the FCC licensing requirements and demonstrate that he has the special knowledge and skills needed to maintain an MLS facility, including proficiency in maintenance procedures and the use of specialized test equipment.

(b) In the event of out-of-tolerance conditions or malfunctions, as evidenced by receiving two successive pilot reports, the owner must close the facility by encasing radiation, and issue a "Notice to Airmen" (NOTAM) that the facility is out of service.

(c) The owner must prepare, and obtain approval of, an operations and maintenance manual that sets forth mandatory procedures for operations, periodic maintenance, and emergency maintenance, including instructions on each of the following:

- (1) Physical security of the facility.
- (2) Maintenance and operations by authorized persons.
- (3) FCC licensing requirements for operations and maintenance personnel.

- (4) Posting of licenses and signs.
- (5) Relations between the facility and FAA air traffic control facilities, with a description of the boundaries of controlled airspace over or near the facility, instructions for relaying air traffic control instructions and information, if applicable, and instructions for the operation of an air traffic advisory service if the facility is located outside of controlled airspace.
- (6) Notice to the Administrator of any suspension of service.
- (7) Detailed and specific maintenance procedures and servicing guides stating the frequency of servicing.
- (8) Air-ground communications, if provided, expressly written or incorporating appropriate sections of FAA manuals by reference.
- (9) Keeping the station logs and other technical reports, and the submission of reports required by § 171.327.
- (10) Monitoring of the MLS facility.
- (11) Inspections by United States personnel.
- (12) Names, addresses, and telephone numbers of persons to be notified in an emergency.
- (13) Shutdowns for periodic maintenance and issuing of NOTAM for routine or emergency shutdowns.
- (14) Commissioning of the MLS facility.
- (15) An acceptable procedure for amending or revising the manual.
- (16) An explanation of the kinds of activities (such as construction or grading) in the vicinity of the MLS facility that may require shutdown or recertification of the MLS facility by FAA flight check.
- (17) Procedures for conducting a ground check of the azimuth and elevation alignment.
- (18) The following information concerning the MLS facility:
  - (i) Facility component locations with respect to airport layout, instrument runways, and similar areas.
  - (ii) The type, make and model of the basic radio equipment that provides the service including required test equipment.
  - (iii) The station power emission, channel, and frequency of the azimuth, elevation, DME, marker beacon, and associated compass locators, if any.
  - (iv) The hours of operation.
  - (v) Station identification call letters and method of station identification and the time spacing of the identification.
  - (vi) A description of the critical parts that may not be changed, adjusted, or repaired without an FAA flight check to confirm published operations.
- (d) The owner or his maintenance representative must make a ground check of the MLS facility periodically in accordance with procedures approved by the FAA at the time of commissioning, and must report the results of the checks as provided in § 171.327.
- (e) The only modifications permitted are those that are submitted to FAA for approval by the MLS equipment manufacturer. The owner or sponsor of the facility must incorporate these modifications in the MLS equipment. Associated changes must also be made to the operations and maintenance manual required in paragraph (c) of this section. This and all other corrections and additions to this operations and maintenance manual must also be submitted to FAA for approval.
- (f) The owner or the owner's maintenance representative must participate in inspections made by the FAA.
- (g) The owner must ensure the availability of a sufficient stock of spare parts, including solid state components, or modules to make possible the prompt replacement of components or modules that fail or deteriorate in service.
- (h) FAA approved test instruments must be used for maintenance of the MLS facility.
- (i) Inspection consists of an examination of the MLS equipment to ensure that unsafe operating conditions do not exist.
- (j) Monitoring of the MLS radiated signal must ensure a high degree of integrity and minimize the requirements for ground and flight inspection. The monitor must be checked daily during the in-service test evaluation period (96 hour burn in) for calibration and stability. These tests and ground checks or azimuth, elevation, DME, and marker beacon radiation characteristics must be conducted in accordance with the maintenance requirements of this section.

**§ 171.327 Operational records.**

The owner of the MLS facility or his maintenance representative must submit the following operational records at the indicated time to the appropriate FAA regional office where the facility is located.

(a) *Facility Equipment Performance & Adjustment Data (FAA Form 198)*. The FAA Form 198 shall be filled out by the owner or his maintenance representative with the equipment adjustments and meter readings as of the time of facility commissioning. One copy must be kept in the permanent records of the facility and two copies must be sent to the appropriate FAA regional office. The owner or his maintenance representative must revise the FAA Form 198 data after any major repair, modernization, or retuning to reflect an accurate record of facility operation and adjustment.

(b) *Facility Maintenance Log (FAA Form 6030-1)*. FAA Form 6030-1 is permanent record of all the activities required to maintain the MLS facility. The entries must include all malfunctions met in maintaining the facility including information on the kind of

work and adjustments made, equipment failures, causes (if determined) and corrective action taken. In addition, the entries must include completion of periodic maintenance required to maintain the facility. The owner or his maintenance representative must keep the original of each form at the facility and send a copy to the appropriate FAA regional office at the end of each month in which it is prepared. However, where an FAA approved remote monitoring system is installed which precludes the need for periodic maintenance visits to the facility, monthly reports from the remote monitoring system control point must be forwarded to the appropriate FAA regional office, and a hard copy retained at the control point.

(c) *Technical Performance Record (FAA Form 6830 (formerly FAA Form 418))*. This form contains a record of system parameters as specified in the manufacturer's equipment manual. This data will be recorded on each scheduled visit to the facility. The owner or his maintenance representative shall keep the original of each record at the facility and send a copy of the form to the appropriate FAA regional office.

## SUBCHAPTER K—ADMINISTRATIVE REGULATIONS

### PART 183—REPRESENTATIVES OF THE ADMINISTRATOR

#### Subpart A—General

Sec.

183.1 Scope.

#### Subpart B—Certification of Representatives

183.11 Selection.

183.13 Certification.

183.15 Duration of certificates.

183.17 Reports.

#### Subpart C—Kinds of Designations: Privileges

183.21 Aviation Medical Examiners.

183.23 Pilot examiners.

183.25 Technical personnel examiners.

183.27 Designated aircraft maintenance inspectors.

183.29 Designated engineering representatives.

183.31 Designated manufacturing inspection representatives.

183.33 Designated Airworthiness Representative.

#### Subpart D—Organization Designation Authorization

183.41 Applicability and definitions.

183.43 Application.

183.45 Issuance of Organization Designation Authorizations.

183.47 Qualifications.

183.49 Authorized functions.

183.51 ODA Unit personnel.

183.53 Procedures manual.

183.55 Limitations.

183.57 Responsibilities of an ODA Holder.

183.59 Inspection.

183.61 Records and reports.

183.63 Continuing requirements: Products, parts or appliances.

183.65 Continuing requirements: Operational approvals.

183.67 Transferability and duration.

AUTHORITY: 31 U.S.C. 9701; 49 U.S.C. 106(g), 40113, 44702, 45303.

SOURCE: Docket No. 1151, 27 FR 4951, May 26, 1962, unless otherwise noted.

EDITORIAL NOTE: For miscellaneous amendments to cross references in this part 183, see Amdt. 183-1, 31 FR 9211, July 6, 1966.

#### Subpart A—General

##### § 183.1 Scope.

This part describes the requirements for designating private persons to act as representatives of the Administrator in examining, inspecting, and testing persons and aircraft for the purpose of issuing airman, operating, and aircraft certificates. In addition, this part states the privileges of those representatives and prescribes rules for the exercising of those privileges, as follows:

(a) An individual may be designated as a representative of the Administrator under subparts B or C of this part.

(b) An organization may be designated as a representative of the Administrator by obtaining an Organization Designation Authorization under subpart D of this part.

[Doc. No. FAA-2003-16685, 70 FR 59946, Oct. 13, 2005]

#### Subpart B—Certification of Representatives

##### § 183.11 Selection.

(a) The Federal Air Surgeon, or his authorized representative within the FAA, may select Aviation Medical Examiners from qualified physicians who apply. In addition, the Federal Air Surgeon may designate qualified forensic pathologists to assist in the medical investigation of aircraft accidents.

(b) Any local Flight Standards Inspector may select a pilot examiner, technical personnel examiner, or a designated aircraft maintenance inspector whenever he determines there is a need for one.

(c)(1) The Manager, Aircraft Certification Office, or the Manager's designee, may select Designated Engineering Representatives from qualified persons who apply by a letter accompanied by a "Statement of Qualifications of Designated Engineering Representative."

(2) The Manager, Aircraft Certification Directorate, or the Manager's designee, may select Designated Manufacturing Inspection Representatives

### § 183.13

from qualified persons who apply by a letter accompanied by a "Statement of Qualifications of Designated Manufacturing Inspection Representative."

(d) The Associate Administrator for Air Traffic, may select Air Traffic Control Tower Operator Examiners.

(e) The Director, Aircraft Certification Service, or the Director's designee, may select Designated Airworthiness Representatives from qualified persons who apply by a letter accompanied by a "Statement of Qualifications of Designated Airworthiness Representative."

(Approved by the Office of Management and Budget under control number 2120-0035)

(Secs. 313(a), 314, 601, 603, 605, and 1102, Federal Aviation Act of 1958, as amended (49 U.S.C. 1354(a), 1355, 1421, 1423, 1425, and 1502); sec. 6(c) Department of Transportation Act (49 U.S.C. 1655(c)))

[Doc. No. 1151, 27 FR 4951, May 26, 1962, as amended by Amdt. 183-7, 45 FR 32669, May 19, 1980; Amdt. 183-8, 48 FR 16179, Apr. 14, 1983; Amdt. 183-9, 54 FR 39296, Sept. 25, 1989]

### § 183.13 Certification.

(a) A "Certificate of Designation" and an appropriate Identification Card is issued to each Aviation Medical Examiner and to each forensic pathologist designated under §183.11(a).

(b) A "Certificate of Authority" specifying the kinds of designation for which the person concerned is qualified and stating an expiration date is issued to each Flight Standards Designated Representative, along with a "Certificate of Designation" for display purposes, designating the holder as a Flight Standards Representative and specifying the kind of designation for which he is qualified.

(c) A "Certificate of Authority," stating the specific functions which the person concerned is authorized to perform and stating an expiration date, is issued to each Designated Airworthiness Representative, along with a

### 14 CFR Ch. I (1-1-08 Edition)

"Certificate of Designation" for display purposes.

(Secs. 601 and 602, 72 Stat. 752, 49 U.S.C. 1421-1422; secs. 313(a), 314, 601, 603, 605, and 1102, Federal Aviation Act of 1958, as amended (49 U.S.C. 1354(a), 1355, 1421, 1423, 1425, and 1502); sec. 6(c) Department of Transportation Act (49 U.S.C. 1655(c)))

[Doc. No. 1151, 27 FR 4951, May 26, 1962, as amended by Amdt. 183-2, 32 FR 46, Jan. 5, 1967; Amdt. 183-8, 48 FR 16179, Apr. 14, 1983]

### § 183.15 Duration of certificates.

(a) Unless sooner terminated under paragraph (c) of this section, a designation as an Aviation Medical Examiner is effective for one year after the date it is issued, and may be renewed for additional periods of one year at the Federal Air Surgeon's discretion. A renewal is effected by a letter and issuance of a new identification card specifying the renewal period.

(b) Unless sooner terminated under paragraph (c) of this section, a designation as Flight Standards or Aircraft Certification Service Designated Representative as described in §§183.23, 183.25, 183.27, 183.29, 183.31, or 183.33 is effective until the expiration date shown on the document granting the authorization.

(c) A designation made under this subpart terminates—

(1) Upon the written request of the representative;

(2) Upon the written request of the employer in any case in which the recommendation of the employer is required for the designation;

(3) Upon the representative being separated from the employment of the employer who recommended him for certification;

(4) Upon a finding by the Administrator that the representative has not properly performed his duties under the designation;

(5) Upon the assistance of the representative being no longer needed by the Administrator; or

## Federal Aviation Administration, DOT

## § 183.25

(6) For any reason the Administration considers appropriate.

(Secs. 313(a), 314, 601, 603, 605, and 1102, Federal Aviation Act of 1958, as amended (49 U.S.C. 1354(a), 1355, 1421, 1423, 1425, and 1502); sec. 6(c) Department of Transportation Act (49 U.S.C. 1655(c)))

[Doc. No. 1151, 27 FR 4951, May 26, 1962, as amended by Amdt. 183-3, 33 FR 1072, Jan. 27, 1968; Amdt. 183-8, 48 FR 16179, Apr. 14, 1983; Amdt. 183-9, 54 FR 39296, Sept. 25, 1989; Amdt. 183-12, 70 FR 59947, Oct. 13, 2005; 71 FR 28774, May 18, 2006]

### § 183.17 Reports.

Each representative designated under this part shall make such reports as are prescribed by the Administrator.

## Subpart C—Kinds of Designations: Privileges

### § 183.21 Aviation Medical Examiners.

An Aviation Medical Examiner may—

(a) Accept applications for physical examinations necessary for issuing medical certificates under part 67 of this chapter;

(b) Under the general supervision of the Federal Air Surgeon or the appropriate senior regional flight surgeon, conduct those physical examinations;

(c) Issue or deny medical certificates in accordance with part 67 of this chapter, subject to reconsideration by the Federal Air Surgeon or his authorized representatives within the FAA;

(d) Issue student pilot certificates as specified in § 61.85 of this chapter; and

(e) As requested, participate in investigating aircraft accidents.

(Secs. 601 and 602, 72 Stat. 752, 49 U.S.C. 1421-1422)

[Doc. No. 1151, 27 FR 4951, May 26, 1962, as amended by Amdt. 183-2, 32 FR 46, Jan. 5, 1967; Amdt. 183-5, 38 FR 12203, May 10, 1973]

### § 183.23 Pilot examiners.

Any pilot examiner, instrument rating examiner, or airline transport pilot examiner may—

(a) As authorized in his designation, accept applications for flight tests necessary for issuing pilot certificates and ratings under this chapter;

(b) Under the general supervision of the appropriate local Flight Standards Inspector, conduct those tests; and

(c) In the discretion of the appropriate local Flight Standards Inspector, issue temporary pilot certificates and ratings to qualified applicants.

### § 183.25 Technical personnel examiners.

(a) A designated mechanic examiner (DME) (airframe and power plant) may—

(1) Accept applications for, and conduct, mechanic, oral and practical tests necessary for issuing mechanic certificates under part 65 of this chapter; and

(2) In the discretion of the appropriate local Flight Standards Inspector, issue temporary mechanic certificates to qualified applicants.

(b) A designated parachute rigger examiner (DPRE) may—

(1) Accept applications for, and conduct, oral and practical tests necessary for issuing parachute rigger certificates under part 65 of this chapter; and

(2) In the discretion of the appropriate local Flight Standards Inspector, issue temporary parachute rigger certificates to qualified applicants.

(c) An air traffic control tower operator examiner may—

(1) Accept applications for, and conduct, written and practical tests necessary for issuing control tower operator certificates under part 65 of this chapter; and

(2) In the discretion of the Associate Administrator for Air Traffic issue temporary control tower operator certificates to qualified applicants.

(d) A designated flight engineer examiner (DFEE) may—

(1) Accept applications for, and conduct, oral and practical tests necessary for issuing flight engineer certificates under part 63 of this chapter; and

(2) In the discretion of the appropriate local Flight Standards Inspector, issue temporary flight engineer certificates to qualified applicants.

(e) A designated flight navigator examiner (DFNE) may—

(1) Accept applications for, and conduct, oral and practical tests necessary for issuing flight navigator certificates under part 63 of this chapter; and

**§ 183.27**

**14 CFR Ch. I (1–1–08 Edition)**

(2) In the discretion of the appropriate local Flight Standards Inspector, issue temporary flight navigator certificates to qualified applicants.

(f) A designated aircraft dispatcher examiner (DADE) may—

(1) Accept applications for, and conduct, written and practical tests necessary for issuing aircraft dispatcher certificates under part 65 of this chapter; and

(2) In the discretion of the appropriate local Flight Standards Inspector, issue temporary aircraft dispatcher certificates to qualified applicants.

[Doc. No. 1151, 27 FR 4951, May 26, 1962, as amended by Amdt. 183–9, 54 FR 39296, Sept. 25, 1989]

**§ 183.27 Designated aircraft maintenance inspectors.**

A designated aircraft maintenance inspector (DAMI) may approve maintenance on civil aircraft used by United States military flying clubs in foreign countries.

**§ 183.29 Designated engineering representatives.**

(a) A structural engineering representative may approve structural engineering information and other structural considerations within limits prescribed by and under the general supervision of the Administrator, whenever the representative determines that information and other structural considerations comply with the applicable regulations of this chapter.

(b) A power plant engineering representative may approve information relating to power plant installations within limitations prescribed by and under the general supervision of the Administrator whenever the representative determines that information complies with the applicable regulations of this chapter.

(c) A systems and equipment engineering representative may approve engineering information relating to equipment and systems, other than those of a structural, powerplant, or radio nature, within limits prescribed by and under the general supervision of the Administrator, whenever the representative determines that informa-

tion complies with the applicable regulations of this chapter.

(d) A radio engineering representative may approve engineering information relating to the design and operating characteristics of radio equipment, within limits prescribed by and under the general supervision of the Administrator whenever the representative determines that information complies with the applicable regulations of this chapter.

(e) An engine engineering representative may approve engineering information relating to engine design, operation and service, within limits prescribed by and under the general supervision of the Administrator, whenever the representative determines that information complies with the applicable regulations of this chapter.

(f) A propeller engineering representative may approve engineering information relating to propeller design, operation, and maintenance, within limits prescribed by and under the general supervision of the Administrator whenever the representative determines that information complies with the applicable regulations of this chapter.

(g) A flight analyst representative may approve flight test information, within limits prescribed by and under the general supervision of the Administrator, whenever the representative determines that information complies with the applicable regulations of this chapter.

(h) A flight test pilot representative may make flight tests, and prepare and approve flight test information relating to compliance with the regulations of this chapter, within limits prescribed by and under the general supervision of the Administrator.

(i) An acoustical engineering representative may witness and approve aircraft noise certification tests and approve measured noise data and evaluated noise data analyses, within the limits prescribed by, and under the general supervision of, the Administrator, whenever the representative determines that the noise test, test data, and associated analyses are in conformity with the applicable regulations

of this chapter. Those regulations include, where appropriate, the methodologies and any equivalencies previously approved by the Director of Environment and Energy, for that noise test series. No designated acoustical engineering representative may determine that a type design change is not an acoustical change, or approve equivalencies to prescribed noise procedures or standards.

[Doc. No. 1151, 27 FR 4951, May 26, 1962, as amended by Amdt. 183-7, 45 FR 32669, May 19, 1980; Amdt. 183-9, 54 FR 39296, Sept. 25, 1989]

#### § 183.31 Designated manufacturing inspection representatives.

A designated manufacturing inspection representative (DMIR) may, within limits prescribed by, and under the general supervision of, the Administrator, do the following:

(a) Issue—

(1) Original airworthiness certificates for aircraft and airworthiness approvals for engines, propellers, and product parts that conform to the approved design requirements and are in a condition for safe operation;

(2) Export certificates of airworthiness and airworthiness approval tags in accordance with subpart L of part 21 of this chapter;

(3) Experimental certificates for aircraft for which the manufacturer holds the type certificate and which have undergone changes to the type design requiring a flight test; and

(4) Special flight permits to export aircraft.

(b) Conduct any inspections that may be necessary to determine that—

(1) Prototype products and related parts conform to design specifications; and

(2) Production products and related parts conform to the approved type design and are in condition for safe operation.

(c) Perform functions authorized by this section for the manufacturer, or the manufacturer's supplier, at any location authorized by the FAA.

[Doc. No. 16622, 45 FR 1416, Jan. 7, 1980]

#### § 183.33 Designated Airworthiness Representative.

A Designated Airworthiness Representative (DAR) may, within limits

prescribed by and under the general supervision of the Administrator, do the following:

(a) Perform examination, inspection, and testing services necessary to issue, and to determine the continuing effectiveness of, certificates, including issuing certificates, as authorized by the Director of Flight Standards Service in the area of maintenance or as authorized by the Director of Aircraft Certification Service in the areas of manufacturing and engineering.

(b) Charge a fee for his or her services.

(c) Perform authorized functions at any authorized location.

(Secs. 313(a), 314, 601, 603, 605, and 1102, Federal Aviation Act of 1958, as amended (49 U.S.C. 1354(a), 1355, 1421, 1423, 1425, and 1502); sec.6(c) Department of Transportation Act (49 U.S.C. 1655(c)))

[Doc. No. 23140, 48 FR 16179, Apr. 14, 1983, as amended by Amdt. 183-9, 54 FR 39296, Sept. 25, 1989; Amdt. 183-11, 67 FR 72766, Dec. 6, 2002]

### Subpart D—Organization Designation Authorization

SOURCE: Doc. No. FAA-2003-16685, 70 FR 59947, Oct. 13, 2005, unless otherwise noted.

#### § 183.41 Applicability and definitions.

(a) This subpart contains the procedures required to obtain an Organization Designation Authorization, which allows an organization to perform specified functions on behalf of the Administrator related to engineering, manufacturing, operations, airworthiness, or maintenance.

(b) *Definitions.* For the purposes of this subpart:

*Organization Designation Authorization* (ODA) means the authorization to perform approved functions on behalf of the Administrator.

*ODA Holder* means the organization that obtains the authorization from the Administrator, as identified in a Letter of Designation.

*ODA Unit* means an identifiable group of two or more individuals within the ODA Holder's organization that performs the authorized functions.

## § 183.43

### § 183.43 Application.

An application for an ODA may be submitted after November 14, 2006. An application for an ODA must be submitted in a form and manner prescribed by the Administrator and must include the following:

- (a) A description of the functions for which authorization is requested.
- (b) A description of how the applicant satisfies the requirements of § 183.47 of this part;
- (c) A description of the applicant's organizational structure, including a description of the proposed ODA Unit as it relates to the applicant's organizational structure; and
- (d) A proposed procedures manual as described in § 183.53 of this part.

### § 183.45 Issuance of Organization Designation Authorizations.

- (a) The Administrator may issue an ODA Letter of Designation if:
  - (1) The applicant meets the applicable requirements of this subpart; and
  - (2) A need exists for a delegation of the function.
- (b) An ODA Holder must apply to and obtain approval from the Administrator for any proposed changes to the functions or limitations described in the ODA Holder's authorization.

### § 183.47 Qualifications.

To qualify for consideration as an ODA, the applicant must—

- (a) Have sufficient facilities, resources, and personnel, to perform the functions for which authorization is requested;
- (b) Have sufficient experience with FAA requirements, processes, and procedures to perform the functions for which authorization is requested; and
- (c) Have sufficient, relevant experience to perform the functions for which authorization is requested.

### § 183.49 Authorized functions.

- (a) Consistent with an ODA Holder's qualifications, the Administrator may delegate any function determined appropriate under 49 U.S.C. 44702(d).
- (b) Under the general supervision of the Administrator, an ODA Unit may perform only those functions, and is subject to the limitations, listed in the ODA Holder's procedures manual.

## 14 CFR Ch. I (1–1–08 Edition)

### § 183.51 ODA Unit personnel.

Each ODA Holder must have within its ODA Unit—

- (a) At least one qualified ODA administrator; and either
- (b) A staff consisting of the engineering, flight test, inspection, or maintenance personnel needed to perform the functions authorized. Staff members must have the experience and expertise to find compliance, determine conformity, determine airworthiness, issue certificates or issue approvals; or
- (c) A staff consisting of operations personnel who have the experience and expertise to find compliance with the regulations governing the issuance of pilot, crew member, or operating certificates, authorizations, or endorsements as needed to perform the functions authorized.

### § 183.53 Procedures manual.

No ODA Letter of Designation may be issued before the Administrator approves an applicant's procedures manual. The approved manual must:

- (a) Be available to each member of the ODA Unit;
- (b) Include a description of those changes to the manual or procedures that may be made by the ODA Holder. All other changes to the manual or procedures must be approved by the Administrator before they are implemented.
- (c) Contain the following:
  - (1) The authorized functions and limitations, including the products, certificates, and ratings;
  - (2) The procedures for performing the authorized functions;
  - (3) Description of the ODA Holder's and the ODA Unit's organizational structure and responsibilities;
  - (4) A description of the facilities at which the authorized functions are performed;
  - (5) A process and a procedure for periodic audit by the ODA Holder of the ODA Unit and its procedures;
  - (6) The procedures outlining actions required based on audit results, including documentation of all corrective actions;
  - (7) The procedures for communicating with the appropriate FAA offices regarding administration of the delegation authorization;

(8) The procedures for acquiring and maintaining regulatory guidance material associated with each authorized function;

(9) The training requirements for ODA Unit personnel;

(10) For authorized functions, the procedures and requirements related to maintaining and submitting records;

(11) A description of each ODA Unit position, and the knowledge and experience required for each position;

(12) The procedures for appointing ODA Unit members and the means of documenting Unit membership, as required under § 183.61(a)(4) of this part;

(13) The procedures for performing the activities required by § 183.63 or § 183.65 of this part;

(14) The procedures for revising the manual, pursuant to the limitations of paragraph (b) of this section; and

(15) Any other information required by the Administrator necessary to supervise the ODA Holder in the performance of its authorized functions.

#### § 183.55 Limitations.

(a) If any change occurs that may affect an ODA Unit's qualifications or ability to perform a function (such as a change in the location of facilities, resources, personnel or the organizational structure), no Unit member may perform that function until the Administrator is notified of the change, and the change is approved and appropriately documented as required by the procedures manual.

(b) No ODA Unit member may issue a certificate, authorization, or other approval until any findings reserved for the Administrator have been made.

(c) An ODA Holder is subject to any other limitations as specified by the Administrator.

#### § 183.57 Responsibilities of an ODA Holder.

The ODA Holder must—

(a) Comply with the procedures contained in its approved procedures manual;

(b) Give ODA Unit members sufficient authority to perform the authorized functions;

(c) Ensure that no conflicting non-ODA Unit duties or other interference

affects the performance of authorized functions by ODA Unit members.

(d) Cooperate with the Administrator in his performance of oversight of the ODA Holder and the ODA Unit.

(e) Notify the Administrator of any change that could affect the ODA Holder's ability to continue to meet the requirements of this part within 48 hours of the change occurring.

#### § 183.59 Inspection.

The Administrator, at any time and for any reason, may inspect an ODA Holder's or applicant's facilities, products, components, parts, appliances, procedures, operations, and records associated with the authorized or requested functions.

#### § 183.61 Records and reports.

(a) Each ODA Holder must ensure that the following records are maintained for the duration of the authorization:

(1) Any records generated and maintained while holding a previous delegation under subpart J or M of part 21, or SFAR 36 of this chapter.

(2) For any approval or certificate issued by an ODA Unit member (except those airworthiness certificates and approvals not issued in support of type design approval projects):

(i) The application and data required to be submitted under this chapter to obtain the certificate or approval; and

(ii) The data and records documenting the ODA Unit member's approval or determination of compliance.

(3) A list of the products, components, parts, or appliances for which ODA Unit members have issued a certificate or approval.

(4) The names, responsibilities, qualifications and example signature of each member of the ODA Unit who performs an authorized function.

(5) A copy of each manual approved or accepted by the ODA Unit, including all historical changes.

(6) Training records for ODA Unit members and ODA administrators.

(7) Any other records specified in the ODA Holder's procedures manual.

(8) The procedures manual required under § 183.53 of this part, including all changes.

**§ 183.63**

(b) Each ODA Holder must ensure that the following are maintained for five years:

(1) A record of each periodic audit and any corrective actions resulting from them; and

(2) A record of any reported service difficulties associated with approvals or certificates issued by an ODA Unit member.

(c) For airworthiness certificates and approvals not issued in support of a type design approval project, each ODA Holder must ensure the following are maintained for two years;

(1) The application and data required to be submitted under this chapter to obtain the certificate or approval; and

(2) The data and records documenting the ODA Unit member's approval or determination of compliance.

(d) For all records required by this section to be maintained, each ODA Holder must:

(1) Ensure that the records and data are available to the Administrator for inspection at any time;

(2) Submit all records and data to the Administrator upon surrender or termination of the authorization.

(e) Each ODA Holder must compile and submit any report required by the Administrator to exercise his supervision of the ODA Holder.

**§ 183.63 Continuing requirements: Products, parts or appliances.**

For any approval or certificate for a product, part or appliance issued under the authority of this subpart, or under the delegation rules of subpart J or M of part 21, or SFAR 36 of this chapter, an ODA Holder must:

(a) Monitor reported service problems related to certificates or approvals it holds;

(b) Notify the Administrator of:

(1) A condition in a product, part or appliance that could result in a finding of unsafe condition by the Administrator; or

(2) A product, part or appliance not meeting the applicable airworthiness requirements for which the ODA Holder has obtained or issued a certificate or approval.

(c) Investigate any suspected unsafe condition or finding of noncompliance with the airworthiness requirements

**14 CFR Ch. I (1-1-08 Edition)**

for any product, part or appliance, as required by the Administrator, and report to the Administrator the results of the investigation and any action taken or proposed.

(d) Submit to the Administrator the information necessary to implement corrective action needed for safe operation of the product, part or appliance.

**§ 183.65 Continuing requirements: Operational approvals.**

For any operational authorization, airman certificate, air carrier certificate, air operator certificate, or air agency certificate issued under the authority of this subpart, an ODA Holder must:

(a) Notify the Administrator of any error that the ODA Holder finds it made in issuing an authorization or certificate;

(b) Notify the Administrator of any authorization or certificate that the ODA Holder finds it issued to an applicant not meeting the applicable requirements;

(c) When required by the Administrator, investigate any problem concerning the issuance of an authorization or certificate; and

(d) When notified by the Administrator, suspend issuance of similar authorizations or certificates until the ODA Holder implements all corrective action required by the Administrator.

**§ 183.67 Transferability and duration.**

(a) An ODA is effective until the date shown on the Letter of Designation, unless sooner terminated by the Administrator.

(b) No ODA may be transferred at any time.

(c) The Administrator may terminate or temporarily suspend an ODA for any reason, including that the ODA Holder:

(1) Has requested in writing that the authorization be suspended or terminated;

(2) Has not properly performed its duties;

(3) Is no longer needed; or

(4) No longer meets the qualifications required to perform authorized functions.

**PART 185—TESTIMONY BY EMPLOYEES AND PRODUCTION OF RECORDS IN LEGAL PROCEEDINGS, AND SERVICE OF LEGAL PROCESS AND PLEADINGS**

Sec.

185.1 Purpose.

185.3 Acceptance of service on behalf of the Secretary of Transportation or the Administrator.

185.5 Testimony by employees and production of records in legal proceedings.

AUTHORITY: 49 U.S.C. 106(g), 40113-40114, 46104; 49 CFR part 9.

SOURCE: Docket No. 9900, 34 FR 16622, Oct. 17, 1969, unless otherwise noted.

**§ 185.1 Purpose.**

(a) The purpose of this part is to name the FAA officials who, pursuant to part 9 of the regulations of the Office of the Secretary of Transportation (49 CFR part 9) as amended (34 FR 11972, July 16, 1969), are those:

(1) Upon whom legal process or pleadings may be served in any legal proceeding concerning the FAA, and who have authority to acknowledge the service and take further action thereon; and

(2) Who otherwise perform the functions prescribed by part 9 in legal proceedings concerning the FAA with respect to testimony by FAA employees and production of FAA records in legal proceedings.

(b) For purposes of this part, "legal proceedings" includes any proceeding before a court of law, administrative board or commission, hearing officer, or other body conducting a legal or administrative proceeding.

**§ 185.3 Acceptance of service on behalf of the Secretary of Transportation or the Administrator.**

Legal process or pleadings in any legal proceeding concerning the FAA may be served, at the option of the server, on the Chief Counsel, Deputy Chief Counsel, Assistant Chief Counsel, Litigation Division, of the FAA, or any other FAA official designated by the Chief Counsel, with the same effect as if served upon the Secretary of Transportation or the Administrator. The official accepting the service under this

section acknowledges the service and takes further action as appropriate.

**§ 185.5 Testimony by employees and production of records in legal proceedings.**

The Chief Counsel, and each Assistant Chief Counsel, each Regional Counsel, the Aeronautical Center Counsel, and the Technical Center Counsel, with respect to matters arising within their respective jurisdictions, and any other FAA official designated by the Chief Counsel, perform the functions in legal proceedings (other than one described in § 185.3 of this part) as prescribed by part 9 of the regulations of the Office of the Secretary of Transportation, with respect to testimony by FAA employees and production of FAA records in legal proceedings.

[Doc. No. 9900, 34 FR 16622, Oct. 17, 1969, as amended by Amdt. 185-1, 54 FR 39296, Sept. 25, 1989; Amdt. 185-3, 62 FR 46866, Sept. 4, 1997]

**PART 187—FEES**

Sec.

187.1 Scope.

187.5 Duplicates of licenses.

187.7 Copies; seal.

187.15 Payment of fees.

187.17 Failure of applicant to pay prescribed fees.

APPENDIX A TO PART 187—METHODOLOGY FOR COMPUTATION OF FEES FOR CERTIFICATION SERVICES PERFORMED OUTSIDE THE UNITED STATES

APPENDIX B TO PART 187—FEES FOR FAA SERVICES FOR CERTAIN FLIGHTS

APPENDIX C TO PART 187—FEES FOR PRODUCTION CERTIFICATION-RELATED SERVICES PERFORMED OUTSIDE THE UNITED STATES

AUTHORITY: 31 U.S.C. 9701; 49 U.S.C. 106(g), 49 U.S.C. 106(1)(6), 40104-40105, 40109, 40113-40114, 44702.

SOURCE: Docket No. 8347, 32 FR 12051, Aug. 22, 1967, unless otherwise noted.

**§ 187.1 Scope.**

This part prescribes fees only for FAA services for which fees are not prescribed in other parts of this chapter or in 49 CFR part 7. The fees for services furnished in connection with making information available to the public are prescribed exclusively in 49 CFR part 7. Appendix A to this part

## § 187.5

prescribes the methodology for computation of fees for certification services performed outside the United States. Appendix A to this part prescribes the methodology for computation of fees for certification services performed outside the United States. Appendix B to this part prescribes the fees for certain aircraft flights that transit U.S.-controlled airspace.

[Doc. No. 8347, 32 FR 12051, Aug 22, 1967, as amended by Amdt. 187-7, 62 FR 13503, Mar. 20, 1997; Amdt. 187-7, 63 FR 40000, July 24, 1998; Amdt. 187-11, 65 FR 36008, June 6, 2000; Amdt. 187-12, 66 FR 43717, Aug. 20, 2001]

### § 187.5 Duplicates of licenses.

The fee for furnishing to a person entitled thereto a replacement, duplicate, or facsimile of a certificate or other document evidencing a license, for which a fee is not specifically provided elsewhere in this chapter, is \$2.

### § 187.7 Copies; seal.

The fees for furnishing photostatic or similar copies of documents and for affixation of the seal for a certification or validation are the same as those provided in subpart H of 49 CFR part 7.

### § 187.15 Payment of fees.

(a) The fees of this part are payable to the Federal Aviation Administration by check, money order, wire transfers, draft, payable in U.S. currency and drawn on a U.S. bank, or by credit card payable in U.S. currency, prior to the provision of any service under this part.

(b) Applicants for the FAA services provided under this part shall pay any bank processing charges on fees collected under this part, when such charges are assessed on U.S. Government.

(c) Applicants for the FAA services described in Appendix A of this part shall pay bank processing charges, when such charges are assessed by banks on U.S. Government deposits.

(d) The fees described in appendix B of this part are payable to the Federal Aviation Administration in U.S. currency. Remittance of fees of \$1,000 or more are to be paid by electronic funds transfer. Remittance of amounts less than \$1,000 may be paid by electronic

## 14 CFR Ch. I (1-1-08 Edition)

funds transfer, check, money order, credit card, or draft.

[Doc. No. 27809, 60 FR 19631, Apr. 19, 1995, as amended by Amdt. 187-7, 62 FR 13503, Mar. 20, 1997; Amdt. 187-7, 62 FR 23295, Apr. 29, 1997; Amdt. 187-10, 62 FR 55703, Oct. 27, 1997; Amdt. 187-7, 63 FR 40000, July 24, 1998; Amdt. 187-11, 65 FR 36008, June 6, 2000; Amdt. 187-12, 66 FR 43718, Aug. 20, 2001; Amdt. 187-4, 72 FR 18559, Apr. 12, 2007]

### § 187.17 Failure by applicant to pay prescribed fees.

If an applicant fails to pay fees agreed to under appendix C of this part, the FAA may suspend or deny any application for service and may suspend or revoke any production certification-related approval granted.

[Doc. No. 28967, 62 FR 55703, Oct. 27, 1997]

### APPENDIX A TO PART 187—METHODOLOGY FOR COMPUTATION OF FEES FOR CERTIFICATION SERVICES PERFORMED OUTSIDE THE UNITED STATES

(a) Fixed fees and hourly rates have been derived using the methodology described below to ensure full cost recovery for certification actions or approvals provided by the FAA for persons outside the United States.

(b) These rates are based on aviation safety inspector time rather than calculating a separate rate for managerial or clerical time because the inspector is the individual performing the actual service. Charging for inspector time, while building in all costs into the rate base, provides for efficient cost recovery and time management.

(c) The hourly billing rate has been determined by using the annual operations budget of the Flight Standards Service. The budget is comprised of the following:

(1) Personnel compensation and benefits, budget code series 1100 (excluding codes 1151 and 1152—overtime, Sunday and holiday pay), 1200, and 1300.

(2) Travel and transportation of persons, budget code series 2100 (excluding code 2100—site visit travel).

(3) Transportation of things, budget code series 2200.

(4) Rental, communications, utilities, budget code series 2300.

(5) Printing and reproduction, budget code series 2400.

(6) Contractual services, budget code series 2500.

(7) Supplies and materials, budget code series 2600.

(8) Equipment, budget code series 3100.

(9) Lands and structures, budget code series 3200.

(10) Insurance claims and indemnities, budget code series 4200.

(d) In order to recover overhead costs attributable to the budget, all costs other than direct inspector transportation and subsistence, overtime, and Sunday/holiday costs, are assigned to the number of inspector positions. An hourly cost per inspector is developed by dividing the annual Flight Standards Operations Budget, excluding the items enumerated above, by the number of aviation safety inspections (OMB position series 1825) on board at the beginning of the fiscal year, to determine the annual cost of an aviation safety inspector. This annual cost of an aviation safety inspector is divided by 2,087 hours, which is the annual paid hours of a U.S. Federal Government employee. This result in the hourly government paid cost of an aviation safety inspector.

(e) To ensure that the hourly inspector cost represents a billing rate that ensures

full recovery of costs, the hourly cost per inspector must be multiplied by an indirect work factor to determine the hourly inspector billing rate. This is necessary for the following reasons:

(1) Inspectors spend a significant amount of time in indirect work to support their inspection activities, much of which cannot be allocated to any one client.

(2) Not all 2,087 annual paid hours are available as work hours because training, providing technical assistance, leave, and other indirect work activities reduce the work time that may be directly billed. Consequently, the hourly cost per inspector must be adjusted upwards by an indirect work factor. The calculation of an indirect work factor is discussed in paragraph (f) of this appendix.

(f)(1) The indirect work factor is determined using the following formula:

$$\left(1 + \sum_{i=1}^k a_i\right)(1 + b) = \text{indirect work factor}$$

where:

a=indirect work rate, and

b=leave usage (total leave hours divided by total hours available for work).

(2) The components of the formula are derived as follows:

(i) *a=indirect work rate.* Indirect work rate is taken from the Flight Standards Staffing Standard Order and is used to project the amount of time an aviation safety inspector spends in indirect activities, as opposed to certification and surveillance work. The indirect work activities are:

(A) Development of master minimum equipment lists on Flight Operations Evaluation Board.

(B) Development of aircraft training documents on Flight Standardization Board.

(C) Development of Maintenance program documents on Maintenance Review Board.

(D) Providing technical assistance.

(E) Assisting legal counsel.

(F) Evaluation of technical documents.

(G) Leave (all types).

(H) Training.

(I) Administrative time.

(J) Travel for indirect work.

(ii) *b=leave usage (total leave hours divided by total hours available for work).* This is computed by using OMB guidelines of 280 average annual leave hours and 1,800 average annual hours available for work for computer manpower requirements.

(g) The hourly inspector cost, when multiplied by the indirect work factor, yields the

hourly inspector billing rate and ensures full cost recovery by incorporating the total amount of FAA paid hours needed to produce one hour of direct billable inspector time.

(h) Certifications and approvals for which there are fixed times, such as airman tests, are determined by multiplying the time used in the Flight Standards Staffing Standard or airman test guidelines by the inspector hourly billing rate.

(i) Certifications and approvals for which there are no fixed work rates, such as airman and repair station facilities (air agencies), are billed at the hourly inspector billing rate.

(j) Actual transportation and subsistence expenses incurred in certification or approval actions will be billed in addition to the hourly inspector billing rate, where such expenses are incurred.

(k) In no event will the fees exceed the actual costs of providing certification or approval services.

(l) The methodology for computing user fees is published in this Appendix. The User fee schedule is published in an FAA Advisory Circular entitled "Flight Standards Service Schedule of Charges Outside the United States." A copy of this publication may be obtained from: New Orders, Superintendent of Documents, P.O. Box 371954, Pittsburgh, PA 15250-7954.

(m) Fees will be reviewed every year, at the beginning of the fiscal year, and adjusted

either upward or downward in order to reflect the current costs of performing tests, authorizations, certifications, permits, or ratings.

(n) Notice of each change to a fee for a service described in the user fee schedule will be published in the "Notices" section of the FEDERAL REGISTER.

[Amdt. 187-5, 60 FR 19631, Apr. 19, 1995]

#### APPENDIX B TO PART 187—FEES FOR FAA SERVICES FOR CERTAIN FLIGHTS

(a) *Applicability.* Except as provided in paragraphs (b) and (c) of this appendix, this appendix applies to any person who conducts a flight through U.S.-controlled airspace that does not include a landing or takeoff in the United States. U.S.-controlled airspace is defined as all U.S. airspace either directly owned by the United States or allocated to the United States by the International Civil Aviation Organization (ICAO) or by other countries. This is further defined, for this section only, as Enroute and Oceanic airspace. Enroute airspace is defined, for this section only, as airspace where primarily radar-based air traffic services are provided. Oceanic airspace is defined, for this section only, as airspace where primarily procedural air traffic services are provided.

(b) *Governmental flights.* This appendix does not apply to any military or civilian flight operated by the United States Government or by any foreign government.

(c) *Canada-to-Canada flights.* This appendix will not apply to any operator of a flight that takes off and lands in Canada, without an intermediate stop outside Canada, that operates in U.S.-controlled airspace.

(d) *Services.* Persons covered by paragraph (a) of this appendix must pay a fee for the FAA's rendering or providing certain services, including but not limited to the following:

- (1) Air traffic management.
- (2) Communications.
- (3) Navigation.
- (4) Radar surveillance, including separation services.
- (5) Flight information services.
- (6) Procedural control.
- (7) Emergency services and training.

(e) *Methodology for the computation of fees.* (1) For the services listed in paragraph (d) of this appendix, the fee is computed based on the distance flown in either enroute or oceanic airspace (U.S.-controlled airspace.) Distance flown is based on the great circle distance (GCD) for the point of entry and the point of exit of U.S.-controlled airspace based on FAA flight data. Fees are assessed using the methodology presented in paragraph (e)(2) of this appendix. Where actual entry and exit points are not available, the

best available FAA flight data will be used to calculate the entry and exit points.

(2) A User (operator of an overflight) is assessed a fee for each 100 nautical miles (or portion thereof) flown in each segment and type of U.S.-controlled airspace. Separate calculations are made for transiting Enroute and Oceanic airspace. The total fee charged for an Overflight between any entry and exit points is equal to the sum of these two charges. This relationship is summarized as:

$$R_{ij} = \$15.94 * DO_{ij} + \$33.72 * DE_{ij},$$

Where

$R_{ij}$  = the fee charged to aircraft flying between entry point  $i$  and exit point  $j$ .

$DO_{ij}$  = total great circle distance traveled in each segment of U.S.-controlled oceanic airspace expressed in hundreds of nautical miles for aircraft flying between entry point  $i$  and exit point  $j$  for each segment of oceanic airspace.

$DE_{ij}$  = total great circle distance traveled in each segment of U.S.-controlled enroute airspace expressed in hundreds of nautical miles for aircraft flying between entry point  $i$  and exit point  $j$  for each segment of enroute airspace.

(f) *Billing and payment procedures—(1) Billing.* The FAA will send an invoice to each user that is covered by this appendix when fees are owed to the FAA. If the FAA cannot identify the user, then an invoice will be sent to the registered owner. No invoice will be sent unless the monthly (based on Greenwich Mean Time) fees for service equal or exceed \$250. Users will be billed at the address of record in the country where the aircraft is registered, unless a billing address is otherwise provided.

(2) *Payment.* Payment must be made by one of the methods described in §187.15(d).

(g) *Review of rule.* The rule prescribed in this appendix will be reviewed at least once every 2 years and adjusted to reflect the current costs of the services covered by this appendix.

[Amdt. 187-12, 66 FR 43718, Aug. 20, 2001]

#### APPENDIX C TO PART 187—FEES FOR PRODUCTION CERTIFICATION-RELATED SERVICES PERFORMED OUTSIDE THE UNITED STATES

(a) *Purpose.* This appendix describes the methodology for the calculation of fees for production certification-related services outside the United States that are performed by the FAA.

(b) *Applicability.* This appendix applies to production approval holders who elect to use manufacturing facilities or supplier facilities located outside the United States to manufacture or assemble aeronautical products after September 30, 1997.

(c) *Definitions.* For the purpose of this appendix, the following definitions apply:

*Manufacturing facility* means a place where production of a complete aircraft, aircraft engine, propeller, part, component, or appliance is performed.

*Production certification-related service* means a service associated with initial production approval holder qualification; ongoing production approval holder and supplier surveillance; designee management; initial production approval holder qualification and ongoing surveillance for production certificate extensions outside the United States; conformity inspections; and witnessing of tests.

*Supplier facility* means a place where production of a part, component, or sub-assembly is performed for a production approval holder.

*Production approval holder* means a person who holds an FAA approval for production under type certificate only, an FAA approval for production under an approved production inspection system, a production certificate, a technical standard order authorization, or a parts manufacturer approval.

(d) *Procedural requirements.* (1) Applicants may apply for FAA production certification-related services provided outside the United States by a letter of application to the FAA detailing when and where the particular services are required.

(2) The FAA will notify the applicant in writing of the estimated cost and schedule to provide the services.

(3) The applicant will review the estimated costs and schedule of services. If the applicant agrees with the estimated costs and schedule of services, the applicant will propose to the FAA that the services be provided. If the FAA agrees and can provide the services requested, a written agreement will be executed between the applicant and the FAA.

(4) The applicant must provide advance payment for each 12-month period of agreed FAA service unless a shorter period is agreed to between the Production Approval Holder and FAA.

(e) *Fee determination.* (1) Fees for FAA production certification-related services will consist of: personnel compensation and benefit (PC&B) for each participating FAA employee, actual travel and transportation expenses incurred in providing the service, other agency costs and an overhead percentage.

(2) Fees will be determined on a case-by-case basis according to the following general formula:

$$W_1H_1 + W_2H_2 \text{ etc.,} + T + O$$

Where:

$W_1H_1$ =hourly PC&B rate for employee 1, times estimated hours

$W_2H_2$ =hourly PC&B rate for employee 2, etc., times estimated hours

T=estimated travel and transportation expenses

O=other agency costs related to each activity including overhead.

(3) In no event will the applicant be charged more than the actual FAA costs of providing production certification-related services.

(4) If the actual FAA costs vary from the estimated fees by more than 10 percent, written notice by the FAA will be given to the applicant as soon as possible.

(5) If FAA costs exceed the estimated fees, the applicant will be required to pay the difference prior to receiving further services. If the estimated fees exceed the FAA costs, the applicant may elect to apply the balance to future agreements or to receive a refund.

(f) Fees will be reviewed by the FAA periodically and adjusted either upward or downward in order to reflect the current costs of performing production certification-related services outside the United States.

(1) Notice of any change to the elements of the fee formula in this Appendix will be published in the FEDERAL REGISTER.

(2) Notice of any change to the methodology in this Appendix and other changes for the fees will be published in the FEDERAL REGISTER.

[Doc. No. 28967, 62 FR 55703, Oct. 27, 1997]

## PART 189—USE OF FEDERAL AVIATION ADMINISTRATION COMMUNICATIONS SYSTEM

Sec.

189.1 Scope.

189.3 Kinds of messages accepted or relayed.

189.5 Limitation of liability.

AUTHORITY: 31 U.S.C. 9701; 49 U.S.C. 106(g), 40104, 40113, 44502, 45303.

SOURCE: Docket No. 27778, 60 FR 39615, Aug. 2, 1995, unless otherwise noted.

### § 189.1 Scope.

This part describes the kinds of messages that may be transmitted or relayed by FAA Flight Service Stations.

### § 189.3 Kinds of messages accepted or relayed.

(a) Flight Service Stations may accept for transmission over FAA communication systems any messages concerning international or overseas aircraft operations described in paragraphs (a) (1) through (6) of this section. In addition, Flight Service Stations may relay any message described

in this section that was originally accepted for transmission at an FAA Flight Service Station outside the 48 contiguous States, or was received from a foreign station of the Aeronautical Fixed Telecommunications Network that, in normal routing, would require transit of the United States to reach an overseas address:

(1) Distress messages and distress traffic.

(2) Messages concerning the safety of human life.

(3) Flight safety messages concerning—

(i) Air traffic control, including—

(A) Messages concerning aircraft in flight or about to depart;

(B) Departure messages;

(C) Flight plan departure messages;

(D) Arrival messages;

(E) Flight plan messages;

(F) Flight notification messages;

(G) Messages concerning flight cancellation; and

(H) Messages concerning delayed departure;

(ii) Position reports from aircraft;

(iii) Messages originated by an aircraft operating agency of immediate concern to an aircraft in flight or about to depart; and

(iv) Meteorological advice of immediate concern to an aircraft in flight or about to depart.

(4) Meteorological messages concerning—

(i) Meteorological forecasts;

(ii) Meteorological observations exclusively; or

(iii) Other meteorological information exchanged between meteorological offices.

(5) Aeronautical administrative messages—

(i) Concerning the operation or maintenance of facilities essential to the safety or regulatory of aircraft operation;

(ii) Essential to efficient functioning of aeronautical telecommunications; or

(iii) Between civil aviation authorities concerning aircraft operation.

(6) Notices to airmen.

(b) The following messages may only be relayed through the FAA communications systems:

(1) Flight regularity messages—

(i) Addressed to the point of intended landing and to not more than two other addressees in the general area of the route segment of the flight to which the message refers, containing information required for weight and balance computation and remarks essential to the rapid unloading of the aircraft;

(ii) Concerning changes, taking effect within 72 hours, in aircraft operating schedules;

(iii) Concerning the servicing of aircraft en route or scheduled to depart within 48 hours;

(iv) Concerning changes in the collective requirements for passengers, crew, or cargo of aircraft en route or about to depart, if the changes are caused by unavoidable deviations from normal operating schedules and are necessary for flight regularity;

(v) Concerning non-routine landings to be made by aircraft en route or about to depart;

(vi) Concerning parts or materials urgently needed to operate aircraft en route or scheduled to depart within 48 hours; or

(vii) Concerning pre-flight arrangement of air navigation services and, in the case of non-scheduled or irregular operations, operational servicing of aircraft scheduled to depart within 48 hours.

(2) Messages originated by and addressed to aircraft operating agencies or their representatives that directly bear on the efficient and economic conduct or day to day operations, if adequate non-United States communications facilities are not available and the messages concern—

(i) Matter described in paragraph (b)(1) of this section, but not meeting the time limitations described in paragraph (b)(1) of this section;

(ii) Aircraft parts, equipment, or supplies, air navigation or communications, or essential ground facilities;

(iii) Train or hotel reservations for passengers or employees;

(iv) Lost baggage or personal effects;

(v) Tickets or cargo shipments and payment therefore;

(vi) Location of passengers and cargo;

(vii) New or revised passenger or cargo rates;

(viii) Crew assignments and similar operations personnel matters taking effect within 7 days;

(ix) Post flight reports for record purposes;

(x) Publicity and special handling regarding dignitaries; or

(xi) Reservations, when originated by aircraft operating agencies to secure space required in transport aircraft.

#### § 189.5 Limitation of liability.

The United States is not liable for any omission, error, or delay in transmitting or relaying, or for any failure to transmit or relay, any message accepted for transmission or relayed under this part, even if the omission, error, delay, or failure to transmit or relay is caused by the negligence of an employee of the United States.

## PART 193—PROTECTION OF VOLUNTARILY SUBMITTED INFORMATION

Sec.

193.1 What does this part cover?

193.3 Definitions.

193.5 How may I submit safety or security information and have it protected from disclosure?

193.7 What does it mean for the FAA to designate information as protected?

193.9 Will the FAA ever disclose information that is designated as protected under this part?

193.11 What is the notice procedure?

193.13 What is the no-notice procedure?

193.15 What FAA officials exercise the authority of the Administrator under this part?

193.17 How must design and production approval holders handle information they receive from the FAA under this part?

AUTHORITY: 49 U.S.C. 106(g), 40113, 40123.

SOURCE: 66 FR 33805, June 25, 2001, unless otherwise note.

#### § 193.1 What does this part cover?

This part describes when and how the FAA protects from disclosure safety and security information that you submit voluntarily to the FAA. This part carries out 49 U.S.C. 40123, protection of voluntarily submitted information.

#### § 193.3 Definitions.

*Agency* means each authority of the Government of the United States,

whether or not the agency is within or subject to review by another agency, but does not include—

(1) The Congress;

(2) The courts of the United States;

(3) The governments of the territories or possessions of the United States;

(4) The government of the District of Columbia;

(5) Court martial and military commissions.

*De-identified* means that the identity of the source of the information, and the names of persons have been removed from the information.

*Disclose* means to release information to a person other than another agency. Examples are disclosures under the Freedom of Information Act (5 U.S.C. 552), in rulemaking proceedings, in a press release, or to a party to a legal action.

*Information* includes data, reports, source, and other information. “Information” may be used to describe the whole or a portion of a submission of information.

*Summarized* means that individual incidents are not specifically described, but are presented in statistical or other general form.

*Voluntary* means that the information was not required to be submitted as part of a mandatory program, and was not submitted as a condition of doing business with the government. “Voluntarily-provided information” does not include information submitted as part of complying with statutory, regulatory, or contractual requirements, except that information submitted as part of complying with a voluntary program under this part is considered to be voluntarily provided.

#### § 193.5 How may I submit safety or security information and have it protected from disclosure?

(a) You may do so under a program under this part. The program may be developed based on your proposal, a proposal from another person, or a proposal developed by the FAA.

(b) You may be any person, including an individual, a company, or an organization.

(c) You may propose to develop a program under this part using either the

## § 193.7

## 14 CFR Ch. I (1–1–08 Edition)

notice procedure in § 193.11 or the no-notice procedure in § 193.13.

(d) If the FAA decides to protect the information that you propose to submit it issues an order designating the information as protected under this part.

(e) The FAA only issues an order designating information as protected if the FAA makes the findings in § 193.7.

(f) The designation may be for a program in which all similar persons may participate, or for a program in which only you submit information.

(g) Even if you receive protection from disclosure under this part, this part does not establish the extent to which the FAA may or may not use the information to take enforcement action. Limits on enforcement action applicable to a program under this part will be in another policy or rule.

### **§ 193.7 What does it mean for the FAA to designate information as protected?**

(a) *General.* When the FAA issues an order designating information as protected under this part, the FAA does not disclose the information except as provided in this part.

(b) *What findings does the FAA make before designating information as protected?* The FAA designates information as protected under this part when the FAA finds that—

(1) The information is provided voluntarily;

(2) The information is safety or security related;

(3) The disclosure of the information would inhibit the voluntary provision of that type of information;

(4) The receipt of that type of information aids in fulfilling the FAA's safety and security responsibilities; and

(5) Withholding such information from disclosure, under the circumstances provided in this part, will be consistent with the FAA's safety and security responsibilities.

(c) *How will the FAA handle requests for information under the Freedom of Information Act (FOIA)?* The FAA does not disclose information that is designated as protected under this part in response to a FOIA request.

(d) *What if the FAA obtains from another source the same information I submit?* Only information received under a program under this part is protected from disclosure under this part. Information obtained by the FAA through another means is not protected under this part.

(e) *Sharing information with other agencies.* The FAA may provide information that you have submitted under this part to other agencies with safety or security responsibilities. The agencies are subject to the requirements of 49 U.S.C. 40123 regarding nondisclosure of information. The FAA will give the information to another agency only if, for each such request, the other agency provides the FAA with adequate assurance, in writing, that—

(1) The agency has a safety or security need for the information, including the general nature of the need.

(2) The agency will protect the information from disclosure as required in 49 U.S.C. 40123, this part, and the designation. This includes a commitment that the agency will mark the information as provided in the designation.

(3) The agency will limit access to those with a need to know to carry out safety or security responsibilities.

(f) *What if the FAA receives a subpoena for the information I submit?* When the FAA receives a subpoena for information you have submitted under this part, the FAA contacts you to determine whether you object to disclosure of the information or you wish to participate in responding to the subpoena. If both you and the FAA determine that release of the information is appropriate, the information is released. Otherwise, the FAA will not release information designated as protected under this part unless ordered to do so by a court of competent jurisdiction.

### **§ 193.9 Will the FAA ever disclose information that is designated as protected under this part?**

The FAA discloses information that is designated as protected under this part when withholding it would not be consistent with the FAA's safety and security responsibilities, as follows:

(a) *Disclosure in all programs.* (1) The FAA may disclose de-identified, summarized information submitted under

this part to explain the need for changes in policies and regulations. An example is the FAA publishing a notice of proposed rulemaking based on your information, and including a de-identified, summarized version of your information (and the information from other persons, if applicable) to explain the need for the notice of proposed rulemaking.

(2) The FAA may disclose information provided under this part to correct a condition that compromises safety or security, if that condition continues uncorrected.

(3) The FAA may disclose information provided under this part to carry out a criminal investigation or prosecution.

(4) The FAA may disclose information provided under this part to comply with 49 U.S.C. 44905, regarding information about threats to civil aviation.

(b) *Additional disclosures.* For each program, the FAA may find that there are additional circumstances under which withholding information provided under this part would not be consistent with the FAA's safety and security responsibilities. Those circumstances are described in the designation for that program.

#### § 193.11 What is the notice procedure?

This section states the notice procedure for the FAA to designate information as protected under this part. This procedure is used when there is not an immediate safety or security need for the information. This procedure generally is used to specify a type of information that you and others like you will provide on an on-going basis.

(a) *Application.* You may apply to have information designated as protected under this part by submitting an application addressed to the U.S. Department of Transportation, Docket Operations, West Building Ground Floor, Room W12-140, 1200 New Jersey Avenue, SE., Washington, DC 20590 for paper submissions, and the Federal Docket Management System (FDMS) Web page at <http://www.regulations.gov> for electronic submissions. Your application must include the designation described in paragraph (c) of this section that you want the FAA to issue. You should not include in your application

any information that you do not want available to the public. The FAA may issue a proposed designation based on the application or may deny your application.

(b) *Proposed designation.* Before issuing a designation under this section, based either on your application or the FAA's own initiative, the FAA publishes a proposed designation in the FEDERAL REGISTER and requests comment.

(c) *Designation.* The FAA designates information as protected under this part if, after review of the comments, the FAA makes the findings in § 193.7. The FAA publishes in the FEDERAL REGISTER an order designating the information provided under the program as protected under this part. The designation includes the following:

(1) A summary of why the FAA finds that you and others, if applicable, will provide the information voluntarily.

(2) A description of the type of information that you and others, if applicable, may voluntarily provide under the program and a summary of why the FAA finds that the information is safety or security related.

(3) A summary of why the FAA finds that the disclosure of the information would inhibit you and others, if applicable, from voluntarily providing of that type of information.

(4) A summary of why the receipt of that type of information aids in fulfilling the FAA's safety and security responsibilities.

(5) A summary of why withholding such information from disclosure would be consistent with the FAA's safety and security responsibilities, including a statement as to the circumstances under which, and a summary of why, withholding such information from disclosure would not be consistent with the FAA's safety and security responsibilities, as described in § 193.9.

(6) A summary of how the FAA will distinguish information protected under this part from information the FAA receives from other sources.

(7) A summary of the significant comments received and the FAA's responses.

(d) *Amendment of designation.* The FAA may amend a designation using

## § 193.13

## 14 CFR Ch. I (1–1–08 Edition)

the procedures in paragraphs (a), (b), and (c) of this section.

(e) *Withdrawal of designation.* The FAA may withdraw a designation under this section at any time the FAA finds that continuation of the designation does not meet the elements of §193.7, or if the requirements of the designation are not met. The FAA withdraws the designation by publishing a notice in the FEDERAL REGISTER. The withdrawal is effective on the date of publication or such later date as the notice may state. Information provided during the time the program was designated remains protected under this part and the program. Information provided after the withdrawal of the designation is effective is not protected under this part or the program.

[66 FR 33805, June 25, 2001, as amended at 72 FR 68475, Dec. 5, 2007]

### § 193.13 What is the no-notice procedure?

This section states the no-notice procedure for the FAA to designate information as protected under this part. This procedure is used when there is an immediate safety or security need for the information. This procedure generally is used for specific information that you will provide on a short-term basis.

(a) *Application.* You may request that the FAA designate information you are offering as protected under this part. You must state your name, at least the general nature of information, and whether you will provide the information without the protection of this part. Your request may be verbal or writing.

(b) *Designation.* The FAA issues a written order designating information provided under this section as protected under this part. The FAA designates the information as protected under this part if the FAA—

(1) Makes the findings as §193.7; and

(2) Finds that there is an immediate safety or security need to obtain the information without carrying out the procedures in §193.11 of this part.

(c) *Time limit.* Except as provided in paragraphs (c)(1) and (c)(2) of this section, no designation under this section continues in effect for more than 60

days after the date of designation. Information provided during the time the designation was in effect remains protected under this part. Information provided that the designation ceases to be in effect is not protected under this part. The designation remains in effect for more than 60 days if—

(1) The procedures to designate such information under §193.11(a) have been initiated, or

(2) There is an ongoing enforcement or criminal investigation, in which case the designation may continue until the investigation is completed.

(d) *Amendment of designation.* The FAA may amend a designation under this section using the procedures in paragraphs (a) and (b) of this section.

(e) *Withdrawal of designation.* The FAA may withdraw a designation under this section at any time the FAA finds that continuation does not meet the elements of §193.7, or if the requirements of the designation are not met. The FAA withdraws the designation by notifying the person in writing that the designation is withdrawn. The withdrawal is effective on the date of receipt of the notice or such later date as the notice may state. Information provided during the time the designation was in effect remains protected under this part. Information provided after the withdrawal is effective is not protected under this part.

### § 193.15 What FAA officials exercise the authority of the Administrator under this part?

(a) The authority to issue proposed and final designations, to issue proposed and final amendments of designations, and to withdraw designations under this part, and to disclose information that has been designated as protected under this part, is delegated by the Administrator to Associate Administrators and Assistant Administrators and to the Chief Counsel, their Deputies, and any individual formally designated as Acting Associate or Assistant Administrator, Acting Chief Counsel, or Acting Deputy of such offices.

(b) The officials identified in paragraph (a) of this section may further

**Federal Aviation Administration, DOT**

**§ 193.17**

delegate the authority to issue proposed designations and proposed amendments to designations.

**§ 193.17 How must design and production approval holders handle information they receive from the FAA under this part?**

(a) If the FAA discloses information under § 193.9(a)(2) to the holders of de-

sign approvals of production approvals issued by the FAA, the approval holder must disclose that information only to persons who need to know the information to address the safety or security condition.

(b) Unless an emergency exists, before disclosing information to approval holders the FAA will contact the submitter of the information.

**SUBCHAPTERS L-M [RESERVED]**

## SUBCHAPTER N—WAR RISK INSURANCE

### PART 198—AVIATION INSURANCE

Sec.

198.1 Eligibility of aircraft operation for insurance.

198.3 Basis of insurance.

198.5 Types of insurance coverage available.

198.7 Amount of insurance coverage available.

198.9 Application for insurance.

198.11 Change in status of aircraft.

198.13 Premium insurance—payment of premiums.

198.15 Non-premium insurance—payment of registration binders.

198.17 Ground support and other coverage.

AUTHORITY: 49 U.S.C. 106(g), 40113, 44301–44310; 49 CFR 1.47(b).

SOURCE: Docket No. 28893, 63 FR 13739, Mar. 20, 1998, unless otherwise noted.

#### § 198.1 Eligibility of aircraft operation for insurance.

An aircraft operation is eligible for insurance if—

(a) The President of the United States has determined that the continuation of that aircraft operation is necessary to carry out the foreign policy of the United States;

(b) The aircraft operation is—

(1) In foreign air commerce or between two or more places all of which are outside the United States if insurance with premium is sought; or

(2) In domestic or foreign air commerce, or between two or more places all of which are outside the United States if insurance without premium is sought; and

(c) The Administrator finds that commercial insurance against loss or damage arising out of any risk from the aircraft operation cannot be obtained on reasonable terms from an insurance carrier.

#### § 198.3 Basis of insurance.

(a) Premium insurance may be issued by the FAA if the requirements of § 198.19 (a), (b)(1) and (c) are met.

(b) Subject to § 198.9(c), standby insurance without premium may be issued by the FAA if all of the following conditions have been met:

(1) A department, agency, or instrumentality of the U.S. Government

seeks performance of air services operations, pursuant to a contract of the department, agency, or instrumentality; or transportation of military forces or materiel on behalf of the United States, pursuant to an agreement between the United States and a foreign government.

(2) Such department, agency, or instrumentality of the U.S. Government has agreed in writing to indemnify the Secretary of Transportation against all losses covered by such insurance. Such an agreement, when countersigned by the President, constitutes a determination that the continuation of that aircraft operation is necessary to carry out the foreign policy of the United States.

(3) A current copy of the aircraft operator's applicable commercial insurance policy or policies is on file with the FAA, including every endorsement making a material change to the policy. Updated copies of these policies must be provided upon each renewal of the commercial policy. Every subsequent material change by endorsement must be promptly provided to the FAA.

(c) Insurance is activated, placing the insurance in full force, as specified by the FAA's written notification to the operator and remains in force until such time as either of the following occurs:

(1) The requirements in § 198.1 are no longer met; or

(2) In the case of non-premium insurance, an aircraft operation is no longer performed under contract to a department, agency, or instrumentality of the U.S. Government; or pursuant to an agreement between the United States and a foreign government; or the Administrator finds that commercial insurance can now be obtained on reasonable terms.

(d) Insurance policies revert to standby status upon written notification by the FAA to the aircraft operator. A policy will remain in standby status until either—

(1) The insurance is activated by written notice; or

(2) The policy is canceled.

**§ 198.5 Types of insurance coverage available.**

Application may be made for insurance against loss or damage to the following persons, property, or interests:

(a) Aircraft, or insurable items of an aircraft, engaged in eligible operations under § 198.1.

(b) Any individual employed or transported on the aircraft referred to in paragraph (a) of this section.

(c) The baggage of persons referred to in paragraph (b) of this section.

(d) Property transported, or to be transported, on the aircraft referred to in paragraph (a) of this section.

(e) Statutory or contractual obligations, or any other liability, of the aircraft referred to in paragraph (a) of this section or of its owner or operator, of the nature customarily covered by insurance.

**§ 198.7 Amount of insurance coverage available.**

(a) For each aircraft or insurable item, the amount insured may not exceed the amount for which the applicant has otherwise insured or self-insured the aircraft or insurable item against damage or liability arising from any risk. In the case of hull insurance, the amount insured may not exceed the reasonable value of the aircraft as determined by the FAA or its designated agent.

(b) Policies issued without premium may be revised from time to time by the FAA with notice to the insured, to add aircraft or insurable items or to amend amounts of coverage if the insured has changed the amount by which it has otherwise insured or self-insured the aircraft or itself.

**§ 198.9 Applicant for insurance.**

(a) Application for premium or non-premium insurance must be made in accordance with the applicable form supplied by the FAA.

(b) Each applicant for insurance with the premium under this part must submit to the FAA with its application a letter describing in detail the operations in which the aircraft is or will be engaged and stating the type of insurance coverage being sought and the reason it is being sought. The applicant

must also submit any other information deemed pertinent by the FAA.

(c) Each applicant for premium or non-premium insurance must, upon request by the FAA, submit to the FAA evidence that commercial insurance is not available on reasonable terms for each flight or ground operation for which insurance is sought. Each aircraft operator who has a standby non-premium insurance policy must, upon request by the FAA, submit evidence to the FAA that commercial insurance is not available on reasonable terms before the FAA activates that policy. The adequacy of the evidence submitted is determined solely by the FAA.

(d) The standby non-premium policy issued to the aircraft operator does not provide actual coverage until formally activated by the FAA.

**§ 198.11 Change in status of aircraft.**

In the event of sale, lease, confiscation, requisition, total loss, or other change in the status of an aircraft or insurable items covered by insurance under this part, the insured party must notify the office administering the Aviation Insurance Program before, or as soon as practicable after, the change in status.

**§ 198.13 Premium insurance—payment of premiums.**

The insured must pay the premium for insurance issued under this part within the stated period after receipt of notice that premium payment is due and in accordance with the provisions of the applicable FAA insurance policy. Premiums must be sent to the FAA, and made payable to the FAA.

**§ 198.15 Non-premium insurance—payment of registration binders.**

(a) The binder for initial registration is \$575 for each aircraft or insurable item. This binder is adjusted not more frequently than annually based on changes in the Consumer Price Index of All Urban Consumers published by the Secretary of Labor.

(b) An application for non-premium insurance must be accompanied by the proper binder, payable to the FAA. A binder is not returnable unless the application is rejected.

**§ 198.17**

(c) Requests made after issuance of a non-premium policy for the addition of an aircraft or insurable item must be accompanied by the binder for each aircraft and insurable item.

(d) When an operator acquires an aircraft or insurable item that was previously covered under an active or standby policy, the new operator must register that aircraft or item on its policy and pay the binder for each aircraft and insurable item.

**14 CFR Ch. I (1-1-08 Edition)**

**§ 198.17 Ground support and other coverage.**

An aircraft operator may apply for insurance to cover any risks arising from the provision of goods or services directly supporting the operation of an aircraft that meets the requirements of § 198.3(b).

**PART 199 [RESERVED]**

## FINDING AIDS

---

A list of CFR titles, subtitles, chapters, subchapters and parts and an alphabetical list of agencies publishing in the CFR are included in the CFR Index and Finding Aids volume to the Code of Federal Regulations which is published separately and revised annually.

Material Approved for Incorporation by Reference  
Table of CFR Titles and Chapters  
Alphabetical List of Agencies Appearing in the CFR  
List of CFR Sections Affected



## Material Approved for Incorporation by Reference

(Revised as of January 1, 2008)

The Director of the Federal Register has approved under 5 U.S.C. 552(a) and 1 CFR Part 51 the incorporation by reference of the following publications. This list contains only those incorporations by reference effective as of the revision date of this volume. Incorporations by reference found within a regulation are effective upon the effective date of that regulation. For more information on incorporation by reference, see the preliminary pages of this volume.

### 14 CFR (PARTS 140–199)

#### FEDERAL AVIATION ADMINISTRATION, DEPARTMENT OF TRANSPORTATION 14 CFR

##### American National Standards Institute

25 West 43rd Street, Fourth floor, New York, NY 10036 Telephone:  
(212) 642–4900

International Electrotechnical Commission Pub. No. 179, Precision Part 150, A150.9  
Sound Level Meters.

##### Federal Aviation Administration

National Flight Data Center, 800 Independence Ave. SW., Wash-  
ington, D.C. 20590

Federal Aviation Administration Advisory Circulars:

Copies of FAA Advisory Circulars are available from the addresses  
listed at the end of this table.

150/5100–12 Electron Navigational Aids Approved for Funding Under the Airport Development Aid Program (ADAP) (1976).	152.11
150/5190–3A Model Airport Hazard Zoning Ordinance (1972) .....	152.11
150/5210–7A Aircraft Fire and Rescue Communications (1972) .....	152.11
150/5210–10 Airport Fire and Rescue Equipment Building Guide (1967).	152.11
150/5300–2C Airport Design Standards—Site Requirements for Ter- minal Navigational Facilities (Through Change 1, 1976).	152.11
150/5300–4B Utility Airports—Air Access to National Transportation (Through change 1, 1976).	152.11
150/5300–6 Airport Design Standards—General Aviation Airports— Basic and General Transport (Through Change 2, 1969).	152.11
150/5300–8 Planning and Design Criteria for Metropolitan STOL Ports (1970).	152.11
150/5320–5B Airport Drainage (1970) .....	152.11
150/5320–6B Airport Pavement Design and Evaluation (Through Change 1, 1974).	152.11
150/5320–10 Environmental Enhancement at Airports—Industrial Waste Treatment (1974).	152.11
150/5320–12 Methods for the Design, Construction, and Maintenance of Skid Resistant Airport Pavement Surfaces (1975).	152.11
150/5325–2C Airport Design Standards—Airports Served by Air Car- riers—Surface Gradient and Line-of-Sight (Through Change 1, 1975).	152.11
150/5325–4 Runway Length Requirements for Airport Design (1977)	152.11
150/5325–6A Airport Design Standards—Effect and Treatment of Jet Blast (1972).	152.11

## Title 14—Aeronautics and Space

14 CFR (PARTS 140–199)—Continued

FEDERAL AVIATION ADMINISTRATION, DEPARTMENT OF TRANSPORTATION—  
Continued

	14 CFR
150/5325–8 Compass Calibration Pad (1969) .....	152.11
150/5335–1A Airport Design Standards—Airports Served by Air Carriers—Taxiways (1970, through Change 2, 1976).	152.11
150/5335–2 Airport Aprons (1965) .....	152.11
150/5335–3 Airport Design Standards—Airports Served by Air Carriers—Bridges and Tunnels on Airports (1971).	152.11
150/5335–4 Airport Design Standards—Airports Served by Air Carriers—Runway Geometrics (Through Change 1, 1976).	152.11
150/5340–1D Marking of Paved Areas on Airports (1973) .....	152.11
150/5340–4C Installation Details for Runway Centerline and Touchdown Zone Lighting Systems (Through Change 1, 1975).	152.11
150/5340–5A Segmented Circle Airport Marker System (1971) .....	152.11
150/5340–8 Airport 51-foot Tubular Beacon Tower (1964) .....	152.11
150/5340–14B Economy Approach Lighting Aids (Through Change 2, 1975).	152.11
150/5340–17A Standby Power for Non-FAA Airport Lighting System (1971).	152.11
150/5340–18 Taxiway Guidance Sign System (1968) .....	152.11
150/5340–19 Taxiway Centerline Lighting System (1968) .....	152.11
150/5340–20 Installation Details and Maintenance Standards for Reflective Markers for Airport Runway and Taxiway Centerlines (1969).	152.11
150/5340–21 Airport Miscellaneous Lighting Visual Aids (1971) .....	152.11
150/5340–22 Maintenance Guide for Determining Degradation and Cleaning of Centerline and Touchdown Zone Lights (1971, Change 1, 1976).	152.11
150/5340–23A Supplemental Wind Cones (1975) .....	152.11
150/5340–24 Runway and Taxiway Edge Lighting System (1975) .....	152.11
150/5340–25 Visual Approach Slope Indicator (VASI) Systems (Through Change 1, 1977).	152.11
150/5345–1E Approved Airport Lighting Equipment (Through Change 1, 1977).	152.11
150/5345–2 Specifications for L–810 Obstruction Light (through Change 1, 1963).	152.11
150/5345–3C Specification for L–821 Panels for Remote Control of Airport Lighting (1977).	152.11
150/5345–4 Specification for L–829 Internally Lighted Airport Taxi Guidance Sign (Through Change 1, 1967).	152.11
150/5345–5 Specification for L–847 Circuit Selector Switch, 5,000 Volt 20 Ampere (1963).	152.11
150/5345–7C Specification for L–824 Underground Electrical Cable for Airport Lighting Circuits (1976).	152.11
150/5345–10C Specification for L–828 Constant Current Regulators (1971).	152.11
150/5345–11 Specification for L–812 Static Indoor Type Constant Current Regulator Assembly; 4 KW and 7½ KW, With Brightness Control for Remote Operation (1964).	152.11
150/5345–12A Specification for L–801 Beacon (Through Change 1, 1974).	152.11
150/5345–13 Specification for L–841 Auxiliary Relay Cabinet Assembly for Pilot Control of Airport Lighting Circuits (1964).	152.11

## Material Approved for Incorporation by Reference

14 CFR (PARTS 140–199)—Continued

FEDERAL AVIATION ADMINISTRATION, DEPARTMENT OF TRANSPORTATION—  
Continued

	14 CFR
150/5345–18 Specification for L–811 Static Indoor Type Constant Current Regulator Assembly, 4 KW; With Brightness Control and Runway Selection for Direct Operation (Through Change 1, 1975).	152.11
150/5345–21 Specification for L–813 Static Indoor Type Constant Current Regulator Assembly; 4 KW and 7½ KW; for Remote Operation of Taxiway Lights (1964).	152.11
150/5345–26A Specification for L–823 Plug and Receptacle, Cable Connectors (Through change 1, 1971).	152.11
150/5345–27A Specification for L–807 Eight-foot and Twelve-foot Unlighted or Externally Lighted Wind Cone Assemblies (1969).	152.11
150/5345–28C Specification L–851 Visual Approach Slope Indicators and Accessories (1977).	152.11
150/5345–36 Specification for L–808 Lighted Wind Tee (1965) .....	152.11
150/5345–39A FAA Specification for L–853, Runway and Taxiway Retroreflective Markers (1971).	152.11
150/5345–42A FAA Specification L–857, Airport Light Bases, Transformer Housings, and Junction Boxes (Through change 1, 1975).	152.11
150/5345–43B FAA/DOD Specification L–856, High Intensity Obstruction Lighting Systems (1973).	152.11
150/5345–44A Specification for L–858 Retroreflective Taxiway Guidance Sign (1971).	152.11
150/5345–45 Lightweight Approach Light Structure (1973) .....	152.11
150/5345–46 Specification for Semiflush Airport Lights (Through change 1, 1975).	152.11
150/5345–47 Isolation Transformers for Airport Lighting Systems (1975).	152.11
150/5345–48 Specification for Runway and Taxiway Edge Lights (Through change 1, 1976).	152.11
150/5360–6 Airport Terminal Building Development with Federal Participation (1976).	152.11
150/5360–7 Planning and Design Considerations for Airport Terminal Building Development (1976).	152.11
150/5370–7 Airport Construction Controls to Prevent Air Water Pollution (1971).	152.11
150/5370–9 Slip-Form Paving—Portland Cement Concrete (1973) .....	152.11
150/5370–10 Standards for Specifying Construction of Airports (1974)	152.11
150/5370–11 Use of Nondestructive Testing Devices in the Evaluation of Airport Pavements (1976).	152.11
150/5390–1A Heliport Design Guide (1969) .....	152.11
36–3B Estimated Airplane Noise Levels in A-Weighted Decibels (1981).	159.40

Address Table for Federal Aviation Administration Advisory Circulars:

FAA Distribution Unit, M–443.1, Department of Transportation Warehouse, 1725 15th St. NE., Washington, D.C. 20002

Airports Division, ANE–600, Federal Aviation Administration, 12 New England Executive Park, Burlington, MA 01803

Airports Division, AEA–600, Federal Aviation Administration, Federal Bldg., Room 329, John F. Kennedy International Airport, Jamaica, NY 11430

Airports District Office, ADO–NYC, Federal Aviation Administration, Colonial Bldg., 181 S. Franklin Ave., Valley Stream, NY 11581

## Title 14—Aeronautics and Space

14 CFR (PARTS 140–199)—Continued

FEDERAL AVIATION ADMINISTRATION, DEPARTMENT OF TRANSPORTATION—  
Continued

14 CFR

Airports District Office, ADO–HAR, Federal Aviation Administration, Terminal Bldg., Capital City Airport, New Cumberland, PA 17070

Airports District Office, ADO–WASH, Federal Aviation Administration, 900 S. Washington St., Falls Church, VA 22046

Airports Field Office, Federal Aviation Administration, Route 9—Box 31–C, Beaver, WV 25813

Airports Division, ASO–600, Federal Aviation Administration, 3400 Whipple St., East Point, GA 30344

Airports District Office, ADO–ATL, Federal Aviation Administration, Suite C, Room 116, 1568 Willingham Dr., College Park, GA 30337

Airports District Office, ADO–MIA, Federal Aviation Administration, FAA/NWS Bldg., Miami International Airport, Miami, FL 33159

Airports District Office, ADO–MEM, Federal Aviation Administration, 3973 Knight Arnold Rd., Suite 103, Memphis, TN 38118

Airports District Office, ADO–JAN, Federal Aviation Administration, FAA Bldg.—Municipal Airport, Jackson, MS 39208

Airports Division, AGL–600, Federal Aviation Administration, 2300 E. Devon Ave., Des Plaines, IL 60018

Airports District Office, CHI–ADO, Federal Aviation Administration, 2300 E. Devon Ave., Des Plaines, IL 60018

Airports District Office, DET–ADO, Federal Aviation Administration, Bldg. 358, Detroit Metropolitan Airport, Detroit, MI 48242

Airports District Office, MSP–ADO, Federal Aviation Administration, 6301 34th Ave. South, Minneapolis, MN 55450

Airports Division, ACE–600, Federal Aviation Administration, Federal Bldg., 601 E. 12th St., Kansas City, MO 64106

Airports Division, ASW–600, Federal Aviation Administration, 4400 Blue Mound Rd., Fort Worth, TX 76131

Airports District Office, ASW–HOU–ADO, Federal Aviation Administration, Wm. P. Hobby Airport, 8800 Paul B. Koonce Dr., Houston, TX 77061

Airports District Office, ASW–ABQ–ADO, Federal Aviation Administration, NWS/FAA Bldg., Albuquerque International Airport, P.O. Box 9253, Albuquerque, NM 87119

Airports District Office, ASW–OKC–ADO, Federal Aviation Administration, FAA Bldg., Room 204, Wiley Post Airport, Bethany, OK 73008

Airports Division, ARM–600, Federal Aviation Administration, 10455 E. 25th Ave., Aurora, CO 80010

Airports Field Office, BIS–662, Federal Aviation Administration, 2000 Airport Rd., Bismarck, ND 58501

Airports Field Office, HLN–662, Federal Aviation Administration, FAA Bldg., Room 2, Helena County Airport, Helena, MT 59601

Airports Division, ANW–600, Federal Aviation Administration, FAA Bldg., Boeing Field, King County International Airport, Seattle, WA 98108

Airports Division, AWE–600, Federal Aviation Administration, 15000 Aviation Blvd., Lawndale, CA 90261

## Material Approved for Incorporation by Reference

14 CFR (PARTS 140–199)—Continued

FEDERAL AVIATION ADMINISTRATION, DEPARTMENT OF TRANSPORTATION—  
Continued

14 CFR

Airports Field Office, AWE–680, Federal Aviation Administration,  
15000 Aviation Blvd., Lawndale, CA 90261

Airports Field Office, SFO–680, Federal Aviation Administration,  
831 Mitten Rd., Burlingame, CA 94010

Airports Division, AAL–600, Federal Aviation Administration, An-  
chorage Federal Office Bldg., P.O. Box 14, 701 C. St., Anchorage,  
AL 99513

Airports Division, APC–600, Federal Aviation Administration,  
Prince Jonah Kuhio Kalanianaʻole Bldg., 300 Ala Moana Blvd., Hono-  
lulu, HI 96813

Technical Standard Orders:

United States Flight Inspection Manual (3d Ed., May, 1963) ..... 171.71

United States Standard for Technical Instrument Procedures (3d Ed.,  
July, 1976). 171.71

### International Civil Aviation Organization

Attention: Distribution Officer, P.O. Box 400, Succursale: Place  
de l'Aviation Internationale, 1000 Sherbrooke St. West, Montreal,  
Quebec, Canada, H3A 2R2

Annex 10 to the Convention on International Civil Aviation (2d  
Ed., Vol. I, Apr. 1965). 171.71



## Table of CFR Titles and Chapters

(Revised as of January 1, 2008)

### Title 1—General Provisions

- I Administrative Committee of the Federal Register (Parts 1—49)
- II Office of the Federal Register (Parts 50—299)
- IV Miscellaneous Agencies (Parts 400—500)

### Title 2—Grants and Agreements

#### SUBTITLE A—OFFICE OF MANAGEMENT AND BUDGET GUIDANCE FOR GRANTS AND AGREEMENTS

- I Office of Management and Budget Governmentwide Guidance for Grants and Agreements (Parts 100—199)
- II Office of Management and Budget Circulars and Guidance (200—299)

#### SUBTITLE B—FEDERAL AGENCY REGULATIONS FOR GRANTS AND AGREEMENTS

- III Department of Health and Human Services (Parts 300—399)
- VI Department of State (Parts 600—699)
- VIII Department of Veterans Affairs (Parts 800—899)
- IX Department of Energy (Parts 900—999)
- XI Department of Defense (Parts 1100—1199)
- XIV Department of the Interior (Parts 1400—1499)
- XV Environmental Protection Agency (Parts 1500—1599)
- XXVIII National Aeronautics and Space Administration (Parts 1880—1899)
- XXII Corporation for National and Community Service (Parts 2200—2299)
- XXIV Housing and Urban Development (Parts 2400—2499)
- XXV National Science Foundation (Parts 2500—2599)
- XXVI National Archives and Records Administration (Parts 2600—2699)
- XXVII Small Business Administration (Parts 2700—2799)
- XXVIII Department of Justice (Parts 2800—2899)
- XXXII National Endowment for the Arts (Parts 3200—3299)
- XXXIII National Endowment for the Humanities (Parts 3300—3399)
- XXXV Export-Import Bank of the United States (Parts 3500—3599)
- XXXVII Peace Corps (Parts 3700—3799)

### **Title 3—The President**

Chap.

- I Executive Office of the President (Parts 100—199)

### **Title 4—Accounts**

- I Government Accountability Office (Parts 1—99)

### **Title 5—Administrative Personnel**

- I Office of Personnel Management (Parts 1—1199)
- II Merit Systems Protection Board (Parts 1200—1299)
- III Office of Management and Budget (Parts 1300—1399)
- V The International Organizations Employees Loyalty Board (Parts 1500—1599)
- VI Federal Retirement Thrift Investment Board (Parts 1600—1699)
- VIII Office of Special Counsel (Parts 1800—1899)
- IX Appalachian Regional Commission (Parts 1900—1999)
- XI Armed Forces Retirement Home (Parts 2100—2199)
- XIV Federal Labor Relations Authority, General Counsel of the Federal Labor Relations Authority and Federal Service Impasses Panel (Parts 2400—2499)
- XV Office of Administration, Executive Office of the President (Parts 2500—2599)
- XVI Office of Government Ethics (Parts 2600—2699)
- XXI Department of the Treasury (Parts 3100—3199)
- XXII Federal Deposit Insurance Corporation (Parts 3200—3299)
- XXIII Department of Energy (Parts 3300—3399)
- XXIV Federal Energy Regulatory Commission (Parts 3400—3499)
- XXV Department of the Interior (Parts 3500—3599)
- XXVI Department of Defense (Parts 3600—3699)
- XXVIII Department of Justice (Parts 3800—3899)
- XXIX Federal Communications Commission (Parts 3900—3999)
- XXX Farm Credit System Insurance Corporation (Parts 4000—4099)
- XXXI Farm Credit Administration (Parts 4100—4199)
- XXXIII Overseas Private Investment Corporation (Parts 4300—4399)
- XXXV Office of Personnel Management (Parts 4500—4599)
- XL Interstate Commerce Commission (Parts 5000—5099)
- XLI Commodity Futures Trading Commission (Parts 5100—5199)
- XLII Department of Labor (Parts 5200—5299)
- XLIII National Science Foundation (Parts 5300—5399)
- XLV Department of Health and Human Services (Parts 5500—5599)
- XLVI Postal Rate Commission (Parts 5600—5699)
- XLVII Federal Trade Commission (Parts 5700—5799)
- XLVIII Nuclear Regulatory Commission (Parts 5800—5899)
- L Department of Transportation (Parts 6000—6099)
- LII Export-Import Bank of the United States (Parts 6200—6299)
- LIII Department of Education (Parts 6300—6399)

## **Title 5—Administrative Personnel—Continued**

Chap.	
LIV	Environmental Protection Agency (Parts 6400—6499)
LV	National Endowment for the Arts (Parts 6500—6599)
LVI	National Endowment for the Humanities (Parts 6600—6699)
LVII	General Services Administration (Parts 6700—6799)
LVIII	Board of Governors of the Federal Reserve System (Parts 6800—6899)
LIX	National Aeronautics and Space Administration (Parts 6900—6999)
LX	United States Postal Service (Parts 7000—7099)
LXI	National Labor Relations Board (Parts 7100—7199)
LXII	Equal Employment Opportunity Commission (Parts 7200—7299)
LXIII	Inter-American Foundation (Parts 7300—7399)
LXIV	Merit Systems Protection Board (Parts 7400—7499)
LXV	Department of Housing and Urban Development (Parts 7500—7599)
LXVI	National Archives and Records Administration (Parts 7600—7699)
LXVII	Institute of Museum and Library Services (Parts 7700—7799)
LXIX	Tennessee Valley Authority (Parts 7900—7999)
LXXI	Consumer Product Safety Commission (Parts 8100—8199)
LXXIII	Department of Agriculture (Parts 8300—8399)
LXXIV	Federal Mine Safety and Health Review Commission (Parts 8400—8499)
LXXVI	Federal Retirement Thrift Investment Board (Parts 8600—8699)
LXXVII	Office of Management and Budget (Parts 8700—8799)
XCVII	Department of Homeland Security Human Resources Management System (Department of Homeland Security--Office of Personnel Management) (Parts 9700—9799)
XCIX	Department of Defense Human Resources Management and Labor Relations Systems (Department of Defense--Office of Personnel Management) (Parts 9900—9999)

## **Title 6—Domestic Security**

I	Department of Homeland Security, Office of the Secretary (Parts 0—99)
X	Privacy and Civil Liberties Oversight Board (Parts 1000—1099)

## **Title 7—Agriculture**

SUBTITLE A—OFFICE OF THE SECRETARY OF AGRICULTURE (PARTS 0—26)	
SUBTITLE B—REGULATIONS OF THE DEPARTMENT OF AGRICULTURE	
I	Agricultural Marketing Service (Standards, Inspections, Marketing Practices), Department of Agriculture (Parts 27—209)
II	Food and Nutrition Service, Department of Agriculture (Parts 210—299)
III	Animal and Plant Health Inspection Service, Department of Agriculture (Parts 300—399)

## Title 7—Agriculture—Continued

Chap.	
IV	Federal Crop Insurance Corporation, Department of Agriculture (Parts 400—499)
V	Agricultural Research Service, Department of Agriculture (Parts 500—599)
VI	Natural Resources Conservation Service, Department of Agriculture (Parts 600—699)
VII	Farm Service Agency, Department of Agriculture (Parts 700—799)
VIII	Grain Inspection, Packers and Stockyards Administration (Federal Grain Inspection Service), Department of Agriculture (Parts 800—899)
IX	Agricultural Marketing Service (Marketing Agreements and Orders; Fruits, Vegetables, Nuts), Department of Agriculture (Parts 900—999)
X	Agricultural Marketing Service (Marketing Agreements and Orders; Milk), Department of Agriculture (Parts 1000—1199)
XI	Agricultural Marketing Service (Marketing Agreements and Orders; Miscellaneous Commodities), Department of Agriculture (Parts 1200—1299)
XIV	Commodity Credit Corporation, Department of Agriculture (Parts 1400—1499)
XV	Foreign Agricultural Service, Department of Agriculture (Parts 1500—1599)
XVI	Rural Telephone Bank, Department of Agriculture (Parts 1600—1699)
XVII	Rural Utilities Service, Department of Agriculture (Parts 1700—1799)
XVIII	Rural Housing Service, Rural Business-Cooperative Service, Rural Utilities Service, and Farm Service Agency, Department of Agriculture (Parts 1800—2099)
XX	Local Television Loan Guarantee Board (Parts 2200—2299)
XXVI	Office of Inspector General, Department of Agriculture (Parts 2600—2699)
XXVII	Office of Information Resources Management, Department of Agriculture (Parts 2700—2799)
XXVIII	Office of Operations, Department of Agriculture (Parts 2800—2899)
XXIX	Office of Energy Policy and New Uses, Department of Agriculture (Parts 2900—2999)
XXX	Office of the Chief Financial Officer, Department of Agriculture (Parts 3000—3099)
XXXI	Office of Environmental Quality, Department of Agriculture (Parts 3100—3199)
XXXII	Office of Procurement and Property Management, Department of Agriculture (Parts 3200—3299)
XXXIII	Office of Transportation, Department of Agriculture (Parts 3300—3399)
XXXIV	Cooperative State Research, Education, and Extension Service, Department of Agriculture (Parts 3400—3499)
XXXV	Rural Housing Service, Department of Agriculture (Parts 3500—3599)

## **Title 7—Agriculture—Continued**

Chap.	
XXXVI	National Agricultural Statistics Service, Department of Agriculture (Parts 3600—3699)
XXXVII	Economic Research Service, Department of Agriculture (Parts 3700—3799)
XXXVIII	World Agricultural Outlook Board, Department of Agriculture (Parts 3800—3899)
XLI	[Reserved]
XLII	Rural Business-Cooperative Service and Rural Utilities Service, Department of Agriculture (Parts 4200—4299)

## **Title 8—Aliens and Nationality**

I	Department of Homeland Security (Immigration and Naturalization) (Parts 1—499)
V	Executive Office for Immigration Review, Department of Justice (Parts 1000—1399)

## **Title 9—Animals and Animal Products**

I	Animal and Plant Health Inspection Service, Department of Agriculture (Parts 1—199)
II	Grain Inspection, Packers and Stockyards Administration (Packers and Stockyards Programs), Department of Agriculture (Parts 200—299)
III	Food Safety and Inspection Service, Department of Agriculture (Parts 300—599)

## **Title 10—Energy**

I	Nuclear Regulatory Commission (Parts 0—199)
II	Department of Energy (Parts 200—699)
III	Department of Energy (Parts 700—999)
X	Department of Energy (General Provisions) (Parts 1000—1099)
XIII	Nuclear Waste Technical Review Board (Parts 1303—1399)
XVII	Defense Nuclear Facilities Safety Board (Parts 1700—1799)
XVIII	Northeast Interstate Low-Level Radioactive Waste Commission (Parts 1800—1899)

## **Title 11—Federal Elections**

I	Federal Election Commission (Parts 1—9099)
---	--

## **Title 12—Banks and Banking**

I	Comptroller of the Currency, Department of the Treasury (Parts 1—199)
II	Federal Reserve System (Parts 200—299)
III	Federal Deposit Insurance Corporation (Parts 300—399)
IV	Export-Import Bank of the United States (Parts 400—499)

## **Title 12—Banks and Banking—Continued**

- Chap.
- V Office of Thrift Supervision, Department of the Treasury (Parts 500—599)
  - VI Farm Credit Administration (Parts 600—699)
  - VII National Credit Union Administration (Parts 700—799)
  - VIII Federal Financing Bank (Parts 800—899)
  - IX Federal Housing Finance Board (Parts 900—999)
  - XI Federal Financial Institutions Examination Council (Parts 1100—1199)
  - XIV Farm Credit System Insurance Corporation (Parts 1400—1499)
  - XV Department of the Treasury (Parts 1500—1599)
  - XVII Office of Federal Housing Enterprise Oversight, Department of Housing and Urban Development (Parts 1700—1799)
  - XVIII Community Development Financial Institutions Fund, Department of the Treasury (Parts 1800—1899)

## **Title 13—Business Credit and Assistance**

- I Small Business Administration (Parts 1—199)
- III Economic Development Administration, Department of Commerce (Parts 300—399)
- IV Emergency Steel Guarantee Loan Board, Department of Commerce (Parts 400—499)
- V Emergency Oil and Gas Guaranteed Loan Board, Department of Commerce (Parts 500—599)

## **Title 14—Aeronautics and Space**

- I Federal Aviation Administration, Department of Transportation (Parts 1—199)
- II Office of the Secretary, Department of Transportation (Aviation Proceedings) (Parts 200—399)
- III Commercial Space Transportation, Federal Aviation Administration, Department of Transportation (Parts 400—499)
- V National Aeronautics and Space Administration (Parts 1200—1299)
- VI Air Transportation System Stabilization (Parts 1300—1399)

## **Title 15—Commerce and Foreign Trade**

SUBTITLE A—OFFICE OF THE SECRETARY OF COMMERCE (PARTS 0—29)

SUBTITLE B—REGULATIONS RELATING TO COMMERCE AND FOREIGN TRADE

- I Bureau of the Census, Department of Commerce (Parts 30—199)
- II National Institute of Standards and Technology, Department of Commerce (Parts 200—299)
- III International Trade Administration, Department of Commerce (Parts 300—399)

## **Title 15—Commerce and Foreign Trade—Continued**

Chap.

- IV Foreign-Trade Zones Board, Department of Commerce (Parts 400—499)
- VII Bureau of Industry and Security, Department of Commerce (Parts 700—799)
- VIII Bureau of Economic Analysis, Department of Commerce (Parts 800—899)
- IX National Oceanic and Atmospheric Administration, Department of Commerce (Parts 900—999)
- XI Technology Administration, Department of Commerce (Parts 1100—1199)
- XIII East-West Foreign Trade Board (Parts 1300—1399)
- XIV Minority Business Development Agency (Parts 1400—1499)  
SUBTITLE C—REGULATIONS RELATING TO FOREIGN TRADE AGREEMENTS
- XX Office of the United States Trade Representative (Parts 2000—2099)  
SUBTITLE D—REGULATIONS RELATING TO TELECOMMUNICATIONS AND INFORMATION
- XXIII National Telecommunications and Information Administration, Department of Commerce (Parts 2300—2399)

## **Title 16—Commercial Practices**

- I Federal Trade Commission (Parts 0—999)
- II Consumer Product Safety Commission (Parts 1000—1799)

## **Title 17—Commodity and Securities Exchanges**

- I Commodity Futures Trading Commission (Parts 1—199)
- II Securities and Exchange Commission (Parts 200—399)
- IV Department of the Treasury (Parts 400—499)

## **Title 18—Conservation of Power and Water Resources**

- I Federal Energy Regulatory Commission, Department of Energy (Parts 1—399)
- III Delaware River Basin Commission (Parts 400—499)
- VI Water Resources Council (Parts 700—799)
- VIII Susquehanna River Basin Commission (Parts 800—899)
- XIII Tennessee Valley Authority (Parts 1300—1399)

## **Title 19—Customs Duties**

- I Bureau of Customs and Border Protection, Department of Homeland Security; Department of the Treasury (Parts 0—199)
- II United States International Trade Commission (Parts 200—299)
- III International Trade Administration, Department of Commerce (Parts 300—399)

## **Title 19—Customs Duties—Continued**

Chap.

- IV Bureau of Immigration and Customs Enforcement, Department of Homeland Security (Parts 400—599)

## **Title 20—Employees' Benefits**

- I Office of Workers' Compensation Programs, Department of Labor (Parts 1—199)
- II Railroad Retirement Board (Parts 200—399)
- III Social Security Administration (Parts 400—499)
- IV Employees Compensation Appeals Board, Department of Labor (Parts 500—599)
- V Employment and Training Administration, Department of Labor (Parts 600—699)
- VI Employment Standards Administration, Department of Labor (Parts 700—799)
- VII Benefits Review Board, Department of Labor (Parts 800—899)
- VIII Joint Board for the Enrollment of Actuaries (Parts 900—999)
- IX Office of the Assistant Secretary for Veterans' Employment and Training Service, Department of Labor (Parts 1000—1099)

## **Title 21—Food and Drugs**

- I Food and Drug Administration, Department of Health and Human Services (Parts 1—1299)
- II Drug Enforcement Administration, Department of Justice (Parts 1300—1399)
- III Office of National Drug Control Policy (Parts 1400—1499)

## **Title 22—Foreign Relations**

- I Department of State (Parts 1—199)
- II Agency for International Development (Parts 200—299)
- III Peace Corps (Parts 300—399)
- IV International Joint Commission, United States and Canada (Parts 400—499)
- V Broadcasting Board of Governors (Parts 500—599)
- VII Overseas Private Investment Corporation (Parts 700—799)
- IX Foreign Service Grievance Board (Parts 900—999)
- X Inter-American Foundation (Parts 1000—1099)
- XI International Boundary and Water Commission, United States and Mexico, United States Section (Parts 1100—1199)
- XII United States International Development Cooperation Agency (Parts 1200—1299)
- XIII Millenium Challenge Corporation (Parts 1300—1399)
- XIV Foreign Service Labor Relations Board; Federal Labor Relations Authority; General Counsel of the Federal Labor Relations Authority; and the Foreign Service Impasse Disputes Panel (Parts 1400—1499)

## **Title 22—Foreign Relations—Continued**

Chap.

- XV African Development Foundation (Parts 1500—1599)
- XVI Japan-United States Friendship Commission (Parts 1600—1699)
- XVII United States Institute of Peace (Parts 1700—1799)

## **Title 23—Highways**

- I Federal Highway Administration, Department of Transportation (Parts 1—999)
- II National Highway Traffic Safety Administration and Federal Highway Administration, Department of Transportation (Parts 1200—1299)
- III National Highway Traffic Safety Administration, Department of Transportation (Parts 1300—1399)

## **Title 24—Housing and Urban Development**

SUBTITLE A—OFFICE OF THE SECRETARY, DEPARTMENT OF HOUSING AND URBAN DEVELOPMENT (PARTS 0—99)

SUBTITLE B—REGULATIONS RELATING TO HOUSING AND URBAN DEVELOPMENT

- I Office of Assistant Secretary for Equal Opportunity, Department of Housing and Urban Development (Parts 100—199)
- II Office of Assistant Secretary for Housing-Federal Housing Commissioner, Department of Housing and Urban Development (Parts 200—299)
- III Government National Mortgage Association, Department of Housing and Urban Development (Parts 300—399)
- IV Office of Housing and Office of Multifamily Housing Assistance Restructuring, Department of Housing and Urban Development (Parts 400—499)
- V Office of Assistant Secretary for Community Planning and Development, Department of Housing and Urban Development (Parts 500—599)
- VI Office of Assistant Secretary for Community Planning and Development, Department of Housing and Urban Development (Parts 600—699) [Reserved]
- VII Office of the Secretary, Department of Housing and Urban Development (Housing Assistance Programs and Public and Indian Housing Programs) (Parts 700—799)
- VIII Office of the Assistant Secretary for Housing—Federal Housing Commissioner, Department of Housing and Urban Development (Section 8 Housing Assistance Programs, Section 202 Direct Loan Program, Section 202 Supportive Housing for the Elderly Program and Section 811 Supportive Housing for Persons With Disabilities Program) (Parts 800—899)
- IX Office of Assistant Secretary for Public and Indian Housing, Department of Housing and Urban Development (Parts 900—1699)
- X Office of Assistant Secretary for Housing—Federal Housing Commissioner, Department of Housing and Urban Development (Interstate Land Sales Registration Program) (Parts 1700—1799)

## **Title 24—Housing and Urban Development—Continued**

Chap.

- XII Office of Inspector General, Department of Housing and Urban Development (Parts 2000—2099)
- XX Office of Assistant Secretary for Housing—Federal Housing Commissioner, Department of Housing and Urban Development (Parts 3200—3899)
- XXV Neighborhood Reinvestment Corporation (Parts 4100—4199)

## **Title 25—Indians**

- I Bureau of Indian Affairs, Department of the Interior (Parts 1—299)
- II Indian Arts and Crafts Board, Department of the Interior (Parts 300—399)
- III National Indian Gaming Commission, Department of the Interior (Parts 500—599)
- IV Office of Navajo and Hopi Indian Relocation (Parts 700—799)
- V Bureau of Indian Affairs, Department of the Interior, and Indian Health Service, Department of Health and Human Services (Part 900)
- VI Office of the Assistant Secretary-Indian Affairs, Department of the Interior (Parts 1000—1199)
- VII Office of the Special Trustee for American Indians, Department of the Interior (Parts 1200—1299)

## **Title 26—Internal Revenue**

- I Internal Revenue Service, Department of the Treasury (Parts 1—899)

## **Title 27—Alcohol, Tobacco Products and Firearms**

- I Alcohol and Tobacco Tax and Trade Bureau, Department of the Treasury (Parts 1—399)
- II Bureau of Alcohol, Tobacco, Firearms, and Explosives, Department of Justice (Parts 400—699)

## **Title 28—Judicial Administration**

- I Department of Justice (Parts 0—299)
- III Federal Prison Industries, Inc., Department of Justice (Parts 300—399)
- V Bureau of Prisons, Department of Justice (Parts 500—599)
- VI Offices of Independent Counsel, Department of Justice (Parts 600—699)
- VII Office of Independent Counsel (Parts 700—799)
- VIII Court Services and Offender Supervision Agency for the District of Columbia (Parts 800—899)
- IX National Crime Prevention and Privacy Compact Council (Parts 900—999)

## **Title 28—Judicial Administration—Continued**

Chap.

- XI Department of Justice and Department of State (Parts 1100—1199)

## **Title 29—Labor**

SUBTITLE A—OFFICE OF THE SECRETARY OF LABOR (PARTS 0—99)

SUBTITLE B—REGULATIONS RELATING TO LABOR

- I National Labor Relations Board (Parts 100—199)
- II Office of Labor-Management Standards, Department of Labor (Parts 200—299)
- III National Railroad Adjustment Board (Parts 300—399)
- IV Office of Labor-Management Standards, Department of Labor (Parts 400—499)
- V Wage and Hour Division, Department of Labor (Parts 500—899)
- IX Construction Industry Collective Bargaining Commission (Parts 900—999)
- X National Mediation Board (Parts 1200—1299)
- XII Federal Mediation and Conciliation Service (Parts 1400—1499)
- XIV Equal Employment Opportunity Commission (Parts 1600—1699)
- XVII Occupational Safety and Health Administration, Department of Labor (Parts 1900—1999)
- XX Occupational Safety and Health Review Commission (Parts 2200—2499)
- XXV Employee Benefits Security Administration, Department of Labor (Parts 2500—2599)
- XXVII Federal Mine Safety and Health Review Commission (Parts 2700—2799)
- XL Pension Benefit Guaranty Corporation (Parts 4000—4999)

## **Title 30—Mineral Resources**

- I Mine Safety and Health Administration, Department of Labor (Parts 1—199)
- II Minerals Management Service, Department of the Interior (Parts 200—299)
- III Board of Surface Mining and Reclamation Appeals, Department of the Interior (Parts 300—399)
- IV Geological Survey, Department of the Interior (Parts 400—499)
- VII Office of Surface Mining Reclamation and Enforcement, Department of the Interior (Parts 700—999)

## **Title 31—Money and Finance: Treasury**

SUBTITLE A—OFFICE OF THE SECRETARY OF THE TREASURY (PARTS 0—50)

SUBTITLE B—REGULATIONS RELATING TO MONEY AND FINANCE

- I Monetary Offices, Department of the Treasury (Parts 51—199)
- II Fiscal Service, Department of the Treasury (Parts 200—399)

## **Title 31—Money and Finance: Treasury—Continued**

Chap.

- IV Secret Service, Department of the Treasury (Parts 400—499)
- V Office of Foreign Assets Control, Department of the Treasury (Parts 500—599)
- VI Bureau of Engraving and Printing, Department of the Treasury (Parts 600—699)
- VII Federal Law Enforcement Training Center, Department of the Treasury (Parts 700—799)
- VIII Office of International Investment, Department of the Treasury (Parts 800—899)
- IX Federal Claims Collection Standards (Department of the Treasury—Department of Justice) (Parts 900—999)

## **Title 32—National Defense**

### SUBTITLE A—DEPARTMENT OF DEFENSE

- I Office of the Secretary of Defense (Parts 1—399)
  - V Department of the Army (Parts 400—699)
  - VI Department of the Navy (Parts 700—799)
  - VII Department of the Air Force (Parts 800—1099)
- ### SUBTITLE B—OTHER REGULATIONS RELATING TO NATIONAL DEFENSE
- XII Defense Logistics Agency (Parts 1200—1299)
  - XVI Selective Service System (Parts 1600—1699)
  - XVII Office of the Director of National Intelligence (Parts 1700—1799)
  - XXVIII National Counterintelligence Center (Parts 1800—1899)
  - XIX Central Intelligence Agency (Parts 1900—1999)
  - XX Information Security Oversight Office, National Archives and Records Administration (Parts 2000—2099)
  - XXI National Security Council (Parts 2100—2199)
  - XXIV Office of Science and Technology Policy (Parts 2400—2499)
  - XXVII Office for Micronesian Status Negotiations (Parts 2700—2799)
  - XXVIII Office of the Vice President of the United States (Parts 2800—2899)

## **Title 33—Navigation and Navigable Waters**

- I Coast Guard, Department of Homeland Security (Parts 1—199)
- II Corps of Engineers, Department of the Army (Parts 200—399)
- IV Saint Lawrence Seaway Development Corporation, Department of Transportation (Parts 400—499)

## **Title 34—Education**

### SUBTITLE A—OFFICE OF THE SECRETARY, DEPARTMENT OF EDUCATION (PARTS 1—99)

### SUBTITLE B—REGULATIONS OF THE OFFICES OF THE DEPARTMENT OF EDUCATION

- I Office for Civil Rights, Department of Education (Parts 100—199)

## **Title 34—Education—Continued**

Chap.

- II Office of Elementary and Secondary Education, Department of Education (Parts 200—299)
- III Office of Special Education and Rehabilitative Services, Department of Education (Parts 300—399)
- IV Office of Vocational and Adult Education, Department of Education (Parts 400—499)
- V Office of Bilingual Education and Minority Languages Affairs, Department of Education (Parts 500—599)
- VI Office of Postsecondary Education, Department of Education (Parts 600—699)
- XI National Institute for Literacy (Parts 1100—1199)  
SUBTITLE C—REGULATIONS RELATING TO EDUCATION
- XII National Council on Disability (Parts 1200—1299)

## **Title 35 [Reserved]**

## **Title 36—Parks, Forests, and Public Property**

- I National Park Service, Department of the Interior (Parts 1—199)
- II Forest Service, Department of Agriculture (Parts 200—299)
- III Corps of Engineers, Department of the Army (Parts 300—399)
- IV American Battle Monuments Commission (Parts 400—499)
- V Smithsonian Institution (Parts 500—599)
- VII Library of Congress (Parts 700—799)
- VIII Advisory Council on Historic Preservation (Parts 800—899)
- IX Pennsylvania Avenue Development Corporation (Parts 900—999)
- X Presidio Trust (Parts 1000—1099)
- XI Architectural and Transportation Barriers Compliance Board (Parts 1100—1199)
- XII National Archives and Records Administration (Parts 1200—1299)
- XV Oklahoma City National Memorial Trust (Parts 1500—1599)
- XVI Morris K. Udall Scholarship and Excellence in National Environmental Policy Foundation (Parts 1600—1699)

## **Title 37—Patents, Trademarks, and Copyrights**

- I United States Patent and Trademark Office, Department of Commerce (Parts 1—199)
- II Copyright Office, Library of Congress (Parts 200—299)
- III Copyright Royalty Board, Library of Congress (Parts 301—399)
- IV Assistant Secretary for Technology Policy, Department of Commerce (Parts 400—499)
- V Under Secretary for Technology, Department of Commerce (Parts 500—599)

## **Title 38—Pensions, Bonuses, and Veterans' Relief**

- I Department of Veterans Affairs (Parts 0—99)

## **Title 39—Postal Service**

Chap.

- I United States Postal Service (Parts 1—999)
- III Postal Regulatory Commission (Parts 3000—3099)

## **Title 40—Protection of Environment**

- I Environmental Protection Agency (Parts 1—1099)
- IV Environmental Protection Agency and Department of Justice (Parts 1400—1499)
- V Council on Environmental Quality (Parts 1500—1599)
- VI Chemical Safety and Hazard Investigation Board (Parts 1600—1699)
- VII Environmental Protection Agency and Department of Defense; Uniform National Discharge Standards for Vessels of the Armed Forces (Parts 1700—1799)

## **Title 41—Public Contracts and Property Management**

### SUBTITLE B—OTHER PROVISIONS RELATING TO PUBLIC CONTRACTS

- 50 Public Contracts, Department of Labor (Parts 50-1—50-999)
- 51 Committee for Purchase From People Who Are Blind or Severely Disabled (Parts 51-1—51-99)
- 60 Office of Federal Contract Compliance Programs, Equal Employment Opportunity, Department of Labor (Parts 60-1—60-999)
- 61 Office of the Assistant Secretary for Veterans' Employment and Training Service, Department of Labor (Parts 61-1—61-999)

### SUBTITLE C—FEDERAL PROPERTY MANAGEMENT REGULATIONS SYSTEM

- 101 Federal Property Management Regulations (Parts 101-1—101-99)
- 102 Federal Management Regulation (Parts 102-1—102-299)
- 105 General Services Administration (Parts 105-1—105-999)
- 109 Department of Energy Property Management Regulations (Parts 109-1—109-99)
- 114 Department of the Interior (Parts 114-1—114-99)
- 115 Environmental Protection Agency (Parts 115-1—115-99)
- 128 Department of Justice (Parts 128-1—128-99)

### SUBTITLE D—OTHER PROVISIONS RELATING TO PROPERTY MANAGEMENT [RESERVED]

### SUBTITLE E—FEDERAL INFORMATION RESOURCES MANAGEMENT REGULATIONS SYSTEM

### SUBTITLE F—FEDERAL TRAVEL REGULATION SYSTEM

- 300 General (Parts 300-1—300-99)
- 301 Temporary Duty (TDY) Travel Allowances (Parts 301-1—301-99)
- 302 Relocation Allowances (Parts 302-1—302-99)
- 303 Payment of Expenses Connected with the Death of Certain Employees (Part 303-1—303-99)
- 304 Payment of Travel Expenses from a Non-Federal Source (Parts 304-1—304-99)

## **Title 42—Public Health**

Chap.

- I Public Health Service, Department of Health and Human Services (Parts 1—199)
- IV Centers for Medicare & Medicaid Services, Department of Health and Human Services (Parts 400—499)
- V Office of Inspector General-Health Care, Department of Health and Human Services (Parts 1000—1999)

## **Title 43—Public Lands: Interior**

SUBTITLE A—OFFICE OF THE SECRETARY OF THE INTERIOR (PARTS 1—199)

SUBTITLE B—REGULATIONS RELATING TO PUBLIC LANDS

- I Bureau of Reclamation, Department of the Interior (Parts 200—499)
- II Bureau of Land Management, Department of the Interior (Parts 1000—9999)
- III Utah Reclamation Mitigation and Conservation Commission (Parts 10000—10010)

## **Title 44—Emergency Management and Assistance**

- I Federal Emergency Management Agency, Department of Homeland Security (Parts 0—399)
- IV Department of Commerce and Department of Transportation (Parts 400—499)

## **Title 45—Public Welfare**

SUBTITLE A—DEPARTMENT OF HEALTH AND HUMAN SERVICES (PARTS 1—199)

SUBTITLE B—REGULATIONS RELATING TO PUBLIC WELFARE

- II Office of Family Assistance (Assistance Programs), Administration for Children and Families, Department of Health and Human Services (Parts 200—299)
- III Office of Child Support Enforcement (Child Support Enforcement Program), Administration for Children and Families, Department of Health and Human Services (Parts 300—399)
- IV Office of Refugee Resettlement, Administration for Children and Families, Department of Health and Human Services (Parts 400—499)
- V Foreign Claims Settlement Commission of the United States, Department of Justice (Parts 500—599)
- VI National Science Foundation (Parts 600—699)
- VII Commission on Civil Rights (Parts 700—799)
- VIII Office of Personnel Management (Parts 800—899)
- X Office of Community Services, Administration for Children and Families, Department of Health and Human Services (Parts 1000—1099)
- XI National Foundation on the Arts and the Humanities (Parts 1100—1199)

## **Title 45—Public Welfare—Continued**

Chap.	
XII	Corporation for National and Community Service (Parts 1200—1299)
XIII	Office of Human Development Services, Department of Health and Human Services (Parts 1300—1399)
XVI	Legal Services Corporation (Parts 1600—1699)
XVII	National Commission on Libraries and Information Science (Parts 1700—1799)
XVIII	Harry S. Truman Scholarship Foundation (Parts 1800—1899)
XXI	Commission on Fine Arts (Parts 2100—2199)
XXIII	Arctic Research Commission (Part 2301)
XXIV	James Madison Memorial Fellowship Foundation (Parts 2400—2499)
XXV	Corporation for National and Community Service (Parts 2500—2599)

## **Title 46—Shipping**

I	Coast Guard, Department of Homeland Security (Parts 1—199)
II	Maritime Administration, Department of Transportation (Parts 200—399)
III	Coast Guard (Great Lakes Pilotage), Department of Homeland Security (Parts 400—499)
IV	Federal Maritime Commission (Parts 500—599)

## **Title 47—Telecommunication**

I	Federal Communications Commission (Parts 0—199)
II	Office of Science and Technology Policy and National Security Council (Parts 200—299)
III	National Telecommunications and Information Administration, Department of Commerce (Parts 300—399)

## **Title 48—Federal Acquisition Regulations System**

1	Federal Acquisition Regulation (Parts 1—99)
2	Defense Acquisition Regulations System, Department of Defense (Parts 200—299)
3	Department of Health and Human Services (Parts 300—399)
4	Department of Agriculture (Parts 400—499)
5	General Services Administration (Parts 500—599)
6	Department of State (Parts 600—699)
7	Agency for International Development (Parts 700—799)
8	Department of Veterans Affairs (Parts 800—899)
9	Department of Energy (Parts 900—999)
10	Department of the Treasury (Parts 1000—1099)
12	Department of Transportation (Parts 1200—1299)
13	Department of Commerce (Parts 1300—1399)
14	Department of the Interior (Parts 1400—1499)

## **Title 48—Federal Acquisition Regulations System—Continued**

Chap.

- 15 Environmental Protection Agency (Parts 1500—1599)
- 16 Office of Personnel Management, Federal Employees Health Benefits Acquisition Regulation (Parts 1600—1699)
- 17 Office of Personnel Management (Parts 1700—1799)
- 18 National Aeronautics and Space Administration (Parts 1800—1899)
- 19 Broadcasting Board of Governors (Parts 1900—1999)
- 20 Nuclear Regulatory Commission (Parts 2000—2099)
- 21 Office of Personnel Management, Federal Employees Group Life Insurance Federal Acquisition Regulation (Parts 2100—2199)
- 23 Social Security Administration (Parts 2300—2399)
- 24 Department of Housing and Urban Development (Parts 2400—2499)
- 25 National Science Foundation (Parts 2500—2599)
- 28 Department of Justice (Parts 2800—2899)
- 29 Department of Labor (Parts 2900—2999)
- 30 Department of Homeland Security, Homeland Security Acquisition Regulation (HSAR) (Parts 3000—3099)
- 34 Department of Education Acquisition Regulation (Parts 3400—3499)
- 51 Department of the Army Acquisition Regulations (Parts 5100—5199)
- 52 Department of the Navy Acquisition Regulations (Parts 5200—5299)
- 53 Department of the Air Force Federal Acquisition Regulation Supplement [RESERVED]
- 54 Defense Logistics Agency, Department of Defense (Parts 5400—5499)
- 57 African Development Foundation (Parts 5700—5799)
- 61 General Services Administration Board of Contract Appeals (Parts 6100—6199)
- 63 Department of Transportation Board of Contract Appeals (Parts 6300—6399)
- 99 Cost Accounting Standards Board, Office of Federal Procurement Policy, Office of Management and Budget (Parts 9900—9999)

## **Title 49—Transportation**

SUBTITLE A—OFFICE OF THE SECRETARY OF TRANSPORTATION  
(PARTS 1—99)

SUBTITLE B—OTHER REGULATIONS RELATING TO TRANSPORTATION

- I Pipeline and Hazardous Materials Safety Administration, Department of Transportation (Parts 100—199)
- II Federal Railroad Administration, Department of Transportation (Parts 200—299)
- III Federal Motor Carrier Safety Administration, Department of Transportation (Parts 300—399)
- IV Coast Guard, Department of Homeland Security (Parts 400—499)

## **Title 49—Transportation—Continued**

Chap.

- V National Highway Traffic Safety Administration, Department of Transportation (Parts 500—599)
- VI Federal Transit Administration, Department of Transportation (Parts 600—699)
- VII National Railroad Passenger Corporation (AMTRAK) (Parts 700—799)
- VIII National Transportation Safety Board (Parts 800—999)
- X Surface Transportation Board, Department of Transportation (Parts 1000—1399)
- XI Research and Innovative Technology Administration, Department of Transportation [RESERVED]
- XII Transportation Security Administration, Department of Homeland Security (Parts 1500—1699)

## **Title 50—Wildlife and Fisheries**

- I United States Fish and Wildlife Service, Department of the Interior (Parts 1—199)
- II National Marine Fisheries Service, National Oceanic and Atmospheric Administration, Department of Commerce (Parts 200—299)
- III International Fishing and Related Activities (Parts 300—399)
- IV Joint Regulations (United States Fish and Wildlife Service, Department of the Interior and National Marine Fisheries Service, National Oceanic and Atmospheric Administration, Department of Commerce); Endangered Species Committee Regulations (Parts 400—499)
- V Marine Mammal Commission (Parts 500—599)
- VI Fishery Conservation and Management, National Oceanic and Atmospheric Administration, Department of Commerce (Parts 600—699)

## **CFR Index and Finding Aids**

Subject/Agency Index

List of Agency Prepared Indexes

Parallel Tables of Statutory Authorities and Rules

List of CFR Titles, Chapters, Subchapters, and Parts

Alphabetical List of Agencies Appearing in the CFR

## Alphabetical List of Agencies Appearing in the CFR

(Revised as of January 1, 2008)

Agency	CFR Title, Subtitle or Chapter
Administrative Committee of the Federal Register	1, I
Advanced Research Projects Agency	32, I
Advisory Council on Historic Preservation	36, VIII
African Development Foundation	22, XV
Federal Acquisition Regulation	48, 57
Agency for International Development	22, II
Federal Acquisition Regulation	48, 7
Agricultural Marketing Service	7, I, IX, X, XI
Agricultural Research Service	7, V
Agriculture Department	5, LXXXIII
Agricultural Marketing Service	7, I, IX, X, XI
Agricultural Research Service	7, V
Animal and Plant Health Inspection Service	7, III; 9, I
Chief Financial Officer, Office of	7, XXX
Commodity Credit Corporation	7, XIV
Cooperative State Research, Education, and Extension Service	7, XXXIV
Economic Research Service	7, XXXVII
Energy, Office of	2, IX; 7, XXIX
Environmental Quality, Office of	7, XXXI
Farm Service Agency	7, VII, XVIII
Federal Acquisition Regulation	48, 4
Federal Crop Insurance Corporation	7, IV
Food and Nutrition Service	7, II
Food Safety and Inspection Service	9, III
Foreign Agricultural Service	7, XV
Forest Service	36, II
Grain Inspection, Packers and Stockyards Administration	7, VIII; 9, II
Information Resources Management, Office of	7, XXVII
Inspector General, Office of	7, XXVI
National Agricultural Library	7, XLI
National Agricultural Statistics Service	7, XXXVI
Natural Resources Conservation Service	7, VI
Operations, Office of	7, XXVIII
Procurement and Property Management, Office of	7, XXXII
Rural Business-Cooperative Service	7, XVIII, XLII
Rural Development Administration	7, XLII
Rural Housing Service	7, XVIII, XXXV
Rural Telephone Bank	7, XVI
Rural Utilities Service	7, XVII, XVIII, XLII
Secretary of Agriculture, Office of	7, Subtitle A
Transportation, Office of	7, XXXIII
World Agricultural Outlook Board	7, XXXVIII
Air Force Department	32, VII
Federal Acquisition Regulation Supplement	48, 53
Air Transportation Stabilization Board	14, VI
Alcohol and Tobacco Tax and Trade Bureau	27, I
Alcohol, Tobacco, Firearms, and Explosives, Bureau of	27, II
AMTRAK	49, VII
American Battle Monuments Commission	36, IV
American Indians, Office of the Special Trustee	25, VII
Animal and Plant Health Inspection Service	7, III; 9, I
Appalachian Regional Commission	5, IX

Agency	CFR Title, Subtitle or Chapter
Architectural and Transportation Barriers Compliance Board	36, XI
Arctic Research Commission	45, XXIII
Armed Forces Retirement Home	5, XI
Army Department	32, V
Engineers, Corps of	33, II; 36, III
Federal Acquisition Regulation	48, 51
Benefits Review Board	20, VII
Bilingual Education and Minority Languages Affairs, Office of	34, V
Blind or Severely Disabled, Committee for Purchase From People Who Are	41, 51
Broadcasting Board of Governors	22, V
Federal Acquisition Regulation	48, 19
Census Bureau	15, I
Centers for Medicare & Medicaid Services	42, IV
Central Intelligence Agency	32, XIX
Chief Financial Officer, Office of	7, XXX
Child Support Enforcement, Office of	45, III
Children and Families, Administration for	45, II, III, IV, X
Civil Rights, Commission on	45, VII
Civil Rights, Office for	34, I
Coast Guard	33, I; 46, I; 49, IV
Coast Guard (Great Lakes Pilotage)	46, III
Commerce Department	44, IV
Census Bureau	15, I
Economic Affairs, Under Secretary	37, V
Economic Analysis, Bureau of	15, VIII
Economic Development Administration	13, III
Emergency Management and Assistance	44, IV
Federal Acquisition Regulation	48, 13
Fishery Conservation and Management	50, VI
Foreign-Trade Zones Board	15, IV
Industry and Security, Bureau of	15, VII
International Trade Administration	15, III; 19, III
National Institute of Standards and Technology	15, II
National Marine Fisheries Service	50, II, IV, VI
National Oceanic and Atmospheric Administration	15, IX; 50, II, III, IV, VI
National Telecommunications and Information Administration	15, XXIII; 47, III
National Weather Service	15, IX
Patent and Trademark Office, United States	37, I
Productivity, Technology and Innovation, Assistant Secretary for	37, IV
Secretary of Commerce, Office of	15, Subtitle A
Technology, Under Secretary for	37, V
Technology Administration	15, XI
Technology Policy, Assistant Secretary for	37, IV
Commercial Space Transportation	14, III
Commodity Credit Corporation	7, XIV
Commodity Futures Trading Commission	5, XLI; 17, I
Community Planning and Development, Office of Assistant Secretary for	24, V, VI
Community Services, Office of	45, X
Comptroller of the Currency	12, I
Construction Industry Collective Bargaining Commission	29, IX
Consumer Product Safety Commission	5, LXXI; 16, II
Cooperative State Research, Education, and Extension Service	7, XXXIV
Copyright Office	37, II
Copyright Royalty Board	37, III
Corporation for National and Community Service	2, XXII; 45, XII, XXV
Cost Accounting Standards Board	48, 99
Council on Environmental Quality	40, V
Court Services and Offender Supervision Agency for the District of Columbia	28, VIII
Customs and Border Protection Bureau	19, I
Defense Contract Audit Agency	32, I
Defense Department	5, XXVI; 32, Subtitle A; 40, VII

Agency	CFR Title, Subtitle or Chapter
Advanced Research Projects Agency	32, I
Air Force Department	32, VII
Army Department	32, V; 33, II; 36, III, 48, 51
Defense Acquisition Regulations System	48, II
Defense Intelligence Agency	32, I
Defense Logistics Agency	32, I, XII; 48, 54
Engineers, Corps of	33, II; 36, III
National Imagery and Mapping Agency	32, I
Navy Department	32, VI; 48, 52
Secretary of Defense, Office of	2, XI; 32, I
Defense Contract Audit Agency	32, I
Defense Intelligence Agency	32, I
Defense Logistics Agency	32, XII; 48, 54
Defense Nuclear Facilities Safety Board	10, XVII
Delaware River Basin Commission	18, III
District of Columbia, Court Services and Offender Supervision Agency for the	28, VIII
Drug Enforcement Administration	21, II
East-West Foreign Trade Board	15, XIII
Economic Affairs, Under Secretary	37, V
Economic Analysis, Bureau of	15, VIII
Economic Development Administration	13, III
Economic Research Service	7, XXXVII
Education, Department of	5, LIII
Bilingual Education and Minority Languages Affairs, Office of	34, V
Civil Rights, Office for	34, I
Educational Research and Improvement, Office of	34, VII
Elementary and Secondary Education, Office of	34, II
Federal Acquisition Regulation	48, 34
Postsecondary Education, Office of	34, VI
Secretary of Education, Office of	34, Subtitle A
Special Education and Rehabilitative Services, Office of	34, III
Vocational and Adult Education, Office of	34, IV
Educational Research and Improvement, Office of	34, VII
Elementary and Secondary Education, Office of	34, II
Emergency Oil and Gas Guaranteed Loan Board	13, V
Emergency Steel Guarantee Loan Board	13, IV
Employee Benefits Security Administration	29, XXV
Employees' Compensation Appeals Board	20, IV
Employees Loyalty Board	5, V
Employment and Training Administration	20, V
Employment Standards Administration	20, VI
Endangered Species Committee	50, IV
Energy, Department of	5, XXIII; 10, II, III, X
Federal Acquisition Regulation	48, 9
Federal Energy Regulatory Commission	5, XXIV; 18, I
Property Management Regulations	41, 109
Energy, Office of	7, XXIX
Engineers, Corps of	33, II; 36, III
Engraving and Printing, Bureau of	31, VI
Environmental Protection Agency	2, XV; 5, LIV; 40, I, IV, VII
Federal Acquisition Regulation	48, 15
Property Management Regulations	41, 115
Environmental Quality, Office of	7, XXXI
Equal Employment Opportunity Commission	5, LXII; 29, XIV
Equal Opportunity, Office of Assistant Secretary for	24, I
Executive Office of the President	3, I
Administration, Office of	5, XV
Environmental Quality, Council on	40, V
Management and Budget, Office of	5, III, LXXVII; 14, VI; 48, 99
National Drug Control Policy, Office of	21, III
National Security Council	32, XXI; 47, 2
Presidential Documents	3

Agency	CFR Title, Subtitle or Chapter
Science and Technology Policy, Office of	32, XXIV; 47, II
Trade Representative, Office of the United States	15, XX
Export-Import Bank of the United States	2, XXXV; 5, LII; 12, IV
Family Assistance, Office of	45, II
Farm Credit Administration	5, XXXI; 12, VI
Farm Credit System Insurance Corporation	5, XXX; 12, XIV
Farm Service Agency	7, VII, XVIII
Federal Acquisition Regulation	48, 1
Federal Aviation Administration	14, I
Commercial Space Transportation	14, III
Federal Claims Collection Standards	31, IX
Federal Communications Commission	5, XXIX; 47, I
Federal Contract Compliance Programs, Office of	41, 60
Federal Crop Insurance Corporation	7, IV
Federal Deposit Insurance Corporation	5, XXII; 12, III
Federal Election Commission	11, I
Federal Emergency Management Agency	44, I
Federal Employees Group Life Insurance Federal Acquisition Regulation	48, 21
Federal Employees Health Benefits Acquisition Regulation	48, 16
Federal Energy Regulatory Commission	5, XXIV; 18, I
Federal Financial Institutions Examination Council	12, XI
Federal Financing Bank	12, VIII
Federal Highway Administration	23, I, II
Federal Home Loan Mortgage Corporation	1, IV
Federal Housing Enterprise Oversight Office	12, XXVII
Federal Housing Finance Board	12, IX
Federal Labor Relations Authority, and General Counsel of the Federal Labor Relations Authority	5, XIV; 22, XIV
Federal Law Enforcement Training Center	31, VII
Federal Management Regulation	41, 102
Federal Maritime Commission	46, IV
Federal Mediation and Conciliation Service	29, XII
Federal Mine Safety and Health Review Commission	5, LXXIV; 29, XXVII
Federal Motor Carrier Safety Administration	49, III
Federal Prison Industries, Inc.	28, III
Federal Procurement Policy Office	48, 99
Federal Property Management Regulations	41, 101
Federal Railroad Administration	49, II
Federal Register, Administrative Committee of	1, I
Federal Register, Office of	1, II
Federal Reserve System	12, II
Board of Governors	5, LVIII
Federal Retirement Thrift Investment Board	5, VI, LXXXVI
Federal Service Impasses Panel	5, XIV
Federal Trade Commission	5, XLVII; 16, I
Federal Transit Administration	49, VI
Federal Travel Regulation System	41, Subtitle F
Fine Arts, Commission on	45, XXI
Fiscal Service	31, II
Fish and Wildlife Service, United States	50, I, IV
Fishery Conservation and Management	50, VI
Food and Drug Administration	21, I
Food and Nutrition Service	7, II
Food Safety and Inspection Service	9, III
Foreign Agricultural Service	7, XV
Foreign Assets Control, Office of	31, V
Foreign Claims Settlement Commission of the United States	45, V
Foreign Service Grievance Board	22, IX
Foreign Service Impasse Disputes Panel	22, XIV
Foreign Service Labor Relations Board	22, XIV
Foreign-Trade Zones Board	15, IV
Forest Service	36, II
General Services Administration	5, LVII; 41, 105
Contract Appeals, Board of	48, 61
Federal Acquisition Regulation	48, 5
Federal Management Regulation	41, 102

Agency	CFR Title, Subtitle or Chapter
Federal Property Management Regulations	41, 101
Federal Travel Regulation System	41, Subtitle F
General	41, 300
Payment From a Non-Federal Source for Travel Expenses	41, 304
Payment of Expenses Connected With the Death of Certain Employees	41, 303
Relocation Allowances	41, 302
Temporary Duty (TDY) Travel Allowances	41, 301
Geological Survey	30, IV
Government Accountability Office	4, I
Government Ethics, Office of	5, XVI
Government National Mortgage Association	24, III
Grain Inspection, Packers and Stockyards Administration	7, VIII; 9, II
Harry S. Truman Scholarship Foundation	45, XVIII
Health and Human Services, Department of	2, III; 5, XLV; 45, Subtitle A,
Centers for Medicare & Medicaid Services	42, IV
Child Support Enforcement, Office of	45, III
Children and Families, Administration for	45, II, III, IV, X
Community Services, Office of	45, X
Family Assistance, Office of	45, II
Federal Acquisition Regulation	48, 3
Food and Drug Administration	21, I
Human Development Services, Office of	45, XIII
Indian Health Service	25, V
Inspector General (Health Care), Office of	42, V
Public Health Service	42, I
Refugee Resettlement, Office of	45, IV
Homeland Security, Department of	6, I
Coast Guard	33, I; 46, I; 49, IV
Coast Guard (Great Lakes Pilotage)	46, III
Customs and Border Protection Bureau	19, I
Federal Emergency Management Agency	44, I
Immigration and Customs Enforcement Bureau	19, IV
Immigration and Naturalization	8, I
Transportation Security Administration	49, XII
Housing and Urban Development, Department of	5, LXXV; 24, Subtitle B, 2, XXIV; 2424
Community Planning and Development, Office of Assistant Secretary for	24, V, VI
Equal Opportunity, Office of Assistant Secretary for	24, I
Federal Acquisition Regulation	48, 24
Federal Housing Enterprise Oversight, Office of	12, XVII
Government National Mortgage Association	24, III
Housing—Federal Housing Commissioner, Office of Assistant Secretary for	24, II, VIII, X, XX
Housing, Office of, and Multifamily Housing Assistance Restructuring, Office of	24, IV
Inspector General, Office of	24, XII
Public and Indian Housing, Office of Assistant Secretary for Secretary, Office of	24, IX 24, Subtitle A, VII
Housing—Federal Housing Commissioner, Office of Assistant Secretary for	24, II, VIII, X, XX
Housing, Office of, and Multifamily Housing Assistance Restructuring, Office of	24, IV
Human Development Services, Office of	45, XIII
Immigration and Customs Enforcement Bureau	19, IV
Immigration and Naturalization	8, I
Immigration Review, Executive Office for	8, V
Independent Counsel, Office of	28, VII
Indian Affairs, Bureau of	25, I, V
Indian Affairs, Office of the Assistant Secretary	25, VI
Indian Arts and Crafts Board	25, II
Indian Health Service	25, V
Industry and Security, Bureau of	15, VII
Information Resources Management, Office of	7, XXVII
Information Security Oversight Office, National Archives and Records Administration	32, XX

Agency	CFR Title, Subtitle or Chapter
Inspector General	
Agriculture Department	7, XXVI
Health and Human Services Department	42, V
Housing and Urban Development Department	24, XII
Institute of Peace, United States	22, XVII
Inter-American Foundation	5, LXIII; 22, X
Interior Department	
American Indians, Office of the Special Trustee	25, VII
Endangered Species Committee	50, IV
Federal Acquisition Regulation	48, 14
Federal Property Management Regulations System	41, 114
Fish and Wildlife Service, United States	50, I, IV
Geological Survey	30, IV
Indian Affairs, Bureau of	25, I, V
Indian Affairs, Office of the Assistant Secretary	25, VI
Indian Arts and Crafts Board	25, II
Land Management, Bureau of	43, II
Minerals Management Service	30, II
National Indian Gaming Commission	25, III
National Park Service	36, I
Reclamation, Bureau of	43, I
Secretary of the Interior, Office of	2, XIV; 43, Subtitle A
Surface Mining and Reclamation Appeals, Board of	30, III
Surface Mining Reclamation and Enforcement, Office of	30, VII
Internal Revenue Service	26, I
International Boundary and Water Commission, United States and Mexico, United States Section	22, XI
International Development, United States Agency for Federal Acquisition Regulation	22, II 48, 7
International Development Cooperation Agency, United States	22, XII
International Fishing and Related Activities	50, III
International Investment, Office of	31, VIII
International Joint Commission, United States and Canada	22, IV
International Organizations Employees Loyalty Board	5, V
International Trade Administration	15, III; 19, III
International Trade Commission, United States	19, II
Interstate Commerce Commission	5, XL
James Madison Memorial Fellowship Foundation	45, XXIV
Japan–United States Friendship Commission	22, XVI
Joint Board for the Enrollment of Actuaries	20, VIII
Justice Department	2, XXVII; 5, XXVIII; 28, I, XI; 40, IV
Alcohol, Tobacco, Firearms, and Explosives, Bureau of	27, II
Drug Enforcement Administration	21, II
Federal Acquisition Regulation	48, 28
Federal Claims Collection Standards	31, IX
Federal Prison Industries, Inc.	28, III
Foreign Claims Settlement Commission of the United States	45, V
Immigration Review, Executive Office for	8, V
Offices of Independent Counsel	28, VI
Prisons, Bureau of	28, V
Property Management Regulations	41, 128
Labor Department	5, XLII
Benefits Review Board	20, VII
Employee Benefits Security Administration	29, XXV
Employees' Compensation Appeals Board	20, IV
Employment and Training Administration	20, V
Employment Standards Administration	20, VI
Federal Acquisition Regulation	48, 29
Federal Contract Compliance Programs, Office of	41, 60
Federal Procurement Regulations System	41, 50
Labor-Management Standards, Office of	29, II, IV
Mine Safety and Health Administration	30, I
Occupational Safety and Health Administration	29, XVII
Public Contracts	41, 50

Agency	CFR Title, Subtitle or Chapter
Secretary of Labor, Office of	29, Subtitle A
Veterans' Employment and Training Service, Office of the Assistant Secretary for	41, 61; 20, IX
Wage and Hour Division	29, V
Workers' Compensation Programs, Office of	20, I
Labor-Management Standards, Office of	29, II, IV
Land Management, Bureau of	43, II
Legal Services Corporation	45, XVI
Library of Congress	36, VII
Copyright Office	37, II
Copyright Royalty Board	37, III
Local Television Loan Guarantee Board	7, XX
Management and Budget, Office of	5, III, LXXXVII; 14, VI; 48, 99
Marine Mammal Commission	50, V
Maritime Administration	46, II
Merit Systems Protection Board	5, II, LXIV
Micronesian Status Negotiations, Office for	32, XXVII
Millennium Challenge Corporation	22, XIII
Mine Safety and Health Administration	30, I
Minerals Management Service	30, II
Minority Business Development Agency	15, XIV
Miscellaneous Agencies	1, IV
Monetary Offices	31, I
Morris K. Udall Scholarship and Excellence in National Environmental Policy Foundation	36, XVI
National Aeronautics and Space Administration	2, XVIII; 5, LIX; 14, V
Federal Acquisition Regulation	48, 18
National Agricultural Library	7, XLI
National Agricultural Statistics Service	7, XXXVI
National and Community Service, Corporation for	45, XII, XXV
National Archives and Records Administration	2, XXVI; 5, LXVI; 36, XII
Information Security Oversight Office	32, XX
National Capital Planning Commission	1, IV
National Commission for Employment Policy	1, IV
National Commission on Libraries and Information Science	45, XVII
National Council on Disability	34, XII
National Counterintelligence Center	32, XVIII
National Credit Union Administration	12, VII
National Crime Prevention and Privacy Compact Council	28, IX
National Drug Control Policy, Office of	21, III
National Endowment for the Arts	2, XXXII
National Endowment for the Humanities	2, XXXIII
National Foundation on the Arts and the Humanities	45, XI
National Highway Traffic Safety Administration	23, II, III; 49, V
National Imagery and Mapping Agency	32, I
National Indian Gaming Commission	25, III
National Institute for Literacy	34, XI
National Institute of Standards and Technology	15, II
National Intelligence, Office of Director of	32, XVII
National Labor Relations Board	5, LXI; 29, I
National Marine Fisheries Service	50, II, IV, VI
National Mediation Board	29, X
National Oceanic and Atmospheric Administration	15, IX; 50, II, III, IV, VI
National Park Service	36, I
National Railroad Adjustment Board	29, III
National Railroad Passenger Corporation (AMTRAK)	49, VII
National Science Foundation	2, XXV; 5, XLIII; 45, VI
Federal Acquisition Regulation	48, 25
National Security Council	32, XXI
National Security Council and Office of Science and Technology Policy	47, II
National Telecommunications and Information Administration	15, XXIII; 47, III
National Transportation Safety Board	49, VIII
Natural Resources Conservation Service	7, VI

Agency	CFR Title, Subtitle or Chapter
Navajo and Hopi Indian Relocation, Office of	25, IV
Navy Department	32, VI
Federal Acquisition Regulation	48, 52
Neighborhood Reinvestment Corporation	24, XXV
Northeast Interstate Low-Level Radioactive Waste Commission	10, XVIII
Nuclear Regulatory Commission	5, XLVIII; 10, I
Federal Acquisition Regulation	48, 20
Occupational Safety and Health Administration	29, XVII
Occupational Safety and Health Review Commission	29, XX
Offices of Independent Counsel	28, VI
Oklahoma City National Memorial Trust	36, XV
Operations Office	7, XXVIII
Overseas Private Investment Corporation	5, XXXIII; 22, VII
Patent and Trademark Office, United States	37, I
Payment From a Non-Federal Source for Travel Expenses	41, 304
Payment of Expenses Connected With the Death of Certain Employees	41, 303
Peace Corps	22, III
Pennsylvania Avenue Development Corporation	36, IX
Pension Benefit Guaranty Corporation	29, XL
Personnel Management, Office of	5, I, XXXV; 45, VIII
Federal Acquisition Regulation	48, 17
Federal Employees Group Life Insurance Federal Acquisition Regulation	48, 21
Federal Employees Health Benefits Acquisition Regulation	48, 16
Pipeline and Hazardous Materials Safety Administration	49, I
Postal Regulatory Commission	5, XLVI; 39, III
Postal Service, United States	5, LX; 39, I
Postsecondary Education, Office of	34, VI
President's Commission on White House Fellowships	1, IV
Presidential Documents	3
Presidio Trust	36, X
Prisons, Bureau of	28, V
Privacy and Civil Liberties Oversight Board	6, X
Procurement and Property Management, Office of	7, XXXII
Productivity, Technology and Innovation, Assistant Secretary	37, IV
Public Contracts, Department of Labor	41, 50
Public and Indian Housing, Office of Assistant Secretary for	24, IX
Public Health Service	42, I
Railroad Retirement Board	20, II
Reclamation, Bureau of	43, I
Refugee Resettlement, Office of	45, IV
Relocation Allowances	41, 302
Research and Innovative Technology Administration	49, XI
Rural Business-Cooperative Service	7, XVIII, XLII
Rural Development Administration	7, XLII
Rural Housing Service	7, XVIII, XXXV
Rural Telephone Bank	7, XVI
Rural Utilities Service	7, XVII, XVIII, XLII
Saint Lawrence Seaway Development Corporation	33, IV
Science and Technology Policy, Office of	32, XXIV
Science and Technology Policy, Office of, and National Security Council	47, II
Secret Service	31, IV
Securities and Exchange Commission	17, II
Selective Service System	32, XVI
Small Business Administration	2, XXVII; 13, I
Smithsonian Institution	36, V
Social Security Administration	20, III; 48, 23
Soldiers' and Airmen's Home, United States	5, XI
Special Counsel, Office of	5, VIII
Special Education and Rehabilitative Services, Office of	34, III
State Department	2, VI; 22, I; 28, XI
Federal Acquisition Regulation	48, 6
Surface Mining and Reclamation Appeals, Board of	30, III

Agency	CFR Title, Subtitle or Chapter
Surface Mining Reclamation and Enforcement, Office of	30, VII
Surface Transportation Board	49, X
Susquehanna River Basin Commission	18, VIII
Technology Administration	15, XI
Technology Policy, Assistant Secretary for	37, IV
Technology, Under Secretary for	37, V
Tennessee Valley Authority	5, LXIX; 18, XIII
Thrift Supervision Office, Department of the Treasury	12, V
Trade Representative, United States, Office of	15, XX
Transportation, Department of	5, L
Commercial Space Transportation	14, III
Contract Appeals, Board of	48, 63
Emergency Management and Assistance	44, IV
Federal Acquisition Regulation	48, 12
Federal Aviation Administration	14, I
Federal Highway Administration	23, I, II
Federal Motor Carrier Safety Administration	49, III
Federal Railroad Administration	49, II
Federal Transit Administration	49, VI
Maritime Administration	46, II
National Highway Traffic Safety Administration	23, II, III; 49, V
Pipeline and Hazardous Materials Safety Administration	49, I
Saint Lawrence Seaway Development Corporation	33, IV
Secretary of Transportation, Office of	14, II; 49, Subtitle A
Surface Transportation Board	49, X
Transportation Statistics Bureau	49, XI
Transportation, Office of	7, XXXIII
Transportation Security Administration	49, XII
Transportation Statistics Bureau	49, XI
Travel Allowances, Temporary Duty (TDY)	41, 301
Treasury Department	5, XXI; 12, XV; 17, IV;
	31, IX
Alcohol and Tobacco Tax and Trade Bureau	27, I
Community Development Financial Institutions Fund	12, XVIII
Comptroller of the Currency	12, I
Customs and Border Protection Bureau	19, I
Engraving and Printing, Bureau of	31, VI
Federal Acquisition Regulation	48, 10
Federal Claims Collection Standards	31, IX
Federal Law Enforcement Training Center	31, VII
Fiscal Service	31, II
Foreign Assets Control, Office of	31, V
Internal Revenue Service	26, I
International Investment, Office of	31, VIII
Monetary Offices	31, I
Secret Service	31, IV
Secretary of the Treasury, Office of	31, Subtitle A
Thrift Supervision, Office of	12, V
Truman, Harry S. Scholarship Foundation	45, XVIII
United States and Canada, International Joint Commission	22, IV
United States and Mexico, International Boundary and Water Commission, United States Section	22, XI
Utah Reclamation Mitigation and Conservation Commission	43, III
Veterans Affairs Department	2, VIII; 38, I
Federal Acquisition Regulation	48, 8
Veterans' Employment and Training Service, Office of the Assistant Secretary for	41, 61; 20, IX
Vice President of the United States, Office of	32, XXVIII
Vocational and Adult Education, Office of	34, IV
Wage and Hour Division	29, V
Water Resources Council	18, VI
Workers' Compensation Programs, Office of	20, I
World Agricultural Outlook Board	7, XXXVIII



## List of CFR Sections Affected

All changes in this volume of the Code of Federal Regulations that were made by documents published in the FEDERAL REGISTER since January 1, 2001, are enumerated in the following list. Entries indicate the nature of the changes effected. Page numbers refer to FEDERAL REGISTER pages. The user should consult the entries for chapters and parts as well as sections for revisions.

For the period before January 1, 2001, see the "List of CFR Sections Affected, 1949–1963, 1964–1972, 1973–1985, and 1986–2000" published in 11 separate volumes.

	<b>2001</b>		<b>2002</b>
<b>14 CFR</b>	66 FR Page	<b>14 CFR</b>	67 FR Page
Chapter I		Chapter I	
142 SFAR No. 93 added.....	52279	145.63 Regulation at 67 FR 58912 eff. date delayed to 1-16-04.....	78970
142.1 (a) and (b)(1) amended .....	21066	145.79 Regulation at 67 FR 58912 eff. date delayed to 1-16-04.....	78970
145 Comment request.....	59692	183.33 (a) revised; eff. 12-8-03; in- terim.....	72766
145.1–145.5 (Subpart A) Revised; eff. 4-6-03 .....	41117	187 Policy statement .....	42462
145.2 Heading and (a) amended .....	21067	191 Removed .....	8350
145.51–145.61 (Subpart B) Re- vised; eff. 4-6-03.....	41117		
145.63 (c) amended.....	21067		
Regulation at 65 FR 56206 eff. date delayed to 1-16-02.....	21626		
Regulation at 65 FR 56206 eff. date delayed to 1-16-03.....	58912		
145.79 Regulation at 65 FR 56206 eff. date delayed to 1-16-02.....	21626		
Regulation at 65 FR 56206 eff. date delayed to 1-16-03.....	58912		
145.101–145.109 (Subpart C) Re- vised; eff. 4-6-03.....	41117		
145.151–145.163 (Subpart D) Re- vised; eff. in part 4-6-03.....	41117		
145.163 Revised; eff. 4-6-05 .....	41117		
145.201–145.223 (Subpart E) Added; eff. 4-6-03 .....	41117		
145 Appendix A removed; eff. 4-6- 03.....	41117		
161.5 Amended .....	21067		
170.3 Amended .....	21067		
187.1 Amended .....	43717		
187.15 (d) revised .....	43718		
187 Appendix B revised.....	43718		
193 Added .....	33805		
		<b>14 CFR</b>	<b>2003</b> 68 FR Page
		Chapter I	
		142.1 (a), (b)(1), (4) and (5) revised; (b)(6) added; (c) removed .....	54588
		145 SFAR No. 36 amended; eff. 1- 23-04 .....	65378
		Regulation at 66 FR 41117 eff. date delayed to 10-6-03.....	12542
		Regulation at 68 FR 12542 eff. Date corrected to 10-3-03 .....	17546
		Regulation at 66 FR 41117 eff. date delayed to 1-31-04.....	55819
		145.1–145.5 (Subpart A) Regula- tion at 66 FR 41117 eff. date de- layed to 10-6-03 .....	12542
		145.51–145.61 (Subpart B) Regula- tion at 66 FR 41117 eff. date de- layed to 10-6-03 .....	12542
		145.63 Regulation at 65 FR 56206 eff. date delayed to 1-30-06.....	75116
		145.79 Regulation at 65 FR 56206 eff. date delayed to 1-30-06.....	75116

**14 CFR (1-1-08 Edition)**

**14 CFR—Continued** 68 FR  
Page

Chapter I—Continued  
 145.101—145.109 (Subpart C) Regulation at 66 FR 41117 eff. date delayed to 10-6-03.....12542  
 145.151—145.163 (Subpart D) Regulation at 66 FR 41117 eff. date delayed in part to 10-6-03.....12542  
 145.163 Regulation at 66 FR 41117 eff. date delayed to 10-6-05.....12542  
 Regulation at 68 FR 12542 eff. date corrected to 4-6-05 .....17546  
 Regulation at 66 FR 41121 eff. 4-6-05 .....55819  
 145.201—145.223 (Subpart E) Regulation at 66 FR 41117 eff. date delayed to 10-6-03.....12542  
 145.221 (a), (c) and (d) revised; eff. 1-31-04.....75382  
 150 Corrected; CFR correction.....6608  
 183 Comment period extended .....5782, 10368, 10369  
 193 Policy statement .....38594

**2004**

**14 CFR** 69 FR  
Page

Title 14 Nomenclature change .....18803  
 Chapter I  
 142 Technical correction .....6531  
 145 Regulation at 68 FR 65378 confirmed.....5388  
 150.3 Revised .....57625  
 150.5 (a) and (c) revised .....57625  
 150.7 Amended .....57625  
 150.13 (e)(1), (3) introductory text, (ii), (iii), (v), (vi), (vii) and (ix) revised; (e)(3)(xi) added .....57625  
 150.21 (a)(1), (d), (f)(1) introductory text and (2) introductory text revised .....57626  
 150.23 (d) revised .....57626  
 150.35 (f) revised .....57626  
 150 Appendix A amended .....57626  
 Appendix A corrected .....61438  
 158.53 (a) revised .....12948  
 183 Technical correction .....6555

**2005**

**14 CFR** 70 FR  
Page

Chapter I  
 145 Authority citation revised .....15583  
 SFAR No. 36 amended.....59946  
 145.53 Revised .....58831  
 145.57 (a) revised .....58831

**14 CFR—Continued** 70 FR  
Page

Chapter I—Continued  
 145.63 Regulation at 65 FR 56206 withdrawn.....76979  
 145.79 Regulation at 65 FR 56206 withdrawn.....76979  
 145.163 Regulation at 66 FR 41117 delayed to 4-6-06 .....15580  
 (a) introductory text revised; eff. 4-6-06 .....15583  
 145.165 Added .....58831  
 145.206 Added .....58831  
 (a) correctly amended .....75397  
 145.221 Heading and (d) introductory text revised; eff. 1-30-06.....76979  
 150 Comment disposition .....29066  
 158.3 Amended .....14934  
 158.23 (a) introductory text revised.....14934  
 158.24 Added .....14934  
 158.25 Revised.....14935  
 158.27 (c)(2), (3) introductory text and (4) revised .....14936  
 158.29 (c)(2) revised .....14936  
 158.30 Added .....14936  
 158.37 Revised .....14937  
 183.1 Revised .....59946  
 183.15 (a) and (b) revised; (c) removed; (d) redesignated as (c).....59947  
 183.33 Regulation at 67 FR 72766 confirmed .....5532  
 183.41—183.67 (Subpart D) Added (OMB numbers pending in part).....59947  
 183.43 OMB number .....67345  
 183.45 OMB number .....67345  
 183.53 OMB number .....67345  
 183.55 OMB number .....67345  
 183.57 OMB number .....67345  
 183.63 OMB number .....67345  
 183.65 OMB number .....67345

**2006**

**14 CFR** 71 FR  
Page

Chapter I  
 183.15 (b) correctly revised .....28774  
 193 Orders.....54405

**List of CFR Sections Affected**

<b>2007</b>		<b>14 CFR—Continued</b>	
<b>14 CFR</b>	72 FR Page		72 FR Page
Chapter I		Chapter I—Continued	
150.13 (e)(2) removed; (e)(3) and (4) redesignated as new (e)(2) and (3).....	68475	158.37 Heading, (b)(1)(i)(A), (ii)(C), (D), (E) and (5) revised; (b)(1)(i)(B) and (C) redesign- ated as (b)(1)(i)(C) and (D); new (b)(1)(i)(B) and (ii)(F) added.....	28849
158.3 Amended.....	28847	158.39 (a) and (d) revised.....	28849
158.9 (a)(4) and (5) revised; (a)(6) added.....	28847	158.43 (b)(3) and (c) revised.....	28849
158.13 (b) through (e) revised; (f), (g) and (h) added.....	28847	158.45 (a)(3) revised.....	28849
158.15 (b)(5) and (6) revised; (b)(7) and (8) added.....	28848	158.47 (a) and (c)(4) revised.....	28849
158.18 Added.....	28848	158.49 (c) redesignated as (d); (b) and new (d) revised; new (c) added.....	28850
158.20 Added.....	28848	158.53 Revised.....	28850
158.29 (a)(1)(ii) and (b)(1)(ii) re- vised.....	28848	(c)(3) correctly amended.....	31714
158.30 Heading revised.....	28848	158.63 (a) and (c) revised.....	28851
158.31 Introductory text and (b) revised.....	28849	158.65 Revised.....	28851
158.33 (a)(2), (c)(1) introductory text and (2) revised; (a)(3) added.....	28849	158.67 (c)(2) revised.....	28851
		158.81 Revised.....	28851
		158.97 Removed.....	28851
		158 Appendix A amended.....	28851
		187.15 (a) revised.....	18559
		Regulation at 72 FR 18559 con- firmed.....	55022
		193.11 (a) amended.....	68475

