

SUBCHAPTER B—FOOD FOR HUMAN CONSUMPTION

PART 100—GENERAL

Subpart A—State and Local Requirements

Sec.

100.1 Petitions requesting exemption from preemption for State or local requirements.

100.2 State enforcement of Federal regulations.

Subparts B–E [Reserved]

Subpart F—Misbranding for Reasons Other Than Labeling

100.100 Misleading containers.

Subpart G—Specific Administrative Rulings and Decisions

100.155 Salt and iodized salt.

AUTHORITY: 21 U.S.C. 321, 331, 337, 342, 343, 348, 371.

SOURCE: 42 FR 14306, Mar. 15, 1977, unless otherwise noted.

Subpart A—State and Local Requirements

§ 100.1 Petitions requesting exemption from preemption for State or local requirements.

(a) *Scope and purpose.* (1) This subpart applies to the submission and consideration of petitions under section 403A(b) of the Federal Food, Drug, and Cosmetic Act (the act), by a State or a political subdivision of a State, requesting exemption of a State requirement from preemption under section 403A(a) of the act.

(2) Section 403A(b) of the act provides that where a State requirement has been preempted under section 403A(a) of the act, the State may petition the agency for an exemption. The agency may grant the exemption, under such conditions as it may prescribe by regulation, if the agency finds that the State requirement will not cause any food to be in violation of any applicable requirement under Federal law, will not unduly burden interstate commerce, and is designed to address a particular need for information that is not met by the preemptive Federal requirement.

(b) *Definitions.* (1) *Act* means the Federal Food, Drug, and Cosmetic Act (21 U.S.C. 321 *et seq.*).

(2) *Agency* means the Food and Drug Administration.

(3) *Commissioner* means the Commissioner of Food and Drugs.

(4) *State* means a State as defined in section 201(a)(1) of the act (which includes a territory of the United States, the District of Columbia, and Puerto Rico) or any political subdivision of a State having authority to issue food standards and food labeling regulations having force of law.

(5) *State requirement* means any statute, standard, regulation, or other requirement that is issued by a State.

(c) *Prerequisites for petitions for exemption from preemption.* The Food and Drug Administration will consider a petition for exemption from preemption on its merits only if the petition demonstrates that:

(1) The State requirement was enacted or was issued as a final rule by an authorized official of the State and is in effect or would be in effect but for the provisions of section 403A of the act.

(2) The State requirement is subject to preemption under section 403A(a) of the act because of a statutory provision listed in that section or because of a Federal standard or other Federal regulation that is in effect, or that has been published as a final rule with a designated effective date, and that was issued under the authority of a statutory provision listed in that section. For the purposes of this subpart, all petitions seeking exemption from preemption under section 403A(a)(3) through (a)(5) of the act submitted before May 8, 1992, will be considered timely even though the applicable statutory provisions or regulations are not yet in effect.

(3) The petitioner is an official of a State having authority to act for, or on behalf of, the Government in applying for an exemption of State requirements from preemption.

(4) The State requirement is subject to preemption under section 403A(a) of the act because it is not identical to

§ 100.1

21 CFR Ch. I (4-1-07 Edition)

the requirement of the preemptive Federal statutory provision or regulation including a standard of identity, quality, and fill. "Not identical to" does not refer to the specific words in the requirement but instead means that the State requirement directly or indirectly imposes obligations or contains provisions concerning the composition or labeling of food, or concerning a food container, that:

(i) Are not imposed by or contained in the applicable provision (including any implementing regulation) of section 401 or 403 of the act; or

(ii) Differ from those specifically imposed by or contained in the applicable provision (including any implementing regulation) of section 401 or 403 of the act.

(d) *Form of petition.* (1) All information included in the petition should meet the general requirements of §10.20(c) of this chapter.

(2) An original and one copy of the petition shall be submitted, or the petitioner may submit an original and a computer readable disk containing the petition. Contents of the disk should be in a standard format, such as ASCII format. (Petitioners interested in submitting a disk should contact the Center for Food Safety and Applied Nutrition for details.)

(3) Petitions for exemption from preemption for a State requirement shall be submitted to the Division of Dockets Management in the following form:

(Date) _____
Division of Dockets Management,
Food and Drug Administration,
Department of Health and Human Services,
5630 Fishers Lane, rm. 1061,
Rockville, MD 20852.

PETITION REQUESTING EXEMPTION FROM
PREEMPTION FOR STATE REQUIREMENT

The undersigned submits this petition under section 403A(b) of the Federal Food, Drug, and Cosmetic Act to request that the Food and Drug Administration exempt a State requirement from preemption.

The undersigned has authority to act for, or on behalf of, the (*identify State or political subdivision of the State*) because (*document petitioner's authority to submit petition on behalf of the State*).

A. Action Requested

1. Identify and give the exact wording of the State requirement and give date it was enacted or issued in final form.

2. Identify the specific standard or regulation that is believed to preempt the State requirement and the section and paragraph of the act that the standard or regulation implements.

B. Documentation of State Requirement

Provide a copy of the State requirement that is the subject of the application. Where available, the application should also include copies of any legislative history or background materials used in issuing the requirement, including hearing reports or studies concerning the development or consideration of the requirement.

C. Statement of Grounds

A petition for an exemption from preemption should contain the following:

1. An explanation of the State requirement and its rationale, and a comparison of State and Federal requirements to show differences.

2. An explanation of why compliance with the State requirement would not cause a food to be in violation of any applicable requirement under Federal law.

3. Information on the effect that granting the State petition will have on interstate commerce. The petition should contain information on economic feasibility, i.e., whether the State and Federal requirements have significantly different effects on the production and distribution of the food product; comparison of the costs of compliance as shown by data or information on the actual or anticipated effect of the State and Federal requirements on the sale and price of the food product in interstate commerce; and the effect of the State requirement on the availability of the food product to consumers. To the extent possible, the petition should include information showing that it is practical and feasible for producers of food products to comply with the State requirement. Such information may be submitted in the form of statements from affected persons indicating their ability to comply.

4. Identification of a particular need for information that the State requirement is designed to meet, which need is not met by Federal law. The petition should describe the conditions that require the State to petition for an exemption, the information need that the State requirement fulfills, the inadequacy of the Federal requirement in addressing this need, and the geographical area or political subdivision in which such need exists.

Food and Drug Administration, HHS

§ 100.2

D. Environmental Impact

The petition shall contain a claim for categorical exclusion under 21 CFR 25.24 or an environmental assessment under 21 CFR 25.31.

E. Notification

Provide name and address of person, branch, department, or other instrumentality of the State government that should be notified of the Commissioner's action concerning the petition.

F. Certification

The undersigned certifies, that, to the best knowledge and belief of the undersigned, this petition includes all information and views on which the petition relies.

(Signature) _____
(Name of petitioner) _____
(Mailing address) _____
(Telephone number) _____

(Information collection requirements in this section were approved by the Office of Management and Budget (OMB) and assigned OMB number 0910-0277)

(e) *Submission of petition for exemption; public disclosure.* The availability for public disclosure of a petition for exemption will be governed by the rules specified in §10.20(j) of this chapter.

(f) *Agency consideration of petitions.* (1) Unless otherwise specified in this section, all relevant provisions and requirements of subpart B of part 10 of this chapter, are applicable to State petitions requesting exemption from Federal preemption under section 403A(b) of the act.

(2) If a petition does not meet the prerequisite requirements of paragraph (c) of this section, the agency will issue a letter to the petitioner denying the petition and stating in what respect the petition does not meet these requirements.

(3) If a petition appears to meet the prerequisite requirements in paragraph (c) of this section, it will be filed by the Division of Dockets Management, stamped with the date of filing, and assigned a docket number. The docket number identifies the file established by the Division of Dockets Management for all submissions relating to the petition, as provided in this part. Subsequent submissions relating to the matter must refer to the docket number and will be filed in the docket file. The Division of Dockets Management will promptly notify the petitioner in

writing of the filing and docket number of a petition.

(4) Any interested person may submit written comments to the Division of Dockets Management on a filed petition as provided in §10.30(d) of this chapter.

(5) Within 90 days of the date of filing the agency will furnish a response to the petitioner. The response will either:

(i) State that the agency has tentatively determined that the petition merits the granting of an exemption, and that it intends to publish in the FEDERAL REGISTER a proposal to grant the exemption through rulemaking;

(ii) Deny the petition and state the reasons for such denial; or

(iii) Provide a tentative response indicating why the agency has been unable to reach a decision on the petition, e.g., because of other agency priorities or a need for additional information.

(g) If a State submitted a petition for exemption of a State requirement from preemption under section 403A(a)(3) through (a)(5) of the act before May 8, 1992, that State requirement will not be subject to preemption until:

(1) November 8, 1992; or

(2) Action on the petition, whichever occurs later.

[58 FR 2468, Jan. 6, 1993]

§100.2 State enforcement of Federal regulations.

(a) Under section 307 of the Federal Food, Drug, and Cosmetic Act (the act), a State may bring, in its own name and within its own jurisdiction, proceedings for the civil enforcement, or to restrain violations, of sections 401, 403(b), 403(c), 403(d), 403(e), 403(f), 403(g), 403(h), 403(i), 403(k), 403(q), or 403(r) of the act if the food that is the subject of the proceedings is located in the State.

(b) No proceeding may be commenced by a State under paragraph (a) of this section:

(1) Before 30 days after the State has given notice to the Food and Drug Administration (FDA) that the State intends to bring such proceeding.

(2) Before 90 days after the State has given notice to FDA of such intent if

§ 100.2

21 CFR Ch. I (4-1-07 Edition)

FDA has, within such 30 days, commenced an informal or formal enforcement action pertaining to the food which would be the subject of such proceeding.

(3) If FDA is diligently prosecuting a proceeding in court pertaining to such food, has settled such proceeding, or has settled the informal or formal enforcement action pertaining to such food.

(c) A State may intervene as a matter of right, in any court proceeding described in paragraph (b)(3) of this section.

(d) The notification that a State submits in accordance with paragraph (b) of this section should include the following information and be submitted in the following recommended format:

(Date) _____
Name of State agency _____
Post office address _____
Street address _____
City, State, and ZIP code _____
Name of product(s) covered by the notification _____
Reporting official, title, and telephone no. _____
FAX No. _____
Agency contact (if different from reporting official), title, and telephone no. _____

Director,
Division of Enforcement (HFS-605),
Center for Food Safety and Applied Nutrition,
Food and Drug Administration,
5100 Paint Branch Pkwy.,
College Park, MD 20740.

To Whom It May Concern:

The undersigned, _____, submits this letter of notification pursuant to section 307(b)(1) of the Federal Food, Drug, and Cosmetic Act (21 U.S.C. 337(b)(1)) with respect to _____. (name of products covered by the notification and the enforcement action that is to be initiated)

Attached hereto, and constituting a part of this letter of notification are the following:

- A. The name of the product.
- B. The type and size of each product container.
- C. Copy of the label and labeling of the product.
- D. Manufacturing code (if applicable).
- E. Name and address of firm believed to be responsible for violations.
- F. Name and address of parent firm (if known).
- G. Reason for the anticipated State enforcement action (list specific violations, including sections of the law violated).

H. Name of firm against which action is anticipated (if applicable).

I. Type of enforcement action.

Yours very truly,

Reporting Agency

By _____
(Indicate authority)

(e) The letter of notification should be signed by a State official authorized by the State to institute the contemplated enforcement actions.

(f) The letter of notification should be sent to the Division of Enforcement (HFS-605), Center for Food Safety and Applied Nutrition, Food and Drug Administration, 5100 Paint Branch Pkwy., College Park, MD 20740, FAX number 202-205-4642.

(g) FDA will notify the State of the date in which its letter of notification was received by FDA, Center for Food Safety and Applied Nutrition, Division of Enforcement (HFS-605) (within 2 working days after date of receipt). This date will be the date of notification for the purposes of paragraph (b) of this section.

(h) The Director, Division of Enforcement, Office of Field Programs, Center for Food Safety and Applied Nutrition, FDA, will respond to the State's notification within 30 days of the date of notification by advising:

(1) Whether FDA has commenced an informal or formal enforcement action pertaining to the food that is the subject of the notification; or

(2) Whether FDA is prosecuting a proceeding in court pertaining to such food, has settled such proceeding, or has settled informal or formal enforcement action pertaining to such food.

(i) Information contained in State notification letters shall be exempt from public disclosure to the same extent to which such information would be so exempt pursuant to §§20.61, 20.64, and 20.88 of this chapter.

(j) *Definitions.* (1) *Informal enforcement actions* include warning letters, recalls, detentions, or other administrative enforcement actions that pertain to the food in question.

(2) *Formal enforcement actions* include seizures, injunctions, or other civil judicial enforcement actions that pertain to the food in question. (Information collection requirements in this section

Food and Drug Administration, HHS

§ 100.155

were approved by the Office of Management and Budget (OMB) and assigned OMB control number 0910-0275.)

[58 FR 2460, Jan. 6, 1993; 58 FR 17097, Apr. 1, 1993, as amended at 66 FR 56035, Nov. 6, 2001]

Subparts B–E [Reserved]

Subpart F—Misbranding for Reasons Other Than Labeling

§ 100.100 Misleading containers.

In accordance with section 403(d) of the act, a food shall be deemed to be misbranded if its container is so made, formed, or filled as to be misleading.

(a) A container that does not allow the consumer to fully view its contents shall be considered to be filled as to be misleading if it contains nonfunctional slack-fill. Slack-fill is the difference between the actual capacity of a container and the volume of product contained therein. Nonfunctional slack-fill is the empty space in a package that is filled to less than its capacity for reasons other than:

(1) Protection of the contents of the package;

(2) The requirements of the machines used for enclosing the contents in such package;

(3) Unavoidable product settling during shipping and handling;

(4) The need for the package to perform a specific function (e.g., where packaging plays a role in the preparation or consumption of a food), where such function is inherent to the nature of the food and is clearly communicated to consumers;

(5) The fact that the product consists of a food packaged in a reusable container where the container is part of the presentation of the food and has value which is both significant in proportion to the value of the product and independent of its function to hold the food, e.g., a gift product consisting of a food or foods combined with a container that is intended for further use after the food is consumed; or durable commemorative or promotional packages; or

(6) Inability to increase level of fill or to further reduce the size of the package (e.g., where some minimum package size is necessary to accommo-

date required food labeling (excluding any vignettes or other nonmandatory designs or label information), discourage pilfering, facilitate handling, or accommodate tamper-resistant devices).

(b) [Reserved]

[59 FR 537, Jan. 5, 1994]

Subpart G—Specific Administrative Rulings and Decisions

§ 100.155 Salt and iodized salt.

(a) For the purposes of this section, the term *iodized salt* or *iodized table salt* is designated as the name of salt for human food use to which iodide has been added in the form of cuprous iodide or potassium iodide permitted by §§ 184.1265 and 184.1634 of this chapter. In the labeling of such products, all words in the name shall be equal in prominence and type size. The statement “This salt supplies iodide, a necessary nutrient” shall appear on the label immediately following the name and shall be in letters which are not less in height than those required for the declaration of the net quantity of contents as specified in § 101.105 of this chapter.

(b) Salt or table salt for human food use to which iodide has not been added shall bear the statement, “This salt does not supply iodide, a necessary nutrient.” This statement shall appear immediately following the name of the food and shall be in letters which are not less in height than those required for the declaration of the net quantity of contents as specified in § 101.105 of this chapter.

(c) Salt, table salt, iodized salt, or iodized table salt to which anticaking agents have been added may bear in addition to the ingredient statement designating the anticaking agent(s), a label statement describing the characteristics imparted by such agent(s) (for example, “free flowing”), providing such statement does not appear with greater prominence or in type size larger than the statements which immediately follow the name of the food as required by paragraphs (a) and (b) of this section.

(d) Individual serving-sized packages containing less than ½ ounce and packages containing more than 2½ pounds

of a food described in this section shall be exempt from declaration of the statements which paragraphs (a) and (b) of this section require immediately following the name of the food. Such exemption shall not apply to the outer container or wrapper of a multiunit retail package.

(e) All salt, table salt, iodized salt, or iodized table salt in packages intended for retail sale shipped in interstate commerce 18 months after the date of publication of this statement of policy in the FEDERAL REGISTER, shall be labeled as prescribed by this section; and if not so labeled, the Food and Drug Administration will regard them as misbranded within the meaning of sections 403 (a) and (f) of the Federal Food, Drug, and Cosmetic Act.

[42 FR 14306, Mar. 15, 1977, as amended at 48 FR 10811, Mar. 15, 1983; 49 FR 24119, June 12, 1984]

PART 101—FOOD LABELING

Subpart A—General Provisions

Sec.

- 101.1 Principal display panel of package form food.
- 101.2 Information panel of package form food.
- 101.3 Identity labeling of food in packaged form.
- 101.4 Food; designation of ingredients.
- 101.5 Food; name and place of business of manufacturer, packer, or distributor.
- 101.9 Nutrition labeling of food.
- 101.10 Nutrition labeling of restaurant foods.
- 101.12 Reference amounts customarily consumed per eating occasion.
- 101.13 Nutrient content claims—general principles.
- 101.14 Health claims: general requirements.
- 101.15 Food; prominence of required statements.
- 101.17 Food labeling warning, notice, and safe handling statements.
- 101.18 Misbranding of food.

Subpart B—Specific Food Labeling Requirements

- 101.22 Foods; labeling of spices, flavorings, colorings and chemical preservatives.
- 101.30 Percentage juice declaration for foods purporting to be beverages that contain fruit or vegetable juice.

Subpart C—Specific Nutrition Labeling Requirements and Guidelines

- 101.36 Nutrition labeling of dietary supplements.
- 101.42 Nutrition labeling of raw fruit, vegetables, and fish.
- 101.43 Substantial compliance of food retailers with the guidelines for the voluntary nutrition labeling of raw fruit, vegetables, and fish.
- 101.44 Identification of the 20 most frequently consumed raw fruit, vegetables, and fish in the United States.
- 101.45 Guidelines for the voluntary nutrition labeling of raw fruit, vegetables, and fish.

Subpart D—Specific Requirements for Nutrient Content Claims

- 101.54 Nutrient content claims for “good source,” “high,” “more,” and “high potency.”
- 101.56 Nutrient content claims for “light” or “lite.”
- 101.60 Nutrient content claims for the calorie content of foods.
- 101.61 Nutrient content claims for the sodium content of foods.
- 101.62 Nutrient content claims for fat, fatty acid, and cholesterol content of foods.
- 101.65 Implied nutrient content claims and related label statements.
- 101.67 Use of nutrient content claims for butter.
- 101.69 Petitions for nutrient content claims.

Subpart E—Specific Requirements for Health Claims

- 101.70 Petitions for health claims.
- 101.71 Health claims: claims not authorized.
- 101.72 Health claims: calcium and osteoporosis.
- 101.73 Health claims: dietary lipids and cancer.
- 101.74 Health claims: sodium and hypertension.
- 101.75 Health claims: dietary saturated fat and cholesterol and risk of coronary heart disease.
- 101.76 Health claims: fiber-containing grain products, fruits, and vegetables and cancer.
- 101.77 Health claims: fruits, vegetables, and grain products that contain fiber, particularly soluble fiber, and risk of coronary heart disease.
- 101.78 Health claims: fruits and vegetables and cancer.
- 101.79 Health claims: Folate and neural tube defects.
- 101.80 Health claims: dietary noncariogenic carbohydrate sweeteners and dental caries.

Food and Drug Administration, HHS

§ 101.2

- 101.81 Health claims: Soluble fiber from certain foods and risk of coronary heart disease (CHD).
- 101.82 Health claims: Soy protein and risk of coronary heart disease (CHD).
- 101.83 Health claims: plant sterol/stanol esters and risk of coronary heart disease (CHD).

Subpart F—Specific Requirements for Descriptive Claims That Are Neither Nutrient Content Claims nor Health Claims

- 101.93 Certain types of statements for dietary supplements.
- 101.95 “Fresh,” “freshly frozen,” “fresh frozen,” “frozen fresh.”

Subpart G—Exemptions From Food Labeling Requirements

- 101.100 Food; exemptions from labeling.
- 101.105 Declaration of net quantity of contents when exempt.
- 101.108 Temporary exemptions for purposes of conducting authorized food labeling experiments.
- APPENDIX A TO PART 101—MONIER-WILLIAMS PROCEDURE (WITH MODIFICATIONS) FOR SULFITES IN FOOD, CENTER FOR FOOD SAFETY AND APPLIED NUTRITION, FOOD AND DRUG ADMINISTRATION (NOVEMBER 1985)
- APPENDIX B TO PART 101—GRAPHIC ENHANCEMENTS USED BY THE FDA
- APPENDIX C TO PART 101—NUTRITION FACTS FOR RAW FRUITS AND VEGETABLES
- APPENDIX D TO PART 101—NUTRITION FACTS FOR COOKED FISH

AUTHORITY: 15 U.S.C. 1453, 1454, 1455; 21 U.S.C. 321, 331, 342, 343, 348, 371; 42 U.S.C. 243, 264, 271.

SOURCE: 42 FR 14308, Mar. 15, 1977, unless otherwise noted.

EDITORIAL NOTE: Nomenclature changes to part 101 appear at 63 FR 14035, Mar. 24, 1998, 66 FR 17358, Mar. 30, 2001, and 66 FR 56035, Nov. 6, 2001.

Subpart A—General Provisions

§ 101.1 Principal display panel of package form food.

The term *principal display panel* as it applies to food in package form and as used in this part, means the part of a label that is most likely to be displayed, presented, shown, or examined under customary conditions of display for retail sale. The principal display panel shall be large enough to accommodate all the mandatory label information required to be placed thereon

by this part with clarity and conspicuousness and without obscuring design, vignettes, or crowding. Where packages bear alternate principal display panels, information required to be placed on the principal display panel shall be duplicated on each principal display panel. For the purpose of obtaining uniform type size in declaring the quantity of contents for all packages of substantially the same size, the term *area of the principal display panel* means the area of the side or surface that bears the principal display panel, which area shall be:

(a) In the case of a rectangular package where one entire side properly can be considered to be the principal display panel side, the product of the height times the width of that side;

(b) In the case of a cylindrical or nearly cylindrical container, 40 percent of the product of the height of the container times the circumference;

(c) In the case of any otherwise shaped container, 40 percent of the total surface of the container: *Provided, however,* That where such container presents an obvious “principal display panel” such as the top of a triangular or circular package of cheese, the area shall consist of the entire top surface. In determining the area of the principal display panel, exclude tops, bottoms, flanges at tops and bottoms of cans, and shoulders and necks of bottles or jars. In the case of cylindrical or nearly cylindrical containers, information required by this part to appear on the principal display panel shall appear within that 40 percent of the circumference which is most likely to be displayed, presented, shown, or examined under customary conditions of display for retail sale.

§ 101.2 Information panel of package form food.

(a) The term *information panel* as it applies to packaged food means that part of the label immediately contiguous and to the right of the principal display panel as observed by an individual facing the principal display panel with the following exceptions:

(1) If the part of the label immediately contiguous and to the right of the principal display panel is too small

§ 101.2

21 CFR Ch. I (4–1–07 Edition)

to accommodate the necessary information or is otherwise unusable label space, e.g., folded flaps or can ends, the panel immediately contiguous and to the right of this part of the label may be used.

(2) If the package has one or more alternate principal display panels, the information panel is immediately contiguous and to the right of any principal display panel.

(3) If the top of the container is the principal display panel and the package has no alternate principal display panel, the information panel is any panel adjacent to the principal display panel.

(b) All information required to appear on the label of any package of food under §§101.4, 101.5, 101.8, 101.9, 101.13, 101.17, 101.36, subpart D of part 101, and part 105 of this chapter shall appear either on the principal display panel or on the information panel, unless otherwise specified by regulations in this chapter.

(c) All information appearing on the principal display panel or the information panel pursuant to this section shall appear prominently and conspicuously, but in no case may the letters and/or numbers be less than one-sixteenth inch in height unless an exemption pursuant to paragraph (f) of this section is established. The requirements for conspicuousness and legibility shall include the specifications of §§101.105(h) (1) and (2) and 101.15.

(1)(i) Soft drinks packaged in bottles manufactured before October 31, 1975 shall be exempt from the requirements prescribed by this section to the extent that information which is blown, lithographed, or formed onto the surface of the bottle is exempt from the size and placement requirements of this section.

(ii) Soft drinks packaged in bottles shall be exempt from the size and placement requirements prescribed by this section if all of the following conditions are met:

(A) If the soft drink is packaged in a bottle bearing a paper, plastic foam jacket, or foil label, or is packaged in a nonreusable bottle bearing a label lithographed onto the surface of the bottle or is packaged in metal cans, the product shall not be exempt from any

requirement of this section other than the exemptions created by §1.24(a)(5) (ii) and (v) of this chapter and the label shall bear all required information in the specified minimum type size, except the label will not be required to bear the information required by §101.5 if this information appears on the bottle closure or on the lid of the can in a type size not less than one-sixteenth inch in height, or if embossed on the lid of the can in a type size not less than one-eighth inch in height.

(B) If the soft drink is packaged in a bottle which does not bear a paper, plastic foam jacket or foil label, or is packaged in a reusable bottle bearing a label lithographed onto the surface of the bottle:

(1) Neither the bottle nor the closure is required to bear nutrition labeling in compliance with §101.9, except that any multiunit retail package in which it is contained shall bear nutrition labeling if required by §101.9; and any vending machine in which it is contained shall bear nutrition labeling if nutrition labeling is not present on the bottle or closure, if required by §101.9.

(2) All other information pursuant to this section shall appear on the top of the bottle closure prominently and conspicuously in letters and/or numbers no less than one thirty-second inch in height, except that if the information required by §101.5 is placed on the side of the closure in accordance with §1.24(a)(5)(ii) of this chapter, such information shall appear in letters and/or numbers no less than one-sixteenth inch in height.

(3) Upon the petition of any interested person demonstrating that the bottle closure is too small to accommodate this information, the Commissioner may by regulation establish an alternative method of disseminating such information. Information appearing on the closure shall appear in the following priority:

(i) The statement of ingredients.
(ii) The name and address of the manufacturer, packer, or distributor.
(iii) The statement of identity.

(2) Individual serving-size packages of food served with meals in restaurants, institutions, and on board passenger carriers, and not intended for sale at retail, are exempt from

type-size requirements of this paragraph, provided:

(i) The package has a total area of 3 square inches or less available to bear labeling;

(ii) There is insufficient area on the package available to print all required information in a type size of $\frac{1}{16}$ inch in height;

(iii) The information required by paragraph (b) of this section appears on the label in accordance with the provisions of this paragraph, except that the type size is not less than $\frac{1}{32}$ inch in height.

(d)(1) Except as provided by §§101.9(j)(13) and (j)(17) and 101.36(i)(2) and (i)(5), all information required to appear on the principal display panel or on the information panel under this section shall appear on the same panel unless there is insufficient space. In determining the sufficiency of the available space, except as provided by §§101.9(j)(17) and 101.36(i)(5), any vignettes, designs, and other nonmandatory label information shall not be considered. If there is insufficient space for all of this information to appear on a single panel, it may be divided between these two panels, except that the information required under any given section or part shall all appear on the same panel. A food whose label is required to bear the ingredient statement on the principal display panel may bear all other information specified in paragraph (b) of this section on the information panel.

(2) Any food, not otherwise exempted in this section, if packaged in a container consisting of a separate lid and body, and bearing nutrition labeling pursuant to §101.9, and if the lid qualifies for and is designed to serve as a principal display panel, shall be exempt from the placement requirements of this section in the following respects:

(i) The name and place of business information required by §101.5 shall not be required on the body of the container if this information appears on the lid in accordance with this section.

(ii) The nutrition information required by §101.9 shall not be required on the lid if this information appears on the container body in accordance with this section.

(iii) The statement of ingredients required by §101.4 shall not be required on the lid if this information appears on the container body in accordance with this section. Further, the statement of ingredients is not required on the container body if this information appears on the lid in accordance with this section.

(e) All information appearing on the information panel pursuant to this section shall appear in one place without other intervening material.

(f) If the label of any package of food is too small to accommodate all of the information required by §§101.4, 101.5, 101.8, 101.9, 101.13, 101.17, 101.36, subpart D of part 101, and part 105 of this chapter, the Commissioner may establish by regulation an acceptable alternative method of disseminating such information to the public, e.g., a type size smaller than one-sixteenth inch in height, or labeling attached to or inserted in the package or available at the point of purchase. A petition requesting such a regulation, as an amendment to this paragraph, shall be submitted under part 10 of this chapter.

[42 FR 14308, Mar. 15, 1977, as amended at 42 FR 15673, Mar. 22, 1977; 42 FR 45905, Sept. 13, 1977; 42 FR 47191, Sept. 20, 1977; 44 FR 16006, Mar. 16, 1979; 49 FR 13339, Apr. 4, 1984; 53 FR 16068, May 5, 1988; 58 FR 44030, Aug. 18, 1993; 60 FR 17205, Apr. 5, 1995; 62 FR 43074, Aug. 12, 1997; 62 FR 49847, Sept. 23, 1997; 63 FR 14817, Mar. 27, 1998]

§101.3 Identity labeling of food in packaged form.

(a) The principal display panel of a food in package form shall bear as one of its principal features a statement of the identity of the commodity.

(b) Such statement of identity shall be in terms of:

(1) The name now or hereafter specified in or required by any applicable Federal law or regulation; or, in the absence thereof,

(2) The common or usual name of the food; or, in the absence thereof,

(3) An appropriately descriptive term, or when the nature of the food is obvious, a fanciful name commonly used by the public for such food.

(c) Where a food is marketed in various optional forms (whole, slices, diced, etc.), the particular form shall

§ 101.3

21 CFR Ch. I (4–1–07 Edition)

be considered to be a necessary part of the statement of identity and shall be declared in letters of a type size bearing a reasonable relation to the size of the letters forming the other components of the statement of identity; except that if the optional form is visible through the container or is depicted by an appropriate vignette, the particular form need not be included in the statement. This specification does not affect the required declarations of identity under definitions and standards for foods promulgated pursuant to section 401 of the act.

(d) This statement of identity shall be presented in bold type on the principal display panel, shall be in a size reasonably related to the most prominent printed matter on such panel, and shall be in lines generally parallel to the base on which the package rests as it is designed to be displayed.

(e) Under the provisions of section 403(c) of the Federal Food, Drug, and Cosmetic Act, a food shall be deemed to be misbranded if it is an imitation of another food unless its label bears, in type of uniform size and prominence, the word "imitation" and, immediately thereafter, the name of the food imitated.

(1) A food shall be deemed to be an imitation and thus subject to the requirements of section 403(c) of the act if it is a substitute for and resembles another food but is nutritionally inferior to that food.

(2) A food that is a substitute for and resembles another food shall not be deemed to be an imitation provided it meets each of the following requirements:

(i) It is not nutritionally inferior to the food for which it substitutes and which it resembles.

(ii) Its label bears a common or usual name that complies with the provisions of §102.5 of this chapter and that is not false or misleading, or in the absence of an existing common or usual name, an appropriately descriptive term that is not false or misleading. The label may, in addition, bear a fanciful name which is not false or misleading.

(3) A food for which a common or usual name is established by regulation (e.g., in a standard of identity pursuant to section 401 of the act, in a common

or usual name regulation pursuant to part 102 of this chapter, or in a regulation establishing a nutritional quality guideline pursuant to part 104 of this chapter), and which complies with all of the applicable requirements of such regulation(s), shall not be deemed to be an imitation.

(4) Nutritional inferiority includes: (i) Any reduction in the content of an essential nutrient that is present in a measurable amount, but does not include a reduction in the caloric or fat content provided the food is labeled pursuant to the provisions of §101.9, and provided the labeling with respect to any reduction in caloric content complies with the provisions applicable to caloric content in part 105 of this chapter.

(ii) For the purpose of this section, a measurable amount of an essential nutrient in a food shall be considered to be 2 percent or more of the Daily Reference Value (DRV) of protein listed under §101.9(c)(7)(iii) and of potassium listed under §101.9(c)(9) per reference amount customarily consumed and 2 percent or more of the Reference Daily Intake (RDI) of any vitamin or mineral listed under §101.9(c)(8)(iv) per reference amount customarily consumed, except that selenium, molybdenum, chromium, and chloride need not be considered.

(iii) If the Commissioner concludes that a food is a substitute for and resembles another food but is inferior to the food imitated for reasons other than those set forth in this paragraph, he may propose appropriate revisions to this regulation or he may propose a separate regulation governing the particular food.

(f) A label may be required to bear the percentage(s) of a characterizing ingredient(s) or information concerning the presence or absence of an ingredient(s) or the need to add an ingredient(s) as part of the common or usual name of the food pursuant to subpart B of part 102 of this chapter.

(g) Dietary supplements shall be identified by the term "dietary supplement" as a part of the statement of identity, except that the word "dietary" may be deleted and replaced by the name of the dietary ingredients in the product (e.g., calcium supplement)

or an appropriately descriptive term indicating the type of dietary ingredients that are in the product (e.g., herbal supplement with vitamins).

[42 FR 14308, Mar. 15, 1977, as amended at 48 FR 10811, Mar. 15, 1983; 58 FR 2227, Jan. 6, 1993; 60 FR 67174, Dec. 28, 1995; 62 FR 49847, Sept. 23, 1997]

§ 101.4 Food; designation of ingredients.

(a)(1) Ingredients required to be declared on the label or labeling of a food, including foods that comply with standards of identity, except those ingredients exempted by § 101.100, shall be listed by common or usual name in descending order of predominance by weight on either the principal display panel or the information panel in accordance with the provisions of § 101.2, except that ingredients in dietary supplements that are listed in the nutrition label in accordance with § 101.36 need not be repeated in the ingredient list. Paragraph (g) of this section describes the ingredient list on dietary supplement products.

(2) The descending order of predominance requirements of paragraph (a)(1) of this section do not apply to ingredients present in amounts of 2 percent or less by weight when a listing of these ingredients is placed at the end of the ingredient statement following an appropriate quantifying statement, e.g., "Contains ___ percent or less of ____" or "Less than ___ percent of ____." The blank percentage within the quantifying statement shall be filled in with a threshold level of 2 percent, or, if desired, 1.5 percent, 1.0 percent, or 0.5 percent, as appropriate. No ingredient to which the quantifying phrase applies may be present in an amount greater than the stated threshold.

(b) The name of an ingredient shall be a specific name and not a collective (generic) name, except that:

(1) Spices, flavorings, colorings and chemical preservatives shall be declared according to the provisions of § 101.22.

(2) An ingredient which itself contains two or more ingredients and which has an established common or usual name, conforms to a standard established pursuant to the Meat Inspection or Poultry Products Inspection

Acts by the U.S. Department of Agriculture, or conforms to a definition and standard of identity established pursuant to section 401 of the Federal Food, Drug, and Cosmetic Act, shall be designated in the statement of ingredients on the label of such food by either of the following alternatives:

(i) By declaring the established common or usual name of the ingredient followed by a parenthetical listing of all ingredients contained therein in descending order of predominance except that, if the ingredient is a food subject to a definition and standard of identity established in subchapter B of this chapter that has specific labeling provisions for optional ingredients, optional ingredients may be declared within the parenthetical listing in accordance with those provisions.

(ii) By incorporating into the statement of ingredients in descending order of predominance in the finished food, the common or usual name of every component of the ingredient without listing the ingredient itself.

(3) Skim milk, concentrated skim milk, reconstituted skim milk, and nonfat dry milk may be declared as "skim milk" or "nonfat milk".

(4) Milk, concentrated milk, reconstituted milk, and dry whole milk may be declared as "milk".

(5) Bacterial cultures may be declared by the word "cultured" followed by the name of the substrate, e.g., "made from cultured skim milk or cultured buttermilk".

(6) Sweetcream buttermilk, concentrated sweetcream buttermilk, reconstituted sweetcream buttermilk, and dried sweetcream buttermilk may be declared as "buttermilk".

(7) Whey, concentrated whey, reconstituted whey, and dried whey may be declared as "whey".

(8) Cream, reconstituted cream, dried cream, and plastic cream (sometimes known as concentrated milk fat) may be declared as "cream".

(9) Butteroil and anhydrous butterfat may be declared as "butterfat".

(10) Dried whole eggs, frozen whole eggs, and liquid whole eggs may be declared as "eggs".

(11) Dried egg whites, frozen egg whites, and liquid egg whites may be declared as "egg whites".

§ 101.4

21 CFR Ch. I (4–1–07 Edition)

(12) Dried egg yolks, frozen egg yolks, and liquid egg yolks may be declared as “egg yolks”.

(13) [Reserved]

(14) Each individual fat and/or oil ingredient of a food intended for human consumption shall be declared by its specific common or usual name (e.g., “beef fat”, “cottonseed oil”) in its order of predominance in the food except that blends of fats and/or oils may be designated in their order of predominance in the foods as “_____ shortening” or “blend of _____ oils”, the blank to be filled in with the word “vegetable”, “animal”, “marine”, with or without the terms “fat” or “oils”, or combination of these, whichever is applicable if, immediately following the term, the common or usual name of each individual vegetable, animal, or marine fat or oil is given in parentheses, e.g., “vegetable oil shortening (soybean and cottonseed oil)”. For products that are blends of fats and/or oils and for foods in which fats and/or oils constitute the predominant ingredient, i.e., in which the combined weight of all fat and/or oil ingredients equals or exceeds the weight of the most predominant ingredient that is not a fat or oil, the listing of the common or usual names of such fats and/or oils in parentheses shall be in descending order of predominance. In all other foods in which a blend of fats and/or oils is used as an ingredient, the listing of the common or usual names in parentheses need not be in descending order of predominance if the manufacturer, because of the use of varying mixtures, is unable to adhere to a constant pattern of fats and/or oils in the product. If the fat or oil is completely hydrogenated, the name shall include the term *hydrogenated*, or if partially hydrogenated, the name shall include the term *partially hydrogenated*. If each fat and/or oil in a blend or the blend is completely hydrogenated, the term “hydrogenated” may precede the term(s) describing the blend, e.g., “hydrogenated vegetable oil (soybean, cottonseed, and palm oils)”, rather than preceding the name of each individual fat and/or oil; if the blend of fats and/or oils is partially hydrogenated, the term “partially hydrogenated” may be used in the same manner. Fat and/or

oil ingredients not present in the product may be listed if they may sometimes be used in the product. Such ingredients shall be identified by words indicating that they may not be present, such as “or”, “and/or”, “contains one or more of the following:”, e.g., “vegetable oil shortening (contains one or more of the following: cottonseed oil, palm oil, soybean oil)”. No fat or oil ingredient shall be listed unless actually present if the fats and/or oils constitute the predominant ingredient of the product, as defined in this paragraph (b)(14).

(15) When all the ingredients of a wheat flour are declared in an ingredient statement, the principal ingredient of the flour shall be declared by the name(s) specified in §§ 137.105, 137.200, 137.220 and 137.225 of this chapter, i.e., the first ingredient designated in the ingredient list of flour, or bromated flour, or enriched flour, or self-rising flour is “flour”, “white flour”, “wheat flour”, or “plain flour”; the first ingredient designated in the ingredient list of durum flour is “durum flour”; the first ingredient designated in the ingredient list of whole wheat flour, or bromated whole wheat flour is “whole wheat flour”, “graham flour”, or “entire wheat flour”; and the first ingredient designated in the ingredient list of whole durum wheat flour is “whole durum wheat flour”.

(16) Ingredients that act as leavening agents in food may be declared in the ingredient statement by stating the specific common or usual name of each individual leavening agent in parentheses following the collective name “leavening”, e.g., “leavening (baking soda, monocalcium phosphate, and calcium carbonate)”. The listing of the common or usual name of each individual leavening agent in parentheses shall be in descending order of predominance; *Except*, That if the manufacturer is unable to adhere to a constant pattern of leavening agents in the product, the listing of individual leavening agents need not be in descending order of predominance. Leavening agents not present in the product may be listed if they are sometimes used in the product. Such ingredients shall be identified by words indicating that they may not be present, such as

“or”, “and/or”, “contains one or more of the following:”.

(17) Ingredients that act as yeast nutrients in foods may be declared in the ingredient statement by stating the specific common or usual name of each individual yeast nutrient in parentheses following the collective name “yeast nutrients”, e.g., “yeast nutrients (calcium sulfate and ammonium phosphate)”. The listing of the common or usual name of each individual yeast nutrient in parentheses shall be in descending order of predominance: *Except*, That if the manufacturer is unable to adhere to a constant pattern of yeast nutrients in the product, the listing of the common or usual names of individual yeast nutrients need not be in descending order of predominance. Yeast nutrients not present in the product may be listed if they are sometimes used in the product. Such ingredients shall be identified by words indicating that they may not be present, such as “or”, “and/or”, or “contains one or more of the following:”.

(18) Ingredients that act as dough conditioners may be declared in the ingredient statement by stating the specific common or usual name of each individual dough conditioner in parentheses following the collective name “dough conditioner”, e.g., “dough conditioners (L-cysteine, ammonium sulfate)”. The listing of the common or usual name of each dough conditioner in parentheses shall be in descending order of predominance: *Except*, That if the manufacturer is unable to adhere to a constant pattern of dough conditioners in the product, the listing of the common or usual names of individual dough conditioners need not be in descending order of predominance. Dough conditioners not present in the product may be listed if they are sometimes used in the product. Such ingredients shall be identified by words indicating that they may not be present, such as “or”, “and/or”, or “contains one or more of the following:”.

(19) Ingredients that act as firming agents in food (e.g., salts of calcium and other safe and suitable salts in canned vegetables) may be declared in the ingredient statement, in order of predominance appropriate for the total of all firming agents in the food, by

stating the specific common or usual name of each individual firming agent in descending order of predominance in parentheses following the collective name “firming agents”. If the manufacturer is unable to adhere to a constant pattern of firming agents in the food, the listing of the individual firming agents need not be in descending order of predominance. Firming agents not present in the product may be listed if they are sometimes used in the product. Such ingredients shall be identified by words indicating that they may not be present, such as “or”, “and/or”, “contains one or more of the following:”.

(20) For purposes of ingredient labeling, the term *sugar* shall refer to sucrose, which is obtained from sugar cane or sugar beets in accordance with the provisions of § 184.1854 of this chapter.

(21) [Reserved]

(22) Wax and resin ingredients on fresh produce when such produce is held for retail sale, or when held for other than retail sale by packers or repackers shall be declared collectively by the phrase “coated with food-grade animal-based wax, to maintain freshness” or the phrase “coated with food-grade vegetable-, petroleum-, beeswax-, and/or shellac-based wax or resin, to maintain freshness” as appropriate. The terms “food-grade” and “to maintain freshness” are optional. The term *lac-resin* may be substituted for the term *shellac*.

(23) When processed seafood products contain fish protein ingredients consisting primarily of the myofibrillar protein fraction from one or more fish species and the manufacturer is unable to adhere to a constant pattern of fish species in the fish protein ingredient, because of seasonal or other limitations of species availability, the common or usual name of each individual fish species need not be listed in descending order of predominance. Fish species not present in the fish protein ingredient may be listed if they are sometimes used in the product. Such ingredients must be identified by words indicating that they may not be present, such as “or”, “and/or”, or “contains one or more of the following:” Fish protein ingredients may

§ 101.4

21 CFR Ch. I (4–1–07 Edition)

be declared in the ingredient statement by stating the specific common or usual name of each fish species that may be present in parentheses following the collective name “fish protein”, e.g., “fish protein (contains one or more of the following: Pollock, cod, and/or pacific whiting)”.

(c) When water is added to reconstitute, completely or partially, an ingredient permitted by paragraph (b) of this section to be declared by a class name, the position of the ingredient class name in the ingredient statement shall be determined by the weight of the unreconstituted ingredient plus the weight of the quantity of water added to reconstitute that ingredient, up to the amount of water needed to reconstitute the ingredient to single strength. Any water added in excess of the amount of water needed to reconstitute the ingredient to single strength shall be declared as “water” in the ingredient statement.

(d) When foods characterized on the label as “nondairy” contain a caseinate ingredient, the caseinate ingredient shall be followed by a parenthetical statement identifying its source. For example, if the manufacturer uses the term “nondairy” on a creamer that contains sodium caseinate, it shall include a parenthetical term such as “a milk derivative” after the listing of sodium caseinate in the ingredient list.

(e) If the percentage of an ingredient is included in the statement of ingredients, it shall be shown in parentheses following the name of the ingredient and expressed in terms of percent by weight. Percentage declarations shall be expressed to the nearest 1 percent, except that where ingredients are present at levels of 2 percent or less, they may be grouped together and expressed in accordance with the quantifying guidance set forth in paragraph (a)(2) of this section.

(f) Except as provided in §101.100, ingredients that must be declared on labeling because there is no label for the food, including foods that comply with standards of identity, shall be listed prominently and conspicuously by common or usual name in the manner prescribed by paragraph (b) of this section.

(g) When present, the ingredient list on dietary supplement products shall be located immediately below the nutrition label, or, if there is insufficient space below the nutrition label, immediately contiguous and to the right of the nutrition label and shall be preceded by the word “Ingredients,” unless some ingredients (i.e., sources) are identified within the nutrition label in accordance with §101.36(d), in which case the ingredients listed outside the nutrition label shall be in a list preceded by the words “Other ingredients.” Ingredients in dietary supplements that are not dietary ingredients or that do not contain dietary ingredients, such as excipients, fillers, artificial colors, artificial sweeteners, flavors, or binders, shall be included in the ingredient list.

(h) The common or usual name of ingredients of dietary supplements that are botanicals (including fungi and algae) shall be consistent with the names standardized in *Herbs of Commerce*, 1992 edition, which is incorporated by reference in accordance with 5 U.S.C. 552(a) and 1 CFR part 51. Copies may be obtained from the American Herbal Products Association, 8484 Georgia Ave., suite 370, Silver Spring, MD 20910, 301-588-1171, FAX 301-588-1174, e-mail: ahpa@ahpa.org, or may be examined at the Center for Food Safety and Applied Nutrition’s Library, 5100 Paint Branch Pkwy., College Park, MD 20740, or at the National Archives and Records Administration (NARA). For information on the availability of this material at NARA, call 202-741-6030, or go to: http://www.archives.gov/federal_register/code_of_federal_regulations/ibr_locations.html. The listing of these names on the label shall be followed by statements of:

(1) The part of the plant (e.g., root, leaves) from which the dietary ingredient is derived (e.g., “Garlic bulb” or “Garlic (bulb)”), except that this designation is not required for algae. The name of the part of the plant shall be expressed in English (e.g., “flower” rather than “flos”);

(2) The Latin binomial name of the plant, in parentheses, except that this name is not required when it is available in the reference entitled: *Herbs of*

Commerce for the common or usual name listed on the label, and, when required, the Latin binomial name may be listed before the part of the plant. Any name in Latin form shall be in accordance with internationally accepted rules on nomenclature, such as those found in the *International Code of Botanical Nomenclature* and shall include the designation of the author or authors who published the Latin name, when a positive identification cannot be made in its absence. The *International Code of Botanical Nomenclature* (Tokyo Code), 1994 edition, a publication of the International Association for Plant Taxonomy, is incorporated by reference in accordance with 5 U.S.C. 552(a) and 1 CFR part 51. Copies of the *International Code of Botanical Nomenclature* may be obtained from Koeltz Scientific Books, D-61453 Königstein, Germany, and University Bookstore, Southern Illinois University, Carbondale, IL 62901-4422, 618-536-3321, FAX 618-453-5207, or may be examined at the Center for Food Safety and Applied Nutrition's Library, 5100 Paint Branch Pkwy., College Park, MD 20740, or at the National Archives and Records Administration (NARA). For information on the availability of this material at NARA, call 202-741-6030, or go to: http://www.archives.gov/federal_register/code_of_federal_regulations/ibr_locations.html.

(3) On labels of single-ingredient dietary supplements that do not include an ingredient list, the identification of the Latin binomial name, when needed, and the part of the plant may be prominently placed on the principal display panel or information panel, or included in the nutrition label.

[42 FR 14308, Mar. 15, 1977, as amended at 43 FR 12858, Mar. 28, 1978; 43 FR 24519, June 6, 1978; 48 FR 8054, Feb. 25, 1983; 55 FR 17433, Apr. 25, 1990; 58 FR 2875, Jan. 6, 1993; 62 FR 49847, Sept. 23, 1997; 62 FR 64634, Dec. 8, 1997; 64 FR 50448, Sept. 17, 1999; 66 FR 17358, Mar. 30, 2001; 66 FR 66742, Dec. 27, 2001; 68 FR 15355, Mar. 31, 2003]

§ 101.5 Food; name and place of business of manufacturer, packer, or distributor.

(a) The label of a food in packaged form shall specify conspicuously the

name and place of business of the manufacturer, packer, or distributor.

(b) The requirement for declaration of the name of the manufacturer, packer, or distributor shall be deemed to be satisfied, in the case of a corporation, only by the actual corporate name, which may be preceded or followed by the name of the particular division of the corporation. In the case of an individual, partnership, or association, the name under which the business is conducted shall be used.

(c) Where the food is not manufactured by the person whose name appears on the label, the name shall be qualified by a phrase that reveals the connection such person has with such food; such as "Manufactured for _____", "Distributed by _____", or any other wording that expresses the facts.

(d) The statement of the place of business shall include the street address, city, State, and ZIP code; however, the street address may be omitted if it is shown in a current city directory or telephone directory. The requirement for inclusion of the ZIP code shall apply only to consumer commodity labels developed or revised after the effective date of this section. In the case of nonconsumer packages, the ZIP code shall appear either on the label or the labeling (including invoice).

(e) If a person manufactures, packs, or distributes a food at a place other than his principal place of business, the label may state the principal place of business in lieu of the actual place where such food was manufactured or packed or is to be distributed, unless such statement would be misleading.

§ 101.9 Nutrition labeling of food.

(a) Nutrition information relating to food shall be provided for all products intended for human consumption and offered for sale unless an exemption is provided for the product in paragraph (j) of this section.

(1) When food is in package form, the required nutrition labeling information shall appear on the label in the format specified in this section.

(2) When food is not in package form, the required nutrition labeling information shall be displayed clearly at the point of purchase (e.g., on a

§ 101.9

21 CFR Ch. I (4–1–07 Edition)

counter card, sign, tag affixed to the product, or some other appropriate device). Alternatively, the required information may be placed in a booklet, looseleaf binder, or other appropriate format that is available at the point of purchase.

(3) Solicitation of requests for nutrition information by a statement “For nutrition information write to _____” on the label or in the labeling or advertising for a food, or providing such information in a direct written reply to a solicited or unsolicited request, does not subject the label or the labeling of a food exempted under paragraph (j) of this section to the requirements of this section if the reply to the request conforms to the requirements of this section.

(4) If any vitamin or mineral is added to a food so that a single serving provides 50 percent or more of the Reference Daily Intake (RDI) for the age group for which the product is intended, as specified in paragraph (c)(8)(iv) of this section, of any one of the added vitamins or minerals, unless such addition is permitted or required in other regulations, e.g., a standard of identity or nutritional quality guideline, or is otherwise exempted by the Commissioner, the food shall be considered a food for special dietary use within the meaning of §105.3(a)(1)(iii) of this chapter.

(b) Except as provided in §101.9(h)(3), all nutrient and food component quantities shall be declared in relation to a serving as defined in this section.

(1) The term *serving* or *serving size* means an amount of food customarily consumed per eating occasion by persons 4 years of age or older which is expressed in a common household measure that is appropriate to the food. When the food is specially formulated or processed for use by infants or by toddlers, a serving or serving size means an amount of food customarily consumed per eating occasion by infants up to 12 months of age or by children 1 through 3 years of age, respectively.

(2) Except as provided in paragraphs (b)(3), (b)(4), and (b)(6) of this section and for products that are intended for weight control and are available only through a weight-control or weight-

maintenance program, serving size declared on a product label shall be determined from the “Reference Amounts Customarily Consumed Per Eating Occasion * * *” (reference amounts) that appear in §101.12(b) using the procedures described below. For products that are both intended for weight control and available only through a weight-control program, a manufacturer may determine the serving size that is consistent with the meal plan of the program. Such products must bear a statement, “for sale only through the _____ program” (fill in the blank with the name of the appropriate weight-control program, e.g., Smith’s Weight Control), on the principal display panel. However, the reference amounts in §101.12(b) shall be used for purposes of evaluating whether weight-control products that are available only through a weight-control program qualify for nutrient content claims or health claims.

(i) For products in discrete units (e.g., muffins, sliced products, such as sliced bread, or individually packaged products within a multiserving package) and for products which consist of two or more foods packaged and presented to be consumed together where the ingredient represented as the main ingredient is in discrete units (e.g., pancakes and syrup), the serving size shall be declared as follows:

(A) If a unit weighs 50 percent or less of the reference amount, the serving size shall be the number of whole units that most closely approximates the reference amount for the product category;

(B) If a unit weighs more than 50 percent, but less than 67 percent of the reference amount, the manufacturer may declare one unit or two units as the serving size;

(C) If a unit weighs 67 percent or more, but less than 200 percent of the reference amount, the serving size shall be one unit;

(D) If a unit weighs 200 percent or more of the reference amount, the manufacturer may declare one unit as the serving size if the whole unit can reasonably be consumed at a single-eating occasion.

(E) For products that have reference amounts of 100 grams (g) (or milliliter

(mL)) or larger and are individual units within a multiserving package, if a unit contains more than 150 percent but less than 200 percent of the reference amount, the manufacturer may decide whether to declare the individual unit as 1 or 2 servings.

(F) The serving size for maraschino cherries shall be expressed as 1 cherry with the parenthetical metric measure equal to the average weight of a medium size cherry.

(G) The serving size for products that naturally vary in size (e.g., pickles, shellfish, whole fish, and fillet of fish) may be the amount in ounces that most closely approximates the reference amount for the product category. Manufacturers shall adhere to the requirements in paragraph (b)(5)(vi) of this section for expressing the serving size in ounces.

(H) For products which consist of two or more foods packaged and presented to be consumed together where the ingredient represented as the main ingredient is in discrete units (e.g., pancakes and syrup), the serving size may be the number of discrete units represented as the main ingredient plus proportioned minor ingredients used to make the reference amount for the combined product determined in §101.12(f).

(I) For packages containing several individual single-serving containers, each of which is labeled with all required information including nutrition labeling as specified in §101.9 (that is, are labeled appropriately for individual sale as single-serving containers), the serving size shall be 1 unit.

(ii) For products in large discrete units that are usually divided for consumption (e.g., cake, pie, pizza, melon, cabbage), for unprepared products where the entire contents of the package is used to prepare large discrete units that are usually divided for consumption (e.g., cake mix, pizza kit), and for products which consist of two or more foods packaged and presented to be consumed together where the ingredient represented as the main ingredient is a large discrete unit usually divided for consumption (e.g., prepared cake packaged with a can of frosting), the serving size shall be the fractional slice of the ready-to-eat product (e.g.,

1/12 cake, 1/8 pie, 1/4 pizza, 1/4 melon, 1/6 cabbage) that most closely approximates the reference amount for the product category, and may be the fraction of the package used to make the reference amount for the unprepared product determined in §101.12(c) or the fraction of the large discrete unit represented as the main ingredient plus proportioned minor ingredients used to make the reference amount for the combined product determined in §101.12(f). In expressing the fractional slice, manufacturers shall use 1/2, 1/3, 1/4, 1/5, 1/6, or smaller fractions that can be generated by further division by 2 or 3.

(iii) For nondiscrete bulk products (e.g., breakfast cereal, flour, sugar, dry mixes, concentrates, pancake mixes, macaroni and cheese kits), and for products which consist of two or more foods packaged and presented to be consumed together where the ingredient represented as the main ingredient is a bulk product (e.g., peanut butter and jelly), the serving size shall be the amount in household measure that most closely approximates the reference amount for the product category and may be the amount of the bulk product represented as the main ingredient plus proportioned minor ingredients used to make the reference amount for the combined product determined in §101.12(f).

(3) The serving size for meal products and main dish products as defined in §101.13 (l) and (m) that comes in single-serving containers as defined in paragraph (b)(6) of this section shall be the entire content (edible portion only) of the package. Serving size for meal products and main dish products in multiserving containers shall be based on the reference amount applicable to the product in §101.12(b) if the product is listed in §101.12(b). Serving size for meal products and main dish products in multiserving containers that are not listed in §101.12(b) shall be based on the reference amount according to §101.12(f).

(4) A variety pack, such as a package containing several varieties of single-serving units as defined in paragraph (b)(2)(i) of this section, and a product having two or more compartments with each compartment containing a

different food, shall provide nutrition information for each variety or food per serving size that is derived from the reference amount in §101.12(b) applicable for each variety or food and the procedures to convert the reference amount to serving size in paragraph (b)(2) of this section.

(5) For labeling purposes, the term *common household measure* or *common household unit* means cup, tablespoon, teaspoon, piece, slice, fraction (e.g., 1/4 pizza), ounce (oz), fluid ounce (fl oz), or other common household equipment used to package food products (e.g., jar, tray). In expressing serving size in household measures, except as specified in paragraphs (b)(5)(iv), (b)(5)(v), (b)(5)(vi), and (b)(5)(vii) of this section, the following rules shall be used:

(i) Cups, tablespoons, or teaspoons shall be used wherever possible and appropriate except for beverages. For beverages, a manufacturer may use fluid ounces. Cups shall be expressed in 1/4- or 1/3-cup increments. Tablespoons shall be expressed as 1, 1 1/3, 1 1/2, 1 2/3, 2, or 3 tablespoons. Teaspoons shall be expressed as 1/8, 1/4, 1/2, 3/4, 1, or 2 teaspoons.

(ii) If cups, tablespoons or teaspoons are not applicable, units such as piece, slice, tray, jar, and fraction shall be used.

(iii) If paragraphs (b)(5)(i) and (b)(5)(ii) of this section are not applicable, ounces may be used with an appropriate visual unit of measure such as a dimension of a piece, e.g., 1 oz (28 g/about 1/2 pickle). Ounce measurements shall be expressed in 0.5 oz increments most closely approximating the reference amount.

(iv) A description of the individual container or package shall be used for single serving containers and for individually packaged products within multiserving containers (e.g., can, box, package). A description of the individual unit shall be used for other products in discrete units (e.g., piece, slice, cracker, bar).

(v) For unprepared products where the entire contents of the package is used to prepare large discrete units that are usually divided for consumption (e.g., cake mix, pizza kit), the fraction or portion of the package may be used.

(vi) Ounces with an appropriate visual unit of measure, as described in paragraph (b)(5)(iii) of this section, may be used for products that naturally vary in size as provided for in paragraph (b)(2)(i)(G) of this section.

(vii) As provided for in §101.9(h)(1), for products that consist of two or more distinct ingredients or components packaged and presented to be consumed together (e.g. dry macaroni and cheese mix, cake and muffin mixes with separate ingredient packages, pancakes and syrup), nutrition information may be declared for each component or as a composite. The serving size may be provided in accordance with the provisions of paragraphs (b)(2)(i), (b)(2)(ii), and (b)(2)(iii) of this section, or alternatively in ounces with an appropriate visual unit of measure, as described in paragraph (b)(5)(iii) of this section (e.g., declared as separate components: “3 oz dry macaroni (84 g/about 2/3 cup)” and “1 oz dry cheese mix (28 g/about 2 tbsp);” declared as a composite value: “4 oz (112 g/about 2/3 cup macaroni and 2 tbsp dry cheese mix)”).

(viii) For nutrition labeling purposes, a teaspoon means 5 milliliters (mL), a tablespoon means 15 mL, a cup means 240 mL, 1 fl oz means 30 mL, and 1 oz in weight means 28 g.

(ix) When a serving size, determined from the reference amount in §101.12(b) and the procedures described in this section, falls exactly half way between two serving sizes, e.g., 2.5 tbsp, manufacturers shall round the serving size up to the next incremental size.

(6) A product that is packaged and sold individually and that contains less than 200 percent of the applicable reference amount shall be considered to be a single-serving container, and the entire content of the product shall be labeled as one serving except for products that have reference amounts of 100 g (or mL) or larger, manufacturers may decide whether a package that contains more than 150 percent but less than 200 percent of the reference amount is 1 or 2 servings. Packages sold individually that contain 200 percent or more of the applicable reference amount may be labeled as a single-serving if the entire content of the package can reasonably

be consumed at a single-eating occasion.

(7) A label statement regarding a serving shall be the serving size expressed in common household measures as set forth in paragraphs (b)(2) through (b)(6) of this section and shall be followed by the equivalent metric quantity in parenthesis (fluids in milliliters and all other foods in grams) except for single-serving containers.

(i) For a single-serving container, the parenthetical metric quantity, which will be presented as part of the net weight statement on the principal display panel, is not required except where nutrition information is required on a drained weight basis according to §101.9(b)(9). However, if a manufacturer voluntarily provides the metric quantity on products that can be sold as single servings, then the numerical value provided as part of the serving size declaration must be identical to the metric quantity declaration provided as part of the net quantity of contents statement.

(ii) The gram or milliliter quantity equivalent to the household measure should be rounded to the nearest whole number except for quantities that are less than 5 g (mL). The gram (mL) quantity between 2 and 5 g (mL) should be rounded to the nearest 0.5 g (mL) and the g (mL) quantity less than 2 g (mL) should be expressed in 0.1-g (mL) increments.

(iii) In addition, serving size may be declared in ounce and fluid ounce, in parenthesis, following the metric measure separated by a slash where other common household measures are used as the primary unit for serving size, e.g., 1 slice (28 g/1 oz) for sliced bread. The ounce quantity equivalent to the metric quantity should be expressed in 0.1 oz increments.

(iv) If a manufacturer elects to use abbreviations for units, the following abbreviations shall be used: tbs for tablespoon, tsp for teaspoon, g for gram, mL for milliliter, oz for ounce, and fl oz for fluid ounce.

(v) For products that only require the addition of water or another ingredient that contains insignificant amounts of nutrients in the amount added and that are prepared in such a way that there are no significant

changes to the nutrient profile, the amount of the finished product may be declared in parentheses at the end of the serving size declaration (e.g., 1/2 cup (120 mL) concentrated soup (makes 1 cup prepared)).

(vi) To promote uniformity in label serving sizes in household measures declared by different manufacturers, FDA has provided a guidance document entitled, "Guidelines for Determining the Gram Weight of the Household Measure." The guidance document can be obtained from the Office of Nutritional Products, Labeling and Dietary Supplements (HFS-800), Center for Food Safety and Applied Nutrition, Food and Drug Administration, 5100 Paint Branch Pkwy., College Park, MD 20740.

(8) Determination of the number of servings per container shall be based on the serving size of the product determined by following the procedures described in this section.

(i) The number of servings shall be rounded to the nearest whole number except for the number of servings between 2 and 5 servings and random weight products. The number of servings between 2 and 5 servings shall be rounded to the nearest 0.5 serving. Rounding should be indicated by the use of the term *about* (e.g., about 2 servings, about 3.5 servings).

(ii) When the serving size is required to be expressed on a drained solids basis and the number of servings varies because of a natural variation in unit size (e.g., maraschino cherries, pickles), the manufacturer may state the typical number of servings per container (e.g., usually 5 servings).

(iii) For random weight products, a manufacturer may declare "varied" for the number of servings per container provided the nutrition information is based on the reference amount expressed in ounces. The manufacturer may provide the typical number of servings in parenthesis following the "varied" statement.

(iv) For packages containing several individual single-serving containers, each of which is labeled with all required information including nutrition labeling as specified in §101.9 (that is, are labeled appropriately for individual sale as single-serving containers), the number of servings shall be the number

§ 101.9

21 CFR Ch. I (4–1–07 Edition)

of individual packages within the total package.

(v) For packages containing several individually packaged multiserving units, the number of servings shall be determined by multiplying the number of individual multiserving units in the total package by the number of servings in each individual unit.

(9) The declaration of nutrient and food component content shall be on the basis of food as packaged or purchased with the exception of raw fish covered under § 101.42 (see 101.44), packaged single-ingredient products that consist of fish or game meat as provided for in paragraph (j)(11) of this section, and of foods that are packed or canned in water, brine, or oil but whose liquid packing medium is not customarily consumed (e.g., canned fish, maraschino cherries, pickled fruits, and pickled vegetables). Declaration of nutrient and food component content of raw fish shall follow the provisions in § 101.45. Declaration of the nutrient and food component content of foods that are packed in liquid which is not customarily consumed shall be based on the drained solids.

(10) Another column of figures may be used to declare the nutrient and food component information:

(i) Per 100 g or 100 mL, or per 1 oz or 1 fl oz of the food as packaged or purchased;

(ii) Per one unit if the serving size of a product in discrete units in a multiserving container is more than 1 unit;

(iii) Per cup popped for popcorn in a multiserving container.

(11) If a product is promoted on the label, labeling, or advertising for a use that differs in quantity by twofold or greater from the use upon which the reference amount in § 101.12(b) was based (e.g., liquid cream substitutes promoted for use with breakfast cereals), the manufacturer shall provide a second column of nutrition information based on the amount customarily consumed in the promoted use, in addition to the nutrition information per serving derived from the reference amount in § 101.12(b), except that non-discrete bulk products that are used primarily as ingredients (e.g., flour, sweeteners, shortenings, oils), or traditionally used for multipurposes (e.g.,

eggs, butter, margarine), and multipurpose baking mixes are exempt from this requirement.

(c) The declaration of nutrition information on the label and in labeling of a food shall contain information about the level of the following nutrients, except for those nutrients whose inclusion, and the declaration of amounts, is voluntary as set forth in this paragraph. No nutrients or food components other than those listed in this paragraph as either mandatory or voluntary may be included within the nutrition label. Except as provided for in paragraphs (f) or (j) of this section, nutrient information shall be presented using the nutrient names specified and in the following order in the formats specified in paragraphs (d) or (e) of this section.

(1) “Calories, total,” “Total calories,” or “Calories”: A statement of the caloric content per serving, expressed to the nearest 5-calorie increment up to and including 50 calories, and 10-calorie increment above 50 calories, except that amounts less than 5 calories may be expressed as zero. Energy content per serving may also be expressed in kilojoule units, added in parentheses immediately following the statement of the caloric content.

(i) Caloric content may be calculated by the following methods. Where either specific or general food factors are used, the factors shall be applied to the actual amount (i.e., before rounding) of food components (e.g., fat, carbohydrate, protein, or ingredients with specific food factors) present per serving.

(A) Using specific Atwater factors (i.e., the Atwater method) given in Table 13, “Energy Value of Foods—Basis and Derivation,” by A. L. Merrill and B. K. Watt, United States Department of Agriculture (USDA) Handbook No. 74 (slightly revised, 1973), which is incorporated by reference in accordance with 5 U.S.C. 552(a) and 1 CFR part 51 and is available from the Office of Nutritional Products, Labeling and Dietary Supplements (HFS-800), Center for Food Safety and Applied Nutrition, Food and Drug Administration, 5100 Paint Branch Pkwy., College Park, MD

20740, or may be inspected at the National Archives and Records Administration (NARA). For information on the availability of this material at NARA, call 202-741-6030, or go to: http://www.archives.gov/federal_register/code_of_federal_regulations/ibr_locations.html;

(B) Using the general factors of 4, 4, and 9 calories per gram for protein, total carbohydrate, and total fat, respectively, as described in USDA Handbook No. 74 (slightly revised 1973) pp. 9-11, which is incorporated by reference in accordance with 5 U.S.C. 552(a) and 1 CFR part 51 (the availability of this incorporation by reference is given in paragraph (c)(1)(i)(A) of this section);

(C) Using the general factors of 4, 4, and 9 calories per gram for protein, total carbohydrate less the amount of insoluble dietary fiber, and total fat, respectively, as described in USDA Handbook No. 74 (slightly revised 1973) pp. 9-11, which is incorporated by reference in accordance with 5 U.S.C. 552(a) and 1 CFR part 51 (the availability of this incorporation by reference is given in paragraph (c)(1)(i)(A) of this section);

(D) Using data for specific food factors for particular foods or ingredients approved by the Food and Drug Administration (FDA) and provided in parts 172 or 184 of this chapter, or by other means, as appropriate; or

(E) Using bomb calorimetry data subtracting 1.25 calories per gram protein to correct for incomplete digestibility, as described in USDA Handbook No. 74 (slightly revised 1973) p. 10, which is incorporated by reference in accordance with 5 U.S.C. 552(a) and 1 CFR part 51 (the availability of this incorporation by reference is given in paragraph (c)(1)(i)(A) of this section).

(ii) "Calories from fat": A statement of the caloric content derived from total fat as defined in paragraph (c)(2) of this section in a serving, expressed to the nearest 5-calorie increment, up to and including 50 calories, and the nearest 10-calorie increment above 50 calories, except that label declaration of "calories from fat" is not required on products that contain less than 0.5 gram of fat in a serving and amounts less than 5 calories may be expressed as zero. This statement shall be declared

as provided in paragraph (d)(5) of this section. Except as provided for in paragraph (f) of this section, if "Calories from fat" is not required and, as a result, not declared, the statement "Not a significant source of calories from fat" shall be placed at the bottom of the table of nutrient values in the same type size.

(iii) "Calories from saturated fat" or "Calories from saturated" (VOLUNTARY): A statement of the caloric content derived from saturated fat as defined in paragraph (c)(2)(i) of this section in a serving may be declared voluntarily, expressed to the nearest 5-calorie increment, up to and including 50 calories, and the nearest 10-calorie increment above 50 calories, except that amounts less than 5 calories may be expressed as zero. This statement shall be indented under the statement of calories from fat as provided in paragraph (d)(5) of this section.

(2) "Fat, total" or "Total fat": A statement of the number of grams of total fat in a serving defined as total lipid fatty acids and expressed as triglycerides. Amounts shall be expressed to the nearest 0.5 (1/2) gram increment below 5 grams and to the nearest gram increment above 5 grams. If the serving contains less than 0.5 gram, the content shall be expressed as zero.

(i) "Saturated fat," or "Saturated": A statement of the number of grams of saturated fat in a serving defined as the sum of all fatty acids containing no double bonds, except that label declaration of saturated fat content information is not required for products that contain less than 0.5 gram of total fat in a serving if no claims are made about fat, fatty acid, or cholesterol content, and if "calories from saturated fat" is not declared. Except as provided for in paragraph (f) of this section, if a statement of the saturated fat content is not required and, as a result, not declared, the statement "Not a significant source of saturated fat" shall be placed at the bottom of the table of nutrient values. Saturated fat content shall be indented and expressed as grams per serving to the nearest 0.5 gram (1/2) gram increment below 5

grams and to the nearest gram increment above 5 grams. If the serving contains less than 0.5 gram, the content shall be expressed as zero.

(ii) “*Trans* fat” or “*Trans*”: A statement of the number of grams of *trans* fat in a serving, defined as the sum of all unsaturated fatty acids that contain one or more isolated (i.e., nonconjugated) double bonds in a *trans* configuration, except that label declaration of *trans* fat content information is not required for products that contain less than 0.5 gram of total fat in a serving if no claims are made about fat, fatty acid or cholesterol content. The word “*trans*” may be italicized to indicate its Latin origin. *Trans* fat content shall be indented and expressed as grams per serving to the nearest 0.5 (1/2)-gram increment below 5 grams and to the nearest gram increment above 5 grams. If the serving contains less than 0.5 gram, the content, when declared, shall be expressed as zero. Except as provided for in paragraph (f) of this section, if a statement of the *trans* fat content is not required and, as a result, not declared, the statement “Not a significant source of *trans* fat” shall be placed at the bottom of the table of nutrient values.

(iii) “Polyunsaturated fat” or “Polyunsaturated” (VOLUNTARY): A statement of the number of grams of polyunsaturated fat in a serving defined as *cis,cis*-methylene-interrupted polyunsaturated fatty acids may be declared voluntarily, except that when monounsaturated fat is declared, or when a claim about fatty acids or cholesterol is made on the label or in labeling of a food other than one that meets the criteria in §101.62(b)(1) for a claim for “fat free,” label declaration of polyunsaturated fat is required. Polyunsaturated fat content shall be indented and expressed as grams per serving to the nearest 0.5 (1/2) gram increment below 5 grams and to the nearest gram increment above 5 grams. If the serving contains less than 0.5 gram, the content shall be expressed as zero.

(iv) “Monounsaturated fat” or “Monounsaturated” (VOLUNTARY): A statement of the number of grams of monounsaturated fat in a serving defined as *cis*-monounsaturated fatty acids may be declared voluntarily ex-

cept that when polyunsaturated fat is declared, or when a claim about fatty acids or cholesterol is made on the label or in labeling of a food other than one that meets the criteria in §101.62(b)(1) for a claim for “fat free,” label declaration of monounsaturated fat is required. Monounsaturated fat content shall be indented and expressed as grams per serving to the nearest 0.5 (1/2) gram increment below 5 grams and to the nearest gram increment above 5 grams. If the serving contains less than 0.5 gram, the content shall be expressed as zero.

(3) “Cholesterol”: A statement of the cholesterol content in a serving expressed in milligrams to the nearest 5-milligram increment, except that label declaration of cholesterol information is not required for products that contain less than 2 milligrams cholesterol in a serving and make no claim about fat, fatty acids, or cholesterol content, or such products may state the cholesterol content as zero. Except as provided for in paragraph (f) of this section, if cholesterol content is not required and, as a result, not declared, the statement “Not a significant source of cholesterol” shall be placed at the bottom of the table of nutrient values in the same type size. If the food contains 2 to 5 milligrams of cholesterol per serving, the content may be stated as “less than 5 milligrams.”

(4) “Sodium”: A statement of the number of milligrams of sodium in a specified serving of food expressed as zero when the serving contains less than 5 milligrams of sodium, to the nearest 5-milligram increment when the serving contains 5 to 140 milligrams of sodium, and to the nearest 10-milligram increment when the serving contains greater than 140 milligrams.

(5) “Potassium” (VOLUNTARY): A statement of the number of milligrams of potassium in a specified serving of food may be declared voluntarily, except that when a claim is made about potassium content, label declaration shall be required. Potassium content shall be expressed as zero when the serving contains less than 5 milligrams of potassium, to the nearest 5-milligram increment when the serving contains less than or equal to 140 milligrams of potassium, and to the nearest

10-milligram increment when the serving contains more than 140 milligrams.

(6) "Carbohydrate, total" or "Total carbohydrate": A statement of the number of grams of total carbohydrate in a serving expressed to the nearest gram, except that if a serving contains less than 1 gram, the statement "Contains less than 1 gram" or "less than 1 gram" may be used as an alternative, or if the serving contains less than 0.5 gram, the content may be expressed as zero. Total carbohydrate content shall be calculated by subtraction of the sum of the crude protein, total fat, moisture, and ash from the total weight of the food. This calculation method is described in A. L. Merrill and B. K. Watt, "Energy Value of Foods—Basis and Derivation," USDA Handbook 74 (slightly revised 1973) pp. 2 and 3, which is incorporated by reference in accordance with 5 U.S.C. 552(a) and 1 CFR part 51 (the availability of this incorporation by reference is given in paragraph (c)(1)(i)(A) of this section).

(i) "Dietary fiber": A statement of the number of grams of total dietary fiber in a serving, indented and expressed to the nearest gram, except that if a serving contains less than 1 gram, declaration of dietary fiber is not required or, alternatively, the statement "Contains less than 1 gram" or "less than 1 gram" may be used, and if the serving contains less than 0.5 gram, the content may be expressed as zero. Except as provided for in paragraph (f) of this section, if dietary fiber content is not required and as a result, not declared, the statement "Not a significant source of dietary fiber" shall be placed at the bottom of the table of nutrient values in the same type size.

(A) "Soluble fiber" (VOLUNTARY): A statement of the number of grams of soluble dietary fiber in a serving may be declared voluntarily except when a claim is made on the label or in labeling about soluble fiber, label declaration shall be required. Soluble fiber content shall be indented under dietary fiber and expressed to the nearest gram, except that if a serving contains less than 1 gram, the statement "Contains less than 1 gram" or "less than 1 gram" may be used as an alternative, and if the serving contains less than 0.5

gram, the content may be expressed as zero.

(B) "Insoluble fiber" (VOLUNTARY): A statement of the number of grams of insoluble dietary fiber in a serving may be declared voluntarily except that when a claim is made on the label or in labeling about insoluble fiber, label declaration shall be required. Insoluble fiber content shall be indented under dietary fiber and expressed to the nearest gram except that if a serving contains less than 1 gram, the statement "Contains less than 1 gram" or "less than 1 gram" may be used as an alternative, and if the serving contains less than 0.5 gram, the content may be expressed as zero.

(ii) "Sugars": A statement of the number of grams of sugars in a serving, except that label declaration of sugars content is not required for products that contain less than 1 gram of sugars in a serving if no claims are made about sweeteners, sugars, or sugar alcohol content. Except as provided for in paragraph (f) of this section, if a statement of the sugars content is not required and, as a result, not declared, the statement "Not a significant source of sugars" shall be placed at the bottom of the table of nutrient values in the same type size. Sugars shall be defined as the sum of all free mono- and disaccharides (such as glucose, fructose, lactose, and sucrose). Sugars content shall be indented and expressed to the nearest gram, except that if a serving contains less than 1 gram, the statement "Contains less than 1 gram" or "less than 1 gram" may be used as an alternative, and if the serving contains less than 0.5 gram, the content may be expressed as zero.

(iii) "Sugar alcohol" (VOLUNTARY): A statement of the number of grams of sugar alcohols in a serving may be declared voluntarily on the label, except that when a claim is made on the label or in labeling about sugar alcohol or sugars when sugar alcohols are present in the food, sugar alcohol content shall be declared. For nutrition labeling purposes, sugar alcohols are defined as the sum of saccharide derivatives in which a hydroxyl group replaces a ketone or aldehyde group and whose use in the food is listed by FDA (e.g., mannitol or xylitol) or is generally recognized as

safe (e.g., sorbitol). In lieu of the term “sugar alcohol,” the name of the specific sugar alcohol (e.g., “xylitol”) present in the food may be used in the nutrition label provided that only one sugar alcohol is present in the food. Sugar alcohol content shall be indented and expressed to the nearest gram, except that if a serving contains less than 1 gram, the statement “Contains less than 1 gram” or “less than 1 gram” may be used as an alternative, and if the serving contains less than 0.5 gram, the content may be expressed as zero.

(iv) “Other carbohydrate” (VOLUNTARY): A statement of the number of grams of other carbohydrates may be declared voluntarily. Other carbohydrates shall be defined as the difference between total carbohydrate and the sum of dietary fiber, sugars, and sugar alcohol, except that if sugar alcohol is not declared (even if present), it shall be defined as the difference between total carbohydrate and the sum of dietary fiber and sugars. Other carbohydrate content shall be indented and expressed to the nearest gram, except that if a serving contains less than 1 gram, the statement “Contains less than 1 gram” or “less than 1 gram” may be used as an alternative, and if the serving contains less than 0.5 gram, the content may be expressed as zero.

(7) “Protein”: A statement of the number of grams of protein in a serving, expressed to the nearest gram, except that if a serving contains less than 1 gram, the statement “Contains less than 1 gram” or “less than 1 gram” may be used as an alternative, and if the serving contains less than 0.5 gram, the content may be expressed as zero. When the protein in foods represented or purported to be for adults and children 4 or more years of age has a protein quality value that is a protein digestibility-corrected amino acid score of less than 20 expressed as a percent, or when the protein in a food represented or purported to be for children greater than 1 but less than 4 years of age has a protein quality value that is a protein digestibility-corrected amino acid score of less than 40 expressed as a percent, either of the following shall be placed adjacent to the declaration of

protein content by weight: The statement “not a significant source of protein,” or a listing aligned under the column headed “Percent Daily Value” of the corrected amount of protein per serving, as determined in paragraph (c)(7)(ii) of this section, calculated as a percentage of the Daily Reference Value (DRV) or Reference Daily Intake (RDI), as appropriate, for protein and expressed as Percent of Daily Value. When the protein quality in a food as measured by the Protein Efficiency Ratio (PER) is less than 40 percent of the reference standard (casein) for a food represented or purported to be for infants, the statement “not a significant source of protein” shall be placed adjacent to the declaration of protein content. Protein content may be calculated on the basis of the factor of 6.25 times the nitrogen content of the food as determined by the appropriate method of analysis as given in the “Official Methods of Analysis of the AOAC International” (formerly the Association of Official Analytical Chemists), 15th Ed. (1990), which is incorporated by reference in accordance with 5 U.S.C. 552(a) and 1 CFR part 51, except when the official procedure for a specific food requires another factor. Copies may be obtained from AOAC INTERNATIONAL, 481 North Frederick Ave., suite 500, Gaithersburg, MD 20877, or may be inspected at the National Archives and Records Administration (NARA). For information on the availability of this material at NARA, call 202-741-6030, or go to: http://www.archives.gov/federal_register/code_of_federal_regulations/ibr_locations.html.

(i) A statement of the corrected amount of protein per serving, as determined in paragraph (c)(7)(ii) of this section, calculated as a percentage of the RDI or DRV for protein, as appropriate, and expressed as Percent of Daily Value, may be placed on the label, except that such a statement shall be given if a protein claim is made for the product, or if the product is represented or purported to be for use by infants or children under 4 years of age. When such a declaration is provided, it shall be placed on the label adjacent to the statement of grams of protein and aligned under the column

headed "Percent Daily Value," and expressed to the nearest whole percent. However, the percentage of the RDI for protein shall not be declared if the food is represented or purported to be for use by infants and the protein quality value is less than 40 percent of the reference standard.

(ii) The "corrected amount of protein (gram) per serving" for foods represented or purported for adults and children 1 or more years of age is equal to the actual amount of protein (gram) per serving multiplied by the amino acid score corrected for protein digestibility. If the corrected score is above 1.00, then it shall be set at 1.00. The protein digestibility-corrected amino acid score shall be determined by methods given in sections 5.4.1, 7.2.1, and 8.00 in "Protein Quality Evaluation, Report of the Joint FAO/WHO Expert Consultation on Protein Quality Evaluation," Rome, 1990, except that when official AOAC procedures described in section (c)(7) of this paragraph require a specific food factor other than 6.25, that specific factor shall be used. The "Report of the Joint FAO/WHO Expert Consultation on Protein Quality Evaluation" as published by the Food and Agriculture Organization of the United Nations/World Health Organization is incorporated by reference in accordance with 5 U.S.C. 552(a) and 1 CFR part 51. Copies are available from the Center for Food Safety and Applied Nutrition (HFS-800), Food and Drug Administration, 5100 Paint Branch Pkwy., College Park, MD 20740, or may be inspected at the National Archives and Records Administration (NARA). For information on the availability of this material at NARA, call 202-741-6030, or go to: http://www.archives.gov/federal_register/code_of_federal_regulations/ibr_locations.html. For foods represented or purported for infants, the corrected amount of protein (grams) per serving is equal to the actual amount of protein (grams) per serving multiplied by the relative protein quality value. The relative protein quality value shall be determined by dividing the subject food protein PER value by the PER value for casein. If the relative protein value is above 1.00, it shall be set at 1.00.

(iii) For the purpose of labeling with a percent of the Daily Reference Value (DRV) or RDI, a value of 50 grams of protein shall be the DRV for adults and children 4 or more years of age, and the RDI for protein for children less than 4 years of age, infants, pregnant women, and lactating women shall be 16 grams, 14 grams, 60 grams, and 65 grams, respectively.

(8) Vitamins and minerals: A statement of the amount per serving of the vitamins and minerals as described in this paragraph, calculated as a percent of the RDI and expressed as percent of Daily Value.

(i) For purposes of declaration of percent of Daily Value as provided for in paragraphs (d), (e), and (f) of this section, foods represented or purported to be for use by infants, children less than 4 years of age, pregnant women, or lactating women shall use the RDI's that are specified for the intended group. For foods represented or purported to be for use by both infants and children under 4 years of age, the percent of Daily Value shall be presented by separate declarations according to paragraph (e) of this section based on the RDI values for infants from birth to 12 months of age and for children under 4 years of age. Similarly, the percent of Daily Value based on both the RDI values for pregnant women and for lactating women shall be declared separately on foods represented or purported to be for use by both pregnant and lactating women. When such dual declaration is used on any label, it shall be included in all labeling, and equal prominence shall be given to both values in all such labeling. All other foods shall use the RDI for adults and children 4 or more years of age.

(ii) The declaration of vitamins and minerals as a percent of the RDI shall include vitamin A, vitamin C, calcium, and iron, in that order, and shall include any of the other vitamins and minerals listed in paragraph (c)(8)(iv) of this section when they are added as a nutrient supplement, or when a claim is made about them. Other vitamins and minerals need not be declared if neither the nutrient nor the component is otherwise referred to on the label or in labeling or advertising and the vitamins and minerals are:

§ 101.9

21 CFR Ch. I (4-1-07 Edition)

(A) Required or permitted in a standardized food (e.g., thiamin, riboflavin, and niacin in enriched flour) and that standardized food is included as an ingredient (i.e., component) in another food; or

(B) Included in a food solely for technological purposes and declared only in the ingredient statement. The declaration may also include any of the other vitamins and minerals listed in paragraph (c)(8)(iv) of this section when they are naturally occurring in the food. The additional vitamins and minerals shall be listed in the order established in paragraph (c)(8)(iv) of this section.

(iii) The percentages for vitamins and minerals shall be expressed to the nearest 2-percent increment up to and including the 10-percent level, the nearest 5-percent increment above 10 percent and up to and including the 50-percent level, and the nearest 10-percent increment above the 50-percent level. Amounts of vitamins and minerals present at less than 2 percent of the RDI are not required to be declared in nutrition labeling but may be declared by a zero or by the use of an asterisk (or other symbol) that refers to another asterisk (or symbol) that is placed at the bottom of the table and that is followed by the statement "Contains less than 2 percent of the Daily Value of this (these) nutrient (nutrients)" or "Contains < 2 percent of the Daily Value of this (these) nutrient (nutrients)." Alternatively, except as provided for in paragraph (f) of this section, if vitamin A, vitamin C, calcium, or iron is present in amounts less than 2 percent of the RDI, label declaration of the nutrient(s) is not required if the statement "Not a significant source of _ (listing the vitamins or minerals omitted)" is placed at the bottom of the table of nutrient values. Either statement shall be in the same type size as nutrients that are indented.

(iv) The following RDI's and nomenclature are established for the following vitamins and minerals which are essential in human nutrition:

- Vitamin A, 5,000 International Units
- Vitamin C, 60 milligrams
- Calcium, 1,000 milligrams
- Iron, 18 milligrams

- Vitamin D, 400 International Units
- Vitamin E, 30 International Units
- Vitamin K, 80 micrograms
- Thiamin, 1.5 milligrams
- Riboflavin, 1.7 milligrams
- Niacin, 20 milligrams
- Vitamin B₆, 2.0 milligrams
- Folate, 400 micrograms
- Vitamin B₁₂, 6 micrograms
- Biotin, 300 micrograms
- Pantothenic acid, 10 milligrams
- Phosphorus, 1,000 milligrams
- Iodine, 150 micrograms
- Magnesium, 400 milligrams
- Zinc, 15 milligrams
- Selenium, 70 micrograms
- Copper, 2.0 milligrams
- Manganese, 2.0 milligrams
- Chromium, 120 micrograms
- Molybdenum, 75 micrograms
- Chloride, 3,400 milligrams

(v) The following synonyms may be added in parentheses immediately following the name of the nutrient or dietary component:

- Calories—Energy
 - Vitamin C—Ascorbic acid
 - Thiamin—Vitamin B₁
 - Riboflavin—Vitamin B₂
 - Folate—Folic acid or Folacin.
- Alternatively, folic acid or folacin may be listed without parentheses in place of folate.

(vi) A statement of the percent of vitamin A that is present as *beta*-carotene may be declared voluntarily. When the vitamins and minerals are listed in a single column, the statement shall be indented under the information on vitamin A. When vitamins and minerals are arrayed horizontally, the statement of percent shall be presented in parenthesis following the declaration of vitamin A and the percent DV of vitamin A in the food (e.g., "Percent Daily Value: Vitamin A 50 (90 percent as *beta*-carotene)"). When declared, the percentages shall be expressed in the same increments as are provided for vitamins and minerals in paragraph (c)(8)(iii) of this section.

(9) For the purpose of labeling with a percent of the DRV, the following DRV's are established for the following food components based on the reference caloric intake of 2,000 calories:

Food component	Unit of measurement	DRV
Fat	gram (g)	65
Saturated fatty acids	do	20
Cholesterol	milligrams (mg)	300

Food component	Unit of measurement	DRV
Total carbohydrate	grams (g)	300
Fiber	do	25
Sodium	milligrams (mg)	2,400
Potassium	do	3,500
Protein	grams (g)	50

(d)(1) Nutrient information specified in paragraph (c) of this section shall be presented on foods in the following format, as shown in paragraph (d)(12) of this section, except on foods on which dual columns of nutrition information are declared as provided for in paragraph (e) of this section, on those food products on which the simplified format is required to be used as provided for in paragraph (f) of this section, on foods for infants and children less than 4 years of age as provided for in paragraph (j)(5) of this section, and on foods in small or intermediate-sized packages as provided for in paragraph (j)(13) of this section. In the interest of uniformity of presentation, FDA urges that the nutrition information be presented using the graphic specifications set forth in appendix B to part 101.

(i) The nutrition information shall be set off in a box by use of hairlines and shall be all black or one color type, printed on a white or other neutral contrasting background whenever practical.

(ii) All information within the nutrition label shall utilize:

(A) Except as provided for in paragraph (c)(2)(ii) of this section, a single easy-to-read type style,

(B) Upper and lower case letters,

(C) At least one point leading (i.e., space between two lines of text) except that at least four points leading shall be utilized for the information required by paragraphs (d)(7) and (d)(8) of this section as shown in paragraph (d)(12), and

(D) Letters should never touch.

(iii) Information required in paragraphs (d)(3), (d)(5), (d)(7), and (d)(8) of this section shall be in type size no smaller than 8 point. Except for the heading "Nutrition Facts," the information required in paragraphs (d)(4), (d)(6), and (d)(9) of this section and all other information contained within the nutrition label shall be in type size no smaller than 6 point. When provided, the information described in paragraph

(d)(10) of this section shall also be in type no smaller than 6 point.

(iv) The headings required by paragraphs (d)(2), (d)(4), and (d)(6) of this section (i.e., "Nutrition Facts," "Amount per Serving," and "% Daily Value*"), the names of all nutrients that are not indented according to requirements of paragraph (c) of this section (i.e., "Calories," "Total Fat," "Cholesterol," "Sodium," "Total Carbohydrate," and "Protein"), and the percentage amounts required by paragraph (d)(7)(ii) of this section shall be highlighted by bold or extra bold type or other highlighting (reverse printing is not permitted as a form of highlighting) that prominently distinguishes it from other information. No other information shall be highlighted.

(v) A hairline rule that is centered between the lines of text shall separate "Amount Per Serving" from the calorie statements required in paragraph (d)(5) of this section and shall separate each nutrient and its corresponding percent Daily Value required in paragraphs (d)(7)(i) and (d)(7)(ii) of this section from the nutrient and percent Daily Value above and below it, as shown in paragraph (d)(12) of this section.

(2) The information shall be presented under the identifying heading of "Nutrition Facts" which shall be set in a type size larger than all other print size in the nutrition label and, except for labels presented according to the format provided for in paragraph (d)(11) of this section, unless impractical, shall be set the full width of the information provided under paragraph (d)(7) of this section, as shown in paragraph (d)(12) of this section.

(3) Information on serving size shall immediately follow the heading as shown in paragraph (d)(12) of this section. Such information shall include:

(i) "Serving Size": A statement of the serving size as specified in paragraph (b)(7) of this section.

(ii) "Servings Per Container": The number of servings per container, except that this statement is not required on single serving containers as defined in paragraph (b)(6) of this section or on other food containers when this information is stated in the net quantity of contents declaration.

§ 101.9

21 CFR Ch. I (4-1-07 Edition)

(4) A subheading “Amount Per Serving” shall be separated from serving size information by a bar as shown in paragraph (d)(12) of this section.

(5) Information on calories shall immediately follow the heading “Amount Per Serving” and shall be declared in one line, leaving sufficient space between the declaration of “Calories” and “Calories from fat” to allow clear differentiation, or, if “Calories from saturated fat” is declared, in a column with total “Calories” at the top, followed by “Calories from fat” (indented), and “Calories from saturated fat” (indented).

(6) The column heading “% Daily Value,” followed by an asterisk (e.g., “% Daily Value*”), shall be separated from information on calories by a bar as shown in paragraph (d)(12) of this section. The position of this column heading shall allow for a list of nutrient names and amounts as described in paragraph (d)(7) of this section to be to the left of, and below, this column heading. The column headings “Percent Daily Value,” “Percent DV,” or “% DV” may be substituted for “% Daily Value.”

(7) Except as provided for in paragraph (j)(13) of this section, nutrient information for both mandatory and any voluntary nutrients listed in paragraph (c) of this section that are to be declared in the nutrition label, except vitamins and minerals, shall be declared as follows:

(i) The name of each nutrient, as specified in paragraph (c) of this section, shall be given in a column and followed immediately by the quantitative amount by weight for that nutrient appended with a “g” for grams or a “mg” for milligrams as shown in paragraph (d)(12) of this section. The symbol “<” may be used in place of “less than.”

(ii) A listing of the percent of the DRV as established in paragraphs (c)(7)(iii) and (c)(9) of this section shall be given in a column aligned under the heading “% Daily Value” established in paragraph (d)(6) of this section with the percent expressed to the nearest whole percent for each nutrient declared in the column described in paragraph (d)(7)(i) of this section for which a DRV has been established, except

that the percent for protein may be omitted as provided in paragraph (c)(7) of this section. The percent shall be calculated by dividing either the amount declared on the label for each nutrient or the actual amount of each nutrient (i.e., before rounding) by the DRV for the nutrient, except that the percent for protein shall be calculated as specified in paragraph (c)(7)(ii) of this section. The numerical value shall be followed by the symbol for percent (i.e., %).

(8) Nutrient information for vitamins and minerals shall be separated from information on other nutrients by a bar and shall be arrayed horizontally (e.g., Vitamin A 4%, Vitamin C 2%, Calcium 15%, Iron 4%) or may be listed in two columns as shown in paragraph (d)(12) of this section, except that when more than four vitamins and minerals are declared, they may be declared vertically with percentages listed under the column headed “% Daily Value.”

(9) A footnote, preceded by an asterisk, shall be placed beneath the list of vitamins and minerals and shall be separated from that list by a hairline.

(i) The footnote shall state:

Percent Daily Values are based on a 2,000 calorie diet.

Your daily values may be higher or lower depending on your calorie needs.

	Calories:	2,000	2,500
Total fat	Less than	65 g	80 g
Saturated fat	Less than	20 g	25 g
Cholesterol	Less than	300 mg	300 mg
Sodium	Less than	2,400 mg	2,400 mg
Total carbohydrate		300 g	375 g
Dietary fiber		25 g	30 g

(ii) If the percent of Daily Value is given for protein in the Percent of Daily Value column as provided in paragraph (d)(7)(ii) of this section, protein shall be listed under dietary fiber, and a value of 50 g shall be inserted on the same line in the column headed “2,000” and a value of 65 g in the column headed “2,500”.

(iii) If potassium is declared in the column described in paragraph (d)(7)(i) of this section, potassium shall be listed under sodium and the DRV established in paragraph (c)(9) of this section shall be inserted on the same line in the numeric columns.

(iv) The abbreviations established in paragraph (j)(13)(ii)(B) of this section may be used within the footnote.

(10) Caloric conversion information on a per gram basis for fat, carbohydrate, and protein may be presented beneath the information required in paragraph (d)(9) of this section, separated from that information by a hairline. This information may be presented horizontally as shown in paragraph (d)(12) of this section (i.e., "Calories per gram: fat 9, carbohydrate 4, protein 4") or vertically in columns.

(11)(i) If the space beneath the information on vitamins and minerals is not adequate to accommodate the information required in paragraph (d)(9) of this section, the information required in paragraph (d)(9) may be moved to the right of the column required in paragraph (d)(7)(ii) of this section and set off by a line that distinguishes it and sets it apart from the percent Daily Value information. The caloric conversion information provided for in para-

graph (d)(10) of this section may be presented beneath either side or along the full length of the nutrition label.

(ii) If the space beneath the mandatory declaration of iron is not adequate to accommodate any remaining vitamins and minerals to be declared or the information required in paragraph (d)(9) of this section, the remaining information may be moved to the right and set off by a line that distinguishes it and sets it apart from the nutrients and the percent DV information given to the left. The caloric conversion information provided for in paragraph (d)(10) of this section may be presented beneath either side or along the full length of the nutrition label.

(iii) If there is not sufficient continuous vertical space (i.e., approximately 3 in) to accommodate the required components of the nutrition label up to and including the mandatory declaration of iron, the nutrition label may be presented in a tabular display as shown below.

Nutrition Facts		Amount/serving	% Daily Value*	Amount/serving	% Daily Value*
Serving Size 2 slices (56g) Servings Per Container 10		Total Fat 1.5g	2%	Total Carbohydrate 26g	9%
		Saturated Fat 0.5g	3%	Dietary Fiber 2g	8%
		Trans Fat 0.5g		Sugars 1g	
		Cholesterol 0mg	0%	Protein 4g	
Calories 140		Sodium 280mg	12%		
Calories from Fat 15		Vitamin A 0%	• Vitamin C 0%	Calcium 6%	• Iron 6%
		Thiamin 15%	• Riboflavin 8%	Niacin 10%	
* Percent Daily Values are based on a 2,000 calorie diet. Your daily values may be higher or lower depending on your calorie needs:					
Calories: 2,000 2,500					
Total Fat	Less than	65g	80g		
Sat Fat	Less than	20g	25g		
Cholesterol	Less than	300mg	300mg		
Sodium	Less than	2,400mg	2,400mg		
Total Carbohydrate		300g	375g		
Dietary Fiber		25g	30g		

§ 101.9

21 CFR Ch. I (4-1-07 Edition)

(12) The following sample label illustrates the provisions of paragraph (d) of this section.

Nutrition Facts	
Serving Size 1 cup (228g)	
Servings Per Container 2	
Amount Per Serving	
Calories 260	Calories from Fat 120
% Daily Value*	
Total Fat 13g	20%
Saturated Fat 5g	25%
<i>Trans</i> Fat 2g	
Cholesterol 30mg	10%
Sodium 660mg	28%
Total Carbohydrate 31g	10%
Dietary Fiber 0g	0%
Sugars 5g	
Protein 5g	
Vitamin A 4%	• Vitamin C 2%
Calcium 15%	• Iron 4%
*Percent Daily Values are based on a 2,000 calorie diet. Your Daily Values may be higher or lower depending on your calorie needs:	
	Calories: 2,000 2,500
Total Fat	Less than 65g 80g
Sat Fat	Less than 20g 25g
Cholesterol	Less than 300mg 300mg
Sodium	Less than 2,400mg 2,400mg
Total Carbohydrate	300g 375g
Dietary Fiber	25g 30g
Calories per gram:	
Fat 9	• Carbohydrate 4 • Protein 4

(13)(i) Nutrition labels on the outer label of packages of products that contain two or more separately packaged foods that are intended to be eaten individually (e.g., variety packs of cereals or snack foods) or of packages that are used interchangeably for the same type of food (e.g., round ice cream containers) may use an aggregate display.

(ii) Aggregate displays shall comply with the format requirements of paragraph (d) of this section to the maximum extent possible, except that the identity of each food shall be specified immediately under the "Nutrition Facts" title, and both the quantitative amount by weight (i.e., g/mg amounts) and the percent Daily Value for each nutrient shall be listed in separate columns under the name of each food. The following sample label illustrates an aggregate display.

Nutrition Facts	Wheat Squares Sweetened		Corn Flakes Not Sweetened		Mixed Grain Flakes Sweetened	
	(35g)		(19g)		(27g)	
Serving Size 1 Box	1		1		1	
Servings Per Container	1		1		1	
Amount Per Serving						
Calories	130		70		100	
Calories from Fat	0		0		0	
	% Daily Value*		% Daily Value*		% Daily Value*	
Total Fat	0g	0%	0g	0%	0g	0%
Saturated Fat	0g	0%	0g	0%	0g	0%
Trans Fat	0g		0g		0g	
Cholesterol	0mg	0%	0mg	0%	0mg	0%
Sodium	0mg	0%	200mg	8%	120mg	5%
Potassium	125mg	4%	25mg	1%	30mg	1%
Total Carbohydrate	29g	10%	17g	6%	24g	8%
Dietary Fiber	3g	12%	1g	4%	1g	4%
Sugars	8g		6g		13g	
Protein	4g		1g		1g	
* Percent Daily Values are based on a 2,000 calorie diet. Your daily values may be higher or lower depending on your calorie needs: Calories: 2,000 2,500	Vitamin A 0%		10%		10%	
	Vitamin C 0%		15%		90%	
	Calcium 0%		0%		0%	
	Iron 10%		6%		20%	
	Thiamin 30%		15%		20%	
	Riboflavin 30%		15%		20%	
	Niacin 30%		15%		20%	
	Vitamin B ₆ 30%		15%		20%	
Total Fat	Less than	65g	80g			
Sat Fat	Less than	20g	25g			
Cholesterol	Less than	300mg	300mg			
Sodium	Less than	2,400mg	2,400mg			
Potassium		3,500mg	3,500mg			
Total Carbohydrate		300g	375g			
Dietary Fiber		25g	30g			

(14) In accordance with §101.15(c)(2), when nutrition labeling must appear in a second language, the nutrition information may be presented in a separate nutrition label for each language or in one nutrition label with the information in the second language following that in English. Numeric characters that are identical in both languages need not be repeated (e.g., “Protein/Proteinas 2 g”). All required information must be included in both languages.

(e) Nutrition information may be presented for two or more forms of the same food (e.g., both “as purchased” and “as prepared”) or for common combinations of food as provided for in paragraph (h)(4) of this section, for different units (e.g., slices of bread or per 100 grams) as provided for in paragraph

(b) of this section, or for two or more groups for which RDI’s are established (e.g., both infants and children less than 4 years of age) as shown in paragraph (e)(5) of this section. When such dual labeling is provided, equal prominence shall be given to both sets of values. Information shall be presented in a format consistent with paragraph (d) of this section, except that:

(1) Following the subheading of “Amount Per Serving,” there shall be two or more column headings accurately describing the forms of the same food (e.g., “Mix” and “Baked”), the combinations of food, the units, or the RDI groups that are being declared. The column representing the product as packaged and according to the label serving size based on the reference

§ 101.9

21 CFR Ch. I (4–1–07 Edition)

amount in §101.12(b) shall be to the left of the numeric columns.

(2) When the dual labeling is presented for two or more forms of the same food, for combinations of food, or for different units, total calories and calories from fat (and calories from saturated fat, when declared) shall be listed in a column and indented as specified in paragraph (d)(5) of this section with quantitative amounts declared in columns aligned under the column headings set forth in paragraph (e)(1) of this section.

(3) Quantitative information by weight required in paragraph (d)(7)(i) of this section shall be specified for the form of the product as packaged and according to the label serving size based on the reference amount in §101.12(b).

(i) Quantitative information by weight may be included for other forms of the product represented by the additional column(s) either immediately adjacent to the required quantitative information by weight for the product as packaged and according to the label serving size based on the reference amount in §101.12(b) or as a footnote.

(A) If such additional quantitative information is given immediately adjacent to the required quantitative information, it shall be declared for all nutrients listed and placed immediately following and differentiated from the required quantitative information (e.g., separated by a comma). Such information shall not be put in a separate column.

(B) If such additional quantitative information is given in a footnote, it shall be declared in the same order as the nutrients are listed in the nutrition label. The additional quantitative information may state the total nutrient content of the product identified in the second column or the nutrient amounts added to the product as packaged for only those nutrients that are present in different amounts than the amounts declared in the required quantitative information. The footnote shall clearly identify which amounts are declared. Any subcomponents declared shall be listed parenthetically after principal components (e.g., 1/2 cup skim milk contributes an additional 40

calories, 65 mg sodium, 6 g total carbohydrate (6 g sugars), and 4 g protein).

(ii) Total fat and its quantitative amount by weight shall be followed by an asterisk (or other symbol) (e.g., “Total fat (2 g)*”) referring to another asterisk (or symbol) at the bottom of the nutrition label identifying the form(s) of the product for which quantitative information is presented.

(4) Information required in paragraphs (d)(7)(ii) and (d)(8) of this section shall be presented under the subheading “% DAILY VALUE” and in columns directly under the column headings set forth in paragraph (e)(1) of this section.

(5) The following sample label illustrates the provisions of paragraph (e) of this section:

Nutrition Facts			
Serving Size 1/12 package (44g, about 1/4 cup dry mix)			
Servings Per Container 12			
Amount Per Serving	Mix	Baked	
Calories	190	280	
Calories from Fat	45	140	
% Daily Value**			
Total Fat 5g*	8%	24%	
Saturated Fat 2g	10%	13%	
Trans Fat 1g			
Cholesterol 0mg	0%	23%	
Sodium 300mg	13%	13%	
Total Carbohydrate 34g	11%	11%	
Dietary Fiber 0g	0%	0%	
Sugars 18g			
Protein 2g			
Vitamin A	0%	0%	
Vitamin C	0%	0%	
Calcium	6%	8%	
Iron	2%	4%	
* Amount in Mix			
** Percent Daily Values are based on a 2,000 calorie diet. Your Daily Values may be higher or lower depending on your calorie needs:			
	Calories:	2,000	2,500
Total Fat	Less than	65g	80g
Sat Fat	Less than	20g	25g
Cholesterol	Less than	300mg	300mg
Sodium	Less than	2,400mg	2,400mg
Total Carbohydrate		300g	375g
Dietary Fiber		25g	30g

(f) The declaration of nutrition information may be presented in the simplified format set forth herein when a food product contains insignificant amounts of eight or more of the following: Calories, total fat, saturated fat, *trans* fat, cholesterol, sodium, total carbohydrate, dietary fiber, sugars, protein, vitamin A, vitamin C, calcium, and iron; except that for foods intended for children less than 2 years of age to which §101.9(j)(5)(i) applies, nutrition information may be presented in the simplified format when a food product contains insignificant amounts of six or more of the following: Calories, total fat, sodium, total carbohydrate, dietary fiber, sugars, protein, vitamin A, vitamin C, calcium, and iron.

(1) An “insignificant amount” shall be defined as that amount that allows a declaration of zero in nutrition labeling, except that for total carbohydrate, dietary fiber, and protein, it shall be an amount that allows a declaration of “less than 1 gram.”

(2) The simplified format shall include information on the following nutrients:

(i) Total calories, total fat, total carbohydrate, protein, and sodium;

(ii) Calories from fat and any other nutrients identified in paragraph (f) of this section that are present in the food in more than insignificant amounts; and

(iii) Any vitamins and minerals listed in paragraph (c)(8)(iv) of this section when they are required to be added as a nutrient supplement to foods for which a standard of identity exists.

(iv) Any vitamins or minerals listed in paragraph (c)(8)(iv) of this section voluntarily added to the food as nutrient supplements.

(3) Other nutrients that are naturally present in the food in more than insignificant amounts may be voluntarily declared as part of the simplified format.

(4) If any nutrients are declared as provided in paragraphs (f)(2)(iii), (f)(2)(iv), or (f)(3) of this section as part of the simplified format or if any nutrition claims are made on the label or in labeling, the statement “Not a significant source of _____” (with the blank filled in with the name(s) of any nutrient(s) identified in §101.9(f) and calories from fat that are present in insignificant amounts) shall be included at the bottom of the nutrition label.

(5) Except as provided for in paragraphs (j)(5) and (j)(13) of this section, nutrient information declared in the simplified format shall be presented in the same manner as specified in paragraphs (d) or (e) of this section, except that the footnote required in paragraph (d)(9) of this section is not required. When the footnote is omitted, an asterisk shall be placed at the bottom of the label followed by the statement “Percent Daily Values are based on a 2,000 calorie diet” and, if the term “Daily Value” is not spelled out in the heading, a statement that “DV” represents “Daily Value.”

(g) Compliance with this section shall be determined as follows:

(1) A collection of primary containers or units of the same size, type, and style produced under conditions as nearly uniform as possible, designated by a common container code or marking, or in the absence of any common container code or marking, a day's production, constitutes a "lot."

(2) The sample for nutrient analysis shall consist of a composite of 12 subsamples (consumer units), taken 1 from each of 12 different randomly chosen shipping cases, to be representative of a lot. Unless a particular method of analysis is specified in paragraph (c) of this section, composites shall be analyzed by appropriate methods as given in the "Official Methods of Analysis of the AOAC International," 15th Ed. (1990), which is incorporated by reference in accordance with 5 U.S.C. 552(a) or 1 CFR part 51 or, if no AOAC method is available or appropriate, by other reliable and appropriate analytical procedures. The availability of this incorporation by reference is given in paragraph (c)(7) of this section.

(3) Two classes of nutrients are defined for purposes of compliance:

(i) *Class I.* Added nutrients in fortified or fabricated foods; and

(ii) *Class II.* Naturally occurring (indigenous) nutrients. If any ingredient which contains a naturally occurring (indigenous) nutrient is added to a food, the total amount of such nutrient in the final food product is subject to class II requirements unless the same nutrient is also added.

(4) A food with a label declaration of a vitamin, mineral, protein, total carbohydrate, dietary fiber, other carbohydrate, polyunsaturated or monounsaturated fat, or potassium shall be deemed to be misbranded under section 403(a) of the Federal Food, Drug, and Cosmetic Act (the act) unless it meets the following requirements:

(i) *Class I vitamin, mineral, protein, dietary fiber, or potassium.* The nutrient content of the composite is at least equal to the value for that nutrient declared on the label.

(ii) *Class II vitamin, mineral, protein, total carbohydrate, dietary fiber, other carbohydrate, polyunsaturated or*

monounsaturated fat, or potassium. The nutrient content of the composite is at least equal to 80 percent of the value for that nutrient declared on the label. *Provided,* That no regulatory action will be based on a determination of a nutrient value that falls below this level by a factor less than the variability generally recognized for the analytical method used in that food at the level involved.

(5) A food with a label declaration of calories, sugars, total fat, saturated fat, *trans* fat, cholesterol, or sodium shall be deemed to be misbranded under section 403(a) of the act if the nutrient content of the composite is greater than 20 percent in excess of the value for that nutrient declared on the label. *Provided,* That no regulatory action will be based on a determination of a nutrient value that falls above this level by a factor less than the variability generally recognized for the analytical method used in that food at the level involved.

(6) Reasonable excesses of a vitamin, mineral, protein, total carbohydrate, dietary fiber, other carbohydrate, polyunsaturated or monounsaturated fat, or potassium over labeled amounts are acceptable within current good manufacturing practice. Reasonable deficiencies of calories, sugars, total fat, saturated fat, *trans* fat, cholesterol, or sodium under labeled amounts are acceptable within current good manufacturing practice.

(7) Compliance will be based on the metric measure specified in the label statement of serving size.

(8) Compliance with the provisions set forth in paragraphs (g)(1) through (g)(6) of this section may be provided by use of an FDA approved data base that has been computed following FDA guideline procedures and where food samples have been handled in accordance with current good manufacturing practice to prevent nutrition loss. FDA approval of a data base shall not be considered granted until the Center for Food Safety and Applied Nutrition has agreed to all aspects of the data base in writing. The approval will be granted where a clear need is presented (e.g., raw produce and seafood). Approvals will be in effect for a limited time, e.g.,

10 years, and will be eligible for renewal in the absence of significant changes in agricultural or industry practices. Approval requests shall be submitted in accordance with the provisions of §10.30 of this chapter. Guidance in the use of data bases may be found in the "FDA Nutrition Labeling Manual—A Guide for Developing and Using Data Bases," available from the Office of Nutritional Products, Labeling and Dietary Supplements (HFS-800), Center for Food Safety and Applied Nutrition, Food and Drug Administration, 5100 Paint Branch Pkwy., College Park, MD 20740.

(9) When it is not technologically feasible, or some other circumstance makes it impracticable, for firms to comply with the requirements of this section (e.g., to develop adequate nutrient profiles to comply with the requirements of paragraph (c) of this section), FDA may permit alternative means of compliance or additional exemptions to deal with the situation. Firms in need of such special allowances shall make their request in writing to the Center for Food Safety and Applied Nutrition (HFS-800), Food and Drug Administration, 5100 Paint Branch Pkwy., College Park, MD 20740.

(h) Products with separately packaged ingredients or foods, with assortments of food, or to which other ingredients are added by the user may be labeled as follows:

(1) If a product consists of two or more separately packaged ingredients enclosed in an outer container or of assortments of the same type of food (e.g., assorted nuts or candy mixtures) in the same retail package, nutrition labeling shall be located on the outer container or retail package (as the case may be) to provide information for the consumer at the point of purchase. However, when two or more food products are simply combined together in such a manner that no outer container is used, or no outer label is available, each product shall have its own nutrition information, e.g., two boxes taped together or two cans combined in a clear plastic overwrap. When separately packaged ingredients or assortments of the same type of food are intended to be eaten at the same time, the nutrition information may be spec-

ified per serving for each component or as a composite value.

(2) If a product consists of two or more separately packaged foods that are intended to be eaten individually and that are enclosed in an outer container (e.g., variety packs of cereals or snack foods), the nutrition information shall:

(i) Be specified per serving for each food in a location that is clearly visible to the consumer at the point of purchase; and

(ii) Be presented in separate nutrition labels or in one aggregate nutrition label with separate columns for the quantitative amount by weight and the percent Daily Value for each food.

(3) If a package contains a variety of foods, or an assortment of foods, and is in a form intended to be used as a gift, the nutrition labeling shall be in the form required by paragraphs (a) through (f) of this section, but it may be modified as follows:

(i) Nutrition information may be presented on the label of the outer package or in labeling within or attached to the outer package.

(ii) In the absence of a reference amount customarily consumed in §101.12(b) that is appropriate for the variety or assortment of foods in a gift package, 1 ounce for solid foods, 2 fluid ounces for nonbeverage liquids (e.g., syrups), and 8 fluid ounces for beverages may be used as the standard serving size for purposes of nutrition labeling of foods subject to this paragraph. However, the reference amounts customarily consumed in §101.12(b) shall be used for purposes of evaluating whether individual foods in a gift package qualify for nutrient content claims or health claims.

(iii) The number of servings per container may be stated as "varied."

(iv) Nutrition information may be provided per serving for individual foods in the package, or, alternatively, as a composite per serving for reasonable categories of foods in the package having similar dietary uses and similar significant nutritional characteristics. Reasonable categories of foods may be used only if accepted by FDA. In determining whether a proposed category is reasonable, FDA will consider whether

the values of the characterizing nutrients in the foods proposed to be in the category meet the compliance criteria set forth in paragraphs (g)(3) through (g)(6) of this section. Proposals for such categories may be submitted in writing to the Office of Nutritional Products, Labeling and Dietary Supplements (HFS-800), Center for Food Safety and Applied Nutrition, Food and Drug Administration, 5100 Paint Branch Pkwy., College Park, MD 20740.

(v) If a food subject to paragraph (j)(13) of this section because of its small size is contained in a gift package, the food need not be included in the determination of nutrition information under paragraph (h) of this section if it is not specifically listed in a promotional catalogue as being present in the gift package, and:

(A) It is used in small quantities primarily to enhance the appearance of the gift package; or

(B) It is included in the gift package as a free gift or promotional item.

(4) If a food is commonly combined with other ingredients or is cooked or otherwise prepared before eating, and directions for such combination or preparations are provided, another column of figures may be used to declare nutrition information on the basis of the food as consumed in the format required in paragraph (e) of this section (e.g., a dry ready-to-eat cereal may be described with one set of Percent Daily Values for the cereal as sold (e.g., per ounce), and another set for the cereal and milk as suggested in the label (e.g., per ounce of cereal and 1/2 cup of vitamin D fortified skim milk); and a cake mix may be labeled with one set of Percent Daily Values for the dry mix (per serving) and another set for the serving of the final cake when prepared): *Provided*, That, the type and quantity of the other ingredients to be added to the product by the user and the specific method of cooking and other preparation shall be specified prominently on the label.

(i) Except as provided in paragraphs (j)(13) and (j)(17) of this section, the location of nutrition information on a label shall be in compliance with § 101.2.

(j) The following foods are exempt from this section or are subject to special labeling requirements:

(1)(i) Food offered for sale by a person who makes direct sales to consumers (e.g., a retailer) who has annual gross sales made or business done in sales to consumers that is not more than \$500,000 or has annual gross sales made or business done in sales of food to consumers of not more than \$50,000, *Provided*, That the food bears no nutrition claims or other nutrition information in any context on the label or in labeling or advertising. Claims or other nutrition information subject the food to the provisions of this section.

(ii) For purposes of this paragraph, calculation of the amount of sales shall be based on the most recent 2-year average of business activity. Where firms have been in business less than 2 years, reasonable estimates must indicate that annual sales will not exceed the amounts specified. For foreign firms that ship foods into the United States, the business activities to be included shall be the total amount of food sales, as well as other sales to consumers, by the firm in the United States.

(2) Food products which are:

(i) Served in restaurants, *Provided*, That the food bears no nutrition claims or other nutrition information in any context on the label or in labeling or advertising. Claims or other nutrition information subject the food to the provisions of this section;

(ii) Served in other establishments in which food is served for immediate human consumption (e.g., institutional food service establishments, such as schools, hospitals, and cafeterias; transportation carriers, such as trains and airplanes; bakeries, delicatessens, and retail confectionery stores where there are facilities for immediate consumption on the premises; food service vendors, such as lunch wagons, ice cream shops, mall cookie counters, vending machines, and sidewalk carts where foods are generally consumed immediately where purchased or while the consumer is walking away, including similar foods sold from convenience stores; and food delivery systems or establishments where ready-to-eat foods are delivered to homes or offices), *Provided*, That the food bears no nutrition

claims or other nutrition information in any context on the label or in labeling or advertising. Claims or other nutrition information subject the food to the provisions of this section;

(iii) Sold only in such facilities, *Provided*, That the food bears no nutrition claims or other nutrition information in any context on the label or in labeling or advertising. Claims or other nutrition information subject the food to the provisions of this section;

(iv) Used only in such facilities and not served to the consumer in the package in which they are received (e.g., foods that are not packaged in individual serving containers); or

(v) Sold by a distributor who principally sells food to such facilities: *Provided*, That:

(A) This exemption shall not be available for those foods that are manufactured, processed, or repackaged by that distributor for sale to any persons other than restaurants or other establishments that serve food for immediate human consumption, and

(B) The manufacturer of such products is responsible for providing the nutrition information on the products if there is a reasonable possibility that the product will be purchased directly by consumers.

(3) Food products that are:

(i) Of the type of food described in paragraphs (j)(2)(i) and (j)(2)(ii) of this section,

(ii) Ready for human consumption,

(iii) Offered for sale to consumers but not for immediate human consumption,

(iv) Processed and prepared primarily in a retail establishment, and

(v) Not offered for sale outside of that establishment (e.g., ready-to-eat foods that are processed and prepared on-site and sold by independent delicatessens, bakeries, or retail confectionery stores where there are no facilities for immediate human consumption; by in-store delicatessen, bakery, or candy departments; or at self-service food bars such as salad bars), *Provided*, That the food bears no nutrition claims or other nutrition information in any context on the label or in labeling or advertising. Claims or other nutrition information subject the food to the provisions of this section.

(4) Foods that contain insignificant amounts of all of the nutrients and food components required to be included in the declaration of nutrition information under paragraph (c) of this section, *Provided*, That the food bears no nutrition claims or other nutrition information in any context on the label or in labeling or advertising. Claims or other nutrition information subject the food to the provisions of this section. An insignificant amount of a nutrient or food component shall be that amount that allows a declaration of zero in nutrition labeling, except that for total carbohydrate, dietary fiber, and protein, it shall be an amount that allows a declaration of "less than 1 gram." Examples of foods that are exempt under this paragraph include coffee beans (whole or ground), tea leaves, plain unsweetened instant coffee and tea, condiment-type dehydrated vegetables, flavor extracts, and food colors.

(5)(i) Foods, other than infant formula, represented or purported to be specifically for infants and children less than 2 years of age shall bear nutrition labeling, except as provided in paragraph (j)(5)(ii) and except that such labeling shall not include calories from fat (paragraph (c)(1)(ii) of this section), calories from saturated fat ((c)(1)(iii)), saturated fat ((c)(2)(i)), polyunsaturated fat ((c)(2)(ii)), monounsaturated fat ((c)(2)(iii)), and cholesterol ((c)(3)).

(ii) Foods, other than infant formula, represented or purported to be specifically for infants and children less than 4 years of age shall bear nutrition labeling, except that:

(A) Such labeling shall not include declarations of percent of Daily Value for total fat, saturated fat, cholesterol, sodium, potassium, total carbohydrate, and dietary fiber;

(B) Nutrient names and quantitative amounts by weight shall be presented in two separate columns.

(C) The heading "Percent Daily Value" required in paragraph (d)(6) of this section shall be placed immediately below the quantitative information by weight for protein;

(D) Percent of Daily Value for protein, vitamins, and minerals shall be listed immediately below the heading "Percent Daily Value"; and

§ 101.9

21 CFR Ch. I (4–1–07 Edition)

(E) Such labeling shall not include the footnote specified in paragraph (d)(9) of this section.

(6) Dietary supplements, except that such foods shall be labeled in compliance with §101.36.

(7) Infant formula subject to section 412 of the act, as amended, except that such foods shall be labeled in compliance with part 107 of this chapter.

(8) Medical foods as defined in section 5(b) of the Orphan Drug Act (21 U.S.C. 360ee(b)(3)). A medical food is a food which is formulated to be consumed or administered enterally under the supervision of a physician and which is intended for the specific dietary management of a disease or condition for which distinctive nutritional requirements, based on recognized scientific principles, are established by medical evaluation. A food is subject to this exemption only if:

(i) It is a specially formulated and processed product (as opposed to a naturally occurring foodstuff used in its natural state) for the partial or exclusive feeding of a patient by means of oral intake or enteral feeding by tube;

(ii) It is intended for the dietary management of a patient who, because of therapeutic or chronic medical needs, has limited or impaired capacity to ingest, digest, absorb, or metabolize ordinary foodstuffs or certain nutrients, or who has other special medically determined nutrient requirements, the dietary management of which cannot be achieved by the modification of the normal diet alone;

(iii) It provides nutritional support specifically modified for the management of the unique nutrient needs that result from the specific disease or condition, as determined by medical evaluation;

(iv) It is intended to be used under medical supervision; and

(v) It is intended only for a patient receiving active and ongoing medical supervision wherein the patient requires medical care on a recurring basis for, among other things, instructions on the use of the medical food.

(9) Food products shipped in bulk form that are not for distribution to consumers in such form and that are for use solely in the manufacture of other foods or that are to be processed,

labeled, or repacked at a site other than where originally processed or packed.

(10) Raw fruits, vegetables, and fish subject to section 403(q)(4) of the act, except that the labeling of such foods should adhere to guidelines in §101.45. This exemption is contingent on the food bearing no nutrition claims or other nutrition information in any context on the label or in labeling or advertising. Claims or other nutrition information subject the food to nutrition labeling in accordance with §101.45. The term *fish* includes freshwater or marine fin fish, crustaceans, and mollusks, including shellfish, amphibians, and other forms of aquatic animal life.

(11) Packaged single-ingredient products that consist of fish or game meat (i.e., animal products not covered under the Federal Meat Inspection Act or the Poultry Products Inspection Act, such as flesh products from deer, bison, rabbit, quail, wild turkey, or ostrich) subject to this section may provide required nutrition information for a 3-ounce cooked edible portion (i.e., on an “as prepared” basis), except that:

(i) Such products that make claims that are based on values as packaged must provide nutrition information on an as packaged basis, and

(ii) Nutrition information is not required for custom processed fish or game meats.

(12) Game meats (i.e., animal products not covered under the Federal Meat Inspection Act or the Poultry Products Inspection Act, such as flesh products from deer, bison, rabbit, quail, wild turkey, or ostrich) may provide required nutrition information on labeling in accordance with the provisions of paragraph (a)(2) of this section.

(13)(i) Foods in small packages that have a total surface area available to bear labeling of less than 12 square inches, *Provided*, That the labels for these foods bear no nutrition claims or other nutrition information in any context on the label or in labeling or advertising. Claims or other nutrition information subject the food to the provisions of this section.

(A) The manufacturer, packer, or distributor shall provide on the label of packages that qualify for and use this

exemption an address or telephone number that a consumer can use to obtain the required nutrition information (e.g., “For nutrition information, call 1-800-123-4567”).

(B) When such products bear nutrition labeling, either voluntarily or because nutrition claims or other nutrition information is provided, all required information shall be in type size no smaller than 6 point or all uppercase type of 1/16 inches minimum height, except that individual serving-size packages of food served with meals in restaurants, institutions, and on board passenger carriers, and not intended for sale at retail, may comply with §101.2(c)(5).

(ii) Foods in packages that have a total surface area available to bear labeling of 40 or less square inches may

modify the requirements of paragraphs (c) through (f) and (i) of this section by one or more of the following means:

(A) Presenting the required nutrition information in a tabular or, as provided below, linear (i.e., string) fashion rather than in vertical columns if the product has a total surface area available to bear labeling of less than 12 square inches, or if the product has a total surface area available to bear labeling of 40 or less square inches and the package shape or size cannot accommodate a standard vertical column or tabular display on any label panel. Nutrition information may be given in a linear fashion only if the label will not accommodate a tabular display.

(1) The following sample label illustrates the tabular display.

Nutrition Facts	Amount/serving	%DV*	Amount/serving	%DV*
	Serving Size 1/3 cup (56g) Servings about 3 Calories 90 Fat Cal. 20	Total Fat 2g	3%	Total Carb. 0g
	Sat. Fat 1g	5%	Fiber 0g	0%
	<i>Trans</i> Fat 0.5g		Sugars 0g	
	Cholest. 10mg	3%	Protein 17g	
	Sodium 200mg	8%		
*Percent Daily Values (DV) are based on a 2,000 calorie diet.	Vitamin A 0% • Vitamin C 0% • Calcium 0% • Iron 6%			

(2) The following sample label illustrates the linear display. When nutrition information is given in a linear fashion, bolding is required only on the title “Nutrition Facts” and is allowed

voluntarily for the nutrient names for “Calories,” “Total fat,” “Cholesterol,” “Sodium,” “Total carbohydrate,” and “Protein.”

Nutrition Facts Serv. Size: 1 package, Amount Per Serving: Calories 45, Fat Cal. 10, Total Fat 1g (2% DV), Sat. Fat 0.5g (3% DV), <i>Trans</i> Fat 0.5g, Cholest. 0mg (0% DV), Sodium 50mg (2% DV), Total Carb. 8g (3% DV), Fiber 1g (4% DV), Sugars 4g, Protein 1g, Vitamin A (8% DV), Vitamin C (8% DV), Calcium (0% DV), Iron (2% DV). Percent Daily Values (DV) are based on a 2,000 calorie diet.
--

(B) Using any of the following abbreviations:

- Serving size—Serv size
- Servings per container—Servings
- Calories from fat—Fat cal

- Calories from saturated fat—Sat fat cal
- Saturated fat—Sat fat
- Monounsaturated fat—Monounsat fat
- Polyunsaturated fat—Polyunsat fat
- Cholesterol—Cholest
- Total carbohydrate—Total carb

§ 101.9

21 CFR Ch. I (4-1-07 Edition)

Dietary fiber—Fiber
Soluble fiber—Sol fiber
Insoluble fiber—Insol fiber
Sugar alcohol—Sugar alc
Other carbohydrate—Other carb

(C) Omitting the footnote required in paragraph (d)(9) of this section and placing another asterisk at the bottom of the label followed by the statement “Percent Daily Values are based on a 2,000 calorie diet” and, if the term “Daily Value” is not spelled out in the heading, a statement that “DV” represents “Daily Value.”

(D) Presenting the required nutrition information on any label panel.

(14) Shell eggs packaged in a carton that has a top lid designed to conform to the shape of the eggs are exempt from outer carton label requirements where the required nutrition information is clearly presented immediately beneath the carton lid or in an insert that can be clearly seen when the carton is opened.

(15) The unit containers in a multi-unit retail food package where:

(i) The multiunit retail food package labeling contains all nutrition information in accordance with the requirements of this section;

(ii) The unit containers are securely enclosed within and not intended to be separated from the retail package under conditions of retail sale; and

(iii) Each unit container is labeled with the statement “This Unit Not Labeled For Retail Sale” in type size not less than 1/16-inch in height, except that this statement shall not be required when the inner unit containers bear no labeling at all. The word “individual” may be used in lieu of or immediately preceding the word “Retail” in the statement.

(16) Food products sold from bulk containers: *Provided*, That nutrition information required by this section be displayed to consumers either on the labeling of the bulk container plainly in view or in accordance with the provisions of paragraph (a)(2) of this section.

(17) Foods in packages that have a total surface area available to bear labeling greater than 40 square inches but whose principal display panel and information panel do not provide sufficient space to accommodate all re-

quired information may use any alternate panel that can be readily seen by consumers for the nutrition label. The space needed for vignettes, designs, and other nonmandatory label information on the principal display panel may be considered in determining the sufficiency of available space on the principal display panel for the placement of the nutrition label. Nonmandatory label information on the information panel shall not be considered in determining the sufficiency of available space for the placement of the nutrition label.

(18) Food products that are low-volume (that is, they meet the requirements for units sold in paragraphs (j)(18)(i) or (j)(18)(ii) of this section); that, except as provided in paragraph (j)(18)(iv) of this section, are the subject of a claim for an exemption that provides the information required under paragraph (j)(18)(iv) of this section, that is filed before the beginning of the time period for which the exemption is claimed, and that is filed by a person, whether it is the manufacturer, packer, or distributor, that qualifies to claim the exemption under the requirements for average full-time equivalent employees in paragraphs (j)(18)(i) or (j)(18)(ii) of this section; and whose labels, labeling, and advertising do not provide nutrition information or make a nutrient content or health claim.

(i) For food products first introduced into interstate commerce before May 8, 1994, the product shall be exempt for the period:

(A) Between May 8, 1995, and May 7, 1996, if, for the period between May 8, 1994, and May 7, 1995, the person claiming the exemption employed fewer than an average of 300 full-time equivalent employees and fewer than 400,000 units of that product were sold in the United States; and

(B) Between May 8, 1996, and May 7, 1997, if for the period between May 8, 1995, and May 7, 1996, the person claiming the exemption employed fewer than an average of 200 full-time equivalent employees and fewer than 200,000 units of that product were sold in the United States.

(ii) For all other food products, the product shall be eligible for an exemption for any 12-month period if, for the

preceding 12 months, the person claiming the exemption employed fewer than an average of 100 full-time equivalent employees and fewer than 100,000 units of that product were sold in the United States, or in the case of a food product that was not sold in the 12-month period preceding the period for which exemption is claimed, fewer than 100,000 units of such product are reasonably anticipated to be sold in the United States during the period for which exemption is claimed.

(iii) If a person claims an exemption under paragraphs (j)(18)(i) or (j)(18)(ii) of this section for a food product and then, during the period of such exemption, the number of full-time equivalent employees of such person exceeds the appropriate number, or the number of food products sold in the United States exceeds the appropriate number, or, if at the end of the period of such exemption, the food product no longer qualifies for an exemption under the provisions of paragraphs (j)(18)(i) or (j)(18)(ii) of this section, such person shall have 18 months from the date that the product was no longer qualified as a low-volume product of a small business to comply with this section.

(iv) A notice shall be filed with the Office of Nutritional Products, Labeling and Dietary Supplements (HFS-800), Center for Food Safety and Applied Nutrition, Food and Drug Administration, 5100 Paint Branch Pkwy., College Park, MD 20740 and contain the following information, except that if the person is not an importer and has fewer than 10 full-time equivalent employees, that person does not have to file a notice for any food product with annual sales of fewer than 10,000 total units:

(A) Name and address of person requesting exemption. This should include a telephone number or FAX number that can be used to contact the person along with the name of a specific contact;

(B) Names of the food products (including the various brand names) for which exemption is claimed;

(C) Name and address of the manufacturer, distributor, or importer of the food product for which an exemption is claimed, if different than the person that is claiming the exemption;

(D) The number of full-time equivalent employees. Provide the average number of full-time equivalent individuals employed by the person and its affiliates for the 12 months preceding the period for which a small business exemption is claimed for a product. The average number of full-time equivalent employees is to be determined by dividing the total number of hours of salary or wages paid to employees of the person and its affiliates by the number of hours of work in a year, 2,080 hours (i.e., 40 hours×52 weeks);

(E) Approximate total number of units of the food product sold by the person in the United States in the 12-month period preceding that for which a small business exemption is claimed. Provide the approximate total number of units sold, or expected to be sold, in a 12-month period for each product for which an exemption is claimed. For products that have been in production for 1 year or more prior to the period for which exemption is claimed, the 12-month period is the period immediately preceding the period for which an exemption is claimed. For other products, the 12-month period is the period for which an exemption is claimed; and

(F) The notice shall be signed by a responsible individual for the person who can certify the accuracy of the information presented in the notice. The individual shall certify that the information contained in the notice is a complete and accurate statement of the average number of full-time equivalent employees of this person and its affiliates and of the number of units of the product for which an exemption is claimed sold by the person. The individual shall also state that should the average number of full-time equivalent employees or the number of units of food products sold in the United States by the person exceed the applicable numbers for the time period for which exemption is claimed, the person will notify FDA of that fact and the date on which the number of employees or the number of products sold exceeded the standard.

(v) FDA may by regulation lower the employee or units of food products requirements of paragraph (j)(18)(ii) of this section for any food product first

§ 101.10

introduced into interstate commerce after May 8, 2002, if the agency determines that the cost of compliance with such lower requirement will not place an undue burden on persons subject to it.

(vi) For the purposes of this paragraph, the following definitions apply:

(A) *Unit* means the packaging or, if there is no packaging, the form in which a food product is offered for sale to consumers.

(B) *Food product* means food in any sized package which is manufactured by a single manufacturer or which bears the same brand name, which bears the same statement of identity, and which has similar preparation methods.

(C) *Person* means all domestic and foreign affiliates, as defined in 13 CFR 121.401, of the corporation, in the case of a corporation, and all affiliates, as defined in 13 CFR 121.401, of a firm or other entity, when referring to a firm or other entity that is not a corporation.

(D) *Full-time equivalent employee* means all individuals employed by the person claiming the exemption. This number shall be determined by dividing the total number of hours of salary or wages paid directly to employees of the person and of all of its affiliates by the number of hours of work in a year, 2,080 hours (i.e., 40 hours×52 weeks).

(k) A food labeled under the provisions of this section shall be deemed to be misbranded under sections 201(n) and 403(a) of the act if its label or labeling represents, suggests, or implies:

(1) That the food, because of the presence or absence of certain dietary properties, is adequate or effective in the prevention, cure, mitigation, or treatment of any disease or symptom. Information about the relationship of a dietary property to a disease or health-related condition may only be provided in conformance with the requirements of § 101.14 and part 101, subpart E.

(2) That the lack of optimum nutritive quality of a food, by reason of the soil on which that food was grown, is or may be responsible for an inadequacy or deficiency in the quality of the daily diet.

(3) That the storage, transportation, processing, or cooking of a food is or

21 CFR Ch. I (4–1–07 Edition)

may be responsible for an inadequacy or deficiency in the quality of the daily diet.

(4) That a natural vitamin in a food is superior to an added or synthetic vitamin.

[58 FR 2175, Jan. 6, 1993, as amended at 58 FR 2227, 2533, Jan. 6, 1993; 58 FR 17104, Apr. 1, 1993; 58 FR 17328–17331, Apr. 2, 1993; 58 FR 44048, 44076, Aug. 18, 1993; 58 FR 59363, Nov. 9, 1993; 58 FR 60109, Nov. 15, 1993; 59 FR 371, Jan. 4, 1994; 59 FR 62317, Dec. 5, 1994; 60 FR 17205, Apr. 5, 1995; 60 FR 30788, June 12, 1995; 60 FR 67174, Dec. 28, 1995; 61 FR 8779, Mar. 5, 1996; 61 FR 14479, Apr. 2, 1996; 61 FR 40978, Aug. 7, 1996; 62 FR 15342, Mar. 31, 1997; 62 FR 49848, Sept. 23, 1997; 63 FR 14035, Mar. 24, 1998; 64 FR 12889, Mar. 16, 1999; 65 FR 56479, Sept. 19, 2000; 66 FR 56035, Nov. 6, 2001; 70 FR 41502, July 11, 2005]

§ 101.10 Nutrition labeling of restaurant foods.

Nutrition labeling in accordance with § 101.9 shall be provided upon request for any restaurant food or meal for which a nutrient content claim (as defined in § 101.13 or in subpart D of this part) or a health claim (as defined in § 101.14 and permitted by a regulation in subpart E of this part) is made, except that information on the nutrient amounts that are the basis for the claim (e.g., “low fat, this meal provides less than 10 grams of fat”) may serve as the functional equivalent of complete nutrition information as described in § 101.9. Nutrient levels may be determined by nutrient data bases, cookbooks, or analyses or by other reasonable bases that provide assurance that the food or meal meets the nutrient requirements for the claim. Presentation of nutrition labeling may be in various forms, including those provided in § 101.45 and other reasonable means.

[61 FR 40332, Aug. 2, 1996]

§ 101.12 Reference amounts customarily consumed per eating occasion.

(a) The general principles and factors that the Food and Drug Administration (FDA) considered in arriving at the reference amounts customarily consumed per eating occasion (reference amounts) which are set forth in paragraph (b) of this section, are that:

(1) FDA calculated the reference amounts for persons 4 years of age or

older to reflect the amount of food customarily consumed per eating occasion by persons in this population group. These reference amounts are based on data set forth in appropriate national food consumption surveys.

(2) FDA calculated the reference amounts for an infant or child under 4 years of age to reflect the amount of food customarily consumed per eating occasion by infants up to 12 months of age or by children 1 through 3 years of age, respectively. These reference amounts are based on data set forth in appropriate national food consumption surveys. Such reference amounts are to be used only when the food is specially formulated or processed for use by an infant or by a child under 4 years of age.

(3) An appropriate national food consumption survey includes a large sample size representative of the demographic and socioeconomic characteristics of the relevant population group and must be based on consumption data under actual conditions of use.

(4) To determine the amount of food customarily consumed per eating occasion, FDA considered the mean, median, and mode of the consumed amount per eating occasion.

(5) When survey data were insufficient, FDA took various other sources of information on serving sizes of food into consideration. These other sources of information included:

(i) Serving sizes used in dietary guidance recommendations or recommended by other authoritative systems or organizations;

(ii) Serving sizes recommended in comments;

(iii) Serving sizes used by manufacturers and grocers; and

(iv) Serving sizes used by other countries.

(6) Because they reflect the amount customarily consumed, the reference amount and, in turn, the serving size declared on the product label are based on only the edible portion of food, and not bone, seed, shell, or other inedible components.

(7) The reference amount is based on the major intended use of the food (e.g., milk as a beverage and not as an addition to cereal).

(8) The reference amounts for products that are consumed as an ingredient of other foods, but that may also be consumed in the form in which they are purchased (e.g., butter), are based on use in the form purchased.

(9) FDA sought to ensure that foods that have similar dietary usage, product characteristics, and customarily consumed amounts have a uniform reference amount.

(b) The following reference amounts shall be used as the basis for determining serving sizes for specific products:

TABLE 1—REFERENCE AMOUNTS CUSTOMARILY CONSUMED PER EATING OCCASION: INFANT AND TODDLER FOODS^{1,2,3,4}

Product category	Reference amount	Label statement ⁵
Cereals, dry instant	15 g	— cup (_ g)
Cereals, prepared, ready-to-serve	110 g	— cup(s) (_ g)
Other cereal and grain products, dry ready-to-eat, e.g., ready-to-eat cereals, cookies, teething biscuits, and toasts.	7 g for infants and 20 g for toddlers for ready-to-eat cereals; 7 g for all others.	— cup(s) (_ g) for ready-to-eat cereals; — piece(s) (_ g) for others
Dinners, desserts, fruits, vegetables or soups, dry mix	15 g	— tbsp(s) (_ g); — cup(s) (_ g)
Dinners, desserts, fruits, vegetables or soups, ready-to-serve, junior type.	110 g	— cup(s) (_ g); — cup(s) (_ mL)
Dinners, desserts, fruits, vegetables or soups, ready-to-serve, strained type.	60 g	— cup(s) (_ g); — cup(s) (_ mL)
Dinners, stews or soups for toddlers, ready-to-serve	170 g	— cup(s) (_ g); — cup(s) (_ mL)
Fruits for toddlers, ready-to-serve	125 g	— cup(s) (_ g)
Vegetables for toddlers, ready-to-serve	70 g	— cup(s) (_ g)
Eggs/egg yolks, ready-to-serve	55 g	— cup(s) (_ g)
Juices, all varieties	120 mL	4 fl oz (120 mL)

¹ These values represent the amount of food customarily consumed per eating occasion and were primarily derived from the 1977–1978 and the 1987–1988 Nationwide Food Consumption Surveys conducted by the U.S. Department of Agriculture.

² Unless otherwise noted in the Reference amount column, the reference amounts are for the ready-to-serve or almost ready-to-serve form of the product (i.e., heat and serve, brown and serve). If not listed separately, the reference amount for the unprepared form (e.g., dry cereal) is the amount required to make the reference amount of the prepared form. Prepared means prepared for consumption (e.g., cooked).

§ 101.12

21 CFR Ch. I (4–1–07 Edition)

³Manufacturers are required to convert the reference amount to the label serving size in a household measure most appropriate to their specific product using the procedures in 21 CFR 101.9(b).

⁴Copies of the list of products for each product category are available from the Office of Nutritional Products, Labeling and Dietary Supplements (HFS-800), Center for Food Safety and Applied Nutrition, Food and Drug Administration, 5100 Paint Branch Pkwy., College Park, MD 20740.

⁵The label statements are meant to provide guidance to manufacturers on the presentation of serving size information on the label, but they are not required. The term "piece" is used as a generic description of a discrete unit. Manufacturers should use the description of a unit that is most appropriate for the specific product (e.g., sandwich for sandwiches, cookie for cookies, and bar for frozen novelties).

TABLE 2—REFERENCE AMOUNTS CUSTOMARILY CONSUMED PER EATING OCCASION: GENERAL FOOD SUPPLY 1,2,3,4

Product category	Reference amount	Label statement ⁵
Bakery products:		
Biscuits, croissants, bagels, tortillas, soft bread sticks, soft pretzels, corn bread, hush puppies.	55 g	__ piece(s) (__ g)
Breads (excluding sweet quick type), rolls	50 g	__ piece(s) (__ g) for sliced bread and distinct pieces (e.g., rolls); 2 oz (56 g/ __ inch slice) for unsliced bread
Bread sticks—see crackers
Toaster pastries—see coffee cakes
Brownies	40 g	__ piece(s) (__ g) for distinct pieces; fractional slice (__ g) for bulk
Cakes, heavy weight (cheese cake; pineapple upside-down cake; fruit, nut, and vegetable cakes with more than or equal to 35 percent of the finished weight as fruit, nuts, or vegetables or any of these combined) ⁶ .	125 g	__ piece(s) (__ g) for distinct pieces (e.g., sliced or individually packaged products); fractional slice (__ g) for large discrete units
Cakes, medium weight (chemically leavened cake with or without icing or filling except those classified as light weight cake; fruit, nut, and vegetable cake with less than 35 percent of the finished weight as fruit, nuts, or vegetables or any of these combined; light weight cake with icing; Boston cream pie; cupcake; éclair; cream puff) ⁷ .	80 g	__ piece(s) (__ g) for distinct pieces (e.g., cupcake); fractional slice (__ g) for large discrete units
Cakes, light weight (angel food, chiffon, or sponge cake without icing or filling) ⁸ .	55 g	__ piece(s) (__ g) for distinct pieces (e.g., sliced or individually packaged products); fractional slice (__ g) for large discrete units
Coffee cakes, crumb cakes, doughnuts, Danish, sweet rolls, sweet quick type breads, muffins, toaster pastries.	55 g	__ piece(s) (__ g) for sliced bread and distinct pieces (e.g., doughnut); 2 oz (56 g/visual unit of measure) for bulk products (e.g., unsliced bread)
Cookies	30 g	__ piece(s) (__ g)
Crackers that are usually not used as snack, melba toast, hard bread sticks, ice cream cones ⁹ .	15 g	__ piece(s) (__ g)
Crackers that are usually used as snacks	30 g	__ piece(s) (__ g)
Croutons	7 g	__ tbsp(s) (__ g); __ cup(s) (__ g); __ piece(s) (__ g) for large pieces
French toast, pancakes, variety mixes	110 g prepared for french toast and pancakes; 40 g dry mix for variety mixes.	__ piece(s) (__ g); __ cup(s) (__ g) for dry mix
Grain-based bars with or without filling or coating, e.g., breakfast bars, granola bars, rice cereal bars.	40 g	__ piece(s) (__ g)
Ice cream cones—see crackers
Pies, cobblers, fruit crisps, turnovers, other pastries ..	125 g	__ piece(s) (__ g) for distinct pieces; fractional slice (__ g) for large discrete units
Pie crust	1/6 of 8 inch crust; 1/8 of 9 inch crust.	1/6 of 8 inch crust (__ g); 1/8 of 9 inch crust (__ g)
Pizza crust	55 g	fractional slice (__ g)
Taco shells, hard	30 g	shell(s) (__ g)
Waffles	85 g	__ piece(s) (__ g)
Beverages:		
Carbonated and noncarbonated beverages, wine coolers, water.	240 mL	8 fl oz (240 mL)
Coffee or tea, flavored and sweetened	240 mL prepared	8 fl oz (240 mL)
Cereal and Other Grain Products:		
Breakfast cereals (hot cereal type), hominy grits	1 cup prepared; 40 g plain dry cereal; 55 g flavored, sweetened dry cereal.	__ cup(s) (__ g)

TABLE 2—REFERENCE AMOUNTS CUSTOMARILY CONSUMED PER EATING OCCASION: GENERAL FOOD SUPPLY ^{1,2,3,4}—Continued

Product category	Reference amount	Label statement ⁵
Breakfast cereals, ready-to-eat, weighing less than 20 g per cup, e.g., plain puffed cereal grains.	15 g	__ cup(s) (__ g)
Breakfast cereals, ready-to-eat weighing 20 g or more but less than 43 g per cup; high fiber cereals containing 28 g or more of fiber per 100 g.	30 g	__ cup(s) (__ g)
Breakfast cereals, ready-to-eat, weighing 43 g or more per cup; biscuit types.	55 g	__ piece(s) (__ g) for large distinct pieces (e.g., biscuit type); __ cup(s) (__ g) for all others
Bran or wheat germ	15 g	__ tbsp(s) (__ g); __ cup(s) (__ g)
Flours or cornmeal	30 g	__ tbsp(s) (__ g); __ cup(s) (__ g)
Grains, e.g., rice, barley, plain	140 g prepared; 45 g dry.	__ cup(s) (__ g)
Pastas, plain	140 g prepared; 55 g dry.	__ cup(s) (__ g); __ piece(s) (__ g) for large pieces (e.g., large shells or lasagna noodles) or 2 oz (56 g/visual unit of measure) for dry bulk products (e.g., spaghetti)
Pastas, dry, ready-to-eat, e.g., fried canned chow mein noodles.	25 g	__ cup(s) (__ g)
Starches, e.g., cornstarch, potato starch, tapioca, etc.	10 g	__ tbsp (__ g)
Stuffing	100 g	__ cup(s) (__ g)
Dairy Products and Substitutes:		
Cheese, cottage	110 g	__ cup (__ g)
Cheese used primarily as ingredients, e.g., dry cottage cheese, ricotta cheese.	55 g	__ cup (__ g)
Cheese, grated hard, e.g., Parmesan, Romano	5 g	__ tbsp (__ g)
Cheese, all others except those listed as separate categories—includes cream cheese and cheese spread.	30 g	__ piece(s) (__ g) for distinct pieces; __ tbsp(s) (__ g) for cream cheese and cheese spread; 1 oz (28 g/visual unit of measure) for bulk
Cheese sauce—see sauce category.		
Cream or cream substitutes, fluid	15 mL	1 tbsp (15 mL)
Cream or cream substitutes, powder	2 g	__ tsp (__ g)
Cream, half & half	30 mL	2 tbsp (30 mL)
Eggnog	120 mL	1/2 cup (120 mL); 4 fl oz (120 mL)
Milk, condensed, undiluted	30 mL	2 tbsp (30 mL)
Milk, evaporated, undiluted	30 mL	2 tbsp (30 mL)
Milk, milk-based drinks, e.g., instant breakfast, meal replacement, cocoa.	240 mL	1 cup (240 mL); 8 fl oz (240 mL)
Shakes or shake substitutes, e.g., dairy shake mixes, fruit frost mixes.	240 mL	1 cup (240 mL); 8 fl oz (240 mL)
Sour cream	30 g	__ tbsp (__ g)
Yogurt	225 g	__ cup (__ g)
Desserts:		
Ice cream, ice milk, frozen yogurt, sherbet: all types, bulk and novelties (e.g., bars, sandwiches, cones).	1/2 cup—includes the volume for coatings and wafers for the novelty type varieties.	__ piece(s) (__ g) for individually wrapped or packaged products; 1/2 cup (__ g) for others
Frozen flavored and sweetened ice and pops, frozen fruit juices: all types, bulk and novelties (e.g., bars, cups).	85 g	__ piece(s) (__ g) for individually wrapped or packaged products; __ cup(s) (__ g) for others
Sundae	1 cup	1 cup (__ g)
Custards, gelatin or pudding	1/2 cup	__ piece(s) (__ g) for distinct unit (e.g., individually packaged products); 1/2 cup (__ g) for bulk
Dessert Toppings and Fillings:		
Cake frostings or icings	35 g	__ tbsp(s) (__ g)
Other dessert toppings, e.g., fruits, syrups, spreads, marshmallow cream, nuts, dairy and nondairy whipped toppings.	2 tbsp	2 tbsp (__ g); 2 tbsp (30 mL)
Pie fillings	85 g	__ cup(s) (__ g)
Egg and Egg Substitutes:		
Egg mixtures, e.g., egg foo young, scrambled eggs, omelets.	110 g	__ piece(s) (__ g) for discrete pieces; __ cup(s) (__ g)
Eggs (all sizes) ⁹	50 g	1 large, medium, etc. (__ g)
Egg substitutes	An amount to make 1 large (50 g) egg.	__ cup(s) (__ g); __ cup(s) (__ mL)
Fats and Oils:		
Butter, margarine, oil, shortening	1 tbsp	1 tbsp (__ g); 1 tbsp (15 mL)
Butter replacement, powder	2 g	__ tsp(s) (__ g)

TABLE 2—REFERENCE AMOUNTS CUSTOMARILY CONSUMED PER EATING OCCASION: GENERAL FOOD SUPPLY ^{1,2,3,4}—Continued

Product category	Reference amount	Label statement ⁵
Dressings for salads	30 g	__ tbsp (__ g); __ tbsp (__ mL)
Mayonnaise, sandwich spreads, mayonnaise-type dressings.	15 g	__ tbsp (__ g)
Spray types	0.25 g	About __ seconds spray (__ g)
Fish, Shellfish, Game Meats ¹⁰ , and Meat or Poultry Substitutes:		
Bacon substitutes, canned anchovies, ¹¹ anchovy pastes, caviar.	15 g	__ piece(s) (__ g) for discrete pieces; __ tbsp(s) (__ g) for others
Dried, e.g., jerky	30 g	__ piece(s) (__ g)
Entrees with sauce, e.g., fish with cream sauce, shrimp with lobster sauce.	140 g cooked	__ cup(s) (__ g); 5 oz (140 g/visual unit of measure) if not measurable by cup
Entrees without sauce, e.g., plain or fried fish and shellfish, fish and shellfish cake.	85 g cooked; 110 g uncooked ¹² .	__ piece(s) (__ g) for discrete pieces; __ cup(s) (__ g); __ oz (__ g/visual unit of measure) if not measurable by cup ¹³
Fish, shellfish or game meat ¹⁰ , canned ¹¹	55 g	__ piece(s) (__ g) for discrete pieces; __ cup(s) (__ g); 2 oz (56 g/ __ cup) for products that are difficult to measure the g weight of cup measure (e.g., tuna); 2 oz (56 g/ __ pieces) for products that naturally vary in size (e.g., sardines)
Substitute for luncheon meat, meat spreads, Canadian bacon, sausages and frankfurters.	55 g	__ piece(s) (__ g) for distinct pieces (e.g., slices, links); __ cup(s) (__ g); 2 oz (56 g/visual unit of measure) for nondiscrete bulk product
Smoked or pickled ¹¹ fish, shellfish, or game meat ¹⁰ ; fish or shellfish spread.	55 g	__ piece(s) (__ g) for distinct pieces (e.g., slices, links) or __ cup(s) (__ g); 2 oz (56 g/visual unit of measure) for nondiscrete bulk product
Substitutes for bacon bits—see miscellaneous category.		
Fruits and Fruit Juices:		
Candied or pickled ¹¹	30 g	__ piece(s) (__ g)
Dehydrated fruits—see snacks category		
Dried	40 g	__ piece(s) (__ g) for large pieces (e.g., dates, figs, prunes); __ cup(s) (__ g) for small pieces (e.g., raisins)
Fruits for garnish or flavor, e.g., maraschino cherries ¹¹ .	4 g	1 cherry (__ g)
Fruit relishes, e.g., cranberry sauce, cranberry relish	70 g	__ cup(s) (__ g)
Fruits used primarily as ingredients, avocado	30 g	See footnote 13
Fruits used primarily as ingredients, others (cranberries, lemon, lime).	55 g	__ piece(s) (__ g) for large fruits; __ cup(s) (__ g) for small fruits measurable by cup ¹³
Watermelon	280 g	See footnote 13
All other fruits (except those listed as separate categories), fresh, canned, or frozen.	140 g	__ piece(s) (__ g) for large pieces (e.g., strawberries, prunes, apricots, etc.); __ cup(s) (__ g) for small pieces (e.g., blueberries, raspberries, etc.) ¹³
Juices, nectars, fruit drinks	240 mL	8 fl oz (240 mL)
Juices used as ingredients, e.g., lemon juice, lime juice.	5 mL	1 tsp (5 mL)
Legumes:		
Bean cake (tofu) ¹¹ , tempeh	85 g	__ piece(s) (__ g) for discrete pieces; 3 oz (84 g/visual unit of measure) for bulk products
Beans, plain or in sauce	130 g for beans in sauce or canned in liquid and refried beans prepared; 90 g for others prepared; 35 g dry.	__ cup (__ g)
Miscellaneous Category:		
Baking powder, baking soda, pectin	0.6 g	__ tsp (__ g)
Baking decorations, e.g., colored sugars and sprinkles for cookies, cake decorations.	1 tsp or 4 g if not measurable by teaspoon.	__ piece(s) (__ g) for discrete pieces; 1 tsp (__ g)
Batter mixes, bread crumbs	30 g	__ tbsp(s) (__ g); __ cup(s) (__ g)
Cooking wine	30 mL	2 tbsp (30 mL)

TABLE 2—REFERENCE AMOUNTS CUSTOMARILY CONSUMED PER EATING OCCASION: GENERAL FOOD SUPPLY ^{1,2,3,4}—Continued

Product category	Reference amount	Label statement ⁵
Dietary supplements	The maximum amount recommended, as appropriate, on the label for consumption per eating occasion, or, in the absence of recommendations, 1 unit, e.g., tablet, capsule, packet, teaspoonful, etc..	__ tablet(s), __ capsule(s), __ packet(s), __ tsp(s) (__ g), etc.
Drink mixers (without alcohol)	Amount to make 240 mL drink (without ice).	__ fl oz (__ mL)
Chewing gum ⁹	3 g	__ piece(s) (__ g)
Meat, poultry and fish coating mixes, dry; seasoning mixes, dry, e.g., chili seasoning mixes, pasta salad seasoning mixes.	Amount to make one reference amount of final dish.	__ tsp(s) (__ g); __ tbsp(s) (__ g)
Salad and potato toppers, e.g., salad crunchies, salad crispins, substitutes for bacon bits.	7 g	__ tbsp(s) (__ g)
Salt, salt substitutes, seasoning salts (e.g., garlic salt)	1/4 tsp	1/4 tsp (__ g); __ piece(s) (__ g) for discrete pieces (e.g., individually packaged products)
Spices, herbs (other than dietary supplements)	1/4 tsp or 0.5 g if not measurable by teaspoon.	1/4 tsp (__ g); __ piece(s) (__ g) if not measurable by teaspoons (e.g., bay leaf)
Mixed Dishes:		
Measurable with cup, e.g., casseroles, hash, macaroni and cheese, pot pies, spaghetti with sauce, stews, etc..	1 cup	1 cup (__ g)
Not measurable with cup, e.g., burritos, egg rolls, enchiladas, pizza, pizza rolls, quiche, all types of sandwiches.	140 g, add 55 g for products with gravy or sauce topping, e.g., enchilada with cheese sauce, crepe with white sauce ¹⁴ .	__ piece(s) (__ g) for discrete pieces; __ fractional slice (__ g) for large discrete units
Nuts and Seeds:		
Nuts, seeds, and mixtures, all types: sliced, chopped, slivered, and whole.	30 g	__ piece(s) (__ g) for large pieces (e.g., unshelled nuts); __ tbsp(s) (__ g) ; __ cup(s) (__ g) for small pieces (e.g., peanuts, sunflower seeds)
Nut and seed butters, pastes, or creams	2 tbsp	2 tbsp (__ g)
Coconut, nut and seed flours	15 g	__ tbsp(s) (__ g); __ cup (__ g)
Potatoes and Sweet Potatoes/Yams:		
French fries, hash browns, skins, or pancakes	70 g prepared; 85 g for frozen unprepared french fries.	__ piece(s) (__ g) for large distinct pieces (e.g., patties, skins); 2.5 oz (70 g/ __ pieces) for prepared fries; 3 oz (84 g/ __ pieces) for unprepared fries
Mashed, candied, stuffed, or with sauce	140 g	__ piece(s) (__ g) for discrete pieces (e.g., stuffed potato); __ cup(s) (__ g)
Plain, fresh, canned, or frozen	110 g for fresh or frozen; 125 g for vacuum packed; 160 g for canned in liquid.	__ piece(s) (__ g) for discrete pieces; __ cup(s) (__ g) for sliced or chopped products
Salads:		
Gelatin salad	120 g	__ cup (__ g)
Pasta or potato salad	140 g	__ cup(s) (__ g)
All other salads, e.g., egg, fish, shellfish, bean, fruit, or vegetable salads.	100 g	__ cup(s) (__ g)
Sauces, Dips, Gravies and Condiments:		
Barbecue sauce, hollandaise sauce, tartar sauce, other sauces for dipping (e.g., mustard sauce, sweet and sour sauce), all dips (e.g., bean dips, dairy-based dips, salsa).	2 tbsp	2 tbsp (__ g); 2 tbsp (30 mL)
Major main entree sauces, e.g., spaghetti sauce	125 g	__ cup (__ g); __ cup (__ mL)

TABLE 2—REFERENCE AMOUNTS CUSTOMARILY CONSUMED PER EATING OCCASION: GENERAL FOOD SUPPLY ^{1,2,3,4}—Continued

Product category	Reference amount	Label statement ⁵
Minor main entree sauces (e.g., pizza sauce, pesto sauce), other sauces used as toppings (e.g., gravy, white sauce, cheese sauce), cocktail sauce.	1/4 cup	1/4 cup (_ g); 1/4 cup (60 mL)
Major condiments, e.g., catsup, steak sauce, soy sauce, vinegar, teriyaki sauce, marinades.	1 tbsp	1 tbsp (_ g); 1 tbsp (15 mL)
Minor condiments, e.g., horseradish, hot sauces, mustards, worcestershire sauce.	1 tsp	1 tsp (_ g); 1 tsp (5 mL)
Snacks:		
All varieties, chips, pretzels, popcorns, extruded snacks, fruit-based snacks (e.g., fruit chips,) grain-based snack mixes.	30 g	_ cup(s) (_ g) for small pieces (e.g., popcorn) _ piece(s) (_ g) for large pieces (e.g., large pretzels; pressed dried fruit sheet); 1 oz (28 g/visual unit of measure) for bulk products (e.g., potato chips)
Soups:		
All varieties	245 g	_ cup (_ g); _ cup (_ mL)
Sugars and Sweets:		
Baking candies (e.g., chips)	15 g	_ piece(s) (_ g) for large pieces; _ tbsp(s) (_ g) for small pieces; 1/2 oz (14 g/visual unit of measure) for bulk products
Hard candies, breath mints	2 g	_ piece(s) (_ g)
Hard candies, roll-type, mini-size in dispenser packages.	5 g	_ piece(s) (_ g)
Hard candies, others	15 g	_ piece(s) (_ g) for large pieces; _ tbsp(s) (_ g) for "mini-size" candies measurable by tablespoon; 1/2 oz (14 g/visual unit of measure) for bulk products
All other candies	40 g	_ piece(s) (_ g); 1 1/2 oz (42 g/visual unit of measure) for bulk products
Confectioner's sugar	30 g	_ cup (_ g)
Honey, jams, jellies, fruit butter, molasses	1 tbsp	1 tbsp (_ g); 1 tbsp (15 mL)
Marshmallows	30 g	_ cup(s) (_ g) for small pieces; _ piece(s) (_ g) for large pieces
Sugar	4 g	_ tsp (_ g); _ piece(s) (_ g) for discrete pieces (e.g., sugar cubes, individually packaged products)
Sugar substitutes	An amount equivalent to one reference amount for sugar in sweetness.	_ tsp(s) (_ g) for solids; _ drop(s) (_ g) for liquid; _ piece(s) (_ g) (e.g., individually packaged products)
Syrups	30 mL for syrups used primarily as an ingredient (e.g., light or dark corn syrup); 60 mL for all others.	2 tbsp (30 mL) for syrups used primarily as an ingredient; 1/4 cup (60 mL) for all others
Vegetables:		
Vegetables primarily used for garnish or flavor, e.g., pimento, parsley.	4 g	_ piece(s) (_ g); _ tbsp(s) (_ g) for chopped products
Chili pepper, green onion	30 g	_ piece(s) (_ g) ¹³ ; _ tbsp(s) (_ g); _ cup(s) (_ g) for sliced or chopped products
All other vegetables without sauce: fresh, canned, or frozen.	85 g for fresh or frozen; 95 g for vacuum packed; 130 g for canned in liquid, cream-style corn, canned or stewed tomatoes, pumpkin, or winter squash.	_ piece(s) (_ g) for large pieces (e.g., brussel sprouts); _ cup(s) (_ g) for small pieces (e.g., cut corn, green peas); 3 oz (84 g/visual unit of measure) if not measurable by cup ¹³
All other vegetables with sauce: fresh, canned, or frozen.	110 g	_ piece(s) (_ g) for large pieces (e.g., brussel sprouts); _ cup(s) (_ g) for small pieces (e.g., cut corn, green peas); 4 oz (112 g/visual unit of measure) if not measurable by cup
Vegetable juice	240 mL	8 fl oz (240 mL)

TABLE 2—REFERENCE AMOUNTS CUSTOMARILY CONSUMED PER EATING OCCASION: GENERAL FOOD SUPPLY^{1,2,3,4}—Continued

Product category	Reference amount	Label statement ⁵
Olives ¹¹	15 g	__ piece(s) (__ g); __ tbsp(s) (__ g) for sliced products
Pickles, all types ¹¹	30 g	1 oz (28 g/visual unit of measure)
Pickle relishes	15 g	__ tbsp (__ g)
Vegetable pastes, e.g., tomato paste	30 g	__ tbsp (__ g)
Vegetable sauces or purees, e.g., tomato sauce, tomato puree.	60 g	__ cup (__ g); __ cup (__ mL)

¹ These values represent the amount (edible portion) of food customarily consumed per eating occasion and were primarily derived from the 1977–1978 and the 1987–1988 Nationwide Food Consumption Surveys conducted by the U.S. Department of Agriculture.

² Unless otherwise noted in the Reference Amount column, the reference amounts are for the ready-to-serve or almost ready-to-serve form of the product (i.e., heat and serve, brown and serve). If not listed separately, the reference amount for the unprepared form (e.g., dry mixes; concentrates; dough; batter; fresh and frozen pasta) is the amount required to make the reference amount of the prepared form. Prepared means prepared for consumption (e.g., cooked).

³ Manufacturers are required to convert the reference amount to the label serving size in a household measure most appropriate to their specific product using the procedures in 21 CFR 101.9(b).

⁴ Copies of the list of products for each product category are available from the Office of Nutritional Products, Labeling and Dietary Supplements (HFS–800), Center for Food Safety and Applied Nutrition, Food and Drug Administration, 5100 Paint Branch Pkwy., College Park, MD 20740.

⁵ The label statements are meant to provide guidance to manufacturers on the presentation of serving size information on the label, but they are not required. The term “piece” is used as a generic description of a discrete unit. Manufacturers should use the description of a unit that is most appropriate for the specific product (e.g., sandwich for sandwiches, cookie for cookies, and bar for ice cream bars). The guidance provided is for the label statement of products in ready-to-serve or almost ready-to-serve form. The guidance does not apply to the products which require further preparation for consumption (e.g., dry mixes, concentrates) unless specifically stated in the product category, reference amount, or label statement column that it is for these forms of the product. For products that require further preparation, manufacturers must determine the label statement following the rules in §101.9(b) using the reference amount determined according to § 101.12(c).

⁶ Includes cakes that weigh 10 g or more per cubic inch.

⁷ Includes cakes that weigh 4 g or more per cubic inch but less than 10 g per cubic inch.

⁸ Includes cakes that weigh less than 4 g per cubic inch.

⁹ Label serving size for ice cream cones and eggs of all sizes will be 1 unit. Label serving size of all chewing gums that weigh more than the reference amount that can reasonably be consumed at a single-eating occasion will be 1 unit.

¹⁰ Animal products not covered under the Federal Meat Inspection Act or the Poultry Products Inspection Act, such as flesh products from deer, bison, rabbit, quail, wild turkey, geese, ostrich, etc.

¹¹ If packed or canned in liquid, the reference amount is for the drained solids, except for products in which both the solids and liquids are customarily consumed (e.g., canned chopped clam in juice).

¹² The reference amount for the uncooked form does not apply to raw fish in § 101.45 or to single-ingredient products that consist of fish or game meat as provided for in § 101.9(b)(11).

¹³ For raw fruit, vegetables, and fish, manufacturers should follow the label statement for the serving size specified in Appendices A and B to the regulation entitled “Food Labeling; Guidelines for Voluntary Nutrition Labeling; and Identification of the 20 Most Frequently Consumed Raw Fruits, Vegetables, and Fish; Definition of Substantial Compliance; Correction” (56 FR 60880 as amended 57 FR 8174, March 6, 1992).

¹⁴ Pizza sauce is part of the pizza and is not considered to be sauce topping.

(c) If a product requires further preparation, e.g., cooking or the addition of water or other ingredients, and if paragraph (b) of this section provides a reference amount for the product in the prepared but not the unprepared form, then the reference amount for the unprepared product shall be determined using the following rules:

(1) Except as provided for in paragraph (c)(2) of this section, the reference amount for the unprepared product shall be the amount of the unprepared product required to make the reference amount for the prepared product as established in paragraph (b) of this section.

(2) For products where the entire contents of the package is used to prepare one large discrete unit usually divided for consumption, the reference amount for the unprepared product shall be the amount of the unprepared

product required to make the fraction of the large discrete unit closest to the reference amount for the prepared product as established in paragraph (b) of this section.

(d) The reference amount for an imitation or substitute food or altered food, such as a “low calorie” version, shall be the same as for the food for which it is offered as a substitute.

(e) If a food is modified by incorporating air (aerated), and thereby the density of the food is lowered by 25 percent or more in weight than that of an appropriate reference regular food as described in §101.13(j)(1)(ii)(A), and the reference amount of the regular food is in grams, the manufacturer may determine the reference amount of the aerated food by adjusting for the difference in density of the aerated food relative to the density of the appropriate reference food provided that the

manufacturer will show FDA detailed protocol and records of all data that were used to determine the density-adjusted reference amount for the aerated food. The reference amount for the aerated food shall be rounded to the nearest 5-g increment. Such products shall bear a descriptive term indicating that extra air has been incorporated (e.g., whipped, aerated). The density-adjusted reference amounts described in paragraph (b) of this section may not be used for cakes except for cheese cake. The differences in the densities of different types of cakes having different degrees of air incorporation have already been taken into consideration in determining the reference amounts for cakes in §101.12(b). In determining the difference in density of the aerated and the regular food, the manufacturer shall adhere to the following:

(1) The regular and the aerated product must be the same in size, shape, and volume. To compare the densities of products having nonsmooth surfaces (e.g., waffles), manufacturers shall use a device or method that ensures that the volumes of the regular and the aerated products are the same.

(2) Sample selections for the density measurements shall be done in accordance with the provisions in §101.9(g).

(3) Density measurements of the regular and the aerated products shall be conducted by the same trained operator using the same methodology (e.g., the same equipment, procedures, and techniques) under the same conditions.

(4) Density measurements shall be replicated a sufficient number of times to ensure that the average of the measurements is representative of the true differences in the densities of the regular and the “aerated” products.

(f) For products that have no reference amount listed in paragraph (b) of this section for the unprepared or the prepared form of the product and that consist of two or more foods packaged and presented to be consumed together (e.g., peanut butter and jelly, cracker and cheese pack, pancakes and syrup, cake and frosting), the reference amount for the combined product shall be determined using the following rules:

(1) For bulk products (e.g., peanut butter and jelly), the reference amount for the combined product shall be the reference amount, as established in paragraph (b) of this section, for the ingredient that is represented as the main ingredient plus proportioned amounts of all minor ingredients.

(2) For products where the ingredient represented as the main ingredient is one or more discrete units (e.g., cracker and cheese pack, pancakes and syrup, cake and frosting), the reference amount for the combined product shall be either the number of small discrete units or the fraction of the large discrete unit that is represented as the main ingredient that is closest to the reference amount for that ingredient as established in paragraph (b) of this section plus proportioned amounts of all minor ingredients.

(3) If the reference amounts are in compatible units, they shall be summed (e.g., the reference amount for equal volumes of peanut butter and jelly for which peanut butter is represented as the main ingredient would be 4 tablespoons (tbsp) (2 tbsp peanut butter plus 2 tbsp jelly). If the reference amounts are in incompatible units, the weights of the appropriate volumes should be used (e.g., 110 grams (g) pancakes plus the gram weight of the proportioned amount of syrup).

(g) The reference amounts set forth in paragraphs (b) through (f) of this section shall be used in determining whether a product meets the criteria for nutrient content claims, such as “low calorie,” and for health claims. If the serving size declared on the product label differs from the reference amount, and the product meets the criteria for the claim only on the basis of the reference amount, the claim shall be followed by a statement that sets forth the basis on which the claim is made. That statement shall include the reference amount as it appears in paragraph (b) of this section followed, in parenthesis, by the amount in common household measure if the reference amount is expressed in measures other than common household measures (e.g., for a beverage, “Very low sodium, 35 mg or less per 240 mL (8 fl oz)”).

(h) The Commissioner of Food and Drugs, either on his or her own initiative or in response to a petition submitted pursuant to part 10 of this chapter, may issue a proposal to establish or amend a reference amount in paragraph (b) of this section. A petition to establish or amend a reference amount shall include:

- (1) Objective of the petition;
- (2) A description of the product;
- (3) A complete sample product label including nutrition label, using the format established by regulation;
- (4) A description of the form (e.g., dry mix, frozen dough) in which the product will be marketed;
- (5) The intended dietary uses of the product with the major use identified (e.g., milk as a beverage and chips as a snack);
- (6) If the intended use is primarily as an ingredient in other foods, list of foods or food categories in which the product will be used as an ingredient with information on the prioritization of the use;
- (7) The population group for which the product will be offered for use (e.g., infants, children under 4 years of age);
- (8) The names of the most closely related products (or in the case of foods for special dietary use and imitation or substitute foods, the names of the products for which they are offered as substitutes);
- (9) The suggested reference amount (the amount of edible portion of food as consumed, excluding bone, seed, shell, or other inedible components) for the population group for which the product is intended with full description of the methodology and procedures that were used to determine the suggested reference amount. In determining the reference amount, general principles and factors in paragraph (a) of this section should be followed.
- (10) The suggested reference amount shall be expressed in metric units. Reference amounts for fluids shall be expressed in milliliters. Reference amounts for other foods shall be expressed in grams except when common household units such as cups, tablespoons, and teaspoons, are more appropriate or are more likely to promote uniformity in serving sizes declared on product labels. For example, common

household measures would be more appropriate if products within the same category differ substantially in density, such as frozen desserts.

(i) In expressing the reference amounts in milliliters, the following rules shall be followed:

(A) For volumes greater than 30 milliliters (mL), the volume shall be expressed in multiples of 30 mL.

(B) For volumes less than 30 mL, the volume shall be expressed in milliliters equivalent to a whole number of teaspoons or 1 tbsp, i.e., 5, 10, or 15 mL.

(ii) In expressing the reference amounts in grams, the following general rules shall be followed:

(A) For quantities greater than 10 g, the quantity shall be expressed in the nearest 5-g increment.

(B) For quantities less than 10 g, exact gram weights shall be used.

(11) A petition to create a new subcategory of food with its own reference amount shall include the following additional information:

(i) Data that demonstrate that the new subcategory of food will be consumed in amounts that differ enough from the reference amount for the parent category to warrant a separate reference amount. Data must include sample size; and the mean, standard deviation, median, and modal consumed amount per eating occasion for the petitioned product and for other products in the category, excluding the petitioned product. All data must be derived from the same survey data.

(ii) Documentation supporting the difference in dietary usage and product characteristics that affect the consumption size that distinguishes the petitioned product from the rest of the products in the category.

(12) A claim for categorical exclusion under §25.30 or 25.32 of this chapter or an environmental assessment under §25.40 of this chapter, and

(13) In conducting research to collect or process food consumption data in support of the petition, the following general guidelines should be followed.

(i) Sampled population selected should be representative of the demographic and socioeconomic characteristics of the target population group for which the food is intended.

§ 101.13

21 CFR Ch. I (4–1–07 Edition)

(ii) Sample size (i.e., number of eaters) should be large enough to give reliable estimates for customarily consumed amounts.

(iii) The study protocol should identify potential biases and describe how potential biases are controlled for or, if not possible to control, how they affect interpretation of results.

(iv) The methodology used to collect or process data should be fully documented and should include: study design, sampling procedures, materials used (e.g., questionnaire, and interviewer's manual), procedures used to collect or process data, methods or procedures used to control for unbiased estimates, and procedures used to correct for nonresponse.

(14) A statement concerning the feasibility of convening associations, corporations, consumers, and other interested parties to engage in negotiated rulemaking to develop a proposed rule consistent with the Negotiated Rulemaking Act (5 U.S.C. 561).

[58 FR 44051, Aug. 18, 1993; 58 FR 60109, Nov. 15, 1993, as amended at 59 FR 371, Jan. 4, 1994; 59 FR 24039, May 10, 1994; 62 FR 40598, July 29, 1997; 62 FR 49848, Sept. 23, 1997; 63 FR 14818, Mar. 27, 1998; 64 FR 12890, Mar. 16, 1999; 66 FR 56035, Nov. 6, 2001]

§ 101.13 Nutrient content claims—general principles.

(a) This section and the regulations in subpart D of this part apply to foods that are intended for human consumption and that are offered for sale, including conventional foods and dietary supplements.

(b) A claim that expressly or implicitly characterizes the level of a nutrient of the type required to be in nutrition labeling under § 101.9 or under § 101.36 (that is, a nutrient content claim) may not be made on the label or in labeling of foods unless the claim is made in accordance with this regulation and with the applicable regulations in subpart D of this part or in part 105 or part 107 of this chapter.

(1) An expressed nutrient content claim is any direct statement about the level (or range) of a nutrient in the food, e.g., “low sodium” or “contains 100 calories.”

(2) An implied nutrient content claim is any claim that:

(i) Describes the food or an ingredient therein in a manner that suggests that a nutrient is absent or present in a certain amount (e.g., “high in oat bran”); or

(ii) Suggests that the food, because of its nutrient content, may be useful in maintaining healthy dietary practices and is made in association with an explicit claim or statement about a nutrient (e.g., “healthy, contains 3 grams (g) of fat”).

(3) Except for claims regarding vitamins and minerals described in paragraph (q)(3) of this section, no nutrient content claims may be made on food intended specifically for use by infants and children less than 2 years of age unless the claim is specifically provided for in parts 101, 105, or 107 of this chapter.

(4) Reasonable variations in the spelling of the terms defined in part 101 and their synonyms are permitted provided these variations are not misleading (e.g., “hi” or “lo”).

(5) For dietary supplements, claims for calories, fat, saturated fat, and cholesterol may not be made on products that meet the criteria in § 101.60(b)(1) or (b)(2) for “calorie free” or “low calorie” claims, except, in the case of calorie claims, when an equivalent amount of a similar dietary supplement (e.g., another protein supplement) that the labeled food resembles and for which it substitutes, normally exceeds the definition for “low calorie” in § 101.60(b)(2).

(c) Information that is required or permitted by § 101.9 or § 101.36, as applicable, to be declared in nutrition labeling, and that appears as part of the nutrition label, is not a nutrient content claim and is not subject to the requirements of this section. If such information is declared elsewhere on the label or in labeling, it is a nutrient content claim and is subject to the requirements for nutrient content claims.

(d) A “substitute” food is one that may be used interchangeably with another food that it resembles, i.e., that it is organoleptically, physically, and functionally (including shelf life) similar to, and that it is not nutritionally inferior to unless it is labeled as an “imitation.”

(1) If there is a difference in performance characteristics that materially limits the use of the food, the food may still be considered a substitute if the label includes a disclaimer adjacent to the most prominent claim as defined in paragraph (j)(2)(iii) of this section, informing the consumer of such difference (e.g., “not recommended for frying”).

(2) This disclaimer shall be in easily legible print or type and in a size no less than that required by §101.105(i) for the net quantity of contents statement, except where the size of the claim is less than two times the required size of the net quantity of contents statement, in which case the disclaimer shall be no less than one-half the size of the claim but no smaller than one-sixteenth of an inch, unless the package complies with §101.2(c)(5), in which case the disclaimer may be in type of not less than one thirty-second of an inch.

(e)(1) Because the use of a “free” or “low” claim before the name of a food implies that the food differs from other foods of the same type by virtue of its having a lower amount of the nutrient, only foods that have been specially processed, altered, formulated, or reformulated so as to lower the amount of the nutrient in the food, remove the nutrient from the food, or not include the nutrient in the food, may bear such a claim (e.g., “low sodium potato chips”).

(2) Any claim for the absence of a nutrient in a food, or that a food is low in a nutrient when the food has not been specially processed, altered, formulated, or reformulated to qualify for that claim shall indicate that the food inherently meets the criteria and shall clearly refer to all foods of that type and not merely to the particular brand to which the labeling attaches (e.g., “corn oil, a sodium-free food”).

(f) A nutrient content claim shall be in type size no larger than two times the statement of identity and shall not be unduly prominent in type style compared to the statement of identity.

(g) [Reserved]

(h)(1) If a food, except a meal product as defined in §101.13(l), a main dish product as defined in §101.13(m), or food intended specifically for use by infants

and children less than 2 years of age, contains more than 13.0 g of fat, 4.0 g of saturated fat, 60 milligrams (mg) of cholesterol, or 480 mg of sodium per reference amount customarily consumed, per labeled serving, or, for a food with a reference amount customarily consumed of 30 g or less or 2 tablespoons or less, per 50 g (for dehydrated foods that must be reconstituted before typical consumption with water or a diluent containing an insignificant amount, as defined in §101.9(f)(1), of all nutrients per reference amount customarily consumed, the per 50 g criterion refers to the “as prepared” form), then that food must bear a statement disclosing that the nutrient exceeding the specified level is present in the food as follows: “See nutrition information for ___ content” with the blank filled in with the identity of the nutrient exceeding the specified level, e.g., “See nutrition information for fat content.”

(2) If a food is a meal product as defined in §101.13(l), and contains more than 26 g of fat, 8.0 g of saturated fat, 120 mg of cholesterol, or 960 mg of sodium per labeled serving, then that food must disclose, in accordance with the requirements as provided in paragraph (h)(1) of this section, that the nutrient exceeding the specified level is present in the food.

(3) If a food is a main dish product as defined in §101.13(m), and contains more than 19.5 g of fat, 6.0 g of saturated fat, 90 mg of cholesterol, or 720 mg of sodium per labeled serving, then that food must disclose, in accordance with the requirements as provided in paragraph (h)(1) of this section, that the nutrient exceeding the specified level is present in the food.

(4)(i) The disclosure statement “See nutrition information for ___ content” shall be in easily legible boldface print or type, in distinct contrast to other printed or graphic matter, and in a size no less than that required by §101.105(i) for the net quantity of contents statement, except where the size of the claim is less than two times the required size of the net quantity of contents statement, in which case the disclosure statement shall be no less than one-half the size of the claim but no smaller than one-sixteenth of an inch,

unless the package complies with §101.2(c)(2), in which case the disclosure statement may be in type of not less than one thirty-second of an inch.

(ii) The disclosure statement shall be immediately adjacent to the nutrient content claim and may have no intervening material other than, if applicable, other information in the statement of identity or any other information that is required to be presented with the claim under this section (e.g., see paragraph (j)(2) of this section) or under a regulation in subpart D of this part (e.g., see §§101.54 and 101.62). If the nutrient content claim appears on more than one panel of the label, the disclosure statement shall be adjacent to the claim on each panel except for the panel that bears the nutrition information where it may be omitted.

(iii) If a single panel of a food label or labeling contains multiple nutrient content claims or a single claim repeated several times, a single disclosure statement may be made. The statement shall be adjacent to the claim that is printed in the largest type on that panel.

(i) Except as provided in §101.9 or §101.36, as applicable, or in paragraph (q)(3) of this section, the label or labeling of a product may contain a statement about the amount or percentage of a nutrient if:

(1) The use of the statement on the food implicitly characterizes the level of the nutrient in the food and is consistent with a definition for a claim, as provided in subpart D of this part, for the nutrient that the label addresses. Such a claim might be, “less than 3 g of fat per serving;”

(2) The use of the statement on the food implicitly characterizes the level of the nutrient in the food and is not consistent with such a definition, but the label carries a disclaimer adjacent to the statement that the food is not “low” in or a “good source” of the nutrient, such as “only 200 mg sodium per serving, not a low sodium food.” The disclaimer must be in easily legible print or type and in a size no less than that required by §101.105(i) for the net quantity of contents statement except where the size of the claim is less than two times the required size of the net quantity of contents statement, in

which case the disclaimer shall be no less than one-half the size of the claim but no smaller than one-sixteenth of an inch unless the package complies with §101.2(c)(5), in which case the disclaimer may be in type of not less than one thirty-second of an inch, or

(3) The statement does not in any way implicitly characterize the level of the nutrient in the food and it is not false or misleading in any respect (e.g., “100 calories” or “5 grams of fat”), in which case no disclaimer is required.

(4) “Percent fat free” claims are not authorized by this paragraph. Such claims shall comply with §101.62(b)(6).

(j) A food may bear a statement that compares the level of a nutrient in the food with the level of a nutrient in a reference food. These statements shall be known as “relative claims” and include “light,” “reduced,” “less” (or “fewer”), and “more” claims.

(1) To bear a relative claim about the level of a nutrient, the amount of that nutrient in the food must be compared to an amount of nutrient in an appropriate reference food as specified below.

(i)(A) For “less” (or “fewer”) and “more” claims, the reference food may be a dissimilar food within a product category that can generally be substituted for one another in the diet (e.g., potato chips as reference for pretzels, orange juice as a reference for vitamin C tablets) or a similar food (e.g., potato chips as reference for potato chips, one brand of multivitamin as reference for another brand of multivitamin).

(B) For “light,” “reduced,” “added,” “extra,” “plus,” “fortified,” and “enriched” claims, the reference food shall be a similar food (e.g., potato chips as a reference for potato chips, one brand of multivitamin for another brand of multivitamin), and

(ii)(A) For “light” claims, the reference food shall be representative of the type of food that includes the product that bears the claim. The nutrient value for the reference food shall be representative of a broad base of foods of that type; e.g., a value in a representative, valid data base; an average value determined from the top three national (or regional) brands, a market basket norm; or, where its nutrient

value is representative of the food type, a market leader. Firms using such a reference nutrient value as a basis for a claim, are required to provide specific information upon which the nutrient value was derived, on request, to consumers and appropriate regulatory officials.

(B) For relative claims other than “light,” including “less” and “more” claims, the reference food may be the same as that provided for “light” in paragraph (j)(1)(ii)(A) of this section, or it may be the manufacturer’s regular product, or that of another manufacturer, that has been offered for sale to the public on a regular basis for a substantial period of time in the same geographic area by the same business entity or by one entitled to use its trade name. The nutrient values used to determine the claim when comparing a single manufacturer’s product to the labeled product shall be either the values declared in nutrition labeling or the actual nutrient values, provided that the resulting label is internally consistent to (i.e., that the values stated in the nutrition information, the nutrient values in the accompanying information and the declaration of the percentage of nutrient by which the food has been modified are consistent and will not cause consumer confusion when compared), and that the actual modification is at least equal to the percentage specified in the definition of the claim.

(2) For foods bearing relative claims:

(i) The label or labeling must state the identity of the reference food and the percentage (or fraction) of the amount of the nutrient in the reference food by which the nutrient in the labeled food differs (e.g., “50 percent less fat than (reference food)” or “1/3 fewer calories than (reference food)”);

(ii) This information shall be immediately adjacent to the most prominent claim. The type size shall be in accordance with paragraph (h)(4)(i) of this section.

(iii) The determination of which use of the claim is in the most prominent location on the label or labeling will be made based on the following factors, considered in order:

(A) A claim on the principal display panel adjacent to the statement of identity;

(B) A claim elsewhere on the principal display panel;

(C) A claim on the information panel; or

(D) A claim elsewhere on the label or labeling.

(iv) The label or labeling must also bear:

(A) Clear and concise quantitative information comparing the amount of the subject nutrient in the product per labeled serving with that in the reference food; and

(B) This statement shall appear adjacent to the most prominent claim or to the nutrition label, except that if the nutrition label is on the information panel, the quantitative information may be located elsewhere on the information panel in accordance with §101.2.

(3) A relative claim for decreased levels of a nutrient may not be made on the label or in labeling of a food if the nutrient content of the reference food meets the requirement for a “low” claim for that nutrient (e.g., 3 g fat or less).

(k) The term “modified” may be used in the statement of identity of a food that bears a relative claim that complies with the requirements of this part, followed immediately by the name of the nutrient whose content has been altered (e.g., “Modified fat cheesecake”). This statement of identity must be immediately followed by the comparative statement such as “Contains 35 percent less fat than _____.” The label or labeling must also bear the information required by paragraph (j)(2) of this section in the manner prescribed.

(1) For purposes of making a claim, a “meal product shall be defined as a food that:

(1) Makes a major contribution to the total diet by:

(i) Weighing at least 10 ounces (oz) per labeled serving; and

(ii) Containing not less than three 40-g portions of food, or combinations of foods, from two or more of the following four food groups, except as noted in paragraph (1)(1)(ii)(E) of this section.

§ 101.13

21 CFR Ch. I (4-1-07 Edition)

(A) Bread, cereal, rice, and pasta group;

(B) Fruits and vegetables group;

(C) Milk, yogurt, and cheese group;

(D) Meat, poultry, fish, dry beans, eggs, and nuts group; except that;

(E) These foods shall not be sauces (except for foods in the above four food groups that are in the sauces), gravies, condiments, relishes, pickles, olives, jams, jellies, syrups, breadings or garnishes; and

(2) Is represented as, or is in a form commonly understood to be, a breakfast, lunch, dinner, or meal. Such representations may be made either by statements, photographs, or vignettes.

(m) For purposes of making a claim, a "main dish product" shall be defined as a food that:

(1) Makes a major contribution to a meal by

(i) Weighing at least 6 oz per labeled serving; and

(ii) Containing not less than 40 g of food, or combinations of foods, from each of at least two of the following four food groups, except as noted in paragraph (m)(1)(ii)(E) of this section.

(A) Bread, cereal, rice, and pasta group;

(B) Fruits and vegetables group;

(C) Milk, yogurt, and cheese group;

(D) Meat, poultry, fish, dry beans, eggs, and nuts groups; except that:

(E) These foods shall not be sauces (except for foods in the above four food groups that are in the sauces) gravies, condiments, relishes, pickles, olives, jams, jellies, syrups, breadings, or garnishes; and

(2) Is represented as, or is in a form commonly understood to be, a main dish (e.g., not a beverage or a dessert). Such representations may be made either by statements, photographs, or vignettes.

(n) Nutrition labeling in accordance with §101.9, §101.10, or §101.36, as applicable, shall be provided for any food for which a nutrient content claim is made.

(o) Except as provided in §101.10, compliance with requirements for nutrient content claims in this section and in the regulations in subpart D of this part, will be determined using the analytical methodology prescribed for

determining compliance with nutrition labeling in §101.9.

(p)(1) Unless otherwise specified, the reference amount customarily consumed set forth in §101.12(b) through (f) shall be used in determining whether a product meets the criteria for a nutrient content claim. If the serving size declared on the product label differs from the reference amount customarily consumed, and the amount of the nutrient contained in the labeled serving does not meet the maximum or minimum amount criterion in the definition for the descriptor for that nutrient, the claim shall be followed by the criteria for the claim as required by §101.12(g) (e.g., "very low sodium, 35 mg or less per 240 milliliters (8 fl oz.)").

(2) The criteria for the claim shall be immediately adjacent to the most prominent claim in easily legible print or type and in a size in accordance with paragraph (h)(4)(i) of this section.

(q) The following exemptions apply:

(1) Nutrient content claims that have not been defined by regulation and that are contained in the brand name of a specific food product that was the brand name in use on such food before October 25, 1989, may continue to be used as part of that brand name for such product, provided that they are not false or misleading under section 403(a) of the Federal Food, Drug, and Cosmetic Act (the act). However, foods bearing such claims must comply with section 403(f), (g), and (h) of the act;

(2) A soft drink that used the term *diet* as part of its brand name before October 25, 1989, and whose use of that term was in compliance with §105.66 of this chapter as that regulation appeared in the Code of Federal Regulations on that date, may continue to use that term as part of its brand name, provided that its use of the term is not false or misleading under section 403(a) of the act. Such claims are exempt from the requirements of section 403(r)(2) of the act (e.g., the disclosure statement also required by §101.13(h)). Soft drinks marketed after October 25, 1989, may use the term "diet" provided they are in compliance with the current §105.66 of this chapter and the requirements of §101.13.

(3)(i) A statement that describes the percentage of a vitamin or mineral in

the food, including foods intended specifically for use by infants and children less than 2 years of age, in relation to a Reference Daily Intake (RDI) as defined in §101.9 may be made on the label or in labeling of a food without a regulation authorizing such a claim for a specific vitamin or mineral unless such claim is expressly prohibited by regulation under section 403(r)(2)(A)(vi) of the act.

(ii) Percentage claims for dietary supplements. Under section 403(r)(2)(F) of the act, a statement that characterizes the percentage level of a dietary ingredient for which a reference daily intake (RDI) or daily reference value (DRV) has not been established may be made on the label or in labeling of dietary supplements without a regulation that specifically defines such a statement. All such claims shall be accompanied by any disclosure statement required under paragraph (h) of this section.

(A) *Simple percentage claims.* Whenever a statement is made that characterizes the percentage level of a dietary ingredient for which there is no RDI or DRV, the statement of the actual amount of the dietary ingredient per serving shall be declared next to the percentage statement (e.g., “40 percent omega-3 fatty acids, 10 mg per capsule”).

(B) *Comparative percentage claims.* Whenever a statement is made that characterizes the percentage level of a dietary ingredient for which there is no RDI or DRV and the statement draws a comparison to the amount of the dietary ingredient in a reference food, the reference food shall be clearly identified, the amount of that food shall be identified, and the information on the actual amount of the dietary ingredient in both foods shall be declared in accordance with paragraph (j)(2)(iv) of this section (e.g., “twice the omega-3 fatty acids per capsule (80 mg) as in 100 mg of menhaden oil (40 mg)”).

(4) The requirements of this section do not apply to:

(i) Infant formulas subject to section 412(h) of the act; and

(ii) Medical foods defined by section 5(b) of the Orphan Drug Act.

(5) A nutrient content claim used on food that is served in restaurants or

other establishments in which food is served for immediate human consumption or which is sold for sale or use in such establishments shall comply with the requirements of this section and the appropriate definition in subpart D of this part, except that:

(i) Such claim is exempt from the requirements for disclosure statements in paragraph (h) of this section and §§101.54(d), 101.62(c), (d)(1)(ii)(D), (d)(2)(iii)(C), (d)(3), (d)(4)(ii)(C), and (d)(5)(ii)(C); and

(ii) In lieu of analytical testing, compliance may be determined using a reasonable basis for concluding that the food that bears the claim meets the definition for the claim. This reasonable basis may derive from recognized data bases for raw and processed foods, recipes, and other means to compute nutrient levels in the foods or meals and may be used provided reasonable steps are taken to ensure that the method of preparation adheres to the factors on which the reasonable basis was determined (e.g., types and amounts of ingredients, cooking temperatures, etc.). Firms making claims on foods based on this reasonable basis criterion are required to provide to appropriate regulatory officials on request the specific information on which their determination is based and reasonable assurance of operational adherence to the preparation methods or other basis for the claim; and

(iii) A term or symbol that may in some contexts constitute a claim under this section may be used, provided that the use of the term or symbol does not characterize the level of a nutrient, and a statement that clearly explains the basis for the use of the term or symbol is prominently displayed and does not characterize the level of a nutrient. For example, a term such as “lite fare” followed by an asterisk referring to a note that makes clear that in this restaurant “lite fare” means smaller portion sizes than normal; or an item bearing a symbol referring to a note that makes clear that this item meets the criteria for the dietary guidance established by a recognized dietary authority would not be considered a nutrient content claim under §101.13.

(6) Nutrient content claims that were part of the common or usual names of

foods that were subject to a standard of identity on November 8, 1990, are not subject to the requirements of paragraphs (b) and (h) of this section or to definitions in subpart D of this part.

(7) Implied nutrient content claims may be used as part of a brand name, provided that the use of the claim has been authorized by the Food and Drug Administration. Petitions requesting approval of such a claim may be submitted under § 101.69(o).

(8) The term *fluoridated*, *fluoride added* or *with added fluoride* may be used on the label or in labeling of bottled water that contains added fluoride.

[58 FR 2410, Jan. 6, 1993; 58 FR 17341, 17342, Apr. 2, 1993, as amended at 58 FR 44030, Aug. 18, 1993; 59 FR 393, Jan. 4, 1994; 59 FR 15051, Mar. 31, 1994; 60 FR 17205, Apr. 5, 1995; 61 FR 11731, Mar. 22, 1996; 61 FR 40332, Aug. 2, 1996; 61 FR 67452, Dec. 23, 1996; 62 FR 31339, June 9, 1997; 62 FR 49867, Sept. 23, 1997; 63 FR 14818, Mar. 27, 1998; 63 FR 26980, May 15, 1998]

§ 101.14 Health claims: general requirements.

(a) *Definitions.* For purposes of this section, the following definitions apply:

(1) *Health claim* means any claim made on the label or in labeling of a food, including a dietary supplement, that expressly or by implication, including “third party” references, written statements (e.g., a brand name including a term such as “heart”), symbols (e.g., a heart symbol), or vignettes, characterizes the relationship of any substance to a disease or health-related condition. Implied health claims include those statements, symbols, vignettes, or other forms of communication that suggest, within the context in which they are presented, that a relationship exists between the presence or level of a substance in the food and a disease or health-related condition.

(2) *Substance* means a specific food or component of food, regardless of whether the food is in conventional food form or a dietary supplement that includes vitamins, minerals, herbs, or other similar nutritional substances.

(3) *Nutritive value* means a value in sustaining human existence by such processes as promoting growth, replac-

ing loss of essential nutrients, or providing energy.

(4) *Disqualifying nutrient levels* means the levels of total fat, saturated fat, cholesterol, or sodium in a food above which the food will be disqualified from making a health claim. These levels are 13.0 grams (g) of fat, 4.0 g of saturated fat, 60 milligrams (mg) of cholesterol, or 480 mg of sodium, per reference amount customarily consumed, per label serving size, and, only for foods with reference amounts customarily consumed of 30 g or less or 2 tablespoons or less, per 50 g. For dehydrated foods that must have water added to them prior to typical consumption, the per 50-g criterion refers to the as prepared form. Any one of the levels, on a per reference amount customarily consumed, a per label serving size or, when applicable, a per 50 g basis, will disqualify a food from making a health claim unless an exception is provided in subpart E of this part, except that:

(i) The levels for a meal product as defined in § 101.13(l) are 26.0 g of fat, 8.0 g of saturated fat, 120 mg of cholesterol, or 960 mg of sodium per label serving size, and

(ii) The levels for a main dish product as defined in § 101.13(m) are 19.5 g of fat, 6.0 g of saturated fat, 90 mg of cholesterol, or 720 mg of sodium per label serving size.

(5) *Disease or health-related condition* means damage to an organ, part, structure, or system of the body such that it does not function properly (e.g., cardiovascular disease), or a state of health leading to such dysfunctioning (e.g., hypertension); except that diseases resulting from essential nutrient deficiencies (e.g., scurvy, pellagra) are not included in this definition (claims pertaining to such diseases are thereby not subject to § 101.14 or § 101.70).

(b) *Eligibility.* For a substance to be eligible for a health claim:

(1) The substance must be associated with a disease or health-related condition for which the general U.S. population, or an identified U.S. population subgroup (e.g., the elderly) is at risk, or, alternatively, the petition submitted by the proponent of the claim otherwise explains the prevalence of the disease or health-related condition

in the U.S. population and the relevance of the claim in the context of the total daily diet and satisfies the other requirements of this section.

(2) If the substance is to be consumed as a component of a conventional food at decreased dietary levels, the substance must be a nutrient listed in 21 U.S.C. 343(q)(1)(C) or (q)(1)(D), or one that the Food and Drug Administration (FDA) has required to be included in the label or labeling under 21 U.S.C. 343(q)(2)(A); or

(3) If the substance is to be consumed at other than decreased dietary levels:

(i) The substance must, regardless of whether the food is a conventional food or a dietary supplement, contribute taste, aroma, or nutritive value, or any other technical effect listed in §170.3(o) of this chapter, to the food and must retain that attribute when consumed at levels that are necessary to justify a claim; and

(ii) The substance must be a food or a food ingredient or a component of a food ingredient whose use at the levels necessary to justify a claim has been demonstrated by the proponent of the claim, to FDA's satisfaction, to be safe and lawful under the applicable food safety provisions of the Federal Food, Drug, and Cosmetic Act.

(c) *Validity requirement.* FDA will promulgate regulations authorizing a health claim only when it determines, based on the totality of publicly available scientific evidence (including evidence from well-designed studies conducted in a manner which is consistent with generally recognized scientific procedures and principles), that there is significant scientific agreement, among experts qualified by scientific training and experience to evaluate such claims, that the claim is supported by such evidence.

(d) *General health claim labeling requirements.* (1) When FDA determines that a health claim meets the validity requirements of paragraph (c) of this section, FDA will propose a regulation in subpart E of this part to authorize the use of that claim. If the claim pertains to a substance not provided for in §101.9 or §101.36, FDA will propose amending that regulation to include declaration of the substance.

(2) When FDA has adopted a regulation in subpart E of this part providing for a health claim, firms may make claims based on the regulation in subpart E of this part, provided that:

(i) All label or labeling statements about the substance-disease relationship that is the subject of the claim are based on, and consistent with, the conclusions set forth in the regulations in subpart E of this part;

(ii) The claim is limited to describing the value that ingestion (or reduced ingestion) of the substance, as part of a total dietary pattern, may have on a particular disease or health-related condition;

(iii) The claim is complete, truthful, and not misleading. Where factors other than dietary intake of the substance affect the relationship between the substance and the disease or health-related condition, such factors may be required to be addressed in the claim by a specific regulation in subpart E of this part;

(iv) All information required to be included in the claim appears in one place without other intervening material, except that the principal display panel of the label or labeling may bear the reference statement, "See _____ for information about the relationship between _____ and _____," with the blanks filled in with the location of the labeling containing the health claim, the name of the substance, and the disease or health-related condition (e.g., "See attached pamphlet for information about calcium and osteoporosis"), with the entire claim appearing elsewhere on the other labeling. Provided that, where any graphic material (e.g., a heart symbol) constituting an explicit or implied health claim appears on the label or labeling, the reference statement or the complete claim shall appear in immediate proximity to such graphic material;

(v) The claim enables the public to comprehend the information provided and to understand the relative significance of such information in the context of a total daily diet; and

(vi) If the claim is about the effects of consuming the substance at decreased dietary levels, the level of the substance in the food is sufficiently low to justify the claim. To meet this

§ 101.14

21 CFR Ch. I (4–1–07 Edition)

requirement, if a definition for use of the term *low* has been established for that substance under this part, the substance must be present at a level that meets the requirements for use of that term, unless a specific alternative level has been established for the substance in subpart E of this part. If no definition for “low” has been established, the level of the substance must meet the level established in the regulation authorizing the claim; or

(vii) If the claim is about the effects of consuming the substance at other than decreased dietary levels, the level of the substance is sufficiently high and in an appropriate form to justify the claim. To meet this requirement, if a definition for use of the term *high* for that substance has been established under this part, the substance must be present at a level that meets the requirements for use of that term, unless a specific alternative level has been established for the substance in subpart E of this part. If no definition for “high” has been established (e.g., where the claim pertains to a food either as a whole food or as an ingredient in another food), the claim must specify the daily dietary intake necessary to achieve the claimed effect, as established in the regulation authorizing the claim; *Provided That*:

(A) Where the food that bears the claim meets the requirements of paragraphs (d)(2)(vi) or (d)(2)(vii) of this section based on its reference amount customarily consumed, and the labeled serving size differs from that amount, the claim shall be followed by a statement explaining that the claim is based on the reference amount rather than the labeled serving size (e.g., “Diets low in sodium may reduce the risk of high blood pressure, a disease associated with many factors. A serving of __ ounces of this product conforms to such a diet.”).

(B) Where the food that bears the claim is sold in a restaurant or in other establishments in which food that is ready for immediate human consumption is sold, the food can meet the requirements of paragraphs (d)(2)(vi) or (d)(2)(vii) of this section if the firm that sells the food has a reasonable basis on which to believe that the food that bears the claim meets the require-

ments of paragraphs (d)(2)(vi) or (d)(2)(vii) of this section and provides that basis upon request.

(3) Nutrition labeling shall be provided in the label or labeling of any food for which a health claim is made in accordance with §101.9; for restaurant foods, in accordance with §101.10; or for dietary supplements, in accordance with §101.36.

(e) *Prohibited health claims.* No expressed or implied health claim may be made on the label or in labeling for a food, regardless of whether the food is in conventional food form or dietary supplement form, unless:

(1) The claim is specifically provided for in subpart E of this part; and

(2) The claim conforms to all general provisions of this section as well as to all specific provisions in the appropriate section of subpart E of this part;

(3) None of the disqualifying levels identified in paragraph (a)(4) of this section is exceeded in the food, unless specific alternative levels have been established for the substance in subpart E of this part; or unless FDA has permitted a claim despite the fact that a disqualifying level of a nutrient is present in the food based on a finding that such a claim will assist consumers in maintaining healthy dietary practices, and, in accordance with the regulation in subpart E of this part that makes such a finding, the label bears a disclosure statement that complies with §101.13(h), highlighting the nutrient that exceeds the disqualifying level;

(4) Except as provided in paragraph (e)(3) of this section, no substance is present at an inappropriate level as determined in the specific provision authorizing the claim in subpart E of this part;

(5) The label does not represent or purport that the food is for infants and toddlers less than 2 years of age except if the claim is specifically provided for in subpart E of this part; and

(6) Except for dietary supplements or where provided for in other regulations in part 101, subpart E, the food contains 10 percent or more of the Reference Daily Intake or the Daily Reference Value for vitamin A, vitamin C,

Food and Drug Administration, HHS

§ 101.15

iron, calcium, protein, or fiber per reference amount customarily consumed prior to any nutrient addition.

(f) The requirements of this section do not apply to:

(1) Infant formulas subject to section 412(h) of the Federal Food, Drug, and Cosmetic Act, and

(2) Medical foods defined by section 5(b) of the Orphan Drug Act.

(g) *Applicability.* The requirements of this section apply to foods intended for human consumption that are offered for sale, regardless of whether the foods are in conventional food form or dietary supplement form.

[58 FR 2533, Jan. 6, 1993; 58 FR 17097, Apr. 1, 1993, as amended at 58 FR 44038, Aug. 18, 1993; 59 FR 425, Jan. 4, 1994; 59 FR 15050, Mar. 31, 1994; 61 FR 40332, Aug. 2, 1996; 62 FR 49867, Sept. 23, 1997; 63 FR 26980, May 15, 1998; 66 FR 17358, Mar. 30, 2001]

§ 101.15 Food; prominence of required statements.

(a) A word, statement, or other information required by or under authority of the act to appear on the label may lack that prominence and conspicuousness required by section 403(f) of the act by reason (among other reasons) of:

(1) The failure of such word, statement, or information to appear on the part or panel of the label which is presented or displayed under customary conditions of purchase;

(2) The failure of such word, statement, or information to appear on two or more parts or panels of the label, each of which has sufficient space therefor, and each of which is so designed as to render it likely to be, under customary conditions of purchase, the part or panel displayed;

(3) The failure of the label to extend over the area of the container or package available for such extension, so as to provide sufficient label space for the prominent placing of such word, statement, or information;

(4) Insufficiency of label space (for the prominent placing of such word, statement, or information) resulting from the use of label space for any word, statement, design, or device which is not required by or under authority of the act to appear on the label;

(5) Insufficiency of label space (for the prominent placing of such word, statement, or information) resulting from the use of label space to give materially greater conspicuousness to any other word, statement, or information, or to any design or device; or

(6) Smallness or style of type in which such word, statement, or information appears, insufficient background contrast, obscuring designs or vignettes, or crowding with other written, printed, or graphic matter.

(b) No exemption depending on insufficiency of label space, as prescribed in regulations promulgated under section 403 (e) or (i) of the act, shall apply if such insufficiency is caused by:

(1) The use of label space for any word, statement, design, or device which is not required by or under authority of the act to appear on the label;

(2) The use of label space to give greater conspicuousness to any word, statement, or other information than is required by section 403(f) of the act; or

(3) The use of label space for any representation in a foreign language.

(c)(1) All words, statements, and other information required by or under authority of the act to appear on the label or labeling shall appear thereon in the English language: *Provided, however,* That in the case of articles distributed solely in the Commonwealth of Puerto Rico or in a Territory where the predominant language is one other than English, the predominant language may be substituted for English.

(2) If the label contains any representation in a foreign language, all words, statements, and other information required by or under authority of the act to appear on the label shall appear thereon in the foreign language: *Provided, however,* That individual serving-size packages of foods containing no more than 1½ avoirdupois ounces or no more than 1½ fluid ounces served with meals in restaurants, institutions, and passenger carriers and not intended for sale at retail are exempt from the requirements of this paragraph (c)(2), if the only representation in the foreign language(s) is the name of the food.

(3) If any article of labeling (other than a label) contains any representation in a foreign language, all words, statements, and other information required by or under authority of the act to appear on the label or labeling shall appear on such article of labeling.

§ 101.17 Food labeling warning, notice, and safe handling statements.

(a) *Self-pressurized containers.* (1) The label of a food packaged in a self-pressurized container and intended to be expelled from the package under pressure shall bear the following warning:

WARNING—Avoid spraying in eyes. Contents under pressure. Do not puncture or incinerate. Do not store at temperature above 120 °F. Keep out of reach of children.

(2) In the case of products intended for use by children, the phrase “except under adult supervision” may be added at the end of the last sentence in the warning required by paragraph (a)(1) of this section.

(3) In the case of products packaged in glass containers, the word “break” may be substituted for the word “puncture” in the warning required by paragraph (a)(1) of this section.

(4) The words “Avoid spraying in eyes” may be deleted from the warning required by paragraph (a)(1) of this section in the case of a product not expelled as a spray.

(b) *Self-pressurized containers with halocarbon or hydrocarbon propellants.* (1) In addition to the warning required by paragraph (a) of this section, the label of a food packaged in a self-pressurized container in which the propellant consists in whole or in part of a halocarbon or a hydrocarbon shall bear the following warning:

WARNING—Use only as directed. Intentional misuse by deliberately concentrating and inhaling the contents can be harmful or fatal.

(2) The warning required by paragraph (b)(1) of this section is not required for the following products:

(i) Products expelled in the form of a foam or cream, which contain less than 10 percent propellant in the container.

(ii) Products in a container with a physical barrier that prevents escape of the propellant at the time of use.

(iii) Products of a net quantity of contents of less than 2 ounces that are designed to release a measured amount of product with each valve actuation.

(iv) Products of a net quantity of contents of less than one-half ounce.

(c) *Food containing or manufactured with a chlorofluorocarbon or other ozone-depleting substance.* Labeling requirements for foods that contain or are manufactured with a chlorofluorocarbon or other ozone-depleting substance designated by the Environmental Protection Agency (EPA) are set forth in 40 CFR part 82.

(d) *Protein products.* (1) The label and labeling of any food product in liquid, powdered, tablet, capsule, or similar forms that derives more than 50 percent of its total caloric value from either whole protein, protein hydrolysates, amino acid mixtures, or a combination of these, and that is represented for use in reducing weight shall bear the following warning:

WARNING: Very low calorie protein diets (below 400 Calories per day) may cause serious illness or death. Do Not Use for Weight Reduction in Such Diets Without Medical Supervision. Not for use by infants, children, or pregnant or nursing women.

(2) Products described in paragraph (d)(1) of this section are exempt from the labeling requirements of that paragraph if the protein products are represented as part of a nutritionally balanced diet plan providing 400 or more Calories (kilocalories) per day and the label or labeling of the product specifies the diet plan in detail or provides a brief description of that diet plan and adequate information describing where the detailed diet plan may be obtained and the label and labeling bear the following statement:

NOTICE: For weight reduction, use only as directed in the accompanying diet plan (the name and specific location in labeling of the diet plan may be included in this statement in place of “accompanying diet plan”). Do not use in diets supplying less than 400 Calories per day without medical supervision.

(3) The label and labeling of food products represented or intended for dietary (food) supplementation that derive more than 50 percent of their total caloric value from either whole protein, protein hydrolysates, amino acid mixtures, or a combination of these,

that are represented specifically for purposes other than weight reduction; and that are not covered by the requirements of paragraph (d) (1) and (2) of this section; shall bear the following statement:

NOTICE: Use this product as a food supplement only. Do not use for weight reduction.

(4) The provisions of this paragraph are separate from and in addition to any labeling requirements promulgated by the Federal Trade Commission for protein supplements.

(5) Protein products shipped in bulk form for use solely in the manufacture of other foods and not for distribution to consumers in such container are exempt from the labeling requirements of this paragraph.

(6) The warning and notice statements required by paragraphs (d) (1), (2), and (3) of this section shall appear prominently and conspicuously on the principal display panel of the package label and any other labeling.

(e) *Dietary supplements containing iron or iron salts.* (1) The labeling of any dietary supplement in solid oral dosage form (e.g., tablets or capsules) that contains iron or iron salts for use as an iron source shall bear the following statement:

WARNING: Accidental overdose of iron-containing products is a leading cause of fatal poisoning in children under 6. Keep this product out of reach of children. In case of accidental overdose, call a doctor or poison control center immediately.

(2)(i) The warning statement required by paragraph (e)(1) of this section shall appear prominently and conspicuously on the information panel of the immediate container label.

(ii) If a product is packaged in unit-dose packaging, and if the immediate container bears labeling but not a label, the warning statement required by paragraph (e)(1) of this section shall appear prominently and conspicuously on the immediate container labeling in a way that maximizes the likelihood that the warning is intact until all of the dosage units to which it applies are used.

(3) Where the immediate container is not the retail package, the warning statement required by paragraph (e)(1) of this section shall also appear promi-

nently and conspicuously on the information panel of the retail package label.

(4) The warning statement shall appear on any labeling that contains warnings.

(5) The warning statement required by paragraph (e)(1) of this section shall be set off in a box by use of hairlines.

(f) *Foods containing psyllium husk.* (1) Foods containing dry or incompletely hydrated psyllium husk, also known as psyllium seed husk, and bearing a health claim on the association between soluble fiber from psyllium husk and reduced risk of coronary heart disease, shall bear a label statement informing consumers that the appropriate use of such foods requires consumption with adequate amounts of fluids, alerting them of potential consequences of failing to follow usage recommendations, and informing persons with swallowing difficulties to avoid consumption of the product (e.g., "NOTICE: This food should be eaten with at least a full glass of liquid. Eating this product without enough liquid may cause choking. Do not eat this product if you have difficulty in swallowing."). However, a product in conventional food form may be exempt from this requirement if a viscous adhesive mass is not formed when the food is exposed to fluids.

(2) The statement shall appear prominently and conspicuously on the information panel or principal display panel of the package label and any other labeling to render it likely to be read and understood by the ordinary individual under customary conditions of purchase and use. The statement shall be preceded by the word "NOTICE" in capital letters.

(g) *Juices that have not been specifically processed to prevent, reduce, or eliminate the presence of pathogens.* (1) For purposes of this paragraph (g), "juice" means the aqueous liquid expressed or extracted from one or more fruits or vegetables, purees of the edible portions of one or more fruits or vegetables, or any concentrate of such liquid or puree.

(2) The label of:

(1) Any juice that has not been processed in the manner described in paragraph (g)(7) of this section; or

(ii) Any beverage containing juice where neither the juice ingredient nor the beverage has been processed in the manner described in paragraph (g)(7) of this section, shall bear the following warning statement:

WARNING: This product has not been pasteurized and, therefore, may contain harmful bacteria that can cause serious illness in children, the elderly, and persons with weakened immune systems.

(3) The warning statement required by this paragraph (g) shall not apply to juice that is not for distribution to retail consumers in the form shipped and that is for use solely in the manufacture of other foods or that is to be processed, labeled, or repacked at a site other than originally processed, provided that for juice that has not been processed in the manner described in paragraph (g)(7) of this section, the lack of such processing is disclosed in documents accompanying the juice, in accordance with the practice of the trade.

(4) The warning statement required by paragraph (g)(2) of this section shall appear prominently and conspicuously on the information panel or on the principal display panel of the label of the container.

(5) The word "WARNING" shall be capitalized and shall appear in bold type.

(6) The warning statement required by paragraph (g)(2) of this section, when on a label, shall be set off in a box by use of hairlines.

(7)(i) The requirements in this paragraph (g) shall not apply to a juice that has been processed in a manner that will produce, at a minimum, a reduction in the pertinent microorganism for a period at least as long as the shelf life of the product when stored under normal and moderate abuse conditions, of the following magnitude:

(A) A 5-log (i.e., 100,000-fold) reduction; or

(B) A reduction that is equal to, or greater than, the criterion established for process controls by any final regulation requiring the application of Hazard Analysis and Critical Control Point (HACCP) principles to the processing of juice.

(ii) For the purposes of this paragraph (g), the "pertinent microorga-

nism" is the most resistant microorganism of public health significance that is likely to occur in the juice.

(h) *Shell eggs.* (1) The label of all shell eggs, whether in intrastate or interstate commerce, shall bear the following statement:

SAFE HANDLING INSTRUCTIONS: To prevent illness from bacteria: keep eggs refrigerated, cook eggs until yolks are firm, and cook foods containing eggs thoroughly.

(2) The label statement required by paragraph (h)(1) of this section shall appear prominently and conspicuously, with the words "SAFE HANDLING INSTRUCTIONS" in bold type, on the information panel or principal display panel of the container.

(3) The label statement required by paragraph (h)(1) of this section shall be set off in a box by use of hairlines.

(4) Shell eggs that have been, before distribution to consumers, specifically processed to destroy all viable *Salmonella* shall be exempt from the requirements of paragraph (h) of this section.

(5) The safe handling statement for shell eggs that are not for direct sale to consumers, e.g., those that are to be repacked or labeled at a site other than where originally processed, or are sold for use in food service establishments, may be provided on cartons or in labeling, e.g., invoices or bills of lading in accordance with the practice of the trade.

(6) Under sections 311 and 361 of the Public Health Service Act (PHS Act), any State or locality that is willing and able to assist the agency in the enforcement of paragraphs (h)(1) through (h)(5) of this section, and is authorized to inspect or regulate establishments handling packed shell eggs, may in its own jurisdiction, enforce paragraphs (h)(1) through (h)(5) of this section through inspections under paragraph (h)(8) of this section and through administrative enforcement remedies identified in paragraph (h)(7) of this section until FDA notifies the State or locality in writing that such assistance is no longer needed. When providing such assistance, a State or locality may follow the hearing procedures set out in paragraphs (h)(7)(ii)(C) through (h)(7)(ii)(D) of this section, substituting, where necessary, appropriate

State or local officials for designated FDA officials or may utilize State or local hearing procedures if such procedures satisfy due process.

(7) This paragraph (h) is established under authority of both the Federal Food, Drug, and Cosmetic Act (the act) and the PHS Act. Under the act, the agency can enforce the food misbranding provisions under 21 U.S.C. 331, 332, 333, and 334. However, 42 U.S.C. 264 provides for the issuance of implementing enforcement regulations; therefore, FDA has established the following administrative enforcement procedures for the relabeling, diversion, or destruction of shell eggs and informal hearings under the PHS Act:

(i) Upon finding that any shell eggs are in violation of this section an authorized FDA representative or State or local representative in accordance with paragraph (h)(6) of this section may order such eggs to be relabeled under the supervision of said representative, diverted, under the supervision of said representative for processing in accordance with the Egg Products Inspection Act (EPIA) (21 U.S.C. 1031 *et seq.*), or destroyed by or under the supervision of an officer or employee of the FDA, or, if applicable, of the State or locality, in accordance with the following procedures:

(A) *Order for relabeling, diversion, or destruction under the PHS Act.* Any district office of the FDA or any State or locality acting under paragraph (h)(6) of this section, upon finding shell eggs held in violation of this regulation, may serve upon the person in whose possession such eggs are found a written order that such eggs be relabeled with the required statement in paragraph (h)(1) of this section before further distribution. If the person chooses not to relabel, the district office of the FDA or, if applicable, the appropriate State or local agency may serve upon the person a written order that such eggs be diverted (from direct consumer sale, e.g., to food service) under the supervision of an officer or employee of the issuing entity, for processing in accordance with the EPIA (21 U.S.C. 1031 *et seq.*) or destroyed by or under the supervision of the issuing entity, within 10-working days from the date of receipt of the order.

(B) *Issuance of order.* The order shall include the following information:

(1) A statement that the shell eggs identified in the order are subject to relabeling, diversion for processing in accordance with the EPIA, or destruction;

(2) A detailed description of the facts that justify the issuance of the order;

(3) The location of the eggs;

(4) A statement that these eggs shall not be sold, distributed, or otherwise disposed of or moved except as provided in paragraph (h)(7)(i)(E) of this section;

(5) Identification or description of the eggs;

(6) The order number;

(7) The date of the order;

(8) The text of this entire section;

(9) A statement that the order may be appealed by written appeal or by requesting an informal hearing;

(10) The name and phone number of the person issuing the order; and

(11) The location and telephone number of the responsible office or agency and the name of its director.

(C) *Approval of director.* An order, before issuance, shall be approved by the director of the office or agency issuing the order. If prior written approval is not feasible, prior oral approval shall be obtained and confirmed by written memorandum as soon as possible.

(D) *Labeling or marking of shell eggs under order.* An FDA, State, or local representative issuing an order under paragraph (h)(7)(i)(A) of this section shall label or mark the shell eggs with official tags that include the following information:

(1) A statement that the shell eggs are detained in accordance with regulations issued under section 361(a) of the PHS Act (42 U.S.C. 264(a)).

(2) A statement that the shell eggs shall not be sold, distributed or otherwise disposed of or moved except, after notifying the issuing entity in writing, to:

(i) Relabel, divert them for processing in accordance with the EPIA, or destroy them, or

(ii) Move them to another location for holding pending appeal.

(3) A statement that the violation of the order or the removal or alteration

of the tag is punishable by fine or imprisonment or both (section 368 of the PHS Act, 42 U.S.C. 271).

(4) The order number and the date of the order, and the name of the government representative who issued the order.

(E) *Sale or other disposition of shell eggs under order.* After service of the order, the person in possession of the shell eggs that are the subject of the order shall not sell, distribute, or otherwise dispose of or move any eggs subject to the order unless and until the notice is withdrawn after an appeal except, after notifying FDA's district office or, if applicable, the State or local agency in writing, to:

(1) Relabel, divert, or destroy them as specified in paragraph (h)(7)(i) of this section, or

(2) Move them to another location for holding pending appeal.

(ii) The person on whom the order for relabeling, diversion, or destruction is served may either comply with the order or appeal the order to the FDA Regional Food and Drug Director.

(A) *Appeal of a detention order.* Any appeal shall be submitted in writing to the FDA District Director in whose district the shell eggs are located within 5-working days of the issuance of the order. If the appeal includes a request for an informal hearing, the hearing shall be held within 5-working days after the appeal is filed or, if requested by the appellant, at a later date, which shall not be later than 20-calendar days after the issuance of the order. The order may also be appealed within the same period of 5-working days by any other person having an ownership or proprietary interest in such shell eggs. The appellant of an order shall state the ownership or proprietary interest the appellant has in the shell eggs.

(B) *Summary decision.* A request for a hearing may be denied, in whole or in part and at any time after a request for a hearing has been submitted, if the FDA Regional Food and Drug Director or his or her designee determines that no genuine and substantial issue of fact has been raised by the material submitted in connection with the hearing or from matters officially noticed. If the FDA Regional Food and Drug Director determines that a hearing is not

justified, written notice of the determination will be given to the parties explaining the reason for denial.

(C) *Informal hearing.* Appearance by any appellant at the hearing may be by mail or in person, with or without counsel. The informal hearing shall be conducted by the FDA Regional Food and Drug Director or his designee, and a written summary of the proceedings shall be prepared by the FDA Regional Food and Drug Director.

(1) The FDA Regional Food and Drug Director may direct that the hearing be conducted in any suitable manner permitted by law and this section. The FDA Regional Food and Drug Director has the power to take such actions and make such rulings as are necessary or appropriate to maintain order and to conduct an informal fair, expeditious, and impartial hearing, and to enforce the requirements concerning the conduct of hearings.

(2) Employees of FDA will first give a full and complete statement of the action which is the subject of the hearing, together with the information and reasons supporting it, and may present oral or written information relevant to the hearing. The party requesting the hearing may then present oral or written information relevant to the hearing. All parties may conduct reasonable examination of any person (except for the presiding officer and counsel for the parties) who makes any statement on the matter at the hearing.

(3) The hearing shall be informal in nature, and the rules of evidence do not apply. No motions or objections relating to the admissibility of information and views will be made or considered, but any party may comment upon or rebut any information and views presented by another party.

(4) The party requesting the hearing may have the hearing transcribed, at the party's expense, in which case a copy of the transcript is to be furnished to FDA. Any transcript of the hearing will be included with the FDA Regional Food and Drug Director's report of the hearing.

(5) The FDA Regional Food and Drug Director shall prepare a written report of the hearing. All written material presented at the hearing will be attached to the report. Whenever time

permits, the FDA Regional Food and Drug Director may give the parties the opportunity to review and comment on the report of the hearing.

(6) The FDA Regional Food and Drug Director shall include as part of the report of the hearing a finding on the credibility of witnesses (other than expert witnesses) whenever credibility is a material issue, and shall include a recommended decision, with a statement of reasons.

(D) *Written appeal.* If the appellant appeals the detention order but does not request a hearing, the FDA Regional Food and Drug Director shall render a decision on the appeal affirming or revoking the detention within 5-working days after the receipt of the appeal.

(E) *Regional Food and Drug Director decision.* If, based on the evidence presented at the hearing or by the appellant in a written appeal, the FDA Regional Food and Drug Director finds that the shell eggs were held in violation of this section, he shall affirm the order that they be relabeled, diverted under the supervision of an officer or employee of the FDA for processing under the EPIA, or destroyed by or under the supervision of an officer or employee of the FDA; otherwise, the FDA Regional Food and Drug Director shall issue a written notice that the prior order is withdrawn. If the FDA Regional Food and Drug Director affirms the order he shall order that the relabeling, diversion, or destruction be accomplished within 10-working days from the date of the issuance of his decision. The FDA Regional Food and Drug Director's decision shall be accompanied by a statement of the reasons for the decision. The decision of the FDA Regional Food and Drug Director shall constitute final agency action, reviewable in the courts.

(F) *No appeal.* If there is no appeal of the order and the person in possession of the shell eggs that are subject to the order fails to relabel, divert, or destroy them within 10-working days, or if the demand is affirmed by the FDA Regional Food and Drug Director after an appeal and the person in possession of such eggs fails to relabel, divert, or destroy them within 10-working days, the FDA district office, or, if applicable,

the State or local agency may designate an officer or employee to divert or destroy such eggs. It shall be unlawful to prevent or to attempt to prevent such diversion or destruction of the shell eggs by the designated officer or employee.

(8) Persons engaged in handling or storing packed shell eggs for retail distribution shall permit authorized representatives of FDA to make at any reasonable time such inspection of the establishment in which shell eggs are being held, including inspection and sampling of the labeling of such eggs as may be necessary in the judgment of such representatives to determine compliance with the provisions of this section. Inspections may be made with or without notice and will ordinarily be made during regular business hours.

(9) No State or local governing entity shall establish or continue in effect any law, rule, regulation, or other requirement requiring safe handling instructions on unpasteurized shell eggs that are less stringent than those required in paragraphs (h)(1) through (h)(5) of this section.

[42 FR 14308, Mar. 15, 1977, as amended at 42 FR 22033, Apr. 29, 1977; 49 FR 13690, Apr. 6, 1984; 49 FR 28548, July 13, 1984; 61 FR 20100, May 3, 1996; 62 FR 2249, Jan. 15, 1997; 63 FR 8118, Feb. 18, 1998; 63 FR 37055, July 8, 1998; 63 FR 63982, Nov. 18, 1998; 66 FR 17358, Mar. 30, 2001; 65 FR 76111, Dec. 5, 2000]

§ 101.18 Misbranding of food.

(a) Among representations in the labeling of a food which render such food misbranded is a false or misleading representation with respect to another food or a drug, device, or cosmetic.

(b) The labeling of a food which contains two or more ingredients may be misleading by reason (among other reasons) of the designation of such food in such labeling by a name which includes or suggests the name of one or more but not all such ingredients, even though the names of all such ingredients are stated elsewhere in the labeling.

(c) Among representations in the labeling of a food which render such food misbranded is any representation that expresses or implies a geographical origin of the food or any ingredient of the

§ 101.22

food except when such representation is either:

(1) A truthful representation of geographical origin.

(2) A trademark or trade name provided that as applied to the article in question its use is not deceptively misdescriptive. A trademark or trade name composed in whole or in part of geographical words shall not be considered deceptively misdescriptive if it:

(i) Has been so long and exclusively used by a manufacturer or distributor that it is generally understood by the consumer to mean the product of a particular manufacturer or distributor; or

(ii) Is so arbitrary or fanciful that it is not generally understood by the consumer to suggest geographic origin.

(3) A part of the name required by applicable Federal law or regulation.

(4) A name whose market significance is generally understood by the consumer to connote a particular class, kind, type, or style of food rather than to indicate geographical origin.

Subpart B—Specific Food Labeling Requirements

§ 101.22 Foods; labeling of spices, flavorings, colorings and chemical preservatives.

(a)(1) The term *artificial flavor* or *artificial flavoring* means any substance, the function of which is to impart flavor, which is not derived from a spice, fruit or fruit juice, vegetable or vegetable juice, edible yeast, herb, bark, bud, root, leaf or similar plant material, meat, fish, poultry, eggs, dairy products, or fermentation products thereof. Artificial flavor includes the substances listed in §§ 172.515(b) and 182.60 of this chapter except where these are derived from natural sources.

(2) The term *spice* means any aromatic vegetable substance in the whole, broken, or ground form, except for those substances which have been traditionally regarded as foods, such as onions, garlic and celery; whose significant function in food is seasoning rather than nutritional; that is true to name; and from which no portion of any volatile oil or other flavoring principle has been removed. Spices include the spices listed in § 182.10 and part 184 of this chapter, such as the following:

21 CFR Ch. I (4–1–07 Edition)

Allspice, Anise, Basil, Bay leaves, Caraway seed, Cardamon, Celery seed, Chervil, Cinnamon, Cloves, Coriander, Cumin seed, Dill seed, Fennel seed, Fenugreek, Ginger, Horseradish, Mace, Marjoram, Mustard flour, Nutmeg, Oregano, Paprika, Parsley, Pepper, black; Pepper, white; Pepper, red; Rosemary, Saffron, Sage, Savory, Star anise, Tarragon, Thyme, Turmeric.

Paprika, turmeric, and saffron or other spices which are also colors, shall be declared as “spice and coloring” unless declared by their common or usual name.

(3) The term *natural flavor* or *natural flavoring* means the essential oil, oleoresin, essence or extractive, protein hydrolysate, distillate, or any product of roasting, heating or enzymolysis, which contains the flavoring constituents derived from a spice, fruit or fruit juice, vegetable or vegetable juice, edible yeast, herb, bark, bud, root, leaf or similar plant material, meat, seafood, poultry, eggs, dairy products, or fermentation products thereof, whose significant function in food is flavoring rather than nutritional. Natural flavors include the natural essence or extractives obtained from plants listed in §§ 182.10, 182.20, 182.40, and 182.50 and part 184 of this chapter, and the substances listed in § 172.510 of this chapter.

(4) The term *artificial color* or *artificial coloring* means any “color additive” as defined in § 70.3(f) of this chapter.

(5) The term *chemical preservative* means any chemical that, when added to food, tends to prevent or retard deterioration thereof, but does not include common salt, sugars, vinegars, spices, or oils extracted from spices, substances added to food by direct exposure thereof to wood smoke, or chemicals applied for their insecticidal or herbicidal properties.

(b) A food which is subject to the requirements of section 403(k) of the act shall bear labeling, even though such food is not in package form.

(c) A statement of artificial flavoring, artificial coloring, or chemical preservative shall be placed on the food or on its container or wrapper, or on any two or all three of these, as may be necessary to render such statement likely to be read by the ordinary person under customary conditions of purchase and use of such food. The specific

artificial color used in a food shall be identified on the labeling when so required by regulation in part 74 of this chapter to assure safe conditions of use for the color additive.

(d) A food shall be exempt from compliance with the requirements of section 403(k) of the act if it is not in package form and the units thereof are so small that a statement of artificial flavoring, artificial coloring, or chemical preservative, as the case may be, cannot be placed on such units with such conspicuousness as to render it likely to be read by the ordinary individual under customary conditions of purchase and use.

(e) A food shall be exempt while held for sale from the requirements of section 403(k) of the act (requiring label statement of any artificial flavoring, artificial coloring, or chemical preservatives) if said food, having been received in bulk containers at a retail establishment, is displayed to the purchaser with either (1) the labeling of the bulk container plainly in view or (2) a counter card, sign, or other appropriate device bearing prominently and conspicuously the information required to be stated on the label pursuant to section 403(k).

(f) A fruit or vegetable shall be exempt from compliance with the requirements of section 403(k) of the act with respect to a chemical preservative applied to the fruit or vegetable as a pesticide chemical prior to harvest.

(g) A flavor shall be labeled in the following way when shipped to a food manufacturer or processor (but not a consumer) for use in the manufacture of a fabricated food, unless it is a flavor for which a standard of identity has been promulgated, in which case it shall be labeled as provided in the standard:

(1) If the flavor consists of one ingredient, it shall be declared by its common or usual name.

(2) If the flavor consists of two or more ingredients, the label either may declare each ingredient by its common or usual name or may state "All flavor ingredients contained in this product are approved for use in a regulation of the Food and Drug Administration." Any flavor ingredient not contained in one of these regulations, and any non-

flavor ingredient, shall be separately listed on the label.

(3) In cases where the flavor contains a solely natural flavor(s), the flavor shall be so labeled, e.g., "strawberry flavor", "banana flavor", or "natural strawberry flavor". In cases where the flavor contains both a natural flavor and an artificial flavor, the flavor shall be so labeled, e.g., "natural and artificial strawberry flavor". In cases where the flavor contains a solely artificial flavor(s), the flavor shall be so labeled, e.g., "artificial strawberry flavor".

(h) The label of a food to which flavor is added shall declare the flavor in the statement of ingredients in the following way:

(1) Spice, natural flavor, and artificial flavor may be declared as "spice", "natural flavor", or "artificial flavor", or any combination thereof, as the case may be.

(2) An incidental additive in a food, originating in a spice or flavor used in the manufacture of the food, need not be declared in the statement of ingredients if it meets the requirements of §101.100(a)(3).

(3) Substances obtained by cutting, grinding, drying, pulping, or similar processing of tissues derived from fruit, vegetable, meat, fish, or poultry, e.g., powdered or granulated onions, garlic powder, and celery powder, are commonly understood by consumers to be food rather than flavor and shall be declared by their common or usual name.

(4) Any salt (sodium chloride) used as an ingredient in food shall be declared by its common or usual name "salt."

(5) Any monosodium glutamate used as an ingredient in food shall be declared by its common or usual name "monosodium glutamate."

(6) Any pyroligneous acid or other artificial smoke flavors used as an ingredient in a food may be declared as artificial flavor or artificial smoke flavor. No representation may be made, either directly or implied, that a food flavored with pyroligneous acid or other artificial smoke flavor has been smoked or has a true smoked flavor, or that a seasoning sauce or similar product containing pyroligneous acid or other artificial smoke flavor and used

to season or flavor other foods will result in a smoked product or one having a true smoked flavor.

(7) Because protein hydrolysates function in foods as both flavorings and flavor enhancers, no protein hydrolysate used in food for its effects on flavor may be declared simply as “flavor,” “natural flavor,” or “flavoring.” The ingredient shall be declared by its specific common or usual name as provided in §102.22 of this chapter.

(i) If the label, labeling, or advertising of a food makes any direct or indirect representations with respect to the primary recognizable flavor(s), by word, vignette, e.g., depiction of a fruit, or other means, or if for any other reason the manufacturer or distributor of a food wishes to designate the type of flavor in the food other than through the statement of ingredients, such flavor shall be considered the characterizing flavor and shall be declared in the following way:

(1) If the food contains no artificial flavor which simulates, resembles or reinforces the characterizing flavor, the name of the food on the principal display panel or panels of the label shall be accompanied by the common or usual name of the characterizing flavor, e.g., “vanilla”, in letters not less than one-half the height of the letters used in the name of the food, except that:

(i) If the food is one that is commonly expected to contain a characterizing food ingredient, e.g., strawberries in “strawberry shortcake”, and the food contains natural flavor derived from such ingredient and an amount of characterizing ingredient insufficient to independently characterize the food, or the food contains no such ingredient, the name of the characterizing flavor may be immediately preceded by the word “natural” and shall be immediately followed by the word “flavored” in letters not less than one-half the height of the letters in the name of the characterizing flavor, e.g., “natural strawberry flavored shortcake,” or “strawberry flavored shortcake”.

(ii) If none of the natural flavor used in the food is derived from the product whose flavor is simulated, the food in which the flavor is used shall be labeled either with the flavor of the prod-

uct from which the flavor is derived or as “artificially flavored.”

(iii) If the food contains both a characterizing flavor from the product whose flavor is simulated and other natural flavor which simulates, resembles or reinforces the characterizing flavor, the food shall be labeled in accordance with the introductory text and paragraph (i)(1)(i) of this section and the name of the food shall be immediately followed by the words “with other natural flavor” in letters not less than one-half the height of the letters used in the name of the characterizing flavor.

(2) If the food contains any artificial flavor which simulates, resembles or reinforces the characterizing flavor, the name of the food on the principal display panel or panels of the label shall be accompanied by the common or usual name(s) of the characterizing flavor, in letters not less than one-half the height of the letters used in the name of the food and the name of the characterizing flavor shall be accompanied by the word(s) “artificial” or “artificially flavored”, in letters not less than one-half the height of the letters in the name of the characterizing flavor, e.g., “artificial vanilla”, “artificially flavored strawberry”, or “grape artificially flavored”.

(3) Wherever the name of the characterizing flavor appears on the label (other than in the statement of ingredients) so conspicuously as to be easily seen under customary conditions of purchase, the words prescribed by this paragraph shall immediately and conspicuously precede or follow such name, without any intervening written, printed, or graphic matter, except:

(i) Where the characterizing flavor and a trademark or brand are presented together, other written, printed, or graphic matter that is a part of or is associated with the trademark or brand may intervene if the required words are in such relationship with the trademark or brand as to be clearly related to the characterizing flavor; and

(ii) If the finished product contains more than one flavor subject to the requirements of this paragraph, the statements required by this paragraph need appear only once in each statement of characterizing flavors present

in such food, e.g., “artificially flavored vanilla and strawberry”.

(iii) If the finished product contains three or more distinguishable characterizing flavors, or a blend of flavors with no primary recognizable flavor, the flavor may be declared by an appropriately descriptive generic term in lieu of naming each flavor, e.g., “artificially flavored fruit punch”.

(4) A flavor supplier shall certify, in writing, that any flavor he supplies which is designated as containing no artificial flavor does not, to the best of his knowledge and belief, contain any artificial flavor, and that he has added no artificial flavor to it. The requirement for such certification may be satisfied by a guarantee under section 303(c)(2) of the act which contains such a specific statement. A flavor user shall be required to make such a written certification only where he adds to or combines another flavor with a flavor which has been certified by a flavor supplier as containing no artificial flavor, but otherwise such user may rely upon the supplier’s certification and need make no separate certification. All such certifications shall be retained by the certifying party throughout the period in which the flavor is supplied and for a minimum of three years thereafter, and shall be subject to the following conditions:

(i) The certifying party shall make such certifications available upon request at all reasonable hours to any duly authorized office or employee of the Food and Drug Administration or any other employee acting on behalf of the Secretary of Health and Human Services. Such certifications are regarded by the Food and Drug Administration as reports to the government and as guarantees or other undertakings within the meaning of section 301(h) of the act and subject the certifying party to the penalties for making any false report to the government under 18 U.S.C. 1001 and any false guarantee or undertaking under section 303(a) of the act. The defenses provided under section 303(c)(2) of the act shall be applicable to the certifications provided for in this section.

(ii) Wherever possible, the Food and Drug Administration shall verify the accuracy of a reasonable number of

certifications made pursuant to this section, constituting a representative sample of such certifications, and shall not request all such certifications.

(iii) Where no person authorized to provide such information is reasonably available at the time of inspection, the certifying party shall arrange to have such person and the relevant materials and records ready for verification as soon as practicable: *Provided*, That, whenever the Food and Drug Administration has reason to believe that the supplier or user may utilize this period to alter inventories or records, such additional time shall not be permitted. Where such additional time is provided, the Food and Drug Administration may require the certifying party to certify that relevant inventories have not been materially disturbed and relevant records have not been altered or concealed during such period.

(iv) The certifying party shall provide, to an officer or representative duly designated by the Secretary, such qualitative statement of the composition of the flavor or product covered by the certification as may be reasonably expected to enable the Secretary’s representatives to determine which relevant raw and finished materials and flavor ingredient records are reasonably necessary to verify the certifications. The examination conducted by the Secretary’s representative shall be limited to inspection and review of inventories and ingredient records for those certifications which are to be verified.

(v) Review of flavor ingredient records shall be limited to the qualitative formula and shall not include the quantitative formula. The person verifying the certifications may make only such notes as are necessary to enable him to verify such certification. Only such notes or such flavor ingredient records as are necessary to verify such certification or to show a potential or actual violation may be removed or transmitted from the certifying party’s place of business: *Provided*, That, where such removal or transmittal is necessary for such purposes the relevant records and notes shall be retained as separate documents in Food and Drug Administration files, shall not be copied in other

reports, and shall not be disclosed publicly other than in a judicial proceeding brought pursuant to the act or 18 U.S.C. 1001.

(j) A food to which a chemical preservative(s) is added shall, except when exempt pursuant to §101.100 bear a label declaration stating both the common or usual name of the ingredient(s) and a separate description of its function, e.g., “preservative”, “to retard spoilage”, “a mold inhibitor”, “to help protect flavor” or “to promote color retention”.

(k) The label of a food to which any coloring has been added shall declare the coloring in the statement of ingredients in the manner specified in paragraphs (k)(1) and (k)(2) of this section, except that colorings added to butter, cheese, and ice cream, if declared, may be declared in the manner specified in paragraph (k)(3) of this section, and colorings added to foods subject to §§105.62 and 105.65 of this chapter shall be declared in accordance with the requirements of those sections.

(1) A color additive or the lake of a color additive subject to certification under 721(c) of the act shall be declared by the name of the color additive listed in the applicable regulation in part 74 or part 82 of this chapter, except that it is not necessary to include the “FD&C” prefix or the term “No.” in the declaration, but the term “Lake” shall be included in the declaration of the lake of the certified color additive (e.g., Blue 1 Lake). Manufacturers may parenthetically declare an appropriate alternative name of the certified color additive following its common or usual name as specified in part 74 or part 82 of this chapter.

(2) Color additives not subject to certification may be declared as “Artificial Color,” “Artificial Color Added,” or “Color Added” (or by an equally informative term that makes clear that a color additive has been used in the food). Alternatively, such color additives may be declared as “Colored with _____” or “_____ color”, the blank to be filled with the name of the color additive listed in the applicable regulation in part 73 of this chapter.

(3) When a coloring has been added to butter, cheese, or ice cream, it need not be declared in the ingredient list

unless such declaration is required by a regulation in part 73 or part 74 of this chapter to ensure safe conditions of use for the color additive. Voluntary declaration of all colorings added to butter, cheese, and ice cream, however, is recommended.

[42 FR 14308, Mar. 15, 1977, as amended at 44 FR 3963, Jan. 19, 1979; 44 FR 37220, June 26, 1979; 54 FR 24891, June 12, 1989; 58 FR 2875, Jan. 6, 1993; 63 FR 14818, Mar. 27, 1998]

§ 101.30 Percentage juice declaration for foods purporting to be beverages that contain fruit or vegetable juice.

(a) This section applies to any food that purports to be a beverage that contains any fruit or vegetable juice (i.e., the product’s advertising, label, or labeling bears the name of, or variation on the name of, or makes any other direct or indirect representation with respect to, any fruit or vegetable juice), or the label or labeling bears any vignette (i.e., depiction of a fruit or vegetable) or other pictorial representation of any fruit or vegetable, or the product contains color and flavor that gives the beverage the appearance and taste of containing a fruit or vegetable juice. The beverage may be carbonated or noncarbonated, concentrated, full-strength, diluted, or contain no juice. For example, a soft drink (soda) that does not represent or suggest by its physical characteristics, name, labeling, ingredient statement, or advertising that it contains fruit or vegetable juice does not purport to contain juice and therefore does not require a percent juice declaration.

(b)(1) If the beverage contains fruit or vegetable juice, the percentage shall be declared by the words “Contains ___ percent (or %) _____ juice” or “___ percent (or %) juice,” or a similar phrase, with the first blank filled in with the percentage expressed as a whole number not greater than the actual percentage of the juice and the second blank (if used) filled in with the name of the particular fruit or vegetable (e.g., “Contains 50 percent apple juice” or “50 percent juice”).

(2) If the beverage contains less than 1 percent juice, the total percentage juice shall be declared as “less than 1 percent juice” or “less than 1 percent

_____ juice” with the blank filled in with the name of the particular fruit or vegetable.

(3) If the beverage contains 100 percent juice and also contains non-juice ingredients that do not result in a diminution of the juice soluble solids or, in the case of expressed juice, in a change in the volume, when the 100 percent juice declaration appears on a panel of the label that does not also bear the ingredient statement, it must be accompanied by the phrase “with added _____,” the blank filled in with a term such as “ingredient(s),” “preservative,” or “sweetener,” as appropriate (e.g., “100% juice with added sweetener”), except that when the presence of the non-juice ingredient(s) is declared as a part of the statement of identity of the product, this phrase need not accompany the 100 percent juice declaration.

(c) If a beverage contains minor amounts of juice for flavoring and is labeled with a flavor description using terms such as “flavor”, “flavored”, or “flavoring” with a fruit or vegetable name and does not bear:

(1) The term “juice” on the label other than in the ingredient statement; or

(2) An explicit vignette depicting the fruit or vegetable from which the flavor derives, such as juice exuding from a fruit or vegetable; or

(3) Specific physical resemblance to a juice or distinctive juice characteristic such as pulp then total percentage juice declaration is not required.

(d) If the beverage does not meet the criteria for exemption from total juice percentage declaration as described in paragraph (c) of this section and contains no fruit or vegetable juice, but the labeling or color and flavor of the beverage represents, suggests, or implies that fruit or vegetable juice may be present (e.g., the product advertising or labeling bears the name, a variation of the name, or a pictorial representation of any fruit or vegetable, or the product contains color and flavor that give the beverage the appearance and taste of containing a fruit or vegetable juice), then the label shall declare “contains zero (0) percent (or %) juice”. Alternatively, the label may declare “Containing (or contains)

no _____ juice”, or “no _____ juice”, or “does not contain _____ juice”, the blank to be filled in with the name of the fruits or vegetables represented, suggested, or implied, but if there is a general suggestion that the product contains fruit or vegetable juice, such as the presence of fruit pulp, the blank shall be filled in with the word “fruit” or “vegetable” as applicable (e.g., “contains no fruit juice”, or “does not contain fruit juice”).

(e) If the beverage is sold in a package with an information panel as defined in §101.2, the declaration of amount of juice shall be prominently placed on the information panel in lines generally parallel to other required information, appearing:

(1) Near the top of the information panel, with no other printed label information appearing above the statement except the brand name, product name, logo, or universal product code; and

(2) In easily legible boldface print or type in distinct contrast to other printed or graphic matter, in a height not less than the largest type found on the information panel except that used for the brand name, product name, logo, universal product code, or the title phrase “Nutrition Facts” appearing in the nutrition information as required by §101.9.

(f) The percentage juice declaration may also be placed on the principal display panel, provided that the declaration is consistent with that presented on the information panel.

(g) If the beverage is sold in a package that does not bear an information panel as defined in §101.2, the percentage juice declaration shall be placed on the principal display panel, in type size not less than that required for the declaration of net quantity of contents statement in §101.105(i), and be placed near the name of the food.

(h)(1) In enforcing these regulations, the Food and Drug Administration will calculate the labeled percentage of juice from concentrate found in a juice or juice beverage using the minimum Brix levels listed below where single-strength (100 percent) juice has at least the specified minimum Brix listed below:

§ 101.36

21 CFR Ch. I (4-1-07 Edition)

Juice	100 percent juice ¹
Acerola	6.0
Apple	11.5
Apricot	11.7
Banana	22.0
Blackberry	10.0
Blueberry	10.0
Boysenberry	10.0
Cantaloupe Melon	9.6
Carambola	7.8
Carrot	8.0
Casaba Melon	7.5
Cashew (Caju)	12.0
Celery	3.1
Cherry, dark, sweet	20.0
Cherry, red, sour	14.0
Crabapple	15.4
Cranberry	7.5
Currant (Black)	11.0
Currant (Red)	10.5
Date	18.5
Dewberry	10.0
Elderberry	11.0
Fig	18.2
Gooseberry	8.3
Grape	16.0
Grapefruit	³ 10.0
Guanabana (soursop)	16.0
Guava	7.7
Honeydew melon	9.6
Kiwi	15.4
Lemon	² 4.5
Lime	² 4.5
Loganberry	10.5
Mango	13.0
Nectarine	11.8
Orange	³ 11.8
Papaya	11.5
Passion Fruit	14.0
Peach	10.5
Pear	12.0
Pineapple	12.8
Plum	14.3
Pomegranate	16.0
Prune	18.5
Quince	13.3
Raspberry (Black)	11.1
Raspberry (Red)	9.2
Rhubarb	5.7
Strawberry	8.0
Tangerine	³ 11.8
Tomato	5.0
Watermelon	7.8
Youngberry	10.0

¹ Indicates Brix value unless other value specified.
² Indicates anhydrous citrus acid percent by weight.
³ Brix values determined by refractometer for citrus juices may be corrected for citric acid.

(2) If there is no Brix level specified in paragraph (h)(1) of this section, the labeled percentage of that juice from concentrate in a juice or juice beverage will be calculated on the basis of the soluble solids content of the single-strength (unconcentrated) juice used to produce such concentrated juice.

(i) Juices directly expressed from a fruit or vegetable (i.e., not concentrated and reconstituted) shall be

considered to be 100 percent juice and shall be declared as “100 percent juice.”

(j) Calculations of the percentage of juice in a juice blend or a diluted juice product made directly from expressed juice (i.e., not from concentrate) shall be based on the percentage of the expressed juice in the product computed on a volume/volume basis.

(k) If the product is a beverage that contains a juice whose color, taste, or other organoleptic properties have been modified to the extent that the original juice is no longer recognizable at the time processing is complete, or if its nutrient profile has been diminished to a level below the normal nutrient range for the juice, then that juice to which such a major modification has been made shall not be included in the total percentage juice declaration.

(l) A beverage required to bear a percentage juice declaration on its label, that contains less than 100 percent juice, shall not bear any other percentage declaration that describes the juice content of the beverage in its label or in its labeling (e.g., “100 percent natural” or “100 percent pure”). However, the label or labeling may bear percentage statements clearly unrelated to juice content (e.g., “provides 100 percent of U.S. RDA of vitamin C”).

(m) Products purporting to be beverages that contain fruit or vegetable juices are exempted from the provisions of this section until May 8, 1994. All products that are labeled on or after that date shall comply with this section.

[58 FR 2925, Jan. 6, 1993, as amended at 58 FR 44063, Aug. 18, 1993; 58 FR 49192, Sept. 22, 1993]

Subpart C—Specific Nutrition Labeling Requirements and Guidelines

SOURCE: 55 FR 60890, Nov. 27, 1991, unless otherwise noted.

§ 101.36 Nutrition labeling of dietary supplements.

(a) The label of a dietary supplement that is offered for sale shall bear nutrition labeling in accordance with this regulation unless an exemption is provided for the product in paragraph (h) of this section.

(b) The declaration of nutrition information on the label and in labeling shall contain the following information, using the subheadings and the format specified in paragraph (e) of this section.

(1) *Serving size.* (i) The subheading “Serving Size” shall be placed under the heading “Supplement Facts” and aligned on the left side of the nutrition label. The serving size shall be determined in accordance with §§101.9(b) and 101.12(b), Table 2. Serving size for dietary supplements shall be expressed using a term that is appropriate for the form of the supplement, such as “tablets,” “capsules,” “packets,” or “teaspoonfuls.”

(ii) The subheading “Servings Per Container” shall be placed under the subheading “Serving Size” and aligned on the left side of the nutrition label, except that this information need not be provided when it is stated in the net quantity of contents declaration.

(2) *Information on dietary ingredients that have a Reference Daily Intake (RDI) or a Daily Reference Value (DRV) as established in §101.9(c) and their subcomponents (hereinafter referred to as “(b)(2)-dietary ingredients”).* (i) The (b)(2)-dietary ingredients to be declared, that is, total calories, calories from fat, total fat, saturated fat, *trans* fat, cholesterol, sodium, total carbohydrate, dietary fiber, sugars, protein, vitamin A, vitamin C, calcium and iron, shall be declared when they are present in a dietary supplement in quantitative amounts by weight that exceed the amount that can be declared as zero in nutrition labeling of foods in accordance with §101.9(c). Calories from saturated fat and polyunsaturated fat, monounsaturated fat, soluble fiber, insoluble fiber, sugar alcohol, and other carbohydrate may be declared, but they shall be declared when a claim is made about them. Any other vitamins or minerals listed in §101.9(c)(8)(iv) or (c)(9) may be declared, but they shall be declared when they are added to the product for purposes of supplementation, or when a claim is made about them. Any (b)(2)-dietary ingredients that are not present, or that are present in amounts that can be declared as zero in §101.9(c), shall not be declared (e.g., amounts corresponding

to less than 2 percent of the RDI for vitamins and minerals). Protein shall not be declared on labels of products that, other than ingredients added solely for technological reasons, contain only individual amino acids.

(A) The names and the quantitative amounts by weight of each (b)(2)-dietary ingredient shall be presented under the heading “Amount Per Serving.” When the quantitative amounts by weight are presented in a separate column, the heading may be centered over a column of quantitative amounts, described by paragraph (b)(2)(ii) of this section, if space permits. A heading consistent with the declaration of the serving size, such as “Each Tablet Contains,” or “Amount Per 2 Tablets” may be used in place of the heading “Amount Per Serving.” Other appropriate terms, such as capsule, packet, or teaspoonful, also may be used in place of the term “Serving.”

(B) The names of dietary ingredients that are declared under paragraph (b)(2)(i) of this section shall be presented in a column aligned on the left side of the nutrition label in the order and manner of indentation specified in §101.9(c), except that calcium and iron shall follow pantothenic acid, and sodium and potassium shall follow chloride. This results in the following order for vitamins and minerals: Vitamin A, vitamin C, vitamin D, vitamin E, vitamin K, thiamin, riboflavin, niacin, vitamin B₆, folate, vitamin B₁₂, biotin, pantothenic acid, calcium, iron, phosphorus, iodine, magnesium, zinc, selenium, copper, manganese, chromium, molybdenum, chloride, sodium, and potassium. The (b)(2)-dietary ingredients shall be listed according to the nomenclature specified in §101.9 or in paragraph (b)(2)(i)(B)(2) of this section.

(1) When “Calories” are declared, they shall be listed first in the column of names, beneath a light bar separating the heading “Amount Per Serving” from the list of names. When “Calories from fat” or “Calories from saturated fat” are declared, they shall be indented beneath “Calories.”

(2) The following synonyms may be added in parentheses immediately following the name of these (b)(2)-dietary ingredients: Vitamin C (ascorbic acid),

thiamin (vitamin B₁), riboflavin (vitamin B₂), folate (folacin or folic acid), and calories (energy). Alternatively, the term “folic acid” or “folacin” may be listed without parentheses in place of “folate.” Energy content per serving may be expressed in kilojoule units, added in parentheses immediately following the statement of caloric content.

(3) Beta-carotene may be declared as the percent of vitamin A that is present as beta-carotene, except that the declaration is required when a claim is made about beta-carotene. When declared, the percent shall be declared to the nearest whole percent, immediately adjacent to or beneath the name vitamin A (e.g., “Vitamin A (90% as beta-carotene)”). The amount of beta-carotene in terms of international units (IU) may be included in parentheses following the percent statement (e.g., “Vitamin A (90% (4500 IU) as beta-carotene)”).

(ii) The number of calories, if declared, and the quantitative amount by weight per serving of each dietary ingredient required to be listed under paragraph (b)(2)(i) of this section shall be presented either in a separate column aligned to the right of the column of names or immediately following the listing of names within the same column. The quantitative amounts by weight shall represent the weight of the dietary ingredient rather than the weight of the source of the dietary ingredient (e.g., the weight of calcium rather than that of calcium carbonate).

(A) These amounts shall be expressed in the increments specified in §101.9(c)(1) through (c)(7), which includes increments for sodium and potassium.

(B) The amounts of vitamins and minerals, excluding sodium and potassium, shall be the amount of the vitamin or mineral included in one serving of the product, using the units of measurement and the levels of significance given in §101.9(c)(8)(iv), except that zeros following decimal points may be dropped, and additional levels of significance may be used when the number of decimal places indicated is not sufficient to express lower amounts (e.g., the RDI for zinc is given in whole milligrams (mg), but the quantitative

amount may be declared in tenths of a mg).

(iii) The percent of the Daily Value of all dietary ingredients declared under paragraph (b)(2)(i) of this section shall be listed, except that the percent for protein may be omitted as provided in §101.9(c)(7); no percent shall be given for subcomponents for which DRV’s have not been established (e.g., sugars); and, for labels of dietary supplements of vitamins and minerals that are represented or purported to be for use by infants, children less than 4 years of age, or pregnant or lactating women, no percent shall be given for total fat, saturated fat, cholesterol, total carbohydrate, dietary fiber, vitamin K, selenium, manganese, chromium, molybdenum, chloride, sodium, or potassium.

(A) When information on the percent of Daily Values is listed, this information shall be presented in one column aligned under the heading of “% Daily Value” and to the right of the column of amounts. The headings “% Daily Value (DV),” “% DV,” “Percent Daily Value,” or “Percent DV” may be substituted for “% Daily Value.” The heading “% Daily Value” shall be placed on the same line as the heading “Amount Per Serving.” When the acronym “DV” is unexplained in the heading and a footnote is required under (b)(2)(iii)(D), (b)(2)(iii)(F), or (b)(3)(iv) of this section, the footnote shall explain the acronym (e.g. “Daily Value (DV) not established”).

(B) The percent of Daily Value shall be calculated by dividing the quantitative amount by weight of each (b)(2)-dietary ingredient by the RDI as established in §101.9(c)(8)(iv) or the DRV as established in §101.9(c)(9) for the specified dietary ingredient and multiplying by 100, except that the percent of Daily Value for protein, when present, shall be calculated as specified in §101.9(c)(7)(ii). The quantitative amount by weight of each dietary ingredient in this calculation shall be the unrounded amount, except that for total fat, saturated fat, cholesterol, sodium, potassium, total carbohydrate, and dietary fiber, the quantitative amount by weight declared on the label (i.e. rounded amount) may be used. The numerical value shall be followed by the symbol for percent (i.e., %).

(C) The percentages based on RDI's and on DRV's shall be expressed to the nearest whole percent, except that for dietary ingredients for which DRV's have been established, "Less than 1%" or "<1%" shall be used to declare the "% Daily Value" when the quantitative amount of the dietary ingredient by weight is great enough to require that the dietary ingredient be listed, but the amount is so small that the "% Daily Value" when rounded to the nearest percent is zero (e.g., a product that contains 1 gram of total carbohydrate would list the percent Daily Value as "Less than 1%" or "<1%").

(D) If the percent of Daily Value is declared for total fat, saturated fat, total carbohydrate, dietary fiber, or protein, a symbol shall follow the value listed for those nutrients that refers to the same symbol that is placed at the bottom of the nutrition label, below the bar required under paragraph (e)(6) of this section and inside the box, that is followed by the statement "Percent Daily Values are based on a 2,000 calorie diet."

(E) The percent of Daily Value shall be based on RDI and DRV values for adults and children 4 or more years of age, unless the product is represented or purported to be for use by infants, children less than 4 years of age, pregnant women, or lactating women, in which case the column heading shall clearly state the intended group. If the product is for persons within more than one group, the percent of Daily Value for each group shall be presented in separate columns as shown in paragraph (e)(10)(ii) of this section.

(F) For declared subcomponents that have no DRV's and, on the labels of dietary supplements of vitamins and minerals that are represented or purported to be for use by infants, children less than 4 years of age, or pregnant or lactating women, for total fat, saturated fat, cholesterol, total carbohydrate, dietary fiber, vitamin K, selenium, manganese, chromium, molybdenum, chloride, sodium, or potassium, a symbol (e.g., an asterisk) shall be placed in the "Percent Daily Value" column that shall refer to the same symbol that is placed at the bottom of the nutrition label, below the last heavy bar and inside the box, and fol-

lowed by the statement "Daily Value not established."

(G) When calories, calories from fat, or calories from saturated fat are declared, the space under the "% Daily Value" column shall be left blank for these items. When there are no other (b)(2)-dietary ingredients listed for which a value must be declared in the "% Daily Value" column, the column may be omitted as shown in paragraph (e)(10)(vii) of this section. When the "% Daily Value" column is not required, but the dietary ingredients listed are subject to paragraph (b)(2)(iii)(F) of this section, the symbol required in that paragraph shall immediately follow the quantitative amount by weight for each dietary ingredient listed under "Amount Per Serving."

(3) *Information on dietary ingredients for which RDI's and DRV's have not been established.* (i) Dietary ingredients for which FDA has not established RDI's or DRV's and that are not subject to regulation under paragraph (b)(2) of this section (hereinafter referred to as "other dietary ingredients") shall be declared by their common or usual name when they are present in a dietary supplement, in a column that is under the column of names described in paragraph (b)(2)(i)(B) of this section or, as long as the constituents of an other dietary ingredient are not listed, in a linear display, under the heavy bar described in paragraph (e)(6) of this section, except that if no (b)(2)-dietary ingredients are declared, other dietary ingredients shall be declared directly beneath the heading "Amount Per Serving" described in paragraph (b)(2)(i)(A) of this section.

(ii) The quantitative amount by weight per serving of other dietary ingredients shall be presented in the same manner as the corresponding information required in paragraph (b)(2)(ii) of this section or, when a linear display is used, shall be presented immediately following the name of the other dietary ingredient. The quantitative amount by weight shall be the weight of the other dietary ingredient listed and not the weight of any component, or the source, of that dietary ingredient.

(A) These amounts shall be expressed using metric measures in appropriate

units (i.e., 1,000 or more units shall be declared in the next higher set of units, e.g., 1,100 mg shall be declared as 1.1 g).

(B) For any dietary ingredient that is a liquid extract from which the solvent has not been removed, the quantity listed shall be the volume or weight of the total extract. Information on the condition of the starting material shall be indicated when it is fresh and may be indicated when it is dried. Information may be included on the concentration of the dietary ingredient and the solvent used, e.g., “fresh dandelion root extract, x (y:z) in 70% ethanol,” where x is the number of milliliters (mL) or mg of the entire extract, y is the weight of the starting material and z is the volume (mL) of solvent. Where the solvent has been partially removed (not to dryness), the final concentration, when indicated, shall be stated (e.g., if the original extract was 1:5 and 50 percent of the solvent was removed, then the final concentration shall be stated as 1:2.5). Where the name of the solvent used is not included in the nutrition label, it is required to be listed in the ingredient statement in accordance with §101.4(g).

(C) For a dietary ingredient that is an extract from which the solvent has been removed, the weight of the ingredient shall be the weight of the dried extract.

(iii) The constituents of a dietary ingredient described in paragraph (b)(3)(i) of this section may be listed indented under the dietary ingredient and followed by their quantitative amounts by weight per serving, except that dietary ingredients described in paragraph (b)(2) of this section shall be listed in accordance with that section. When the constituents of a dietary ingredient described in paragraph (b)(3)(i) of this section are listed, all other dietary ingredients shall be declared in a column; however, the constituents themselves may be declared in a column or in a linear display.

(iv) Other dietary ingredients shall bear a symbol (e.g., an asterisk) in the column under the heading of “% Daily Value” that refers to the same symbol placed at the bottom of the nutrition label and followed by the statement “Daily Value not established,” except that when the heading “% Daily

Value” is not used, the symbol shall follow the quantitative amount by weight for each dietary ingredient listed.

(c) A proprietary blend of dietary ingredients shall be included in the list of dietary ingredients described in paragraph (b)(3)(i) of this section and identified by the term “Proprietary Blend” or other appropriately descriptive term or fanciful name and may be highlighted by bold type. Except as specified in this paragraph, all other requirements for the listing of dietary ingredients in dietary supplements are applicable.

(1) Dietary ingredients contained in the proprietary blend that are listed under paragraph (b)(2) of this section shall be declared in accordance with paragraph (b)(2) of this section.

(2) Dietary ingredients contained in the proprietary blend that are listed under paragraph (b)(3) of this section (i.e., “other dietary ingredients”) shall be declared in descending order of predominance by weight, in a column or linear fashion, and indented under the term “Proprietary Blend” or other appropriately descriptive term or fanciful name.

(3) The quantitative amount by weight specified for the proprietary blend shall be the total weight of all other dietary ingredients contained in the proprietary blend and shall be placed on the same line to the right of the term “Proprietary Blend” or other appropriately descriptive term or fanciful name underneath the column of amounts described in paragraph (b)(2)(ii) of this section. A symbol (e.g., asterisk), which refers to the same symbol placed at the bottom of the nutrition label that is followed by the statement “Daily Value not established,” shall be placed under the heading “% Daily Value,” if present, or immediately following the quantitative amount by weight for the proprietary blend.

(4) The sample label shown in paragraph (e)(10)(v) of this section illustrates one method of nutrition labeling a proprietary blend of dietary ingredients.

(d) The source ingredient that supplies a dietary ingredient may be identified within the nutrition label in parentheses immediately following or indented beneath the name of a dietary ingredient and preceded by the words “as” or “from”, e.g., “Calcium (as calcium carbonate),” except that manner of presentation is unnecessary when the name of the dietary ingredient (e.g., Oriental ginseng) or its synonym (e.g., ascorbic acid) is itself the source ingredient. When a source ingredient is identified in parentheses within the nutrition label, or when the name of the dietary ingredient or its synonym is the source ingredient, it shall not be required to be listed again in the ingredient statement that appears outside of the nutrition label. When a source ingredient is not identified within the nutrition label, it shall be listed in an ingredient statement in accordance with §101.4(g), which shall appear outside and immediately below the nutrition label or, if there is insufficient space below the nutrition label, immediately contiguous and to the right of the nutrition label.

(1) Source ingredients shall be identified in accordance with §101.4 (i.e., shall be listed by common or usual name, and the listing of botanicals shall specify the part of the plant from which the ingredient is derived) regardless of whether they are listed in an ingredient statement or in the nutrition label.

(2) When source ingredients are listed within the nutrition label, and two or more are used to provide a single dietary ingredient, all of the sources shall be listed within the parentheses in descending order by weight.

(3) Representations that the source ingredient conforms to an official compendium may be included either in the nutrition label or in the ingredient list (e.g., “Calcium (as calcium carbonate USP)”).

(e) Nutrition information specified in this section shall be presented as follows:

(1) The title, “Supplement Facts,” shall be set in a type size larger than all other print size in the nutrition label and, unless impractical, shall be set full width of the nutrition label. The title and all headings shall be

bolded to distinguish them from other information.

(2) The nutrition information shall be enclosed in a box by using hairlines.

(3) All information within the nutrition label shall utilize:

(i) A single easy-to-read type style,

(ii) All black or one color type, printed on a white or other neutral contrasting background whenever practical,

(iii) Upper- and lowercase letters, except that all uppercase lettering may be utilized for packages that have a total surface area available to bear labeling of less than 12 square inches,

(iv) At least one point leading (i.e., space between lines of text), and

(v) Letters that do not touch.

(4) Except as provided for small and intermediate-sized packages under paragraph (i)(2) of this section, information other than the title, headings, and footnotes shall be in uniform type size no smaller than 8 point. Type size no smaller than 6 point may be used for column headings (e.g., “Amount Per Serving” and “% Daily Value”) and for footnotes (e.g., “Percent Daily Values are based on a 2,000 calorie diet”).

(5) A hairline rule that is centered between the lines of text shall separate each dietary ingredient required in paragraph (b)(2) and (b)(3) of this section from the dietary ingredient above and beneath it, as shown in paragraph (e)(10) of this section.

(6) A heavy bar shall be placed:

(i) Beneath the subheading “Servings Per Container” except that if “Servings Per Container” is not required and, as a result, not declared, the bar shall be placed beneath the subheading “Serving Size,”

(ii) Beneath the last dietary ingredient to be listed under paragraph (b)(2)(i) of this section, if any, and

(iii) Beneath the last other dietary ingredient to be listed under paragraph (b)(3) of this section, if any.

(7) A light bar shall be placed beneath the headings “Amount Per Serving” and “% Daily Value.”

(8) If the product contains two or more separately packaged dietary supplements that differ from each other (e.g., the product has a packet of supplements to be taken in the morning and a different packet to be taken in

the afternoon), the quantitative amounts and percent of Daily Value may be presented as specified in this paragraph in individual nutrition labels or in one aggregate nutrition label as illustrated in paragraph (e)(10)(iii) of this section.

(9)(i) The quantitative amount by weight (or volume, if permitted) and the percent of Daily Value of each dietary ingredient may be presented on a “per unit” basis in addition to the “per serving” basis required by paragraphs (b)(2)(ii) and (b)(2)(iii) of this section for (b)(2)-dietary ingredients and (b)(3)(ii) and (b)(3)(iv) of this section for other dietary ingredients. If “per unit” information is provided, it must be presented in additional columns to the right of the “per serving” information and be clearly identified by appropriate headings.

(ii) Alternatively, if a recommendation is made in other parts of the label that a dietary supplement be consumed more than once per day, the total quantitative amount by weight (or volume, if permitted) and the percent of Daily Value of each dietary ingredient may be presented on a “per day” basis in addition to the “per serving” basis required by paragraphs (b)(2)(ii) and (b)(2)(iii) of this section for (b)(2)-dietary ingredients and (b)(3)(ii) and (b)(3)(iv) of this section for other dietary ingredients. If “per day” information is provided, it must be presented in additional columns to the right of the “per serving” information and be clearly identified by appropriate head-

ings and/or be presented in a parenthetical statement as part of the “Serving Size” declaration. A sample illustration for “per day” information in a column format is provided in paragraph (e)(11)(viii) of this section. As illustrated, the additional “Per Day” column heading is followed parenthetically by the number of servings recommended per day in other parts of the label (e.g., “Per Day (3 Caplets)”). When the parenthetical statement format following the “Serving Size” declaration is used as an alternative to the column format, the statement must provide no more than simple instructions regarding how to calculate the “per day” amount for the number of servings per day recommended in other parts of the label (e.g., “Serving Size: 1 Caplet (Multiply amounts by 3 for total daily amount)”). When the parenthetical statement format following the “Serving Size” declaration is used in addition to the column format, the statement must provide no more than a simple declaration of the number of servings recommended in other parts of the label (e.g., “Serving Size: 1 Caplet (Total daily amount: 3 caplets per day)”).

(10) In the interest of uniformity of presentation, FDA urges that the information be presented using the graphic specifications set forth in appendix B to part 101, as applicable.

(11) The following sample labels are presented for the purpose of illustration:

(i) Multiple vitamins:

Supplement Facts		
Serving Size 1 Tablet		
	Amount Per Serving	% Daily Value
Vitamin A (as retinyl acetate and 50% as beta-carotene)	5000 IU	100%
Vitamin C (as ascorbic acid)	60 mg	100%
Vitamin D (as cholecalciferol)	400 IU	100%
Vitamin E (as dl-alpha tocopheryl acetate)	30 IU	100%
Thiamin (as thiamin mononitrate)	1.5 mg	100%
Riboflavin	1.7 mg	100%
Niacin (as niacinamide)	20 mg	100%
Vitamin B ₆ (as pyridoxine hydrochloride)	2.0 mg	100%
Folate (as folic acid)	400 mcg	100%
Vitamin B ₁₂ (as cyanocobalamin)	6 mcg	100%
Biotin	30 mcg	10%
Pantothenic Acid (as calcium pantothenate)	10 mg	100%

Other ingredients: Gelatin, lactose, magnesium stearate, microcrystalline cellulose, FD&C Yellow No. 6, propylene glycol, propylparaben, and sodium benzoate.

(ii) Multiple vitamins for children and adults:

Supplement Facts			
Serving Size 1 Tablet			
Amount Per Serving		% Daily Value for Children Under 4 Years of Age	% Daily Value for Adults and Children 4 or more Years of Age
Calories	5		
Total Carbohydrate	1 g	†	< 1%*
Sugars	1 g	†	†
Vitamin A (50% as beta-carotene)	2500 IU	100%	50%
Vitamin C	40 mg	100%	67%
Vitamin D	400 IU	100%	100%
Vitamin E	15 IU	150%	50%
Thiamin	1.1 mg	157%	73%
Riboflavin	1.2 mg	150%	71%
Niacin	14 mg	156%	70%
Vitamin B ₆	1.1 mg	157%	55%
Folate	300 mcg	150%	75%
Vitamin B ₁₂	5 mcg	167%	83%

* Percent Daily Values are based on a 2,000 calorie diet.
 † Daily Value not established.

Other ingredients: Sucrose, sodium ascorbate, stearic acid, gelatin, maltodextrins, artificial flavors, dl-alpha tocopheryl acetate, niacinamide, magnesium stearate, Yellow 6, artificial colors, stearic acid, palmitic acid, pyridoxine hydrochloride, thiamin mononitrate, vitamin A acetate, beta-carotene, folic acid, cholecalciferol, and cyanocobalamin.

(iii) Multiple vitamins in packets:

Supplement Facts				
Serving Size 1 Packet				
Servings Per Container 10				
	AM Packet		PM Packet	
Amount Per Serving	% Daily Value		% Daily Value	
Vitamin A	2500 IU	50%	2500 IU	50%
Vitamin C	60 mg	100%	60 mg	100%
Vitamin D	400 IU	100%		
Vitamin E	30 IU	100%		
Thiamin	1.5 mg	100%	1.5 mg	100%
Riboflavin	1.7 mg	100%	1.7 mg	100%
Niacin	20 mg	100%	20 mg	100%
Vitamin B ₆	2.0 mg	100%	2.0 mg	100%
Folic Acid	200 mcg	50%	200 mcg	50%
Vitamin B ₁₂	3 mcg	50%	3 mcg	50%
Biotin			30 mcg	10%
Pantothenic Acid	5 mg	50%	5 mg	50%

Ingredients: Sodium ascorbate, ascorbic acid, calcium pantothenate, niacinamide, dl-alpha tocopheryl acetate, microcrystalline cellulose, artificial flavors, dextrin, starch, mono- and diglycerides, vitamin A acetate, magnesium stearate, gelatin, FD&C Blue #1, FD&C Red #3, artificial colors, thiamin mononitrate, pyridoxine hydrochloride, citric acid, lactose, sorbic acid, tricalcium phosphate, sodium benzoate, sodium caseinate, methylparaben, potassium sorbate, BHA, BHT, ergocalciferol and cyanocobalamin.

- (iv) Dietary supplement containing dietary ingredient with and without RDI's and DRV's:

Supplement Facts		
Serving Size 1 Capsule		
Amount Per Capsule		% Daily Value
Calories	20	
Calories from Fat	20	
Total Fat	2 g	3%*
Saturated Fat	0.5 g	3%*
Polyunsaturated Fat	1 g	†
Monounsaturated Fat	0.5 g	†
Vitamin A	4250 IU	85%
Vitamin D	425 IU	106%
Omega-3 fatty acids	0.5 g	†

* Percent Daily Values are based on a 2,000 calorie diet.
 † Daily Value not established.

Ingredients: Cod liver oil, gelatin, water, and glycerin.

- (v) A proprietary blend of dietary ingredients:

Supplement Facts		
Serving Size 1 tsp (3 g) (makes 8 fl oz prepared)		
Servings Per Container 24		
	Amount Per Teaspoon	% Daily Value
Calories	10	
Total Carbohydrate	2 g	< 1%*
Sugars	2 g	†
Proprietary blend	0.7 g	
German Chamomile (flower)		†
Hyssop (leaves)		†

* Percent Daily Values are based on a 2,000 calorie diet.
 † Daily Value not established.

Other ingredients: Fructose, lactose, starch, and stearic acid.

(vi) Dietary supplement of an herb

Supplement Facts	
Serving Size 1 Capsule	
Amount Per Capsule	
Oriental Ginseng, powdered (root)	250 mcg*
* Daily Value not established.	

Other ingredients: Gelatin, water, and glycerin.

(vii) Dietary supplement of amino acids:

Supplement Facts	
Serving Size 1 Tablet	
Amount Per Tablet	
Calories	15
Isoleucine (as L-isoleucine hydrochloride)	450 mg*
Leucine (as L-leucine hydrochloride)	620 mg*
Lysine (as L-lysine hydrochloride)	500 mg*
Methionine (as L-methionine hydrochloride)	350 mg*
Cystine (as L-cystine hydrochloride)	200 mg*
Phenylalanine (as L-phenylalanine hydrochloride)	220 mg*
Tyrosine (as L-tyrosine hydrochloride)	900 mg*
Threonine (as L-threonine hydrochloride)	300 mg*
Valine (as L-valine hydrochloride)	650 mg*
* Daily Value not established.	

Other ingredients: Cellulose, lactose, and magnesium stearate.

(viii) Dietary supplement illustrating “per serving” and “per day” information:

Supplement Facts				
Serving Size 1 Caplet				
	Per Caplet		Per Day (3 Caplets)	
	Amount	% Daily Value	Amount	% Daily Value
Calcium (as calcium citrate)	500 mg	50%	1500 mg	150%
Vitamin D (as cholecalciferol)	125 IU	31%	375 IU	93%

(12) If space is not adequate to list the required information as shown in the sample labels in paragraph (e)(11) of this section, the list may be split and continued to the right as long as the headings are repeated. The list to

the right must be set off by a line that distinguishes it and sets it apart from the dietary ingredients and percent of Daily Value information given to the left. The following sample label illustrates this display:

Supplement Facts

Serving Size 1 Packet

Amount Per Packet	% Daily Value	Amount Per Packet	% Daily Value
Vitamin A (from cod liver oil)	5,000 IU	Zinc (as zinc oxide)	15 mg
Vitamin C (as ascorbic acid)	250 mg	Selenium (as sodium selenate)	25 mcg
Vitamin D (as ergocalciferol)	400 IU	Copper (as cupric oxide)	1 mg
Vitamin E (as d-alpha tocopherol)	150 IU	Manganese (as manganese sulfate)	5 mg
Thiamin (as thiamin mononitrate)	75 mg	Chromium (as chromium chloride)	50 mcg
Riboflavin	75 mg	Molybdenum (as sodium molybdate)	50 mcg
Niacin (as niacinamide)	75 mg	Potassium (as potassium chloride)	10 mg
Vitamin B ₆ (as pyridoxine hydrochloride)	75 mg	Choline (as choline chloride)	100 mg
Folic Acid	400 mcg	Betaine (as betaine hydrochloride)	25 mg
Vitamin B ₁₂ (as cyanocobalamin)	100 mcg	Glutamic Acid (as L-glutamic acid)	25 mg
Biotin	100 mcg	Inositol (as inositol monophosphate)	75 mg
Pantothenic Acid (as calcium pantothenate)	75 mg	para-Aminobenzoic acid	30 mg
Calcium (from oystershell)	100 mg	Deoxyribonucleic acid	50 mg
Iron (as ferrous fumarate)	10 mg	Boron	500 mcg
Iodine (from kelp)	150 mcg		
Magnesium (as magnesium oxide)	60 mg		

* Daily Value not established

Other ingredients: Cellulose, stearic acid and silica.

(f)(1) Compliance with this section will be determined in accordance with §101.9(g)(1) through (g)(8), except that the sample for analysis shall consist of

a composite of 12 subsamples (consumer packages) or 10 percent of the

number of packages in the same inspection lot, whichever is smaller, randomly selected to be representative of the lot. The criteria on class I and class II nutrients given in §101.9(g)(3) and (g)(4) also are applicable to other dietary ingredients described in paragraph (b)(3)(i) of this section. Reasonable excesses of these other dietary ingredients over labeled amounts are acceptable within current good manufacturing practice.

(2) When it is not technologically feasible, or some other circumstance makes it impracticable, for firms to comply with the requirements of this section, FDA may permit alternative means of compliance or additional exemptions to deal with the situation in accordance with §101.9(g)(9). Firms in need of such special allowances shall make their request in writing to the Office of Nutritional Products, Labeling and Dietary Supplements (HFS-800), Food and Drug Administration, 5100 Paint Branch Pkwy., College Park, MD 20740.

(g) Except as provided in paragraphs (i)(2) and (i)(5) of this section, the location of nutrition information on a label shall be in compliance with §101.2.

(h) Dietary supplements are subject to the exemptions specified as follows in:

(1) Section 101.9(j)(1) for foods that are offered for sale by a person who makes direct sales to consumers (i.e., a retailer) who has annual gross sales or business done in sales to consumers that is not more than \$500,000 or has annual gross sales made or business done in sales of food to consumers of not more than \$50,000, and whose labels, labeling, and advertising do not provide nutrition information or make a nutrient content or health claim;

(2) Section 101.9(j)(18) for foods that are low-volume products (that is, they meet the requirements for units sold in §101.9(j)(18)(i) or (j)(18)(ii)); that, except as provided in §101.9(j)(18)(iv), are the subject of a claim for an exemption that provides the information required under §101.9(j)(18)(iv), that is filed before the beginning of the time period for which the exemption is claimed, and that is filed by a person, whether it is the manufacturer, packer, or distributor, that qualifies to claim the ex-

emption under the requirements for average full-time equivalent employees in §101.9(j)(18)(i) or (j)(18)(ii), and whose labels, labeling, and advertising do not provide nutrition information or make a nutrient content or health claim;

(3) Section 101.9(j)(9) for foods shipped in bulk form that are not for distribution to consumers in such form and that are for use solely in the manufacture of other dietary supplements or that are to be processed, labeled, or repacked at a site other than where originally processed or packed.

(i) Dietary supplements are subject to the special labeling provisions specified in:

(1) Section 101.9(j)(5)(i) for foods, other than infant formula, represented or purported to be specifically for infants and children less than 2 years of age, in that nutrition labels on such foods shall not include calories from fat, calories from saturated fat, saturated fat, polyunsaturated fat, monounsaturated fat, and cholesterol;

(2) Section 101.9(j)(13) for foods in small or intermediate-sized packages, except that:

(i) All information within the nutrition label on small-sized packages, which have a total surface area available to labeling of less than 12 square inches, shall be in type size no smaller than 4.5 point;

(ii) All information within the nutrition label on intermediate-sized packages, which have from 12 to 40 square inches of surface area available to bear labeling, shall be in type size no smaller than 6 point, except that type size no smaller than 4.5 point may be used on packages that have less than 20 square inches available for labeling and more than 8 dietary ingredients to be listed and on packages that have 20 to 40 square inches available for labeling and more than 16 dietary ingredients to be listed.

(iii) When the nutrition information is presented on any panel under §101.9(j)(13)(ii)(D), the ingredient list shall continue to be located immediately below the nutrition label, or, if there is insufficient space below the nutrition label, immediately contiguous and to the right of the nutrition label as specified in §101.4(g).

(iv) When it is not possible for a small or intermediate-sized package that is enclosed in an outer package to comply with these type size requirements, the type size of the nutrition label on the primary (inner) container may be as small as needed to accommodate all of the required label information provided that the primary container is securely enclosed in outer packaging, the nutrition labeling on the outer packaging meets the applicable type size requirements, and such outer packaging is not intended to be separated from the primary container under conditions of retail sale.

(v) Where there is not sufficient space on a small or intermediate-sized package for a nutrition label that meets minimum type size requirements of 4.5 points if hairlines are used in accordance with paragraph (e)(5) of this section, the hairlines may be omitted and replaced by a row of dots connecting the columns containing the name of each dietary ingredient and the quantitative amounts (by weight and as a percent of Daily Value).

(3) Section 101.9(j)(15) for foods in multiunit food containers;

(4) Section 101.9(j)(16) for foods sold in bulk containers; and

(5) Section 101.9(j)(17) for foods in packages that have a total surface area available to bear labeling greater than 40 square inches but whose principal display panel and information panel do not provide sufficient space to accommodate all required label information, except that the ingredient list shall continue to be located immediately below the nutrition label, or, if there is insufficient space below the nutrition label, immediately contiguous and to the right of the nutrition label as specified in §101.4(g).

(j) Dietary supplements shall be subject to the misbranding provisions of §101.9(k).

[62 FR 49849, Sept. 23, 1997, as amended at 63 FR 30620, June 5, 1998; 66 FR 56035, Nov. 6, 2001; 71 FR 51726, Aug. 31, 2006; 71 FR 74791, Dec. 13, 2006]

§ 101.42 Nutrition labeling of raw fruit, vegetables, and fish.

(a) The Food and Drug Administration (FDA) urges food retailers to provide nutrition information, as provided

in §101.9(c), for raw fruit, vegetables, and fish at the point-of-purchase. If retailers choose to provide such information, they should do so in a manner that conforms to the guidelines in §101.45.

(b) In §101.44, FDA has listed the 20 varieties of raw fruit, vegetables, and fish that are most frequently consumed during a year and to which the guidelines apply.

(c) FDA has also defined in §101.43, the circumstances that constitute substantial compliance by food retailers with the guidelines.

(d) By May 8, 1993, FDA will issue a report on actions taken by food retailers to provide consumers with nutrition information for raw fruit, vegetables, and fish under the guidelines established in §101.45.

(1) The report will include a determination of whether there is substantial compliance, as defined in §101.43, with the guidelines.

(2) In evaluating substantial compliance, FDA will consider only the 20 varieties of raw fruit, vegetables, and fish most frequently consumed as identified in §101.44.

(e) If FDA finds that there is substantial compliance with the guidelines for the nutrition labeling of raw fruit and vegetables or of fish, the agency will so state in the report, and the guidelines will remain in effect. FDA will reevaluate the market place for substantial compliance every 2 years.

(f) If FDA determines that there is not substantial compliance with the guidelines for raw fruit and vegetables or for raw fish, the agency will at that time issue proposed regulations requiring that any person who offers raw fruit and vegetables or fish to consumers provide, in a manner prescribed by regulations, the nutrition information required by §101.9. Final regulations would have to be issued 6 months after issuance of proposed regulations, and they would become effective 6 months after the date of their promulgation.

§ 101.43 Substantial compliance of food retailers with the guidelines for the voluntary nutrition labeling of raw fruit, vegetables, and fish.

(a) The Food and Drug Administration (FDA) will judge a food retailer who sells raw agricultural commodities or raw fish to be in compliance with the guidelines in § 101.45 with respect to raw agricultural commodities if the retailer displays or provides nutrition labeling for at least 90 percent of the raw agricultural commodities listed in § 101.44 that it sells, and with respect to raw fish if the retailer displays or provides nutrition labeling for at least 90 percent of the types of raw fish listed in § 101.44 that it sells. To be in compliance, the nutrition labeling shall:

(1) Be presented in the store or other type of establishment in a manner that is consistent with § 101.45(a)(1);

(2) Be presented in content and format that are consistent with § 101.45 (a)(2), (a)(3), and (a)(4); and

(3) Include data that have been provided by FDA in appendices C and D to part 101 of this chapter, except that the information on potassium is voluntary.

(b) To determine whether there is substantial compliance by food retailers with the guidelines in § 101.45 for the voluntary nutrition labeling of raw fruit and vegetables and of raw fish, FDA will select a representative sample of 2,000 stores, allocated by store type and size, for raw fruit and vegetables and for raw fish.

(c) FDA will find that there is substantial compliance with the guidelines in § 101.45 if it finds based on paragraph (a) of this section that at least 60 percent of all stores that are evaluated are in compliance.

(d) FDA will evaluate substantial compliance separately for raw agricultural commodities and for raw fish.

[55 FR 60890, Nov. 27, 1991, as amended at 61 FR 42759, Aug. 16, 1996]

§ 101.44 Identification of the 20 most frequently consumed raw fruit, vegetables, and fish in the United States.

(a) The 20 most frequently consumed raw fruit are: Banana, apple, watermelon, orange, cantaloupe, grape, grapefruit, strawberry, peach, pear, nectarine, honeydew melon, plum, avo-

cado, lemon, pineapple, tangerine, sweet cherry, kiwifruit, and lime.

(b) The 20 most frequently consumed raw vegetables are: Potato, iceberg lettuce, tomato, onion, carrot, celery, sweet corn, broccoli, green cabbage, cucumber, bell pepper, cauliflower, leaf lettuce, sweet potato, mushroom, green onion, green (snap) bean, radish, summer squash, and asparagus.

(c) The 20 most frequently consumed raw fish are: Shrimp, cod, pollock, catfish, scallops, salmon (Atlantic/Coho, chum/pink, sockeye), flounder/sole, oysters, orange roughy, Atlantic/Pacific mackerel, ocean perch, rockfish, whiting, clam, haddock, blue crab, rainbow trout, halibut, lobster, and swordfish.

[55 FR 60890, Nov. 27, 1991, as amended at 61 FR 42760, Aug. 16, 1996]

EFFECTIVE DATE NOTE: At 71 FR 42044, July 25, 2006, § 101.44 was revised, effective Jan. 1, 2008. For the convenience of the user, the revised text is set forth as follows:

§ 101.44 What are the 20 most frequently consumed raw fruits, vegetables, and fish in the United States?

(a) The 20 most frequently consumed raw fruits are: Apple, avocado (California), banana, cantaloupe, grapefruit, grapes, honeydew melon, kiwifruit, lemon, lime, nectarine, orange, peach, pear, pineapple, plums, strawberries, sweet cherries, tangerine, and watermelon.

(b) The 20 most frequently consumed raw vegetables are: Asparagus, bell pepper, broccoli, carrot, cauliflower, celery, cucumber, green (snap) beans, green cabbage, green onion, iceberg lettuce, leaf lettuce, mushrooms, onion, potato, radishes, summer squash, sweet corn, sweet potato, and tomato.

(c) The 20 most frequently consumed raw fish are: Blue crab, catfish, clams, cod, flounder/sole, haddock, halibut, lobster, ocean perch, orange roughy, oysters, pollock, rainbow trout, rockfish, salmon (Atlantic/coho/Chinook/sockeye, chum/pink), scallops, shrimp, swordfish, tilapia, and tuna.

§ 101.45 Guidelines for the voluntary nutrition labeling of raw fruits, vegetables, and fish.

(a) Nutrition labeling for raw fruits, vegetables, and fish listed in § 101.44 should be presented to the public in the following manner:

(1) Nutrition labeling information should be displayed at the point of purchase by an appropriate means such as

by a label affixed to the food or through labeling including shelf labels, signs, posters, brochures, notebooks, or leaflets that are readily available and in close proximity to the foods. The nutrition labeling information may also be supplemented by a video, live demonstration, or other media.

(2) Serving sizes should be determined, and nutrients declared, in accordance with §101.9 (b) and (c), respectively, except that the nutrition labeling data should be based on the raw edible portion for fruits and vegetables and on the cooked edible portion for fish. The methods used to cook fish should be those that do not add fat, breading, or seasoning (e.g., salt or spices).

(3) When nutrition labeling information is provided for more than one raw fruit, vegetable, or fish on signs, posters, brochures, notebooks, or leaflets, it may be presented in charts with horizontal or vertical columns or as a compilation of individual nutrition labels. Nutrition labeling that is presented in a linear display (see §101.9(j)(13)(ii)(A)(2)) will not be considered to be in compliance. The heading “Nutrition Facts” must be in a type size larger than all other print in the nutrition label. The required information (i.e., headings, serving sizes, list of nutrients, quantitative amounts by weight (except for vitamins and minerals), and percent of Daily Values (DV’s) (except for sugars and protein) must be clearly presented and of sufficient type size and color contrast to be plainly legible, with numeric values for percent of DV highlighted in contrast to the quantitative amounts by weight and hairlines between all nutrients.

(i) Declaration of the number of servings per container need not be included in the nutrition labeling of raw fruits, vegetables, and fish.

(ii) Except for the statement “Percent Daily Values are based on a 2,000 calorie diet,” the footnote required in §101.9(d)(9) is not required. However, when labeling is provided in brochures, notebooks, leaflets, or similar types of materials, retailers are encouraged to include the footnote.

(iii) When the nutrition labeling information for more than one raw fruit or vegetable is provided on signs, post-

ers, brochures, notebooks, or leaflets, the listings for saturated fat and cholesterol may be omitted from the charts or individual nutrition labels so long as the fact that most fruits and vegetables provide negligible amounts of these nutrients, but that avocados contain 1 gram (g) of fat per ounce, is stated in a footnote (e.g., “Most fruits and vegetables provide negligible amounts of saturated fat and cholesterol; avocados provide 1 g of saturated fat per ounce”). The footnote may also contain information about the polyunsaturated and monounsaturated fat content of avocados. When the nutrition labeling information for raw fish is provided on a chart, the listings for dietary fiber and sugars may be omitted if the following footnote is used, “Fish provide negligible amounts of dietary fiber and sugars.”

(4) When nutrition labeling is provided for individual raw fruits, vegetables, or fish on packages or on signs, posters, brochures, notebooks, or leaflets, it should be displayed in accordance with §101.9, except that the declaration of the number of servings per container need not be included. For individual labels provided by retailers on signs and posters, the footnote required in §101.9(d)(9) may be shortened to “Percent Daily Values are based on a 2,000 calorie diet.”

(b) Nutrition label values provided by the Food and Drug Administration (FDA) in Appendices C and D to part 101 for the 20 most frequently consumed raw fruits, vegetables, and fish listed in §101.44 shall be used to ensure uniformity in declared values. FDA will publish proposed updates of the 20 most frequently consumed raw fruits, vegetables, and fish and nutrition label data for these foods (or a notice that the data sets have not changed from the previous publication) at least every 4 years in the FEDERAL REGISTER.

(1) The agency encourages the submission of data bases with new or additional nutrient data for any of the most frequently consumed raw fruits, vegetables, and fish to the Office of Nutritional Products, Labeling and Dietary Supplements (HFS-800), Center for Food Safety and Applied Nutrition, Food and Drug Administration, 5100 Paint Branch Pkwy., College Park, MD

20740, for review and evaluation. FDA may incorporate these data in the next revision of the nutrition labeling information for the top 20 raw fruits, vegetables, and fish.

(i) Guidance in the development of data bases may be found in the “FDA Nutrition Labeling Manual: A Guide for Developing and Using Data Bases,” available from the FDA Office of Food Labeling.

(ii) The submission to FDA should include, but need not be limited to, information on the following: Source of the data (names of investigators, name of organization, place of analyses, dates of analyses), number of samples, sampling design, analytical methods, and statistical treatment of the data. Proposed quantitative label declarations may be included. The proposed values for declaration should be determined in accordance with the “FDA Nutrition Labeling Manual: A Guide for Developing and Using Data Bases.”

(2) [Reserved]

(c) Data bases of nutrient values for raw fruits, vegetables, and fish that are not among the 20 most frequently consumed may be used to develop nutrition labeling values for these foods. This includes data bases of nutrient values for specific varieties, species, or cultivars of raw fruits, vegetables, and fish not specifically identified among the 20 most frequently consumed.

(1) The food names and descriptions for the fruits, vegetables, and fish should clearly identify these foods as distinct from foods among the most frequently consumed list for which FDA has provided data.

(2) Guidance in the development of data bases may be found in the “FDA Nutrition Labeling Manual: A Guide for Developing and Using Data Bases.”

(3) Nutrition labeling values computed from data bases are subject to the compliance provisions of §101.9(g).

(i) Compliance with the provisions of §101.9(g) may be achieved by use of a data base that has been developed following FDA guideline procedures and approved by FDA.

(A) The submission to FDA for approval should include but need not be limited to information on the following: Source of the data (names of investigators, name of organization,

place of analyses, dates of analyses), number of samples, sampling design, analytical methods, statistical treatment of the data, and proposed quantitative label declarations. The values for declaration should be determined in accordance with the “FDA Nutrition Labeling Manual: A Guide for Developing and Using Databases.”

(B) FDA approval of a data base and nutrition labeling values shall not be considered granted until the Center for Food Safety and Applied Nutrition has agreed to all aspects of the data base in writing. Approvals will be in effect for a limited time, e.g., 10 years, and will be eligible for renewal in the absence of significant changes in agricultural or industry practices (e.g., a change occurs in a predominant variety produced). FDA will take steps to revoke its approval of the data base and nutrition labeling values if FDA monitoring suggests that the data base or nutrition labeling values are no longer representative of the item sold in this country. Approval requests shall be submitted in accordance with the provision of §101.30 of this chapter.

(ii) [Reserved]

[61 FR 42760, Aug. 16, 1996, as amended at 66 FR 56035, Nov. 6, 2001]

EFFECTIVE DATE NOTE: At 71 FR 42044, July 25, 2006, §101.45 was amended by revising paragraph (a)(3)(iii) and adding paragraph (a)(3)(iv), effective Jan. 1, 2008. For the convenience of the user, the added and revised text is set forth as follows:

§ 101.45 What are the guidelines for the voluntary nutrition labeling of raw fruits, vegetables, and fish?

(a) * * *

(3) * * *

(iii) When retailers provide nutrition labeling information for more than one raw fruit or vegetable on signs or posters or in brochures, notebooks, or leaflets, the listings for saturated fat, *trans* fat, and cholesterol may be omitted from the charts or individual nutrition labels if a footnote states that most fruits and vegetables provide negligible amounts of these nutrients, but that avocados contain 0.5 gram (g) of saturated fat per ounce (e.g., “Most fruits and vegetables provide negligible amounts of saturated fat, *trans* fat, and cholesterol; avocados provide 0.5 g of saturated fat per ounce”). The footnote also may contain information about the polyunsaturated and monounsaturated fat content of avocados.

(iv) When retailers provide nutrition labeling information for more than one raw fish on signs or posters or in brochures, notebooks, or leaflets, the listings for *trans* fat, dietary fiber, and sugars may be omitted from the charts or individual nutrition labels if the following footnote is used, “Fish provide negligible amounts of *trans* fat, dietary fiber, and sugars.”

* * * * *

Subpart D—Specific Requirements for Nutrient Content Claims

SOURCE: 58 FR 2413, Jan. 6, 1993, unless otherwise noted.

§ 101.54 Nutrient content claims for “good source,” “high,” “more,” and “high potency.”

(a) *General requirements.* Except as provided in paragraph (e) of this section, a claim about the level of a nutrient in a food in relation to the Reference Daily Intake (RDI) established for that nutrient in §101.9(c)(8)(iv) or Daily Reference Value (DRV) established for that nutrient in §101.9(c)(9), (excluding total carbohydrates) may only be made on the label or in labeling of the food if:

(1) The claim uses one of the terms defined in this section in accordance with the definition for that term;

(2) The claim is made in accordance with the general requirements for nutrient content claims in §101.13; and

(3) The food for which the claim is made is labeled in accordance with §101.9, §101.10, or §101.36, as applicable.

(b) *“High” claims.* (1) The terms “high,” “rich in,” or “excellent source of” may be used on the label and in the labeling of foods, except meal products as defined in §101.13(1) and main dish products as defined in §101.13(m), provided that the food contains 20 percent or more of the RDI or the DRV per reference amount customarily consumed.

(2) The terms defined in paragraph (b)(1) of this section may be used on the label and in the labeling of meal products as defined in §101.13(1) and main dish products as defined in §101.13(m), provided that:

(i) The product contains a food that meets the definition of “high” in paragraph (b)(1) of this section; and

(ii) The label or labeling clearly identifies the food that is the subject of the claim (e.g., the serving of broccoli in this product is high in vitamin C).

(c) *“Good Source” claims.* (1) The terms “good source,” “contains,” or “provides” may be used on the label and in the labeling of foods, except meal products as defined in §101.13(1) and main dish products as defined in §101.13(m), provided that the food contains 10 to 19 percent of the RDI or the DRV per reference amount customarily consumed.

(2) The terms defined in paragraph (c)(1) of this section may be used on the label and in the labeling of meal products as defined in §101.13(1) and main dish products as defined in 101.13(m), provided that:

(i) The product contains a food that meets the definition of “good source” in paragraph (c)(1) of this section; and

(ii) The label or labeling clearly identifies the food that is the subject of the claim (e.g., the serving of sweet potatoes in this product is a “good source” of fiber).

(d) *“Fiber” claims.* (1) If a nutrient content claim is made with respect to the level of dietary fiber, that is, that the product is high in fiber, a good source of fiber, or that the food contains “more” fiber, and the food is not “low” in total fat as defined in §101.62(b)(2) or, in the case of a meal product, as defined in §101.13(1), or main dish product, as defined in §101.13(m), is not “low” in total fat as defined in §101.62(b)(3), then the label shall disclose the level of total fat per labeled serving.

(2) The disclosure shall appear in immediate proximity to such claim, be in a type size no less than one-half the size of the claim and precede any disclosure statement required under §101.13(h) (e.g., “contains [x amount] of total fat per serving. See nutrition information for fat content”).

(e) *“More” claims.* (1) A relative claim using the terms “more,” “fortified,” “enriched,” “added,” “extra,” and “plus” may be used on the label or in labeling of foods to describe the level of protein, vitamins, minerals, dietary fiber, or potassium, except as limited by §101.13(j)(1)(i) and except meal products as defined in §101.13(1) and main

dish products as defined in §101.13(m), provided that:

(i) The food contains at least 10 percent more of the RDI for vitamins or minerals or of the DRV for protein, dietary fiber, or potassium (expressed as a percent of the Daily Value) per reference amount customarily consumed than an appropriate reference food; and

(ii) Where the claim is based on a nutrient that has been added to the food, that fortification is in accordance with the policy on fortification of foods in §104.20 of this chapter; and

(iii) As required in §101.13(j)(2) for relative claims:

(A) The identity of the reference food and the percentage (or fraction) that the nutrient is greater relative to the RDI or DRV are declared in immediate proximity to the most prominent such claim (e.g., “contains 10 percent more of the Daily Value for fiber than white bread”); and

(B) Quantitative information comparing the level of the nutrient in the product per labeled serving with that of the reference food that it replaces (e.g., “Fiber content of white bread is 1 gram (g) per serving; (this product) 3.5 g per serving”) is declared adjacent to the most prominent claim or to the nutrition label, except that if the nutrition label is on the information panel, the quantitative information may be located elsewhere on the information panel in accordance with §101.2.

(2) A relative claim using the terms “more,” “fortified,” “enriched,” “added,” “extra,” and “plus” may be used on the label or in labeling to describe the level of protein, vitamins, minerals, dietary fiber or potassium, except as limited in §101.13(j)(1)(i), in meal products as defined in §101.13(1) or main dish products as defined in §101.13(m), provided that:

(i) The food contains at least 10 percent more of the RDI for vitamins or minerals or of the DRV for protein, dietary fiber, or potassium (expressed as a percent of the Daily Value) per 100 g of food than an appropriate reference food.

(ii) Where the claim is based on a nutrient that has been added to the food, that fortification is in accordance with the policy on fortification of foods in §104.20 of this chapter; and

(iii) As required in §101.13(j)(2) for relative claims:

(A) The identity of the reference food and the percentage (or fraction) that the nutrient was increased relative to the RDI or DRV are declared in immediate proximity to the most prominent such claim (e.g., “contains 10 percent more of the Daily Value for fiber per 3 oz than does ‘X brand of product’”), and

(B) Quantitative information comparing the level of the nutrient in the product per specified weight with that of the reference food that it replaces (e.g., “The fiber content of ‘X brand of product’ is 2 g per 3 oz. This product contains 4.5 g per 3 oz.”) is declared adjacent to the most prominent claim or to the nutrition label, except that if the nutrition label is on the information panel, the quantitative information may be located elsewhere on the information panel in accordance with §101.2.

(f) “*High potency*” claims. (1)(i) The term “high potency” may be used on the label or in the labeling of foods to describe individual vitamins or minerals that are present at 100 percent or more of the RDI per reference amount customarily consumed.

(ii) When the term “high potency” is used to describe individual vitamins or minerals in a product that contains other nutrients or dietary ingredients, the label or labeling shall clearly identify which vitamin or mineral is described by the term “high potency” (e.g., “Botanical ‘X’ with high potency vitamin E”).

(2) The term “high potency” may be used on the label or in the labeling of a multiingredient food product to describe the product if the product contains 100 percent or more of the RDI for at least two-thirds of the vitamins and minerals that are listed in §101.9(c)(8)(iv) and that are present in the product at 2 percent or more of the RDI (e.g., “High potency multivitamin, multimineral dietary supplement tablets”).

(3) Where compliance with paragraphs (f)(1)(i), (f)(1)(ii), or (f)(2) of this section is based on a nutrient that has been added to a food (other than a dietary supplement), that fortification shall be in accordance with the policy

§ 101.56

on fortification of foods in §104.20 of this chapter.

(g) *Nutrient content claims using the term “antioxidant.”* A nutrient content claim that characterizes the level of antioxidant nutrients present in a food may be used on the label or in the labeling of that food when:

(1) An RDI has been established for each of the nutrients;

(2) The nutrients that are the subject of the claim have recognized antioxidant activity; that is, when there exists scientific evidence that, following absorption from the gastrointestinal tract, the substance participates in physiological, biochemical, or cellular processes that inactivate free radicals or prevent free radical-initiated chemical reactions;

(3) The level of each nutrient that is the subject of the claim is sufficient to qualify for the §101.54 (b), (c), or (e) claim (e.g., to bear the claim “high in antioxidant vitamin C,” the product must contain 20 percent or more of the RDI for vitamin C). Beta-carotene may be a subject of the claim when the level of vitamin A present as beta-carotene in the food that bears the claim is sufficient to qualify for the claim. For example, for the claim “good source of antioxidant beta-carotene,” 10 percent or more of the RDI for vitamin A must be present as beta-carotene per reference amount customarily consumed; and

(4) The names of the nutrients that are the subject of the claim are included as part of the claim (e.g., “high in antioxidant vitamins C and E”). Alternatively, when used as part of a nutrient content claim, the term “antioxidant” or “antioxidants” (as in “high in antioxidants”) may be linked by a symbol (e.g., an asterisk) that refers to the same symbol that appears elsewhere on the same panel of a product label followed by the name or names of the nutrients with recognized antioxidant activity. The list of nutrients shall appear in letters of a type size height no smaller than the larger

21 CFR Ch. I (4–1–07 Edition)

of one-half of the type size of the largest nutrient content claim or 1/16 inch.

[58 FR 2413, Jan. 6, 1993; 58 FR 17342, Apr. 2, 1993, as amended at 59 FR 394, Jan. 4, 1994; 59 FR 15051, Mar. 31, 1994; 60 FR 17206, Apr. 5, 1995; 61 FR 11731, Mar. 22, 1996; 62 FR 31339, June 9, 1997; 62 FR 49867, 49880, Sept. 23, 1997; 63 FR 26980, May 15, 1998; 66 FR 17358, Mar. 30, 2001]

§ 101.56 Nutrient content claims for “light” or “lite.”

(a) *General requirements.* A claim using the term *light* or *lite* to describe a food may only be made on the label or in labeling of the food if:

(1) The claim uses one of the terms defined in this section in accordance with the definition for that term;

(2) The claim is made in accordance with the general requirements for nutrient content claims in §101.13; and

(3) The food is labeled in accordance with §101.9 or §101.10, where applicable.

(b) *“Light” claims.* The terms “light” or “lite” may be used on the label or in the labeling of foods, except meal products as defined in §101.13(1) and main dish products as defined in §101.13(m), without further qualification, provided that:

(1) If the food derives 50 percent or more of its calories from fat, its fat content is reduced by 50 percent or more per reference amount customarily consumed compared to an appropriate reference food as specified in §101.13(j)(1); or

(2) If the food derives less than 50 percent of its calories from fat:

(i) The number of calories is reduced by at least one-third (33 1/3 percent) per reference amount customarily consumed compared to an appropriate reference food; or

(ii) Its fat content is reduced by 50 percent or more per reference amount customarily consumed compared to the reference food that it resembles or for which it substitutes as specified in §101.13(j)(1); and

(3) As required in §101.13(j)(2) for relative claims:

(i) The identity of the reference food and the percent (or fraction) that the calories and the fat were reduced are declared in immediate proximity to the most prominent such claim, (e.g., “1/3 fewer calories and 50 percent less fat than our regular cheese cake”);

(ii) Quantitative information comparing the level of calories and fat content in the product per labeled serving size with that of the reference food that it replaces (e.g., “lite cheesecake—200 calories, 4 grams (g) fat per serving; regular cheesecake—300 calories, 8 g fat per serving”) is declared adjacent to the most prominent claim or to the nutrition label, except that if the nutrition label is on the information panel, the quantitative information may be located elsewhere on the information panel in accordance with §101.2; and

(iii) If the labeled food contains less than 40 calories or less than 3 g fat per reference amount customarily consumed, the percentage reduction for that nutrient need not be declared.

(4) A “light” claim may not be made on a food for which the reference food meets the definition of “low fat” and “low calorie.”

(c)(1)(i) A product for which the reference food contains 40 calories or less and 3 g fat or less per reference amount customarily consumed may use the term “light” or “lite” without further qualification if it is reduced by 50 percent or more in sodium content compared to the reference food; and

(ii) As required in §101.13(j)(2) for relative claims:

(A) The identity of the reference food and the percent (or fraction) that the sodium was reduced shall be declared in immediate proximity to the most prominent such claim (e.g., 50 percent less sodium than our regular soy sauce); and

(B) Quantitative information comparing the level of sodium per labeled serving size with that of the reference food that it replaces (e.g., “lite soy sauce 500 milligrams (mg) sodium per serving; regular soy sauce 1,000 mg per serving”) is declared adjacent to the most prominent claim or to the nutrition label, except that if the nutrition label is on the information panel, the quantitative information may be located elsewhere on the information panel in accordance with §101.2.

(2)(i) A product for which the reference food contains more than 40 calories or more than 3 g fat per reference amount customarily consumed may use the term “light in sodium” or “lite

in sodium” if it is reduced by 50 percent or more in sodium content compared to the reference food, provided that “light” or “lite” is presented in immediate proximity with “in sodium” and the entire term is presented in uniform type size, style, color, and prominence; and

(ii) As required in §101.13(j)(2) for relative claims:

(A) The identity of the reference food and the percent (or fraction) that the sodium was reduced shall be declared in immediate proximity to the most prominent such claim (e.g., 50 percent less sodium than our regular canned peas); and

(B) Quantitative information comparing the level of sodium per labeled serving size with that of the reference food that it replaces (e.g., “lite canned peas, 175 mg sodium per serving; regular canned peas 350 mg per serving”) is declared adjacent to the most prominent claim or to the nutrition label, except that if the nutrition label is on the information panel, the quantitative information may be located elsewhere on the information panel in accordance with §101.2.

(iii) Except for meal products as defined in §101.13(l) and main dish products as defined in §101.13(m), a “light in sodium” claim may not be made on a food for which the reference food meets the definition of “low in sodium”.

(d)(1) The terms “light” or “lite” may be used on the label or in the labeling of a meal product as defined in §101.13(l) and a main dish product as defined in §101.13(m), provided that:

(i) The food meets the definition of:

(A) “Low in calories” as defined in §101.60(b)(3); or

(B) “Low in fat” as defined in §101.62(b)(3); and

(ii)(A) A statement appears on the principal display panel that explains whether “light” is used to mean “low fat,” “low calories,” or both (e.g., “Light Delight, a low fat meal”); and

(B) The accompanying statement is no less than one-half the type size of the “light” or “lite” claim.

(2)(i) The term “light in sodium” or “lite in sodium” may be used on the label or in the labeling of a meal product as defined in §101.13(l) and a main

§ 101.60

dish product as defined in §101.13(m), provided that the food meets the definition of “low in sodium” as defined in §101.61(b)(5)(i); and

(ii) “Light” or “lite” and “in sodium” are presented in uniform type size, style, color, and prominence.

(e) Except as provided in paragraphs (b) through (d) of this section, the term “light” or “lite” may not be used to refer to a food that is not reduced in fat by 50 percent, or, if applicable, in calories by 1/3 or, when properly qualified, in sodium by 50 percent unless:

(1) It describes some physical or organoleptic attribute of the food such as texture or color and the information (e.g., “light in color” or “light in texture”) so stated, clearly conveys the nature of the product; and

(2) The attribute (e.g., “color” or “texture”) is in the same style, color, and at least one-half the type size as the word “light” and in immediate proximity thereto.

(f) If a manufacturer can demonstrate that the word “light” has been associated, through common use, with a particular food to reflect a physical or organoleptic attribute (e.g., light brown sugar, light corn syrup, or light molasses) to the point where it has become part of the statement of identity, such use of the term “light” shall not be considered a nutrient content claim subject to the requirements in this part.

(g) The term “lightly salted” may be used on a product to which has been added 50 percent less sodium than is normally added to the reference food as described in §101.13(j)(1)(i)(B) and (j)(1)(ii)(B), provided that if the product is not “low in sodium” as defined in §101.61(b)(4), the statement “not a low sodium food,” shall appear adjacent to the nutrition label of the food bearing the claim, or, if the nutrition label is on the information panel, it may appear elsewhere on the information panel in accordance with §101.2 and the information required to accompany a relative claim shall appear on the label or labeling as specified in §101.13(j)(2).

[58 FR 2413, Jan. 6, 1993; 58 FR 17342, Apr. 2, 1993, as amended at 60 FR 17206, Apr. 5, 1995]

21 CFR Ch. I (4–1–07 Edition)

§ 101.60 Nutrient content claims for the calorie content of foods.

(a) *General requirements.* A claim about the calorie or sugar content of a food may only be made on the label or in the labeling of a food if:

(1) The claim uses one of the terms defined in this section in accordance with the definition for that term;

(2) The claim is made in accordance with the general requirements for nutrient content claims in §101.13;

(3) The food for which the claim is made is labeled in accordance with §101.9, §101.10, or §101.36, as applicable; and

(4) For dietary supplements, claims regarding calories may not be made on products that meet the criteria in §101.60(b)(1) or (b)(2) for “calorie free” or “low calorie” claims except when an equivalent amount of a similar dietary supplement (e.g., another protein supplement) that the labeled food resembles and for which it substitutes, normally exceeds the definition for “low calorie” in §101.60(b)(2).

(b) *Calorie content claims.* (1) The terms “calorie free,” “free of calories,” “no calories,” “zero calories,” “without calories,” “trivial source of calories,” “negligible source of calories,” or “dietarily insignificant source of calories” may be used on the label or in the labeling of foods, provided that:

(i) The food contains less than 5 calories per reference amount customarily consumed and per labeled serving.

(ii) As required in §101.13(e)(2), if the food meets this condition without the benefit of special processing, alteration, formulation, or reformulation to lower the caloric content, it is labeled to disclose that calories are not usually present in the food (e.g., “cider vinegar, a calorie free food”).

(2) The terms “low calorie,” “few calories,” “contains a small amount of calories,” “low source of calories,” or “low in calories” may be used on the label or in labeling of foods, except meal products as defined in §101.13(1) and main dish products as defined in §101.13(m), provided that:

(i)(A) The food has a reference amount customarily consumed greater than 30 grams (g) or greater than 2 tablespoons and does not provide more

than 40 calories per reference amount customarily consumed; or

(B) The food has a reference amount customarily consumed of 30 g or less or 2 tablespoons or less and does not provide more than 40 calories per reference amount customarily consumed and, except for sugar substitutes, per 50 g (for dehydrated foods that must be reconstituted before typical consumption with water or a diluent containing an insignificant amount, as defined in §101.9(f)(1), of all nutrients per reference amount customarily consumed, the per 50 g criterion refers to the “as prepared” form).

(ii) If a food meets these conditions without the benefit of special processing, alteration, formulation, or reformulation to vary the caloric content, it is labeled to clearly refer to all foods of its type and not merely to the particular brand to which the label attaches (e.g., “celery, a low calorie food”).

(3) The terms defined in paragraph (b)(2) of this section may be used on the label or in labeling of meal products as defined in §101.13(l) or main dish products as defined in §101.13(m), provided that:

(i) The product contains 120 calories or less per 100 g; and

(ii) If the product meets this condition without the benefit of special processing, alteration, formulation, or reformulation to lower the calorie content, it is labeled to clearly refer to all foods of its type and not merely to the particular brand to which it attaches.

(4) The terms “reduced calorie,” “reduced in calories,” “calorie reduced,” “fewer calories,” “lower calorie,” or “lower in calories” may be used on the label or in the labeling of foods, except as limited by §101.13(j)(1)(i) and except meal products as defined in §101.13(l) and main dish products as defined in §101.13(m), provided that:

(i) The food contains at least 25 percent fewer calories per reference amount customarily consumed than an appropriate reference food as described in §101.13(j)(1); and

(ii) As required in §101.13(j)(2) for relative claims:

(A) The identity of the reference food and the percent (or fraction) that the calories differ between the two foods

are declared in immediate proximity to the most prominent such claim (e.g., reduced calorie cupcakes “33 1/3 percent fewer calories than regular cupcakes”); and

(B) Quantitative information comparing the level of the nutrient per labeled serving size with that of the reference food that it replaces (e.g., “Calorie content has been reduced from 150 to 100 calories per serving.”) is declared adjacent to the most prominent claim or to the nutrition label, except that if the nutrition label is on the information panel, the quantitative information may be located elsewhere on the information panel in accordance with §101.2.

(iii) Claims described in paragraph (b)(4) of this section may not be made on the label or labeling of foods if the reference food meets the definition for “low calorie.”

(5) The terms defined in paragraph (b)(4) of this section may be used on the label or in the labeling of meal products as defined in §101.13(l) and main dish products as defined in §101.13(m), provided that:

(i) The food contains at least 25 percent fewer calories per 100 g of food than an appropriate reference food as described in §101.13(j)(1); and

(ii) As required in §101.13(j)(2) for relative claims:

(A) The identity of the reference food and the percent (or fraction) that the calories differ between the two foods are declared in immediate proximity to the most prominent such claim (e.g., Larry’s Reduced Calorie Lasagna, “25 percent fewer calories per oz (or 3 oz) than our regular Lasagna”); and

(B) Quantitative information comparing the level of the nutrient in the product per specified weight with that of the reference food that it replaces (e.g., “Calorie content has been reduced from 108 calories per 3 oz to 83 calories per 3 oz.”) is declared adjacent to the most prominent claim or to the nutrition label, except that if the nutrition label is on the information panel, the quantitative information may be located elsewhere on the information panel in accordance with §101.2.

(iii) Claims described in paragraph (b)(5) of this section may not be made on the label or labeling of food if the

reference food meets the definition for “low calorie.”

(c) *Sugar content claims*—(1) *Use of terms such as “sugar free,” “free of sugar,” “no sugar,” “zero sugar,” “without sugar,” “sugarless,” “trivial source of sugar,” “negligible source of sugar,” or “dietarily insignificant source of sugar.”* Consumers may reasonably be expected to regard terms that represent that the food contains no sugars or sweeteners e.g., “sugar free,” or “no sugar,” as indicating a product which is low in calories or significantly reduced in calories. Consequently, except as provided in paragraph (c)(2) of this section, a food may not be labeled with such terms unless:

(i) The food contains less than 0.5 g of sugars, as defined in §101.9(c)(6)(ii), per reference amount customarily consumed and per labeled serving or, in the case of a meal product or main dish product, less than 0.5 g of sugars per labeled serving; and

(ii) The food contains no ingredient that is a sugar or that is generally understood by consumers to contain sugars unless the listing of the ingredient in the ingredient statement is followed by an asterisk that refers to the statement below the list of ingredients, which states “adds a trivial amount of sugar,” “adds a negligible amount of sugar,” or “adds a dietarily insignificant amount of sugar;” and

(iii)(A) It is labeled “low calorie” or “reduced calorie” or bears a relative claim of special dietary usefulness labeled in compliance with paragraphs (b)(2), (b)(3), (b)(4), or (b)(5) of this section, or, if a dietary supplement, it meets the definition in paragraph (b)(2) of this section for “low calorie” but is prohibited by §§101.13(b)(5) and 101.60(a)(4) from bearing the claim; or

(B) Such term is immediately accompanied, each time it is used, by either the statement “not a reduced calorie food,” “not a low calorie food,” or “not for weight control.”

(2) The terms “no added sugar,” “without added sugar,” or “no sugar added” may be used only if:

(i) No amount of sugars, as defined in §101.9(c)(6)(ii), or any other ingredient that contains sugars that functionally substitute for added sugars is added during processing or packaging; and

(ii) The product does not contain an ingredient containing added sugars such as jam, jelly, or concentrated fruit juice; and

(iii) The sugars content has not been increased above the amount present in the ingredients by some means such as the use of enzymes, except where the intended functional effect of the process is not to increase the sugars content of a food, and a functionally insignificant increase in sugars results; and

(iv) The food that it resembles and for which it substitutes normally contains added sugars; and

(v) The product bears a statement that the food is not “low calorie” or “calorie reduced” (unless the food meets the requirements for a “low” or “reduced calorie” food) and that directs consumers’ attention to the nutrition panel for further information on sugar and calorie content.

(3) Paragraph (c)(1) of this section shall not apply to a factual statement that a food, including foods intended specifically for infants and children less than 2 years of age, is unsweetened or contains no added sweeteners in the case of a food that contains apparent substantial inherent sugar content, e.g., juices.

(4) The claims provided for in paragraph (c)(1) and (c)(2) of this section may be used on labels or in labeling of dietary supplements of vitamins or minerals that are intended specifically for use by infants and children less than 2 years of age.

(5) The terms “reduced sugar,” “reduced in sugar,” “sugar reduced,” “less sugar,” “lower sugar” or “lower in sugar” may be used on the label or in labeling of foods, except meal products as defined in §101.13(l), main dish products as defined in §101.13(m), and dietary supplements of vitamins or minerals, provided that:

(i) The food contains at least 25 percent less sugar per reference amount customarily consumed than an appropriate reference food as described in §101.13(j)(1); and

(ii) As required in §101.13(j)(2) for relative claims:

(A) The identity of the reference food and the percent (or fraction) that the sugar differs between the two foods are declared in immediate proximity to the

most prominent such claim (e.g., “these corn flakes contain 25 percent less sugar than our sugar coated corn flakes”); and

(B) Quantitative information comparing the level of the sugar in the product per labeled serving with that of the reference food that it replaces (e.g., “Sugar content has been lowered from 8 g to 6 g per serving.”) is declared adjacent to the most prominent claim or to the nutrition label, except that if the nutrition label is on the information panel, the quantitative information may be located elsewhere on the information panel in accordance with §101.2.

(6) The terms defined in paragraph (c)(5) of this section may be used on the label or in the labeling of a meal product as defined in §101.13(l) and a main dish product as defined in §101.13(m), provided that:

(i) The food contains at least 25 percent less sugars per 100 g of food than an appropriate reference food as described in §101.13(j)(1), and

(ii) As required in §101.13(j)(2) for relative claims:

(A) The identity of the reference food and the percent (or fraction) that the sugars differ between the two foods are declared in immediate proximity to the most prominent such claim (e.g., reduced sweet and sour shrimp dinner, “25 percent less sugar per 3 oz than our regular sweet and sour shrimp dinner”); and

(B) Quantitative information comparing the level of the nutrient in the product per specified weight with that of the reference food that it replaces (e.g., “Sugar content has been reduced from 17 g per 3 oz to 13 g per 3 oz.”) is declared adjacent to the most prominent claim or to the nutrition label, except that if the nutrition label is on the information panel, the quantitative information may be located elsewhere on the information panel in accordance with §101.2.

[58 FR 2413, Jan. 6, 1993; 58 FR 17342, Apr. 2, 1993, as amended at 58 FR 44031, Aug. 18, 1993; 59 FR 394, Jan. 4, 1994; 60 FR 17206, Apr. 5, 1995; 62 FR 15342, Mar. 31, 1997; 62 FR 49881, Sept. 23, 1997]

§ 101.61 Nutrient content claims for the sodium content of foods.

(a) *General requirements.* A claim about the level of sodium or salt in a food may only be made on the label or in the labeling of the food if:

(1) The claim uses one of the terms defined in this section in accordance with the definition for that term;

(2) The claim is made in accordance with the general requirements for nutrient content claims in §101.13; and

(3) The food for which the claim is made is labeled in accordance with §101.9, §101.10, or §101.36, as applicable.

(b) *Sodium content claims.* (1) The terms “sodium free,” “free of sodium,” “no sodium,” “zero sodium,” “without sodium,” “trivial source of sodium,” “negligible source of sodium,” or “dietary insignificant source of sodium” may be used on the label or in the labeling of foods, provided that:

(i) The food contains less than 5 milligrams (mg) of sodium per reference amount customarily consumed and per labeled serving or, in the case of a meal product or a main dish product, less than 5 mg of sodium per labeled serving; and

(ii) The food contains no ingredient that is sodium chloride or is generally understood by consumers to contain sodium, unless the listing of the ingredient in the ingredient statement is followed by an asterisk that refers to the statement below the list of ingredients, which states: “Adds a trivial amount of sodium,” “adds a negligible amount of sodium” or “adds a dietarily insignificant amount of sodium;” and

(iii) As required in §101.13(e)(2) if the food meets these conditions without the benefit of special processing, alteration, formulation, or reformulation to lower the sodium content, it is labeled to disclose that sodium is not usually present in the food (e.g., “leaf lettuce, a sodium free food”).

(2) The terms “very low sodium,” or “very low in sodium,” may be used on the label or in labeling of foods, except meal products as defined in §101.13(l) and main dish products as defined in §101.13(m), provided that:

(i)(A) The food has a reference amount customarily consumed greater than 30 grams (g) or greater than 2 tablespoons and contains 35 mg or less

§ 101.61

21 CFR Ch. I (4–1–07 Edition)

sodium per reference amount customarily consumed; or

(B) The food has a reference amount customarily consumed of 30 g or less or 2 tablespoons or less and contains 35 mg or less sodium per reference amount customarily consumed and per 50 g (for dehydrated foods that must be reconstituted before typical consumption with water or a diluent containing an insignificant amount, as defined in §101.9(f)(1), of all nutrients per reference amount customarily consumed, the per 50-g criterion refers to the “as prepared” form);

(i) If the food meets these conditions without the benefit of special processing, alteration, formulation, or reformulation to vary the sodium content, it is labeled to clearly refer to all foods of its type and not merely to the particular brand to which the label attaches (e.g., “potatoes, a very low-sodium food”).

(3) The terms defined in paragraph (b)(2) of this section may be used on the label or in labeling of meal products as defined in §101.13(l) and main dish products as defined in §101.13(m), provided that:

(i) The product contains 35 mg or less of sodium per 100 g of product; and

(ii) If the product meets this condition without the benefit of special processing, alteration, formulation, or reformulation to lower the sodium content, it is labeled to clearly refer to all foods of its type and not merely to the particular brand to which the label attaches.

(4) The terms “low sodium,” or “low in sodium,” “little sodium,” “contains a small amount of sodium,” or “low source of sodium” may be used on the label or in the labeling of foods, except meal products as defined in §101.13(l) and main dish products as defined in §101.13(m), provided that:

(i)(A) The food has a reference amount customarily consumed greater than 30 g or greater than 2 tablespoons and contains 140 mg or less sodium per reference amount customarily consumed; or

(B) The food has a reference amount customarily consumed of 30 g or less or 2 tablespoons or less and contains 140 mg or less sodium per reference amount customarily consumed and per

50 g (for dehydrated foods that must be reconstituted before typical consumption with water or a diluent containing an insignificant amount, as defined in §101.9(f)(1), of all nutrients per reference amount customarily consumed, the per 50-g criterion refers to the “as prepared” form); and

(ii) If the food meets these conditions without the benefit of special processing, alteration, formulation, or reformulation to vary the sodium content, it is labeled to clearly refer to all foods of its type and not merely to the particular brand to which the label attaches (e.g., “fresh spinach, a low sodium food”); and

(5) The terms defined in paragraph (b)(4) of this section may be used on the label or in labeling of meal products as defined in §101.13(l) and main dish products as defined in §101.13(m), provided that:

(i) The product contains 140 mg or less sodium per 100 g; and

(ii) If the product meets these conditions without the benefit of special processing, alteration, formulation, or reformulation to lower the sodium content, it is labeled to clearly refer to all foods of its type and not merely to the particular brand to which the label attaches.

(6) The terms “reduced sodium,” “reduced in sodium,” “sodium reduced,” “less sodium,” “lower sodium,” or “lower in sodium” may be used on the label or in labeling of foods, except meal products as defined in §101.13(l) and main dish products as defined in §101.13(m), provided that:

(i) The food contains at least 25 percent less sodium per reference amount customarily consumed than an appropriate reference food as described in §101.13(j)(1).

(ii) As required for §101.13(j)(2) for relative claims:

(A) The identity of the reference food and the percent (or fraction) that the sodium differs from the labeled food are declared in immediate proximity to the most prominent such claim (e.g., “reduced sodium _____, 50 percent less sodium than regular _____”); and

(B) Quantitative information comparing the level of the sodium in the product per labeled serving with that of the reference food that it replaces

(e.g., “Sodium content has been lowered from 300 to 150 mg per serving.”) is declared adjacent to the most prominent claim or to the nutrition label, except that if the nutrition label is on the information panel, the quantitative information may be located elsewhere on the information panel in accordance with §101.2.

(iii) Claims described in paragraph (b)(6) of this section may not be made on the label or in the labeling of a food if the nutrient content of the reference food meets the definition for “low sodium.”

(7) The terms defined in paragraph (b)(6) of this section may be used on the label or in the labeling of meal products as defined in §101.13(1) and main dish products as defined in §101.13(m), provided that:

(i) The food contains at least 25 percent less sodium per 100 g of food than an appropriate reference food as described in §101.13(j)(1), and

(ii) As required in §101.13(j)(2) for relative claims:

(A) The identity of the reference food and the percent (or fraction) that the sodium differs from the reference food are declared in immediate proximity to the most prominent such claim (e.g., reduced sodium eggplant parmigiana dinner “30 percent less sodium per oz (or 3 oz) than our regular eggplant parmigiana dinner”).

(B) Quantitative information comparing the level of sodium in the product per specified weight with that of the reference food that it replaces (e.g., “Sodium content has been reduced from 217 mg per 3 oz to 150 mg per 3 oz.”) is declared adjacent to the most prominent claim or to the nutrition label, except that if the nutrition label is on the information panel, the quantitative information may be located elsewhere on the information panel in accordance with §101.2.

(iii) Claims described in paragraph (b)(7) of this section may not be made on the label or in the labeling of a food if the nutrient content of the reference food meets the definition for “low sodium.”

(c) The term “salt” is not synonymous with “sodium.” Salt refers to sodium chloride. However, references to salt content such as “unsalted,” “no

salt,” “no salt added” are potentially misleading.

(1) The term “salt free” may be used on the label or in labeling of foods only if the food is “sodium free” as defined in paragraph (b)(1) of this section.

(2) The terms “unsalted,” “without added salt,” and “no salt added” may be used on the label or in labeling of foods only if:

(i) No salt is added during processing;

(ii) The food that it resembles and for which it substitutes is normally processed with salt; and

(iii) If the food is not sodium free, the statement, “not a sodium free food” or “not for control of sodium in the diet” appears adjacent to the nutrition label of the food bearing the claim, or, if the nutrition label is on the information panel, it may appear elsewhere on the information panel in accordance with §101.2.

(3) Paragraph (c)(2) of this section shall not apply to a factual statement that a food intended specifically for infants and children less than 2 years of age is unsalted, provided such statement refers to the taste of the food and is not otherwise false and misleading.

[58 FR 2413, Jan. 6, 1993; 58 FR 17342, Apr. 2, 1993, as amended at 58 FR 44032, Aug. 18, 1993; 59 FR 394, Jan. 4, 1994; 60 FR 17206, Apr. 5, 1995]

§101.62 Nutrient content claims for fat, fatty acid, and cholesterol content of foods.

(a) *General requirements.* A claim about the level of fat, fatty acid, and cholesterol in a food may only be made on the label or in the labeling of foods if:

(1) The claim uses one of the terms defined in this section in accordance with the definition for that term;

(2) The claim is made in accordance with the general requirements for nutrient content claims in §101.13;

(3) The food for which the claim is made is labeled in accordance with §101.9, §101.10, or §101.36, as applicable; and

(4) For dietary supplements, claims for fat, saturated fat, and cholesterol may not be made on products that meet the criteria in §101.60(b)(1) or (b)(2) for “calorie free” or “low calorie” claims.

(b) *Fat content claims.* (1) The terms “fat free,” “free of fat,” “no fat,” “zero fat,” “without fat,” “negligible source of fat,” or “dietarily insignificant source of fat” or, in the case of milk products, “skim” may be used on the label or in labeling of foods, provided that:

(i) The food contains less than 0.5 gram (g) of fat per reference amount customarily consumed and per labeled serving or, in the case of a meal product or main dish product, less than 0.5 g of fat per labeled serving; and

(ii) The food contains no added ingredient that is a fat or is generally understood by consumers to contain fat unless the listing of the ingredient in the ingredient statement is followed by an asterisk that refers to the statement below the list of ingredients, which states “adds a trivial amount of fat,” “adds a negligible amount of fat,” or “adds a dietarily insignificant amount of fat;” and

(iii) As required in §101.13(e)(2), if the food meets these conditions without the benefit of special processing, alteration, formulation, or reformulation to lower fat content, it is labeled to disclose that fat is not usually present in the food (e.g., “broccoli, a fat free food”).

(2) The terms “low fat,” “low in fat,” “contains a small amount of fat,” “low source of fat,” or “little fat” may be used on the label or in labeling of foods, except meal products as defined in §101.13(l) and main dish products as defined in §101.13(m), provided that:

(i)(A) The food has a reference amount customarily consumed greater than 30 g or greater than 2 tablespoons and contains 3 g or less of fat per reference amount customarily consumed; or

(B) The food has a reference amount customarily consumed of 30 g or less or 2 tablespoons or less and contains 3 g or less of fat per reference amount customarily consumed and per 50 g of food (for dehydrated foods that must be reconstituted before typical consumption with water or a diluent containing an insignificant amount, as defined in §101.9(f)(1), of all nutrients per reference amount customarily consumed, the per 50-g criterion refers to the “as prepared” form); and

(ii) If the food meets these conditions without the benefit of special processing, alteration, formulation, or reformulation to lower fat content, it is labeled to clearly refer to all foods of its type and not merely to the particular brand to which the label attaches (e.g., “frozen perch, a low fat food”).

(3) The terms defined in paragraph (b)(2) of this section may be used on the label or in labeling of meal products as defined in §101.13(l) or main dish products as defined in §101.13(m), provided that:

(i) The product contains 3 g or less of total fat per 100 g and not more than 30 percent of calories from fat; and

(ii) If the product meets these conditions without the benefit of special processing, alteration, formulation, or reformulation to lower fat content, it is labeled to clearly refer to all foods of its type and not merely to the particular brand to which the label attaches.

(4) The terms “reduced fat,” “reduced in fat,” “fat reduced,” “less fat,” “lower fat,” or “lower in fat” may be used on the label or in the labeling of foods, except meal products as defined in §101.13(l) and main dish products as defined in §101.13(m), provided that:

(i) The food contains at least 25 percent less fat per reference amount customarily consumed than an appropriate reference food as described in §101.13(j)(1); and

(ii) As required in §101.13(j)(2) for relative claims:

(A) The identity of the reference food and the percent (or fraction) that the fat differs between the two foods and are declared in immediate proximity to the most prominent such claim (e.g., “reduced fat—50 percent less fat than our regular brownies”); and

(B) Quantitative information comparing the level of fat in the product per labeled serving with that of the reference food that it replaces (e.g., “Fat content has been reduced from 8 g to 4 g per serving.”) is declared adjacent to the most prominent claim or to the nutrition label, except that if the nutrition label is on the information panel, the quantitative information may be located elsewhere on the information panel in accordance with §101.2.

(iii) Claims described in paragraph (b)(4) of this section may not be made on the label or in the labeling of a food if the nutrient content of the reference food meets the definition for “low fat.”

(5) The terms defined in paragraph (b)(4) of this section may be used on the label or in the labeling of meal products as defined in §101.13(l) and main dish products as defined in §101.13(m), provided that:

(i) The food contains at least 25 percent less fat per 100 g of food than an appropriate reference food as described in §101.13(j)(1); and

(ii) As required in §101.13(j)(2) for relative claims:

(A) The identity of the reference food and the percent (or fraction) that the fat differs between the two foods are declared in immediate proximity to the most prominent such claim (e.g., reduced fat spinach souffle, “33 percent less fat per 3 oz than our regular spinach souffle”); and

(B) Quantitative information comparing the level of fat in the product per specified weight with that of the reference food that it replaces (e.g., “Fat content has been reduced from 7.5 g per 3 oz to 5 g per 3 oz.”) is declared adjacent to the most prominent claim, to the nutrition label, or, if the nutrition label is located on the information panel, it may appear elsewhere on the information panel in accordance with §101.2.

(iii) Claims described in paragraph (b)(5) of this section may not be made on the label or in the labeling of a food if the nutrient content of the reference food meets the definition for “low fat.”

(6) The term “_ percent fat free” may be used on the label or in the labeling of foods, provided that:

(i) The food meets the criteria for “low fat” in paragraph (b)(2) or (b)(3) of this section;

(ii) The percent declared and the words “fat free” are in uniform type size; and

(iii) A “100 percent fat free” claim may be made only on foods that meet the criteria for “fat free” in paragraph (b)(1) of this section, that contain less than 0.5 g of fat per 100 g, and that contain no added fat.

(c) *Fatty acid content claims.* The label or labeling of foods that bear claims

with respect to the level of saturated fat shall disclose the level of total fat and cholesterol in the food in immediate proximity to such claim each time the claim is made and in type that shall be no less than one-half the size of the type used for the claim with respect to the level of saturated fat. Declaration of cholesterol content may be omitted when the food contains less than 2 milligrams (mg) of cholesterol per reference amount customarily consumed or in the case of a meal or main dish product less than 2 mg of cholesterol per labeled serving. Declaration of total fat may be omitted with the term defined in paragraph (c)(1) of this section when the food contains less than 0.5 g of total fat per reference amount customarily consumed or, in the case of a meal product or a main dish product, when the product contains less than 0.5 g of total fat per labeled serving. The declaration of total fat may be omitted with the terms defined in paragraphs (c)(2) through (c)(5) of this section when the food contains 3 g or less of total fat per reference amount customarily consumed or in the case of a meal product or a main dish product, when the product contains 3 g or less of total fat per 100 g and not more than 30 percent calories from fat.

(1) The terms “saturated fat free,” “free of saturated fat,” “no saturated fat,” “zero saturated fat,” “without saturated fat,” “trivial source of saturated fat,” “negligible source of saturated fat,” or “dietarily insignificant source of saturated fat” may be used on the label or in the labeling of foods, provided that:

(i) The food contains less than 0.5 g of saturated fat and less than 0.5 g *trans* fatty acid per reference amount customarily consumed and per labeled serving, or in the case of a meal product or main dish product, less than 0.5 g of saturated fat and less than 0.5 g *trans* fatty acid per labeled serving; and

(ii) The food contains no ingredient that is generally understood by consumers to contain saturated fat unless the listing of the ingredient in the ingredient statement is followed by an asterisk that refers to the statement below the list of ingredients which

states, “adds a trivial amount of saturated fat,” “adds a negligible amount of saturated fat,” or “adds a dietarily insignificant amount of saturated fat;” and

(iii) As required in §101.13(e)(2), if the food meets these conditions without the benefit of special processing, alteration, formulation, or reformulation to lower saturated fat content, it is labeled to disclose that saturated fat is not usually present in the food.

(2) The terms “low in saturated fat,” “low saturated fat,” “contains a small amount of saturated fat,” “low source of saturated fat,” or “a little saturated fat” may be used on the label or in the labeling of foods, except meal products as defined in §101.13(l) and main dish products as defined in §101.13(m), provided that:

(i) The food contains 1 g or less of saturated fatty acids per reference amount customarily consumed and not more than 15 percent of calories from saturated fatty acids; and

(ii) If a food meets these conditions without benefit of special processing, alteration, formulation, or reformulation to lower saturated fat content, it is labeled to clearly refer to all foods of its type and not merely to the particular brand to which the label attaches (e.g., “raspberries, a low saturated fat food”).

(3) The terms defined in paragraph (c)(2) of this section may be used on the label or in the labeling of meal products as defined in §101.13(l) and main dish products as defined in §101.13(m), provided that:

(i) The product contains 1 g or less of saturated fatty acids per 100 g and less than 10 percent calories from saturated fat; and

(ii) If the product meets these conditions without the benefit of special processing, alteration, formulation, or reformulation to lower saturated fat content, it is labeled to clearly refer to all foods of its type and not merely to the particular brand to which the label attaches.

(4) The terms “reduced saturated fat,” “reduced in saturated fat,” “saturated fat reduced,” “less saturated fat,” “lower saturated fat,” or “lower in saturated fat” may be used on the label or in the labeling of foods,

except as limited by §101.13(j)(1)(i) and except meal products as defined in §101.13(l) and main dish products as defined in §101.13(m), provided that:

(i) The food contains at least 25 percent less saturated fat per reference amount customarily consumed than an appropriate reference food as described in §101.13(j)(1); and

(ii) As required in §101.13(j)(2) for relative claims:

(A) The identity of the reference food and the percent (or fraction) that the saturated fat differs between the two foods are declared in immediate proximity to the most prominent such claim (e.g., “reduced saturated fat. Contains 50 percent less saturated fat than the national average for nondairy creamers”); and

(B) Quantitative information comparing the level of saturated fat in the product per labeled serving with that of the reference food that it replaces (e.g., “Saturated fat reduced from 3 g to 1.5 g per serving”) is declared adjacent to the most prominent claim or to the nutrition label, except that if the nutrition label is on the information panel, the quantitative information may be located elsewhere on the information panel in accordance with §101.2.

(iii) Claims described in paragraph (c)(4) of this section may not be made on the label or in the labeling of a food if the nutrient content of the reference food meets the definition for “low saturated fat.”

(5) The terms defined in paragraph (c)(4) of this section may be used on the label or in the labeling of meal products as defined in §101.13(l) and main dish products as defined in §101.13(m), provided that:

(i) The food contains at least 25 percent less saturated fat per 100 g of food than an appropriate reference food as described in §101.13(j)(1), and

(ii) As required in §101.13(j)(2) for relative claims:

(A) The identity of the reference food, and the percent (or fraction) that the fat differs between the two foods are declared in immediate proximity to the most prominent such claim (e.g., reduced saturated fat Macaroni and Cheese, “33 percent less saturated fat per 3 oz than our regular Macaroni and Cheese”).

(B) Quantitative information comparing the level of saturated fat in the product per specified weight with that of the reference food that it replaces (e.g., “Saturated fat content has been reduced from 2.5 g per 3 oz to 1.7 g per 3 oz.”) is declared adjacent to the most prominent claim or to the nutrition label, except that if the nutrition label in on the information panel, the quantitative information may be located elsewhere on the information panel in accordance with §101.2.

(iii) Claims described in paragraph (c)(5) of this section may not be made on the label or in the labeling of a food if the nutrient content of the reference food meets the definition for “low saturated fat.”

(d) *Cholesterol content claims.* (1) The terms “cholesterol free,” “free of cholesterol,” “zero cholesterol,” “without cholesterol,” “no cholesterol,” “trivial source of cholesterol,” “negligible source of cholesterol,” or “dietarily insignificant source of cholesterol” may be used on the label or in the labeling of foods, provided that:

(i) For foods that contain 13 g or less of total fat per reference amount customarily consumed, per labeled serving, and per 50 g if the reference amount customarily consumed is 30 g or less or 2 tablespoons or less (for dehydrated foods that must be reconstituted before typical consumption with water or a diluent containing an insignificant amount, as defined in §101.9(f)(1), of all nutrients per reference amount customarily consumed, the per 50-g criterion refers to the “as prepared” form), or, in the case of meal products, 26.0 g or less total fat per labeled serving, or, in the case of main dish products, 19.5 g or less total fat per labeled serving:

(A) The food contains less than 2 mg of cholesterol per reference amount customarily consumed and per labeling serving or, in the case of a meal product or main dish product, less than 2 mg of cholesterol per labeled serving; and

(B) The food contains no ingredient that is generally understood by consumers to contain cholesterol, unless the listing of the ingredient in the ingredient statement is followed by an asterisk that refers to the statement

below the list of ingredients, which states “adds a trivial amount of cholesterol,” “adds a negligible amount of cholesterol,” or “adds a dietarily insignificant amount of cholesterol;” and

(C) The food contains 2 g or less of saturated fatty acids per reference amount customarily consumed or, in the case of a meal product or main dish product, 2 g or less of saturated fatty acids per labeled serving; and

(D) As required in §101.13(e)(2), if the food contains less than 2 mg of cholesterol per reference amount customarily consumed or in the case of a meal product or main dish product, less than 2 mg of cholesterol per labeled serving without the benefit of special processing, alteration, formulation, or reformulation to lower cholesterol content, it is labeled to disclose that cholesterol is not usually present in the food (e.g., “applesauce, a cholesterol-free food”).

(ii) For food that contain more than 13 g of total fat per reference amount customarily consumed, per labeling serving, or per 50 g if the reference amount customarily consumed is 30 g or less or 2 tablespoons or less (for dehydrated foods that must be reconstituted before typical consumption with water or a diluent containing an insignificant amount, as defined in §101.9(f)(1), of all nutrients per reference amount customarily consumed, the per 50-g criterion refers to the “as prepared” form), or in the case of a meal product, more than 26 g of total fat per labeled serving, or, in the case of a main dish product more than 19.5 g of total fat per labeled serving:

(A) The food contains less than 2 mg of cholesterol per reference amount customarily consumed and per labeling serving or, in the case of a meal product or main dish product, less than 2 mg of cholesterol per labeled serving; and

(B) The food contains no ingredient that is generally understood by consumers to contain cholesterol, unless the listing of the ingredient in the ingredient statement is followed by an asterisk that refers to the statement below the list of ingredients, which states “adds a trivial amount of cholesterol,” “adds a negligible amount of

cholesterol,” or “adds a dietarily insignificant amount of cholesterol;” and

(C) The food contains 2 g or less of saturated fatty acids per reference amount customarily consumed or, in the case of a meal product or main dish product less than 2 g of saturated fatty acids per labeled serving; and

(D) The label or labeling discloses the level of total fat in a serving (as declared on the label) of the food. Such disclosure shall appear in immediate proximity to such claim preceding any disclosure statement required under §101.13(h) in type that shall be no less than one-half the size of the type used for such claim. If the claim appears on more than one panel, the disclosure shall be made on each panel except for the panel that bears nutrition labeling. If the claim appears more than once on a panel, the disclosure shall be made in immediate proximity to the claim that is printed in the largest type; and

(E) As required in §101.13(e)(2), if the food contains less than 2 mg of cholesterol per reference amount customarily consumed or in the case of a meal product or main dish product less than 2 mg of cholesterol per labeled serving without the benefit of special processing, alteration, formulation, or reformulation to lower cholesterol content, it is labeled to disclose that cholesterol is not usually present in the food (e.g., “canola oil, a cholesterol-free food, contains 14 g of fat per serving”); or

(F) If the food contains less than 2 mg of cholesterol per reference amount customarily consumed or in the case of a meal product or main dish product less than 2 mg of cholesterol per labeled serving only as a result of special processing, alteration, formulation, or reformulation, the amount of cholesterol is substantially less (i.e., meets requirements of paragraph (d)(4)(ii)(A) of this section) than the food for which it substitutes as specified in §101.13(d) that has a significant (e.g., 5 percent or more of a national or regional market) market share. As required in §101.13(j)(2) for relative claims:

(1) The identity of the reference food and the percent (or fraction) that the cholesterol was reduced are declared in immediate proximity to the most prominent such claim (e.g., “choles-

terol-free margarine, contains 100 percent less cholesterol than butter”); and

(2) Quantitative information comparing the level of cholesterol in the product per labeled serving with that of the reference food that it replaces (e.g., “Contains no cholesterol compared with 30 mg cholesterol in one serving of butter. Contains 13 g of fat per serving.”) is declared adjacent to the most prominent claim or to the nutrition label, except that if the nutrition label is on the information panel, the quantitative information may be located elsewhere on the information panel in accordance with §101.2.

(2) The terms “low in cholesterol,” “low cholesterol,” “contains a small amount of cholesterol,” “low source of cholesterol,” or “little cholesterol” may be used on the label or in the labeling of foods, except meal products as defined in §101.13(1) and main dish products as defined in §101.13(m), provided that:

(i) For foods that have a reference amount customarily consumed greater than 30 g or greater than 2 tablespoons and contain 13 g or less of total fat per reference amount customarily consumed and per labeled serving:

(A) The food contains 20 mg or less of cholesterol per reference amount customarily consumed;

(B) The food contains 2 g or less of saturated fatty acids per reference amount customarily consumed; and

(C) As required in §101.13(e)(2), if the food meets these conditions without the benefit of special processing, alteration, formulation, or reformulation to lower cholesterol content, it is labeled to clearly refer to all foods of that type and not merely to the particular brand to which the label attaches (e.g., “low fat cottage cheese, a low cholesterol food.”).

(ii) For foods that have a reference amount customarily consumed of 30 g or less or 2 tablespoons or less and contain 13 g or less of total fat per reference amount customarily consumed, per labeled serving, and per 50 g (for dehydrated foods that must be reconstituted before typical consumption with water or a diluent containing an insignificant amount, as defined in §101.9(f)(1), of all nutrients per reference amount customarily consumed,

the per 50-g criterion refers to the “as prepared” form);

(A) The food contains 20 mg or less of cholesterol per reference amount customarily consumed and per 50 g (for dehydrated foods that must be reconstituted before typical consumption with water or a diluent containing an insignificant amount, as defined in §101.9(f)(1), of all nutrients per reference amount customarily consumed, the per 50-g criterion refers to the “as prepared” form);

(B) The food contains 2 g or less of saturated fatty acids per reference amount customarily consumed; and

(C) As required in §101.13(e)(2), if the food meets these conditions without the benefit of special processing, alteration, formulation, or reformulation to lower cholesterol content, it is labeled to clearly refer to all foods of that type and not merely to the particular brand to which the label attaches (e.g., “low fat cottage cheese, a low cholesterol food”).

(iii) For foods that have a reference amount customarily consumed greater than 30 g or greater than 2 tablespoons and contain more than 13 g of total fat per reference amount customarily consumed or per labeled serving,

(A) The food contains 20 mg or less of cholesterol per reference amount customarily consumed;

(B) The food contains 2 g or less of saturated fatty acids per reference amount customarily consumed;

(C) The label or labeling discloses the level of total fat in a serving (as declared on the label) of the food. Such disclosure shall appear in immediate proximity to such claim preceding any disclosure statement required under §101.13(h) in type that shall be no less than one-half the size of the type used for such claim. If the claim appears on more than one panel, the disclosure shall be made on each panel except for the panel that bears nutrition labeling. If the claim is made more than once on a panel, the disclosure shall be made in immediate proximity to the claim that is printed in the largest type; and

(D) As required in §101.13(e)(2), if the food meets these conditions without the benefit of special processing, alteration, formulation, or reformulation to lower cholesterol content, it is labeled

to clearly refer to all foods of that type and not merely to the particular brand to which the label attaches; or

(E) If the food contains 20 mg or less of cholesterol only as a result of special processing, alteration, formulation, or reformulation, the amount of cholesterol is substantially less (i.e., meets requirements of paragraph (d)(4)(ii)(A) of this section) than the food for which it substitutes as specified in §101.13(d) that has a significant (e.g., 5 percent or more of a national or regional market) market share. As required in §101.13(j)(2) for relative claims:

(1) The identity of the reference food and the percent (or fraction) that the cholesterol has been reduced are declared in immediate proximity to the most prominent such claim (e.g., “low-cholesterol peanut butter sandwich crackers, contains 83 percent less cholesterol than our regular peanut butter sandwich crackers”); and

(2) Quantitative information comparing the level of cholesterol in the product per labeled serving with that of the reference food that it replaces (e.g., “Cholesterol lowered from 30 mg to 5 mg per serving; contains 13 g of fat per serving.”) is declared adjacent to the most prominent claim or to the nutrition label, except that if the nutrition label is on the information panel, the quantitative information may be located elsewhere on the information panel in accordance with §101.2.

(iv) For foods that have a reference amount customarily consumed of 30 g or less or 2 tablespoons or less and contain more than 13 g of total fat per reference amount customarily consumed, per labeled serving, or per 50 g (for dehydrated foods that must be reconstituted before typical consumption with water or a diluent containing an insignificant amount, as defined in §101.9(f)(1), of all nutrients per reference amount customarily consumed, the per 50-g criterion refers to the “as prepared” form),

(A) The food contains 20 mg or less of cholesterol per reference amount customarily consumed and per 50 g (for dehydrated foods that must be reconstituted before typical consumption with water or a diluent containing an insignificant amount, as defined in

§ 101.62

§101.9(f)(1), of all nutrients per reference amount customarily consumed, the per 50-g criterion refers to the “as prepared” form),

(B) The food contains 2 g or less of saturated fatty acids per reference amount customarily consumed;

(C) The label or labeling discloses the level of total fat in a serving (as declared on the label) of the food. Such disclosure shall appear in immediate proximity to such claim preceding any disclosure statement required under §101.13(h) in type that shall be no less than one-half the size of the type used for such claim. If the claim appears on more than one panel, the disclosure shall be made on each panel except for the panel that bears nutrition labeling. If the claim is made more than once on a panel, the disclosure shall be made in immediate proximity to the claim that is printed in the largest type; and

(D) As required in §101.13(e)(2), if the food meets these conditions without the benefit of special processing, alteration, formulation, or reformulation to lower cholesterol content, it is labeled to clearly refer to all foods of that type and not merely to the particular brand to which the label attaches; or

(E) If the food contains 20 mg or less of cholesterol only as a result of special processing, alteration, formulation, or reformulation, the amount of cholesterol is substantially less (i.e., meets requirements of paragraph (d)(4)(ii)(A) of this section) than the food for which it substitutes as specified in §101.13(d) that has a significant (i.e., 5 percent or more of a national or regional market) market share. As required in §101.13(j)(2) for relative claims:

(1) The identity of the reference food and the percent (or fraction) that the cholesterol has been reduced are declared in immediate proximity to the most prominent such claim (e.g., “low-cholesterol peanut butter sandwich crackers, contains 83 percent less cholesterol than our regular peanut butter sandwich crackers”); and

(2) Quantitative information comparing the level of cholesterol in the product per labeled serving with that of the reference food that it replaces (e.g., “Cholesterol lowered from 30 mg to 5 mg per serving; contains 13 g of fat

21 CFR Ch. I (4–1–07 Edition)

per serving.”) is declared adjacent to the most prominent claim or to the nutrition label, except that if the nutrition label is on the information panel, the quantitative information may be located elsewhere on the information panel in accordance with §101.2.

(3) The terms defined in paragraph (d)(2) of this section may be used on the label and in labeling of meal products as defined in §101.13(l) or a main dish product as defined in §101.13(m) provided that the product meets the requirements of paragraph (d)(2) of this section except that the determination as to whether paragraph (d)(2)(i) or (d)(2)(iii) of this section applies to the product will be made only on the basis of whether the meal product contains 26 g or less of total fat per labeled serving or the main dish product contain 19.5 g or less of total fat per labeled serving, the requirement in paragraphs (d)(2)(i)(A) and (d)(2)(iii)(A) of this section shall be limited to 20 mg of cholesterol per 100 g, and the requirement in paragraphs (d)(2)(i)(B) and (d)(2)(iii)(B) of this section shall be modified to require that the food contain 2 g or less of saturated fat per 100 g rather than per reference amount customarily consumed.

(4) The terms “reduced cholesterol,” “reduced in cholesterol,” “cholesterol reduced,” “less cholesterol,” “lower cholesterol,” or “lower in cholesterol” except as limited by §101.13(j)(1)(i) may be used on the label or in labeling of foods or foods that substitute for those foods as specified in §101.13(d), excluding meal products as defined in §101.13(l) and main dish products as defined in §101.13(m), provided that:

(i) For foods that contain 13 g or less of total fat per reference amount customarily consumed, per labeled serving, and per 50 g if the reference amount customarily consumed is 30 g or less or 2 tablespoons or less (for dehydrated foods that must be reconstituted before typical consumption with water or a diluent containing an insignificant amount, as defined in §101.9(f)(1), of all nutrients per reference amount customarily consumed, the per 50-g criterion refers to the “as prepared” form):

(A) The food has been specifically formulated, altered, or processed to reduce its cholesterol by 25 percent or more from the reference food it resembles as defined in §101.13(j)(1) and for which it substitutes as specified in §101.13(d) that has a significant (i.e., 5 percent or more) market share; and

(B) The food contains 2 g or less of saturated fatty acids per reference amount customarily consumed; and

(C) As required in §101.13(j)(2) for relative claims:

(1) The identity of the reference food and the percent (or fraction) that the cholesterol has been reduced are declared in immediate proximity to the most prominent such claim; and

(2) Quantitative information comparing the level of cholesterol in the product per labeled serving with that of the reference food that it replaces (e.g., “[labeled product] 50 mg cholesterol per serving; [reference product] 30 mg cholesterol per serving”) is declared adjacent to the most prominent claim or to the nutrition label, except that if the nutrition label is on the information panel, the quantitative information may be located elsewhere on the information panel in accordance with §101.2.

(ii) For foods that contain more than 13 g of total fat per reference amount customarily consumed, per labeled serving, or per 50 g if the reference amount customarily consumed is 30 g or less or 2 tablespoons or less (for dehydrated foods that must be reconstituted before typical consumption with water or a diluent containing an insignificant amount, as defined in §101.9(f)(1), of all nutrients per reference amount customarily consumed, the per 50-g criterion refers to the “as prepared” form):

(A) The food has been specifically formulated, altered, or processed to reduce its cholesterol by 25 percent or more from the reference food it resembles as defined in §101.13(j)(1) and for which it substitutes as specified in §101.13(d) that has a significant (i.e., 5 percent or more of a national or regional market) market share;

(B) The food contains 2 g or less of saturated fatty acids per reference amount customarily consumed;

(C) The label or labeling discloses the level of total fat in a serving (as declared on the label) of the food. Such disclosure shall appear in immediate proximity to such claim preceding any disclosure statement required under §101.13(h) in type that shall be no less than one-half the size of the type used for such claim. If the claim appears on more than one panel, the disclosure shall be made on each panel except for the panel that bears nutrition labeling. If the claim is made more than once on a panel, the disclosure shall be made in immediate proximity to the claim that is printed in the largest type; and

(D) As required in §101.13(j)(2) for relative claims:

(1) The identity of the reference food and the percent (or fraction) that the cholesterol has been reduced are declared in immediate proximity to the most prominent such claim (e.g., 25 percent less cholesterol than _____); and

(2) Quantitative information comparing the level of cholesterol in the product per labeled serving with that of the reference food that it replaces (e.g., “Cholesterol lowered from 55 mg to 30 mg per serving. Contains 13 g of fat per serving.”) is declared adjacent to the most prominent claim or to the nutrition label, except that if the nutrition label is on the information panel, the quantitative information may be located elsewhere on the information panel in accordance with §101.2.

(iii) Claims described in paragraph (d)(4) of this section may not be made on the label or in labeling of a food if the nutrient content of the reference food meets the definition for “low cholesterol.”

(5) The terms defined in paragraph (d)(4) of this section may be used on the label or in the labeling of meal products as defined in §101.13(l) and main dish products as defined in §101.13(m), provided that:

(i) For meal products that contain 26.0 g or less of total fat per labeled serving or for main dish products that contain 19.5 g or less of total fat per labeled serving;

(A) The food has been specifically formulated, altered, or processed to reduce its cholesterol by 25 percent or

more from the reference food it resembles as defined in §101.13(j)(1) and for which it substitutes as specified in §101.13(d) that has a significant (e.g., 5 percent or more of a national or regional market) market share;

(B) The food contains 2 g or less of saturated fatty acids per 100 g; and

(C) As required in §101.13(j)(2) for relative claims:

(1) The identity of the reference food, and the percent (or fraction) that the cholesterol has been reduced are declared in immediate proximity to the most prominent such claim (e.g., “25% less cholesterol per 3 oz than _____”); and

(2) Quantitative information comparing the level of cholesterol in the product per specified weight with that of the reference food that it replaces (e.g., “Cholesterol content has been reduced from 35 mg per 3 oz to 25 mg per 3 oz.”) is declared adjacent to the most prominent claim or to the nutrition label, except that if the nutrition label is on the information panel, the quantitative information may be located elsewhere on the information panel in accordance with §101.2.

(ii) For meal products that contain more than 26.0 g of total fat per labeled serving or for main dish products that contain more than 19.5 g of total fat per labeled serving:

(A) The food has been specifically formulated, altered, or processed to reduce its cholesterol by 25 percent or more from the reference food it resembles as defined in §101.13(j)(1) and for which it substitutes as specified in §101.13(d) that has a significant (e.g., 5 percent or more of a national or regional market) market share.

(B) The food contains 2 g or less of saturated fatty acids per 100 g;

(C) The label or labeling discloses the level of total fat in a serving (as declared on the label) of the food. Such disclosure shall appear in immediate proximity to such claim preceding any disclosure statement required under §101.13(h) in type that shall be no less than one-half the size of the type used for such claim. If the claim appears on more than one panel the disclosure shall be made on each panel except for the panel that bears nutrition labeling. If the claim is made more than once on

a panel, the disclosure shall be made in immediate proximity to the claim that is printed in the largest type; and

(D) As required in §101.13(j)(2) for relative claims:

(1) The identity of the reference food and the percent (or fraction) that the cholesterol has been reduced are declared in immediate proximity to the most prominent such claim (e.g., 25 percent less cholesterol than _____); and

(2) Quantitative information comparing the level of cholesterol in the product per specified weight with that of the reference food that it replaces (e.g., “Cholesterol lowered from 30 mg to 22 mg per 3 oz of product.”) is declared adjacent to the most prominent claim or to the nutrition label, except that if the nutrition label is on the information panel, the quantitative information may be located elsewhere on the information panel in accordance with §101.2.

(iii) Claims described in paragraph (d)(5) of this section may not be made on the label or in the labeling of a food if the nutrient content of the reference food meets the definition for “low cholesterol.”

(e) “Lean” and “extra lean” claims. (1) The term “lean” may be used on the label or in labeling of foods except meal products as defined in §101.13(l) and main dish products as defined in §101.13(m) provided that the food is a seafood or game meat product and as packaged contains less than 10 g total fat, 4.5 g or less saturated fat, and less than 95 mg cholesterol per reference amount customarily consumed and per 100 g;

(2) The term defined in paragraph (e)(1) of this section may be used on the label or in labeling of a mixed dish not measurable with a cup as defined in §101.12(b) in table 2, provided that the food contains less than 8 g total fat, 3.5 g or less saturated fat and less than 80 mg cholesterol per reference amount customarily consumed;

(3) The term defined in paragraph (e)(1) of this section may be used on the label or in the labeling of meal products as defined in §101.13(l) or main dish products as defined in §101.13(m) provided that the food contains less

than 10 g total fat, 4.5 g or less saturated fat, and less than 95 mg cholesterol per 100 g and per labeled serving;

(4) The term “extra lean” may be used on the label or in the labeling of foods except meal products as defined in §101.13(l) and main dish products as defined in §101.13(m) provided that the food is a discrete seafood or game meat product and as packaged contains less than 5 g total fat, less than 2 g saturated fat, and less than 95 mg cholesterol per reference amount customarily consumed and per 100 g; and

(5) The term defined in paragraph (e)(4) of this section may be used on the label or in labeling of meal products as defined in §101.13(l) and main dish products as defined in §101.13(m) provided that the food contains less than 5 g of fat, less than 2 g of saturated fat, and less than 95 mg of cholesterol per 100 g and per labeled serving.

(f) *Misbranding.* Any label or labeling containing any statement concerning fat, fatty acids, or cholesterol that is not in conformity with this section shall be deemed to be misbranded under sections 201(n), 403(a), and 403(r) of the Federal Food, Drug, and Cosmetic Act.

[58 FR 2413, Jan. 6, 1993; 58 FR 17342, 17343, Apr. 2, 1993, as amended at 58 FR 44032, Aug. 18, 1993; 58 FR 60105, Nov. 15, 1993; 59 FR 394, Jan. 4, 1994; 60 FR 17207, Apr. 5, 1995; 61 FR 59001, Nov. 20, 1996; 63 FR 26980, May 15, 1998; 72 FR 1459, Jan. 12, 2007]

§ 101.65 Implied nutrient content claims and related label statements.

(a) *General requirements.* An implied nutrient content claim can only be made on the label and in labeling of the food if:

(1) The claim uses one of the terms described in this section in accordance with the definition for that term;

(2) The claim is made in accordance with the general requirements for nutrient content claims in §101.13; and

(3) The food for which the claim is made is labeled in accordance with §101.9, §101.10, or §101.36, as applicable.

(b) *Label statements that are not implied claims.* Certain label statements about the nature of a product are not nutrient content claims unless such statements are made in a context that would make them an implied claim

under §101.13(b)(2). The following types of label statements are generally not implied nutrient content claims and, as such, are not subject to the requirements of §101.13 and this section:

(1) A claim that a specific ingredient or food component is absent from a product, provided that the purpose of such claim is to facilitate avoidance of the substances because of food allergies (see §105.62 of this chapter), food intolerance, religious beliefs, or dietary practices such as vegetarianism or other nonnutrition related reason, e.g., “100 percent milk free;”

(2) A claim about a substance that is nonnutritive or that does not have a nutritive function, e.g., “contains no preservatives,” “no artificial colors;”

(3) A claim about the presence of an ingredient that is perceived to add value to the product, e.g., “made with real butter,” “made with whole fruit,” or “contains honey,” except that claims about the presence of ingredients other than vitamins or minerals or that are represented as a source of vitamins and minerals are not allowed on labels or in labeling of dietary supplements of vitamins and minerals that are not in conventional food form.

(4) A statement of identity for a food in which an ingredient constitutes essentially 100 percent of a food (e.g., “corn oil,” “oat bran,” “dietary supplement of vitamin C 60 mg tablet”).

(5) A statement of identity that names as a characterizing ingredient, an ingredient associated with a nutrient benefit (e.g., “corn oil margarine,” “oat bran muffins,” or “whole wheat bagels”), unless such claim is made in a context in which label or labeling statements, symbols, vignettes, or other forms of communication suggest that a nutrient is absent or present in a certain amount; and

(6) A label statement made in compliance with a specific provision of part 105 of this chapter, solely to note that a food has special dietary usefulness relative to a physical, physiological, pathological, or other condition, where the claim identifies the special diet of which the food is intended to be a part.

(c) *Particular implied nutrient content claims.* (1) Claims about the food or an ingredient therein that suggest that a nutrient or an ingredient is absent or

§ 101.65

21 CFR Ch. I (4–1–07 Edition)

present in a certain amount (e.g., “high in oat bran”) are implied nutrient content claims and must comply with paragraph (a) of this section.

(2) The phrases “contains the same amount of [nutrient] as a [food]” and “as much [nutrient] as a [food]” may be used on the label or in the labeling of foods, provided that the amount of the nutrient in the reference food is enough to qualify that food as a “good source” of that nutrient, and the labeled food, on a per serving basis, is an equivalent, good source of that nutrient (e.g., “as much fiber as an apple,” “Contains the same amount of Vitamin C as an 8 oz glass of orange juice.”).

(3) Claims may be made that a food contains or is made with an ingredient that is known to contain a particular nutrient, or is prepared in a way that affects the content of a particular nutrient in the food, if the finished food is either “low” in or a “good source” of the nutrient that is associated with the ingredient or type of preparation. If a more specific level is claimed (e.g., “high in _____”), that level of the nutrient must be present in the food. For example, a claim that a food contains oat bran is a claim that it is a good source

of dietary fiber; that a food is made only with vegetable oil is a claim that it is low in saturated fat; and that a food contains no oil is a claim that it is fat free.

(d) *General nutritional claims.* (1) This paragraph covers labeling claims that are implied nutrient content claims because they:

(i) Suggest that a food because of its nutrient content may help consumers maintain healthy dietary practices; and

(ii) Are made in connection with an explicit or implicit claim or statement about a nutrient (e.g., “healthy, contains 3 grams of fat”).

(2) You may use the term “healthy” or related terms (e.g., “health,” “healthful,” “healthfully,” “healthfulness,” “healthier,” “healthiest,” “healthily,” and “healthiness”) as an implied nutrient content claim on the label or in labeling of a food that is useful in creating a diet that is consistent with dietary recommendations if:

(i) The food meets the following conditions for fat, saturated fat, cholesterol, and other nutrients:

If the food is...	The fat level must be...	The saturated fat level must be...	The cholesterol level must be...	The food must contain...
(A) A raw fruit or vegetable	Low fat as defined in § 101.62(b)(2)	Low saturated fat as defined in § 101.62(c)(2)	The disclosure level for cholesterol specified in § 101.13(h) or less	N/A
(B) A single-ingredient or a mixture of frozen or canned fruits and vegetables ¹	Low fat as defined in § 101.62(b)(2)	Low saturated fat as defined in § 101.62(c)(2)	The disclosure level for cholesterol specified in § 101.13(h) or less	N/A
(C) An enriched cereal-grain product that conforms to a standard of identity in part 136, 137 or 139 of this chapter	Low fat as defined in § 101.62(b)(2)	Low saturated fat as defined in § 101.62(c)(2)	The disclosure level for cholesterol specified in § 101.13(h) or less	N/A
(D) A raw, single-ingredient seafood or game meat	Less than 5 grams (g) total fat per RA ² and per 100 g	Less than 2 g saturated fat per RA and per 100 g	Less than 95 mg cholesterol per RA and per 100 g	At least 10 percent of the RDI ³ or the DRV ⁴ per RA of one or more of vitamin A, vitamin C, calcium, iron, protein, or fiber

If the food is...	The fat level must be...	The saturated fat level must be...	The cholesterol level must be...	The food must contain...
(E) A meal product as defined in § 101.13(l) or a main dish product as defined in § 101.13(m)	Low fat as defined in § 101.62(b)(3)	Low saturated fat as defined in § 101.62(c)(3)	90 mg or less cholesterol per LS ⁵	At least 10 percent of the RDI or DRV per LS of two nutrients (for a main dish product) or of three nutrients (for a meal product) of: vitamin A, vitamin C, calcium, iron, protein, or fiber
(F) A food not specifically listed in this table	Low fat as defined in § 101.62(b)(2)	Low saturated fat as defined in § 101.62(c)(2)	The disclosure level for cholesterol specified in § 101.13(h) or less	At least 10 percent of the RDI or the DRV per RA of one or more of vitamin A, vitamin C, calcium, iron, protein or fiber

¹ May include ingredients whose addition does not change the nutrient profile of the fruit or vegetable.
² RA means Reference Amount Customarily Consumed per Eating Occasion (§ 101.12(b)).
³ RDI means Reference Daily Intake (§ 101.9(c)(8)(iv)).
⁴ DRV means Daily Reference Value (§ 101.9(c)(9)).
⁵ LS means Labeled Serving, i.e., the serving size that is specified in the nutrition information on the product label (§ 101.9(b)).

(ii) The food meets the following conditions for sodium:

If the food is...	The sodium level must be...
(A) A food with a RA that is greater than 30 g or 2 tablespoons (tbsp.)	480 mg or less sodium per RA and per LS
(B) A food with a RA that is equal to or less than 30 g or 2 tbsp.	480 mg or less sodium per 50 g ¹
(C) A meal product as defined in § 101.13(l) or a main dish product as defined in § 101.13(m)	600 mg or less sodium per LS

¹ For dehydrated food that is typically reconstituted with water or a liquid that contains insignificant amounts per RA of all nutrients (as defined in § 101.9(f)(1)), the 50 g refers to the "prepared" form of the product.

(iii) The food complies with the definition and declaration requirements in this part 101 for any specific nutrient content claim on the label or in labeling, and

(iv) If you add a nutrient to the food specified in paragraphs (d)(2)(i)(D), (d)(2)(i)(E), or (d)(2)(i)(F) of this section to meet the 10 percent requirement, that addition must be in accordance with the fortification policy for foods in § 104.20 of this chapter.

[58 FR 2413, Jan. 6, 1993; 58 FR 17343, Apr. 2, 1993, as amended at 59 FR 394, Jan. 4, 1994; 59 FR 24249, May 10, 1994; 59 FR 50828, Oct. 6, 1994; 62 FR 49858, Sept. 23, 1997; 63 FR 14355, Mar. 25, 1998; 70 FR 56848, Sept. 29, 2005]

§ 101.67 Use of nutrient content claims for butter.

(a) Claims may be made to characterize the level of nutrients, including fat, in butter if:

(1) The claim complies with the requirements of § 101.13 and with the requirements of the regulations in this subpart that define the particular nutrient content claim that is used and how it is to be presented. In determining whether a claim is appropriate, the calculation of the percent fat reduction in milkfat shall be based on the 80 percent milkfat requirement provided by the statutory standard for butter (21 U.S.C. 321a);

(2) The product contains cream or milk, including milk constituents (including, but not limited to, whey, casein, modified whey, and salts of casein), or both, with or without added salt, with or without safe and suitable colorings, with or without nutrients added to comply with paragraph (a)(3) of this section, and with or without safe and suitable bacterial cultures. The product may contain safe and suitable ingredients to improve texture, prevent syneresis, add flavor, extend shelf life, improve appearance, and add sweetness. The product may contain water to replace milkfat although the amount of water in the product shall be less than the amount of cream, milk, or milk constituents;

(3) The product is not nutritionally inferior, as defined in §101.3(e)(4), to butter as produced under 21 U.S.C. 321a; and

(4) If the product would violate 21 U.S.C. 321a but for the nutrient content claim that characterizes the level of nutrients, that claim shall be an explicit claim that is included as part of the common or usual name of the product.

(b) Deviations from the ingredient provisions of 21 U.S.C. 321a must be the minimum necessary to achieve similar performance characteristics as butter as produced under 21 U.S.C. 321a, or the food will be deemed to be adulterated under section 402(b) of the act. The performance characteristics (e.g., physical properties, organoleptic characteristics, functional properties, shelf life) of the product shall be similar to butter as produced under 21 U.S.C. 321a. If there is a significant difference in performance characteristics (that materially limits the uses of the product compared to butter,) the label shall include a statement informing the consumer of such difference (e.g., if appropriate, “not recommended for baking purposes”). Such statement shall comply with the requirements of §101.13(d). The modified product shall perform at least one of the principal functions of butter substantially as well as butter as produced under 21 U.S.C. 321a.

(c)(1) Each of the ingredients used in the food shall be declared on the label as required by the applicable sections of this part.

(2) Safe and suitable ingredients added to improve texture, prevent syneresis, add flavor, extend shelf life, improve appearance, or add sweetness and water added to replace milkfat shall be identified with an asterisk in the ingredient statement. The statement “*Ingredients not in regular butter” shall immediately follow the ingredient statement in the same type size.

[58 FR 2455, Jan. 6, 1993]

§ 101.69 Petitions for nutrient content claims.

(a) This section pertains to petitions for claims, expressed or implied, that:

(1) Characterize the level of any nutrient which is of the type required to be in the label or labeling of food by

section 403(q)(1) or (q)(2) of the Federal Food, Drug, and Cosmetic Act (the act); and

(2) That are not exempted under section 403(r)(5)(A) through (r)(5)(C) of the act from the requirements for such claims in section 403(r)(2).

(b) Petitions included in this section are:

(1) Petitions for a new (heretofore unauthorized) nutrient content claim;

(2) Petitions for a synonymous term (i.e., one that is consistent with a term defined by regulation) for characterizing the level of a nutrient; and

(3) Petitions for the use of an implied claim in a brand name.

(c) An original and one copy of the petition to be filed under the provisions of section 403(r)(4) of the act shall be submitted, or the petitioner may submit an original and a computer readable disk containing the petition. Contents of the disk should be in a standard format, such as ASCII format. Petitioners interested in submitting a disk should contact the Food and Drug Administration’s (FDA) Center for Food Safety and Applied Nutrition for details. If any part of the material submitted is in a foreign language, it shall be accompanied by an accurate and complete English translation. The petition shall state the petitioner’s post office address to which published notices as required by section 403 of the act may be sent.

(d) Pertinent information may be incorporated in, and will be considered as part of, a petition on the basis of specific reference to such information submitted to and retained in the files of FDA. However, any reference to unpublished information furnished by a person other than the applicant will not be considered unless use of such information is authorized (with the understanding that such information may in whole or part be subject to release to the public) in a written statement signed by the person who submitted it. Any reference to published information should be accompanied by reprints or photostatic copies of such references.

(e) If nonclinical laboratory studies are included in a petition submitted under section 403(r)(4) of the act, the petition shall include, with respect to each nonclinical study contained in the

petition, either a statement that the study has been, or will be, conducted in compliance with the good laboratory practice regulations as set forth in part 58 of this chapter or, if any such study was not conducted in compliance with such regulations, a brief statement of the reason for the noncompliance.

(f) If clinical investigations are included in a petition submitted under section 403(r)(4) of the act, the petition shall include a statement regarding each such clinical investigation relied upon in the petition that the study either was conducted in compliance with the requirements for institutional review set forth in part 56 of this chapter or was not subject to such requirements in accordance with §56.104 or §56.105 of this chapter, and that it was conducted in compliance with the requirements for informed consent set forth in part 50 of this chapter.

(g) The availability for public disclosure of petitions submitted to the agency under this section will be governed by the rules specified in §10.20(j) of this chapter.

(h) All petitions submitted under this section shall include either a claim for a categorical exclusion under §25.30 or 25.32 of this chapter or an environmental assessment under §25.40 of this chapter.

(i) The data specified under the several lettered headings should be submitted on separate sheets or sets of sheets, suitably identified. If such data have already been submitted with an earlier application from the petitioner, the present petition may incorporate it by specific reference to the earlier petition.

(j) The petition must be signed by the petitioner or by his attorney or agent, or (if a corporation) by an authorized official.

(k) The petition shall include a statement signed by the person responsible for the petition, that to the best of his knowledge, it is a representative and balanced submission that includes unfavorable information, as well as favorable information, known to him pertinent to the evaluation of the petition.

(l) All applicable provisions of part 10—Administrative Practices and Procedures, may be used by FDA, the petitioner or any outside party with re-

spect to any agency action on the petition.

(m)(1) Petitions for a new nutrient content claim shall include the following data and be submitted in the following form.

(Date) _____
 Name of petitioner _____
 Post office address _____
 Subject of the petition _____
 Office of Nutritional Products, Labeling and
 Dietary Supplements (HFS-800)
 Food and Drug Administration,
 Department of Health and Human Services,
 Washington, DC 20204.

To Whom It May Concern:

The undersigned, _____
 submits this petition under section 403(r)(4)
 of the Federal Food, Drug, and Cosmetic Act
 (the act) with respect to (statement of the
 claim and its proposed use).

Attached hereto and constituting a part of
 this petition, are the following:

A. A statement identifying the descriptive
 term and the nutrient that the term is in-
 tended to characterize with respect to the
 level of such nutrient. The statement should
 address why the use of the term as proposed
 will not be misleading. The statement should
 provide examples of the nutrient content
 claim as it will be used on labels or labeling,
 as well as the types of foods on which the
 claim will be used. The statement shall
 specify the level at which the nutrient must
 be present or what other conditions con-
 cerning the food must be met for the use of
 the term in labels or labeling to be appro-
 priate, as well as any factors that would
 make the use of the term inappropriate.

B. A detailed explanation, supported by
 any necessary data, of why use of the food
 component characterized by the claim is of
 importance in human nutrition by virtue of
 its presence or absence at the levels that
 such claim would describe. This explanation
 shall also state what nutritional benefit to
 the public will derive from use of the claim
 as proposed, and why such benefit is not
 available through the use of existing terms
 defined by regulation under section
 403(r)(2)(A)(i) of the act. If the claim is in-
 tended for a specific group within the popu-
 lation, the analysis should specifically ad-
 dress nutritional needs of such group, and
 should include scientific data sufficient for
 such purpose.

C. Analytical data that shows the amount
 of the nutrient that is the subject of the
 claim and that is present in the types of
 foods for which the claim is intended. The
 assays should be performed on representative
 samples using the AOAC INTERNATIONAL
 (AOAC International) methods where avail-
 able. If no AOAC International method is
 available, the petitioner shall submit the

assay method used, and data establishing the validity of the method for assaying the nutrient in the particular food. The validation data should include a statistical analysis of the analytical and product variability.

D. A detailed analysis of the potential effect of the use of the proposed claim on food consumption and of any corresponding changes in nutrient intake. The latter item shall specifically address the intake of nutrients that have beneficial and negative consequences in the total diet. If the claim is intended for a specific group within the population, the above analysis shall specifically address the dietary practices of such group and shall include data sufficient to demonstrate that the dietary analysis is representative of such group.

E. The petitioner is required to submit either a claim for categorical exclusion under §25.30 or §25.32 of this chapter or an environmental assessment under §25.40 of this chapter.

Yours very truly,
 Petitioner _____
 By _____
 (Indicate authority)

(2) Within 15 days of receipt of the petition, the petitioner will be notified by letter of the date on which the petition was received by the agency. Such notice will inform the petitioner:

(i) That the petition is undergoing agency review (in which case a docket number will be assigned to the petition), and the petitioner will subsequently be notified of the agency's decision to file or deny the petition; or

(ii) That the petition is incomplete, e.g., it lacks any of the data required by this part, it presents such data in a manner that is not readily understood, or it has not been submitted in quadruplicate, in which case the petition will be denied, and the petitioner will be notified as to what respect the petition is incomplete.

(3) Within 100 days of the date of receipt of the petition, FDA will notify the petitioner by letter that the petition has either been filed or denied. If denied, the notification shall state the reasons therefor. If filed, the date of the notification letter becomes the date of filing for the purposes of section 403(r)(4)(A)(i) of the act. If FDA does not act within such 100 days, the petition shall be deemed to be denied unless an extension is mutually agreed upon by the FDA and the petitioner. A petition that has been denied, or has been deemed to be denied, without fil-

ing shall not be made available to the public. A filed petition shall be available to the public as provided under paragraph (g) of this section.

(4) Within 90 days of the date of filing FDA will by letter of notification to the petitioner:

(i) Deny the petition; or

(ii) Inform the petitioner that a proposed regulation to provide for the requested use of the new term will be published in the FEDERAL REGISTER. FDA will publish the proposal to amend the regulations to provide for the requested use of the nutrient content claim in the FEDERAL REGISTER within 90 days of the date of filing. The proposal will also announce the availability of the petition for public disclosure.

(iii) If FDA does not act within 90 days of the date of filing, the petition shall be deemed to be denied unless an extension is mutually agreed upon by FDA and the petitioner.

(5) If FDA issues a proposal, the rule-making shall be completed within 540 days of the date of receipt of the petition.

(n)(1) Petitions for a synonymous term shall include the following data and be submitted in the following form.

(Date) _____
 Name of petitioner _____
 Post office address _____
 Subject of the petition _____
 Office of Nutritional Products, Labeling and Dietary Supplements (HFS-800)
 Food and Drug Administration,
 Department of Health and Human Services,
 Washington, DC 20204.

To Whom It May Concern:

The undersigned, _____ submits this petition under section 403(r)(4) of the Federal Food, Drug, and Cosmetic Act (the act) with respect to (statement of the synonymous term and its proposed use in a nutrient content claim that is consistent with an existing term that has been defined under section 403(r)(2) of the act).

Attached hereto and constituting a part of this petition, are the following:

A. A statement identifying the synonymous descriptive term, the existing term defined by a regulation under section 403(r)(2)(A)(i) of the act with which the synonymous term is claimed to be consistent. The statement should address why the proposed synonymous term is consistent with the term already defined by the agency, and why the use of the synonymous term as proposed will not be misleading. The statement

should provide examples of the nutrient content claim as it will be used on labels or labeling, as well as the types of foods on which the claim will be used. The statement shall specify whether any limitations not applicable to the use of the defined term are intended to apply to the use of the synonymous term.

B. A detailed explanation, supported by any necessary data, of why use of the proposed term is requested, including an explanation of whether the existing defined term is inadequate for the purpose of effectively characterizing the level of a nutrient. This item shall also state what nutritional benefit to the public will derive from use of the claim as proposed, and why such benefit is not available through the use of existing term defined by regulation. If the claim is intended for a specific group within the population, the analysis should specifically address nutritional needs of such group, and should include scientific data sufficient for such purpose.

C. The petitioner is required to submit either a claim for categorical exclusion under § 25.30 or § 25.32 of this chapter or an environmental assessment under § 25.40 of this chapter.

Yours very truly,
 Petitioner _____
 By _____
 (Indicate authority)

(2) Within 15 days of receipt of the petition the petitioner will be notified by letter of the date on which the petition was received. Such notice will inform the petitioner:

(i) That the petition is undergoing agency review (in which case a docket number will be assigned to the petition) and the petitioner will subsequently be notified of the agency's decision to grant the petitioner permission to use the proposed term or to deny the petition; or

(ii) That the petition is incomplete, e.g., it lacks any of the data required by this part, it presents such data in a manner that is not readily understood, or it has not been submitted in quadruplicate, in which case the petition will be denied, and the petitioner will be notified as to what respect the petition is incomplete.

(3) Within 90 days of the date of receipt of the petition that is accepted for review (i.e., that has not been found to be incomplete and consequently denied, FDA will notify the petitioner by letter of the agency's decision to grant the petitioner permission to use the proposed term, with any conditions or

limitations on such use specified, or to deny the petition, in which case the letter shall state the reasons therefor. Failure of the petition to fully address the requirements of this section shall be grounds for denial of the petition.

(4) As soon as practicable following the agency's decision to either grant or deny the petition, FDA will publish a notice in the FEDERAL REGISTER informing the public of his decision. If the petition is granted the Food and Drug Administration will list, the approved synonymous term in the regulations listing terms permitted for use in nutrient content claims.

(o)(1) Petitions for the use of an implied nutrient content claim in a brand name shall include the following data and be submitted in the following form:

(Date) _____
 Name of petitioner _____
 Post office address _____
 Subject of the petition _____
 Office of Nutritional Products, Labeling and Dietary Supplements (HFS-800),
 Food and Drug Administration,
 Department of Health and Human Services,
 Washington, DC 20204.
 To Whom It May Concern:

The undersigned, _____ submits this petition under section 403(r)(4) of the Federal Food, Drug, and Cosmetic Act (the act) with respect to (statement of the implied nutrient content claim and its proposed use in a brand name).

Attached hereto and constituting a part of this petition, are the following:

A. A statement identifying the implied nutrient content claim, the nutrient the claim is intended to characterize, the corresponding term for characterizing the level of such nutrient as defined by a regulation under section 403(r)(2)(A)(i) of the act, and the brand name of which the implied claim is intended to be a part. The statement should address why the use of the brandname as proposed will not be misleading. It should address in particular what information is required to accompany the claim or other ways in which the claim meets the requirements of sections 201(n) and 403(a) of the act. The statement should provide examples of the types of foods on which the brand name will appear. It shall also include data showing that the actual level of the nutrient in the food qualifies the food to bear the corresponding term defined by regulation. Assay methods used to determine the level of a nutrient should meet the requirements stated under petition format item C in paragraph (k)(1) of this section.

§ 101.70

21 CFR Ch. I (4-1-07 Edition)

B. A detailed explanation, supported by any necessary data, of why use of the proposed brand name is requested. This item shall also state what nutritional benefit to the public will derive from use of the brand name as proposed. If the branded product is intended for a specific group within the population, the analysis should specifically address nutritional needs of such group and should include scientific data sufficient for such purpose.

C. The petitioner is required to submit either a claim for categorical exclusion under § 25.30 or § 25.32 of this chapter or an environmental assessment under § 25.40 of this chapter.

Yours very truly,
Petitioner _____
By _____

(2) Within 15 days of receipt of the petition the petitioner will be notified by letter of the date on which the petition was received. Such notice will inform the petitioner:

(i) That the petition is undergoing agency review (in which case a docket number will be assigned to the petition); or

(ii) That the petition is incomplete, e.g., it lacks any of the data required by this part, it presents such data in a manner that is not readily understood, or it has not been submitted in quadruplicate, in which case the petition will be denied, and the petitioner will be notified as to what respect the petition is incomplete.

(3) FDA will publish a notice of the petition in the FEDERAL REGISTER announcing its availability to the public and seeking comment on the petition. The petition shall be available to the public to the extent provided under paragraph (g) of this section. The notice shall allow 30 days for comments.

(4) Within 100 days of the date of receipt of the petition that is accepted for review (i.e., that has not been found to be incomplete and subsequently returned to the petitioner), FDA will:

(i) Notify the petitioner by letter of the agency's decision to grant the petitioner permission to use the proposed brand name if such use is not misleading, with any conditions or limitations on such use specified; or

(ii) Deny the petition, in which case the letter shall state the reasons therefor. Failure of the petition to fully address the requirements of this section shall be grounds for denial of the peti-

tion. Should FDA not notify the petitioner of his decision on the petition within 100 days, the petition shall be considered to be granted.

(5) As soon as practicable following the granting of a petition, the Commissioner of Food and Drugs will publish a notice in the FEDERAL REGISTER informing the public of such fact.

[58 FR 2413, Jan. 6, 1993; 58 FR 17343, Apr. 2, 1993, as amended at 58 FR 44033, Aug. 18, 1993; 62 FR 40598, July 29, 1997; 63 FR 26718, May 14, 1998; 63 FR 40024, July 27, 1998; 67 FR 9585, Mar. 4, 2002; 69 FR 16481, Mar. 30, 2004]

Subpart E—Specific Requirements for Health Claims

§ 101.70 Petitions for health claims.

(a) Any interested person may petition the Food and Drug Administration (FDA) to issue a regulation regarding a health claim. An original and one copy of the petition shall be submitted, or the petitioner may submit an original and a computer readable disk containing the petition. Contents of the disk should be in a standard format, such as ASCII format. (Petitioners interested in submitting a disk should contact the Center for Food Safety and Applied Nutrition for details.) If any part of the material submitted is in a foreign language, it shall be accompanied by an accurate and complete English translation. The petition shall state the petitioner's post office address to which any correspondence required by section 403 of the Federal Food, Drug, and Cosmetic Act may be sent.

(b) Pertinent information may be incorporated in, and will be considered as part of, a petition on the basis of specific reference to such information submitted to and retained in the files of FDA. Such information may include any findings, along with the basis of the findings, of an outside panel with expertise in the subject area. Any reference to published information shall be accompanied by reprints, or easily readable copies of such information.

(c) If nonclinical laboratory studies are included in a petition, the petition shall include, with respect to each nonclinical study contained in the petition, either a statement that the study has been conducted in compliance with

the good laboratory practice regulations as set forth in part 58 of this chapter, or, if any such study was not conducted in compliance with such regulations, a brief statement of the reason for the noncompliance.

(d) If clinical or other human investigations are included in a petition, the petition shall include a statement that they were either conducted in compliance with the requirements for institutional review set forth in part 56 of this chapter, or were not subject to such requirements in accordance with §56.104 or §56.105, and a statement that they were conducted in compliance with the requirements for informed consent set forth in part 50 of this chapter.

(e) All data and information in a health claim petition are available for public disclosure after the notice of filing of petition is issued to the petitioner, except that clinical investigation reports, adverse reaction reports, product experience reports, consumer complaints, and other similar data and information shall only be available after deletion of:

(1) Names and any information that would identify the person using the product.

(2) Names and any information that would identify any third party involved with the report, such as a physician or hospital or other institution.

(f) Petitions for a health claim shall include the following data and be submitted in the following form:

(Date) _____
 Name of petitioner _____
 Post office address _____
 Subject of the petition _____
 Food and Drug Administration,
 Office of Nutritional Products, Labeling and
 Dietary Supplements (HFS-800),
 5100 Paint Branch Pkwy.,
 College Park, MD 20740,

The undersigned, _____ submits this petition pursuant to section 403(r)(4) or 403(r)(5)(D) of the Federal Food, Drug, and Cosmetic Act with respect to (statement of the substance and its health claim).

Attached hereto, and constituting a part of this petition, are the following:

A. Preliminary requirements. A complete explanation of how the substance conforms to the requirements of §101.14(b) (21 CFR 101.14(b)). For petitions where the subject substance is a food ingredient or a component of a food ingredient, the petitioner should compile a comprehensive list of the

specific ingredients that will be added to the food to supply the substance in the food bearing the health claim. For each such ingredient listed, the petitioner should state how the ingredient complies with the requirements of §101.14(b)(3)(ii), e.g., that its use is generally recognized as safe (GRAS), listed as a food additive, or authorized by a prior sanction issued by the agency, and what the basis is for the GRAS claim, the food additive status, or prior sanctioned status.

B. Summary of scientific data. The summary of scientific data provides the basis upon which authorizing a health claim can be justified as providing the health benefit. The summary must establish that, based on the totality of publicly available scientific evidence (including evidence from well-designed studies conducted in a manner which is consistent with generally recognized scientific procedures and principles), there is significant scientific agreement among experts qualified by scientific training and experience to evaluate such claims, that the claim is supported by such evidence.

The summary shall state what public health benefit will derive from use of the claim as proposed. If the claim is intended for a specific group within the population, the summary shall specifically address nutritional needs of such group and shall include scientific data showing how the claim is likely to assist in meeting such needs.

The summary shall concentrate on the findings of appropriate review articles, National Institutes of Health consensus development conferences, and other appropriate resource materials. Issues addressed in the summary shall include answers to such questions as:

1. Is there an optimum level of the particular substance to be consumed beyond which no benefit would be expected?
2. Is there any level at which an adverse effect from the substance or from foods containing the substance occurs for any segment of the population?
3. Are there certain populations that must receive special consideration?
4. What other nutritional or health factors (both positive and negative) are important to consider when consuming the substance?

In addition, the summary of scientific data shall include a detailed analysis of the potential effect of the use of the proposed claim on food consumption, specifically any change due to significant alterations in eating habits and corresponding changes in nutrient intake resulting from such changes in food consumption. The latter item shall specifically address the effect on the intake of nutrients that have beneficial and negative consequences in the total diet.

If the claim is intended for a significant subpopulation within the general U.S. population, the analysis shall specifically address

the dietary practices of such group, and shall include data sufficient to demonstrate that the dietary analysis is representative of such group (e.g., adolescents or the elderly).

If appropriate, the petition shall explain the prevalence of the disease or health-related condition in the U.S. population and the relevance of the claim in the context of the total daily diet.

Also, the summary shall demonstrate that the substance that is the subject of the proposed claim conforms to the definition of the term “substance” in §101.14(a)(2).

C. Analytical data that show the amount of the substance that is present in representative foods that would be candidates to bear the claim should be obtained from representative samples using methods from the AOAC INTERNATIONAL (AOAC), where available. If no AOAC method is available, the petitioner shall submit the assay method used and data establishing the validity of the method for assaying the substance in food. The validation data should include a statistical analysis of the analytical and product variability.

D. Model health claim. One or more model health claims that represent label statements that may be used on a food label or in labeling for a food to characterize the relationship between the substance in a food to a disease or health-related condition that is justified by the summary of scientific data provided in section C of the petition. The model health claim shall include:

1. A brief capsulized statement of the relevant conclusions of the summary, and
2. A statement of how this substance helps the consumer to attain a total dietary pattern or goal associated with the health benefit that is provided.

E. The petition shall include the following attachments:

1. Copies of any computer literature searches done by the petitioner (e.g., Medline).
2. Copies of articles cited in the literature searches and other information as follows:
 - a. All information relied upon for the support of the health claim, including copies of publications or other information cited in review articles and used to perform meta-analyses.
 - b. All information concerning adverse consequences to any segment of the population (e.g., sensitivity to the substance).
 - c. All information pertaining to the U.S. population.

F. The petitioner is required to submit either a claim for categorical exclusion under §25.30 or §25.32 of this chapter or an environmental assessment under §25.40 of this chapter.

Yours very truly,
 Petitioner _____
 By _____
 (Indicate authority)

(g) The data specified under the several lettered headings should be submitted on separate pages or sets of pages, suitably identified. If such data have already been submitted with an earlier application from the petitioner or any other final petition, the present petition may incorporate it by specific reference to the earlier petition.

(h) The petition shall include a statement signed by the person responsible for the petition that, to the best of his/her knowledge, it is a representative and balanced submission that includes unfavorable information as well as favorable information, known to him/her to be pertinent to the evaluation of the proposed health claim.

(i) The petition shall be signed by the petitioner or by his/her attorney or agent, or (if a corporation) by an authorized official.

(j) *Agency action on the petition.* (1) Within 15 days of receipt of the petition, the petitioner will be notified by letter of the date on which the petition was received. Such notice will inform the petitioner that the petition is undergoing agency review and that the petitioner will subsequently be notified of the agency’s decision to file for comprehensive review or deny the petition.

(2) Within 100 days of the date of receipt of the petition, FDA will notify the petitioner by letter that the petition has either been filed for comprehensive review or denied. The agency will deny a petition without reviewing the information contained in “B. Summary of Scientific Data” if the information in “A. Preliminary Requirements” is inadequate in explaining how the substance conforms to the requirements of §101.14(b). If the petition is denied, the notification will state the reasons therefor, including justification of the rejection of any report from an authoritative scientific body of the U.S. Government. If filed, the date of the notification letter becomes the date of filing for the purposes of this regulation. If FDA does not act within such 100 days, the petition shall be deemed to be denied unless an extension is mutually agreed upon by FDA and the petitioner. A petition that has been denied, or has been deemed to be denied, without filing will not be made available to the public. A filed petition

will be available to the public to the extent provided under paragraph (e) of this section.

(3) Within 90 days of the date of filing, FDA will by letter of notification to the petitioner:

(i) Deny the petition, or

(ii) Inform the petitioner that a proposed regulation to provide for the requested use of the health claim will be published in the FEDERAL REGISTER. If the petition is denied, the notification will state the reasons therefor, including justification for the rejection of any report from an authoritative scientific body of the U.S. Government. FDA will publish the proposal to amend the regulations to provide for the requested use of the health claim in the FEDERAL REGISTER within 90 days of the date of filing. The proposal will also announce the availability of the petition for public review.

(iii) If FDA does not act within 90 days of the date of filing, the petition shall be deemed to be denied unless an extension is mutually agreed upon by FDA and the petitioner.

(4)(i) Within 270 of the date of publication of the proposal, FDA will publish a final rule that either authorizes use of the health claim or explains why the agency has decided not to authorize one.

(ii) For cause, FDA may extend, no more than twice, the period in which it will publish a final rule; each such extension will be for no more than 90 days. FDA will publish a notice of each extension in the FEDERAL REGISTER. The document will state the basis for the extension, the length of the extension, and the date by which the final rule will be published, which date shall be within 540 days of the date of receipt of the petition.

[58 FR 2534, Jan. 6, 1993; 58 FR 17097, Apr. 1, 1993, as amended at 59 FR 425, Jan. 4, 1994; 62 FR 28232, May 22, 1997; 62 FR 40599, July 29, 1997; 63 FR 26719, May 14, 1998; 63 FR 40024, July 27, 1998; 66 FR 56035, Nov. 6, 2001]

§ 101.71 Health claims: claims not authorized.

Health claims not authorized for foods in conventional food form or for dietary supplements of vitamins, minerals, herbs, or other similar substances:

(a) Dietary fiber and cardiovascular disease.

(b) Zinc and immune function in the elderly.

[58 FR 2534, Jan. 6, 1993, as amended at 58 FR 2548, 2578, 2620, 2639, 2664, 2714, Jan. 6, 1993; 58 FR 17100, Apr. 1, 1993; 59 FR 437, Jan. 4, 1994; 65 FR 58918, Oct. 3, 2000]

§ 101.72 Health claims: calcium and osteoporosis.

(a) *Relationship between calcium and osteoporosis.* An inadequate calcium intake contributes to low peak bone mass and has been identified as one of many risk factors in the development of osteoporosis. Peak bone mass is the total quantity of bone present at maturity, and experts believe that it has the greatest bearing on whether a person will be at risk of developing osteoporosis and related bone fractures later in life. Another factor that influences total bone mass and susceptibility to osteoporosis is the rate of bone loss after skeletal maturity. An adequate intake of calcium is thought to exert a positive effect during adolescence and early adulthood in optimizing the amount of bone that is laid down. However, the upper limit of peak bone mass is genetically determined. The mechanism through which an adequate calcium intake and optimal peak bone mass reduce the risk of osteoporosis is thought to be as follows. All persons lose bone with age. Hence, those with higher bone mass at maturity take longer to reach the critically reduced mass at which bones can fracture easily. The rate of bone loss after skeletal maturity also influences the amount of bone present at old age and can influence an individual's risk of developing osteoporosis. Maintenance of an adequate intake of calcium later in life is thought to be important in reducing the rate of bone loss particularly in the elderly and in women during the first decade following menopause.

(b) *Significance of calcium.* Calcium intake is not the only recognized risk factor in the development of osteoporosis, a multifactorial bone disease. Other factors including a person's sex, race, hormonal status, family history, body stature, level of exercise, general diet, and specific life style

choices such as smoking and excess alcohol consumption affect the risk of osteoporosis.

(1) Heredity and being female are two key factors identifying those individuals at risk for the development of osteoporosis. Hereditary risk factors include race: Notably, Caucasians and Asians are characterized by low peak bone mass at maturity. Caucasian women, particularly those of northern European ancestry, experience the highest incidence of osteoporosis-related bone fracture. American women of African heritage are characterized by the highest peak bone mass and lowest incidence of osteoporotic fracture, despite the fact that they have low calcium intake.

(2) Maintenance of an adequate intake of calcium throughout life is particularly important for a subpopulation of individuals at greatest risk of developing osteoporosis and for whom adequate dietary calcium intake may have the most important beneficial effects on bone health. This target subpopulation includes adolescent and young adult Caucasian and Asian American women.

(c) *Requirements.* (1) All requirements set forth in §101.14 shall be met.

(2) *Specific requirements*—(i) *Nature of the claim.* A health claim associating calcium with a reduced risk of osteoporosis may be made on the label or labeling of a food described in paragraph (c)(2)(ii) of this section, provided that:

(A) The claim makes clear that adequate calcium intake throughout life is not the only recognized risk factor in this multifactorial bone disease by listing specific factors, including sex, race, and age that place persons at risk of developing osteoporosis and stating that an adequate level of exercise and a healthful diet are also needed;

(B) The claim does not state or imply that the risk of osteoporosis is equally applicable to the general United States population. The claim shall identify the populations at particular risk for the development of osteoporosis. These populations include white (or the term “Caucasian”) women and Asian women in their bone forming years (approximately 11 to 35 years of age or the phrase “during teen or early adult

years” may be used). The claim may also identify menopausal (or the term “middle-aged”) women, persons with a family history of the disease, and elderly (or “older”) men and women as being at risk;

(C) The claim states that adequate calcium intake throughout life is linked to reduced risk of osteoporosis through the mechanism of optimizing peak bone mass during adolescence and early adulthood. The phrase “build and maintain good bone health” may be used to convey the concept of optimizing peak bone mass. When reference is made to persons with a family history of the disease, menopausal women, and elderly men and women, the claim may also state that adequate calcium intake is linked to reduced risk of osteoporosis through the mechanism of slowing the rate of bone loss;

(D) The claim does not attribute any degree of reduction in risk of osteoporosis to maintaining an adequate calcium intake throughout life; and

(E) The claim states that a total dietary intake greater than 200 percent of the recommended daily intake (2,000 milligrams (mg) of calcium) has no further known benefit to bone health. This requirement does not apply to foods that contain less than 40 percent of the recommended daily intake of 1,000 mg of calcium per day or 400 mg of calcium per reference amount customarily consumed as defined in §101.12 (b) or per total daily recommended supplement intake.

(ii) *Nature of the food.* (A) The food shall meet or exceed the requirements for a “high” level of calcium as defined in §101.54(b);

(B) The calcium content of the product shall be assimilable;

(C) Dietary supplements shall meet the United States Pharmacopeia (U.S.P.) standards for disintegration and dissolution applicable to their component calcium salts, except that dietary supplements for which no U.S.P. standards exist shall exhibit appropriate assimilability under the conditions of use stated on the product label;

(D) A food or total daily recommended supplement intake shall not

contain more phosphorus than calcium on a weight per weight basis.

(d) *Optional information.* (1) The claim may include information from paragraphs (a) and (b) of this section.

(2) The claim may include information on the number of people in the United States who have osteoporosis. The sources of this information must be identified, and it must be current information from the National Center for Health Statistics, the National Institutes of Health, or "Dietary Guidelines for Americans."

(e) *Model health claim.* The following model health claims may be used in food labeling to describe the relationship between calcium and osteoporosis:

MODEL HEALTH CLAIM APPROPRIATE FOR
MOST CONVENTIONAL FOODS:

Regular exercise and a healthy diet with enough calcium helps teen and young adult white and Asian women maintain good bone health and may reduce their high risk of osteoporosis later in life.

MODEL HEALTH CLAIM APPROPRIATE FOR
FOODS EXCEPTIONALLY HIGH IN CALCIUM
AND MOST CALCIUM SUPPLEMENTS:

Regular exercise and a healthy diet with enough calcium helps teen and young adult white and Asian women maintain good bone health and may reduce their high risk of osteoporosis later in life. Adequate calcium intake is important, but daily intakes above about 2,000 mg are not likely to provide any additional benefit.

[58 FR 2676, Jan. 6, 1993; 58 FR 17101, Apr. 1, 1993; 62 FR 15342, Mar. 31, 1997]

§ 101.73 Health claims: dietary lipids and cancer.

(a) *Relationship between fat and cancer.* (1) Cancer is a constellation of more than 100 different diseases, each characterized by the uncontrolled growth and spread of abnormal cells. Cancer has many causes and stages in its development. Both genetic and environmental risk factors may affect the risk of cancer. Risk factors include a family history of a specific type of cancer, cigarette smoking, alcohol consumption, overweight and obesity, ultraviolet or ionizing radiation, exposure to cancer-causing chemicals, and dietary factors.

(2) Among dietary factors, the strongest positive association has been found between total fat intake and risk

of some types of cancer. Based on the totality of the publicly available scientific evidence, there is significant scientific agreement among experts, qualified by training and experience to evaluate such evidence, that diets high in total fat are associated with an increased cancer risk. Research to date, although not conclusive, demonstrates that the total amount of fats, rather than any specific type of fat, is positively associated with cancer risk. The mechanism by which total fat affects cancer has not yet been established.

(3) A question that has been the subject of considerable research is whether the effect of fat on cancer is site-specific. Neither human nor animal studies are consistent in the association of fat intake with specific cancer sites.

(4) Another question that has been raised is whether the association of total fat intake to cancer risk is independently associated with energy intakes, or whether the association of fat with cancer risk is the result of the higher energy (caloric) intake normally associated with high fat intake. FDA has concluded that evidence from both animal and human studies indicates that total fat intake alone, independent of energy intake, is associated with cancer risk.

(b) *Significance of the relationship between fat intake and risk of cancer.* (1) Cancer is ranked as a leading cause of death in the United States. The overall economic costs of cancer, including direct health care costs and losses due to morbidity and mortality, are very high.

(2) U.S. diets tend to be high in fat and high in calories. The average U.S. diet is estimated to contain 36 to 37 percent of calories from total fat. Current dietary guidelines from the Federal Government and other national health professional organizations recommend that dietary fat intake be reduced to a level of 30 percent or less of energy (calories) from total fat. In order to reduce intake of total fat, individuals should choose diets which are high in vegetables, fruits, and grain products (particularly whole grain products), choose lean cuts of meats, fish, and poultry, substitute low-fat dairy products for higher fat products, and use fats and oils sparingly.

(c) *Requirements.* (1) All requirements set forth in § 101.14 shall be met.

(2) *Specific requirements*—(i) *Nature of the claim.* A health claim associating diets low in fat with reduced risk of cancer may be made on the label or labeling of a food described in paragraph (c)(2)(ii) of this section, provided that:

(A) The claim states that diets low in fat “may” or “might” reduce the risk of some cancers;

(B) In specifying the disease, the claim uses the following terms: “some types of cancer” or “some cancers”;

(C) In specifying the nutrient, the claim uses the term “total fat” or “fat”;

(D) The claim does not specify types of fat or fatty acid that may be related to the risk of cancer;

(E) The claim does not attribute any degree of cancer risk reduction to diets low in fat; and

(F) The claim indicates that the development of cancer depends on many factors.

(ii) *Nature of the food.* The food shall meet all of the nutrient content requirements of § 101.62 for a “low fat” food; except that fish and game meats (i.e., deer, bison, rabbit, quail, wild turkey, geese, ostrich) may meet the requirements for “extra lean” in § 101.62.

(d) *Optional information.* (1) The claim may identify one or more of the following risk factors for development of cancer: Family history of a specific type of cancer, cigarette smoking, alcohol consumption, overweight and obesity, ultraviolet or ionizing radiation, exposure to cancer-causing chemicals, and dietary factors.

(2) The claim may include information from paragraphs (a) and (b) of this section which summarize the relationship between dietary fat and cancer and the significance of the relationship.

(3) The claim may indicate that it is consistent with “Nutrition and Your Health: Dietary Guidelines for Americans,” U.S. Department of Agriculture (USDA) and Department of Health and Human Services (DHHS), Government Printing Office.

(4) The claim may include information on the number of people in the United States who have cancer. The sources of this information must be

identified, and it must be current information from the National Center for Health Statistics, the National Institutes of Health, or “Nutrition and Your Health: Dietary Guidelines for Americans,” USDA and DHHS, Government Printing Office.

(e) *Model health claims.* The following model health claims may be used in food labeling to describe the relationship between dietary fat and cancer:

(1) Development of cancer depends on many factors. A diet low in total fat may reduce the risk of some cancers.

(2) Eating a healthful diet low in fat may help reduce the risk of some types of cancers. Development of cancer is associated with many factors, including a family history of the disease, cigarette smoking, and what you eat.

[58 FR 2801, Jan. 6, 1993; 58 FR 17343, Apr. 2, 1993]

§ 101.74 Health claims: sodium and hypertension.

(a) *Relationship between sodium and hypertension (high blood pressure).* (1) Hypertension, or high blood pressure, generally means a systolic blood pressure of greater than 140 millimeters of mercury (mm Hg) or a diastolic blood pressure of greater than 90 mm Hg. Normotension, or normal blood pressure, is a systolic blood pressure below 140 mm Hg and diastolic blood pressure below 90 mm Hg. Sodium is specified here as the chemical entity or electrolyte “sodium” and is distinguished from sodium chloride, or salt, which is 39 percent sodium by weight.

(2) The scientific evidence establishes that diets high in sodium are associated with a high prevalence of hypertension or high blood pressure and with increases in blood pressure with age, and that diets low in sodium are associated with a low prevalence of hypertension or high blood pressure and with a low or no increase of blood pressure with age.

(b) *Significance of sodium in relation to high blood pressure.* (1) High blood pressure is a public health concern primarily because it is a major risk factor for mortality from coronary heart disease and stroke. Early management of high blood pressure is a major public health goal that can assist in reducing mortality associated with coronary

heart disease and stroke. There is a continuum of mortality risk that increases as blood pressures rise. Individuals with high blood pressure are at greatest risk, and individuals with moderately high, high normal, and normal blood pressure are at steadily decreasing risk. The scientific evidence indicates that reducing sodium intake lowers blood pressure and associated risks in many but not all hypertensive individuals. There is also evidence that reducing sodium intake lowers blood pressure and associated risks in many but not all normotensive individuals as well.

(2) The populations at greatest risk for high blood pressure, and those most likely to benefit from sodium reduction, include those with family histories of high blood pressure, the elderly, males because they develop hypertension earlier in life than females, and black males and females. Although some population groups are at greater risk than others, high blood-pressure is a disease of public health concern for all population groups. Sodium intake, alcohol consumption, and obesity are identified risk factors for high blood pressure.

(3) Sodium intakes exceed recommended levels in almost every group in the United States. One of the major public health recommendations relative to high blood pressure is to decrease consumption of salt. On a population-wide basis, reducing the average sodium intake would have a small but significant effect on reducing the average blood pressure, and, consequently, reducing mortality from coronary heart disease and stroke.

(4) Sodium is an essential nutrient, and experts have recommended a safe minimum level of 500 milligrams (mg) sodium per day and an upper level of 2,400 mg sodium per day, the FDA Daily Value for sodium.

(c) *Requirements.* (1) All requirements set forth in §101.14 shall be met.

(2) *Specific requirements*—(i) *Nature of the claim.* A health claim associating diets low in sodium with reduced risk of high blood pressure may be made on the label or labeling of a food described in paragraph (c)(2)(ii) of this section, provided that:

(A) The claim states that diets low in sodium “may” or “might” reduce the risk of high blood pressure;

(B) In specifying the disease, the claim uses the term “high blood pressure”;

(C) In specifying the nutrient, the claim uses the term “sodium”;

(D) The claim does not attribute any degree of reduction in risk of high blood pressure to diets low in sodium; and

(E) The claim indicates that development of high blood pressure depends on many factors.

(ii) *Nature of the food.* The food shall meet all of the nutrient content requirements of §101.61 for a “low sodium” food.

(d) *Optional information.* (1) The claim may identify one or more of the following risk factors for development of high blood pressure in addition to dietary sodium consumption: Family history of high blood pressure, growing older, alcohol consumption, and excess weight.

(2) The claim may include information from paragraphs (a) and (b) of this section, which summarizes the relationship between dietary sodium and high blood pressure and the significance of the relationship.

(3) The claim may include information on the number of people in the United States who have high blood pressure. The sources of this information must be identified, and it must be current information from the National Center for Health Statistics, the National Institutes of Health, or “Nutrition and Your Health: Dietary Guidelines for Americans,” U.S. Department of Health and Human Services (DHHS) and U.S. Department of Agriculture (USDA), Government Printing Office.

(4) The claim may indicate that it is consistent with “Nutrition and Your Health: U.S. Dietary Guidelines for Americans, DHHS and USDA, Government Printing Office.

(5) In specifying the nutrient, the claim may include the term “salt” in addition to the term “sodium.”

(6) In specifying the disease, the claim may include the term “hypertension” in addition to the term “high blood pressure.”

(7) The claim may state that individuals with high blood pressure should consult their physicians for medical advice and treatment. If the claim defines high or normal blood pressure, then the health claim must state that individuals with high blood pressure should consult their physicians for medical advice and treatment.

(e) *Model health claims.* The following are model health claims that may be used in food labeling to describe the relationship between dietary sodium and high blood pressure:

(1) Diets low in sodium may reduce the risk of high blood pressure, a disease associated with many factors.

(2) Development of hypertension or high blood pressure depends on many factors. [This product] can be part of a low sodium, low salt diet that might reduce the risk of hypertension or high blood pressure.

[58 FR 2836, Jan. 6, 1993; 58 FR 17100, Apr. 1, 1993]

§ 101.75 Health claims: dietary saturated fat and cholesterol and risk of coronary heart disease.

(a) *Relationship between dietary saturated fat and cholesterol and risk of coronary heart disease.* (1) Cardiovascular disease means diseases of the heart and circulatory system. Coronary heart disease is the most common and serious form of cardiovascular disease and refers to diseases of the heart muscle and supporting blood vessels. High blood total- and low density lipoprotein (LDL)- cholesterol levels are major modifiable risk factors in the development of coronary heart disease. High coronary heart disease rates occur among people with high blood cholesterol levels of 240 milligrams/deciliter (mg/dL) (6.21 millimoles per liter (mmol/L)) or above and LDL-cholesterol levels of 160 mg/dL (4.13 mmol/L) or above. Borderline high risk blood cholesterol levels range from 200 to 239 mg/dL (5.17 to 6.18 mmol/L) and 130 to 159 mg/dL (3.36 to 4.11 mmol/L) of LDL-cholesterol. Dietary lipids (fats) include fatty acids and cholesterol. Total fat, commonly referred to as fat, is composed of saturated fat (fatty acids containing no double bonds), and monounsaturated and polyunsaturated

fat (fatty acids containing one or more double bonds).

(2) The scientific evidence establishes that diets high in saturated fat and cholesterol are associated with increased levels of blood total- and LDL-cholesterol and, thus, with increased risk of coronary heart disease. Diets low in saturated fat and cholesterol are associated with decreased levels of blood total- and LDL-cholesterol, and thus, with decreased risk of developing coronary heart disease.

(b) *Significance of the relationship between dietary saturated fat and cholesterol and risk of coronary heart disease.*

(1) Coronary heart disease is a major public health concern in the United States, primarily because it accounts for more deaths than any other disease or group of diseases. Early management of risk factors for coronary heart disease is a major public health goal that can assist in reducing risk of coronary heart disease. There is a continuum of mortality risk from coronary heart disease that increases with increasing levels of blood LDL-cholesterol. Individuals with high blood LDL-cholesterol are at greatest risk. A larger number of individuals with more moderately elevated cholesterol also have increased risk of coronary events; such individuals comprise a substantial proportion of the adult U.S. population. The scientific evidence indicates that reducing saturated fat and cholesterol intakes lowers blood LDL-cholesterol and risk of heart disease in most individuals. There is also evidence that reducing saturated fat and cholesterol intakes in persons with blood cholesterol levels in the normal range also reduces risk of heart disease.

(2) Other risk factors for coronary heart disease include a family history of heart disease, high blood pressure, diabetes, cigarette smoking, obesity (body weight 30 percent greater than ideal body weight), and lack of regular physical exercise.

(3) Intakes of saturated fat exceed recommended levels in many people in the United States. Intakes of cholesterol are, on average, at or above recommended levels. One of the major public health recommendations relative to coronary heart disease risk is

to consume less than 10 percent of calories from saturated fat, and an average of 30 percent or less of total calories from all fat. Recommended daily cholesterol intakes are 300 mg or less per day.

(c) *Requirements.* (1) All requirements set forth in §101.14 shall be met.

(2) *Specific requirements—(i) Nature of the claim.* A health claim associating diets low in saturated fat and cholesterol with reduced risk of coronary heart disease may be made on the label or labeling of a food described in paragraph (c)(2)(ii) of this section provided that:

(A) The claim states that diets low in saturated fat and cholesterol “may” or “might” reduce the risk of heart disease;

(B) In specifying the disease, the claim uses the terms “heart disease” or “coronary heart disease;”

(C) In specifying the nutrient, the claim uses the terms “saturated fat” and “cholesterol” and lists both;

(D) The claim does not attribute any degree of risk reduction for coronary heart disease to diets low in dietary saturated fat and cholesterol; and

(E) The claim states that coronary heart disease risk depends on many factors.

(ii) *Nature of the food.* The food shall meet all of the nutrient content requirements of §101.62 for a “low saturated fat,” “low cholesterol,” and “low fat” food; except that fish and game meats (i.e., deer, bison, rabbit, quail, wild turkey, geese, and ostrich) may meet the requirements for “extra lean” in §101.62.

(d) *Optional information.* (1) The claim may identify one or more of the following risk factors in addition to saturated fat and cholesterol about which there is general scientific agreement that they are major risk factors for this disease: A family history of coronary heart disease, elevated blood total and LDL-cholesterol, excess body weight, high blood pressure, cigarette smoking, diabetes, and physical inactivity.

(2) The claim may indicate that the relationship of saturated fat and cholesterol to heart disease is through the intermediate link of “blood chole-

sterol” or “blood total- and LDL cholesterol.”

(3) The claim may include information from paragraphs (a) and (b) of this section, which summarize the relationship between dietary saturated fat and cholesterol and risk of coronary heart disease, and the significance of the relationship.

(4) In specifying the nutrients, the claim may include the term “total fat” in addition to the terms “saturated fat” and “cholesterol”.

(5) The claim may include information on the number of people in the United States who have coronary heart disease. The sources of this information shall be identified, and it shall be current information from the National Center for Health Statistics, the National Institutes of Health, or “Nutrition and Your Health: Dietary Guidelines for Americans,” U.S. Department of Health and Human Services (DHHS) and U.S. Department of Agriculture (USDA), Government Printing Office.

(6) The claim may indicate that it is consistent with “Nutrition and Your Health: Dietary Guidelines for Americans,” DHHS and USDA, Government Printing Office.

(7) The claim may state that individuals with elevated blood total- or LDL-cholesterol should consult their physicians for medical advice and treatment. If the claim defines high or normal blood total- or LDL-cholesterol levels, then the claim shall state that individuals with high blood cholesterol should consult their physicians for medical advice and treatment.

(e) *Model health claims.* The following are model health claims that may be used in food labeling to describe the relationship between dietary saturated fat and cholesterol and risk of heart disease:

(1) While many factors affect heart disease, diets low in saturated fat and cholesterol may reduce the risk of this disease;

(2) Development of heart disease depends upon many factors, but its risk may be reduced by diets low in saturated fat and cholesterol and healthy lifestyles;

(3) Development of heart disease depends upon many factors, including a family history of the disease, high

blood LDL-cholesterol, diabetes, high blood pressure, being overweight, cigarette smoking, lack of exercise, and the type of dietary pattern. A healthful diet low in saturated fat, total fat, and cholesterol, as part of a healthy lifestyle, may lower blood cholesterol levels and may reduce the risk of heart disease;

(4) Many factors, such as a family history of the disease, increased blood- and LDL-cholesterol levels, high blood pressure, cigarette smoking, diabetes, and being overweight, contribute to developing heart disease. A diet low in saturated fat, cholesterol, and total fat may help reduce the risk of heart disease; and

(5) Diets low in saturated fat, cholesterol, and total fat may reduce the risk of heart disease. Heart disease is dependent upon many factors, including diet, a family history of the disease, elevated blood LDL-cholesterol levels, and physical inactivity.

[58 FR 2757, Jan. 6, 1993]

§ 101.76 Health claims: fiber-containing grain products, fruits, and vegetables and cancer.

(a) *Relationship between diets low in fat and high in fiber-containing grain products, fruits, and vegetables and cancer risk.* (1) Cancer is a constellation of more than 100 different diseases, each characterized by the uncontrolled growth and spread of abnormal cells. Cancer has many causes and stages in its development. Both genetic and environmental risk factors may affect the risk of cancer. Risk factors include: A family history of a specific type of cancer, cigarette smoking, overweight and obesity, alcohol consumption, ultraviolet or ionizing radiation, exposure to cancer-causing chemicals, and dietary factors.

(2) The scientific evidence establishes that diets low in fat and high in fiber-containing grain products, fruits, and vegetables are associated with a reduced risk of some types of cancer. Although the specific role of total dietary fiber, fiber components, and the multiple nutrients and other substances contained in these foods are not yet fully understood, many studies have shown that diets low in fat and high in fiber-containing foods are associated

with reduced risk of some types of cancer.

(b) *Significance of the relationship between consumption of diets low in fat and high in fiber-containing grain products, fruits, and vegetables and risk of cancer.*

(1) Cancer is ranked as a leading cause of death in the United States. The overall economic costs of cancer, including direct health care costs and losses due to morbidity and mortality, are very high.

(2) U.S. diets tend to be high in fat and low in grain products, fruits, and vegetables. Studies in various parts of the world indicate that populations who habitually consume a diet high in plant foods have lower risks of some cancers. These diets generally are low in fat and rich in many nutrients, including, but not limited to, dietary fiber. Current dietary guidelines from Federal government agencies and nationally recognized health professional organizations recommend decreased consumption of fats (less than 30 percent of calories), maintenance of desirable body weight, and increased consumption of fruits and vegetables (five or more servings daily), and grain products (six or more servings daily).

(c) *Requirements.* (1) All requirements set forth in § 101.14 shall be met.

(2) *Specific requirements—(i) Nature of the claim.* A health claim associating diets low in fat and high in fiber-containing grain products, fruits, and vegetables with reduced risk of cancer may be made on the label or labeling of a food described in paragraph (c)(2)(ii) of this section, provided that:

(A) The claim states that diets low in fat and high in fiber-containing grain products, fruits, and vegetables “may” or “might” reduce the risk of some cancers;

(B) In specifying the disease, the claim uses the following terms: “some types of cancer,” or “some cancers”;

(C) The claim is limited to grain products, fruits, and vegetables that contain dietary fiber;

(D) The claim indicates that development of cancer depends on many factors;

(E) The claim does not attribute any degree of cancer risk reduction to diets low in fat and high in fiber-containing grain products, fruits, and vegetables;

(F) In specifying the dietary fiber component of the labeled food, the claim uses the term “fiber”, “dietary fiber” or “total dietary fiber”; and

(G) The claim does not specify types of dietary fiber that may be related to risk of cancer.

(ii) *Nature of the food.* (A) The food shall be or shall contain a grain product, fruit, or vegetable.

(B) The food shall meet the nutrient content requirements of §101.62 for a “low fat” food.

(C) The food shall meet, without fortification, the nutrient content requirements of §101.54 for a “good source” of dietary fiber.

(d) *Optional information.* (1) The claim may include information from paragraphs (a) and (b) of this section, which summarize the relationship between diets low in fat and high in fiber-containing grain products, fruits, and vegetables, and some types of cancer and the significance of the relationship.

(2) The claim may identify one or more of the following risk factors for development of cancer: Family history of a specific type of cancer, cigarette smoking, overweight and obesity, alcohol consumption, ultraviolet or ionizing radiation, exposure to cancer causing chemicals, and dietary factors.

(3) The claim may indicate that it is consistent with “Nutrition and Your Health: Dietary Guidelines for Americans,” U.S. Department of Agriculture (USDA) and Department of Health and Human Services (DHHS), Government Printing Office.

(4) The claim may include information on the number of people in the United States who have cancer. The sources of this information must be identified, and it must be current information from the National Center for Health Statistics, the National Institutes of Health, or “Nutrition and Your Health: Dietary Guidelines for Americans,” USDA and DHHS, Government Printing Office.

(e) *Model health claims.* The following model health claims may be used in food labeling to characterize the relationship between diets low in fat and high in fiber-containing grain products, fruits, and vegetables and cancer risk:

(1) Low fat diets rich in fiber-containing grain products, fruits, and vegetables may reduce the risk of some types of cancer, a disease associated with many factors.

(2) Development of cancer depends on many factors. Eating a diet low in fat and high in grain products, fruits, and vegetables that contain dietary fiber may reduce your risk of some cancers.

[58 FR 2548, Jan. 6, 1993]

§ 101.77 Health claims: fruits, vegetables, and grain products that contain fiber, particularly soluble fiber, and risk of coronary heart disease.

(a) *Relationship between diets low in saturated fat and cholesterol and high in fruits, vegetables, and grain products that contain fiber, particularly soluble fiber, and risk of coronary heart disease.* (1) Cardiovascular disease means diseases of the heart and circulatory system. Coronary heart disease is the most common and serious form of cardiovascular disease and refers to diseases of the heart muscle and supporting blood vessels. High blood total- and low density lipoprotein (LDL)- cholesterol levels are major modifiable risk factors in the development of coronary heart disease. High coronary heart disease rates occur among people with high blood cholesterol levels of 240 milligrams per deciliter (mg/dL) (6.21 (mmol/L)) or above and LDL-cholesterol levels of 160 mg/dL (4.13 mmol/L) or above. Borderline high risk blood cholesterol levels range from 200 to 239 mg/dL (5.17 to 6.18 mmol/L) and 130 to 159 mg/dL (3.36 to 4.11 mmol/L) of LDL-cholesterol. Dietary lipids (fats) include fatty acids and cholesterol. Total fat, commonly referred to as fat, is composed of saturated fat (fatty acids containing no double bonds), and monounsaturated and polyunsaturated fat (fatty acids containing one or more double bonds).

(2) The scientific evidence establishes that diets high in saturated fat and cholesterol are associated with increased levels of blood total- and LDL-cholesterol and, thus, with increased risk of coronary heart disease. Diets low in saturated fat and cholesterol are associated with decreased levels of blood total- and LDL-cholesterol, and

thus, with decreased risk of developing coronary heart disease.

(3) Populations with relatively low blood cholesterol levels tend to have dietary patterns that are not only low in total fat, especially saturated fat and cholesterol, but are also relatively high in fruits, vegetables, and grain products. Although the specific roles of these plant foods are not yet fully understood, many studies have shown that diets high in plant foods are associated with reduced risk of coronary heart disease. These studies correlate diets rich in fruits, vegetables, and grain products and nutrients from these diets, such as some types of fiber, with reduced coronary heart disease risk. Persons consuming these diets frequently have high intakes of dietary fiber, particularly soluble fibers. Currently, there is not scientific agreement as to whether a particular type of soluble fiber is beneficial, or whether the observed protective effects of fruits, vegetables, and grain products against heart disease are due to other components, or a combination of components, in these diets, including, but not necessarily limited to, some types of soluble fiber, other fiber components, other characteristics of the complex carbohydrate content of these foods, other nutrients in these foods, or displacement of saturated fat and cholesterol from the diet.

(b) *Significance of the relationship between diets low in saturated fat and cholesterol, and high in fruits, vegetables, and grain products that contain fiber, particularly soluble fiber, and risk of coronary heart disease.* (1) Coronary heart disease is a major public health concern in the United States, primarily because it accounts for more deaths than any other disease or group of diseases. Early management of risk factors for coronary heart disease is a major public health goal that can assist in reducing risk of coronary heart disease. There is a continuum of mortality risk from coronary heart disease that increases with increasing levels of blood LDL-cholesterol. Individuals with high blood LDL-cholesterol are at greatest risk. A larger number of individuals with more moderately elevated cholesterol also have increased risk of coronary events; such individuals com-

prise a substantial proportion of the adult U.S. population. The scientific evidence indicates that reducing saturated fat and cholesterol intakes lowers blood LDL-cholesterol and risk of heart disease in most individuals, including persons with blood cholesterol levels in the normal range. Additionally, consuming diets high in fruits, vegetables, and grain products, foods that contain soluble fiber, may be a useful adjunct to a low saturated fat and low cholesterol diet.

(2) Other risk factors for coronary heart disease include a family history of heart disease, high blood pressure, diabetes, cigarette smoking, obesity (body weight 30 percent greater than ideal body weight), and lack of regular physical exercise.

(3) Intakes of saturated fat exceed recommended levels in many people in the United States. Intakes of cholesterol are, on average, at or above recommended levels. Intakes of fiber-containing fruits, vegetables, and grain products are about half of recommended intake levels. One of the major public health recommendations relative to coronary heart disease risk is to consume less than 10 percent of calories from saturated fat, and an average of 30 percent or less of total calories from all fat. Recommended daily cholesterol intakes are 300 mg or less per day. Recommended total dietary fiber intakes are about 25 grams (g) daily, of which about 25 percent (about 6 g) should be soluble fiber.

(4) Current dietary guidance recommendations encourage decreased consumption of dietary fat, especially saturated fat and cholesterol, and increased consumption of fiber-rich foods to help lower blood LDL-cholesterol levels. Results of numerous studies have shown that fiber-containing fruits, vegetables, and grain products can help lower blood LDL-cholesterol.

(c) *Requirements.* (1) All requirements set forth in §101.14 shall be met.

(2) *Specific requirements—(i) Nature of the claim.* A health claim associating diets low in saturated fat and cholesterol and high in fruits, vegetables, and grain products that contain fiber, particularly soluble fiber, with reduced risk of heart disease may be made on the label or labeling of a food described

in paragraph (c)(2)(ii) of this section, provided that:

(A) The claim states that diets low in saturated fat and cholesterol and high in fruits, vegetables, and grain products that contain fiber “may” or “might” reduce the risk of heart disease;

(B) In specifying the disease, the claim uses the following terms: “heart disease” or “coronary heart disease;”

(C) The claim is limited to those fruits, vegetables, and grains that contain fiber;

(D) In specifying the dietary fiber, the claim uses the term “fiber,” “dietary fiber,” “some types of dietary fiber,” “some dietary fibers,” or “some fibers;” the term “soluble fiber” may be used in addition to these terms;

(E) In specifying the fat component, the claim uses the terms “saturated fat” and “cholesterol;” and

(F) The claim indicates that development of heart disease depends on many factors; and

(G) The claim does not attribute any degree of risk reduction for coronary heart disease to diets low in saturated fat and cholesterol and high in fruits, vegetables, and grain products that contain fiber.

(ii) *Nature of the food.* (A) The food shall be or shall contain a fruit, vegetable, or grain product.

(B) The food shall meet the nutrient content requirements of §101.62 for a “low saturated fat,” “low cholesterol,” and “low fat” food.

(C) The food contains, without fortification, at least 0.6 g of soluble fiber per reference amount customarily consumed;

(D) The content of soluble fiber shall be declared in the nutrition information panel, consistent with §101.9(c)(6)(i)(A).

(d) *Optional information.* (1) The claim may identify one or more of the following risk factors for heart disease about which there is general scientific agreement: A family history of coronary heart disease, elevated blood-, total- and LDL-cholesterol, excess body weight, high blood pressure, cigarette smoking, diabetes, and physical inactivity.

(2) The claim may indicate that the relationship of diets low in saturated

fat and cholesterol, and high in fruits, vegetables, and grain products that contain fiber to heart disease is through the intermediate link of “blood cholesterol” or “blood total- and LDL-cholesterol.”

(3) The claim may include information from paragraphs (a) and (b) of this section, which summarize the relationship between diets low in saturated fat and cholesterol and high in fruits, vegetables, and grain products that contain fiber and coronary heart disease, and the significance of the relationship.

(4) In specifying the nutrients, the claim may include the term “total fat” in addition to the terms “saturated fat” and “cholesterol.”

(5) The claim may indicate that it is consistent with “Nutrition and Your Health: Dietary Guidelines for Americans,” U.S. Department of Agriculture (USDA) and Department of Health and Human Services (DHHS), Government Printing Office (GPO).

(6) The claim may state that individuals with elevated blood total- and LDL-cholesterol should consult their physicians for medical advice and treatment. If the claim defines high or normal blood total- and LDL-cholesterol levels, then the claim shall state that individuals with high blood cholesterol should consult their physicians for medical advice and treatment.

(7) The claim may include information on the number of people in the United States who have heart disease. The sources of this information shall be identified, and it shall be current information from the National Center for Health Statistics, the National Institutes of Health, or “Nutrition and Your Health: Dietary Guidelines for Americans,” USDA and DHHS, GPO.

(e) *Model health claims.* The following model health claims may be used in food labeling to characterize the relationship between diets low in saturated fat and cholesterol and high in fruits, vegetables, and grain products that contain soluble fiber:

(1) Diets low in saturated fat and cholesterol and rich in fruits, vegetables, and grain products that contain some types of dietary fiber, particularly soluble fiber, may reduce the risk

of heart disease, a disease associated with many factors.

(2) Development of heart disease depends on many factors. Eating a diet low in saturated fat and cholesterol and high in fruits, vegetables, and grain products that contain fiber may lower blood cholesterol levels and reduce your risk of heart disease.

[58 FR 2578, Jan. 6, 1993]

§ 101.78 Health claims: fruits and vegetables and cancer.

(a) *Relationship between substances in diets low in fat and high in fruits and vegetables and cancer risk.* (1) Cancer is a constellation of more than 100 different diseases, each characterized by the uncontrolled growth and spread of abnormal cells. Cancer has many causes and stages in its development. Both genetic and environmental risk factors may affect the risk of cancer. Risk factors include a family history of a specific type of cancer, cigarette smoking, alcohol consumption, overweight and obesity, ultraviolet or ionizing radiation, exposure to cancer-causing chemicals, and dietary factors.

(2) Although the specific roles of the numerous potentially protective substances in plant foods are not yet understood, many studies have shown that diets high in plant foods are associated with reduced risk of some types of cancers. These studies correlate diets rich in fruits and vegetables and nutrients from these diets, such as vitamin C, vitamin A, and dietary fiber, with reduced cancer risk. Persons consuming these diets frequently have high intakes of these nutrients. Currently, there is not scientific agreement as to whether the observed protective effects of fruits and vegetables against cancer are due to a combination of the nutrient components of diets rich in fruits and vegetables, including but not necessarily limited to dietary fiber, vitamin A (as beta-carotene) and vitamin C, to displacement of fat from such diets, or to intakes of other substances in these foods which are not nutrients but may be protective against cancer risk.

(b) *Significance of the relationship between consumption of diets low in fat and high in fruits and vegetables and risk of cancer.* (1) Cancer is ranked as a leading

cause of death in the United States. The overall economic costs of cancer, including direct health care costs and losses due to morbidity and mortality, are very high.

(2) U.S. diets tend to be high in fat and low in fruits and vegetables. Studies in various parts of the world indicate that populations who habitually consume a diet high in plant foods have lower risks of some cancers. These diets generally are low in fat and rich in many nutrients, including, but not limited to, dietary fiber, vitamin A (as beta-carotene), and vitamin C. Current dietary guidelines from Federal Government agencies and nationally recognized health professional organizations recommend decreased consumption of fats (less than 30 percent of calories), maintenance of desirable body weight, and increased consumption of fruits and vegetables (5 or more servings daily), particularly those fruits and vegetables which contain dietary fiber, vitamin A, and vitamin C.

(c) *Requirements.* (1) All requirements set forth in § 101.14 shall be met.

(2) *Specific requirements*—(i) *Nature of the claim.* A health claim associating substances in diets low in fat and high in fruits and vegetables with reduced risk of cancer may be made on the label or labeling of a food described in paragraph (c)(2)(ii) of this section, provided that:

(A) The claim states that diets low in fat and high in fruits and vegetables “may” or “might” reduce the risk of some cancers;

(B) In specifying the disease, the claim uses the following terms: “some types of cancer”, or “some cancers”;

(C) The claim characterizes fruits and vegetables as foods that are low in fat and may contain vitamin A, vitamin C, and dietary fiber;

(D) The claim characterizes the food bearing the claim as containing one or more of the following, for which the food is a good source under § 101.54: dietary fiber, vitamin A, or vitamin C;

(E) The claim does not attribute any degree of cancer risk reduction to diets low in fat and high in fruits and vegetables;

(F) In specifying the fat component of the labeled food, the claim uses the term “total fat” or “fat”;

(G) The claim does not specify types of fats or fatty acids that may be related to risk of cancer;

(H) In specifying the dietary fiber component of the labeled food, the claim uses the term “fiber”, “dietary fiber”, or “total dietary fiber”;

(I) The claim does not specify types of dietary fiber that may be related to risk of cancer; and

(J) The claim indicates that development of cancer depends on many factors.

(ii) *Nature of the food.* (A) The food shall be or shall contain a fruit or vegetable.

(B) The food shall meet the nutrient content requirements of §101.62 for a “low fat” food.

(C) The food shall meet, without fortification, the nutrient content requirements of §101.54 for a “good source” of at least one of the following: vitamin A, vitamin C, or dietary fiber.

(d) *Optional information.* (1) The claim may include information from paragraphs (a) and (b) of this section, which summarize the relationship between diets low in fat and high in fruits and vegetables and some types of cancer and the significance of the relationship.

(2) The claim may identify one or more of the following risk factors for development of cancer: Family history of a specific type of cancer, cigarette smoking, alcohol consumption, overweight and obesity, ultraviolet or ionizing radiation, exposure to cancer-causing chemicals, and dietary factors.

(3) The claim may use the word “beta-carotene” in parentheses after the term vitamin A, provided that the vitamin A in the food bearing the claim is beta-carotene.

(4) The claim may indicate that it is consistent with “Nutrition and Your Health: Dietary Guidelines for Americans,” U.S. Department of Agriculture (USDA) and the Department of Health and Human Services (DHHS), Government Printing Office.

(5) The claim may include information on the number of people in the United States who have cancer. The sources of this information must be identified, and it must be current information from the National Center for Health Statistics, the National Insti-

tutes of Health, or “Nutrition and Your Health: Dietary Guidelines for Americans,” USDA and DHHS, Government Printing Office.

(e) *Model health claims.* The following model health claims may be used in food labeling to characterize the relationship between substances in diets low in fat and high in fruits and vegetables and cancer:

(1) Low fat diets rich in fruits and vegetables (foods that are low in fat and may contain dietary fiber, vitamin A, and vitamin C) may reduce the risk of some types of cancer, a disease associated with many factors. Broccoli is high in vitamins A and C, and it is a good source of dietary fiber.

(2) Development of cancer depends on many factors. Eating a diet low in fat and high in fruits and vegetables, foods that are low in fat and may contain vitamin A, vitamin C, and dietary fiber, may reduce your risk of some cancers. Oranges, a food low in fat, are a good source of fiber and vitamin C.

[58 FR 2639, Jan. 6, 1993]

§ 101.79 Health claims: Folate and neural tube defects.

(a) *Relationship between folate and neural tube defects*—(1) *Definition.* Neural tube defects are serious birth defects of the brain or spinal cord that can result in infant mortality or serious disability. The birth defects anencephaly and spina bifida are the most common forms of neural tube defects and account for about 90 percent of these defects. These defects result from failure of closure of the covering of the brain or spinal cord during early embryonic development. Because the neural tube forms and closes during early pregnancy, the defect may occur before a woman realizes that she is pregnant.

(2) *Relationship.* The available data show that diets adequate in folate may reduce the risk of neural tube defects. The strongest evidence for this relationship comes from an intervention study by the Medical Research Council of the United Kingdom that showed that women at risk of recurrence of a neural tube defect pregnancy who consumed a supplement containing 4 milligrams (mg)(4,000 micrograms (mcg)) folic acid daily before conception and

continuing into early pregnancy had a reduced risk of having a child with a neural tube defect. (Products containing this level of folic acid are drugs). In addition, based on its review of a Hungarian intervention trial that reported periconceptional use of a multivitamin and multimineral preparation containing 800 mcg (0.8 mg) of folic acid, and its review of the observational studies that reported periconceptional use of multivitamins containing 0 to 1,000 mcg of folic acid, the Food and Drug Administration concluded that most of these studies had results consistent with the conclusion that folate, at levels attainable in usual diets, may reduce the risk of neural tube defects.

(b) *Significance of folate*—(1) *Public health concern*. Neural tube defects occur in approximately 0.6 of 1,000 live births in the United States (i.e., approximately 6 of 10,000 live births; about 2,500 cases among 4 million live births annually). Neural tube defects are believed to be caused by many factors. The single greatest risk factor for a neural tube defect-affected pregnancy is a personal or family history of a pregnancy affected with a such a defect. However, about 90 percent of infants with a neural tube defect are born to women who do not have a family history of these defects. The available evidence shows that diets adequate in folate may reduce the risk of neural tube defects but not of other birth defects.

(2) *Populations at risk*. Prevalence rates for neural tube defects have been reported to vary with a wide range of factors including genetics, geography, socioeconomic status, maternal birth cohort, month of conception, race, nutrition, and maternal health, including maternal age and reproductive history. Women with a close relative (i.e., sibling, niece, nephew) with a neural tube defect, those with insulin-dependent diabetes mellitus, and women with seizure disorders who are being treated with valproic acid or carbamazepine are at significantly increased risk compared with women without these characteristics. Rates for neural tube defects vary within the United States, with lower rates observed on the west coast than on the east coast.

(3) *Those who may benefit*. Based on a synthesis of information from several studies, including those which used multivitamins containing folic acid at a daily dose level of ≥ 400 mcg (≥ 0.4 mg), the Public Health Service has inferred that folate alone at levels of 400 mcg (0.4 mg) per day may reduce the risk of neural tube defects. The protective effect found in studies of lower dose folate measured by the reduction in neural tube defect incidence, ranges from none to substantial; a reasonable estimate of the expected reduction in the United States is 50 percent. It is expected that consumption of adequate folate will avert some, but not all, neural tube defects. The underlying causes of neural tube defects are not known. Thus, it is not known what proportion of neural tube defects will be averted by adequate folate consumption. From the available evidence, the Public Health Service estimates that there is the potential for averting 50 percent of cases that now occur (i.e., about 1,250 cases annually). However, until further research is done, no firm estimate of this proportion will be available.

(c) *Requirements*. The label or labeling of food may contain a folate/neural tube defect health claim provided that:

(1) *General requirements*. The health claim for a food meets all of the general requirements of §101.14 for health claims, except that a food may qualify to bear the health claim if it meets the definition of the term “good source.”

(2) *Specific requirements*—(i) *Nature of the claim*—(A) *Relationship*. A health claim that women who are capable of becoming pregnant and who consume adequate amounts of folate daily during their childbearing years may reduce their risk of having a pregnancy affected by spina bifida or other neural tube defects may be made on the label or labeling of food provided that:

(B) *Specifying the nutrient*. In specifying the nutrient, the claim shall use the terms “folate,” “folic acid,” “folacin,” “folate, a B vitamin,” “folic acid, a B vitamin,” or “folacin, a B vitamin.”

(C) *Specifying the condition*. In specifying the health-related condition, the claim shall identify the birth defects as “neural tube defects,” “birth defects spina bifida or anencephaly,” “birth

defects of the brain or spinal cord anencephaly or spina bifida,” “spina bifida and anencephaly, birth defects of the brain or spinal cord,” “birth defects of the brain or spinal cord;” or “brain or spinal cord birth defects.”

(D) *Multifactorial nature.* The claim shall not imply that folate intake is the only recognized risk factor for neural tube defects.

(E) *Reduction in risk.* The claim shall not attribute any specific degree of reduction in risk of neural tube defects from maintaining an adequate folate intake throughout the childbearing years. The claim shall state that some women may reduce their risk of a neural tube defect pregnancy by maintaining adequate intakes of folate during their childbearing years. Optional statements about population-based estimates of risk reduction may be made in accordance with paragraph (c)(3)(vi) of this section.

(F) *Safe upper limit of daily intake.* Claims on foods that contain more than 100 percent of the Daily Value (DV) (400 mcg) when labeled for use by adults and children 4 or more years of age, or 800 mcg when labeled for use by pregnant or lactating women) shall identify the safe upper limit of daily intake with respect to the DV. The safe upper limit of daily intake value of 1,000 mcg (1 mg) may be included in parentheses.

(G) The claim shall state that folate needs to be consumed as part of a healthful diet.

(ii) *Nature of the food—(A) Requirements.* The food shall meet or exceed the requirements for a “good source” of folate as defined in §101.54;

(B) *Dietary supplements.* Dietary supplements shall meet the United States Pharmacopeia (USP) standards for disintegration and dissolution, except that if there are no applicable USP standards, the folate in the dietary supplement shall be shown to be bioavailable under the conditions of use stated on the product label.

(iii) *Limitation.* The claim shall not be made on foods that contain more than 100 percent of the RDI for vitamin A as retinol or preformed vitamin A or vitamin D per serving or per unit.

(iv) *Nutrition labeling.* The nutrition label shall include information about

the amount of folate in the food. This information shall be declared after the declaration for iron if only the levels of vitamin A, vitamin C, calcium, and iron are provided, or in accordance with §101.9 (c)(8) and (c)(9) if other optional vitamins or minerals are declared.

(3) *Optional information—(i) Risk factors.* The claim may specifically identify risk factors for neural tube defects. Where such information is provided, it may consist of statements from §101.79(b)(1) or (b)(2) (e.g., Women at increased risk include those with a personal history of a neural tube defect-affected pregnancy, those with a close relative (i.e., sibling, niece, nephew) with a neural tube defect; those with insulin-dependent diabetes mellitus; those with seizure disorders who are being treated with valproic acid or carbamazepine) or from other parts of this paragraph (c)(3)(i).

(ii) *Relationship between folate and neural tube defects.* The claim may include statements from paragraphs (a) and (b) of this section that summarize the relationship between folate and neural tube defects and the significance of the relationship except for information specifically prohibited from the claim.

(iii) *Personal history of a neural tube defect-affected pregnancy.* The claim may state that women with a history of a neural tube defect pregnancy should consult their physicians or health care providers before becoming pregnant. If such a statement is provided, the claim shall also state that all women should consult a health care provider when planning a pregnancy.

(iv) *Daily value.* The claim may identify 100 percent of the DV (100% DV; 400 mcg) for folate as the target intake goal.

(v) *Prevalence.* The claim may provide estimates, expressed on an annual basis, of the number of neural tube defect-affected births among live births in the United States. Current estimates are provided in §101.79(b)(1), and are approximately 6 of 10,000 live births annually (i.e., about 2,500 cases among 4 million live births annually). Data provided in §101.79(b)(1) shall be used, unless more current estimates from the

U.S. Public Health Service are available, in which case the latter may be cited.

(vi) *Reduction in risk.* An estimate of the reduction in the number of neural tube defect-affected births that might occur in the United States if all women consumed adequate folate throughout their childbearing years may be included in the claim. Information contained in paragraph (b)(3) of this section may be used. If such an estimate (i.e., 50 percent) is provided, the estimate shall be accompanied by additional information that states that the estimate is population-based and that it does not reflect risk reduction that may be experienced by individual women.

(vii) *Diets adequate in folate.* The claim may identify diets adequate in folate by using phrases such as “Sources of folate include fruits, vegetables, whole grain products, fortified cereals, and dietary supplements.” or “Adequate amounts of folate can be obtained from diets rich in fruits, dark green leafy vegetables, legumes, whole grain products, fortified cereals, or dietary supplements.” or “Adequate amounts of folate can be obtained from diets rich in fruits, including citrus fruits and juices, vegetables, including dark green leafy vegetables, legumes, whole grain products, including breads, rice, and pasta, fortified cereals, or a dietary supplement.”

(d) *Model health claims.* The following are examples of model health claims that may be used in food labeling to describe the relationship between folate and neural tube defects:

(1) *Examples 1 and 2.* Model health claims appropriate for foods containing 100 percent or less of the DV for folate per serving or per unit (general population). The examples contain only the required elements:

(i) Healthful diets with adequate folate may reduce a woman’s risk of having a child with a brain or spinal cord birth defect.

(ii) Adequate folate in healthful diets may reduce a woman’s risk of having a child with a brain or spinal cord birth defect.

(2) *Example 3.* Model health claim appropriate for foods containing 100 percent or less of the DV for folate per

serving or per unit. The example contains all required elements plus optional information: Women who consume healthful diets with adequate folate throughout their childbearing years may reduce their risk of having a child with a birth defect of the brain or spinal cord. Sources of folate include fruits, vegetables, whole grain products, fortified cereals, and dietary supplements.

(3) *Example 4.* Model health claim appropriate for foods intended for use by the general population and containing more than 100 percent of the DV of folate per serving or per unit: Women who consume healthful diets with adequate folate may reduce their risk of having a child with birth defects of the brain or spinal cord. Folate intake should not exceed 250% of the DV (1,000 mcg).

[61 FR 8779, Mar. 5, 1996; 61 FR 48529, Sept. 13, 1996, as amended at 65 FR 58918, Oct. 3, 2000]

§ 101.80 Health claims: dietary noncariogenic carbohydrate sweeteners and dental caries.

(a) *Relationship between dietary carbohydrates and dental caries.* (1) Dental caries, or tooth decay, is a disease caused by many factors. Both environmental and genetic factors can affect the development of dental caries. Risk factors include tooth enamel crystal structure and mineral content, plaque quantity and quality, saliva quantity and quality, individual immune response, types and physical characteristics of foods consumed, eating behaviors, presence of acid producing oral bacteria, and cultural influences.

(2) The relationship between consumption of fermentable carbohydrates, i.e., dietary sugars and starches, and tooth decay is well established. Sucrose, also known as sugar, is one of the most, but not the only, cariogenic sugars in the diet. Bacteria found in the mouth are able to metabolize most dietary carbohydrates, producing acid and forming dental plaque. The more frequent and longer the exposure of teeth to dietary sugars and starches, the greater the risk for tooth decay.

(3) Dental caries continues to affect a large proportion of Americans. Although there has been a decline in the

prevalence of dental caries among children in the United States, the disease remains widespread throughout the population, imposing a substantial burden on Americans. Recent Federal government dietary guidelines recommend that Americans choose diets that are moderate in sugars and avoid excessive snacking. Frequent between-meal snacks that are high in sugars and starches may be more harmful to teeth than eating such foods at meals and then brushing.

(4) Noncariogenic carbohydrate sweeteners, such as sugar alcohols, can be used to replace dietary sugars, such as sucrose and corn sweeteners, in foods such as chewing gums and certain confectioneries. Noncariogenic carbohydrate sweeteners are significantly less cariogenic than dietary sugars and other fermentable carbohydrates.

(b) *Significance of the relationship between noncariogenic carbohydrate sweeteners and dental caries.* Noncariogenic carbohydrate sweeteners do not promote dental caries. The noncariogenic carbohydrate sweeteners listed in paragraph (c)(2)(ii) of this section are slowly metabolized by bacteria to form some acid. The rate and amount of acid production is significantly less than that from sucrose and other fermentable carbohydrates and does not cause the loss of important minerals from tooth enamel.

(c) *Requirements.* (1) All requirements set forth in §101.14 shall be met, except that noncariogenic carbohydrate sweetener-containing foods listed in paragraph (c)(2)(ii) of this section are exempt from §101.14(e)(6).

(2) *Specific requirements—(i) Nature of the claim.* A health claim relating noncariogenic carbohydrate sweeteners, compared to other carbohydrates, and the nonpromotion of dental caries may be made on the label or labeling of a food described in paragraph (c)(2)(iii) of this section, provided that:

(A) The claim shall state that frequent between-meal consumption of foods high in sugars and starches can promote tooth decay.

(B) The claim shall state that the noncariogenic carbohydrate sweetener present in the food “does not pro-

mote,” “may reduce the risk of,” “useful [or is useful] in not promoting,” or “expressly [or is expressly] for not promoting” dental caries.

(C) In specifying the nutrient, the claim shall state “sugar alcohol,” “sugar alcohols,” or the name or names of the substances listed in paragraph (c)(2)(ii) of this section, e.g., “sorbitol.” D-tagatose may be identified as “tagatose.”

(D) In specifying the disease, the claim uses the following terms: “dental caries” or “tooth decay.”

(E) The claim shall not attribute any degree of the reduction in risk of dental caries to the use of the noncariogenic carbohydrate sweetener-containing food.

(F) The claim shall not imply that consuming noncariogenic carbohydrate sweetener-containing foods is the only recognized means of achieving a reduced risk of dental caries.

(G) Packages with less than 15 square inches of surface area available for labeling are exempt from paragraphs (A) and (C) of this section.

(H) When the substance that is the subject of the claim is a noncariogenic sugar, the claim shall identify the substance as a sugar that, unlike other sugars, does not promote the development of dental caries.

(ii) *Nature of the substance.* Eligible noncariogenic carbohydrate sweeteners are:

(A) The sugar alcohols xylitol, sorbitol, mannitol, maltitol, isomalt, lactitol, hydrogenated starch hydrolysates, hydrogenated glucose syrups, and erythritol, or a combination of these.

(B) The sugar D-tagatose.

(C) Sucralose.

(iii) *Nature of the food.* (A) The food shall meet the requirement in §101.60(c)(1)(i) with respect to sugars content, except that the food may contain D-tagatose.

(B) A food whose labeling includes a health claim under this section shall contain one or more of the noncariogenic carbohydrate sweeteners listed in paragraph (c)(2)(ii) of this section.

(C) When carbohydrates other than those listed in paragraph (c)(2)(ii) of this section are present in the food, the

§ 101.81

21 CFR Ch. I (4-1-07 Edition)

food shall not lower plaque pH below 5.7 by bacterial fermentation either during consumption or up to 30 minutes after consumption, as measured by the indwelling plaque pH test found in "Identification of Low Caries Risk Dietary Components," dated 1983, by T. N. Imfeld, in Volume 11, *Monographs in Oral Science*, 1983. The Director of the Office of the Federal Register has approved the incorporation by reference of this material in accordance with 5 U.S.C. 552(a) and 1 CFR part 51. You may obtain copies from Karger AG Publishing Co., P.O. Box, Ch-4009 Basel, Switzerland, or you may examine a copy at the Center for Food Safety and Applied Nutrition's Library, Harvey W. Wiley Federal Building, 5100 Paint Branch Pkwy., College Park, MD, or at the National Archives and Records Administration (NARA). For information on the availability of this material at NARA, call 202-741-6030, or go to: http://www.archives.gov/federal_register/code_of_federal_regulations/ibr_locations.html.

(d) *Optional information.* (1) The claim may include information from paragraphs (a) and (b) of this section, which describe the relationship between diets containing noncariogenic carbohydrate sweeteners and dental caries.

(2) The claim may indicate that development of dental caries depends on many factors and may identify one or more of the following risk factors for dental caries: Frequent consumption of fermentable carbohydrates, such as dietary sugars and starches; presence of oral bacteria capable of fermenting carbohydrates; length of time fermentable carbohydrates are in contact with the teeth; lack of exposure to fluoride; individual susceptibility; socioeconomic and cultural factors; and characteristics of tooth enamel, saliva, and plaque.

(3) The claim may indicate that oral hygiene and proper dental care may help to reduce the risk of dental disease.

(4) The claim may indicate that a substance listed in paragraph (c)(2)(ii) of this section serves as a sweetener.

(e) *Model health claim.* The following model health claims may be used in food labeling to describe the relation-

ship between noncariogenic carbohydrate sweetener-containing foods and dental caries.

(1) Examples of the full claim:

(i) Frequent eating of foods high in sugars and starches as between-meal snacks can promote tooth decay. The sugar alcohol [name, optional] used to sweeten this food may reduce the risk of dental caries.

(ii) Frequent between-meal consumption of foods high in sugars and starches promotes tooth decay. The sugar alcohols in [name of food] do not promote tooth decay.

(iii) Frequent eating of foods high in sugars and starches as between-meal snacks can promote tooth decay. Tagatose, the sugar used to sweeten this food, unlike other sugars, may reduce the risk of dental caries.

(iv) Frequent between-meal consumption of foods high in sugars and starches promotes tooth decay. Tagatose, the sugar in [name of food], unlike other sugars, does not promote tooth decay.

(v) Frequent eating of foods high in sugars and starches as between-meal snacks can promote tooth decay. Sucralose, the sweetening ingredient used to sweeten this food, unlike sugars, does not promote tooth decay.

(2) Example of the shortened claim for small packages:

(i) Does not promote tooth decay.

(ii) May reduce the risk of tooth decay.

(iii) Tagatose sugar does not promote tooth decay.

(iv) Tagatose sugar may reduce the risk of tooth decay.

[61 FR 43446, Aug. 23, 1996, as amended at 62 FR 63655, Dec. 2, 1997; 66 FR 66742, Dec. 27, 2001; 67 FR 71470, Dec. 2, 2002; 71 FR 15563, Mar. 29, 2006]

§101.81 Health claims: Soluble fiber from certain foods and risk of coronary heart disease (CHD).

(a) *Relationship between diets that are low in saturated fat and cholesterol and that include soluble fiber from certain foods and the risk of CHD.* (1) Cardiovascular disease means diseases of the heart and circulatory system. Coronary heart disease (CHD) is one of the

most common and serious forms of cardiovascular disease and refers to diseases of the heart muscle and supporting blood vessels. High blood total cholesterol and low density lipoprotein (LDL)-cholesterol levels are associated with increased risk of developing coronary heart disease. High CHD rates occur among people with high total cholesterol levels of 240 milligrams per deciliter (mg/dL) (6.21 (mmol/L)) or above and LDL-cholesterol levels of 160 mg/dL (4.13 mmol/L) or above. Borderline high risk total cholesterol levels range from 200 to 239 mg/dL (5.17 to 6.18 mmol/L) and 130 to 159 mg/dL (3.36 to 4.11 mmol/L) of LDL-cholesterol. The scientific evidence establishes that diets high in saturated fat and cholesterol are associated with increased levels of blood total- and LDL-cholesterol and, thus, with increased risk of CHD.

(2) Populations with a low incidence of CHD tend to have relatively low blood total cholesterol and LDL-cholesterol levels. These populations also tend to have dietary patterns that are not only low in total fat, especially saturated fat and cholesterol, but are also relatively high in fiber-containing fruits, vegetables, and grain products, such as whole oat products.

(3) Scientific evidence demonstrates that diets low in saturated fat and cholesterol may reduce the risk of CHD. Other evidence demonstrates that the addition of soluble fiber from certain foods to a diet that is low in saturated fat and cholesterol may also help to reduce the risk of CHD.

(b) *Significance of the relationship between diets that are low in saturated fat and cholesterol and that include soluble fiber from certain foods and the risk of CHD.* (1) CHD is a major public health concern in the United States. It accounts for more deaths than any other disease or group of diseases. Early management of risk factors for CHD is a major public health goal that can assist in reducing risk of CHD. High blood total and LDL-cholesterol are major modifiable risk factors in the development of CHD.

(2) Intakes of saturated fat exceed recommended levels in the diets of many people in the United States. One of the major public health recommendations relative to CHD risk is

to consume less than 10 percent of calories from saturated fat and an average of 30 percent or less of total calories from all fat. Recommended daily cholesterol intakes are 300 milligrams (mg) or less per day. Scientific evidence demonstrates that diets low in saturated fat and cholesterol are associated with lower blood total- and LDL-cholesterol levels. Soluble fiber from certain foods, when included in a low saturated fat and cholesterol diet, also helps to lower blood total- and LDL-cholesterol levels.

(c) *Requirements.* (1) All requirements set forth in §101.14 shall be met. The label and labeling of foods containing psyllium husk shall be consistent with the provisions of §101.17(f).

(2) *Specific requirements—(i) Nature of the claim.* A health claim associating diets that are low in saturated fat and cholesterol and that include soluble fiber from certain foods with reduced risk of heart disease may be made on the label or labeling of a food described in paragraph (c)(2)(iii) of this section, provided that:

(A) The claim states that diets that are low in saturated fat and cholesterol and that include soluble fiber from certain foods “may” or “might” reduce the risk of heart disease.

(B) In specifying the disease, the claim uses the following terms: “heart disease” or “coronary heart disease”;

(C) In specifying the substance, the claim uses the term “soluble fiber” qualified by the name of the eligible source of soluble fiber (provided in paragraph (c)(2)(ii) of this section. Additionally, the claim may use the name of the food product that contains the eligible source of soluble fiber;

(D) In specifying the fat component, the claim uses the terms “saturated fat” and “cholesterol”;

(E) The claim does not attribute any degree of risk reduction for CHD to diets that are low in saturated fat and cholesterol and that include soluble fiber from the eligible food sources from paragraph (c)(2)(ii) of this section; and

(F) The claim does not imply that consumption of diets that are low in saturated fat and cholesterol and that include soluble fiber from the eligible food sources from paragraph (c)(2)(ii) of

this section is the only recognized means of achieving a reduced risk of CHD.

(G) The claim specifies the daily dietary intake of the soluble fiber source that is necessary to reduce the risk of coronary heart disease and the contribution one serving of the product makes to the specified daily dietary intake level. Daily dietary intake levels of soluble fiber sources listed in paragraph (c)(2)(ii) of this section that have been associated with reduced risk coronary heart disease are:

(1) 3 g or more per day of β -glucan soluble fiber from either whole oats or barley, or a combination of whole oats and barley.

(2) 7 g or more per day of soluble fiber from psyllium seed husk.

(ii) *Nature of the substance—Eligible sources of soluble fiber.* (A) Beta (β) glucan soluble fiber from the whole oat and barley sources listed below. β -glucan soluble fiber will be determined by method No. 992.28 from the “Official Methods of Analysis of the AOAC INTERNATIONAL,” 16th ed. (1995), which is incorporated by reference in accordance with 5 U.S.C. 552(a) and 1 CFR part 51. Copies may be obtained from the AOAC INTERNATIONAL, 481 North Frederick Ave., suite 500, Gaithersburg, MD 20877, or may be examined at the Center for Food Safety and Applied Nutrition’s Library, 5100 Paint Branch Pkwy., College Park, MD 20740, or at the National Archives and Records Administration (NARA). For information on the availability of this material at NARA, call 202–741–6030, or go to: http://www.archives.gov/federal_register/code_of_federal_regulations/ibr_locations.html;

(1) *Oat bran.* Oat bran is produced by grinding clean oat groats or rolled oats and separating the resulting oat flour by suitable means into fractions such that the oat bran fraction is not more than 50 percent of the original starting material and provides at least 5.5 percent (dry weight basis (dwb)) β -glucan soluble fiber and a total dietary fiber content of 16 percent (dwb), and such that at least one-third of the total dietary fiber is soluble fiber;

(2) *Rolled oats.* Rolled oats, also known as oatmeal, produced from 100

percent dehulled, clean oat groats by steaming, cutting, rolling, and flaking, and provides at least 4 percent (dwb) of β -glucan soluble fiber and a total dietary fiber content of at least 10 percent.

(3) *Whole oat flour.* Whole oat flour is produced from 100 percent dehulled, clean oat groats by steaming and grinding, such that there is no significant loss of oat bran in the final product, and provides at least 4 percent (dwb) of β -glucan soluble fiber and a total dietary fiber content of at least 10 percent (dwb).

(4) *Oatrim.* The soluble fraction of alpha-amylase hydrolyzed oat bran or whole oat flour, also known as oatrim. Oatrim is produced from either oat bran as defined in paragraph (c)(2)(ii)(A)(1) of this section or whole oat flour as defined in paragraph (c)(2)(ii)(A)(3) of this section by solubilization of the starch in the starting material with an alpha-amylase hydrolysis process, and then removal by centrifugation of the insoluble components consisting of a high portion of protein, lipid, insoluble dietary fiber, and the majority of the flavor and color components of the starting material. Oatrim shall have a beta-glucan soluble fiber content up to 10 percent (dwb) and not less than that of the starting material (dwb).

(5) *Whole grain barley and dry milled barley.* Dehulled and hull-less whole grain barley with a β -glucan soluble fiber content of at least 4 percent (dwb) and a total dietary fiber content of at least 10 percent (dwb). Dry milled barley grain products include barley bran, barley flakes, barley grits, pearl barley, barley flour, barley meal, and sieved barley meal that are produced from clean, sound dehulled or hull-less barley grain using standard dry milling techniques, which may include steaming or tempering, and that contain at least 4 percent (dwb) of β -glucan soluble fiber and at least 8 percent (dwb) of total dietary fiber, except barley bran and sieved barley meal for which the minimum β -glucan soluble fiber content is 5.5 percent (dwb) and minimum total dietary fiber content is 15 percent (dwb). Dehulled barley, hull-less barley, barley bran, barley flakes, barley grits, pearl barley, and barley flour are

as defined in the Barley Glossary (AACC Method 55-99), published in Approved Methods of the American Association of Cereal Chemists, 10th ed. (2000), pp. 1 and 2, which is incorporated by reference in accordance with 5 U.S.C. 552(a) and 1 CFR part 51. Copies may be obtained from the American Association of Cereal Chemists, Inc., 3340 Pilot Knob Rd., St. Paul, Minnesota, 55121, or may be examined at the Center for Food Safety and Applied Nutrition Library, 5100 Paint Branch Pkwy., College Park, MD 20740, or at the National Archives and Records Administration (NARA). For information on the availability of this material at NARA, call 202-741-6030, or go to: http://www.archives.gov/federal_register/code_of_federal_regulations/ibr_locations.html. Barley meal is unsifted, ground barley grain not subjected to any processing to separate the bran, germ, and endosperm. Sieved barley meal is an endosperm cell wall-enriched fraction of ground barley separated from meal by sieving or by air classification.

(B)(1) Psyllium husk from the dried seed coat (epidermis) of the seed of *Plantago* (*P.*) *ovata*, known as blond psyllium or Indian psyllium, *P. indica*, or *P. psyllium*. To qualify for this claim, psyllium seed husk, also known as psyllium husk, shall have a purity of no less than 95 percent, such that it contains 3 percent or less protein, 4.5 percent or less of light extraneous matter, and 0.5 percent or less of heavy extraneous matter, but in no case may the combined extraneous matter exceed 4.9 percent, as determined by U.S. Pharmacopeia (USP) methods described in USP's "The National Formulary," USP 23, NF 18, p. 1341, (1995), which is incorporated by reference in accordance with 5 U.S.C. 552(a) and 1 CFR part 51. Copies may be obtained from the U.S. Pharmacopeial Convention, Inc., 12601 Twinbrook Pkwy., Rockville, MD 20852, or may be examined at the Center for Food Safety and Applied Nutrition's Library, 5100 Paint Branch Pkwy., College Park, MD 20740, or at the National Archives and Records Administration (NARA). For information on the availability of this material at NARA, call 202-741-6030, or go to: <http://www.archives.gov/>

[federal_register/
code_of_federal_regulations/
ibr_locations.html](http://www.archives.gov/federal_register/code_of_federal_regulations/ibr_locations.html);

(2) FDA will determine the amount of soluble fiber that is provided by psyllium husk by using a modification of the Association of Official Analytical Chemists' International (AOAC's) method for soluble dietary fiber (991.43) described by Lee et al., "Determination of Soluble and Insoluble Dietary Fiber in Psyllium-containing Cereal Products," *Journal of the AOAC International*, 78 (No. 3):724-729, 1995, which is incorporated by reference in accordance with 5 U.S.C. 552(a) and 1 CFR part 51. Copies may be obtained from the AOAC INTERNATIONAL, 481 North Frederick Ave., suite 500, Gaithersburg, MD 20877, or may be examined at the Center for Food Safety and Applied Nutrition's Library, 5100 Paint Branch Pkwy., College Park, MD 20740 or at the National Archives and Records Administration (NARA). For information on the availability of this material at NARA, call 202-741-6030, or go to: http://www.archives.gov/federal_register/code_of_federal_regulations/ibr_locations.html;

(iii) *Nature of the food eligible to bear the claim.* (A) The food product shall include:

(1) One or more of the whole oat or barley foods from paragraphs (c)(2)(ii)(A)(1), (2), (3), and (5) of this section, and the whole oat or barley foods shall contain at least 0.75 gram (g) of soluble fiber per reference amount customarily consumed of the food product; or

(2) The food containing the oatrim from paragraph (c)(2)(ii)(A)(4) of this section shall contain at least 0.75 g of beta-glucan soluble fiber per reference amount customarily consumed of the food product; or

(3) Psyllium husk that complies with paragraph (c)(2)(ii)(B) of this section, and the psyllium food shall contain at least 1.7 g of soluble fiber per reference amount customarily consumed of the food product;

(B) The amount of soluble fiber shall be declared in the nutrition label, consistent with §101.9(c)(6)(i)(A).

(C) The food shall meet the nutrient content requirements in §101.62 for a

“low saturated fat,” “low cholesterol,” and “low fat” food.

(d) *Optional information.* (1) The claim may state that the development of heart disease depends on many factors and may identify one or more of the following risk factors for heart disease about which there is general scientific agreement: A family history of CHD; elevated blood total and LDL-cholesterol; excess body weight; high blood pressure; cigarette smoking; diabetes; and physical inactivity. The claim may also provide additional information about the benefits of exercise and management of body weight to help lower the risk of heart disease;

(2) The claim may state that the relationship between intake of diets that are low in saturated fat and cholesterol and that include soluble fiber from the eligible food sources from paragraph (c)(2)(ii) of this section and reduced risk of heart disease is through the intermediate link of “blood cholesterol” or “blood total- and LDL-cholesterol;”

(3) The claim may include information from paragraphs (a) and (b) of this section, which summarize the relationship between diets that are low in saturated fat and cholesterol and that include soluble fiber from certain foods and coronary heart disease and the significance of the relationship;

(4) The claim may specify the name of the eligible soluble fiber;

(5) The claim may state that a diet low in saturated fat and cholesterol that includes soluble fiber from whole oats or barley is consistent with “Nutrition and Your Health: Dietary Guidelines for Americans,” U.S. Department of Agriculture (USDA) and Department of Health and Human Services (DHHS), Government Printing Office (GPO);

(6) The claim may state that individuals with elevated blood total- and LDL-cholesterol should consult their physicians for medical advice and treatment. If the claim defines high or normal blood total- and LDL-cholesterol levels, then the claim shall state that individuals with high blood cholesterol should consult their physicians for medical advice and treatment;

(7) The claim may include information on the number of people in the United States who have heart disease.

The sources of this information shall be identified, and it shall be current information from the National Center for Health Statistics, the National Institutes of Health, or “Nutrition and Your Health: Dietary Guidelines for Americans,” USDA and DHHS, GPO.

(e) *Model health claim.* The following model health claims may be used in food labeling to describe the relationship between diets that are low in saturated fat and cholesterol and that include soluble fiber from certain foods and reduced risk of heart disease:

(1) Soluble fiber from foods such as [name of soluble fiber source from paragraph (c)(2)(ii) of this section and, if desired, the name of food product], as part of a diet low in saturated fat and cholesterol, may reduce the risk of heart disease. A serving of [name of food] supplies _____ grams of the [grams of soluble fiber specified in paragraph (c)(2)(i)(G) of this section] soluble fiber from [name of the soluble fiber source from paragraph (c)(2)(ii) of this section] necessary per day to have this effect.

(2) Diets low in saturated fat and cholesterol that include [_____ grams of soluble fiber specified in paragraph (c)(2)(i)(G) of this section] of soluble fiber per day from [name of soluble fiber source from paragraph (c)(2)(ii) of this section and, if desired, the name of the food product] may reduce the risk of heart disease. One serving of [name of food] provides _____ grams of this soluble fiber.

[62 FR 3600, Jan. 23, 1997, as amended at 62 FR 15344, Mar. 31, 1997; 63 FR 8119, Feb. 18, 1998; 66 FR 66742, Dec. 27, 2001; 67 FR 61782, Oct. 2, 2002; 68 FR 15355, Mar. 31, 2003; 70 FR 40880, July 15, 2005; 70 FR 76162, Dec. 23, 2005]

§ 101.82 Health claims: Soy protein and risk of coronary heart disease (CHD).

(a) *Relationship between diets that are low in saturated fat and cholesterol and that include soy protein and the risk of CHD.* (1) Cardiovascular disease means diseases of the heart and circulatory system. CHD is one of the most common and serious forms of cardiovascular disease and refers to diseases of the heart muscle and supporting blood vessels. High blood total cholesterol and low density lipoprotein

(LDL)-cholesterol levels are associated with increased risk of developing CHD. High CHD rates occur among people with high total cholesterol levels of 240 milligrams per deciliter (mg/dL) (6.21 millimole per liter (mmol/L)) or above and LDL-cholesterol levels of 160 mg/dL (4.13 mmol/L) or above. Borderline high risk total cholesterol levels range from 200 to 239 mg/dL (5.17 to 6.18 mmol/L) and 130 to 159 mg/dL (3.36 to 4.11 mmol/L) of LDL-cholesterol. The scientific evidence establishes that diets high in saturated fat and cholesterol are associated with increased levels of blood total and LDL-cholesterol and, thus, with increased risk of CHD.

(2) Populations with a low incidence of CHD tend to have relatively low blood total cholesterol and LDL-cholesterol levels. These populations also tend to have dietary patterns that are not only low in total fat, especially saturated fat and cholesterol, but are also relatively high in plant foods that contain dietary fiber and other components.

(3) Scientific evidence demonstrates that diets low in saturated fat and cholesterol may reduce the risk of CHD. Other evidence demonstrates that the addition of soy protein to a diet that is low in saturated fat and cholesterol may also help to reduce the risk of CHD.

(b) *Significance of the relationship between diets that are low in saturated fat and cholesterol and that include soy protein and the risk of CHD.* (1) CHD is a major public health concern in the United States. It accounts for more deaths than any other disease or group of diseases. Early management of risk factors for CHD is a major public health goal that can assist in reducing risk of CHD. High blood total and LDL-cholesterol are major modifiable risk factors in the development of CHD.

(2) Intakes of saturated fat exceed recommended levels in the diets of many people in the United States. One of the major public health recommendations relative to CHD risk is to consume less than 10 percent of calories from saturated fat and an average of 30 percent or less of total calories from all fat. Recommended daily cholesterol intakes are 300 mg or less per day. Scientific evidence demonstrates

that diets low in saturated fat and cholesterol are associated with lower blood total and LDL-cholesterol levels. Soy protein, when included in a low saturated fat and cholesterol diet, also helps to lower blood total and LDL-cholesterol levels.

(c) *Requirements.* (1) All requirements set forth in §101.14 shall be met.

(2) *Specific requirements—(i) Nature of the claim.* A health claim associating diets that are low in saturated fat and cholesterol and that include soy protein with reduced risk of heart disease may be made on the label or labeling of a food described in paragraph (c)(2)(iii) of this section, provided that:

(A) The claim states that diets that are low in saturated fat and cholesterol and that include soy protein “may” or “might” reduce the risk of heart disease;

(B) In specifying the disease, the claim uses the following terms: “heart disease” or “coronary heart disease”;

(C) In specifying the substance, the claim uses the term “soy protein”;

(D) In specifying the fat component, the claim uses the terms “saturated fat” and “cholesterol”;

(E) The claim does not attribute any degree of risk reduction for CHD to diets that are low in saturated fat and cholesterol and that include soy protein;

(F) The claim does not imply that consumption of diets that are low in saturated fat and cholesterol and that include soy protein is the only recognized means of achieving a reduced risk of CHD; and

(G) The claim specifies the daily dietary intake of soy protein that is necessary to reduce the risk of coronary heart disease and the contribution one serving of the product makes to the specified daily dietary intake level. The daily dietary intake level of soy protein that has been associated with reduced risk of coronary heart disease is 25 grams (g) or more per day of soy protein.

(ii) *Nature of the substance.* (A) Soy protein from the legume seed *Glycine max*.

(B) FDA will assess qualifying levels of soy protein in the following fashion: FDA will measure total protein content by the appropriate method of

analysis given in the “Official Methods of Analysis of the AOAC International,” as described at §101.9(c)(7). For products that contain no sources of protein other than soy, FDA will consider the amount of soy protein as equivalent to the total protein content. For products that contain a source or sources of protein in addition to soy, FDA will, using the measurement of total protein content, calculate the soy protein content based on the ratio of soy protein ingredients to total protein ingredients in the product. FDA will base its calculation on information identified and supplied by manufacturers, such as nutrient data bases or analyses, recipes or formulations, purchase orders for ingredients, or any other information that reasonably substantiates the ratio of soy protein to total protein. Manufacturers must maintain records sufficient to substantiate the claim for as long as the products are marketed and provide these records, on written request, to appropriate regulatory officials.

(iii) *Nature of the food eligible to bear the claim.* (A) The food product shall contain at least 6.25 g of soy protein per reference amount customarily consumed of the food product;

(B) The food shall meet the nutrient content requirements in §101.62 for a “low saturated fat” and “low cholesterol” food; and

(C) The food shall meet the nutrient content requirement in §101.62 for a “low fat” food, unless it consists of or is derived from whole soybeans and contains no fat in addition to the fat inherently present in the whole soybeans it contains or from which it is derived.

(d) *Optional information.* (1) The claim may state that the development of heart disease depends on many factors and may identify one or more of the following risk factors for heart disease about which there is general scientific agreement: A family history of CHD; elevated blood total and LDL-cholesterol; excess body weight; high blood pressure; cigarette smoking; diabetes; and physical inactivity. The claim may also provide additional information about the benefits of exercise and management of body weight to help lower the risk of heart disease;

(2) The claim may state that the relationship between intake of diets that are low in saturated fat and cholesterol and that include soy protein and reduced risk of heart disease is through the intermediate link of “blood cholesterol” or “blood total and LDL-cholesterol”;

(3) The claim may include information from paragraphs (a) and (b) of this section, which summarize the relationship between diets that are low in saturated fat and cholesterol and that include soy protein and CHD and the significance of the relationship;

(4) The claim may state that a diet low in saturated fat and cholesterol that includes soy protein is consistent with “Nutrition and Your Health: Dietary Guidelines for Americans,” U.S. Department of Agriculture (USDA) and Department of Health and Human Services (DHHS), Government Printing Office (GPO);

(5) The claim may state that individuals with elevated blood total and LDL-cholesterol should consult their physicians for medical advice and treatment. If the claim defines high or normal blood total and LDL-cholesterol levels, then the claim shall state that individuals with high blood cholesterol should consult their physicians for medical advice and treatment;

(6) The claim may include information on the number of people in the United States who have heart disease. The sources of this information shall be identified, and it shall be current information from the National Center for Health Statistics, the National Institutes of Health, or “Nutrition and Your Health: Dietary Guidelines for Americans,” USDA and DHHS, GPO;

(e) *Model health claim.* The following model health claims may be used in food labeling to describe the relationship between diets that are low in saturated fat and cholesterol and that include soy protein and reduced risk of heart disease:

(1) 25 grams of soy protein a day, as part of a diet low in saturated fat and cholesterol, may reduce the risk of heart disease. A serving of [name of food] supplies ___ grams of soy protein.

(2) Diets low in saturated fat and cholesterol that include 25 grams of

soy protein a day may reduce the risk of heart disease. One serving of [name of food] provides ____ grams of soy protein.

[64 FR 57732, Oct. 26, 1999]

EFFECTIVE DATE NOTE: At 64 FR 57732, Oct. 26, 1999, §101.82 was added. Paragraph (c)(2)(ii)(B) contains information collection and recordkeeping requirements and will not become effective until approval has been given by the Office of Management and Budget.

§101.83 Health claims: plant sterol/stanol esters and risk of coronary heart disease (CHD).

(a) *Relationship between diets that include plant sterol/stanol esters and the risk of CHD.* (1) Cardiovascular disease means diseases of the heart and circulatory system. Coronary heart disease (CHD) is one of the most common and serious forms of cardiovascular disease and refers to diseases of the heart muscle and supporting blood vessels. High blood total cholesterol and low density lipoprotein (LDL) cholesterol levels are associated with increased risk of developing coronary heart disease. High CHD rates occur among people with high total cholesterol levels of 240 milligrams per deciliter (mg/dL) (6.21 millimole per liter (mmol/l)) or above and LDL cholesterol levels of 160 mg/dL (4.13 mmol/l) or above. Borderline high risk blood cholesterol levels range from 200 to 239 mg/dL (5.17 to 6.18 mmol/l) for total cholesterol, and 130 to 159 mg/dL (3.36 to 4.11 mmol/l) of LDL cholesterol.

(2) Populations with a low incidence of CHD tend to have relatively low blood total cholesterol and LDL cholesterol levels. These populations also tend to have dietary patterns that are not only low in total fat, especially saturated fat and cholesterol, but are also relatively high in plant foods that contain dietary fiber and other components.

(3) Scientific evidence demonstrates that diets that include plant sterol/stanol esters may reduce the risk of CHD.

(b) *Significance of the relationship between diets that include plant sterol/stanol esters and the risk of CHD.* (1) CHD is a major public health concern in the United States. It accounts for

more deaths than any other disease or group of diseases. Early management of risk factors for CHD is a major public health goal that can assist in reducing risk of CHD. High blood total and LDL cholesterol are major modifiable risk factors in the development of CHD.

(2) The scientific evidence establishes that including plant sterol/stanol esters in the diet helps to lower blood total and LDL cholesterol levels.

(c) *Requirements*—(1) *General.* All requirements set forth in §101.14 shall be met, except §101.14(a)(4) with respect to the disqualifying level for total fat per 50 grams (g) in dressings for salad and spreads and §101.14(e)(6) with respect to dressings for salad.

(2) *Specific requirements*—(i) *Nature of the claim.* A health claim associating diets that include plant sterol/stanol esters with reduced risk of heart disease may be made on the label or labeling of a food described in paragraph (c)(2)(iii) of this section, provided that:

(A) The claim states that plant sterol/stanol esters should be consumed as part of a diet low in saturated fat and cholesterol;

(B) The claim states that diets that include plant sterol/stanol esters “may” or “might” reduce the risk of heart disease;

(C) In specifying the disease, the claim uses the following terms: “heart disease” or “coronary heart disease”;

(D) In specifying the substance, the claim uses the term “plant sterol esters” or “plant stanol esters,” except that if the sole source of the plant sterols or stanols is vegetable oil, the claim may use the term “vegetable oil sterol esters” or “vegetable oil stanol esters”;

(E) The claim does not attribute any degree of risk reduction for CHD to diets that include plant sterol/stanol esters;

(F) The claim does not imply that consumption of diets that include plant sterol/stanol esters is the only recognized means of achieving a reduced risk of CHD; and

(G) The claim specifies the daily dietary intake of plant sterol or stanol esters that is necessary to reduce the risk of CHD and the contribution one serving of the product makes to the

specified daily dietary intake level. Daily dietary intake levels of plant sterol and stanol esters that have been associated with reduced risk of are:

(1) 1.3 g or more per day of plant sterol esters.

(2) 3.4 g or more per day of plant stanol esters.

(H) The claim specifies that the daily dietary intake of plant sterol or stanol esters should be consumed in two servings eaten at different times of the day with other foods.

(ii) *Nature of the substance*—(A) *Plant sterol esters.* (1) Plant sterol esters prepared by esterifying a mixture of plant sterols from edible oils with food-grade fatty acids. The plant sterol mixture shall contain at least 80 percent beta-sitosterol, campesterol, and stigmasterol (combined weight).

(2) FDA will measure plant sterol esters by the method entitled “Determination of the Sterol Content in Margarines, Halvarines, Dressings, Fat Blends and Sterol Fatty Acid Ester Concentrates by Capillary Gas Chromatography,” developed by Unilever United States, Inc., dated February 1, 2000. The method, which is incorporated by reference in accordance with 5 U.S.C. 552(a) and 1 CFR part 51, may be obtained from the Center for Food Safety and Applied Nutrition, Office of Nutritional Products, Labeling, and Dietary Supplements, Division of Nutrition Science and Policy, 5100 Paint Branch Pkwy., College Park, MD 20740, and may be examined at the Center for Food Safety and Applied Nutrition’s Library, 5100 Paint Branch Pkwy., College Park, MD 20740, or at the National Archives and Records Administration (NARA). For information on the availability of this material at NARA, call 202–741–6030, or go to: http://www.archives.gov/federal_register/code_of_federal_regulations/ibr_locations.html.

(B) *Plant stanol esters.* (1) Plant stanol esters prepared by esterifying a mixture of plant stanols derived from edible oils or byproducts of the kraft paper pulping process with food-grade fatty acids. The plant stanol mixture shall contain at least 80 percent sitostanol and campestanol (combined weight).

(2) FDA will measure plant stanol esters by the following methods developed by McNeil Consumer Healthcare dated February 15, 2000: “Determination of Stanols and Sterols in Benecol Tub Spread”; “Determination of Stanols and Sterols in Benecol Dressing”; “Determination of Stanols and Sterols in Benecol Snack Bars”; or “Determination of Stanols and Sterols in Benecol Softgels.” These methods are incorporated by reference in accordance with 5 U.S.C. 552(a) and 1 CFR part 51. Copies may be obtained from the Center for Food Safety and Applied Nutrition, Office of Nutritional Products, Labeling, and Dietary Supplements, Division of Nutrition Science and Policy, 5100 Paint Branch Pkwy., College Park, MD 20740, or may be examined at the Center for Food Safety and Applied Nutrition’s Library, 5100 Paint Branch Pkwy., College Park, MD 20740, and at the National Archives and Records Administration (NARA). For information on the availability of this material at NARA, call 202–741–6030, or go to: http://www.archives.gov/federal_register/code_of_federal_regulations/ibr_locations.html.

(iii) *Nature of the food eligible to bear the claim.* (A) The food product shall contain:

(1) At least 0.65 g of plant sterol esters that comply with paragraph (c)(2)(ii)(A)(1) of this section per reference amount customarily consumed of the food products eligible to bear the health claim, specifically spreads and dressings for salad, or

(2) At least 1.7 g of plant stanol esters that comply with paragraph (c)(2)(ii)(B)(1) of this section per reference amount customarily consumed of the food products eligible to bear the health claim, specifically spreads, dressings for salad, snack bars, and dietary supplements in softgel form.

(B) The food shall meet the nutrient content requirements in §101.62 for a “low saturated fat” and “low cholesterol” food; and

(C) The food must meet the limit for total fat in §101.14(a)(4), except that spreads and dressings for salad are not required to meet the limit for total fat per 50 g if the label of the food bears a

disclosure statement that complies with § 101.13(h); and

(D) The food must meet the minimum nutrient contribution requirement in § 101.14(e)(6) unless it is a dressing for salad.

(d) *Optional information.* (1) The claim may state that the development of heart disease depends on many factors and may identify one or more of the following risk factors for heart disease about which there is general scientific agreement: A family history of CHD; elevated blood total and LDL cholesterol; excess body weight; high blood pressure; cigarette smoking; diabetes; and physical inactivity. The claim may also provide additional information about the benefits of exercise and management of body weight to help lower the risk of heart disease.

(2) The claim may state that the relationship between intake of diets that include plant sterol/stanol esters and reduced risk of heart disease is through the intermediate link of “blood cholesterol” or “blood total and LDL cholesterol.”

(3) The claim may include information from paragraphs (a) and (b) of this section, which summarize the relationship between diets that include plant sterol/stanol esters and the risk of CHD and the significance of the relationship.

(4) The claim may include information from the following paragraph on the relationship between saturated fat and cholesterol in the diet and the risk of CHD: The scientific evidence establishes that diets high in saturated fat and cholesterol are associated with increased levels of blood total and LDL cholesterol and, thus, with increased risk of CHD. Intakes of saturated fat exceed recommended levels in the diets of many people in the United States. One of the major public health recommendations relative to CHD risk is to consume less than 10 percent of calories from saturated fat and an average of 30 percent or less of total calories from all fat. Recommended daily cholesterol intakes are 300 mg or less per day. Scientific evidence demonstrates that diets low in saturated fat and cholesterol are associated with lower blood total and LDL cholesterol levels.

(5) The claim may state that diets that include plant sterol or stanol esters and are low in saturated fat and cholesterol are consistent with “Nutrition and Your Health: Dietary Guidelines for Americans,” U.S. Department of Agriculture (USDA) and Department of Health and Human Services (DHHS), Government Printing Office (GPO).

(6) The claim may state that individuals with elevated blood total and LDL cholesterol should consult their physicians for medical advice and treatment. If the claim defines high or normal blood total and LDL cholesterol levels, then the claim shall state that individuals with high blood cholesterol should consult their physicians for medical advice and treatment.

(7) The claim may include information on the number of people in the United States who have heart disease. The sources of this information shall be identified, and it shall be current information from the National Center for Health Statistics, the National Institutes of Health, or “Nutrition and Your Health: Dietary Guidelines for Americans,” U.S. Department of Agriculture (USDA) and Department of Health and Human Services (DHHS), Government Printing Office (GPO).

(e) *Model health claim.* The following model health claims may be used in food labeling to describe the relationship between diets that include plant sterol or stanol esters and reduced risk of heart disease:

(1) *For plant sterol esters:* (i) Foods containing at least 0.65 g per serving of plant sterol esters, eaten twice a day with meals for a daily total intake of at least 1.3 g, as part of a diet low in saturated fat and cholesterol, may reduce the risk of heart disease. A serving of [name of the food] supplies _____ grams of vegetable oil sterol esters.

(ii) Diets low in saturated fat and cholesterol that include two servings of foods that provide a daily total of at least 1.3 g of vegetable oil sterol esters in two meals may reduce the risk of heart disease. A serving of [name of the food] supplies _____ grams of vegetable oil sterol esters.

(2) *For plant stanol esters:* (i) Foods containing at least 1.7 g per serving of

plant stanol esters, eaten twice a day with meals for a total daily intake of at least 3.4 g, as part of a diet low in saturated fat and cholesterol, may reduce the risk of heart disease. A serving of [name of the food] supplies _____ grams of plant stanol esters.

(ii) Diets low in saturated fat and cholesterol that include two servings of foods that provide a daily total of at least 3.4 g of vegetable oil stanol esters in two meals may reduce the risk of heart disease. A serving of [name of the food] supplies _____ grams of vegetable oil stanol esters.

[65 FR 54717, Sept. 8, 2000; 65 FR 70466, Nov. 24, 2000, as amended at 66 FR 66742, Dec. 27, 2001; 68 FR 15355, Mar. 31, 2003; 70 FR 41958, July 21, 2005]

Subpart F—Specific Requirements for Descriptive Claims That Are Neither Nutrient Content Claims nor Health Claims

§ 101.93 Certain types of statements for dietary supplements.

(a)(1) No later than 30 days after the first marketing of a dietary supplement that bears one of the statements listed in section 403(r)(6) or the Federal Food, Drug, and Cosmetic Act, the manufacturer, packer, or distributor of the dietary supplement shall notify the Office of Nutritional Products, Labeling and Dietary Supplements (HFS-810), Center for Food Safety and Applied Nutrition, Food and Drug Administration, 5100 Paint Branch Pkwy., College Park, MD 20740, that it has included such a statement on the label or in the labeling of its product. An original and two copies of this notification shall be submitted.

(2) The notification shall include the following:

(i) The name and address of the manufacturer, packer, or distributor of the dietary supplement that bears the statement;

(ii) The text of the statement that is being made;

(iii) The name of the dietary ingredient or supplement that is the subject of the statement, if not provided in the text of the statement; and

(iv) The name of the dietary supplement (including brand name), if not provided in response to paragraph

(a)(2)(iii) on whose label, or in whose labeling, the statement appears.

(3) The notice shall be signed by a responsible individual or the person who can certify the accuracy of the information presented and contained in the notice. The individual shall certify that the information contained in the notice is complete and accurate, and that the notifying firm has substantiation that the statement is truthful and not misleading.

(b) *Disclaimer.* The requirements in this section apply to the label or labeling of dietary supplements where the dietary supplement bears a statement that is provided for by section 403(r)(6) of the Federal Food, Drug, and Cosmetic Act (the act), and the manufacturer, packer, or distributor wishes to take advantage of the exemption to section 201(g)(1)(C) of the act that is provided by compliance with section 403(r)(6) of the act.

(c) *Text for disclaimer.* (1) Where there is one statement, the disclaimer shall be placed in accordance with paragraph (d) of this section and shall state:

This statement has not been evaluated by the Food and Drug Administration. This product is not intended to diagnose, treat, cure, or prevent any disease.

(2) Where there is more than one such statement on the label or in the labeling, each statement shall bear the disclaimer in accordance with paragraph (c)(1) of this section, or a plural disclaimer may be placed in accordance with paragraph (d) of this section and shall state:

These statements have not been evaluated by the Food and Drug Administration. This product is not intended to diagnose, treat, cure, or prevent any disease.

(d) *Placement.* The disclaimer shall be placed adjacent to the statement with no intervening material or linked to the statement with a symbol (e.g., an asterisk) at the end of each such statement that refers to the same symbol placed adjacent to the disclaimer specified in paragraphs (c)(1) or (c)(2) of this section. On product labels and in labeling (e.g., pamphlets, catalogs), the disclaimer shall appear on each panel or page where there such is a statement. The disclaimer shall be set off in a box

where it is not adjacent to the statement in question.

(e) *Typesize.* The disclaimer in paragraph (c) of this section shall appear in boldface type in letters of a typesize no smaller than one-sixteenth inch.

(f) *Permitted structure/function statements.* Dietary supplement labels or labeling may, subject to the requirements in paragraphs (a) through (e) of this section, bear statements that describe the role of a nutrient or dietary ingredient intended to affect the structure or function in humans or that characterize the documented mechanism by which a nutrient or dietary ingredient acts to maintain such structure or function, provided that such statements are not disease claims under paragraph (g) of this section. If the label or labeling of a product marketed as a dietary supplement bears a disease claim as defined in paragraph (g) of this section, the product will be subject to regulation as a drug unless the claim is an authorized health claim for which the product qualifies.

(g) *Disease claims.* (1) For purposes of 21 U.S.C. 343(r)(6), a “disease” is damage to an organ, part, structure, or system of the body such that it does not function properly (e.g., cardiovascular disease), or a state of health leading to such dysfunctioning (e.g., hypertension); except that diseases resulting from essential nutrient deficiencies (e.g., scurvy, pellagra) are not included in this definition.

(2) FDA will find that a statement about a product claims to diagnose, mitigate, treat, cure, or prevent disease (other than a classical nutrient deficiency disease) under 21 U.S.C. 343(r)(6) if it meets one or more of the criteria listed below. These criteria are not intended to classify as disease claims statements that refer to the ability of a product to maintain healthy structure or function, unless the statement implies disease prevention or treatment. In determining whether a statement is a disease claim under these criteria, FDA will consider the context in which the claim is presented. A statement claims to diagnose, mitigate, treat, cure, or prevent disease if it claims, explicitly or implicitly, that the product:

(i) Has an effect on a specific disease or class of diseases;

(ii) Has an effect on the characteristic signs or symptoms of a specific disease or class of diseases, using scientific or lay terminology;

(iii) Has an effect on an abnormal condition associated with a natural state or process, if the abnormal condition is uncommon or can cause significant or permanent harm;

(iv) Has an effect on a disease or diseases through one or more of the following factors:

(A) The name of the product;

(B) A statement about the formulation of the product, including a claim that the product contains an ingredient (other than an ingredient that is an article included in the definition of “dietary supplement” under 21 U.S.C. 321(ff)(3)) that has been regulated by FDA as a drug and is well known to consumers for its use or claimed use in preventing or treating a disease;

(C) Citation of a publication or reference, if the citation refers to a disease use, and if, in the context of the labeling as a whole, the citation implies treatment or prevention of a disease, e.g., through placement on the immediate product label or packaging, inappropriate prominence, or lack of relationship to the product’s express claims;

(D) Use of the term “disease” or “diseased,” except in general statements about disease prevention that do not refer explicitly or implicitly to a specific disease or class of diseases or to a specific product or ingredient; or

(E) Use of pictures, vignettes, symbols, or other means;

(v) Belongs to a class of products that is intended to diagnose, mitigate, treat, cure, or prevent a disease;

(vi) Is a substitute for a product that is a therapy for a disease;

(vii) Augments a particular therapy or drug action that is intended to diagnose, mitigate, treat, cure, or prevent a disease or class of diseases;

(viii) Has a role in the body’s response to a disease or to a vector of disease;

(ix) Treats, prevents, or mitigates adverse events associated with a therapy for a disease, if the adverse events constitute diseases; or

§ 101.95

(x) Otherwise suggests an effect on a disease or diseases.

[62 FR 49886, Sept. 23, 1997, as amended at 62 FR 49867, Sept. 23, 1997; 65 FR 1050, Jan. 6, 2000; 66 FR 17358, Mar. 30, 2001; 66 FR 56035, Nov. 6, 2001]

§ 101.95 “Fresh,” “freshly frozen,” “fresh frozen,” “frozen fresh.”

The terms defined in this section may be used on the label or in labeling of a food in conformity with the provisions of this section. The requirements of the section pertain to any use of the subject terms as described in paragraphs (a) and (b) of this section that expressly or implicitly refers to the food on labels or labeling, including use in a brand name and use as a sensory modifier. However, the use of the term “fresh” on labels or labeling is not subject to the requirements of paragraph (a) of this section if the term does not suggest or imply that a food is unprocessed or unpreserved. For example, the term “fresh” used to describe pasteurized whole milk is not subject to paragraph (a) of this section because the term does not imply that the food is unprocessed (consumers commonly understand that milk is nearly always pasteurized). However, the term “fresh” to describe pasta sauce that has been pasteurized or that contains pasteurized ingredients would be subject to paragraph (a) of this section because the term implies that the food is not processed or preserved. Uses of fresh not subject to this regulation will be governed by the provisions of 403(a) of the Federal Food, Drug, and Cosmetic Act (the act).

(a) The term “fresh,” when used on the label or in labeling of a food in a manner that suggests or implies that the food is unprocessed, means that the food is in its raw state and has not been frozen or subjected to any form of thermal processing or any other form of preservation, except as provided in paragraph (c) of this section.

(b) The terms “fresh frozen” and “frozen fresh,” when used on the label or in labeling of a food, mean that the food was quickly frozen while still fresh (i.e., the food had been recently harvested when frozen). Blanching of the food before freezing will not preclude use of the term “fresh frozen” to

21 CFR Ch. I (4–1–07 Edition)

describe the food. “Quickly frozen” means frozen by a freezing system such as blast-freezing (sub-zero Fahrenheit temperature with fast moving air directed at the food) that ensures the food is frozen, even to the center of the food, quickly and that virtually no deterioration has taken place.

(c) *Provisions and restrictions.* (1) The following do not preclude the food from use of the term “fresh:”

(i) The addition of approved waxes or coatings;

(ii) The post-harvest use of approved pesticides;

(iii) The application of a mild chlorine wash or mild acid wash on produce; or

(iv) The treatment of raw foods with ionizing radiation not to exceed the maximum dose of 1 kiloGray in accordance with §179.26 of this chapter.

(2) A food meeting the definition in paragraph (a) of this section that is refrigerated is not precluded from use of “fresh” as provided by this section.

[58 FR 2426, Jan. 6, 1993]

Subpart G—Exemptions From Food Labeling Requirements

§ 101.100 Food; exemptions from labeling.

(a) The following foods are exempt from compliance with the requirements of section 403(i)(2) of the act (requiring a declaration on the label of the common or usual name of each ingredient when the food is fabricated from two or more ingredients).

(1) An assortment of different items of food, when variations in the items that make up different packages packed from such assortment normally occur in good packing practice and when such variations result in variations in the ingredients in different packages, with respect to any ingredient that is not common to all packages. Such exemption, however, shall be on the condition that the label shall bear, in conjunction with the names of such ingredients as are common to all packages, a statement (in terms that are as informative as practicable and that are not misleading) indicating by name other ingredients which may be present.

(2) A food having been received in bulk containers at a retail establishment, if displayed to the purchaser with either:

(i) The labeling of the bulk container plainly in view, provided ingredient information appears prominently and conspicuously in lettering of not less than one-fourth of an inch in height; or

(ii) A counter card, sign, or other appropriate device bearing prominently and conspicuously, but in no case with lettering of less than one-fourth of an inch in height, the information required to be stated on the label pursuant to section 403(i)(2) of the Federal Food, Drug, and Cosmetic Act (the act).

(3) Incidental additives that are present in a food at insignificant levels and do not have any technical or functional effect in that food. For the purposes of this paragraph (a)(3), incidental additives are:

(i) Substances that have no technical or functional effect but are present in a food by reason of having been incorporated into the food as an ingredient of another food, in which the substance did have a functional or technical effect.

(ii) Processing aids, which are as follows:

(a) Substances that are added to a food during the processing of such food but are removed in some manner from the food before it is packaged in its finished form.

(b) Substances that are added to a food during processing, are converted into constituents normally present in the food, and do not significantly increase the amount of the constituents naturally found in the food.

(c) Substances that are added to a food for their technical or functional effect in the processing but are present in the finished food at insignificant levels and do not have any technical or functional effect in that food.

(iii) Substances migrating to food from equipment or packaging or otherwise affecting food that are not food additives as defined in section 201(s) of the act; or if they are food additives as so defined, they are used in conformity with regulations established pursuant to section 409 of the act.

(4) For the purposes of paragraph (a)(3) of this section, any sulfiting agent (sulfur dioxide, sodium sulfite, sodium bisulfite, potassium bisulfite, sodium metabisulfite, and potassium metabisulfite) that has been added to any food or to any ingredient in any food and that has no technical effect in that food will be considered to be present in an insignificant amount only if no detectable amount of the agent is present in the finished food. A detectable amount of sulfiting agent is 10 parts per million or more of the sulfite in the finished food. Compliance with this paragraph will be determined using sections 20.123–20.125, “Total Sulfurous Acid,” in “Official Methods of Analysis of the Association of Official Analytical Chemists,” 14th Ed. (1984), which is incorporated by reference and the refinements of the “Total Sulfurous Acid” procedure in the “Monier-Williams Procedure (with Modifications) for Sulfites in Foods,” which is appendix A to part 101. A copy of sections 20.123–20.125 of the Official Methods of Analysis of the Association of Official Analytical Chemists” is available from the AOAC INTERNATIONAL, 481 North Frederick Ave., suite 500, Gaithersburg, MD 20877, or available for inspection at the National Archives and Records Administration (NARA). For information on the availability of this material at NARA, call 202-741-6030, or go to: http://www.archives.gov/federal_register/code_of_federal_regulations/ibr_locations.html.

(b) A food repackaged in a retail establishment is exempt from the following provisions of the act if the conditions specified are met.

(1) Section 403(e)(1) of the act (requiring a statement on the label of the name and place of business of the manufacturer, packer, or distributor).

(2) Section 403(g)(2) of the act (requiring the label of a food which purports to be or is represented as one for which a definition and standard of identity has been prescribed to bear the name of the food specified in the definition and standard and, insofar as may be required by the regulation establishing the standard the common names of the optional ingredients present in the food), if the food is displayed to the

purchaser with its interstate labeling clearly in view, or with a counter card, sign, or other appropriate device bearing prominently and conspicuously the information required by these provisions.

(3) Section 403(i)(1) of the act (requiring the label to bear the common or usual name of the food), if the food is displayed to the purchaser with its interstate labeling clearly in view, or with a counter card, sign, or other appropriate device bearing prominently and conspicuously the common or usual name of the food, or if the common or usual name of the food is clearly revealed by its appearance.

(c) An open container (a container of rigid or semirigid construction, which is not closed by lid, wrapper, or otherwise other than by an uncolored transparent wrapper which does not obscure the contents) of a fresh fruit or fresh vegetable, the quantity of contents of which is not more than 1 dry quart, shall be exempt from the labeling requirements of sections 403(e), (g)(2) (with respect to the name of the food specified in the definition and standard), and (i)(1) of the act; but such exemption shall be on the condition that if two or more such containers are enclosed in a crate or other shipping package, such crate or package shall bear labeling showing the number of such containers enclosed therein and the quantity of the contents of each.

(d) Except as provided by paragraphs (e) and (f) of this section, a shipment or other delivery of a food which is, in accordance with the practice of the trade, to be processed, labeled, or repacked in substantial quantity at an establishment other than that where originally processed or packed, shall be exempt, during the time of introduction into and movement in interstate commerce and the time of holding in such establishment, from compliance with the labeling requirements of section 403 (c), (e), (g), (h), (i), (k), and (q) of the act if:

(1) The person who introduced such shipment or delivery into interstate commerce is the operator of the establishment where such food is to be processed, labeled, or repacked; or

(2) In case such person is not such operator, such shipment or delivery is made to such establishment under a

written agreement, signed by and containing the post office addresses of such person and such operator, and containing such specifications for the processing, labeling, or repacking, as the case may be, of such food in such establishment as will ensure, if such specifications are followed, that such food will not be adulterated or misbranded within the meaning of the act upon completion of such processing, labeling, or repacking. Such person and such operator shall each keep a copy of such agreement until 2 years after the final shipment or delivery of such food from such establishment, and shall make such copies available for inspection at any reasonable hour to any officer or employee of the Department who requests them.

(3) The article is an egg product subject to a standard of identity promulgated in part 160 of this chapter, is to be shipped under the conditions specified in paragraph (d) (1) or (2) of this section and for the purpose of pasteurization or other treatment as required in such standard, and each container of such egg product bears a conspicuous tag or label reading "Caution—This egg product has not been pasteurized or otherwise treated to destroy viable *Salmonella* microorganisms". In addition to safe and suitable bactericidal processes designed specifically for *Salmonella* destruction in egg products, the term "other treatment" in the first sentence of this paragraph shall include use in acidic dressings in the processing of which the pH is not above 4.1 and the acidity of the aqueous phase, expressed as acetic acid, is not less than 1.4 percent, subject also to the conditions that:

(i) The agreement required in paragraph (d)(2) of this section shall also state that the operator agrees to utilize such unpasteurized egg products in the processing of acidic dressings according to the specifications for pH and acidity set forth in this paragraph, agrees not to deliver the acidic dressing to a user until at least 72 hours after such egg product is incorporated in such acidic dressing, and agrees to maintain for inspection adequate records covering such processing for 2 years after such processing.

(ii) In addition to the caution statement referred to above, the container of such egg product shall also bear the statement "Unpasteurized _____ for use in acidic dressings only", the blank being filled in with the applicable name of the eggs or egg product.

(e) Conditions affecting expiration of exemptions: (1) An exemption of a shipment or other delivery of a food under paragraph (d) (1) or (3) of this section shall, at the beginning of the act of removing such shipment or delivery, or any part thereof, from such establishment become void ab initio if the food comprising such shipment, delivery, or part is adulterated or misbranded within the meaning of the act when so removed.

(2) An exemption of a shipment or other delivery of a food under paragraph (d) (2) or (3) of this section shall become void ab initio with respect to the person who introduced such shipment or delivery into interstate commerce upon refusal by such person to make available for inspection a copy of the agreement, as required by paragraph (d) (2) or (3) of this section.

(3) An exemption of a shipment or other delivery of a food under paragraph (d) (2) or (3) of this section shall expire:

(i) At the beginning of the act of removing such shipment or delivery, or any part thereof, from such establishment if the food constituting such shipment, delivery, or part is adulterated or misbranded within the meaning of the act when so removed; or

(ii) Upon refusal by the operator of the establishment where such food is to be processed, labeled, or repacked, to make available for inspection a copy of the agreement, as required by such paragraph.

(f) The word "processed" as used in this paragraph shall include the holding of cheese in a suitable warehouse at a temperature of not less than 35 °F for the purpose of aging or curing to bring the cheese into compliance with requirements of an applicable definition and standard of identity. The exemptions provided for in paragraph (d) of this section shall apply to cheese which is, in accordance with the practice of the trade, shipped to a warehouse for aging or curing, on condition that the

cheese is identified in the manner set forth in one of the applicable following paragraphs, and in such case the provisions of paragraph (e) of this section shall also apply:

(1) In the case of varieties of cheese for which definitions and standards of identity require a period of aging whether or not they are made from pasteurized milk, each such cheese shall bear on the cheese a legible mark showing the date at which the preliminary manufacturing process has been completed and at which date curing commences, and to each cheese, on its wrapper or immediate container, shall be affixed a removable tag bearing the statement "Uncured _____ cheese for completion of curing and proper labeling", the blank being filled in with the applicable name of the variety of cheese. In the case of swiss cheese, the date at which the preliminary manufacturing process had been completed and at which date curing commences is the date on which the shaped curd is removed from immersion in saturated salt solution as provided in the definition and standard of identity for swiss cheese, and such cheese shall bear a removable tag reading, "To be cured and labeled as 'swiss cheese,' but if eyes do not form, to be labeled as 'swiss cheese for manufacturing'".

(2) In the case of varieties of cheeses which when made from unpasteurized milk are required to be aged for not less than 60 days, each such cheese shall bear a legible mark on the cheese showing the date at which the preliminary manufacturing process has been completed and at which date curing commences, and to each such cheese or its wrapper or immediate container shall be affixed a removable tag reading, "_____ cheese made from unpasteurized milk. For completion of curing and proper labeling", the blank being filled in with the applicable name of the variety of cheese.

(3) In the case of cheddar cheese, washed curd cheese, colby cheese, granular cheese, and brick cheese made from unpasteurized milk, each such cheese shall bear a legible mark on the cheese showing the date at which the preliminary manufacturing process has been completed and at which date curing commences, and to each such

cheese or its wrapper or immediate container shall be affixed a removable tag reading “_____ cheese made from unpasteurized milk. For completion of curing and proper labeling, or for labeling as _____ cheese for manufacturing”, the blank being filled in with the applicable name of the variety of cheese.

(g) The label declaration of a harmless marker used to identify a particular manufacturer’s product may result in unfair competition through revealing a trade secret. Exemption from the label declaration of such a marker is granted, therefore, provided that the following conditions are met:

(1) The person desiring to use the marker without label declaration of its presence has submitted to the Commissioner of Food and Drugs full information concerning the proposed usage and the reasons why he believes label declaration of the marker should be subject to this exemption; and

(2) The person requesting the exemption has received from the Commissioner of Food and Drugs a finding that the marker is harmless and that the exemption has been granted.

(h) Wrapped fish fillets of nonuniform weight intended to be unpacked and marked with the correct weight at or before the point of retail sale in an establishment other than that where originally packed shall be exempt from the requirement of section 403(e)(2) of the act during introduction and movement in interstate commerce and while held for sale prior to weighing and marking:

(1) *Provided*, That (i) The outside container bears a label declaration of the total net weight; and

(ii) The individual packages bear a conspicuous statement “To be weighed at or before time of sale” and a correct statement setting forth the weight of the wrapper;

(2) *Provided further*, That it is the practice of the retail establishment to weigh and mark the individual packages with a correct net-weight statement prior to or at the point of retail sale. A statement of the weight of the wrapper shall be set forth so as to be readily read and understood, using such term as “wrapper tare—ounce”, the blank being filled in with the cor-

rect average weight of the wrapper used.

(3) The act of delivering the wrapped fish fillets during the retail sale without the correct net-weight statement shall be deemed an act which results in the product’s being misbranded while held for sale. Nothing in this paragraph shall be construed as requiring net-weight statements for wrapped fish fillets delivered into institutional trade provided the outside container bears the required information.

(i) Wrapped clusters (consumer units) of bananas of nonuniform weight intended to be unpacked from a master carton or container and weighed at or before the point of retail sale in an establishment other than that where originally packed shall be exempt from the requirements of section 403(e)(2) of the act during introduction and movement in interstate commerce and while held for sale prior to weighing:

(1) *Provided*, That (i) The master carton or container bears a label declaration of the total net weight; and

(ii) The individual packages bear a conspicuous statement “To be weighed at or before the time of sale” and a correct statement setting forth the weight of the wrapper; using such term as “wrapper tare __ ounce”, the blank being filled in with the correct average weight of the wrapper used;

(2) *Provided further*, That it is the practice of the retail establishment to weigh the individual packages either prior to or at the time of retail sale.

(3) The act of delivering the wrapped clusters (consumer units) during the retail sale without an accurate net weight statement or alternatively without weighing at the time of sale shall be deemed an act which results in the product’s being misbranded while held for sale. Nothing in this paragraph shall be construed as requiring net-weight statements for clusters (consumer units) delivered into institutional trade, provided that the master container or carton bears the required information.

[42 FR 14308, Mar. 15, 1977, as amended at 51 FR 25017, July 9, 1986; 58 FR 2188, 2876, Jan. 6, 1993; 66 FR 17358, Mar. 30, 2001]

§ 101.105 Declaration of net quantity of contents when exempt.

(a) The principal display panel of a food in package form shall bear a declaration of the net quantity of contents. This shall be expressed in the terms of weight, measure, numerical count, or a combination of numerical count and weight or measure. The statement shall be in terms of fluid measure if the food is liquid, or in terms of weight if the food is solid, semisolid, or viscous, or a mixture of solid and liquid; except that such statement may be in terms of dry measure if the food is a fresh fruit, fresh vegetable, or other dry commodity that is customarily sold by dry measure. If there is a firmly established general consumer usage and trade custom of declaring the contents of a liquid by weight, or a solid, semisolid, or viscous product by fluid measure, it may be used. Whenever the Commissioner determines that an existing practice of declaring net quantity of contents by weight, measure, numerical count, or a combination in the case of a specific packaged food does not facilitate value comparisons by consumers and offers opportunity for consumer confusion, he will by regulation designate the appropriate term or terms to be used for such commodity.

(b)(1) Statements of weight shall be in terms of avoirdupois pound and ounce.

(2) Statements of fluid measure shall be in terms of the U.S. gallon of 231 cubic inches and quart, pint, and fluid ounce subdivisions thereof, and shall:

(i) In the case of frozen food that is sold and consumed in a frozen state, express the volume at the frozen temperature.

(ii) In the case of refrigerated food that is sold in the refrigerated state, express the volume at 40 °F (4 °C).

(iii) In the case of other foods, express the volume at 68 °F (20 °C).

(3) Statements of dry measure shall be in terms of the U.S. bushel of 2,150.42 cubic inches and peck, dry quart, and dry pint subdivisions thereof.

(c) When the declaration of quantity of contents by numerical count does not give adequate information as to the quantity of food in the package, it

shall be combined with such statement of weight, measure, or size of the individual units of the foods as will provide such information.

(d) The declaration may contain common or decimal fractions. A common fraction shall be in terms of halves, quarters, eighths, sixteenths, or thirty-seconds; except that if there exists a firmly established general consumer usage and trade custom of employing different common fractions in the net quantity declaration of a particular commodity, they may be employed. A common fraction shall be reduced to its lowest terms; a decimal fraction shall not be carried out to more than two places. A statement that includes small fractions of an ounce shall be deemed to permit smaller variations than one which does not include such fractions.

(e) The declaration shall be located on the principal display panel of the label, and with respect to packages bearing alternate principal panels it shall be duplicated on each principal display panel.

(f) The declaration shall appear as a distinct item on the principal display panel, shall be separated (by at least a space equal to the height of the lettering used in the declaration) from other printed label information appearing above or below the declaration and (by at least a space equal to twice the width of the letter "N" of the style of type used in the quantity of contents statement) from other printed label information appearing to the left or right of the declaration. It shall not include any term qualifying a unit of weight, measure, or count (such as "jumbo quart" and "full gallon") that tends to exaggerate the amount of the food in the container. It shall be placed on the principal display panel within the bottom 30 percent of the area of the label panel in lines generally parallel to the base on which the package rests as it is designed to be displayed: *Provided*, That on packages having a principal display panel of 5 square inches or less, the requirement for placement within the bottom 30 percent of the area of the label panel shall not apply when the declaration of net quantity of contents meets the other requirements of this part.

(g) The declaration shall accurately reveal the quantity of food in the package exclusive of wrappers and other material packed therewith: *Provided*, That in the case of foods packed in containers designed to deliver the food under pressure, the declaration shall state the net quantity of the contents that will be expelled when the instructions for use as shown on the container are followed. The propellant is included in the net quantity declaration.

(h) The declaration shall appear in conspicuous and easily legible boldface print or type in distinct contrast (by typography, layout, color, embossing, or molding) to other matter on the package; except that a declaration of net quantity blown, embossed, or molded on a glass or plastic surface is permissible when all label information is so formed on the surface. Requirements of conspicuousness and legibility shall include the specifications that:

(1) The ratio of height to width (of the letter) shall not exceed a differential of 3 units to 1 unit (no more than 3 times as high as it is wide).

(2) Letter heights pertain to upper case or capital letters. When upper and lower case or all lower case letters are used, it is the lower case letter "o" or its equivalent that shall meet the minimum standards.

(3) When fractions are used, each component numeral shall meet one-half the minimum height standards.

(i) The declaration shall be in letters and numerals in a type size established in relationship to the area of the principal display panel of the package and shall be uniform for all packages of substantially the same size by complying with the following type specifications:

(1) Not less than one-sixteenth inch in height on packages the principal display panel of which has an area of 5 square inches or less.

(2) Not less than one-eighth inch in height on packages the principal display panel of which has an area of more than 5 but not more than 25 square inches.

(3) Not less than three-sixteenths inch in height on packages the principal display panel of which has an area of more than 25 but not more than 100 square inches.

(4) Not less than one-fourth inch in height on packages the principal display panel of which has an area of more than 100 square inches, except not less than ½ inch in height if the area is more than 400 square inches.

Where the declaration is blown, embossed, or molded on a glass or plastic surface rather than by printing, typing, or coloring, the lettering sizes specified in paragraphs (h)(1) through (4) of this section shall be increased by one-sixteenth of an inch.

(j) On packages containing less than 4 pounds or 1 gallon and labeled in terms of weight or fluid measure:

(1) The declaration shall be expressed both in ounces, with identification by weight or by liquid measure and, if applicable (1 pound or 1 pint or more) followed in parentheses by a declaration in pounds for weight units, with any remainder in terms of ounces or common or decimal fractions of the pound (see examples set forth in paragraphs (m) (1) and (2) of this section), or in the case of liquid measure, in the largest whole units (quarts, quarts and pints, or pints, as appropriate) with any remainder in terms of fluid ounces or common or decimal fractions of the pint or quart (see examples in paragraphs (m) (3) and (4) of this section).

(2) If the net quantity of contents declaration appears on a random package, that is a package which is one of a lot, shipment, or delivery of packages of the same consumer commodity with varying weights and with no fixed weight pattern, it may, when the net weight exceeds 1 pound, be expressed in terms of pounds and decimal fractions of the pound carried out to not more than two decimal places. When the net weight does not exceed 1 pound, the declaration on the random package may be in decimal fractions of the pound in lieu of ounces (see example in paragraph (m)(5) of this section).

(3) The declaration may appear in more than one line. The term "net weight" shall be used when stating the net quantity of contents in terms of weight. Use of the terms "net" or "net contents" in terms of fluid measure or numerical count is optional. It is sufficient to distinguish avoidupois ounce from fluid ounce through association of terms; for example, "Net wt. 6 oz" or

“6 oz Net wt.” and “6 fl oz” or “Net contents 6 fl oz”.

(k) On packages containing 4 pounds or 1 gallon or more and labeled in terms of weight or fluid measure, the declaration shall be expressed in pounds for weight units with any remainder in terms of ounces or common or decimal fraction of the pound, or in the case of fluid measure, it shall be expressed in the largest whole unit (gallons followed by common or decimal fraction of a gallon or by the next smaller whole unit or units (quarts, or quarts and pints)) with any remainder in terms of fluid ounces or common or decimal fractions of the pint or quart (see paragraph (m)(6) of this section).

(l) [Reserved]

(m) Examples:

(1) A declaration of 1½ pounds weight shall be expressed as “Net Wt. 24 oz (1 lb 8 oz),” “Net Wt. 24 oz (1½ lb),” or “Net Wt. 24 oz (1.5 lb)”.

(2) A declaration of three-fourths pound avoirdupois weight shall be expressed as “Net Wt. 12 oz”.

(3) A declaration of 1 quart liquid measure shall be expressed as “Net 32 fl oz (1 qt)”.

(4) A declaration of 1¾ quarts liquid measure shall be expressed as “Net contents 56 fluid ounces (1 quart 1½ pints)” or as “Net 56 fluid oz (1 qt 1 pt 8 oz)”, but not in terms of quart and ounce such as “Net 56 fluid oz (1 quart 24 ounces)”.

(5) On a random package, declaration of three-fourths pound avoirdupois may be expressed as “Net Wt. .75 lb”.

(6) A declaration of 2½ gallons liquid measure shall be expressed as “Net contents 2½ gallons,” “Net contents 2.5 gallons,” or “Net contents 2 gallons 2 quarts” and not as “2 gallons 4 pints”.

(n) For quantities, the following abbreviations and none other may be employed (periods and plural forms are optional):

weight wt	pint pt
ounce oz	quart qt
pound lb	fluid fl
gallon gal	

(o) Nothing in this section shall prohibit supplemental statements at locations other than the principal display panel(s) describing in nondeceptive terms the net quantity of contents; *Provided*, that such supplemental state-

ments of net quantity of contents shall not include any term qualifying a unit of weight, measure, or count that tends to exaggerate the amount of the food contained in the package; for example, “jumbo quart” and “full gallon”. Dual or combination declarations of net quantity of contents as provided for in paragraphs (a), (c), and (j) of this section (for example, a combination of net weight plus numerical count, net contents plus dilution directions of a concentrate, etc.) are not regarded as supplemental net quantity statements and may be located on the principal display panel.

(p) A separate statement of the net quantity of contents in terms of the metric system is not regarded as a supplemental statement and an accurate statement of the net quantity of contents in terms of the metric system of weight or measure may also appear on the principal display panel or on other panels.

(q) The declaration of net quantity of contents shall express an accurate statement of the quantity of contents of the package. Reasonable variations caused by loss or gain of moisture during the course of good distribution practice or by unavoidable deviations in good manufacturing practice will be recognized. Variations from stated quantity of contents shall not be unreasonably large.

(r) The declaration of net quantity of contents on pickles and pickle products, including relishes but excluding one or two whole pickles in clear plastic bags which may be declared by count, shall be expressed in terms of the U.S. gallon of 231 cubic inches and quart, pint, and fluid ounce subdivisions thereof.

(s) On a multiunit retail package, a statement of the quantity of contents shall appear on the outside of the package and shall include the number of individual units, the quantity of each individual unit, and, in parentheses, the total quantity of contents of the multiunit package in terms of avoirdupois or fluid ounces, except that such declaration of total quantity need not be followed by an additional parenthetical declaration in terms of the largest whole units and subdivisions thereof, as required by paragraph (j)(1) of this

section. A multiunit retail package may thus be properly labeled: "6-16 oz bottles—(96 fl oz)" or "3-16 oz cans—(net wt. 48 oz)". For the purposes of this section, "multiunit retail package" means a package containing two or more individually packaged units of the identical commodity and in the same quantity, intended to be sold as part of the multiunit retail package but capable of being individually sold in full compliance with all requirements of the regulations in this part. Open multiunit retail packages that do not obscure the number of units or prevent examination of the labeling on each of the individual units are not subject to this paragraph if the labeling of each individual unit complies with the requirements of paragraphs (f) and (i) of this section. The provisions of this section do not apply to that butter or margarine covered by the exemptions in § 1.24(a) (10) and (11) of this chapter.

(t) Where the declaration of net quantity of contents is in terms of net weight and/or drained weight or volume and does not accurately reflect the actual quantity of the contents or the product falls below the applicable standard of fill of container because of equipment malfunction or otherwise unintentional product variation, and the label conforms in all other respects to the requirements of this chapter (except the requirement that food falling below the applicable standard of fill of container shall bear the general statement of substandard fill specified in § 130.14(b) of this chapter), the mislabeled food product, including any food product that fails to bear the general statement of substandard fill specified in § 130.14(b) of this chapter, may be sold by the manufacturer or processor directly to institutions operated by Federal, State or local governments (schools, prisons, hospitals, etc.): *Provided*, That:

(1) The purchaser shall sign a statement at the time of sale stating that he is aware that the product is mislabeled to include acknowledgment of the nature and extent of the mislabeling, (e.g., "Actual net weight may be as low as ___% below labeled quantity") and that any subsequent distribution by him of said product ex-

cept for his own institutional use is unlawful. This statement shall be kept on file at the principal place of business of the manufacturer or processor for 2 years subsequent to the date of shipment of the product and shall be available to the Food and Drug Administration upon request.

(2) The product shall be labeled on the outside of its shipping container with the statement(s):

(i) When the variation concerns net weight and/or drained weight or volume, "Product Mislabeled. Actual net weight (drained weight or volume where appropriate) may be as low as ___% below labeled quantity. This Product Not for Retail Distribution", the blank to be filled in with the maximum percentage variance between the labeled and actual weight or volume of contents of the individual packages in the shipping container, and

(ii) When the variation is in regard to a fill of container standard, "Product Mislabeled. Actual fill may be as low as ___% below standard of fill. This Product Not for Retail Distribution".

(3) The statements required by paragraphs (t)(2) (i) and (ii) of this section, which may be consolidated where appropriate, shall appear prominently and conspicuously as compared to other printed matter on the shipping container and in boldface print or type on a clear, contrasting background in order to render them likely to be read and understood by the purchaser under ordinary conditions of purchase.

[42 FR 14308, Mar. 15, 1977, as amended at 42 FR 15673, Mar. 22, 1977]

§ 101.108 Temporary exemptions for purposes of conducting authorized food labeling experiments.

(a) The food industry is encouraged to experiment voluntarily, under controlled conditions and in collaboration with the Food and Drug Administration, with and other formats for presenting nutrition and other related food labeling information that is consistent with the current quantitative system in §§ 101.9 and 105.66 of this chapter.

(b) Any firm that intends to undertake a labeling experiment that requires exemptions from certain requirements of §§ 101.9 and 105.66 of this

chapter should submit a written proposal containing a thorough discussion of each of the following information items that apply to the particular experiment:

(1) A description of the labeling format to be tested;

(2) A statement of the criteria to be used in the experiment for assigning foods to categories, e.g., nutrient or other values defining "low" and "reduced";

(3) A draft of the material to be used in the store, e.g., shelf tags, booklets, posters, etc.;

(4) The dates on which the experiment will begin and end and on which a written report of analysis of the experimental data will be submitted to FDA, together with a commitment not to continue the experiment beyond the proposed ending date without FDA approval;

(5) The geographic area or areas in which the experiment is to be conducted;

(6) The mechanism to measure the effectiveness of the experiment;

(7) The method for conveying to consumers the required nutrition and other labeling information that is exempted from the label during the experiment;

(8) The method that will be or has been used to determine the actual nutritional characteristics of foods for which a claim is made; and

(9) A statement of the sections of the regulations for which an exemption is sought.

(c) The written proposal should be sent to the Division of Dockets Management (HFA-305), Food and Drug Administration, 5630 Fishers Lane, rm. 1061, Rockville, MD 20852. The proposal should be clearly identified as a request for a temporary exemption for purposes of conducting authorized food labeling experiments and submitted as a citizen petition under §10.30 of this chapter.

(d) Approval for food labeling experiments will be given by FDA in writing. Foods labeled in violation of existing regulations will be subject to regulatory action unless an FDA-approved exemption to the specific regulation has been granted for that specific product.

(e) Reporting requirements contained in §101.108(b) have been approved by this Office of Management and Budget and assigned number 0910-0151.

[48 FR 15240, Apr. 8, 1983, as amended at 59 FR 14364, Mar. 28, 1994; 62 FR 15343, Mar. 31, 1997]

APPENDIX A TO PART 101—MONIER-WILLIAMS PROCEDURE (WITH MODIFICATIONS) FOR SULFITES IN FOOD, CENTER FOR FOOD SAFETY AND APPLIED NUTRITION, FOOD AND DRUG ADMINISTRATION (NOVEMBER 1985)

The AOAC official method for sulfites (*Official Methods of Analysis*, 14th Edition, 20.123-20.125, AOAC INTERNATIONAL) has been modified, in FDA laboratories, to facilitate the determination of sulfites at or near 10 ppm in food. Method instructions, including modifications, are described below.

Apparatus—The apparatus shown diagrammatically (Figure 1) is designed to accomplish the selective transfer of sulfur dioxide from the sample in boiling aqueous hydrochloric acid to a solution of 3% hydrogen peroxide. This apparatus is easier to assemble than the official apparatus and the back pressure inside the apparatus is limited to the unavoidable pressure due to the height of the 3% H₂O₂ solution above the tip of the bubbler (F). Keeping the backpressure as low as possible reduces the likelihood that sulfur dioxide will be lost through leaks.

The apparatus should be assembled as shown in Fig. 1 with a thin film of stopcock grease on the sealing surfaces of all the joints except the joint between the separatory funnel and the flask. Each joint should be clamped together to ensure a complete seal throughout the analysis. The separatory funnel, B, should have a capacity of 100 ml or greater. An inlet adapter, A, with a hose connector (Kontes K-183000 or equivalent) is required to provide a means of applying a head of pressure above the solution. (A pressure equalizing dropping funnel is not recommended because condensate, perhaps with sulfur dioxide, is deposited in the funnel and the side arm.) The round bottom flask, C, is a 1000 ml flask with three 24/40 tapered joints. The gas inlet tube, D, (Kontes K-179000 or equivalent) should be of sufficient length to permit introduction of the nitrogen within 2.5 cm of the bottom of the flask. The Allihn condenser, E, (Kontes K-431000-2430 or equivalent) has a jacket length of 300 mm. The bubbler, F, was fabricated from glass according to the dimensions given in Fig. 2. The 3% hydrogen peroxide solution can be contained in a vessel, G, with an i.d. of ca. 2.5 cm and a depth of 18 cm.

Buret—A 10 ml buret (Fisher Cat. No. 03-848-2A or equivalent) with overflow tube and

hose connections for an Ascarite tube or equivalent air scrubbing apparatus. This will permit the maintenance of a carbon dioxide-free atmosphere over the standardized 0.01N sodium hydroxide.

Chilled Water Circulator—The condenser must be chilled with a coolant, such as 20% methanol-water, maintained at 5 °C. A circulating pump equivalent to the Neslab Coolflow 33 is suitable.

Reagents

(a) *Aqueous hydrochloric acid, 4N*.—For each analysis prepare 90 ml of hydrochloric acid by adding 30 ml of concentrated hydrochloric acid (12N) to 60 ml of distilled water.

(b) *Methyl red indicator*.—Dissolve 250 mg of methyl red in 100 ml ethanol.

(c) *Hydrogen peroxide solution, 3%*.—Dilute ACS reagent grade 30% hydrogen peroxide to 3% with distilled water. Just prior to use, add three drops of methyl red indicator and titrate to a yellow end-point using 0.01N sodium hydroxide. If the end-point is exceeded discard the solution and prepare another 3% H₂O₂ solution.

(d) *Standardized titrant, 0.01N NaOH*.—Certified reagent may be used (Fisher SO-5-284). It should be standardized with reference standard potassium hydrogen phthalate.

(e) *Nitrogen*.—A source of high purity nitrogen is required with a flow regulator that will maintain a flow of 200 cc per minute. To guard against the presence of oxygen in the nitrogen, an oxygen scrubbing solution such as an alkaline pyrogallol trap may be used. Prepare pyrogallol trap as follows:

1. Add 4.5 g pyrogallol to the trap.
2. Purge trap with nitrogen for 2 to 3 minutes.
3. Prepare a KOH solution prepared by adding 65g KOH to 85 ml distilled water (caution: heat).
4. Add the KOH solution to the trap while maintaining an atmosphere of nitrogen in the trap.

Determination

Assemble the apparatus as shown in Fig. 1. The flask C must be positioned in a heating mantle that is controlled by a power regulating device such as Variac or equivalent. Add 400 ml of distilled water to flask C. Close the stopcock of separatory funnel, B, and add 90 ml of 4N hydrochloric acid to the separatory funnel. Begin the flow of nitrogen at a rate of 200±10 cc/min. The condenser coolant flow must be initiated at this time. Add 30 ml of 3% hydrogen peroxide, which has been titrated to a yellow end-point with 0.01N NaOH, to container G. After fifteen minutes the apparatus and the distilled water will be thoroughly de-oxygenated and

the apparatus is ready for sample introduction.

Sample preparation (solids).—Transfer 50 g of food, or a quantity of food with a convenient quantity of SO₂ (500 to 1500 mcg SO₂), to a food processor or blender. Add 100 ml of 5% ethanol in water and briefly grind the mixture. Grinding or blending should be continued only until the food is chopped into pieces small enough to pass through the 24/40 point of flask C.

Sample preparation (liquids).—Mix 50 g of the sample, or a quantity with a convenient quantity of SO₂ (500 to 1500 mcg SO₂), with 100 ml of 5% ethanol in water.

Sample introduction and distillation.—Remove the separatory funnel B, and quantitatively transfer the food sample in aqueous ethanol to flask C. Wipe the tapered joint clean with a laboratory tissue, apply stopcock grease to the outer joint of the separatory funnel, and return the separatory funnel, B, to tapered joint flask C. The nitrogen flow through the 3% hydrogen peroxide solution should resume as soon as the funnel, B, is re-inserted into the appropriate joint in flask C. Examine each joint to ensure that it is sealed.

Apply a head pressure above the hydrochloric acid solution in B with a rubber bulb equipped with a valve. Open the stopcock in B and permit the hydrochloric acid solution to flow into flask C. Continue to maintain sufficient pressure above the acid solution to force the solution into the flask C. The stopcock may be closed, if necessary, to pump up the pressure above the acid and then opened again. Close the stopcock before the last few milliliters drain out of the separatory funnel, B, to guard against the escape of sulfur dioxide into the separatory funnel.

Apply the power to the heating mantle. Use a power setting which will cause 80 to 90 drops per minute of condensate to return to the flask from condenser, E. After 1.75 hours of boiling the contents of the 1000 ml flask and remove trap G.

Titration.—Titrate the contents with 0.01N sodium hydroxide. Titrate with 0.01N NaOH to a yellow end-point that persists for at least twenty seconds. Compute the sulfite content, expressed as micrograms sulfur dioxide per gram of food (ppm) as follows:

$$\text{ppm} = (32.03 \times V_B \times N \times 1000) \div W_t$$

where 32.03=milliequivalent weight of sulfur dioxide; V_B=volume of sodium hydroxide titrant of normality, N, required to reach endpoint; the factor, 1000, converts milliequivalents to microequivalents and W_t=weight (g) of food sample introduced into the 1000 ml flask.

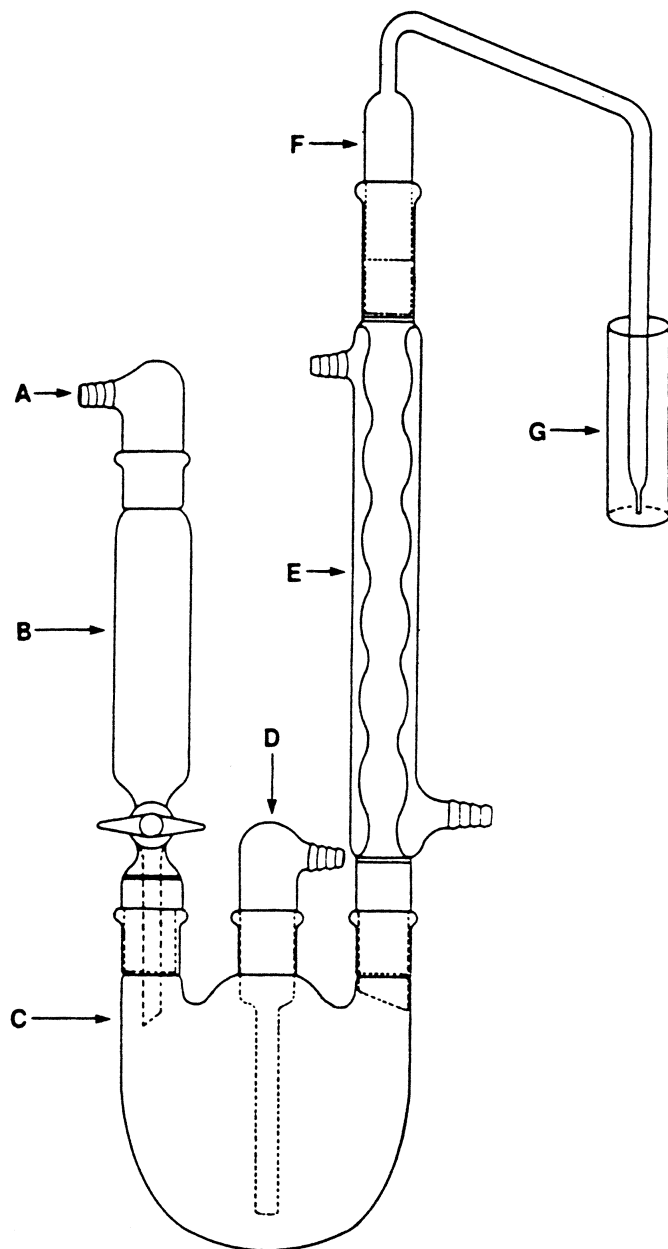

FIGURE 1. THE OPTIMIZED MONIER-WILLIAMS APPARATUS. COMPONENT IDENTIFICATION IS GIVEN IN TEXT.

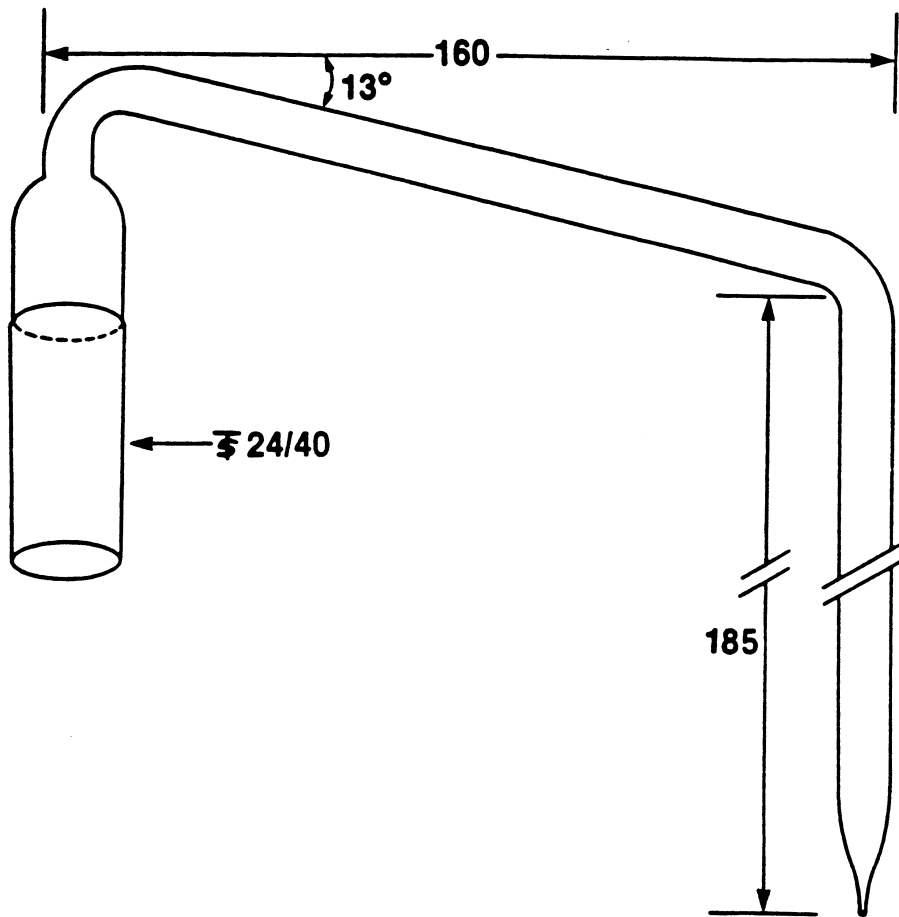

FIGURE 2. DIAGRAM OF BUBBLER (F IN FIGURE 1). LENGTHS ARE GIVEN IN MM.

[42 FR 14308, Mar. 15, 1977, as amended at 51 FR 25017, July 9, 1986]

APPENDIX B TO PART 101—GRAPHIC ENHANCEMENTS USED BY THE FDA

Examples of Graphic Enhancements used by the FDA

A. Overall

1. Nutrition Facts Label is boxed with all black or one color type printed on a white or neutral ground.

B. Typeface and size

1. The "Nutrition Facts" label uses 6 point or larger Helvetica Black and/or Helvetica Regular type. In order to fit some formats the typography may be kerned as much as -4, (tighter kerning reduces legibility).
2. Key nutrients & their % Daily Value are set in 8 point Helvetica Black (but "%" is set in Helvetica Regular).
3. "Nutrition Facts" is set in either Franklin Gothic Heavy or Helvetica Black to fit the width of the label flush left and flush right.
4. "Serving Size" and "Servings per container" are set in 8 point Helvetica Regular with 1 point of leading.
5. The table labels (for example; "Amount per Serving") are set 6 point Helvetica Black.
6. Absolute measures of nutrient content (for example; "1g") and nutrient subgroups are set in 8 point Helvetica Regular with 4 points of leading.
7. Vitamins and minerals are set in 8 point Helvetica Regular, with 4 points of leading, separated by 10 point bullets.
8. All type that appears under vitamins and minerals is set in 6 point Helvetica regular with 1 point of leading.

C. Rules

1. A 7 point rule separates large groupings as shown in example. A 3 point rule separates calorie information from the nutrient information.
2. A hairline rule or 1/4 point rule separates individual nutrients, as shown in the example. Descenders do not touch rule. The top half of the label (nutrient information) has 2 points of leading between the type and the rules, the bottom half of the label (footnotes) has 1 point of leading between the type and the rules.

D. Box

1. All labels are enclosed by 1/2 point box rule within 3 points of text measure.

Examples of Graphic Enhancements used by the FDA

Annotations on the left side of the label:

- Helvetica Regular 8 point with 1 point of leading
- 3 point rule
- 8 point Helvetica Black with 4 points of leading
- 1/4 point rule centered between nutrients (2 points leading above and 2 points below)
- 8 point Helvetica Regular with 4 points of leading
- 8 point Helvetica Regular, 4 points of leading with 10 point bullets.

Annotations on the right side of the label:

- Franklin Gothic Heavy or Helvetica Black, flush left & flush right, no smaller than 13 point
- 7 point rule
- 6 point Helvetica Black
- All labels enclosed by 1/2 point box rule within 3 points of text measure
- 1/4 point rule
- Type below vitamins and minerals (footnotes) is 6 point with 1 point of leading

Amount Per Serving		% Daily Values*	
Calories 260	Calories from Fat 120		
Total Fat 13g			20%
Saturated Fat 5g			25%
Trans Fat 2g			
Cholesterol 30mg			10%
Sodium 660mg			28%
Total Carbohydrate 31g			10%
Dietary Fiber 0g			0%
Sugars 5g			
Protein 5g			
Vitamin A 4%	•	Vitamin C 2%	
Calcium 15%	•	Iron 4%	
*Percent Daily Values are based on a 2,000 calorie diet. Your Daily Values may be higher or lower depending on your calorie needs.			
	Calories:	2,000	2,500
Total Fat	Less than	65g	80g
Sat Fat	Less than	20g	25g
Cholesterol	Less than	300mg	300mg
Sodium	Less than	2,400mg	2,400mg
Total Carbohydrate		300g	375g
Dietary Fiber		25g	30g

[58 FR 17332, Apr. 2, 1993, as amended at 70 FR 41506, July 11, 2005]

APPENDIX C TO PART 101—NUTRITION FACTS FOR RAW FRUITS AND VEGETABLES

Nutrition facts* for raw fruits and vegetables edible portion	Cal-ories from fat	Total fat		Saturated fat		Cholesterol	Sodium	Potassium	Total Car-bonydrate	Dietary Fiber	Sug-ars	Pro-tein	Vita-min A		Vita-min C		Cal-cium	Iron		
		(g)	(%)	(g)	(%)								(mg)	(%)	(%)	(%)			(%)	(%)
Banana, 1 medium (126 g/4.5 oz)	110	0	0	0	0	0	0	400	11	29	10	4	16	1	0	15	0	2		
Apple, 1 medium (154 g/5.5 oz)	80	0	0	0	0	0	0	170	5	22	7	5	20	16	0	2	8	0	2	
Watermelon, 1/8 medium melon; 2 cups diced pieces (280 g/10.0 oz)	80	0	0	0	0	0	0	0	7	27	9	2	8	25	1	20	25	2	4	
Orange, 1 medium (154 g/5.5 oz)	70	0	0	0	0	0	0	230	7	21	7	7	28	14	1	130	6	2	4	
Cantaloupe, 1/4 medium (134 g/4.8 oz)	50	0	0	0	0	0	0	280	8	12	4	1	4	11	1	100	80	2	2	
Grapes, 1 1/2 cups (138 g/4.9 oz)	90	10	2	0	0	0	0	25	1	24	8	1	4	23	1	2	25	2	2	
Grapefruit, 1/2 medium (154 g/5.3 oz) ..	60	0	0	0	0	0	0	230	7	16	5	6	24	10	15	110	2	0	2	
Strawberries, 8 medium (147 g/5.3 oz) ..	45	0	0	0	0	0	0	270	8	12	4	4	16	8	1	160	2	4	4	
Peach, 1 medium (98 g/3.5 oz)	40	0	0	0	0	0	0	190	5	10	3	2	8	9	1	2	10	0	0	
Pear, 1 medium (166 g/5.9 oz)	100	1	2	0	0	0	0	210	6	25	8	4	16	17	1	0	10	2	0	
Nectarine, 1 medium (140 g/5.0 oz)	70	0	0.5	1	0	0	0	300	9	16	5	2	8	12	1	4	15	0	2	
Honeydew Melon, 1/10 medium melon (134 g/4.8 oz)	50	0	0	0	0	0	35	1	310	9	13	4	1	4	12	1	2	45	0	2
Plums, 2 medium (132 g/4.7 oz)	80	10	2	0	0	0	0	220	6	19	6	2	8	10	1	6	20	0	0	
Avocado, California, 1/8 medium (30 g/1.1 oz)	55	45	5	8	1	5	0	170	5	3	1	3	12	0	1	0	4	0	0	
Lemon, 1 medium (58 g/2.1 oz)	15	0	0	0	0	0	5	90	3	5	2	1	4	1	0	0	40	2	0	
Pineapple, 2 slices, 3" diameter, 3/4" thick (112 g/4 oz)	60	0	0	0	0	0	10	115	3	16	5	1	4	13	1	0	25	2	2	
Tangerine, 1 medium (109 g/3.9 oz)	50	0	0.5	1	0	0	0	180	5	15	5	3	12	12	1	0	50	4	0	
Sweet cherries, 21 cherries; 1 cup (140 g/5.0 oz)	90	0	0.5	1	0	0	0	300	9	22	7	3	12	19	2	2	15	2	2	
Kiwifruit, 2 medium (148 g/5.3 oz)	100	10	1	2	0	0	0	480	14	24	8	4	16	16	2	2	240	6	4	
Lime, 1 medium (67 g/2.4 oz)	20	0	0	0	0	0	0	75	2	7	2	2	8	0	0	0	35	0	0	
Potato, 1 medium (148 g/5.3 oz)	100	0	0	0	0	0	0	720	21	26	9	3	12	3	4	0	45	2	6	
Iceberg lettuce, 1/8 medium head (89 g/3.2 oz)	15	0	0	0	0	0	10	120	3	3	1	1	4	2	1	4	6	2	2	
Tomato, 1 medium (148 g/5.3 oz)	35	0	0.5	1	0	0	5	360	10	7	2	1	4	4	1	20	40	2	2	
Onion, 1 medium (148 g/5.3 oz)	60	0	0	0	0	0	5	240	7	14	5	3	12	9	2	0	20	4	2	
Carrot, 7" long, 1 1/4" diameter (78 g/2.8 oz)	35	0	0	0	0	0	40	280	8	8	3	2	8	5	1	270	10	2	0	
Celery, 2 medium stalks (110 g/3.9 oz) ..	20	0	0	0	0	0	100	4	350	10	5	2	8	0	1	2	15	4	2	
Sweet corn, kernels from 1 medium ear (90 g/3.2 oz)	80	10	1	2	0	0	0	240	7	18	6	3	12	5	3	2	10	0	2	
Broccoli, 1 medium stalk (148 g/5.3 oz) ..	45	0	0.5	1	0	0	55	250	15	8	3	5	20	3	5	15	220	6	6	
Green cabbage, 1/2 medium head (84 g/3.0 oz)	25	0	0	0	0	0	20	190	5	5	2	2	8	3	1	0	70	4	2	
Cucumber, 1/2 medium (99 g/3.5 oz)	15	0	0	0	0	0	0	170	5	3	1	1	4	2	1	4	10	2	2	
Bell pepper, 1 medium (148 g/5.3 oz) ..	30	0	0	0	0	0	0	270	8	7	2	2	8	4	1	8	190	2	2	
Cauliflower, 1/8 medium head (99 g/3.5 oz) ..	25	0	0	0	0	0	30	1	270	8	5	2	8	2	2	0	100	2	2	
Leaf lettuce, 1 1/2 cups shredded (85 g/3.0 oz)	15	0	0	0	0	0	30	1	230	7	4	1	2	1	40	6	4	0	0	

Nutrition facts ¹ for raw fruits and vegetables edible portion	Cal-ories from fat	Total fat		Saturated fat		Cholesterol		Sodium		Potassium		Total Car-bohydrate		Dietary Fiber		Sug-ars		Pro-tein		Vita-min A		Vita-min C		Cal-cium		Iron		
		(g)	(%)	(g)	(%)	(mg)	(%)	(mg)	(%)	(mg)	(%)	(g)	(%)	(g)	(%)	(g)	(%)	(g)	(%)	(g)	(%)	(g)	(%)	(g)	(%)	(g)	(%)	(g)
Sweet Potato, medium, 5" long, 2" diameter (130 g/4.6 oz)	130	0	0	0	0	0	0	45	2	350	10	33	11	4	16	7	2	440	30	2	2	2	2	2	2	2	2	2
Mushrooms, 5 medium (84 g/3.0 oz) ...	20	0	0	0	0	0	0	0	0	300	9	3	1	1	4	0	3	0	2	0	2	0	2	0	2	0	2	2
Green onion, 1/4 cup chopped (25 g/0.9 oz)	10	0	0	0	0	0	0	5	0	70	2	2	1	1	4	1	0	2	8	0	0	0	0	0	0	0	0	0
Green (snap) beans, 3/4 cup cut (83 g/3.0 oz)	25	0	0	0	0	0	0	0	0	200	6	5	2	3	12	2	1	4	10	4	2	2	2	2	2	2	2	2
Radishes, 7 radishes (85 g/3.0 oz)	15	0	0	0	0	0	0	25	1	230	7	3	1	0	0	2	1	0	30	2	0	2	0	2	0	2	0	2
Summer squash, 1/2 medium (98 g/3.5 oz)	20	0	0	0	0	0	0	0	0	260	7	4	1	2	8	2	1	6	30	2	2	2	2	2	2	2	2	2
Asparagus, 5 spears (93 g/3.3 oz)	25	0	0	0	0	0	0	0	0	230	7	4	1	2	8	2	2	10	15	2	2	2	2	2	2	2	2	2

¹ Raw, edible weight portion. Percent (%) Daily Values are based on a 2,000 calorie diet.

[61 FR 42761, Aug. 16, 1996]

EFFECTIVE DATE NOTE: At 71 FR 42044, July 25, 2006, appendix C to part 101 was revised, effective Jan. 1, 2008. At 71 FR 47439, Aug. 17, 2006, appendix C to part 101 was correctly revised, effective Jan. 1, 2008. For the convenience of the user, the revised text as corrected is set forth as follows:

Appendix C to Part 101.1--Nutrition Facts for Raw Fruits and Vegetables

Nutrition facts for raw fruits and vegetables edible portion	Cal-ories	Cal-ories from fat	Total Fat (g) (%)	Saturated Fat (g) (%)	Trans Fat (g) (%)	Cholesterol (mg) (%)	Sodium (mg) (%)	Potassium (mg) (%)	Total Carbohydrate (g) (%)	Dietary Fiber (g) (%)	Sug-ars (g) (%)	Pro-tein (g) (%)	Vita-min.A (%)	Vita-min.C (%)	Cal-cium (%)	Iron (%)
Apple, 1 large (242 g/8 oz)	130	0	0	0	0	0	0	260	34	5	20	25	1	2	8	2
Avocado, California, 1/5 medium (30 g/1.1 oz)	50	35	4.5	7	0.5	3	0	140	4	3	1	4	0	1	0	4
Banana, 1 medium (126 g/4.5 oz)	110	0	0	0	0	0	0	450	13	30	10	3	12	19	1	2
Cantaloupe, 1/4 medium (134 g/4.8 oz)	50	0	0	0	0	0	20	240	7	12	4	1	4	11	1	120
Grapefruit, 1/2 medium (154 g/5.5 oz)	60	0	0	0	0	0	0	160	5	15	5	2	8	11	1	35
Grapes, 3/4 cup (126 g/4.5 oz)	90	0	0	0	0	0	15	240	7	23	8	1	4	20	0	2
Honeydew Melon, 1/10 medium melon (134 g/4.8 oz)	50	0	0	0	0	0	30	210	6	12	4	1	4	11	1	2
Kiwifruit, 2 medium (148 g/5.3 oz)	90	10	1	2	0	0	0	450	13	20	7	4	16	13	1	2
Lemon, 1 medium (58 g/2.1 oz)	15	0	0	0	0	0	0	75	2	5	2	2	8	2	0	40
Lime, 1 medium (67 g/2.4 oz)	20	0	0	0	0	0	0	75	2	7	2	2	8	0	0	35
Nectarine, 1 medium (140 g/5.0 oz)	60	5	0.5	1	0	0	0	250	7	15	5	2	8	11	1	8
Orange, 1 medium (154 g/5.5 oz)	80	0	0	0	0	0	0	250	7	19	6	3	12	14	1	2
Peach, 1 medium (147 g/5.3 oz)	60	0	0.5	1	0	0	0	230	7	15	5	2	8	13	1	6
Pear, 1 medium (166 g/5.9 oz)	100	0	0	0	0	0	0	190	5	26	9	6	24	16	1	0
Pineapple, 2 slices, 3" diameter, 3/4" thick (112 g/4 oz)	50	0	0	0	0	0	10	120	3	13	4	1	4	10	1	2
Plums, 2 medium (151 g/5.4 oz)	70	0	0	0	0	0	0	230	7	19	6	2	8	16	1	8
Strawberries, 8 medium (147g/5.3 oz)	50	0	0	0	0	0	0	170	5	11	4	2	8	8	1	0
Sweet cherries, 21 cherries; 1 cup (140 g/5.0 oz)	100	0	0	0	0	0	0	350	10	26	9	1	4	16	1	2
Tangerine, 1 medium (109 g/3.9 oz)	50	0	0	0	0	0	0	160	5	13	4	2	8	9	1	6
Watermelon, 1/18 medium melon; 2 cups diced pieces (280 g/10.0 oz)	80	0	0	0	0	0	0	270	8	21	7	1	4	20	1	30

Appendix C to Part 101.--Nutrition Facts for Raw Fruits and Vegetables-continued

Nutrition facts for raw fruits and vegetables edible portion	Cal-ories from fat	Cal-ories from fat	Total Fat (g) (%)	Saturated Fat (g) (%)	Trans Fat (g) (%)	Cholesterol (mg) (%)	Sodium (mg) (%)	Potassium (mg) (%)	Total Carbo-hydrate (g) (%)	Dietary Fiber (g) (%)	Sug-ars (g) (%)	Pro-tein (g) (%)	Vita-min A (%)	Vita-min C (%)	Cal-cium (%)	Iron (%)
Asparagus, 5 spears (93 g/3.3 oz)	20	0	0	0	0	0	0	230	7	4	2	8	2	10	15	2
Bell pepper, 1 medium (148 g/5.3 oz)	25	0	0	0	0	0	40	220	6	2	8	4	1	4	190	2
Broccoli, 1 medium stalk (148 g/5.3 oz)	45	0	0.5	1	0	0	80	3	460	13	8	3	12	2	6	220
Carrot, 1 carrot, 7" long, 1 1/4" diameter (78 g/2.8 oz)	30	0	0	0	0	0	60	3	250	7	2	8	5	1	110	10
Cauliflower, 1/6 medium head (99 g/3.5 oz)	25	0	0	0	0	0	30	1	270	8	5	2	8	2	0	100
Celery, 2 medium stalks (110 g/3.9 oz)	15	0	0	0	0	0	115	5	260	7	4	1	2	8	2	0
Cucumber, 1/3 medium (99 g/3.5 oz)	10	0	0	0	0	0	0	140	4	2	1	4	1	4	10	2
Green (snap) beans, 3/4 cup cut (83 g/3.0 oz)	20	0	0	0	0	0	0	200	6	5	2	3	12	2	1	4
Green cabbage, 1/12 medium head (84 g/3.0 oz)	25	0	0	0	0	0	20	1	190	5	5	2	8	3	1	0
Green onion, 1/4 cup chopped (25 g/0.9 oz)	10	0	0	0	0	0	10	0	70	2	1	1	4	1	0	2
Iceberg lettuce, 1/6 medium head (89 g/3.2 oz)	10	0	0	0	0	0	10	0	125	4	2	1	4	2	1	6
Leaf lettuce, 1 1/2 cups shredded (85 g/3.0 oz)	15	0	0	0	0	0	35	1	170	5	2	1	4	1	130	6
Mushrooms, 5 medium (84 g/3.0 oz)	20	0	0	0	0	0	15	0	300	9	3	1	4	0	3	0
Onion, 1 medium (148 g/5.3 oz)	45	0	0	0	0	0	5	0	190	5	11	4	3	12	9	1
Potato, 1 medium (148 g/5.3 oz)	110	0	0	0	0	0	0	0	620	18	26	9	2	8	1	3
Radishes, 7 radishes (85 g/3.0 oz)	10	0	0	0	0	0	55	2	190	5	3	1	1	4	2	0
Summer squash, 1/2 medium (98 g/3.5 oz)	20	0	0	0	0	0	0	0	260	7	4	1	2	8	2	1
Sweet corn, kernels from 1 medium ear (90 g/3.2 oz)	90	20	2.5	4	0	0	0	0	250	7	18	6	2	8	5	4
Sweet Potato, 1 medium, 5" long, 2" diameter (130 g/4.6 oz)	100	0	0	0	0	0	70	3	440	13	23	8	4	16	7	2
Tomato, 1 medium (148 g/5.3 oz)	25	0	0	0	0	0	20	1	340	10	5	2	1	4	3	1

¹ Raw, edible weight portion. Percent (%) Daily Values are based on a 2,000 calorie diet.

APPENDIX D TO PART 101—NUTRITION FACTS FOR COOKED FISH

Nutrition facts ¹ fish (84 g/3 oz)	Cal-ories from fat	Total fat		Saturated fat		Cholesterol		Sodium		Potassium		Total car-bohydrate		Dietary fiber		Sug-ars (g)	Pro-tein (g)	Vita-min A (%)	Vita-min C (%)	Cal-cium (%)	Iron (%)
		(g)	(%)	(g)	(%)	(mg)	(%)	(mg)	(%)	(g)	(%)	(g)	(%)								
Shrimp	80	1	2	0	0	165	55	190	8	140	4	0	0	0	0	18	0	0	2	15	
Cod	90	0	0.5	0	0	45	15	60	3	450	13	0	0	0	0	20	0	0	2	2	
Pollock	90	1	2	0	0	80	27	110	5	360	10	0	0	0	0	20	0	0	2	2	
Catfish	140	80	9	14	2	10	50	17	40	2	230	7	0	0	0	17	0	0	0	0	
Scallops, about 6 large or 14 small	120	10	1	2	0	0	55	18	260	11	280	8	2	1	0	22	0	0	2	2	
Salmon, Atlantic/Conto	160	60	7	11	1	5	50	17	50	2	480	14	0	0	0	22	0	0	0	4	
Salmon, Chum/Pink	130	35	4	6	1	5	70	23	65	3	410	12	0	0	0	22	2	0	0	4	
Salmon, Sockeye	180	80	9	14	1.5	8	75	25	55	2	320	9	0	0	0	23	4	0	0	2	
Flounder/sole	100	14	1.5	2	0.5	3	60	20	90	4	290	8	0	0	0	21	0	0	2	2	
Oysters, about 12 medium	100	35	3.5	5	1	5	115	38	190	8	390	11	4	1	0	10	0	0	6	45	
Orange roughy	80	10	1	2	0	0	20	7	70	3	330	9	0	0	0	16	0	0	0	0	
Mackerel, Atlantic/Pacific	210	120	13	20	1.5	8	60	20	100	4	400	11	0	0	0	21	0	0	0	5	
Ocean perch	110	20	2	3	0	0	50	17	95	4	290	8	0	0	0	21	0	0	10	6	
Rockfish	100	20	2	3	0	0	40	13	70	3	430	12	0	0	0	21	4	0	0	2	
Whiting	110	25	3	5	0.5	3	70	23	95	4	320	9	0	0	0	19	2	0	6	0	
Clams, about 12 small	100	15	1.5	2	0	0	55	18	95	4	530	15	0	0	0	22	10	0	6	60	
Haddock	100	10	1	2	0	0	80	27	85	4	340	10	0	0	0	21	0	0	2	6	
Blue crab	100	10	1	2	0	0	90	30	320	13	360	10	0	0	0	20	0	0	8	4	
Rainbow trout	140	50	6	9	2	10	60	20	35	1	370	11	0	0	0	20	4	0	6	2	
Hallbut	110	20	2	3	0	0	35	12	60	3	490	14	0	0	0	23	2	0	4	4	
Lobster	80	0	0.5	1	0	0	60	20	320	13	300	9	1	0	0	17	0	0	4	2	
Swordfish	130	35	4.5	7	1	5	40	13	100	4	310	9	0	0	0	22	2	2	0	4	

¹ Cooked, edible weight portion. Percent (%) Daily Values are based on a 2,000 calorie diet.

Pt. 101, App. D

21 CFR Ch. I (4–1–07 Edition)

EFFECTIVE DATE NOTE: At 71 FR 42044, July 25, 2006, appendix D to part 101 was revised, effective Jan. 1, 2008. At 71 FR 47439, Aug. 17, 2006, appendix D to part 101 was correctly revised. For the convenience of the user, the

revised text as corrected is set forth as follows:

Appendix D to Part 101.--Nutrition Facts for Cooked Fish

Nutrition facts ¹ fish (84 g/3 oz)	Cal-ories	Cal-ories from fat	Total Fat (g) (%)	Saturated Fat (g) (%)	Trans Fat (g)	Cholesterol (mg) (%)	Sodium (mg) (%)	Potassium (mg) (%)	Total Carbo-hydrate (g) (%)	Dietary Fiber (g) (%)	Sug-ars (g)	Pro-tein (g)	Vita-min A (%)	Vita-min C (%)	Cal-cium (%)	Iron (%)
Blue crab	100		1 2 0 0	0 0 0	0	32 330 14	300 9		0 0 0	0 0 0	0 0 0	20 0	0 4	0 10	4	
Catfish	130		6 9 2 10	0 50 17 40	2 230 7			0 0 0	0 0 0	0 0 0	0 0 0	17 0	0 0	0 0	0 0	
Clams, about 12 small	110		1.5 2 0 0	0 80 27 95	4 470 13			6 2 0	0 0 0	0 0 0	0 0 0	17 10	0 0	8 30		
Cod	90		5 1 2 0	0 50 17 65	3 460 13			0 0 0	0 0 0	0 0 0	0 0 0	20 0	0 2	2 2		
Flounder/sole	100		1.5 2 0 0	0 55 18 100	4 390 11			0 0 0	0 0 0	0 0 0	0 0 0	19 0	0 0	2 0		
Haddock	100		1 2 0 0	0 70 23 85	4 340 10			0 0 0	0 0 0	0 0 0	0 0 0	21 2	0 0	2 6		
Halibut	120		2 3 0 0	0 40 13 60	3 500 14			0 0 0	0 0 0	0 0 0	0 0 0	23 4	0 0	2 6		
Lobster	80		0 0.5 1 0	0 60 20 320	13 300 9			1 0 0	0 0 0	0 0 0	0 0 0	17 2	0 0	6 2		
Ocean perch	110		2 3 0 0	0 45 15 95	4 290 8			0 0 0	0 0 0	0 0 0	0 0 0	21 0	0 2	10 4		
Orange roughy	80		5 1 2 0	0 20 7 70	3 340 10			0 0 0	0 0 0	0 0 0	0 0 0	16 2	0 0	4 2		
Oysters, about 12 medium	100		35 4 6 1	5 0 80 27	300 13 220 6			6 2 0	0 0 0	0 0 0	0 0 0	10 0	0 6	6 6	45	
Pollock	90		1 2 0 0	0 80 27	110 5 370 11			0 0 0	0 0 0	0 0 0	0 0 0	20 2	0 0	0 2		
Rainbow trout	140		50 6 9 2	10 0 55 18	35 1 370 11			0 0 0	0 0 0	0 0 0	0 0 0	20 4	4 4	8 2		
Rockfish	110		15 2 3 0	0 40 13 70	3 440 13			0 0 0	0 0 0	0 0 0	0 0 0	21 4	0 0	2 2		
Salmon, Atlantic/Chor/Sockeye/Chinook	200		10 15 2 10	0 70 23 55	2 430 12			0 0 0	0 0 0	0 0 0	0 0 0	24 4	4 4	2 2		
Salmon, Chum/Pink	130		40 4 6 1	5 0 70 23	65 3 420 12			0 0 0	0 0 0	0 0 0	0 0 0	22 2	0 0	2 4		
Scallops, about 6 large or 14 small	140		10 1 2 0	0 65 22 310	13 430 12			5 2 0	0 0 0	0 0 0	0 0 0	27 2	0 0	4 14		
Shrimp	100		10 1.5 2 0	0 0 170 57	240 10 220 6			0 0 0	0 0 0	0 0 0	0 0 0	21 4	4 4	6 10		
Swordfish	120		50 6 9 1.5	8 0 40 13	100 4 310 9			0 0 0	0 0 0	0 0 0	0 0 0	16 2	2 0	6 6		
Tilapia	110		20 2.5 4 1	5 0 75 25	30 1 360 10			0 0 0	0 0 0	0 0 0	0 0 0	22 0	2 0	2 0		
Tuna	130		15 1.5 2 0	0 0 50 17	40 2 480 14			0 0 0	0 0 0	0 0 0	0 0 0	26 2	2 2	2 4		

¹ Cooked, edible weight portion. Percent (%) Daily Values are based on a 2,000 calorie diet.

PART 102—COMMON OR USUAL NAME FOR NONSTANDARDIZED FOODS

Subpart A—General Provisions

Sec.

- 102.5 General principles.
102.19 Petitions.

Subpart B—Requirements for Specific Nonstandardized Foods

- 102.22 Protein hydrolysates.
102.23 Peanut spreads.
102.26 Frozen “heat and serve” dinners.
102.28 Foods packaged for use in the preparation of “main dishes” or “dinners.”
102.33 Beverages that contain fruit or vegetable juice.
102.37 Mixtures of edible fat or oil and olive oil.
102.39 Onion rings made from diced onion.
102.41 Potato chips made from dried potatoes.
102.45 Fish sticks or portions made from minced fish.
102.46 Pacific whiting.
102.47 Bonito.
102.49 Fried clams made from minced clams.
102.50 Crabmeat.
102.54 Seafood cocktails.
102.55 Nonstandardized breaded composite shrimp units.
102.57 Greenland turbot (*Reinhardtius hippoglossoides*).

AUTHORITY: 21 U.S.C. 321, 343, 371.

SOURCE: 42 FR 14322, Mar. 15, 1977, unless otherwise noted.

Subpart A—General Provisions

§ 102.5 General principles.

(a) The common or usual name of a food, which may be a coined term, shall accurately identify or describe, in as simple and direct terms as possible, the basic nature of the food or its characterizing properties or ingredients. The name shall be uniform among all identical or similar products and may not be confusingly similar to the name of any other food that is not reasonably encompassed within the same name. Each class or subclass of food shall be given its own common or usual name that states, in clear terms, what it is in a way that distinguishes it from different foods.

(b) The common or usual name of a food shall include the percentage(s) of any characterizing ingredient(s) or

component(s) when the proportion of such ingredient(s) or component(s) in the food has a material bearing on price or consumer acceptance or when the labeling or the appearance of the food may otherwise create an erroneous impression that such ingredient(s) or component(s) is present in an amount greater than is actually the case. The following requirements shall apply unless modified by a specific regulation in subpart B of this part.

(1) The percentage of a characterizing ingredient or component shall be declared on the basis of its quantity in the finished product (i.e., weight/weight in the case of solids, or volume/volume in the case of liquids).

(2) The percentage of a characterizing ingredient or component shall be declared by the words “containing (or contains) __ percent (or %) _____” or “__ percent (or %) _____” with the first blank filled in with the percentage expressed as a whole number not greater than the actual percentage of the ingredient or component named and the second blank filled in with the common or usual name of the ingredient or component. The word “containing” (or “contains”), when used, shall appear on a line immediately below the part of the common or usual name of the food required by paragraph (a) of this section. For each characterizing ingredient or component, the words “__ percent (or %) _____” shall appear following or directly below the word “containing” (or contains), or directly below the part of the common or usual name of the food required by paragraph (a) of this section when the word “containing” (or contains) is not used, in easily legible boldface print or type in distinct contrast to other printed or graphic matter, and in a height not less than the larger of the following alternatives:

(i) Not less than one-sixteenth inch in height on packages having a principal display panel with an area of 5 square inches or less and not less than one-eighth inch in height if the area of the principal display panel is greater than 5 square inches; or

(ii) Not less than one-half the height of the largest type appearing in the part of the common or usual name of

the food required by paragraph (a) of this section.

(c) The common or usual name of a food shall include a statement of the presence or absence of any characterizing ingredient(s) or component(s) and/or the need for the user to add any characterizing ingredient(s) or component(s) when the presence or absence of such ingredient(s) or component(s) in the food has a material bearing on price or consumer acceptance or when the labeling or the appearance of the food may otherwise create an erroneous impression that such ingredient(s) or component(s) is present when it is not, and consumers may otherwise be misled about the presence or absence of the ingredient(s) or component(s) in the food. The following requirements shall apply unless modified by a specific regulation in subpart B of this part.

(1) The presence or absence of a characterizing ingredient or component shall be declared by the words "containing (or contains) _____" or "containing (or contains) no _____" or "no _____" or "does not contain _____", with the blank being filled in with the common or usual name of the ingredient or component.

(2) The need for the user of a food to add any characterizing ingredient(s) or component(s) shall be declared by an appropriate informative statement.

(3) The statement(s) required under paragraph (c)(1) and/or (2) of this section shall appear following or directly below the part of the common or usual name of the food required by paragraphs (a) and (b) of this section, in easily legible boldface print or type in distinct contrast to other printed or graphic matter, and in a height not less than the larger of the alternatives established under paragraphs (b)(2) (i) and (ii) of this section.

(d) A common or usual name of a food may be established by common usage or by establishment of a regulation in subpart B of this part, in part 104 of this chapter, in a standard of identity, or in other regulations in this chapter.

§ 102.19 Petitions.

(a) The Commissioner of Food and Drugs, either on his own initiative or

on behalf of any interested person who has submitted a petition, may publish a proposal to issue, amend, or revoke, under this part, a regulation prescribing a common or usual name for a food, pursuant to part 10 of this chapter.

(b) If the principal display panel of a food for which a common or usual name regulation is established is too small to accommodate all mandatory requirements, the Commissioner may establish by regulation an acceptable alternative, e.g., a smaller type size. A petition requesting such a regulation, which would amend the applicable regulation, shall be submitted pursuant to part 10 of this chapter.

[42 FR 14322, Mar. 15, 1977, as amended at 42 FR 15673, Mar. 22, 1977]

Subpart B—Requirements for Specific Nonstandardized Foods

§ 102.22 Protein hydrolysates.

The common or usual name of a protein hydrolysate shall be specific to the ingredient and shall include the identity of the food source from which the protein was derived.

(a) "Hydrolyzed wheat gluten," "hydrolyzed soy protein," and "autolyzed yeast extract" are examples of acceptable names. "Hydrolyzed casein" is also an example of an acceptable name, whereas "hydrolyzed milk protein" is not an acceptable name for this ingredient because it is not specific to the ingredient (hydrolysates can be prepared from other milk proteins). The names "hydrolyzed vegetable protein" and "hydrolyzed protein" are not acceptable because they do not identify the food source of the protein.

(b) [Reserved]

[58 FR 2876, Jan. 6, 1993]

§ 102.23 Peanut spreads.

(a) The common or usual name of a spreadable peanut product that does not conform to § 164.150 of this chapter, and more than 10 percent of which consists of nonpeanut ingredients, shall consist of the term "peanut spread" and a statement of the percentage by weight of peanuts in the product in the manner set forth in § 102.5(b), except

that peanut percentages shall be based on the amount of peanuts used to make the finished food and shall be declared in 5-percent increments expressed as a multiple of 5, not to exceed the actual percentage of peanuts in the products.

(b) A spreadable peanut product that is nutritionally inferior to peanut butter shall be labeled as an imitation of peanut butter under §101.3(e)(2) of this chapter; a spreadable peanut product shall be considered nutritionally equivalent to peanut butter if it meets all of the following conditions:

(1) *Protein.* (i) The protein content of the product is at least 24 percent by weight of the finished product, and the overall biological quality of the protein contained in the product is at least 68 percent that of casein; or

(ii) The protein content of the product is at least 16.6 percent by weight of the finished product, and the overall biological quality of the protein contained in the product is equal to or greater than that of casein.

(2) *Other nutrients.* The product contains the following levels of nutrients per 100 grams of product:

Nutrient	Amount (milligrams)
Niacin	15.3
Vitamin B ₆	0.33
Folic acid	0.08
Iron	2.0
Zinc	2.9
Magnesium	173.0
Copper	0.6

(c) Compliance with the requirements of paragraph (b) of this section shall be determined by methods described in the following references except that in determining protein quantity in products with mixed protein sources a nitrogen conversion factor of 6.25 may be used.

(1) Protein quantity: "Official Methods of Analysis of the Association of Official Analytical Chemists" (AOAC), 13th Ed. (1980), using the method described in section 27.007, which is incorporated by reference. Copies may be obtained from the AOAC INTERNATIONAL, 481 North Frederick Ave., suite 500, Gaithersburg, MD 20877, or may be examined at the National Archives and Records Administration (NARA). For information on the avail-

ability of this material at NARA, call 202-741-6030, or go to: http://www.archives.gov/federal_register/code_of_federal_regulations/ibr_locations.html.

(2) Biological quality of protein: AOAC, 13th Ed. (1980), using the method described in sections 43.212-43.216, which is incorporated by reference. The availability of this incorporation by reference is given in paragraph (c)(1) of this section.

(3) Niacin: AOAC, 13th Ed. (1980), using the method described in sections 43.044-43.046, which is incorporated by reference. The availability of this incorporation by reference is given in paragraph (c)(1) of this section.

(4) Vitamin B₆: AOAC, 13th Ed. (1980), using the method described in sections 43.188-43.193, which is incorporated by reference. The availability of this incorporation by reference is given in paragraph (c)(1) of this section.

(5) Folic acid: Using the method described in U.S. Department of Agriculture Handbook No. 29, modified by use of ascorbate buffer as described by Ford and Scott, *Journal of Dairy Research*, 35:85-90 (1968), which is incorporated by reference. Copies are available from the Center for Food Safety and Applied Nutrition (HFS-800), Food and Drug Administration, 5100 Paint Branch Pkwy., College Park, MD 20740, or available for inspection at the National Archives and Records Administration (NARA). For information on the availability of this material at NARA, call 202-741-6030, or go to: http://www.archives.gov/federal_register/code_of_federal_regulations/ibr_locations.html.

(6) Iron: AOAC, 13th Ed. (1980), using the method described in sections 43.217-43.219, which is incorporated by reference. The availability of this incorporation by reference is given in paragraph (c)(1) of this section.

(7) Zinc: AOAC, 13th Ed. (1980), using the method described in sections 25.150-25.153, which is incorporated by reference. The availability of this incorporation by reference is given in paragraph (c)(1) of this section.

(8) Copper: AOAC, 13th Ed. (1980), using the method described in sections 25.038-25.043, which is incorporated by

reference. The availability of this incorporation by reference is given in paragraph (c)(1) of this section.

(9) Magnesium: AOAC, 13th Ed. (1980), using the method described in sections 2.109–2.113, which is incorporated by reference. The availability of this incorporation by reference is given in paragraph (c)(1) of this section.

[42 FR 36455, July 15, 1977, as amended at 47 FR 11821, Mar. 19, 1982; 49 FR 5609, Feb. 14, 1984; 54 FR 24891, June 12, 1989; 61 FR 14479, Apr. 2, 1996; 63 FR 14035, Mar. 24, 1998; 66 FR 17358, Mar. 30, 2001; 66 FR 56035, Nov. 6, 2001]

§ 102.26 Frozen “heat and serve” dinners.

(a) A frozen “heat and serve” dinner:

(1) Shall contain at least three components, one of which shall be a significant source of protein and each of which shall consist of one or more of the following: meat, poultry, fish, cheese, eggs, vegetables, fruit, potatoes, rice, or other cereal based products (other than bread or rolls).

(2) May also contain other servings of food (e.g., soup, bread or rolls, beverage, dessert).

(b) The common or usual name of the food consists of all of the following:

(1) The phrase “frozen ‘heat and serve’ dinner,” except that the name of the predominant characterizing ingredient or other appropriately descriptive term may immediately precede the word “dinner” (e.g., “frozen chicken dinner” or “frozen heat and serve beef dinner”). The words “heat and serve” are optional. The word “frozen” is also optional, provided that the words “Keep Frozen” or the equivalent are prominently and conspicuously placed on the principal display panel in type size not less than that specified in § 102.5(b)(2)(i).

(2) The phrase “containing (or contains) _____” the blank to be filled in with an accurate description of each of the three or more dish components listed in paragraph (a)(1) of this section in their order of descending predominance by weight (e.g., ham, mashed potatoes, and peas), followed by any of the other servings specified in paragraph (a)(2) of this section contained in the package (e.g., onion soup, enriched white bread, and artificially flavored vanilla pudding) in their order of descending pre-

dominance by weight. This part of the name shall be placed immediately following or directly below the part specified in paragraph (b)(1) of this section in the manner set forth in § 102.5(c)(3). The words “contains” or “containing” are optional.

(3) If the labeling implies that the package contains other foods and these foods are not present in the package, e.g., if a vignette on the package depicts a “serving suggestion” which includes any foods not present in the package, the principal display panel shall bear a statement that such foods are not present, in type size not less than that specified in § 102.5(b)(2)(i).

§ 102.28 Foods packaged for use in the preparation of “main dishes” or “dinners.”

(a) The common or usual name of a packaged food which is represented on the principal display panel by word or vignette to be used in the preparation of a “main dish”, “dinner”, or other such food serving, and to which some other important characterizing ingredient(s) or component(s) not present in the package must be added, consists of all the following:

(1) The common or usual name of each important ingredient or component in the package, in descending order of predominance by weight (e.g., “noodles and tomato sauce”).

(2) An appropriate informative statement identifying the food to be prepared by use of the package contents (e.g., “for preparation of chicken casserole”).

(3) An appropriate informative statement that additional characterizing ingredient(s) or component(s) must be added and which names the additional characterizing ingredient(s) or component(s) (e.g., “you must add _____ to complete the recipe,” the blank to be filled in with the name(s) of the important characterizing ingredient(s) or component(s) that must be added).

(b) The labeling required by paragraph (a) of this section shall appear on the principal display panel.

(1) No word in the statement required by paragraph (a)(2) of this section may appear on the principal display panel more conspicuously or in larger type

§ 102.33

than the smallest and least conspicuous type employed on the panel for any word, phrase or statement within the scope of paragraph (a)(1) of this section.

(2) Every word in the statement required by paragraph (a)(3) of this section shall appear on the principal display panel in easily legible bold face print or type in distinct contrast to other printed or graphic matter, and in a height not less than the larger of the following alternatives:

(i) Not less than one-sixteenth inch in height on packages having a principal display panel with an area of 5 square inches or less and not less than one-eighth inch in height if the area of the principal display panel is greater than 5 square inches; or

(ii) Not less than one-half the height of the largest type appearing in the part of the common or usual name of the food required by paragraphs (a) (1) and (2) of this section.

(c) Any vignette which shows any food or characterizing ingredient(s) or component(s) not included in the package shall be accompanied either by the statement required by paragraph (a)(3) of this section or by a separate statement specifying the food or characterizing ingredient(s) or component(s) shown in the vignette but not included in the package.

(d) If the statement specified in paragraph (a)(2) of this section is used on any panel in addition to the principal display panel as a product identification statement, the complete common or usual name shall appear on such panel in the manner specified in paragraph (b) of this section.

(e) When a brand name or other prominent product designation contains a word or words that includes or suggests an important characterizing ingredient(s) or component(s) that must be added, or otherwise states or implies that the package contains a complete main dish, dinner, or other food serving, the part of the common or usual name of the food required by paragraph (a)(3) of this section shall appear in direct conjunction with such brand name or other designation and in type size not less than one-half the height of the largest type appearing in such brand name or other designation.

21 CFR Ch. I (4-1-07 Edition)

§ 102.33 Beverages that contain fruit or vegetable juice.

(a) For a carbonated or noncarbonated beverage that contains less than 100 percent and more than 0 percent fruit or vegetable juice, the common or usual name shall be a descriptive name that meets the requirements of § 102.5(a) and, if the common or usual name uses the word "juice," shall include a qualifying term such as "beverage," "cocktail," or "drink" appropriate to advise the consumer that the product is less than 100 percent juice (e.g., "diluted grape juice beverage" or "grape juice drink").

(b) If the product is a diluted multiple-juice beverage or blend of single-strength juices and names, other than in the ingredient statement, more than one juice, then the names of those juices, except in the ingredient statement, must be in descending order of predominance by volume unless the name specifically shows that the juice with the represented flavor is used as a flavor (e.g., raspberry-flavored apple and pear juice drink). In accordance with § 101.22(i)(1)(iii) of this chapter, the presence of added natural flavors is not required to be declared in the name of the beverage unless the declared juices alone do not characterize the product before the addition of the added flavors.

(c) If a diluted multiple-juice beverage or blend of single-strength juices contains a juice that is named or implied on the label or labeling other than in the ingredient statement (represented juice), and also contains a juice other than the named or implied juice (nonrepresented juice), then the common or usual name for the product shall indicate that the represented juice is not the only juice present (e.g., "Apple blend; apple juice in a blend of two other fruit juices.")

(d) In a diluted multiple-juice beverage or blend of single-strength juices where one or more, but not all, of the juices are named on the label other than in the ingredient statement, and where the named juice is not the predominant juice, the common or usual name for the product shall:

(1) Indicate that the named juice is present as a flavor or flavoring (e.g.,

“Raspcranberry”; raspberry and cranberry flavored juice drink); or

(2) Include the amount of the named juice, declared in a 5-percent range (e.g., Raspcranberry; raspberry and cranberry juice beverage, 10- to 15-percent cranberry juice and 3- to 8-percent raspberry juice). The 5-percent range, when used, shall be declared in the manner set forth in §102.5(b)(2).

(e) The common or usual name of a juice that has been modified shall include a description of the exact nature of the modification (e.g., “acid-reduced cranberry juice,” “deflavored, de-colored grape juice”).

(f) If the product is a beverage that contains a juice whose color, taste, or other organoleptic properties have been modified to the extent that the original juice is no longer recognizable at the time processing is complete, or if its nutrient profile has been diminished to a level below the normal nutrient range for the juice, then the source fruits or vegetables from which the modified juice was derived may not be depicted on the label by vignette or other pictorial representation.

(g)(1) If one or more juices in a juice beverage is made from concentrate, the name of the juice must include a term indicating that fact, such as “from concentrate,” or “reconstituted.” Such terms must be included in the name of each individual juice or it may be stated once adjacent to the product name so that it applies to all the juices, (e.g., “cherry juice (from concentrate) in a blend of two other juices” or “cherry juice in a blend of 2 other juices (from concentrate)”). The term shall be in a type size no less than one-half the height of the letters in the name of the juice.

(2) If the juice is 100 percent single species juice consisting of juice directly expressed from a fruit or vegetable whose Brix level has been raised by the addition of juice concentrate from the same fruit or vegetable, the name of the juice need not include a statement that the juice is from concentrate. However, if water is added to this 100 percent juice mixture to adjust the Brix level, the product shall be la-

beled with the term “from concentrate” or “reconstituted.”

[58 FR 2926, Jan. 6, 1993; 58 FR 17103, Apr. 1, 1993, as amended at 58 FR 44063, Aug. 18, 1993; 62 FR 15343, Mar. 31, 1997]

§ 102.37 Mixtures of edible fat or oil and olive oil.

The common or usual name of a mixture of edible fats and oils containing less than 100 percent and more than 0 percent olive oil shall be as follows:

(a) A descriptive name for the product meeting the requirements of §102.5(a), e.g., “cottonseed oil and olive oil” or another descriptive phrase, and

(b) When the label bears any representation, other than in the ingredient listing, of the presence of olive oil in the mixture, the descriptive name shall be followed by a statement of the percentage of olive oil contained in the product in the manner set forth in §102.5(b)(2).

§ 102.39 Onion rings made from diced onion.

(a) The common or usual name of the food product that resembles and is of the same composition as onion rings, except that it is composed of comminuted onions, shall be as follows:

(1) When the product is composed of dehydrated onions, the name shall be “onion rings made from dried diced onions.”

(2) When the product is composed of any form of onion other than dehydrated, the name shall be “onion rings made from diced onions.”

(b) The words “made from dried diced onions” or “made from diced onions” shall immediately follow or appear on a line(s) immediately below the words “onion rings” in easily legible boldface print or type in distinct contrast to other printed or graphic matter, and in a height not less than the larger of the following alternatives:

(1) Not less than one-sixteenth inch in height on packages having a principal display panel with an area of 5 square inches or less and not less than one-eighth inch in height if the area of the principal display panel is greater than 5 square inches; or

(2) Not less than one-half the height of the largest type used in the words “onion rings.”

§ 102.41

§ 102.41 Potato chips made from dried potatoes.

(a) The common or usual name of the food product that resembles and is of the same composition as potato chips, except that it is composed of dehydrated potatoes (buds, flakes, granules, or other form), shall be “potato chips made from dried potatoes.”

(b) The words “made from dried potatoes” shall immediately follow or appear on a line(s) immediately below the words “potato chips” in easily legible boldface print or type in distinct contrast to other printed or graphic matter, and in a height not less than the larger of the following alternatives:

(1) Not less than one-sixteenth inch in height on packages having a principal display panel with an area of 5 square inches or less and not less than one-eighth inch in height if the area of the principal display panel is greater than 5 square inches; or

(2) Not less than one-half the height of the largest type used in the words “potato chips.”

§ 102.45 Fish sticks or portions made from minced fish.

(a) The common or usual name of the food product that resembles and is of the same composition as fish sticks or fish portions, except that it is composed of comminuted fish flesh, shall be “fish _____ made from minced fish,” the blank to be filled in with the word “sticks” or “portions” as the case may be.

(b) The words “made from minced fish” shall immediately follow or appear on a line(s) immediately below the words “fish _____” in easily legible boldface print or type in distinct contrast to other printed or graphic matter, and in a height not less than the larger of the following alternatives:

(1) Not less than one-sixteenth inch in height on packages having a principal display panel with an area of 5 square inches or less and not less than one-eighth inch in height if the area of the principal display panel is greater than 5 square inches; or

(2) Not less than one-half the height of the largest type used in the words “fish _____.”

21 CFR Ch. I (4–1–07 Edition)

§ 102.46 Pacific whiting.

“Pacific whiting” or “North Pacific whiting” is the common or usual name of the food fish *Merluccius productus*.

[44 FR 45617, Aug. 3, 1979]

§ 102.47 Bonito.

“Bonito” or “bonito fish” is the common or usual name of the following food fishes:

Cybiosarda elegans (Whitely, 1935)—Leaping bonito

Gymnosarda unicolor (Ruppell, 1838)—Dogtooth tuna

Orcynopsis unicolor (Geoffroy St. Hilaire, 1817)—Plain bonito

Sarda australis (Macleay, 1880)—Australian bonito

Sarda chiliensis (Cuvier, 1831)—Eastern Pacific bonito

Sarda orientalis (Temminck and Schlegel, 1844)—Striped bonito

Sarda sarda (Bloch, 1793)—Atlantic bonito

[55 FR 45797, Oct. 31, 1990]

§ 102.49 Fried clams made from minced clams.

(a) The common or usual name of the food product that resembles and is of the same composition as fried clams, except that it is composed of comminuted clams, shall be “fried clams made from minced clams.”

(b) The words “made from minced clams” shall immediately follow or appear on a line(s) immediately below the words “fried clams” and in easily legible boldface print or type in distinct contrast to other printed or graphic matter, and in a height not less than the larger of the following alternatives:

(1) Not less than one-sixteenth inch in height on packages having a principal display panel with an area of 5 square inches or less and not less than one-eighth inch in height if the area of the principal display panel is greater than 5 square inches; or

(2) Not less than one-half the height of the largest type used in the words “fried clams.”

§ 102.50 Crabmeat.

The common or usual name of crabmeat derived from each of the following designated species of crabs shall be as follows:

Scientific name of crab	Common or usual name of crabmeat
<i>Chionoecetes opilio</i> , <i>Chionoecetes tanneri</i> , <i>Chionoecetes bairdii</i> , and <i>Chionoecetes angulatus</i>	Snow crabmeat.
<i>Erimacrus isenbeckii</i>	Korean variety crabmeat or Kegani crabmeat.
<i>Lithodes aequispina</i>	Brown King crabmeat.
<i>Paralithodes brevipes</i>	King crabmeat or Hanasaki crabmeat.
<i>Paralithodes camtschaticus</i>	King crabmeat and Paralithodes Platypus.

[42 FR 14322, Mar. 15, 1977, as amended at 60 FR 34460, July 3, 1995]

§ 102.54 Seafood cocktails.

The common or usual name of a seafood cocktail in package form fabricated with one or more seafood ingredients shall be:

(a) When the cocktail contains only one seafood ingredient, the name of the seafood ingredient followed by the word "cocktail" (e.g., shrimp cocktail, crabmeat cocktail) and a statement of the percentage by weight of that seafood ingredient in the product in the manner set forth in §102.5(b).

(b) When the cocktail contains more than one seafood ingredient, the term "seafood cocktail" and a statement of the percentage by weight of each seafood ingredient in the product in the manner set forth in §102.5(b).

§ 102.55 Nonstandardized breaded composite shrimp units.

(a) The common or usual name of the food product that conforms to the definition and standard of identity described by §161.175(c)(6) of this chapter, except that the food is made from comminuted shrimp and is not in raw frozen form, shall be "_____ made from minced shrimp," the blank to be filled in with the words "breaded shrimp sticks" or "breaded shrimp cutlets" depending upon the shape of the product, or if prepared in a shape other than that of sticks or cutlets "breaded shrimp _____ made from minced shrimp," the blank to be filled by a word or phrase that accurately describes the shape and that is not misleading.

(b) The words "made from minced shrimp" shall immediately follow or appear on a line(s) immediately below the other words required by this sec-

tion in easily legible boldface print or type in distinct contrast to other printed or graphic matter, and in a height not less than the larger of the following alternatives:

(1) Not less than one-sixteenth inch in height on packages having a principal display panel with an area of 5 square inches or less and no less than one-eighth inch in height if the area of the principal display panel is greater than 5 square inches; or

(2) Not less than one-half the height of the largest type used in the words "breaded shrimp sticks" or the other comparable words required by this section.

§ 102.57 Greenland turbot (*Reinhardtius hippoglossoides*).

"Greenland turbot" is the common or usual name of the food fish *Reinhardtius hippoglossoides*, a species of *Pleuronectidae* right-eye flounders. The term "halibut" may be associated only with Atlantic halibut (*Hippoglossus hippoglossus*) or Pacific halibut (*Hippoglossus stenolepis*).

PART 104—NUTRITIONAL QUALITY GUIDELINES FOR FOODS

Subpart A—General Provisions

Sec.
104.5 General principles.

Subpart B—Fortification Policy

104.20 Statement of purpose.

Subpart C—Specific Nutritional Quality Guidelines

104.47 Frozen "heat and serve" dinner.

AUTHORITY: 21 U.S.C. 321, 343, 371(a).

SOURCE: 42 FR 14327, Mar. 15, 1977, unless otherwise noted.

Subpart A—General Provisions

§ 104.5 General principles.

(a) A nutritional quality guideline prescribes the minimum level or range of nutrient composition (nutritional quality) appropriate for a given class of food.

(b) Labeling for a product which complies with all of the requirements of

§ 104.20

the nutritional quality guideline established for its class of food may state "This product provides nutrients in amounts appropriate for this class of food as determined by the U.S. Government," except that the words "this product" are optional. This statement, if used, shall be printed on the principal display panel, and may also be printed on the information panel, in letters not larger than twice the size of the minimum type required for the declaration of net quantity of contents by §101.105 of this chapter. Labeling of noncomplying products may not include any such statement or otherwise represent, suggest, or imply the product as being, in whole or in part, in compliance with a guideline.

(c) A product bearing the statement provided for in paragraph (b) of this section, in addition to meeting the requirements of the applicable nutritional quality guideline, shall comply with the following requirements:

(1) The label of the product shall bear the common or usual name of the food in accordance with the provisions of the guideline and §§101.3 and 102.5(a) of this chapter.

(2) The label of the product shall bear nutrition labeling in accordance with §§101.2 and 101.9 of this chapter and all other labeling required by applicable sections of part 101 of this chapter.

(d) No claim or statement may be made on the label or in labeling representing, suggesting, or implying any nutritional or other differences between a product to which nutrient addition has or has not been made in order to meet the guideline, except that a nutrient addition shall be declared in the ingredient statement.

(e) Compliance with a nutrient level specified in a nutritional quality guideline shall be determined by the procedures and requirements established in §101.9(g) of this chapter.

(f) A product within a class of food for which a nutritional quality guideline has been established and to which has been added a discrete nutrient either for which no minimum nutrient level or nutrient range or other allowance has been established as appropriate in the nutritional quality guideline, or at a level that exceeds any maximum established as appropriate in

21 CFR Ch. I (4-1-07 Edition)

the guideline, shall be ineligible to bear the guideline statement provided for in paragraph (b) of this section, and such a product shall also be deemed to be misbranded under the act unless the label and all labeling bear the following prominent and conspicuous statement: "The addition of _____ to (or "The addition of _____ at the level contained in) this product has been determined by the U.S. Government to be unnecessary and inappropriate and does not increase the dietary value of the food," the blank to be filled in with the common or usual name of the nutrient(s) involved.

[42 FR 14327, Mar. 15, 1977, as amended at 63 FR 14818, Mar. 27, 1998]

Subpart B—Fortification Policy

§ 104.20 Statement of purpose.

(a) The fundamental objective of this subpart is to establish a uniform set of principles that will serve as a model for the rational addition of nutrients to foods. The achievement and maintenance of a desirable level of nutritional quality in the nation's food supply is an important public health objective. The addition of nutrients to specific foods can be an effective way of maintaining and improving the overall nutritional quality of the food supply. However, random fortification of foods could result in over- or underfortification in consumer diets and create nutrient imbalances in the food supply. It could also result in deceptive or misleading claims for certain foods. The Food and Drug Administration does not encourage indiscriminate addition of nutrients to foods, nor does it consider it appropriate to fortify fresh produce; meat, poultry, or fish products; sugars; or snack foods such as candies and carbonated beverages. To preserve a balance of nutrients in the diet, manufacturers who elect to fortify foods are urged to utilize these principles when adding nutrients to food. It is reasonable to anticipate that the Reference Daily Intakes (RDI's) as delineated in §101.9 of this chapter and in paragraph (d) of this section will be amended from time to time to list additional nutrients and/or to change the levels of specific RDI's as improved

knowledge about human nutrient requirements and allowances develops. The policy set forth in this section is based on U.S. dietary practices and nutritional needs and may not be applicable in other countries.

(b) A nutrient(s) listed in paragraph (d)(3) of this section may appropriately be added to a food to correct a dietary insufficiency recognized by the scientific community to exist and known to result in nutritional deficiency disease if:

(1) Sufficient information is available to identify the nutritional problem and the affected population groups, and the food is suitable to act as a vehicle for the added nutrients. Manufacturers contemplating using this principle are urged to contact the Food and Drug Administration before implementing a fortification plan based on this principle.

(2) The food is not the subject of any other Federal regulation for a food or class of food that requires, permits, or prohibits nutrient additions. (Other Federal regulations include, but are not limited to, standards of identity promulgated under section 401 of the Federal Food, Drug, and Cosmetic Act, nutritional quality guidelines established in subpart C of this part, and common or usual name regulations established in part 102 of this chapter.)

(c) A nutrient(s) listed in paragraph (d)(3) of this section may appropriately be added to a food to restore such nutrient(s) to a level(s) representative of the food prior to storage, handling, and processing, when:

(1) The nutrient is shown by adequate scientific documentation to have been lost in storage, handling, or processing in a measurable amount equal to at least 2 percent of the Daily Reference Value (DRV) of protein and of potassium and 2 percent of the Reference Daily Intake (RDI) in a normal serving of the food.

(2) Good manufacturing practices and normal storage and handling procedures cannot prevent the loss of such nutrient(s),

(3) All nutrients, including protein, iodine and vitamin D, that are lost in a measurable amount are restored and all ingredients of the food product that

contribute nutrients are considered in determining restoration levels; and

(4) The food is not the subject of any other Federal regulation that requires or prohibits nutrient addition(s), or the food has not been fortified in accordance with any other Federal regulation that permits voluntary nutrient additions.

(d) A nutrient(s) listed in paragraph (d)(3) of this section may be added to a food in proportion to the total caloric content of the food, to balance the vitamin, mineral, and protein content if:

(1) A normal serving of the food contains at least 40 kilocalories (that is, 2 percent of a daily intake of 2,000 kilocalories);

(2) The food is not the subject of any other Federal regulation for a food or class of food that requires, permits, or prohibits nutrient additions; and

(3) The food contains all of the following nutrients per 100 calories based on 2,000 calorie total intake as a daily standard:

Nutrient	Unit of measurement	DRV or RDI ¹	Amount per 100 calories
Protein	grams (g)	50	2.5
Vitamin A	International Unit (IU)	5,000	250
Vitamin C	milligrams (mg)	60	3
Calcium	g	1	0.05
Iron	mg	18	0.9
Vitamin D	IU	400	20
Vitamin E	do	30	1.5
Thiamin	mg	1.5	0.08
Riboflavin	do	1.7	0.09
Niacin	do	20	1
Vitamin B ₆	do	2.0	0.1
Folate	micrograms (µg)	400	20
Vitamin B ₁₂	do	6.0	0.3
Biotin	mg	0.3	0.015
Pantothenic acid	do	10	0.5
Phosphorus	g	1.0	0.05
Magnesium	mg	400	20
Zinc	do	15	0.8
Iodine	µg	150	7.5
Copper	mg	2.0	0.1
Potassium	do	3,500	175

¹ RDI's for adults and children 4 or more years of age.

(e) A nutrient(s) may appropriately be added to a food that replaces traditional food in the diet to avoid nutritional inferiority in accordance with §101.3(e)(2) of this chapter.

(f) Nutrient(s) may be added to foods as permitted or required by applicable regulations established elsewhere in this chapter.

(g) A nutrient added to a food is appropriate only when the nutrient:

§ 104.47

(1) Is stable in the food under customary conditions of storage, distribution, and use;

(2) Is physiologically available from the food;

(3) Is present at a level at which there is a reasonable assurance that consumption of the food containing the added nutrient will not result in an excessive intake of the nutrient, considering cumulative amounts from other sources in the diet; and

(4) Is suitable for its intended purpose and is in compliance with applicable provisions of the act and regulations governing the safety of substances in food.

(h) Any claims or statements in the labeling of food about the addition of a vitamin, mineral, or protein to a food shall be made only if the claim or statement is not false or misleading and otherwise complies with the act and any applicable regulations. The following label claims are acceptable:

(1) The labeling claim “fully restored with vitamins and minerals” or “fully restored with vitamins and minerals to the level of unprocessed _____” (the blank to be filled in with the common or usual name of the food) may be used to describe foods fortified in accordance with the principles established in paragraph (c) of the section.

(2) The labeling claim, “vitamins and minerals (and “protein” when appropriate) added are in proportion to caloric content” may be used to describe food fortified in accordance with the principles established in paragraph (d) of this section.

(3) When labeling claims are permitted, the term “enriched,” “fortified,” “added,” or similar terms may be used interchangeably to indicate the addition of one or more vitamins or minerals or protein to a food, unless an applicable Federal regulation requires the use of specific words or statements.

(i) It is inappropriate to make any claim or statement on a label or in labeling, other than in a listing of the nutrient ingredients as part of the ingredient statement, that any vitamin, mineral, or protein has been added to a food to which nutrients have been

21 CFR Ch. I (4–1–07 Edition)

added pursuant to paragraph (e) of this section.

[45 FR 6323, Jan. 25, 1980, as amended at 58 FR 2228, Jan. 6, 1993]

Subpart C—Specific Nutritional Quality Guidelines

§ 104.47 Frozen “heat and serve” dinner.

(a) A product, for which a common or usual name is established in §102.26 of this chapter, in order to be eligible to bear the guideline statement set forth at §104.5(b), shall contain at least the following three components:

(1) One or more sources of protein derived from meat, poultry, fish, cheese, or eggs.

(2) One or more vegetables or vegetable mixtures other than potatoes, rice, or cereal-based product.

(3) Potatoes, rice, or cereal-based product (other than bread or rolls) or another vegetable or vegetable mixture.

(b) The three or more components named in paragraph (a) of this section, including their sauces, gravies, breadings, etc.:

(1) Shall contribute not less than the minimum levels of nutrients prescribed in paragraph (d) of this section.

(2) Shall be selected so that one or more of the listed protein sources of paragraph (a)(1) of this section, excluding their sauces, gravies, breadings, etc., shall provide not less than 70 percent of the total protein supplied by the components named in paragraph (a) of this section.

(c) If it is necessary to add any nutrient(s) in order to meet the minimum nutrient levels prescribed in paragraph (d) of this section, the addition of each such nutrient may not result in a total nutrient level exceeding 150 percent of the minimum level prescribed. Nutrients used for such addition shall be biologically available in the final product.

(d) Minimum levels of nutrients for a frozen “heat and serve” dinner are as follows:

Nutrient	Minimum levels for frozen "heat and serve" dinner—	
	For each 100 Calories (kcal) of the total components specified in par. (a)	For the total components specified in par. (a)
Protein, grams	4.60	16.0
Vitamin A, IU	150.00	520.0
Thiamine, mg05	.2
Riboflavin, mg06	.2
Niacin, mg99	3.4
Pantothenic acid, mg32	1.1
Vitamin, B ₆ , mg15	.5
Vitamin, B ₁₂ , mg33	1.1
Iron, mg62	2.2

(1) A frozen "heat and serve" dinner prepared from conventional food ingredients listed in paragraph (a) of this section will also contain folic acid, magnesium, iodine, calcium, and zinc. Minimum levels for these nutrients cannot be established at the present time but may be specified as additional data are obtained.

(2) The minimum levels for pantothenic acid, vitamin B-6, and vitamin B-12 are tentative. Final levels will be established when sufficient data are available. Until final levels are established, a product containing less than the tentative levels will not be deemed to be misbranded when labeled in accordance with §104.5(b).

(3) When technologically practicable, iodized salt shall be used or iodine shall be present at a level equivalent to that which would be present if iodized salt were used in the manufacture of the product.

(4) When technologically practicable, product components and ingredients shall be selected to obtain the desirable calcium to phosphorous ratio of 1:1. Technological addition of phosphates shall be minimized and shall not exceed the amount necessary for the intended effect.

(e) If the product includes servings of food which are not prescribed by paragraph (a) of this section (e.g., soup, bread or rolls, beverage, or dessert), their contribution shall not be considered in determining compliance with the nutrient levels established in paragraph (d) of this section but shall be included in any nutrition labeling.

(f) For the purposes of labeling, an "average serving" shall be one entire frozen "heat and serve" dinner.

[42 FR 14327, Mar. 5, 1977]

PART 105—FOODS FOR SPECIAL DIETARY USE

Subpart A—General Provisions

Sec.

105.3 Definitions and interpretations.

Subpart B—Label Statements

105.62 Hypoallergenic foods.

105.65 Infant foods.

105.66 Label statements relating to usefulness in reducing or maintaining body weight.

Subpart C [Reserved]

Subpart D—Standards of Identity [Reserved]

AUTHORITY: 21 U.S.C. 321, 341, 343, 348, 350, 371, 379e.

SOURCE: 42 FR 14328, Mar. 15, 1977, unless otherwise noted.

Subpart A—General Provisions

§ 105.3 Definitions and interpretations.

The definitions and interpretations of terms contained in section 201 of the Federal Food, Drug, and Cosmetic Act (hereafter "the act") shall be applicable with the following additions:

(a)(1) The term *special dietary uses*, as applied to food for man, means particular (as distinguished from general) uses of food, as follows:

(i) Uses for supplying particular dietary needs which exist by reason of a physical, physiological, pathological or other condition, including but not limited to the conditions of diseases, convalescence, pregnancy, lactation, allergic hypersensitivity to food, underweight, and overweight;

(ii) Uses for supplying particular dietary needs which exist by reason of age, including but not limited to the ages of infancy and childhood;

(iii) Uses for supplementing or fortifying the ordinary or usual diet with any vitamin, mineral, or other dietary property. Any such particular use of a food is a special dietary use, regardless

of whether such food also purports to be or is represented for general use.

(2) The use of an artificial sweetener in a food, except when specifically and solely used for achieving a physical characteristic in the food which cannot be achieved with sugar or other nutritive sweetener, shall be considered a use for regulation of the intake of calories and available carbohydrate, or for use in the diets of diabetics and is therefore a special dietary use.

(b)-(d) [Reserved]

(e) For the purposes of the regulations in this part, the terms *infant*, *child*, and *adult* mean persons not more than 12 months old, more than 12 months but less than 12 years old, and 12 years or more old, respectively.

[42 FR 14328, Mar. 15, 1977, as amended at 44 FR 16006, Mar. 16, 1979; 44 FR 49665, Aug. 24, 1979]

Subpart B—Label Statements

§ 105.62 Hypoallergenic foods.

If a food purports to be or is represented for special dietary use by reason of the decrease or absence of any allergenic property or by reason of being offered as food suitable as a substitute for another food having an allergenic property, the label shall bear:

(a) The common or usual name and the quantity or proportion of each ingredient (including spices, flavoring, and coloring) in case the food is fabricated from two or more ingredients.

(b) A qualification of the name of the food, or the name of each ingredient thereof in case the food is fabricated from two or more ingredients, to reveal clearly the specific plant or animal that is the source of such food or of such ingredient, if such food or such ingredient consists in whole or in part of plant or animal matter and such name does not reveal clearly the specific plant or animal that is such a source.

(c) An informative statement of the nature and effect of any treatment or processing of the food or any ingredient thereof, if the changed allergenic property results from such treatment or processing.

§ 105.65 Infant foods.

(a) If a food (other than a dietary supplement of vitamins and/or min-

erals alone) purports to be or is represented for special dietary use for infants, the label shall bear, if such food is fabricated from two or more ingredients, the common or usual name of each ingredient, including spices, flavoring, and coloring.

(b) If such food, or any ingredient thereof, consists in whole or in part of plant or animal matter and the name of such food or ingredient does not clearly reveal the specific plant or animal which is its source, such name shall be so qualified as to reveal clearly the specific plant or animal that is such source.

[42 FR 14328, Mar. 15, 1977, as amended at 47 FR 947, Jan. 8, 1982; 49 FR 10090, Mar. 19, 1984; 50 FR 1840, Jan. 14, 1985]

§ 105.66 Label statements relating to usefulness in reducing or maintaining body weight.

(a) *General requirements.* Any food that purports to be or is represented for special dietary use because of usefulness in reducing or maintaining body weight shall bear:

(1) Nutrition labeling in conformity with § 101.9, or, where applicable, § 101.36 of this chapter, unless exempt under that section; and

(2) A conspicuous statement of the basis upon which the food claims to be of special dietary usefulness.

(b) *Nonnutritive ingredients.* (1) Any food subject to paragraph (a) of this section that achieves its special dietary usefulness by use of a nonnutritive ingredient (i.e., one not utilized in normal metabolism) shall bear on its label a statement that it contains a nonnutritive ingredient and the percentage by weight of the nonnutritive ingredient.

(2) A special dietary food may contain a nonnutritive sweetener or other ingredient only if the ingredient is safe for use in the food under the applicable law and regulations of this chapter. Any food that achieves its special dietary usefulness in reducing or maintaining body weight through the use of a nonnutritive sweetener shall bear on its label the statement required by paragraph (b)(1) of this section, but need not state the percentage by weight of the nonnutritive sweetener. If a nutritive sweetener(s) as well as

nonnutritive sweetener(s) is added, the statement shall indicate the presence of both types of sweetener, e.g., “Sweetened with nutritive sweetener(s) and nonnutritive sweetener(s).”

(c) “*Low calorie*” foods. A food purporting to be “low calorie” must comply with the criteria set forth for such foods in §101.60(b)(2) and (b)(3) of this chapter.

(d) “*Reduced calorie*” foods and other comparative calorie claims. A food purporting to be “reduced calorie” or otherwise containing fewer calories than a reference food must comply with the criteria set forth for such food in §101.60(b)(4) and (b)(5) of this chapter.

(e) *Label terms suggesting usefulness as low calorie or reduced calorie foods.* (1) Except as provided in paragraphs (e)(2) and (e)(3) of this section, and in §101.13(q)(2) of this chapter for soft drinks, a food may be labeled with terms such as “diet,” “dietetic,” “artificially sweetened,” or “sweetened with nonnutritive sweetener” only if the claim is not false and misleading, and the food is labeled “low calorie” or “reduced calorie” or bears another comparative calorie claim in compliance with part 101 of this chapter and this section.

(2) Paragraph (e)(1) of this section shall not apply to any use of such terms that is specifically authorized by regulation governing a particular food, or, unless otherwise restricted by regulation, to any use of the term “diet” that clearly shows that the food is offered solely for a dietary use other than regulating body weight, e.g., “for low-sodium diets.”

(3) Paragraph (e)(1) of this section shall not apply to any use of such terms on a formulated meal replacement or other food that is represented to be of special dietary use as a whole meal, pending the issuance of a regulation governing the use of such terms on foods.

(f) “*Sugar free*,” and “*no added sugar*.” Criteria for the use of the terms “sugar free” and “no added sugar” are provided for in §101.60(c) of this chapter.

[58 FR 2430, Jan. 6, 1993]

Subpart C [Reserved]

Subpart D—Standards of Identity [Reserved]

PART 106—INFANT FORMULA QUALITY CONTROL PROCEDURES

Subpart A—General Provisions

Sec.

- 106.1 Status and applicability of the quality control procedures regulation.
- 106.3 Definitions.

Subpart B—Quality Control Procedures for Assuring Nutrient Content of Infant Formulas

- 106.20 Ingredient control.
- 106.25 In-process control.
- 106.30 Finished product evaluation.
- 106.90 Coding.

Subpart C—Records and Reports

- 106.100 Records.

Subpart D—Notification Requirements

- 106.120 New formulations and reformulations.

AUTHORITY: 21 U.S.C. 321, 350a, 371.

SOURCE: 47 FR 17025, Apr. 20, 1982, unless otherwise noted.

Subpart A—General Provisions

§ 106.1 Status and applicability of the quality control procedures regulation.

(a) The criteria set forth in §§106.20, 106.25, 106.30, 106.90, and 106.100 shall apply in determining whether an infant formula meets the safety, quality, and nutrient requirements of section 412 of the act and the requirements of regulations promulgated under section 412(a)(2) of the act.

(b) The failure to comply with any regulation set forth in §§106.20, 106.25, 106.30, 106.90, and 106.100 applicable to the manufacturing, processing, and packaging of an infant formula shall render such formula adulterated under section 412(a)(1)(C) of the act.

(c) References in this part to regulatory sections of the Code of Federal Regulations are to chapter I of title 21 unless otherwise noted.

§ 106.3 Definitions.

The definitions and interpretations contained in section 201 of the act are applicable to such terms when used in this part. The following definitions shall also apply:

(a) *Indicator nutrient.* An indicator nutrient is a nutrient whose concentration is measured during the manufacture of an infant formula to confirm complete addition and/or uniform distribution of a premix or other substance of which the indicator nutrient is a part.

(b) *In-process batch.* An in-process batch is a combination of ingredients at any point in the manufacturing process before packaging.

(c) *Manufacturer.* A manufacturer is a person who prepares, reconstitutes, or otherwise changes the physical or chemical characteristics of an infant formula and/or packages the product in a container for distribution.

(d) *Nutrient.* A nutrient is any vitamin, mineral, or other substance required in accordance with the table set out in section 412(g) of the act or by regulations promulgated under section 412(a)(2)(A) of the act.

(e) *Nutrient premix.* A nutrient premix is a combination of ingredients containing two or more nutrients. A nutrient premix either may be received from a supplier or be prepared by an infant formula manufacturer.

Subpart B—Quality Control Procedures for Assuring Nutrient Content of Infant Formulas

§ 106.20 Ingredient control.

(a) Except as provided in § 106.20(b), no analysis before use in manufacturing is needed for ingredients that are generally stable in shipping and storage, and that either are received under a supplier's guarantee or certification that the mixture has been analyzed as to nutrient composition or are labeled as having nutrient compositions complying with specifications in the U.S. Pharmacopeia, the National Formulary, the Food Chemicals Codex, or other similar recognized standards.

(b) Unless each batch of finished product is analyzed as specified in § 106.30(b)(1) before release of product

for commercial or charitable distribution, the following shall apply:

(1) When an ingredient is relied upon as a source of a nutrient(s) and when evidence indicates that such nutrient(s) in that ingredient is likely to be affected adversely by shipping or storage conditions, the manufacturer shall analyze that ingredient for each relied-upon nutrient that may be affected, using validated analytical methods.

(2) Ingredients, including nutrient premixes, that are either without a supplier's guarantee or certification, or not labeled as complying with prescribed standards, shall be sampled and analyzed for each relied-upon nutrient by the manufacturer, except that ingredients used as a major source of protein or fat need not be analyzed for each relied-upon nutrient if the manufacturer has records to show that each relied-upon nutrient is present at a reasonably constant level. Nutrient premixes prepared by the infant formula manufacturer shall be sampled and analyzed for each relied-upon nutrient. Nutrient premixes which are received from suppliers shall be sampled and analyzed for each relied-upon nutrient unless the supplier has sampled and analyzed each batch of premix for each relied-upon nutrient and has so certified in writing.

§ 106.25 In-process control.

(a) For each infant formula, a master manufacturing order shall be prepared and approved by a responsible official of the manufacturer. The manufacturer shall establish a quality control system that assures and verifies the addition of each ingredient specified in the manufacturing order.

(b) Unless each batch of finished product is analyzed as specified in § 106.30(b)(1), the manufacturer shall analyze each in-process batch for:

- (1) Solids;
- (2) Protein, fat, and carbohydrates (carbohydrates either by analysis or by mathematical difference);
- (3) The indicator nutrient(s) in each nutrient premix;
- (4) Each nutrient added independently of nutrient premixes during formulation of the product, except for linoleic acid, vitamin D, vitamin K, choline, inositol, and biotin; and

(5) Solids or an appropriate nutrient to confirm proper dilution when final dilution is made after performance of the analyses in paragraph (b) (1) through (4) of this section.

§ 106.30 Finished product evaluation.

(a) The manufacturer shall establish criteria for sampling and testing to ensure that each batch of infant formula meets the nutrient requirements of section 412(g) of the act or of regulations promulgated under section 412(a)(2) of the act before release of product for commercial or charitable distribution.

(b)(1) *Immediate analysis.* Before release of product for commercial or charitable distribution, the manufacturer shall analyze representative samples of each batch of finished product for:

(i) Specific nutrient(s) to assess process degradation; and

(ii) All nutrients not previously analyzed for by the manufacturers, unless each in-process batch is analyzed for nutrients as specified in §106.25(b) and the ingredients are analyzed as specified in §106.20(b). No analyses are needed for linoleic acid, vitamin D, vitamin K, choline, inositol, and biotin; and for nutrients that are added as a part of a nutrient premix analyzed by the manufacturer or having a supplier's guarantee or certification and for which an indicator nutrient(s) was analyzed by the manufacturer.

(2) *Periodic analysis.* The manufacturer shall sample at least one newly processed finished product batch every 3 months and shall analyze representative samples for all nutrients except those that the manufacturers measured in the immediate analysis of that product batch.

(3) *Stability analysis.* Using representative samples collected from finished product batches, the manufacturer shall conduct stability analysis for selected nutrients with sufficient frequency to substantiate the maintenance of nutrient content throughout the shelf life of the product.

(c) The manufacturer shall evaluate new formulations and the effect of changes in ingredients or processing conditions that could affect the level of nutrients by means of a testing pro-

gram designed to confirm uniformity of batches and to determine the effects of such changes. The following shall apply:

(1) A minor change is a minor reduction in nutrient levels, a minor increase in levels of nutrients that are subject to maximum limits established under section 412(g) of the act or in regulations established under section 412(a)(2) of the act, or any other change where experience or theory would not predict a possible significant adverse impact on nutrient levels or nutrient availability. After a minor change the manufacturer shall analyze representative samples for all nutrients so changed and those possibly affected by the change.

(2) A major change is any new formulation, or any change of ingredients or processes where experience or theory would predict a possible significant adverse impact on levels of nutrients or availability of nutrients. After a major change the manufacturer shall analyze representative samples for osmolality, all nutrients, and the biological quality of the protein. A protein biological quality analysis is not necessary for a formulation change that is not expected to have an adverse effect on the biological quality of the protein. Vitamin D shall be determined by the rat bioassay method as prescribed in "Official Methods of Analysis of the Association of Official Analytical Chemists" (AOAC), 13th Ed. (1980), sections 43.195-43.208, "Vitamin D (30)—Official Final Action," which is incorporated by reference. Copies are available from the AOAC INTERNATIONAL, 481 North Frederick Ave., suite 500, Gaithersburg, MD 20877, or available for inspection at the National Archives and Records Administration (NARA). For information on the availability of this material at NARA, call 202-741-6030, or go to: http://www.archives.gov/federal_register/code_of_federal_regulations/ibr_locations.html. Before release of the product for commercial or charitable distribution, the manufacturer shall have completed all appropriate analyses except that shipment of the product need not be delayed until results of

§ 106.90

21 CFR Ch. I (4-1-07 Edition)

the vitamin D bioassay and, if required, a protein biological quality bioassay are complete, provided such bioassays have been initiated, and if another analysis for the vitamin D has been run and the protein content has been determined by a suitable method. The biological quality of the protein shall be determined by an appropriate modification of the AOAC bioassay method of analysis. The manufacturer shall analyze additional samples from the same batch for vitamin D, by any suitable method, and for the biological quality of the protein. The manufacturer shall perform such analyses at least annually for a period not to exceed the expected shelf life of the product.

(d) A simple adjustment in the level of an ingredient to accommodate inconsistencies in processing is considered to be neither a minor nor a major change.

[47 FR 17025, Apr. 20, 1982, as amended at 54 FR 24891, June 12, 1989; 63 FR 14035, Mar. 24, 1998]

§ 106.90 Coding.

The manufacturer shall code all infant formulas in conformity with the coding requirements that are applicable to thermally processed low-acid foods packaged in hermetically sealed containers as prescribed in § 113.60(c).

Subpart C—Records and Reports

§ 106.100 Records.

(a) Every manufacturer of infant formula shall maintain the records specified in this regulation in order to permit the Food and Drug Administration to determine whether each manufacturer is in compliance with section 412 of the Federal Food, Drug, and Cosmetic Act (the act).

(b) The manufacturer shall maintain all records that pertain to food-packaging materials subject to § 174.5 of this chapter and that bear on whether such materials would cause an infant formula to be adulterated within the meaning of section 402(a)(2)(C) of the act.

(c) The manufacturer shall maintain all records that pertain to nutrient premix testing that it generates or re-

ceives. Such records shall include, but are not limited to:

(1) Any results of testing conducted to ensure that each nutrient premix is in compliance with the premix certificate and guarantee and specifications that have been provided to the manufacturer by the premix supplier, including tests conducted when nutrients exceed their expiration date or shelf life (retest date).

(2) All certificates and guarantees given by premix suppliers concerning the nutrients required by section 412(i) of the act and § 107.100 of this chapter.

(d) The premix supplier shall maintain the results of all testing conducted to provide all certificates and guarantees concerning nutrient premixes for infant formulas. Such records shall include but are not limited to:

(1) The results of tests conducted to determine the purity of each nutrient required by section 412(i) of the act or § 107.100 of this chapter and any other nutrient listed in the certificate and guarantee;

(2) The weight of each nutrient added;

(3) The results of any quantitative tests conducted to determine the amount of each nutrient certified or guaranteed; and

(4) The results of any quantitative tests conducted to identify the nutrient levels present when nutrient premixes exceed their expiration date or shelf life (retest date).

(e) The manufacturer shall maintain all records necessary to ensure proper nutrient quality control in the manufacture of infant formula products. Such records shall include the results of any testing conducted to verify that each nutrient required by section 412(i) of the act or § 107.100 of this chapter is present in each batch of infant formula at the appropriate concentration. This requirement pertains to ingredients, in process batch and finished product from the time of manufacture through its expiration date.

(f) The manufacturer shall maintain all records necessary to ensure required nutrient content at the final product stage. Such records shall include, but are not limited to, testing results for vitamins A, B₁ (thiamine),

C, and E for each batch of infant formula. “Final product stage” means the point in the manufacturing process prior to distribution at which the infant formula is homogenous and not subject to further degradation from the manufacturing process.

(g) The manufacturer shall maintain all records pertaining to distribution of the infant formula. Such records shall include, but not be limited to, all information and data necessary to effect and monitor recalls of the manufacturer’s infant formula products in accordance with subpart E of part 107 of this chapter.

(h) The manufacturer shall maintain all records pertaining to the microbiological quality and purity of raw materials and finished powdered infant formula.

(i) [Reserved]

(j) The manufacturer shall maintain all records pertaining to regularly scheduled audits, including audit plans and procedures. Audit plans identify the specific manufacturing and quality control procedures to be reviewed. Audit procedures are the methods used to review the manufacturing and quality control procedures. Records of audits shall include the information and data necessary for a determination as to whether the manufacturer complies with the current good manufacturing practices and quality procedures identified in parts 106, 107, 109, 110, and 113 of this chapter. The records shall include written assurances from the manufacturer that regularly scheduled audits are being conducted by appropriately trained individuals who do not have any direct responsibility for the manufacture or production of infant formula, and that the complete audit plans and procedures for the firm have been followed. The actual written reports of the audits need not be made available.

(k) The manufacturer shall maintain procedures describing how all written and oral complaints regarding infant formula will be handled. The manufacturer shall follow these procedures and shall include in them provisions for the review of any complaint involving an infant formula and for determining the need for an investigation of the possible existence of a hazard to health.

(1) For purposes of this section, every manufacturer shall interpret a “complaint” as any communication that contains any allegation, written or oral, expressing dissatisfaction with a product for any reason, including concerns about the possible existence of a hazard to health and about appearance, taste, odor, and quality. Correspondence about prices, package size or shape, or other matters that could not possibly reveal the existence of a hazard to health shall not, for compliance purposes, be considered a complaint and therefore need not be made available to an FDA investigator.

(2) When a complaint shows that a hazard to health possibly exists, the manufacturer shall conduct an investigation into the validity of the complaint. Where such an investigation is conducted, the manufacturer shall include in its file on the complaint the determination as to whether a hazard to health exists and the basis for that determination. No investigation is necessary when the manufacturer determines that there is no possibility of a hazard to health. When no investigation is necessary, the manufacturer shall include in the record the reason that an investigation was found to be unnecessary and the name of the responsible person making that determination.

(3) When there is a reasonable possibility of a causal relationship between the consumption of an infant formula and an infant’s death, the manufacturer shall, within 15 days of receiving such information, conduct an investigation and notify the agency as required in §106.120(b).

(4) The manufacturer shall maintain in designated files all records pertaining to the complaints it receives. The manufacturer shall separate the files into two classes:

(i) Those complaints that allege that the infant became ill from consuming the product or required treatment by a physician or health-care provider.

(ii) Those complaints that may involve a possible existence of a hazard to health but do not refer to an infant becoming ill or the need for treatment by physician or a health care provider.

§ 106.120

21 CFR Ch. I (4–1–07 Edition)

(5) The manufacturer shall include in a complaint file the following information concerning the complaint:

- (i) The name of the infant formula;
- (ii) The batch number;
- (iii) The name of complainant;
- (iv) A copy of the complaint or a memo of the telephone conversation or meeting and all correspondence with the complainant;
- (v) By reference or copy, all the associated manufacturing records and complaint investigation records needed to evaluate the complaint. When copies of such records are not maintained in the complaint file, they must be available within 24 hours when requested by an FDA official.

(vi) All actions taken to follow up on the complaint; and

(vii) All findings and evaluations of the complaint.

(6) The manufacturer should maintain the files regarding infant formula complaints at the establishment where the infant formula was manufactured, processed, or packed. When the manufacturer wishes to maintain all consumer complaints for the entire firm at one location other than at the facility where an infant formula was manufactured, processed, or packed, the manufacturer may do so as long as all records required by this section are available within 24 hours of request for inspection at that facility. However, all records of consumer complaints, including summaries, any reports, and any files, maintained at the manufacturing facility or at any other facility shall be made available to investigators for review and copying upon request.

(l) The manufacturer shall make readily available for authorized inspection all records required under this part or copies of such records. Records shall be available at any reasonable time at the establishment where the activities described in such records occurred. (Infant formula complaint files may be maintained at one facility, as provided in §106.100(k)(6), if all required records are readily available at that facility.) These records or copies thereof shall be subject to photocopying or other means of reproduction as part of such inspection. Records that can be immediately retrieved from another lo-

cation by electronic means shall be considered as meeting the requirements of this paragraph.

(m) Records required under this part may be retained either as original records or as true copies such as photocopies, microfilm, microfiche, or other accurate reproductions of the original records. Where reduction techniques, such as microfilming are used, suitable reader and photocopying equipment shall be readily available.

(n) Production control, product testing, testing results, complaints, and distribution records necessary to verify compliance with parts 106, 107, 109, 110, and 113 of this chapter, or with other appropriate regulations, shall be retained for 1 year after the expiration of the shelf life of the infant formula or 3 years from the date of manufacture, whichever is greater.

(o) The manufacturer shall maintain quality control records that contain sufficient information to permit a public health evaluation of any batch of infant formula.

[56 FR 66571, Dec. 24, 1991; 57 FR 7435, Mar. 2, 1992]

Subpart D—Notification Requirements

§ 106.120 New formulations and reformulations.

(a) Information required by section 412(b)(2) and (3) of the act shall be submitted to Center for Food Safety and Applied Nutrition (HFS-830), Food and Drug Administration, 5100 Paint Branch Pkwy., College Park, MD 20740.

(b) The manufacturer shall promptly notify the Food and Drug Administration when the manufacturer has knowledge (as defined in section 412(c)(2) of the act) that reasonably supports the conclusion that an infant formula that has been processed by the manufacturer and that has left an establishment subject to the control of the manufacturer may not provide the nutrients required by section 412(g) of the act and by regulations promulgated under section 412(a)(2) of the act, or when there is an infant formula that is otherwise adulterated or misbranded and that may present risk to human health. This notification shall be made,

by telephone, to the Director of the appropriate Food and Drug Administration district office specified in part 5, subpart M of this chapter. After normal business hours (8 a.m. to 4:30 p.m.) the FDA emergency number, 301-443-1240, shall be used. The manufacturer shall send a followup written confirmation to the Center for Food Safety and Applied Nutrition (HFS-605), Food and Drug Administration, 5100 Paint Branch Pkwy., College Park, MD 20740, and to the appropriate Food and Drug Administration district office specified in part 5, subpart M of this chapter.

[47 FR 17025, Apr. 20, 1982, as amended at 54 FR 24891, June 12, 1989; 61 FR 14479, Apr. 2, 1996; 66 FR 17358, Mar. 30, 2001; 66 FR 56035, Nov. 6, 2001; 69 FR 17291, Apr. 2, 2004]

PART 107—INFANT FORMULA

Subpart A—General Provisions

Sec.
107.3 Definitions.

Subpart B—Labeling

107.10 Nutrient information.
107.20 Directions for use.
107.30 Exemptions.

Subpart C—Exempt Infant Formulas

107.50 Terms and conditions.

Subpart D—Nutrient Requirements

107.100 Nutrient specifications.

Subpart E—Infant Formula Recalls

107.200 Food and Drug Administration-required recall.
107.210 Firm-initiated product removals.
107.220 Scope and effect of infant formula recalls.
107.230 Elements of an infant formula recall.
107.240 Notification requirements.
107.250 Termination of an infant formula recall.
107.260 Revision of an infant formula recall.
107.270 Compliance with this subpart.
107.280 Records retention.

AUTHORITY: 21 U.S.C. 321, 343, 350a, 371.

SOURCE: 50 FR 1840, Jan. 14, 1985, unless otherwise noted.

Subpart A—General Provisions

§ 107.3 Definitions.

The following definitions shall apply, in addition to the definitions contained in section 201 of the Federal Food, Drug, and Cosmetic Act (the act):

Exempt formula. An exempt infant formula is an infant formula intended for commercial or charitable distribution that is represented and labeled for use by infants who have inborn errors of metabolism or low birth weight, or who otherwise have unusual medical or dietary problems.

Manufacturer. A manufacturer is a person who prepares, reconstitutes, or otherwise changes the physical or chemical characteristics of an infant formula or packages the infant formula in containers for distribution.

References. References in this part to regulatory sections of the Code of Federal Regulations are to chapter I of title 21, unless otherwise noted.

[50 FR 48186, Nov. 22, 1985]

Subpart B—Labeling

§ 107.10 Nutrient information.

(a) The labeling of infant formulas, as defined in section 201(aa) of the Federal Food, Drug, and Cosmetic Act, shall bear in the order given, in the units specified, and in tabular format, the following information regarding the product as prepared in accordance with label directions for infant consumption:

(1) A statement of the number of fluid ounces supplying 100 kilocalories (in case of food label statements, a kilocalorie is represented by the word “Calorie”); and

(2) A statement of the amount of each of the following nutrients supplied by 100 kilocalories:

Nutrients	Unit of measurement
Protein	Grams.
Fat	Do.
Carbohydrate	Do.
Water	Do.
Linoleic acid	Milligrams.
Vitamins:	
Vitamin A	International units.
Vitamin D	Do.
Vitamin E	Do.
Vitamin K	Micrograms.
Thiamine (Vitamin B ₁)	Do.
Riboflavin (Vitamin B ₂)	Do.

§ 107.20

21 CFR Ch. I (4–1–07 Edition)

Nutrients	Unit of measurement
Vitamin B ₆	Do.
Vitamin B ₁₂	Do.
Niacin	Do.
Folic acid (Folacin)	Do.
Pantothenic acid	Do.
Biotin	Do.
Vitamin C (Ascorbic acid)	Milligrams.
Choline	Do.
Inositol	Do.
Minerals:	
Calcium	Milligrams.
Phosphorus	Do.
Magnesium	Do.
Iron	Do.
Zinc	Do.
Manganese	Micrograms.
Copper	Do.
Iodine	Do.
Sodium	Milligrams.
Potassium	Do.
Chloride	Do.

(b) In addition the following apply:

(1) Vitamin A content may also be declared on the label in units of microgram retinol equivalents, vitamin D content in units of micrograms cholecalciferol, vitamin E content in units of milligram alpha-tocopherol equivalents, and sodium, potassium, and chloride content in units of millimoles, micromoles, or milli-equivalents. When these declarations are made they shall appear in parentheses immediately following the declarations in International Units for vitamins A, D, and E, and immediately following the declarations in milligrams for sodium, potassium, and chloride.

(2) Biotin, choline, and inositol content shall be declared except when they are not added to milk-based infant formulas.

(3) Each of the listed nutrients, and the caloric density, may also be declared on the label on other bases, such as per 100 milliliters or per liter, as prepared for infant consumption.

(4) One of the following statements shall appear on the principal display panel, as appropriate:

(i) The statement “Infant Formula With Iron”, or a similar statement, if the product contains 1 milligram or more of iron in a quantity of product that supplies 100 kilocalories when prepared in accordance with label directions for infant consumption.

(ii) The statement “Additional Iron May Be Necessary”, or a similar statement, if the product contains less than

1 milligram of iron in a quantity of product that supplies 100 kilocalories when prepared in accordance with label directions for infant consumption.

(5) Any additional vitamin may be declared at the bottom of the vitamin list and any additional minerals may be declared between iodine and sodium, provided that any additionally declared nutrient (i) has been identified as essential by the National Academy of Sciences through its development of a recommended dietary allowance or an estimated safe and adequate daily dietary intake range, or has been identified as essential by the Food and Drug Administration through a FEDERAL REGISTER publication or establishment of a U.S. Recommended Daily Allowance, and (ii) is provided at a level considered in these publications as having biological significance, when these levels are known.

[50 FR 1840, Jan. 14, 1985, as amended at 67 FR 9585, Mar. 4, 2002]

§ 107.20 Directions for use.

In addition to the applicable labeling requirements in parts 101 and 105 of this chapter, the product label shall bear:

(a) Under the heading “Directions For Preparation and Use”, directions for:

(1) Storage of infant formula before and after the container has been opened, including a statement indicating that prolonged storage at excessive temperatures should be avoided;

(2) Agitating liquid infant formula before opening the container, such as “Shake Well Before Opening”;

(3) “Sterilization” of water, bottle, and nipples when necessary for preparing infant formula for use;

(4) Dilution of infant formula, when appropriate. Directions for powdered infant formula shall contain the weight and volume of powdered formula to be reconstituted.

(b) In close proximity to the “Directions for Preparation and Use” a pictogram depicting the major steps for preparation of that infant formula, such as (for a concentrated formula):

Sterilization is recommended.
Your physician will decide if it
is not required.

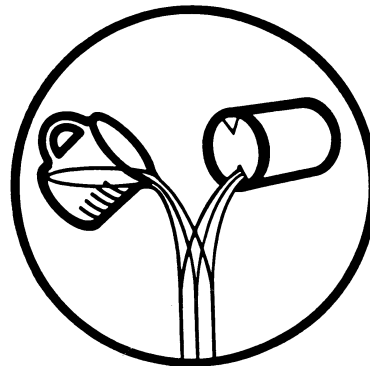
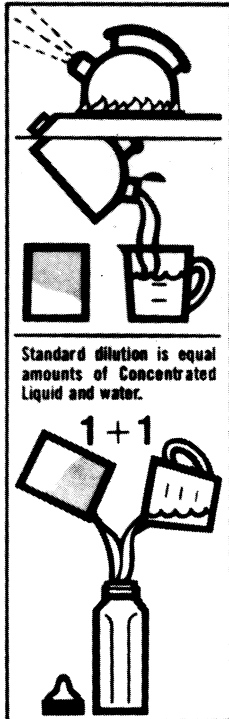

if the addition of water is necessary. The symbol shall be placed on a white background encircled by a dark border.

(e) A warning statement beneath or in close proximity to the "Directions For Preparation and Use" that cautions against improper preparation or use of an infant formula, such as "THE HEALTH OF YOUR INFANT DEPENDS ON CAREFULLY FOLLOWING THE DIRECTIONS FOR PREPARATION AND USE".

(f) A statement indicating that parents should consult their physicians about the use of infant formulas, such as "USE AS DIRECTED BY A PHYSICIAN".

(c) A "Use by ____" date, the blank to be filled in with the month and year selected by the manufacturer, packer, or distributor of the infant formula on the basis of tests or other information showing that the infant formula, until that date, under the conditions of handling, storage, preparation, and use prescribed by label directions, will: (1) when consumed, contain not less than the quantity of each nutrient, as set forth on its label; and (2) otherwise be of an acceptable quality (e.g., pass through an ordinary bottle nipple).

(d) The statement "Add Water" or "Do Not Add Water", as appropriate, to appear on the principal display panel of concentrated or ready-to-feed infant formulas. In close proximity to the statement "Add Water", a symbol such as

[50 FR 1840, Jan. 14, 1985, as amended at 67 FR 9585, Mar. 4, 2002]

§ 107.30 Exemptions.

When containers of ready-to-feed infant formula, to be sold at the retail level, are contained within a multiunit package, the labels of the individual containers shall contain all of the label information required by section 403 of the Federal Food, Drug, and Cosmetic Act (the act), §§107.10 and 107.20, and all appropriate sections of part 101 of this chapter, except that the labels of the individual containers contained within the outer package shall be exempt from compliance with the requirements of section 403 (e)(1) and (i)(2) of the act; and §§107.10 (a) and (b)(2) and 107.20 (b), (e), and (f), provided that (a) the multiunit package meets all the requirements of this part; (b) individual containers are securely enclosed within and are not intended to be separated

from the retail package under conditions of retail sale; and (c) the label on each individual container includes the statement "This Unit Not Intended For Individual Sale" in type size not less than one-sixteenth inch in height. The word "Retail" may be used in lieu of or immediately following the word "Individual" in the statement.

Subpart C—Exempt Infant Formulas

§ 107.50 Terms and conditions.

(a) *Terms and conditions.* Section 412(f)(1) of the act exempts from the requirements of section 412(a), (b), and (c)(1)(A) of the act infant formulas that are represented and labeled for use by an infant who has an inborn error of metabolism or low birth weight or who otherwise has an unusual medical or dietary problem, if such formulas comply with regulations prescribed by the Secretary. The regulations in this subpart establish the terms and conditions that a manufacturer must meet with respect to such infant formulas.

(b) *Infant formulas generally available at the retail level.* (1) These exempt infant formulas can generally be purchased from retail store shelves that are readily available to the public. Such formulas are also typically represented and labeled for use to provide dietary management for diseases or conditions that are not clinically serious or life-threatening, even though such formulas may also be represented and labeled for use in clinically serious or life-threatening disorders.

(2) Except as provided in paragraphs (b)(4) and (5) of this section, an infant formula manufacturer shall, with respect to each formula covered by this paragraph, comply with the nutrient requirements of section 412(g) of the act or of regulations promulgated under section 412(a)(2) of the act, the quality control procedure requirements of part 106, and the labeling requirements of subpart B of this part.

(3) To retain the exempt status of an infant formula covered by this paragraph, the manufacturer shall submit to the Food and Drug Administration (FDA), at the address specified in paragraph (e)(1) of this section, on or before May 21, 1986, or on or before the 90th

day before the first processing of the infant formula for commercial or charitable distribution, whichever occurs later, the label and other labeling of the infant formula, a complete quantitative formulation for the infant formula, and a detailed description of the medical conditions for which the infant formula is represented. FDA will review the information under paragraph (d) of this section.

(4) To retain the exempt status of an infant formula covered by this paragraph, when any change in ingredients or processes that may result in an adverse impact on levels of nutrients or availability of nutrients is instituted, the manufacturer shall submit to FDA at the address specified in paragraph (e)(1) of this section, before the first processing of the infant formula, the label and other labeling of the infant formula, a complete quantitative formulation for the infant formula, a detailed description of the reformulation and the rationale for the reformulation, a complete description of the change in processing, and a detailed description of the medical conditions for which the infant formula is represented. FDA will review that information under paragraph (d) of this section.

(5) A manufacturer may deviate from the requirements of paragraph (b)(2) of this section only with respect to those specific requirements for which it submits to FDA, at the address specified in paragraph (e)(1) of this section, the medical, nutritional, scientific, or technological rationale (including any appropriate animal or human clinical studies). FDA will review that information under paragraph (d) of this section.

(c) *Infant formulas not generally available at the retail level.* (1) These exempt infant formulas are not generally found on retail shelves for general consumer purchase. Such formulas typically are prescribed by a physician, and must be requested from a pharmacist or are distributed directly to institutions such as hospitals, clinics, and State or Federal agencies. Such formulas are also generally represented and labeled solely to provide dietary management for specific diseases or conditions that are clinically serious or life-threatening

and generally are required for prolonged periods of time. Exempt infant formulas distributed directly to institutions such as hospitals, clinics, and State or Federal agencies that are of the same formulation as those generally available at the retail level are subject to the requirements of paragraph (b) of this section rather than to the requirements of this paragraph.

(2) Except as provided for in paragraph (c)(5) of this section, an infant formula manufacturer shall, with respect to each formula covered by this paragraph, comply with the nutrient requirements of section 412(g) of the act or of regulations promulgated under section 412(a)(2) of the act, and the labeling requirements of subpart B of this part.

(3) Each manufacturer of an infant formula covered by this paragraph shall establish quality control procedures designed to ensure that the infant formula meets applicable nutrient requirements of this section, including any special nutritional characteristics for the specific disorders or conditions for which the formula is represented for use. Each manufacturer shall maintain records of such quality control procedures sufficient to permit a public health evaluation of each manufactured batch of infant formula and shall permit any authorized FDA employee at all reasonable times to have access to and to copy and verify the records referred to in this paragraph.

(4) To retain the exempt status of an infant formula covered by this paragraph, the manufacturer shall submit the information required by paragraphs (b)(3) and (4) of this section.

(5) A manufacturer may deviate from the requirements of paragraph (c)(2) of this section only with respect to those specific requirements for which it submits to FDA, at the address specified in paragraph (e)(1) of this section, the medical, nutritional, scientific, or technological rationale (including any appropriate animal or human clinical studies). FDA will review that information under paragraph (d) of this section.

(6) The requirements of this section do not apply to an infant formula specially and individually prepared for one

or more specific infants on a physician's request.

(d) *FDA review of exempt status.* (1) FDA's Center for Food Safety and Applied Nutrition will review information submitted by infant formula manufacturers under paragraph (b) (3), (b) (4), or (c)(4) of this section. On the basis of such review and other information available to the agency, the Center for Food Safety and Applied Nutrition may impose additional conditions on, or modify requirements for, the quality control procedures, nutrient specifications, or labeling of an infant formula, or withdraw a product's exempt status. Such determinations will be made by the Director of the Center for Food Safety and Applied Nutrition.

(2)(i) If after completing its review of all information submitted, the Center for Food Safety and Applied Nutrition concludes that additional or modified quality control, nutrient, or labeling requirements are needed, or that a product's exempt status is withdrawn, the Center for Food Safety and Applied Nutrition will so notify the manufacturer and this notification will specify the reasons therefor. Upon receipt of this notification, the manufacturer has 10 working days to have the decision reviewed under §107.50 by the office of the Commissioner of Food and Drugs. A determination by the Director of the Center for Food Safety and Applied Nutrition that is not appealed becomes a final agency decision.

(ii) After a final decision by the Director or by the office of the Commissioner that a product's exempt status is withdrawn, the manufacturer shall comply with the nutrient requirements of section 412(g) of the act or of regulations promulgated under section 412(a)(2) of the act, the quality control requirements of part 106, and the labeling requirements of subpart B of this part.

(iii) The compliance date for the withdrawal of a product's exempt status or the imposition of additional or modified quality control, nutrient, or labeling requirements is 60 calendar days after issuance of the final decision except as otherwise provided for reasons stated in the decision. If the agency determines that a health hazard

may exist and so notifies the manufacturer, withdrawal of a product's exempt status shall be effective on the date of receipt of notification from the Director of the Center for Food Safety and Applied Nutrition. Additional or modified requirements, or the withdrawal of an exemption, apply only to those formulas that are manufactured after the compliance date. A postponement of the compliance date may be granted for good cause.

(3) FDA may decide that withdrawal of an exemption is necessary when, on the basis of its review under paragraph (d)(1) of this section, it concludes that quality control procedures are not adequate to ensure that the formula contains all required nutrients, that deviations in nutrient levels are not supported by generally accepted scientific, nutritional, or medical rationale, or that deviations from subpart B of this part are not necessary to provide appropriate directions for preparation and use of the infant formula, or that additional labeling information is necessary.

(4) FDA will use the following criteria in determining whether deviations from the requirements of this subpart are necessary and will adequately protect the public health:

(i) A deviation from the nutrient requirements of section 412(g) of the act or of regulations promulgated under section 412(a)(2) of the act is necessary to provide an infant formula that is appropriate for the dietary management of a specific disease, disorder, or medical condition;

(ii) For exempt infant formulas subject to paragraph (b) of this section, a deviation from the quality control procedures requirements of part 106 is necessary because of unusual or difficult technological problems in manufacturing the infant formula; and

(iii) A deviation from the labeling requirements of subpart B of this part is necessary because label information, including pictograms and symbols required by those regulations, could lead to inappropriate use of the product.

(e) *Notification requirements.* (1) Information required by paragraphs (b) and (c) of this section shall be submitted to Center for Food Safety and Applied Nutrition (HFS-830), Food and Drug Ad-

ministration, 5100 Paint Branch Pkwy., College Park, MD 20740.

(2) The manufacturer shall promptly notify FDA when the manufacturer has knowledge (as defined in section 412(c)(2) of the act) that reasonably supports the conclusion that an exempt infant formula that has been processed by the manufacturer and that has left an establishment subject to the control of the manufacturer may not provide the nutrients required by paragraph (b) or (c) of this section, or when there is an exempt infant formula that may be otherwise adulterated or misbranded and if so adulterated or misbranded presents a risk of human health. This notification shall be made, by telephone, to the Director of the appropriate FDA district office specified in part 5, subpart M of this chapter. After normal business hours (8 a.m. to 4:30 p.m.), the FDA emergency number, 301-443-1240, shall be used. The manufacturer shall send a followup written confirmation to the Center for Food Safety and Applied Nutrition (HFS-605), Food and Drug Administration, 5100 Paint Branch Pkwy., College Park, MD 20740, and to the appropriate FDA district office specified in part 5, subpart M of this chapter.

[50 FR 48187, Nov. 22, 1985, as amended at 61 FR 14479, Apr. 2, 1996; 66 FR 17358, Mar. 30, 2001; 66 FR 56035, Nov. 6, 2001; 67 FR 9585, Mar. 4, 2002; 69 FR 17291, Apr. 2, 2004]

Subpart D—Nutrient Requirements

§ 107.100 Nutrient specifications.

(a) An infant formula shall contain the following nutrients at a level not less than the minimum level specified and not more than the maximum level specified for each 100 kilocalories of the infant formula in the form prepared for consumption as directed on the container:

Nutrients	Unit of measurement	Minimum level	Maximum level
Protein	Grams	1.8	4.5
	do	3.3	6.0
Fat	Percent calories	30	54
	Milligrams	300
Linoleic acid	Percent calories	2.7
Vitamins			
Vitamin A	International Units	250	750

Food and Drug Administration, HHS

§ 107.210

Nutrients	Unit of measurement	Minimum level	Maximum level
Vitamin D	do	40	100
Vitamin E	do	0.7
Vitamin K	Micrograms	4
Thiamine (vitamin B ₁)	do	40
Riboflavin (vitamin B ₂)	do	60
Vitamin B ₆	do	35
Vitamin B ₁₂	do	0.15
Niacin ¹	do	250
Folic acid (folacin)	do	4
Pantothenic acid	do	300
Biotin ²	do	1.5
Vitamin C (ascorbic acid)	Milligrams	8
Choline ²	do	7
Inositol ²	do	4
Minerals			
Calcium	do	60
Phosphorus	do	30
Magnesium	do	6
Iron	do	0.15	3.0
Zinc	do	0.5
Manganese	Micrograms	5
Copper	Micrograms	60
Iodine	do	5	75
Sodium	Milligrams	20	60
Potassium	do	80	200
Chloride	do	55	150

¹The generic term "niacin" includes niacin (nicotinic acid) and niacinamide (nicotinamide).
²Required only for non-milk-based infant formulas.

In addition to the specifications established in the table in this paragraph for vitamins and minerals, the following also apply:

- (b) Vitamin E shall be present at a level of at least 0.7 International Unit of vitamin E per gram of linoleic acid.
- (c) Any vitamin K added shall be in the form of phyloquinone.
- (d) Vitamin B₆ shall be present at a level of at least 15 micrograms of vitamin B₆ for each gram of protein in excess of 1.8 grams of protein per 100 kilocalories of infant formula in the form prepared for consumption as directed on the container.
- (e) The ratio of calcium to phosphorus in infant formula in the form prepared for consumption as directed on the container shall be no less than 1.1 and not more than 2.0.
- (f) Protein shall be present in an amount not to exceed 4.5 grams per 100 kilocalories regardless of quality, and not less than 1.8 grams per 100 kilocalories of infant formula in the form prepared for consumption as directed on the container when its biological quality is equivalent to or better than that of casein. If the biological quality of the protein is less than

that of casein, the minimum amount of protein shall be increased proportionately to compensate for its lower biological quality. For example, an infant formula containing protein with a biological quality of 75 percent of casein shall contain at least 2.4 grams of protein (1.8/0.75). No protein with a biological quality less than 70 percent of casein shall be used.

[50 FR 45108, Oct. 30, 1985]

Subpart E—Infant Formula Recalls

SOURCE: 54 FR 4008, Jan. 27, 1989, unless otherwise noted.

§ 107.200 Food and Drug Administration-required recall.

When the Food and Drug Administration determines that an adulterated or misbranded infant formula presents a risk to human health, a manufacturer shall immediately take all actions necessary to recall that formula, extending to and including the retail level, consistent with the requirements of this subpart.

§ 107.210 Firm-initiated product removals.

- (a) If a manufacturer has determined to recall voluntarily from the market an infant formula that is not subject to § 107.200 but that otherwise violates the laws and regulations administered by the Food and Drug Administration (FDA) and that would be subject to legal action, the manufacturer, upon prompt notification to FDA, shall administer such voluntary recall consistent with the requirements of this subpart.
- (b) If a manufacturer has determined to withdraw voluntarily from the market an infant formula that is adulterated or misbranded in only a minor way and that would not be subject to legal action, such removal from the market is deemed to be a market withdrawal, as defined in § 7.3(j) of this chapter. As required by § 107.240(a), the manufacturer shall promptly notify FDA of such violative formula and may, but is not required to, conduct such market withdrawal consistent with the requirements of this subpart pertaining to product recalls.

§ 107.220 Scope and effect of infant formula recalls.

(a) The requirements of this subpart apply:

(1) When the Food and Drug Administration has determined that it is necessary to remove from the market a distributed infant formula that is in violation of the laws and regulations administered by the Food and Drug Administration and that poses a risk to human health; or

(2) When a manufacturer has determined that it is necessary to remove from the market a distributed infant formula that:

(i) Is no longer subject to the manufacturer's control;

(ii) Is in violation of the laws and regulations administered by the Food and Drug Administration and against which the agency could initiate legal or regulatory action; and

(iii) Does not present a human risk.

(b) The Food and Drug Administration will monitor continually the recall action and will take appropriate actions to ensure that the violative infant formula is removed from the market.

§ 107.230 Elements of an infant formula recall.

A recalling firm shall conduct an infant formula recall with the following elements:

(a) The recalling firm shall evaluate in writing the hazard to human health associated with the use of the infant formula. This health hazard evaluation shall include consideration of any disease, injury, or other adverse physiological effect that has been or that could be caused by the infant formula and of the seriousness, likelihood, and consequences of the diseases, injury, or other adverse physiological effect. The Food and Drug Administration will conduct its own health hazard evaluation and promptly notify the recalling firm of the results of that evaluation if the criteria for recall under § 107.200 have been met.

(b) The recalling firm shall devise a written recall strategy suited to the individual circumstances of the particular recall. The recall strategy shall take into account the health hazard evaluation and specify the following:

The extent of the recall; if necessary, the public warning to be given about any hazard presented by the infant formula; the disposition of the recalled infant formula; and the effectiveness checks that will be made to determine that the recall is carried out.

(c) The recalling firm shall promptly notify each of its affected direct accounts about the recall. The format of a recall communication shall be distinctive, and the content and extent of a recall communication shall be commensurate with the hazard of the infant formula being recalled and the strategy developed for the recall. The recall communication shall instruct consignees to report back quickly to the recalling firm about whether they are in possession of the recalled infant formula and shall include a means of doing so. The recalled communication shall also advise consignees how to return the recall infant formula to the manufacturer or otherwise dispose of it. The recalling firm shall send a followup recall communication to any consignee that does not respond to the initial recall communication.

(d) If the infant formula presents a risk to human health, the recalling firm shall request that each establishment, at which such infant formula is sold or available for sale, post at the point of purchase of such formula a notice of such recall at such establishment. The notice shall be provided by the recalling firm after approval of the notice by the Food and Drug Administration. The recalling firm shall also request that each retail establishment maintain such notice on display until such time as the Food and Drug Administration notifies the recalling firm that the agency considers the recall completed.

(e) The recalling firm shall furnish promptly to the appropriate Food and Drug Administration district office listed in part 5, subpart M of this chapter, as they are available, copies of the health hazard evaluation, the recall strategy, and all recall communications (including, for a recall under § 107.200, the notice to be displayed at

retail establishments) directed to consignees, distributors, retailers, and members of the public.

[54 FR 4008, Jan. 27, 1989, as amended at 66 FR 17358, Mar. 30, 2001; 69 FR 17291, Apr. 2, 2004]

§ 107.240 Notification requirements.

(a) *Notification of a violative infant formula.* A manufacturer shall promptly notify the Food and Drug Administration when the manufacturer has knowledge (as defined in section 412(e)(2) of the Federal Food, Drug, and Cosmetic Act (the act)) that reasonably supports the conclusion that an infant formula that has been processed by the manufacturer and that has left an establishment subject to the control of the manufacturer:

(1) May not provide the nutrients required by section 412(i) of the act and by regulations promulgated under section 412(i)(2) of the act; or

(2) May be otherwise adulterated or misbranded.

(b) *Method of notification.* The notification made pursuant to §107.240(a) shall be made, by telephone, to the Director of the appropriate Food and Drug Administration district office listed in part 5, subpart M of this chapter. After normal business hours (8 a.m. to 4:30 p.m.), FDA's emergency number, 301-443-1240, shall be used. The manufacturer shall send written confirmation of the notification to the Center for Food Safety and Applied Nutrition (HFS-605), Food and Drug Administration, 5100 Paint Branch Pkwy., College Park, MD 20740, and to the appropriate Food and Drug Administration district office listed in part 5, subpart M of this chapter.

(c) *Reports about an infant formula recall*—(1) *Telephone report.* When a determination is made that an infant formula is to be recalled, the recalling firm shall telephone within 24 hours the appropriate Food and Drug Administration district office listed in part 5, subpart M of this chapter and shall provide relevant information about the infant formula that is to be recalled.

(2) *Initial written report.* Within 14 days after the recall has begun, the recalling firm shall provide a written report to the appropriate Food and Drug Administration district office. The re-

port shall contain relevant information, including the following cumulative information concerning the infant formula that is being recalled:

(i) Number of consignees notified of the recall, and date and method of notification, including, for a recall pursuant to §107.200 information about the notice provided for retail display and the request for its display.

(ii) Number of consignees responding to the recall communication and quantity of recalled infant formula on hand at the time it was received.

(iii) Quantity of recalled infant formula returned or corrected by each consignee contacted and the quantity of recalled infant formula accounted for.

(iv) Number and results of effectiveness checks that were made.

(v) Estimated timeframes for completion of the recall.

(3) *Status reports.* The recalling firm shall submit to the appropriate Food and Drug Administration district office a written status report on the recall at least every 14 days until the recall is terminated. The status report shall describe the steps taken by the recalling firm to carry out the recall since the last report and the results of these steps.

[54 FR 4008, Jan. 27, 1989, as amended at 61 FR 14479, Apr. 2, 1996; 66 FR 17359, Mar. 30, 2001; 66 FR 56035, Nov. 6, 2001; 69 FR 17291, Apr. 2, 2004]

§ 107.250 Termination of an infant formula recall.

The recalling firm may submit a recommendation for termination of the recall to the appropriate Food and Drug Administration district office listed in part 5, subpart M of this chapter for transmittal to the Center for Food Safety and Applied Nutrition (HFS-605), for action. Any such recommendation shall contain information supporting a conclusion that the recall strategy has been effective. The agency will respond within 15 days of receipt by the Center for Food Safety and Applied Nutrition (HFS-605), of the request for termination. The recalling firm shall continue to implement the recall strategy until it receives final written notification from the agency that the recall has been terminated.

§ 107.260

The agency will send such a notification unless it has information, from FDA's own audits or from other sources, demonstrating that the recall has not been effective. The agency may conclude that a recall has not been effective if:

(a) The recalling firm's distributors have failed to retrieve the recalled infant formula; or

(b) Stocks of the recalled infant formula remain in distribution channels that are not in direct control of the recalling firm.

[54 FR 4008, Jan. 27, 1989, as amended at 61 FR 14479, Apr. 2, 1996; 66 FR 17359, Mar. 30, 2001; 69 FR 17291, Apr. 2, 2004]

§ 107.260 Revision of an infant formula recall.

If after a review of the recalling firm's recall strategy or periodic reports or other monitoring of the recall, the Food and Drug Administration concludes that the actions of the recalling firm are deficient, the agency shall notify the recalling firm of any serious deficiency. The agency may require the firm to:

(a) Change the extent of the recall, if the agency concludes on the basis of available data that the depth of the recall is not adequate in light of the risk to human health presented by the infant formula.

(b) Carry out additional effectiveness checks, if the agency's audits, or other information, demonstrate that the recall has not been effective.

(c) Issue additional notifications to the firm's direct accounts, if the agency's audits, or other information demonstrate that the original notifications were not received, or were disregarded in a significant number of cases.

§ 107.270 Compliance with this subpart.

A recalling firm may satisfy the requirements of this subpart by any means reasonable calculated to meet the obligations set forth in this Subpart E. The recall guidance in subpart C of part 7 of this chapter specify procedures that may be useful to a recalling firm in determining how to comply with these regulations.

[54 FR 4008, Jan. 27, 1989, as amended at 65 FR 56479, Sept. 19, 2000]

21 CFR Ch. I (4-1-07 Edition)

§ 107.280 Records retention.

Each manufacturer of an infant formula shall make and retain such records respecting the distribution of the infant formula through any establishment owned or operated by such manufacturer as may be necessary to effect and monitor recalls of the formula. Such records shall be retained for at least 1 year after the expiration of the shelf life of the infant formula.

[54 FR 4008, Jan. 27, 1989, as amended at 67 FR 9585, Mar. 4, 2002]

PART 108—EMERGENCY PERMIT CONTROL

Subpart A—General Provisions

Sec.

108.3 Definitions.

108.5 Determination of the need for a permit.

108.6 Revocation of determination of need for permit.

108.7 Issuance or denial of permit.

108.10 Suspension and reinstatement of permit.

108.12 Manufacturing, processing, or packing without a permit, or in violation of a permit.

108.19 Establishment of requirements for exemption from section 404 of the act.

Subpart B—Specific Requirements and Conditions for Exemption From or Compliance With an Emergency Permit

108.25 Acidified foods.

108.35 Thermal processing of low-acid foods packaged in hermetically sealed containers.

AUTHORITY: 21 U.S.C. 342, 344, 371.

SOURCE: 42 FR 14334, Mar. 15, 1977, unless otherwise noted.

Subpart A—General Provisions

§ 108.3 Definitions.

(a) The definitions contained in section 201 of the Federal Food, Drug, and Cosmetic Act are applicable to such terms when used in this part.

(b) *Commissioner* means the Commissioner of Food and Drugs.

(c) *Act* means the Federal Food, Drug, and Cosmetic Act, as amended.

(d) *Permit* means an emergency permit issued by the Commissioner pursuant to section 404 of the act for such

Food and Drug Administration, HHS

§ 108.7

temporary period of time as may be necessary to protect the public health.

(e) *Manufacture, processing, or packing of food in any locality* means activities conducted in a single plant or establishment, a series of plants under a single management, or all plants in an industry or region, by a manufacturer, processor, or packer.

§ 108.5 Determination of the need for a permit.

(a) Whenever the Commissioner determines after investigation that a manufacturer, processor, or packer of a food for which a regulation has been promulgated in subpart B of this part does not meet the mandatory conditions and requirements established in such regulation, he shall issue to such manufacturer, processor, or packer an order determining that a permit shall be required before the food may be introduced or delivered for introduction into interstate commerce by that person. The order shall specify the mandatory conditions and requirements with which there is a lack of compliance.

(1) The manufacturer, processor, or packer shall have 3 working days after receipt of such order within which to file objections. Such objections may be filed by telegram, telex, or any other mode of written communication addressed to the Center for Food Safety and Applied Nutrition, Food and Drug Administration (HFS-605), 5100 Paint Branch Pkwy., College Park, MD 20740. If such objections are filed, the determination is stayed pending a hearing to be held within 5 working days after the filing of objections on the issues involved unless the Commissioner determines that the objections raise no genuine and substantial issue of fact to justify a hearing.

(2) If the Commissioner finds that there is an imminent hazard to health, the order shall contain this finding and the reasons therefor, and shall state that the determination of the need for a permit is effective immediately pending an expedited hearing.

(b) A hearing under this section shall be conducted by the Commissioner or his designee at a location agreed upon by the objector and the Commissioner or, if such agreement cannot be reached, at a location designated by

the Commissioner. The manufacturer, processor, or packer shall have the right to cross-examine the Food and Drug Administration's witnesses and to present witnesses on his own behalf.

(c) Within 5 working days after the hearing, and based on the evidence presented at the hearing, the Commissioner shall determine whether a permit is required and shall so inform the manufacturer, processor, or packer in writing, with the reasons for his decision.

(d) The Commissioner's determination of the need for a permit constitutes final agency action from which appeal lies to the courts. The Commissioner will not stay a determination of the need for a permit pending court appeal except in unusual circumstances, but will participate in expediting any such appeal.

[42 FR 14334, Mar. 15, 1977, as amended at 54 FR 24891, June 12, 1989; 61 FR 14479, Apr. 2, 1996; 66 FR 56035, Nov. 6, 2001]

§ 108.6 Revocation of determination of need for permit.

(a) A permit shall be required only during such temporary period as is necessary to protect the public health.

(b) Whenever the Commissioner has reason to believe that a permit holder is in compliance with the mandatory requirements and conditions established in subpart B of this part and is likely to remain in compliance, he shall, on his own initiative or on the application of the permit holder, revoke both the determination of need for a permit and the permit that had been issued. If denied, the applicant shall, upon request, be afforded a hearing conducted in accordance with § 108.5 (b) and (c) as soon as practicable. Such revocation is without prejudice to the initiation of further permit proceedings with respect to the same manufacturer, processor, or packer should later information again show the need for a permit.

§ 108.7 Issuance or denial of permit.

(a) After a determination and notification by the Commissioner in accordance with the provisions of § 108.5 that a manufacturer, processor, or packer requires a permit, such manufacturer,

§ 108.10

processor, or packer may not thereafter introduce or deliver for introduction into interstate commerce any such food manufactured, processed, or packed by him unless he holds a permit issued by the Commissioner or obtains advance written approval of the Food and Drug Administration pursuant to § 108.12(a).

(b) Any manufacturer, processor, or packer for whom the Commissioner has made a determination that a permit is necessary may apply to the Commissioner for the issuance of such a permit. The application shall contain such data and information as is necessary to show that all mandatory requirements and conditions for the manufacturer, processing or packing of a food for which regulations are established in subpart B of this part are met and, in particular, shall show that the deviations specified in the Commissioner's determination of the need for a permit have been corrected or suitable interim measures established. Within 10 working days after receipt of such application, (except that the Commissioner may extend such time an additional 10 working days where necessary), the Commissioner shall issue a permit, deny the permit, or offer the applicant a hearing conducted in accordance with § 108.5 (b) and (c) as to whether the permit should be issued. The Commissioner shall issue such a permit to which shall be attached, in addition to the mandatory requirements and conditions of subpart B of this part, any additional requirements or conditions which may be necessary to protect the public health if he finds that all mandatory requirements and conditions of subpart B of this part are met or suitable interim measures are established.

(c) Denial of a permit constitutes final agency action from which appeal lies to the courts. The Commissioner will not stay such denial pending court appeal except in unusual circumstances, but will participate in expediting any such appeal.

§ 108.10 Suspension and reinstatement of permit.

(a) Whenever the Commissioner finds that a permit holder is not in compliance with the mandatory requirements and conditions established by the per-

21 CFR Ch. I (4-1-07 Edition)

mit, he shall immediately suspend the permit and so inform the permit holder, with the reasons for the suspension.

(b) Upon application for reinstatement of a permit, the Commissioner shall, within 10 working days, reinstate the permit if he finds that the person is in compliance with the mandatory requirements and conditions established by the permit or deny the application.

(c) Any person whose permit has been suspended or whose application for reinstatement has been denied may request a hearing. The hearing shall be conducted by the Commissioner or his designee within 5 working days of receipt of the request at a location agreed upon by the objector and the Commissioner or, if an agreement cannot be reached, at a location designated by the Commissioner. The permit holder shall have the right to present witnesses on his own behalf and to cross-examine the Food and Drug Administration's witnesses.

(d) Within 5 working days after the hearing, and based on the evidence presented at the hearing, the Commissioner shall determine whether the permit shall be reinstated and shall so inform the permit holder, with the reasons for his decision.

(e) Denial of an application for reinstatement of a permit constitutes final agency action from which appeal lies to the courts. The Commissioner will not stay such denial pending court appeal except in unusual circumstances, but will participate in expediting any such appeal.

§ 108.12 Manufacturing, processing, or packing without a permit, or in violation of a permit.

(a) A manufacturer, processor, or packer may continue at his own risk to manufacture, process, or pack without a permit a food for which the Commissioner has determined that a permit is required. All food so manufactured, processed, or packed during such period without a permit shall be retained by the manufacturer, processor, or packer and may not be introduced or delivered for introduction into interstate commerce without the advance written approval of the Food and Drug Administration. Such approval may be granted only upon an adequate showing that

such food is free from microorganisms of public health significance. The manufacturer, processor, or packer may provide to the Commissioner, for his consideration in making any such determination, an evaluation of the potential public health significance of such food by a competent authority in accordance with procedures recognized as being adequate to detect any potential hazard to public health. Within 20 working days after receipt of a written request for such written approval the Food and Drug Administration shall either issue such written approval or deny the request. If the request is denied, the applicant shall, upon request, be afforded a prompt hearing conducted in accordance with §108.5 (b) and (c).

(b) Except as provided in paragraph (a) of this section, no manufacturer, processor, or packer may introduce or deliver for introduction into interstate commerce without a permit or in violation of a permit a food for which the Commissioner has determined that a permit is required. Where a manufacturer, processor, or packer utilizes a consolidation warehouse or other storage facility under his control, interstate shipment of any such food from the point of production to that warehouse or storage facility shall not violate this paragraph, provided that no further introduction or delivery for introduction into interstate commerce is made from that consolidated warehouse or storage facility except as provided in paragraph (a) of this section.

§108.19 Establishment of requirements for exemption from section 404 of the act.

(a) Whenever the Commissioner finds after investigation that the distribution in interstate commerce of any class of food may, by reason of contamination with microorganisms during the manufacture, processing, or packing thereof in any locality, be injurious to health, and that such injurious nature cannot be adequately determined after such articles have entered interstate commerce, he shall promulgate regulations in Subpart B of this part establishing requirements and conditions governing the manufacture, processing, or packing of the food nec-

essary to protect the public health. Such regulations may be proposed by the Commissioner on his own initiative or in response to a petition from any interested person pursuant to part 10 of this chapter.

(b) A manufacturer, processor, or packer of a food for which a regulation has been promulgated in subpart B of this part shall be exempt from the requirement for a permit only if he meets all of the mandatory requirements and conditions established in that regulation.

[42 FR 14334, Mar. 15, 1977, as amended at 42 FR 15673, Mar. 22, 1977]

Subpart B—Specific Requirements and Conditions for Exemption From or Compliance With an Emergency Permit

§ 108.25 Acidified foods.

(a) Inadequate or improper manufacture, processing, or packing of acidified foods may result in the distribution in interstate commerce of processed foods that may be injurious to health. The harmful nature of such foods cannot be adequately determined after these foods have entered into interstate commerce. The Commissioner of Food and Drugs therefore finds that, to protect the public health, it may be necessary to require any commercial processor, in any establishment engaged in the manufacture, processing, or packing of acidified foods, to obtain and hold a temporary emergency permit provided for under section 404 of the Federal Food, Drug, and Cosmetic Act. Such a permit may be required whenever the Commissioner finds, after investigation, that the commercial processor has failed to fulfill all the requirements of this section, including registration and filing of process information, and the mandatory portions of §§114.10, 114.80(a) (1) and (2), and (b), 114.83, 114.89, and 114.100 (b), (c), and (d) of this chapter as they relate to acidified foods. These requirements are intended to ensure safe manufacturing, processing, and packing processes and to permit the Food and Drug Administration to verify that these processes are being followed. Failure to meet these requirements shall constitute a

prima facie basis for the immediate application of the emergency permit control provisions of section 404 of the act to that establishment, under the procedures established in subpart A of this part.

(b) The definitions in §114.3 of this chapter are applicable when those terms are used in this section.

(c)(1) *Registration.* A commercial processor, when first engaging in the manufacture, processing, or packing of acidified foods in any State, as defined in section 201(a)(1) of the act, shall, not later than 10 days after first so engaging, register and file with the Food and Drug Administration on Form FDA 2541 (food canning establishment registration) information including, but not limited to, the name of the establishment, principal place of business, the location of each establishment in which that processing is carried on, the processing method in terms of acidity and pH control, and a list of foods so processed in each establishment. These forms are available from the LACF Registration Coordinator (HFS-618), Center for Food Safety and Applied Nutrition, Food and Drug Administration, 5100 Paint Branch Pkwy., College Park, MD 20740, or at any Food and Drug Administration district office. The completed form shall be submitted to the Center for Food Safety and Applied Nutrition (HFS-565), Food and Drug Administration, 5100 Paint Branch Pkwy., College Park, MD 20740. Commercial processors presently so engaged shall register within 120 days after the effective date of this regulation. Foreign processors shall register within 120 days after the effective date of this regulation or before any offering of foods for import into the United States, whichever is later. Commercial processors duly registered under this section shall notify the Food and Drug Administration not later than 90 days after the commercial processor ceases or discontinues the manufacture, processing, or packing of the foods in any establishment, except that this notification shall not be required for temporary cessations due to the seasonal character of an establishment's production or by temporary conditions including, but not limited to, labor disputes, fire, or acts of God.

(2) *Process filing.* A commercial processor engaged in the processing of acidified foods shall, not later than 60 days after registration, and before packing any new product, provide the Food and Drug Administration information on the scheduled processes including, as necessary, conditions for heat processing and control of pH, salt, sugar, and preservative levels and source and date of the establishment of the process, for each acidified food in each container size. Filing of this information does not constitute approval of the information by the Food and Drug Administration, and information concerning processes and other data so filed shall be regarded as trade secrets within the meaning of 21 U.S.C. 331(j) and 18 U.S.C. 1905. This information shall be submitted on form FDA 2541a (food canning establishment process filing form for all methods except aseptic). Forms are available from the LACF Registration Coordinator (HFS-618), Center for Food Safety and Applied Nutrition, Food and Drug Administration, 5100 Paint Branch Pkwy., College Park, MD 20740, or at Food and Drug Administration district office. The completed form shall be submitted to the LACF Registration Coordinator (HFS-618), Center for Food Safety and Applied Nutrition, Food and Drug Administration, 5100 Paint Branch Pkwy., College Park, MD 20740.

(3) *Process adherence and information—*
(i) *Scheduling.* A commercial processor engaged in processing acidified foods in any registered establishment shall process each food in conformity with at least the scheduled processes filed under paragraph (c)(2) of this section.

(ii) *Process and pH information availability.* When requested by the Food and Drug Administration in writing, a commercial processor engaged in the processing of acidified foods shall provide the Food and Drug Administration with any process and procedure information that the Food and Drug Administration deems necessary to determine the adequacy of the process. Furnishing of this information does not constitute approval by the Food and Drug Administration of the content of the information filed, and the information concerning processes and other data so furnished shall be considered

trade secrets within the meaning of 21 U.S.C. 331(j) and 18 U.S.C. 1905 (to the extent that they qualify under those provisions).

(d) A commercial processor engaged in the processing of acidified foods shall promptly report to the Food and Drug Administration any instance of spoilage, process deviation, or contamination with microorganisms, the nature of which has potential health-endangering significance, where any lot of such food has in whole or in part entered distribution in commerce.

(e) A commercial processor engaged in the processing of acidified foods shall prepare and maintain files on a current procedure for use for products under the processor's control, which that processor will ask the distributor to follow, including plans for recalling products that may be injurious to health; for identifying, collecting, warehousing, and controlling products; for determining the effectiveness of recalls; for notifying the Food and Drug Administration of any recalls; and for implementing recall programs.

(f) All plant personnel involved in acidification, pH control, heat treatment, or other critical factors of the operation shall be under the operating supervision of a person who has attended a school approved by the Commissioner for giving instruction in food-handling techniques, food protection principles, personal hygiene, plant sanitation practices, pH controls, and critical factors in acidification, and who has satisfactorily completed the prescribed course of instruction. The Commissioner will consider students who have satisfactorily completed the required portions of the courses presented under §108.35 and part 113 of this chapter before March 16, 1979, as having satisfactorily completed the prescribed course of instruction under this section and part 114 of this chapter. The Commissioner will not withhold approval of any school qualified to give such instruction.

(g) A commercial processor engaged in the processing of acidified foods shall prepare, review, and retain at the processing plant or other reasonably accessible location for a period of 3 years from the date of manufacture, all records of processing, deviations in

processing, pH, and other records specified in part 114 of this chapter. Upon written demand during the course of a factory inspection under section 704 of the act by a duly authorized employee of the Food and Drug Administration, a commercial processor shall permit the inspection and copying by that employee of these records to verify the pH and the adequacy of processing.

(h) This section shall not apply to the commercial processing of any food processed under the continuous inspection of the meat and poultry inspection program of the Food Safety and Inspection Service of the Department of Agriculture under the Federal Meat Inspection Act (34 Stat. 1256, as amended by 81 Stat. 584 (21 U.S.C. 601 *et seq.*)) and the Poultry Products Inspection Act (71 Stat. 441, as amended by 82 Stat. 791 (21 U.S.C. 451 *et seq.*)).

(i) Wherever the Commissioner finds that any State regulates the commercial processing of acidified foods under effective regulations specifying at least the requirements of part 114 of this chapter, the Commissioner shall issue a notice stating that compliance with such State regulations shall constitute compliance with this section, if the State through its regulatory agency or each processor of acidified foods in the State files with the Food and Drug Administration the registration information and the processing information prescribed in paragraph (c) of this section.

(j) *Imports:* (1) This section applies to any foreign commercial processor engaged in the processing of acidified foods and offering those foods for import into the United States except that, in lieu of providing for the issuance of an emergency permit under paragraph (a) of this section, the Commissioner will request the Secretary of the Treasury to refuse admission into the United States, under section 801 of the act, to any acidified foods which the Commissioner determines, after investigation, may result in the distribution in interstate commerce of processed foods that may be injurious to health as set forth in paragraph (a) of this section.

(2) Any acidified food so refused admission shall not be admitted until the Commissioner determines that the

commercial processor offering the food for import has complied with the requirements of this section and that the food is not injurious to health. To assist the Commissioner in making this determination, a duly authorized employee of the Food and Drug Administration shall be permitted to inspect the commercial processor's manufacturing, processing, and packing facilities.

(k) The following information submitted to the Food and Drug Administration under this section is not available for public disclosure unless it has been previously disclosed to the public as defined in §20.81 of this chapter or it relates to a product or ingredient that has been abandoned and no longer represents a trade secret or confidential commercial or financial information as defined in §20.61 of this chapter:

(1) Manufacturing methods or processes, including quality control information.

(2) Production, sales, distribution, and similar information, except that any compilation of the information aggregated and prepared in a way that does not reveal information which is not available for public disclosure under this provision is available for public disclosure.

(3) Quantitative or semiquantitative formulas.

[44 FR 16207, Mar. 16, 1979, as amended at 54 FR 24891, June 12, 1989; 61 FR 14479, Apr. 2, 1996; 66 FR 56035, Nov. 6, 2001]

§108.35 Thermal processing of low-acid foods packaged in hermetically sealed containers.

(a) Inadequate or improper manufacture, processing, or packing of thermally processed low-acid foods in hermetically sealed containers may result in the distribution in interstate commerce of processed foods that may be injurious to health. The harmful nature of such foods cannot be adequately determined after these foods have entered into interstate commerce. The Commissioner of Food and Drugs therefore finds that, in order to protect the public health, it may be necessary to require any commercial processor, in any establishment engaged in the manufacture, processing, or packing of thermally processed low-acid foods in

hermetically sealed containers, to obtain and hold a temporary emergency permit provided for under section 404 of the Federal Food, Drug, and Cosmetic Act. Such a permit may be required whenever the Commissioner finds, after investigation, that the commercial processor has failed to fulfill all the requirements of this section, including registration and the filing of process information, and the mandatory portions of part 113 of this chapter. These requirements are intended to ensure safe manufacture, processing, and packing procedures and to permit the Food and Drug Administration to verify that these procedures are being followed. Such failure shall constitute a prima facie basis for the immediate application of the emergency permit control provisions of section 404 of the act to that establishment, pursuant to the procedures established in subpart A of this part.

(b) The definitions in §113.3 of this chapter are applicable when such terms are used in this section.

(c) *Registration and process filing*—(1) *Registration*. A commercial processor when first engaging in the manufacture, processing, or packing of thermally processed low-acid foods in hermetically sealed containers in any state, as defined in section 201(a)(1) of the act, shall, not later than 10 days after first so engaging, register with the Food and Drug Administration on Form FDA 2541 (food canning establishment registration) information including (but not limited to) his name, principal place of business, the location of each establishment in which such processing is carried on, the processing method in terms of the type of processing equipment employed, and a list of the low-acid foods so processed in each such establishment. These forms are available from the LACF Registration Coordinator (HFS-618), Center for Food Safety and Applied Nutrition, Food and Drug Administration, 5100 Paint Branch Pkwy., College Park, MD 20740, or at any Food and Drug Administration district office. The completed form shall be submitted to the LACF Registration Coordinator (HFS-618), Center for Food Safety and Applied Nutrition, Food and Drug Administration, 5100 Paint Branch Pkwy., College Park,

Food and Drug Administration, HHS

§ 108.35

MD 20740. Commercial processors presently so engaged shall register not later than July 13, 1973. Commercial processors duly registered in accordance with this section shall notify the Food and Drug Administration not later than 90 days after such commercial processor ceases or discontinues the manufacture, processing, or packing of thermally processed foods in any establishment: *Provided*, That such notification shall not be required as to the temporary cessation necessitated by the seasonal character of the particular establishment's production or caused by temporary conditions including but not limited to strikes, lockouts, fire, or acts of God.

(2) *Process filing*. A commercial processor engaged in the thermal processing of low-acid foods packaged in hermetically sealed containers shall, not later than 60 days after registration and prior to the packing of a new product, provide the Food and Drug Administration information as to the scheduled processes including but not limited to the processing method, type of retort or other thermal processing equipment employed, minimum initial temperatures, times and temperatures of processing, sterilizing value (F₀), or other equivalent scientific evidence of process adequacy, critical control factors affecting heat penetration, and source and date of the establishment of the process, for each such low-acid food in each container size: *Provided*, That the filing of such information does not constitute approval of the information by the Food and Drug Administration, and that information concerning processes and other data so filed shall be regarded as trade secrets within the meaning of 21 U.S.C. 331(j) and 18 U.S.C. 1905. This information shall be submitted on the following forms as appropriate: Form FDA 2541a (food canning establishment process filing for all methods except aseptic), or Form FDA 2541c (food canning establishment process filing for aseptic systems). These forms are available from the LACF Registration Coordinator (HFS-618), Center for Food Safety and Applied Nutrition, Food and Drug Administration, 5100 Paint Branch Pkwy., College Park, MD 20740, or at any Food and Drug Administration district of-

vice. The completed form(s) shall be submitted to the LACF Registration Coordinator (HFS-618), Center for Food Safety and Applied Nutrition, Food and Drug Administration, 5100 Paint Branch Pkwy., College Park, MD 20740.

(i) If all the necessary information is not available for existing products, the processor shall, at the time the existing information is provided to the Food and Drug Administration request in writing an extension of time for submission of such information, specifying what additional information is to be supplied and the date by which it is to be submitted. Within 30 working days after receipt of such request the Food and Drug Administration shall either grant or deny such request in writing.

(ii) If a packer intentionally makes a change in a previously filed scheduled process by reducing the initial temperature or retort temperature, reducing the time of processing, or changing the product formulation, the container, or any other condition basic to the adequacy of scheduled process, he shall prior to using such changed process obtain substantiation by qualified scientific authority as to its adequacy. Such substantiation may be obtained by telephone, telegram, or other media, but must be promptly recorded, verified in writing by the authority, and contained in the packer's files for review by the Food and Drug Administration. Within 30 days after first use, the packer shall submit to the Center for Food Safety and Applied Nutrition (HFS-617), Food and Drug Administration, 5100 Paint Branch Pkwy., College Park, MD 20740 a complete description of the modifications made and utilized, together with a copy of his file record showing prior substantiation by a qualified scientific authority as to the safety of the changed process. Any intentional change of a previously filed scheduled process or modification thereof in which the change consists solely of a higher initial temperature, a higher retort temperature, or a longer processing time, shall not be considered a change subject to this paragraph, but if that modification is thereafter to be regularly scheduled, the modified process shall be promptly

filed as a scheduled process, accompanied by full information on the specified forms as provided in this paragraph.

(iii) Many packers employ an "operating" process in which retort operators are instructed to use retort temperatures and/or processing times slightly in excess of those specified in the scheduled process as a safety factor to compensate for minor fluctuations in temperature or time to assure that the minimum times and temperatures in the scheduled process are always met. This would not constitute a modification of the scheduled process.

(3) *Process adherence and information.*

(i) A commercial processor engaged in the thermal processing of low-acid foods packaged in hermetically sealed containers in any registered establishment shall process each low-acid food in each container size in conformity with at least the scheduled processes and modifications filed pursuant to paragraph (c)(2) of this section.

(ii) Process information availability: When requested by the Food and Drug Administration in writing, a commercial processor engaged in thermal processing of low-acid foods packaged in hermetically sealed containers shall provide the Food and Drug Administration with any information concerning processes and procedures which is deemed necessary by the Food and Drug Administration to determine the adequacy of the process: *Provided*, That the furnishing of such information does not constitute approval of the information by the Food and Drug Administration, and that the information concerning processes and other data so furnished shall be regarded as trade secrets within the meaning of 21 U.S.C. 331(j) and 18 U.S.C. 1905.

(d) A commercial processor engaged in the thermal processing of low-acid foods packaged in hermetically sealed containers shall promptly report to the Food and Drug Administration any instance of spoilage or process deviation the nature of which indicates potential health significance where any lot of such food has in whole or in part entered distribution.

(e) A commercial processor engaged in thermal processing of low-acid foods packaged in hermetically sealed con-

tainers shall promptly report to the Food and Drug Administration any instance wherein any lot of such food, which may be injurious to health by reason of contamination with microorganisms, has in whole or in part entered distribution.

(f) A commercial processor engaged in the thermal processing of low-acid foods packaged in hermetically sealed containers shall have prepared and in his files a current procedure which he will use for products under his control and which he will ask his distributor to follow, including plans for effecting recalls of any product that may be injurious to health; for identifying, collecting, warehousing, and controlling the product; for determining the effectiveness of such recall; for notifying the Food and Drug Administration of any such recall; and for implementing such recall program.

(g) All operators of retorts, thermal processing systems, aseptic processing and packaging systems, or other thermal processing systems, and container closure inspectors shall be under the operating supervision of a person who has attended a school approved by the Commissioner for giving instruction in retort operations, aseptic processing and packaging systems operations or other thermal processing systems operations, and container closure inspections, and has satisfactorily completed the prescribed course of instruction: *Provided*, That this requirement shall not apply in the State of California as listed in paragraph (j) of this section. The Commissioner will not withhold approval of any school qualified to give such instruction.

(h) A commercial processor engaged in the thermal processing of low-acid foods packaged in hermetically sealed containers shall prepare, review, and retain at the processing plant for a period of not less than one year, and at the processing plant or other reasonably accessible location for an additional two years, all records of processing, deviations in processing, container closure inspections, and other records specified in part 113 of this chapter. If during the first year of the three-year record retention period the processing plant is closed for a prolonged period between seasonal packs,

the records may be transferred to some other reasonably accessible location at the end of the seasonal pack. Upon written demand during the course of a factory inspection pursuant to section 704 of the act by a duly authorized employee of the Food and Drug Administration, a commercial processor shall permit the inspection and copying by such employee of these records to verify the adequacy of processing, the integrity of container closures, and the coding of the products.

(i) This section shall not apply to the commercial processing of any food processed under the continuous inspection of the meat and poultry inspection program of the Animal and Plant Health Inspection Service of the Department of Agriculture under the Federal Meat Inspection Act (34 Stat. 1256, as amended by 81 Stat. 584 (21 U.S.C. 601 *et seq.*)) and the Poultry Products Inspection Act (71 Stat. 441, as amended by 82 Stat. 791 (21 U.S.C. 451 *et seq.*)).

(j) Compliance with State regulations: (1) Wherever the Commissioner finds that any State regulates the commercial thermal processing of low-acid foods in accordance with effective regulations specifying at least the requirements of part 113 of this chapter, he shall issue a notice stating that compliance with such State regulations shall constitute compliance with part 113 of this chapter. However, the provisions of this section shall remain applicable to the commercial processing of low-acid foods in any such State, except that, either the State through its regulatory agency or each processor of low-acid foods in such State shall file with the Center for Food Safety and Applied Nutrition the registration information and the processing information prescribed in paragraph (c) of this section.

(2) The Commissioner finds that the regulations adopted by the State of California under the laws relating to cannery inspections governing thermal processing of low-acid foods packaged in hermetically sealed containers satisfy the requirements of part 113 of this chapter.

Accordingly, processors, who under the laws relating to cannery inspections are licensed by the State of California and who comply with such state regu-

lations, shall be deemed to comply with the requirements of part 113 of this chapter.

(k) *Imports:* (1) This section shall apply to any foreign commercial processor engaged in the thermal processing of low-acid foods packaged in hermetically sealed containers and offering such foods for import into the United States except that, in lieu of providing for the issuance of an emergency permit under paragraph (a) of this section, the Commissioner will request the Secretary of the Treasury to refuse admission into the United States, pursuant to section 801 of the act, of any such low-acid foods which the Commissioner determines, after investigation, may result in the distribution in interstate commerce of processed foods that may be injurious to health as set forth in paragraph (a) of this section.

(2) Any such food refused admission shall not be admitted until such time as the Commissioner may determine that the commercial processor offering the food for import is in compliance with the requirements and conditions of this section and that such food is not injurious to health. For the purpose of making such determination, the Commissioner reserves the right for a duly authorized employee of the Food and Drug Administration to inspect the commercial processor's manufacturing, processing, and packing facilities.

(1) The following data and information submitted to the Food and Drug Administration pursuant to this section are not available for public disclosure unless they have been previously disclosed to the public as defined in §20.81 of this chapter or they relate to a product or ingredient that has been abandoned and they no longer represent a trade secret or confidential commercial or financial information as defined in §20.81 of this chapter:

(1) Manufacturing methods or processes, including quality control information.

(2) Production, sales, distribution, and similar data and information, except that any compilation of such data and information aggregated and prepared in a way that does not reveal data or information which is not available for public disclosure under this

provision is available for public disclosure.

(3) Quantitative or semiquantitative formulas.

[42 FR 14334, Mar. 15, 1977, as amended at 42 FR 15673, Mar. 22, 1977; 54 FR 24891, June 12, 1989; 61 FR 14480, Apr. 2, 1996; 66 FR 56035, Nov. 6, 2001]

PART 109—UNAVOIDABLE CONTAMINANTS IN FOOD FOR HUMAN CONSUMPTION AND FOOD-PACKAGING MATERIAL

Subpart A—General Provisions

Sec.

109.3 Definitions and interpretations.

109.4 Establishment of tolerances, regulatory limits, and action levels.

109.6 Added poisonous or deleterious substances.

109.7 Unavoidability.

109.15 Use of polychlorinated biphenyls (PCB's) in establishments manufacturing food-packaging materials.

109.16 Ornamental and decorative ceramicware.

Subpart B—Tolerances for Unavoidable Poisonous or Deleterious Substances

109.30 Tolerances for polychlorinated biphenyls (PCB's).

Subpart C—Regulatory Limits for Added Poisonous or Deleterious Substances [Reserved]

Subpart D—Naturally Occurring Poisonous or Deleterious Substances [Reserved]

AUTHORITY: 21 U.S.C. 321, 336, 342, 346, 346a, 348, 371.

SOURCE: 42 FR 52819, Sept. 30, 1977, unless otherwise noted.

Subpart A—General Provisions

§ 109.3 Definitions and interpretations.

(a) *Act* means the Federal Food, Drug, and Cosmetic Act.

(b) The definitions of terms contained in section 201 of the act are applicable to such terms when used in this part unless modified in this section.

(c) A *naturally occurring poisonous or deleterious substance* is a poisonous or deleterious substance that is an inherent natural constituent of a food and is

not the result of environmental, agricultural, industrial, or other contamination.

(d) An *added poisonous or deleterious substance* is a poisonous or deleterious substance that is not a naturally occurring poisonous or deleterious substance. When a naturally occurring poisonous or deleterious substance is increased to abnormal levels through mishandling or other intervening acts, it is an added poisonous or deleterious substance to the extent of such increase.

(e) *Food* includes human food and substances migrating to food from food-contact articles.

§ 109.4 Establishment of tolerances, regulatory limits, and action levels.

(a) When appropriate under the criteria of § 109.6, a tolerance for an added poisonous or deleterious substance, which may be a food additive, may be established by regulation in subpart B of this part under the provisions of section 406 of the act. A tolerance may prohibit any detectable amount of the substance in food.

(b) When appropriate under the criteria of § 109.6, and under section 402(a)(1) of the act, a regulatory limit for an added poisonous or deleterious substance, which may be a food additive, may be established by regulation in subpart C of this part under the provisions of sections 402(a)(1) and 701(a) of the act. A regulatory limit may prohibit any detectable amount of the substance in food. The regulatory limit established represents the level at which food is adulterated within the meaning of section 402(a)(1) of the act.

(c)(1) When appropriate under the criteria of § 109.6, an action level for an added poisonous or deleterious substance, which may be a food additive, may be established to define a level of contamination at which a food may be regarded as adulterated.

(2) Whenever an action level is established or changed, a notice shall be published in the FEDERAL REGISTER as soon as practicable thereafter. The notice shall call attention to the material supporting the action level which shall be on file with the Division of Dockets Management before the notice

is published. The notice shall invite public comment on the action level.

(d) A regulation may be established in subpart D of this part to identify a food containing a naturally occurring poisonous or deleterious substance which will be deemed to be adulterated under section 402(a)(1) of the act. These regulations do not constitute a complete list of such foods.

[42 FR 52819, Sept. 30, 1977, as amended at 55 FR 20785, May 21, 1990]

§ 109.6 Added poisonous or deleterious substances.

(a) Use of an added poisonous or deleterious substance, other than a pesticide chemical, that is also a food additive, will be controlled by a regulation issued under section 409 of the act when possible. When such a use cannot be approved under the criteria of section 409 of the act, or when the added poisonous or deleterious substance is not a food additive, a tolerance, regulatory limit, or action level may be established pursuant to the criteria in paragraphs (b), (c), or (d) of this section. Residues resulting from the use of an added poisonous or deleterious substance that is also a pesticide chemical will ordinarily be controlled by a tolerance established in a regulation issued under sections 406, 408, or 409 of the act by the U.S. Environmental Protection Agency (EPA). When such a regulation has not been issued, an action level for an added poisonous or deleterious substance that is also a pesticide chemical may be established by the Food and Drug Administration. The Food and Drug Administration will request EPA to recommend such an action level pursuant to the criteria established in paragraph (d) of this section.

(b) A tolerance for an added poisonous or deleterious substance in any food may be established when the following criteria are met:

(1) The substance cannot be avoided by good manufacturing practice.

(2) The tolerance established is sufficient for the protection of the public health, taking into account the extent to which the presence of the substance cannot be avoided and the other ways in which the consumer may be affected by the same or related poisonous or deleterious substances.

(3) No technological or other changes are foreseeable in the near future that might affect the appropriateness of the tolerance established. Examples of changes that might affect the appropriateness of the tolerance include anticipated improvements in good manufacturing practice that would change the extent to which use of the substance is unavoidable and anticipated studies expected to provide significant new toxicological or use data.

(c) A regulatory limit for an added poisonous or deleterious substance in any food may be established when each of the following criteria is met:

(1) The substance cannot be avoided by current good manufacturing practices.

(2) There is no tolerance established for the substance in the particular food under sections 406, 408, or 409 of the act.

(3) There is insufficient information by which a tolerance may be established for the substance under section 406 of the act or technological changes appear reasonably possible that may affect the appropriateness of a tolerance. The regulatory limit established represents the level at which food is adulterated within the meaning of section 402(a)(1) of the act.

(d) An action level for an added poisonous or deleterious substance in any food may be established when the criteria in paragraph (b) of this section are met, except that technological or other changes that might affect the appropriateness of the tolerance are foreseeable in the near future. An action level for an added poisonous or deleterious substance in any food may be established at a level at which the Food and Drug Administration may regard the food as adulterated within the meaning of section 402(a)(1) of the act, without regard to the criteria in paragraph (b) of this section or in section 406 of the act. An action level will be withdrawn when a tolerance or regulatory limit for the same substance and use has been established.

(e) Tolerances will be established under authority appropriate for action levels (sections 306, 402(a), and 701(a) of the act, together with section 408 or 409 of the act, if appropriate) as well as under authority appropriate for tolerances (sections 406 and 701 of the act).

§ 109.7

21 CFR Ch. I (4-1-07 Edition)

In the event the effectiveness of a tolerance is stayed pursuant to section 701(e)(2) of the act by the filing of an objection, the order establishing the tolerance shall be deemed to be an order establishing an action level until final action is taken upon such objection.

[42 FR 52819, Sept. 30, 1977, as amended at 55 FR 20785, May 21, 1990]

§ 109.7 Unavoidability.

(a) Tolerances and action levels in this part are established at levels based on the unavoidability of the poisonous or deleterious substance concerned and do not establish a permissible level of contamination where it is avoidable.

(b) Compliance with tolerances, regulatory limits, and action levels does not excuse failure to observe either the requirement in section 402(a)(4) of the act that food may not be prepared, packed, or held under insanitary conditions or the other requirements in this chapter that food manufacturers must observe current good manufacturing practices. Evidence obtained through factory inspection or otherwise indicating such a violation renders the food unlawful, even though the amounts of poisonous or deleterious substances are lower than the currently established tolerances, regulatory limits, or action levels. The manufacturer of food must at all times utilize quality control procedures which will reduce contamination to the lowest level currently feasible.

[42 FR 52819, Sept. 30, 1977, as amended at 55 FR 20785, May 21, 1990]

§ 109.15 Use of polychlorinated biphenyls (PCB's) in establishments manufacturing food-packaging materials.

(a) Polychlorinated biphenyls (PCB's) represent a class of toxic industrial chemicals manufactured and sold under a variety of trade names, including: Aroclor (United States); Phenoclor (France); Colphen (Germany); and Kanaclor (Japan). PCB's are highly stable, heat resistant, and nonflammable chemicals. Industrial uses of PCB's include, or did include in the past, their use as electrical transformer and capacitor fluids, heat transfer fluids, hydraulic fluids, and plasticizers, and in

formulations of lubricants, coatings, and inks. Their unique physical and chemical properties and widespread, uncontrolled industrial applications have caused PCB's to be a persistent and ubiquitous contaminant in the environment, causing the contamination of certain foods. In addition, incidents have occurred in which PCB's have directly contaminated animal feeds as a result of industrial accidents (leakage or spillage of PCB fluids from plant equipment). These accidents in turn caused the contamination of food products intended for human consumption (meat, milk and eggs). Investigations by the Food and Drug Administration have revealed that a significant percentage of paper food-packaging material contains PCB's which can migrate to the packaged food. The origin of PCB's in such material is not fully understood. Reclaimed fibers containing carbonless copy paper (contains 3 to 5 percent PCB's) have been identified as a primary source of PCB's in paper products. Some virgin paper products have also been found to contain PCB's, the source of which is generally attributed to direct contamination from industrial accidents from the use of PCB-containing equipment and machinery in food packaging manufacturing establishments. Since PCB's are toxic chemicals, the PCB contamination of food-packaging materials as a result of industrial accidents, which can cause the PCB contamination of food, represents a hazard to public health. It is therefore necessary to place certain restrictions on the industrial uses of PCB's in establishments manufacturing food-packaging materials.

(b) The following special provisions are necessary to preclude the accidental PCB contamination of food-packaging materials:

(1) New equipment or machinery for manufacturing food-packaging materials shall not contain or use PCB's.

(2) On or before September 4, 1973, the management of establishments manufacturing food-packaging materials shall:

(i) Have the heat exchange fluid used in existing equipment for manufacturing food-packaging materials sampled and tested to determine whether it contains PCB's or verify the absence of

PCB's in such formulations by other appropriate means. On or before Sept. 4, 1973, any such fluid formulated with PCB's must to the fullest extent possible commensurate with current good manufacturing practices be replaced with a heat exchange fluid that does not contain PCB's.

(ii) Eliminate to the fullest extent possible commensurate with current good manufacturing practices from the establishment any other PCB-containing equipment, machinery and materials wherever there is a reasonable expectation that such articles could cause food-packaging materials to become contaminated with PCB's either as a result of normal use or as a result of accident, breakage, or other mishap.

(iii) The toxicity and other characteristics of fluids selected as PCB replacements must be adequately determined so that the least potentially hazardous replacement is used. In making this determination with respect to a given fluid, consideration should be given to (a) its toxicity; (b) the maximum quantity that could be spilled onto a given quantity of food before it would be noticed, taking into account its color and odor; (c) possible signaling devices in the equipment to indicate a loss of fluid, etc.; and (d) its environmental stability and tendency to survive and be concentrated through the food chain. The judgment as to whether a replacement fluid is sufficiently non-hazardous is to be made on an individual installation and operation basis.

(c) The provisions of this section do not apply to electrical transformers and condensers containing PCB's in sealed containers.

§ 109.16 Ornamental and decorative ceramicware.

(a) Lead is a toxic metal that is used as a component of glazes and decorative decals on ceramics, including some ornamental and decorative ceramicware. The use of ornamental or decorative ceramicware to prepare, serve, or hold food may result in the leaching of lead from the glaze or decoration into the food. The provisions of paragraph (b) of this section are necessary to ensure that ornamental or decorative ceramicware bear adequate

indications that they are not to be used for food-handling purposes.

(b) Ornamental or decorative ceramicware initially introduced or initially delivered for introduction into interstate commerce on or after July 13, 1994 appears to be suitable for food use will be considered to be for food use unless:

(1) It bears:

(i) A conspicuous stick-on label on a surface clearly visible to consumers that states in legible script in letters at least 3.2 millimeters (0.125 inch) in height one of the following messages: "Not for Food Use. May Poison Food," "Not for Food Use. Glaze contains lead. Food Use May Result in Lead Poisoning," and "Not for Food Use—Food Consumed from this Vessel May be Harmful," and

(ii) A conspicuous and legible permanent statement of the message selected from paragraph (b)(1)(i) of this section molded or fired onto the exterior surface of the base or, when the ceramicware is not fired after decoration, permanently painted onto the exterior surface of the base. This permanent statement shall be in letters at least 3.2 millimeters (0.125 inch) in height, except that if insufficient space exists for the permanent statement in letters of such height, the statement shall be in the largest letters that will allow it to fit on the base of the piece, provided that the letters are at least 1.6 millimeters (0.062 inch) in height; or

(2) A hole is bored through the potential food-contact surface.

(c) In addition to steps required under paragraphs (b)(1) and (b)(2) of this section, the following optional information may be provided on the ware:

(1) A further explanatory statement concerning the decorative nature of the piece, such as "Decorative" or "For Decorative Purposes Only," may be used; however, such additional statement shall be placed after the required statement.

(2) A symbol may be used to advise that a piece of ornamental or decorative ceramicware is not to be used with food, as illustrated below.

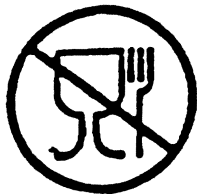

The circle of the above symbol should be at least 2.54 centimeters (1 inch) in diameter. The symbol may be used on the temporary label or applied to the base of the piece in the same manner as the permanent statement.

[59 FR 1641, Jan. 12, 1994]

Subpart B—Tolerances for Unavoidable Poisonous or Deleterious Substances

§ 109.30 Tolerances for polychlorinated biphenyls (PCB's).

(a) Polychlorinated biphenyls (PCB's) are toxic, industrial chemicals. Because of their widespread, uncontrolled industrial applications, PCB's have become a persistent and ubiquitous contaminant in the environment. As a result, certain foods and animal feeds, principally those of animal and marine origin, contain PCB's as unavoidable, environmental contaminants. PCB's are transmitted to the food portion (meat, milk, and eggs) of food-producing animals ingesting PCB-contaminated animal feed. In addition, a significant percentage of paper food-packaging materials contain PCB's which may migrate to the packaged food. The source of PCB's in paper food-packaging materials is primarily of certain types of carbonless copy paper (containing 3 to 5 percent PCB's) in waste paper stocks used for manufacturing recycled paper. Therefore, temporary tolerances for residues of PCB's as unavoidable environmental or industrial contaminants are established for a sufficient period of time following the effective date of this paragraph to permit the elimination of such contaminants at the earliest practicable time. For the purposes of this paragraph, the term "polychlorinated biphenyls (PCB's)" is applicable to mixtures of chlorinated biphenyl compounds, irrespective of which mixture

of PCB's is present as the residue. The temporary tolerances for residues of PCB's are as follows:

- (1) 1.5 parts per million in milk (fat basis).
 - (2) 1.5 parts per million in manufactured dairy products (fat basis).
 - (3) 3 parts per million in poultry (fat basis).
 - (4) 0.3 parts per million in eggs.
 - (5) 0.2 parts per million in finished animal feed for food-producing animals (except the following finished animal feeds: feed concentrates, feed supplements, and feed premixes).
 - (6) 2 parts per million in animal feed components of animal origin, including fishmeal and other by-products of marine origin and in finished animal feed concentrates, supplements, and premixes intended for food producing animals.
 - (7) 2 parts per million in fish and shellfish (edible portion). The edible portion of fish excludes head, scales, viscera, and inedible bones.
 - (8) 0.2 parts per million in infant and junior foods.
 - (9) 10 parts per million in paper food-packaging material intended for or used with human food, finished animal feed and any components intended for animal feeds. The tolerance shall not apply to paper food-packaging material separated from the food therein by a functional barrier which is impermeable to migration of PCB's.
- (b) A compilation entitled "Analytical Methodology for Polychlorinated Biphenyls, June 1979" for determining compliance with the tolerances established in this section is available from the Division of Dockets Management (HFA-305), Food and Drug Administration, 5630 Fishers Lane, rm. 1061, Rockville, MD 20852.
- (c) A barrier is functional for purposes of paragraph (a)(9) of this section if the barrier limits migration of PCB's from the packaging material to food to a level not exceeding the migration which occurs under the same test conditions from packaging material containing 10 parts per million PCB without the use of a barrier. A class of barrier material is functional for purposes of paragraph (a)(9) of this section if a

representative barrier of the class limits migration of PCB's from the packaging material to food to a level not exceeding the migration which occurs under the same test conditions from packaging material containing 10 parts per million PCB without the use of a barrier. Migration levels shall be determined for purpose of this paragraph solely by use of testing conditions described in "Test Procedures for Determination of PCB Permeability of Food Packaging, Inner-Wraps, September 1976, revised May 1983", which is incorporated by reference. Copies are available from the Division of Dockets Management (HFA-305), Food and Drug Administration, 5630 Fishers Lane, rm. 1061, Rockville, MD 20852, or available for inspection at the National Archives and Records Administration (NARA). For information on the availability of this material at NARA, call 202-741-6030, or go to: http://www.archives.gov/federal_register/code_of_federal_regulations/ibr_locations.html. A class of barrier material shall be deemed functional only if the definition of the class and the designation of one or more representative barriers has been approved by the Director, Center for Food Safety and Applied Nutrition, Food and Drug Administration. In the event that the Director, Center for Food Safety and Applied Nutrition, does not approve a proposal made to the Center regarding the definition of a class of barrier material or the designation of representative barriers, the Director shall advise the person making the proposal of the reasons for the Center's disapproval within 90 days of receipt of the proposal. All proposals for definition of classes and determinations of the Food and Drug Administration regarding such proposals shall be on file with the Division of Dockets Management (HFA-305), Food and Drug Administration, 5630 Fishers Lane, rm. 1061, Rockville, MD 20852.

(d) Any person who asserts that a barrier or class of barriers is functional shall submit the results of tests conducted to determine the functionality of the barrier or class of barriers to Center for Food Safety and Applied Nutrition (HFS-308), Food and Drug Administration, 5100 Paint Branch Pkwy.,

College Park, MD 20740. All barriers or classes of barriers shall be tested with the four solid food receptors specified in "Test Procedures for Determination of PCB Permeability of Food Packaging, Inner-Wraps, September 1976, revised May 1983", which is incorporated by reference. The availability of this reference is given in paragraph (c) of this section. The test results as to each barrier shall be accompanied by (1) a description of the barrier's composition adequate to enable identification; and (2) a specific definition of the barrier by relevant technical characteristics. The Center for Food Safety and Applied Nutrition shall review submitted test results promptly. Within 60 days of the receipt of test results, the Director, Center for Food Safety and Applied Nutrition, shall notify the person submitting the test results whether the tests were conducted in accordance with the "Analytical Methodology for Polychlorinated Biphenyls; June 1979", which is incorporated by reference, or the "Test Procedures for Determination of PCB Permeability of Food Packaging, Inner-Wraps, September 1976, revised May 1983" and whether, therefore, the barrier or class of barriers is deemed functional within the meaning of paragraph (c) of this section. The test results and any response of the Food and Drug Administration shall be placed on file with the Division of Dockets Management, Food and Drug Administration, 5630 Fishers Lane, rm. 1061, Rockville, MD 20852.

[42 FR 52819, Sept. 30, 1977, as amended at 44 FR 38340, June 29, 1979; 46 FR 8459, Jan. 27, 1981; 48 FR 10811, Mar. 15, 1983; 48 FR 37021, Aug. 16, 1983; 54 FR 24892, June 12, 1989; 59 FR 14364, Mar. 28, 1994; 61 FR 14480, Apr. 2, 1996; 66 FR 56035, Nov. 6, 2001]

EFFECTIVE DATE NOTE: At 38 FR 22794, Aug. 24, 1973, the following appeared concerning §109.30(a)(9) (formerly 122.10(a)(9)):

* * * §109.30(a)(9) is hereby stayed pending full review of the objections and requests for hearing. * * *

In the interim, as stated in the final order (38 FR 18098) the Food and Drug Administration will enforce the temporary tolerance level established by §109.30(a)(9) by seizing any paper food-packaging material shipped in interstate commerce after September 4, 1973 containing higher than the specified

level of PCB's as adulterated in violation of sec. 402 of the act.

Subpart C—Regulatory Limits for Added Poisonous or Deleterious Substances [Reserved]

Subpart D—Naturally Occurring Poisonous or Deleterious Substances [Reserved]

PART 110—CURRENT GOOD MANUFACTURING PRACTICE IN MANUFACTURING, PACKING, OR HOLDING HUMAN FOOD

Subpart A—General Provisions

- Sec.
110.3 Definitions.
110.5 Current good manufacturing practice.
110.10 Personnel.
110.19 Exclusions.

Subpart B—Buildings and Facilities

- 110.20 Plant and grounds.
110.35 Sanitary operations.
110.37 Sanitary facilities and controls.

Subpart C—Equipment

- 110.40 Equipment and utensils.

Subpart D [Reserved]

Subpart E—Production and Process Controls

- 110.80 Processes and controls.
110.93 Warehousing and distribution.

Subpart F [Reserved]

Subpart G—Defect Action Levels

- 110.110 Natural or unavoidable defects in food for human use that present no health hazard.

AUTHORITY: 21 U.S.C. 342, 371, 374; 42 U.S.C. 264.

SOURCE: 51 FR 24475, June 19, 1986, unless otherwise noted.

Subpart A—General Provisions

§ 110.3 Definitions.

The definitions and interpretations of terms in section 201 of the Federal Food, Drug, and Cosmetic Act (the act) are applicable to such terms when used

in this part. The following definitions shall also apply:

(a) *Acid foods or acidified foods* means foods that have an equilibrium pH of 4.6 or below.

(b) *Adequate* means that which is needed to accomplish the intended purpose in keeping with good public health practice.

(c) *Batter* means a semifluid substance, usually composed of flour and other ingredients, into which principal components of food are dipped or with which they are coated, or which may be used directly to form bakery foods.

(d) *Blanching*, except for tree nuts and peanuts, means a prepackaging heat treatment of foodstuffs for a sufficient time and at a sufficient temperature to partially or completely inactivate the naturally occurring enzymes and to effect other physical or biochemical changes in the food.

(e) *Critical control point* means a point in a food process where there is a high probability that improper control may cause, allow, or contribute to a hazard or to filth in the final food or decomposition of the final food.

(f) *Food* means food as defined in section 201(f) of the act and includes raw materials and ingredients.

(g) *Food-contact surfaces* are those surfaces that contact human food and those surfaces from which drainage onto the food or onto surfaces that contact the food ordinarily occurs during the normal course of operations. "Food-contact surfaces" includes utensils and food-contact surfaces of equipment.

(h) *Lot* means the food produced during a period of time indicated by a specific code.

(i) *Microorganisms* means yeasts, molds, bacteria, and viruses and includes, but is not limited to, species having public health significance. The term "undesirable microorganisms" includes those microorganisms that are of public health significance, that subject food to decomposition, that indicate that food is contaminated with filth, or that otherwise may cause food to be adulterated within the meaning of the act. Occasionally in these regulations, FDA used the adjective "microbial" instead of using an adjectival

phrase containing the word microorganism.

(j) *Pest* refers to any objectionable animals or insects including, but not limited to, birds, rodents, flies, and larvae.

(k) *Plant* means the building or facility or parts thereof, used for or in connection with the manufacturing, packaging, labeling, or holding of human food.

(l) *Quality control operation* means a planned and systematic procedure for taking all actions necessary to prevent food from being adulterated within the meaning of the act.

(m) *Rework* means clean, unadulterated food that has been removed from processing for reasons other than insanitary conditions or that has been successfully reconditioned by reprocessing and that is suitable for use as food.

(n) *Safe-moisture level* is a level of moisture low enough to prevent the growth of undesirable microorganisms in the finished product under the intended conditions of manufacturing, storage, and distribution. The maximum safe moisture level for a food is based on its water activity (a_w). An a_w will be considered safe for a food if adequate data are available that demonstrate that the food at or below the given a_w will not support the growth of undesirable microorganisms.

(o) *Sanitize* means to adequately treat food-contact surfaces by a process that is effective in destroying vegetative cells of microorganisms of public health significance, and in substantially reducing numbers of other undesirable microorganisms, but without adversely affecting the product or its safety for the consumer.

(p) *Shall* is used to state mandatory requirements.

(q) *Should* is used to state recommended or advisory procedures or identify recommended equipment.

(r) *Water activity* (a_w) is a measure of the free moisture in a food and is the quotient of the water vapor pressure of the substance divided by the vapor pressure of pure water at the same temperature.

§ 110.5 Current good manufacturing practice.

(a) The criteria and definitions in this part shall apply in determining whether a food is adulterated (1) within the meaning of section 402(a)(3) of the act in that the food has been manufactured under such conditions that it is unfit for food; or (2) within the meaning of section 402(a)(4) of the act in that the food has been prepared, packed, or held under insanitary conditions whereby it may have become contaminated with filth, or whereby it may have been rendered injurious to health. The criteria and definitions in this part also apply in determining whether a food is in violation of section 361 of the Public Health Service Act (42 U.S.C. 264).

(b) Food covered by specific current good manufacturing practice regulations also is subject to the requirements of those regulations.

§ 110.10 Personnel.

The plant management shall take all reasonable measures and precautions to ensure the following:

(a) *Disease control*. Any person who, by medical examination or supervisory observation, is shown to have, or appears to have, an illness, open lesion, including boils, sores, or infected wounds, or any other abnormal source of microbial contamination by which there is a reasonable possibility of food, food-contact surfaces, or food-packaging materials becoming contaminated, shall be excluded from any operations which may be expected to result in such contamination until the condition is corrected. Personnel shall be instructed to report such health conditions to their supervisors.

(b) *Cleanliness*. All persons working in direct contact with food, food-contact surfaces, and food-packaging materials shall conform to hygienic practices while on duty to the extent necessary to protect against contamination of food. The methods for maintaining cleanliness include, but are not limited to:

(1) Wearing outer garments suitable to the operation in a manner that protects against the contamination of food, food-contact surfaces, or food-packaging materials.

§ 110.19

(2) Maintaining adequate personal cleanliness.

(3) Washing hands thoroughly (and sanitizing if necessary to protect against contamination with undesirable microorganisms) in an adequate hand-washing facility before starting work, after each absence from the work station, and at any other time when the hands may have become soiled or contaminated.

(4) Removing all unsecured jewelry and other objects that might fall into food, equipment, or containers, and removing hand jewelry that cannot be adequately sanitized during periods in which food is manipulated by hand. If such hand jewelry cannot be removed, it may be covered by material which can be maintained in an intact, clean, and sanitary condition and which effectively protects against the contamination by these objects of the food, food-contact surfaces, or food-packaging materials.

(5) Maintaining gloves, if they are used in food handling, in an intact, clean, and sanitary condition. The gloves should be of an impermeable material.

(6) Wearing, where appropriate, in an effective manner, hair nets, headbands, caps, beard covers, or other effective hair restraints.

(7) Storing clothing or other personal belongings in areas other than where food is exposed or where equipment or utensils are washed.

(8) Confining the following to areas other than where food may be exposed or where equipment or utensils are washed: eating food, chewing gum, drinking beverages, or using tobacco.

(9) Taking any other necessary precautions to protect against contamination of food, food-contact surfaces, or food-packaging materials with microorganisms or foreign substances including, but not limited to, perspiration, hair, cosmetics, tobacco, chemicals, and medicines applied to the skin.

(c) *Education and training.* Personnel responsible for identifying sanitation failures or food contamination should have a background of education or experience, or a combination thereof, to provide a level of competency necessary for production of clean and safe food. Food handlers and supervisors

21 CFR Ch. I (4–1–07 Edition)

should receive appropriate training in proper food handling techniques and food-protection principles and should be informed of the danger of poor personal hygiene and insanitary practices.

(d) *Supervision.* Responsibility for assuring compliance by all personnel with all requirements of this part shall be clearly assigned to competent supervisory personnel.

[51 FR 24475, June 19, 1986, as amended at 54 FR 24892, June 12, 1989]

§ 110.19 Exclusions.

(a) The following operations are not subject to this part: Establishments engaged solely in the harvesting, storage, or distribution of one or more “raw agricultural commodities,” as defined in section 201(r) of the act, which are ordinarily cleaned, prepared, treated, or otherwise processed before being marketed to the consuming public.

(b) FDA, however, will issue special regulations if it is necessary to cover these excluded operations.

Subpart B—Buildings and Facilities

§ 110.20 Plant and grounds.

(a) *Grounds.* The grounds about a food plant under the control of the operator shall be kept in a condition that will protect against the contamination of food. The methods for adequate maintenance of grounds include, but are not limited to:

(1) Properly storing equipment, removing litter and waste, and cutting weeds or grass within the immediate vicinity of the plant buildings or structures that may constitute an attractant, breeding place, or harborage for pests.

(2) Maintaining roads, yards, and parking lots so that they do not constitute a source of contamination in areas where food is exposed.

(3) Adequately draining areas that may contribute contamination to food by seepage, foot-borne filth, or providing a breeding place for pests.

(4) Operating systems for waste treatment and disposal in an adequate manner so that they do not constitute a source of contamination in areas where food is exposed.

Food and Drug Administration, HHS

§ 110.35

If the plant grounds are bordered by grounds not under the operator's control and not maintained in the manner described in paragraph (a) (1) through (3) of this section, care shall be exercised in the plant by inspection, extermination, or other means to exclude pests, dirt, and filth that may be a source of food contamination.

(b) *Plant construction and design.* Plant buildings and structures shall be suitable in size, construction, and design to facilitate maintenance and sanitary operations for food-manufacturing purposes. The plant and facilities shall:

(1) Provide sufficient space for such placement of equipment and storage of materials as is necessary for the maintenance of sanitary operations and the production of safe food.

(2) Permit the taking of proper precautions to reduce the potential for contamination of food, food-contact surfaces, or food-packaging materials with microorganisms, chemicals, filth, or other extraneous material. The potential for contamination may be reduced by adequate food safety controls and operating practices or effective design, including the separation of operations in which contamination is likely to occur, by one or more of the following means: location, time, partition, air flow, enclosed systems, or other effective means.

(3) Permit the taking of proper precautions to protect food in outdoor bulk fermentation vessels by any effective means, including:

(i) Using protective coverings.

(ii) Controlling areas over and around the vessels to eliminate harborage for pests.

(iii) Checking on a regular basis for pests and pest infestation.

(iv) Skimming the fermentation vessels, as necessary.

(4) Be constructed in such a manner that floors, walls, and ceilings may be adequately cleaned and kept clean and kept in good repair; that drip or condensate from fixtures, ducts and pipes does not contaminate food, food-contact surfaces, or food-packaging materials; and that aisles or working spaces are provided between equipment and walls and are adequately unobstructed and of adequate width to permit em-

ployees to perform their duties and to protect against contaminating food or food-contact surfaces with clothing or personal contact.

(5) Provide adequate lighting in hand-washing areas, dressing and locker rooms, and toilet rooms and in all areas where food is examined, processed, or stored and where equipment or utensils are cleaned; and provide safety-type light bulbs, fixtures, skylights, or other glass suspended over exposed food in any step of preparation or otherwise protect against food contamination in case of glass breakage.

(6) Provide adequate ventilation or control equipment to minimize odors and vapors (including steam and noxious fumes) in areas where they may contaminate food; and locate and operate fans and other air-blowing equipment in a manner that minimizes the potential for contaminating food, food-packaging materials, and food-contact surfaces.

(7) Provide, where necessary, adequate screening or other protection against pests.

§ 110.35 Sanitary operations.

(a) *General maintenance.* Buildings, fixtures, and other physical facilities of the plant shall be maintained in a sanitary condition and shall be kept in repair sufficient to prevent food from becoming adulterated within the meaning of the act. Cleaning and sanitizing of utensils and equipment shall be conducted in a manner that protects against contamination of food, food-contact surfaces, or food-packaging materials.

(b) *Substances used in cleaning and sanitizing; storage of toxic materials.* (1) Cleaning compounds and sanitizing agents used in cleaning and sanitizing procedures shall be free from undesirable microorganisms and shall be safe and adequate under the conditions of use. Compliance with this requirement may be verified by any effective means including purchase of these substances under a supplier's guarantee or certification, or examination of these substances for contamination. Only the following toxic materials may be used or stored in a plant where food is processed or exposed:

§ 110.37

21 CFR Ch. I (4-1-07 Edition)

- (i) Those required to maintain clean and sanitary conditions;
- (ii) Those necessary for use in laboratory testing procedures;
- (iii) Those necessary for plant and equipment maintenance and operation; and
- (iv) Those necessary for use in the plant's operations.

(2) Toxic cleaning compounds, sanitizing agents, and pesticide chemicals shall be identified, held, and stored in a manner that protects against contamination of food, food-contact surfaces, or food-packaging materials. All relevant regulations promulgated by other Federal, State, and local government agencies for the application, use, or holding of these products should be followed.

(c) *Pest control.* No pests shall be allowed in any area of a food plant. Guard or guide dogs may be allowed in some areas of a plant if the presence of the dogs is unlikely to result in contamination of food, food-contact surfaces, or food-packaging materials. Effective measures shall be taken to exclude pests from the processing areas and to protect against the contamination of food on the premises by pests. The use of insecticides or rodenticides is permitted only under precautions and restrictions that will protect against the contamination of food, food-contact surfaces, and food-packaging materials.

(d) *Sanitation of food-contact surfaces.* All food-contact surfaces, including utensils and food-contact surfaces of equipment, shall be cleaned as frequently as necessary to protect against contamination of food.

(1) Food-contact surfaces used for manufacturing or holding low-moisture food shall be in a dry, sanitary condition at the time of use. When the surfaces are wet-cleaned, they shall, when necessary, be sanitized and thoroughly dried before subsequent use.

(2) In wet processing, when cleaning is necessary to protect against the introduction of microorganisms into food, all food-contact surfaces shall be cleaned and sanitized before use and after any interruption during which the food-contact surfaces may have become contaminated. Where equipment and utensils are used in a continuous

production operation, the utensils and food-contact surfaces of the equipment shall be cleaned and sanitized as necessary.

(3) Non-food-contact surfaces of equipment used in the operation of food plants should be cleaned as frequently as necessary to protect against contamination of food.

(4) Single-service articles (such as utensils intended for one-time use, paper cups, and paper towels) should be stored in appropriate containers and shall be handled, dispensed, used, and disposed of in a manner that protects against contamination of food or food-contact surfaces.

(5) Sanitizing agents shall be adequate and safe under conditions of use. Any facility, procedure, or machine is acceptable for cleaning and sanitizing equipment and utensils if it is established that the facility, procedure, or machine will routinely render equipment and utensils clean and provide adequate cleaning and sanitizing treatment.

(e) *Storage and handling of cleaned portable equipment and utensils.* Cleaned and sanitized portable equipment with food-contact surfaces and utensils should be stored in a location and manner that protects food-contact surfaces from contamination.

[51 FR 24475, June 19, 1986, as amended at 54 FR 24892, June 12, 1989]

§ 110.37 Sanitary facilities and controls.

Each plant shall be equipped with adequate sanitary facilities and accommodations including, but not limited to:

(a) *Water supply.* The water supply shall be sufficient for the operations intended and shall be derived from an adequate source. Any water that contacts food or food-contact surfaces shall be safe and of adequate sanitary quality. Running water at a suitable temperature, and under pressure as needed, shall be provided in all areas where required for the processing of food, for the cleaning of equipment, utensils, and food-packaging materials, or for employee sanitary facilities.

(b) *Plumbing.* Plumbing shall be of adequate size and design and adequately installed and maintained to:

Food and Drug Administration, HHS

§ 110.40

(1) Carry sufficient quantities of water to required locations throughout the plant.

(2) Properly convey sewage and liquid disposable waste from the plant.

(3) Avoid constituting a source of contamination to food, water supplies, equipment, or utensils or creating an unsanitary condition.

(4) Provide adequate floor drainage in all areas where floors are subject to flooding-type cleaning or where normal operations release or discharge water or other liquid waste on the floor.

(5) Provide that there is not backflow from, or cross-connection between, piping systems that discharge waste water or sewage and piping systems that carry water for food or food manufacturing.

(c) *Sewage disposal.* Sewage disposal shall be made into an adequate sewerage system or disposed of through other adequate means.

(d) *Toilet facilities.* Each plant shall provide its employees with adequate, readily accessible toilet facilities. Compliance with this requirement may be accomplished by:

(1) Maintaining the facilities in a sanitary condition.

(2) Keeping the facilities in good repair at all times.

(3) Providing self-closing doors.

(4) Providing doors that do not open into areas where food is exposed to airborne contamination, except where alternate means have been taken to protect against such contamination (such as double doors or positive air-flow systems).

(e) *Hand-washing facilities.* Hand-washing facilities shall be adequate and convenient and be furnished with running water at a suitable temperature. Compliance with this requirement may be accomplished by providing:

(1) Hand-washing and, where appropriate, hand-sanitizing facilities at each location in the plant where good sanitary practices require employees to wash and/or sanitize their hands.

(2) Effective hand-cleaning and sanitizing preparations.

(3) Sanitary towel service or suitable drying devices.

(4) Devices or fixtures, such as water control valves, so designed and con-

structed to protect against recontamination of clean, sanitized hands.

(5) Readily understandable signs directing employees handling unprotected food, unprotected food-packaging materials, of food-contact surfaces to wash and, where appropriate, sanitize their hands before they start work, after each absence from post of duty, and when their hands may have become soiled or contaminated. These signs may be posted in the processing room(s) and in all other areas where employees may handle such food, materials, or surfaces.

(6) Refuse receptacles that are constructed and maintained in a manner that protects against contamination of food.

(f) *Rubbish and offal disposal.* Rubbish and any offal shall be so conveyed, stored, and disposed of as to minimize the development of odor, minimize the potential for the waste becoming an attractant and harborage or breeding place for pests, and protect against contamination of food, food-contact surfaces, water supplies, and ground surfaces.

Subpart C—Equipment

§ 110.40 Equipment and utensils.

(a) All plant equipment and utensils shall be so designed and of such material and workmanship as to be adequately cleanable, and shall be properly maintained. The design, construction, and use of equipment and utensils shall preclude the adulteration of food with lubricants, fuel, metal fragments, contaminated water, or any other contaminants. All equipment should be so installed and maintained as to facilitate the cleaning of the equipment and of all adjacent spaces. Food-contact surfaces shall be corrosion-resistant when in contact with food. They shall be made of nontoxic materials and designed to withstand the environment of their intended use and the action of food, and, if applicable, cleaning compounds and sanitizing agents. Food-contact surfaces shall be maintained to protect food from being contaminated by any source, including unlawful indirect food additives.

§ 110.80

21 CFR Ch. I (4-1-07 Edition)

(b) Seams on food-contact surfaces shall be smoothly bonded or maintained so as to minimize accumulation of food particles, dirt, and organic matter and thus minimize the opportunity for growth of microorganisms.

(c) Equipment that is in the manufacturing or food-handling area and that does not come into contact with food shall be so constructed that it can be kept in a clean condition.

(d) Holding, conveying, and manufacturing systems, including gravimetric, pneumatic, closed, and automated systems, shall be of a design and construction that enables them to be maintained in an appropriate sanitary condition.

(e) Each freezer and cold storage compartment used to store and hold food capable of supporting growth of microorganisms shall be fitted with an indicating thermometer, temperature-measuring device, or temperature-recording device so installed as to show the temperature accurately within the compartment, and should be fitted with an automatic control for regulating temperature or with an automatic alarm system to indicate a significant temperature change in a manual operation.

(f) Instruments and controls used for measuring, regulating, or recording temperatures, pH, acidity, water activity, or other conditions that control or prevent the growth of undesirable microorganisms in food shall be accurate and adequately maintained, and adequate in number for their designated uses.

(g) Compressed air or other gases mechanically introduced into food or used to clean food-contact surfaces or equipment shall be treated in such a way that food is not contaminated with unlawful indirect food additives.

Subpart D [Reserved]

Subpart E—Production and Process Controls

§ 110.80 Processes and controls.

All operations in the receiving, inspecting, transporting, segregating, preparing, manufacturing, packaging, and storing of food shall be conducted in accordance with adequate sanitation

principles. Appropriate quality control operations shall be employed to ensure that food is suitable for human consumption and that food-packaging materials are safe and suitable. Overall sanitation of the plant shall be under the supervision of one or more competent individuals assigned responsibility for this function. All reasonable precautions shall be taken to ensure that production procedures do not contribute contamination from any source. Chemical, microbial, or extraneous-material testing procedures shall be used where necessary to identify sanitation failures or possible food contamination. All food that has become contaminated to the extent that it is adulterated within the meaning of the act shall be rejected, or if permissible, treated or processed to eliminate the contamination.

(a) *Raw materials and other ingredients.* (1) Raw materials and other ingredients shall be inspected and segregated or otherwise handled as necessary to ascertain that they are clean and suitable for processing into food and shall be stored under conditions that will protect against contamination and minimize deterioration. Raw materials shall be washed or cleaned as necessary to remove soil or other contamination. Water used for washing, rinsing, or conveying food shall be safe and of adequate sanitary quality. Water may be reused for washing, rinsing, or conveying food if it does not increase the level of contamination of the food. Containers and carriers of raw materials should be inspected on receipt to ensure that their condition has not contributed to the contamination or deterioration of food.

(2) Raw materials and other ingredients shall either not contain levels of microorganisms that may produce food poisoning or other disease in humans, or they shall be pasteurized or otherwise treated during manufacturing operations so that they no longer contain levels that would cause the product to be adulterated within the meaning of the act. Compliance with this requirement may be verified by any effective means, including purchasing raw materials and other ingredients under a supplier's guarantee or certification.

(3) Raw materials and other ingredients susceptible to contamination with aflatoxin or other natural toxins shall comply with current Food and Drug Administration regulations and action levels for poisonous or deleterious substances before these materials or ingredients are incorporated into finished food. Compliance with this requirement may be accomplished by purchasing raw materials and other ingredients under a supplier's guarantee or certification, or may be verified by analyzing these materials and ingredients for aflatoxins and other natural toxins.

(4) Raw materials, other ingredients, and rework susceptible to contamination with pests, undesirable microorganisms, or extraneous material shall comply with applicable Food and Drug Administration regulations and defect action levels for natural or unavoidable defects if a manufacturer wishes to use the materials in manufacturing food. Compliance with this requirement may be verified by any effective means, including purchasing the materials under a supplier's guarantee or certification, or examination of these materials for contamination.

(5) Raw materials, other ingredients, and rework shall be held in bulk, or in containers designed and constructed so as to protect against contamination and shall be held at such temperature and relative humidity and in such a manner as to prevent the food from becoming adulterated within the meaning of the act. Material scheduled for rework shall be identified as such.

(6) Frozen raw materials and other ingredients shall be kept frozen. If thawing is required prior to use, it shall be done in a manner that prevents the raw materials and other ingredients from becoming adulterated within the meaning of the act.

(7) Liquid or dry raw materials and other ingredients received and stored in bulk form shall be held in a manner that protects against contamination.

(b) *Manufacturing operations.* (1) Equipment and utensils and finished food containers shall be maintained in an acceptable condition through appropriate cleaning and sanitizing, as necessary. Insofar as necessary, equipment

shall be taken apart for thorough cleaning.

(2) All food manufacturing, including packaging and storage, shall be conducted under such conditions and controls as are necessary to minimize the potential for the growth of microorganisms, or for the contamination of food. One way to comply with this requirement is careful monitoring of physical factors such as time, temperature, humidity, a_w , pH, pressure, flow rate, and manufacturing operations such as freezing, dehydration, heat processing, acidification, and refrigeration to ensure that mechanical breakdowns, time delays, temperature fluctuations, and other factors do not contribute to the decomposition or contamination of food.

(3) Food that can support the rapid growth of undesirable microorganisms, particularly those of public health significance, shall be held in a manner that prevents the food from becoming adulterated within the meaning of the act. Compliance with this requirement may be accomplished by any effective means, including:

(i) Maintaining refrigerated foods at 45 °F (7.2 °C) or below as appropriate for the particular food involved.

(ii) Maintaining frozen foods in a frozen state.

(iii) Maintaining hot foods at 140 °F (60 °C) or above.

(iv) Heat treating acid or acidified foods to destroy mesophilic microorganisms when those foods are to be held in hermetically sealed containers at ambient temperatures.

(4) Measures such as sterilizing, irradiating, pasteurizing, freezing, refrigerating, controlling pH or controlling a_w that are taken to destroy or prevent the growth of undesirable microorganisms, particularly those of public health significance, shall be adequate under the conditions of manufacture, handling, and distribution to prevent food from being adulterated within the meaning of the act.

(5) Work-in-process shall be handled in a manner that protects against contamination.

(6) Effective measures shall be taken to protect finished food from contamination by raw materials, other ingredients, or refuse. When raw materials,

other ingredients, or refuse are unprotected, they shall not be handled simultaneously in a receiving, loading, or shipping area if that handling could result in contaminated food. Food transported by conveyor shall be protected against contamination as necessary.

(7) Equipment, containers, and utensils used to convey, hold, or store raw materials, work-in-process, rework, or food shall be constructed, handled, and maintained during manufacturing or storage in a manner that protects against contamination.

(8) Effective measures shall be taken to protect against the inclusion of metal or other extraneous material in food. Compliance with this requirement may be accomplished by using sieves, traps, magnets, electronic metal detectors, or other suitable effective means.

(9) Food, raw materials, and other ingredients that are adulterated within the meaning of the act shall be disposed of in a manner that protects against the contamination of other food. If the adulterated food is capable of being reconditioned, it shall be reconditioned using a method that has been proven to be effective or it shall be reexamined and found not to be adulterated within the meaning of the act before being incorporated into other food.

(10) Mechanical manufacturing steps such as washing, peeling, trimming, cutting, sorting and inspecting, mashing, dewatering, cooling, shredding, extruding, drying, whipping, defatting, and forming shall be performed so as to protect food against contamination. Compliance with this requirement may be accomplished by providing adequate physical protection of food from contaminants that may drip, drain, or be drawn into the food. Protection may be provided by adequate cleaning and sanitizing of all food-contact surfaces, and by using time and temperature controls at and between each manufacturing step.

(11) Heat blanching, when required in the preparation of food, should be effected by heating the food to the required temperature, holding it at this temperature for the required time, and then either rapidly cooling the food or

passing it to subsequent manufacturing without delay. Thermophilic growth and contamination in blanchers should be minimized by the use of adequate operating temperatures and by periodic cleaning. Where the blanched food is washed prior to filling, water used shall be safe and of adequate sanitary quality.

(12) Batters, breadings, sauces, gravies, dressings, and other similar preparations shall be treated or maintained in such a manner that they are protected against contamination. Compliance with this requirement may be accomplished by any effective means, including one or more of the following:

- (i) Using ingredients free of contamination.
- (ii) Employing adequate heat processes where applicable.
- (iii) Using adequate time and temperature controls.
- (iv) Providing adequate physical protection of components from contaminants that may drip, drain, or be drawn into them.
- (v) Cooling to an adequate temperature during manufacturing.
- (vi) Disposing of batters at appropriate intervals to protect against the growth of microorganisms.

(13) Filling, assembling, packaging, and other operations shall be performed in such a way that the food is protected against contamination. Compliance with this requirement may be accomplished by any effective means, including:

- (i) Use of a quality control operation in which the critical control points are identified and controlled during manufacturing.
- (ii) Adequate cleaning and sanitizing of all food-contact surfaces and food containers.
- (iii) Using materials for food containers and food-packaging materials that are safe and suitable, as defined in §130.3(d) of this chapter.
- (iv) Providing physical protection from contamination, particularly airborne contamination.
- (v) Using sanitary handling procedures.

(14) Food such as, but not limited to, dry mixes, nuts, intermediate moisture food, and dehydrated food, that relies on the control of a_w for preventing the

growth of undesirable microorganisms shall be processed to and maintained at a safe moisture level. Compliance with this requirement may be accomplished by any effective means, including employment of one or more of the following practices:

- (i) Monitoring the a_w of food.
- (ii) Controlling the soluble solids-water ratio in finished food.
- (iii) Protecting finished food from moisture pickup, by use of a moisture barrier or by other means, so that the a_w of the food does not increase to an unsafe level.

(15) Food such as, but not limited to, acid and acidified food, that relies principally on the control of pH for preventing the growth of undesirable microorganisms shall be monitored and maintained at a pH of 4.6 or below. Compliance with this requirement may be accomplished by any effective means, including employment of one or more of the following practices:

- (i) Monitoring the pH of raw materials, food in process, and finished food.
- (ii) Controlling the amount of acid or acidified food added to low-acid food.

(16) When ice is used in contact with food, it shall be made from water that is safe and of adequate sanitary quality, and shall be used only if it has been manufactured in accordance with current good manufacturing practice as outlined in this part.

(17) Food-manufacturing areas and equipment used for manufacturing human food should not be used to manufacture nonhuman food-grade animal feed or inedible products, unless there is no reasonable possibility for the contamination of the human food.

[51 FR 24475, June 19, 1986, as amended at 65 FR 56479, Sept. 19, 2000]

§ 110.93 Warehousing and distribution.

Storage and transportation of finished food shall be under conditions that will protect food against physical, chemical, and microbial contamination as well as against deterioration of the food and the container.

Subpart F [Reserved]

Subpart G—Defect Action Levels

§ 110.110 Natural or unavoidable defects in food for human use that present no health hazard.

(a) Some foods, even when produced under current good manufacturing practice, contain natural or unavoidable defects that at low levels are not hazardous to health. The Food and Drug Administration establishes maximum levels for these defects in foods produced under current good manufacturing practice and uses these levels in deciding whether to recommend regulatory action.

(b) Defect action levels are established for foods whenever it is necessary and feasible to do so. These levels are subject to change upon the development of new technology or the availability of new information.

(c) Compliance with defect action levels does not excuse violation of the requirement in section 402(a)(4) of the act that food not be prepared, packed, or held under unsanitary conditions or the requirements in this part that food manufacturers, distributors, and holders shall observe current good manufacturing practice. Evidence indicating that such a violation exists causes the food to be adulterated within the meaning of the act, even though the amounts of natural or unavoidable defects are lower than the currently established defect action levels. The manufacturer, distributor, and holder of food shall at all times utilize quality control operations that reduce natural or unavoidable defects to the lowest level currently feasible.

(d) The mixing of a food containing defects above the current defect action level with another lot of food is not permitted and renders the final food adulterated within the meaning of the act, regardless of the defect level of the final food.

(e) A compilation of the current defect action levels for natural or unavoidable defects in food for human use that present no health hazard may be obtained upon request from the Center for Food Safety and Applied Nutrition

(HFS-565), Food and Drug Administration, 5100 Paint Branch Pkwy., College Park, MD 20740.

[51 FR 24475, June 19, 1986, as amended at 61 FR 14480, Apr. 2, 1996; 66 FR 56035, Nov. 6, 2001]

PART 113—THERMALLY PROCESSED LOW-ACID FOODS PACKAGED IN HERMETICALLY SEALED CONTAINERS

Subpart A—General Provisions

Sec.

- 113.3 Definitions.
- 113.5 Current good manufacturing practice.
- 113.10 Personnel.

Subpart B [Reserved]

Subpart C—Equipment

- 113.40 Equipment and procedures.

Subpart D—Control of Components, Food Product Containers, Closures, and In-Process Material

- 113.60 Containers.

Subpart E—Production and Process Controls

- 113.81 Product preparation.
- 113.83 Establishing scheduled processes.
- 113.87 Operations in the thermal processing room.
- 113.89 Deviations in processing, venting, or control of critical factors.

Subpart F—Records and Reports

- 113.100 Processing and production records.

AUTHORITY: 21 U.S.C. 342, 371, 374; 42 U.S.C. 264.

SOURCE: 44 FR 16215, Mar. 16, 1979, unless otherwise noted.

Subpart A—General Provisions

§ 113.3 Definitions.

For the purposes of this part, the following definitions apply:

(a) *Aseptic processing and packaging* means the filling of a commercially sterilized cooled product into presterilized containers, followed by aseptic hermetical sealing, with a presterilized closure, in an atmosphere free of microorganisms.

(b) *Bleeders* means openings used to remove air that enters with steam from retorts and steam chambers and to promote circulation of steam in such retorts and steam chambers. Bleeders may serve as a means of removing condensate.

(c) *Come-up-time* means the time which elapses between the introduction of steam into the closed retort and the time when the retort reaches the required processing temperature.

(d) *Commercial processor* includes any person engaged in commercial, custom, or institutional (church, school, penal, or other organization) processing of food, including pet food. Persons engaged in the production of foods that are to be used in market or consumer tests are also included.

(e) *Commercial sterility*: (1) “Commercial sterility” of thermally processed food means the condition achieved—

(i) By the application of heat which renders the food free of—

(a) Microorganisms capable of reproducing in the food under normal nonrefrigerated conditions of storage and distribution; and

(b) Viable microorganisms (including spores) of public health significance; or

(ii) By the control of water activity and the application of heat, which renders the food free of microorganisms capable of reproducing in the food under normal nonrefrigerated conditions of storage and distribution.

(2) “Commercial sterility” of equipment and containers used for aseptic processing and packaging of food means the condition achieved by application of heat, chemical sterilant(s), or other appropriate treatment that renders the equipment and containers free of viable microorganisms having public health significance, as well as microorganisms of nonhealth significance, capable of reproducing in the food under normal nonrefrigerated conditions of storage and distribution.

(f) *Critical factor* means any property, characteristic, condition, aspect, or other parameter, variation of which may affect the scheduled process and the attainment of commercial sterility.

(g) *Flame sterilizer* means an apparatus in which hermetically sealed containers are agitated at atmospheric

pressure, by either continuous, discontinuous, or reciprocating movement, with impinging gas flames to achieve sterilization temperatures. A holding period in a heated section may follow the initial heating period.

(h) *Headspace, gross* is the vertical distance between the level of the product (generally the liquid surface) in an upright rigid container and the top edge of the container (the top of the double seam of a can or the top edge of a glass jar).

(i) *Headspace, net* of a container is the vertical distance between the level of the product (generally the liquid surface) in the upright rigid container and the inside surface of the lid.

(j) *Hermetically sealed container* means a container that is designed and intended to be secure against the entry of microorganisms and thereby to maintain the commercial sterility of its contents after processing.

(k) *Incubation* means the holding of a sample(s) at a specified temperature for a specified period of time for the purpose of permitting or stimulating the growth of microorganisms.

(l) *Initial temperature* means the average temperature of the contents of the coldest container to be processed at the time the thermal processing cycle begins, as determined after thorough stirring or shaking of the filled and sealed container.

(m) *Lot* means that amount of a product produced during a period of time indicated by a specific code.

(n) *Low-acid foods* means any foods, other than alcoholic beverages, with a finished equilibrium pH greater than 4.6 and a water activity (a_w) greater than 0.85. Tomatoes and tomato products having a finished equilibrium pH less than 4.7 are not classed as low-acid foods.

(o) *Minimum thermal process* means the application of heat to food, either before or after sealing in a hermetically sealed container, for a period of time and at a temperature scientifically determined to be adequate to ensure destruction of microorganisms of public health significance.

(p) *Operating process* means the process selected by the processor that equals or exceeds the minimum re-

quirements set forth in the scheduled process.

(q) *Retort* means any closed vessel or other equipment used for the thermal processing of foods.

(r) *Scheduled process* means the process selected by the processor as adequate under the conditions of manufacture for a given product to achieve commercial sterility. This process may be in excess of that necessary to ensure destruction of microorganisms of public health significance, and shall be at least equivalent to the process established by a competent processing authority to achieve commercial sterility.

(s) *Shall* is used to state mandatory requirements.

(t) *Should* is used to state recommended or advisory procedures or to identify recommended equipment.

(u) *Vacuum-packed products* means those products that are sealed in a container under the vacuum specified in the scheduled process, the maintenance of which vacuum is critical to the adequacy of the scheduled process.

(v) *Vents* means openings through the retort shell, controlled by gate, plug cock, or other adequate valves used for the elimination of air during the venting period.

(w) *Water activity* (a_w) is a measure of the free moisture in a product and is the quotient of the water vapor pressure of the substance divided by the vapor pressure of pure water at the same temperature.

§ 113.5 Current good manufacturing practice.

The criteria in §§ 113.10, 113.40, 113.60, 113.81, 113.83, 113.87, 113.89, and 113.100 shall apply in determining whether the facilities, methods, practices, and controls used by the commercial processor in the manufacture, processing, or packing of low-acid foods in hermetically sealed containers are operated or administered in a manner adequate to protect the public health.

§ 113.10 Personnel.

The operators of processing systems, retorts, aseptic processing and packaging systems and product formulating systems (including systems wherein water activity is used in conjunction

with thermal processing) and container closure inspectors shall be under the operating supervision of a person who has attended a school approved by the Commissioner for giving instruction appropriate to the preservation technology involved and who has been identified by that school as having satisfactorily completed the prescribed course of instruction. This person shall supervise only in those areas for which a school approved by the Commissioner identifies the person as having satisfactorily completed training.

Subpart B [Reserved]

Subpart C—Equipment

§ 113.40 Equipment and procedures.

(a) *Equipment and procedures for pressure processing in steam in still retorts—*

(1) *Indicating mercury-in-glass thermometer.* Each retort shall be equipped with at least one mercury-in-glass thermometer whose divisions are easily readable to 1 °F and whose temperature range does not exceed 17 °F per inch of graduated scale. Thermometers shall be tested for accuracy against a known accurate standard thermometer upon installation and at least once a year thereafter, or more frequently if necessary, to ensure their accuracy. Records of thermometer accuracy checks that specify date, standard used, method used, and person performing the test should be maintained. Each thermometer should have a tag, seal, or other means of identity that includes the date on which it was last tested for accuracy. A thermometer that has a divided mercury column or that cannot be adjusted to the standard shall be repaired or replaced before further use of the retort. Thermometers shall be installed where they can be accurately and easily read. Bulbs of indicating thermometers shall be installed either within the retort shell or in external wells attached to the retort. External wells or pipes shall be connected to the retort through at least a 3/4-inch diameter opening and equipped with a 1/16-inch or larger bleeder opening so located as to provide a full flow of steam past the length of the thermometer bulb. The bleeders for external wells shall emit

steam continuously during the entire processing period. The mercury thermometer—not the recorder chart—shall be the reference instrument for indicating the processing temperature.

(2) *Temperature-recording device.* Each still retort shall have an accurate temperature-recording device. Graduations on the temperature-recording devices shall not exceed 2 °F within a range of 10 °F of the processing temperature. Each chart shall have a working scale of not more than 55 °F per inch within a range of 20 °F of the processing temperature. The temperature chart shall be adjusted to agree as nearly as possible with, but to be in no event higher than, the known accurate mercury-in-glass thermometer during the process time. A means of preventing unauthorized changes in adjustment shall be provided. A lock, or a notice from management posted at or near the recording device which provides a warning that only authorized persons are permitted to make adjustments, is a satisfactory means for preventing unauthorized changes. The recorder may be combined with the steam controller and may be a recording-controlling instrument. The temperature-recorder bulb shall be installed either within the retort shell or in a well attached to the shell. Each temperature-recorder bulb well shall have a 1/16-inch or larger bleeder which emits steam continuously during the processing period. Air-operated temperature controllers should have adequate filter systems to ensure a supply of clean, dry air.

(3) *Pressure gages.* Each retort should be equipped with a pressure gage that should be graduated in divisions of 2 pounds or less.

(4) *Steam controller.* Each retort shall be equipped with an automatic steam controller to maintain the retort temperature. This may be a recording-controlling instrument when combined with a recording thermometer. The steam controller may be air-operated and actuated by a temperature sensor positioned near the mercury-in-glass thermometer in the retort; a steam controller activated by the steam pressure of the retort is acceptable if it is carefully maintained mechanically so that it operates satisfactorily.

(5) *Steam inlet.* The steam inlet to each still retort shall be large enough to provide sufficient steam for proper operation of the retort. Steam may enter either the top portion or the bottom portion of the retort but, in any case, shall enter the portion of the retort opposite the vent; for example, steam inlet in bottom portion and vent in top portion.

(6) *Crate supports.* A bottom crate support shall be used in vertical still retorts. Baffle plates shall not be used in the bottom of still retorts.

(7) *Steam spreaders.* Steam spreaders are continuations of the steam inlet line inside the retort. Horizontal still retorts shall be equipped with steam spreaders that extend the length of the retort. For steam spreaders along the bottom of the retort, the perforations should be along the top 90° of this pipe, that is, within 45° on either side of the top center. Horizontal still retorts over 30 feet long should have two steam inlets connected to the spreader. In vertical still retorts, the steam spreaders, if used, should be perforated along the center line of the pipe facing the interior of the retort or along the sides of the pipe. The number of perforations should be such that the total cross-sectional area of the perforations is equal to 1½ to 2 times the cross-sectional area of the smallest restriction in the steam inlet line.

(8) *Bleeders.* Bleeders, except those for thermometer wells, shall be one-eighth inch or larger and shall be wide open during the entire process, including the come-up-time. For horizontal still retorts, bleeders shall be located within approximately 1 foot of the outermost locations of containers at each end along the top of the retort; additional bleeders shall be located not more than 8 feet apart along the top. Bleeders may be installed at positions other than those specified above, as long as there is evidence in the form of heat distribution data that they accomplish adequate removal of air and circulation of steam within the retort. Vertical retorts shall have at least one bleeder opening located in that portion of the retort opposite the steam inlet. In retorts having top steam inlet and bottom venting, a bleeder shall be installed in the bottom of the retort to

remove condensate. All bleeders shall be arranged so that the operator can observe that they are functioning properly.

(9) *Stacking equipment and position of containers.* Crates, trays, gondolas, etc., for holding containers shall be made of strap iron, adequately perforated sheet metal, or other suitable material. When perforated sheet metal is used for the bottoms, the perforations should be approximately the equivalent of 1-inch holes on 2-inch centers. If dividers are used between the layers of containers, they should be perforated as above. The positioning of containers in the retort, when specified in the scheduled process, shall be in accordance with that process.

(10) *Air valves.* Retorts using air for pressure cooling shall be equipped with a suitable valve to prevent air leakage into the retort during processing.

(11) *Water valves.* Retorts using water for cooling shall be equipped with a suitable valve to prevent leakage of water into the retort during processing.

(12) *Vents.* Vents shall be installed in such a way that air is removed from the retort before timing of the process is started. Vents shall be controlled by gate, plug cock, or other adequate type valves which shall be fully open to permit rapid discharge of air from the retort during the venting period. Vents shall not be connected directly to a closed drain system. If the overflow is used as a vent, there shall be an atmospheric break in the line before it connects to a closed drain. The vent shall be located in that portion of the retort opposite the steam inlet; for example, steam inlet in bottom portion and vent in top portion. Where a retort manifold connects several vent pipes from a single still retort, it shall be controlled by a gate, plug cock, or other adequate type valve. The retort manifold shall be of a size that the cross-sectional area of the pipe is larger than the total cross-sectional area of all connecting vents. The discharge shall not be directly connected to a closed drain without an atmospheric break in the line. A manifold header connecting vents or manifolds from several still retorts shall lead to the atmosphere.

§ 113.40

21 CFR Ch. I (4-1-07 Edition)

The manifold header shall not be controlled by a valve and shall be of a size that the cross-sectional area is at least equal to the total cross-sectional area of all connecting retort manifold pipes from all retorts venting simultaneously. Timing of the process shall not begin until the retort has been properly vented and the processing temperature has been reached. Some typical installations and operating procedures reflecting the requirements of this section for venting still retorts are given in paragraph (a)(12)(i)(a) through (d) and (ii)(a) and (b) of this section.

(i) *Venting horizontal retorts.* (a) Venting through multiple 1-inch vents discharging directly to atmosphere.

1-in. gate valve 1-in. vent

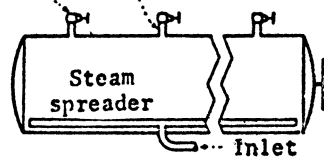

Specifications. One 1-inch vent for every 5 feet of retort length, equipped with a gate or plug cock valve and discharging to atmosphere; end vents not more than 2½ feet from ends of retort.

Venting method. Vent valves should be wide open for at least 5 minutes and to at least 225 °F, or at least 7 minutes and to at least 220 °F.

(b) Venting through multiple 1-inch vents discharging through a manifold to atmosphere.

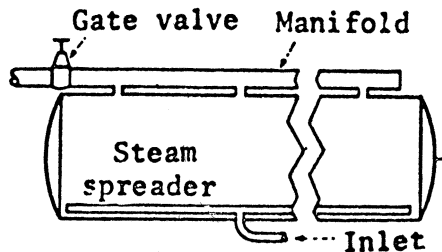

Specifications. One 1-inch vent for every 5 feet of retort length; and vents not over 2½ feet from ends of retort: Size of manifold—for retorts less than 15 feet in length, 2½ inches; for retorts 15 feet and over in length, 3 inches.

Venting method. Manifold vent gate or plug cock valve should be wide open for at least 6 minutes and to at least 225 °F, or for at least 8 minutes and to at least 220 °F.

(c) Venting through water spreaders.

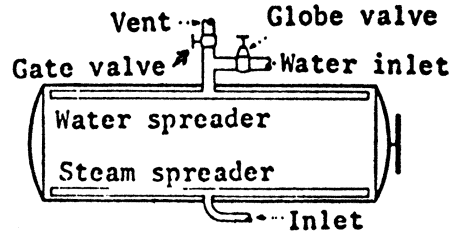

Size of vent and vent valve. For retorts less than 15 feet in length, 2 inches; for retorts 15 feet and over in length, 2½ inches.

Size of water spreader. For retorts less than 15 feet in length, 1½ inches; for retorts 15 feet and over in length, 2 inches. The number of holes should be such that their total cross-sectional area is approximately equal to the cross-sectional area of the vent pipe inlet.

Venting method. Water spreader vent gate or plug cock valve should be wide open for at least 5 minutes and to at least 225 °F, or for at least 7 minutes and to at least 220 °F.

(d) Venting through a single 2½-inch top vent (for retorts not exceeding 15 feet in length).

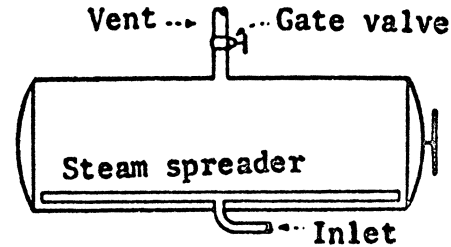

Specifications: A 2½-inch vent equipped with a 2½-inch gate or plug cock valve and located within 2 feet of the center of the retort.

Venting method: Vent gate or plug cock valve should be wide open for at least 4 minutes and to at least 220 °F.

(ii) *Venting vertical retorts.* (a) Venting through a 1½-inch overflow.

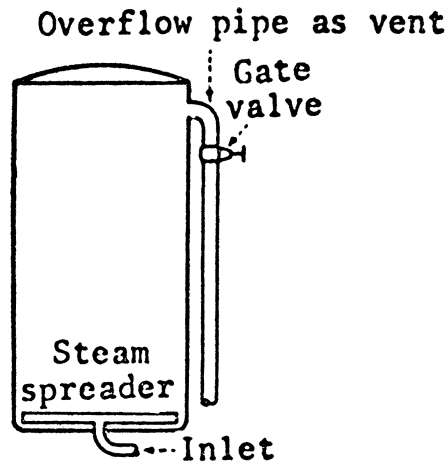

Specifications. A 1½-inch overflow pipe equipped with a 1½-inch gate or plug cock valve and with not more than 6 feet of 1½-inch pipe beyond the valve before break to the atmosphere or to a manifold header.

Venting method. Vent gate or plug cock valve should be wide open for at least 4 minutes and to at least 218 °F, or for at least 5 minutes and to at least 215 °F.

(b) Venting through a single 1-inch side or top vent.

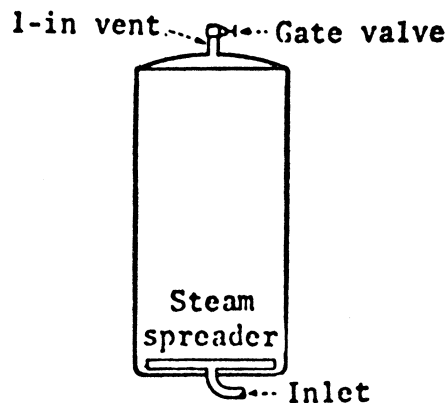

Specifications. A 1-inch vent in lid or top side, equipped with a 1-inch gate or plug cock valve and discharging directly into the atmosphere or to a manifold header.

Venting method. Vent gate or plug cock valve should be wide open for at least 5 minutes and to at least 230 °F, or for at least 7 minutes and to at least 220 °F.

(iii) Other installations and operating procedures that deviate from the above specifications may be used if

there is evidence in the form of heat distribution data, which shall be kept on file, that they accomplish adequate venting of air.

(13) *Critical factors.* Critical factors specified in the scheduled process shall be measured and recorded on the processing record at intervals of sufficient frequency to ensure that the factors are within the limits specified in the scheduled process.

(i) When maximum fill-in or drained weight is specified in the scheduled process, it shall be measured and recorded at intervals of sufficient frequency to ensure that the weight of the product does not exceed the maximum for the given container size specified in the scheduled process.

(ii) Closing machine vacuum in vacuum-packed products shall be observed and recorded at intervals of sufficient frequency to ensure that the vacuum is as specified in the scheduled process.

(iii) Such measurements and recordings should be made at intervals not to exceed 15 minutes.

(iv) When the product style results in stratification or layering of the primary product in the containers, the positioning of containers in the retort shall be according to the scheduled process.

(b) *Equipment and procedures for pressure processing in water in still retorts—*

(1) *Indicating mercury-in-glass thermometer.* Each retort shall be equipped with at least one mercury-in-glass thermometer whose divisions are easily readable to 1 °F and whose temperature range does not exceed 17 °F per inch of graduated scale. Thermometers shall be tested for accuracy against a known accurate standard thermometer upon installation and at least once a year thereafter, or more frequently if necessary, to ensure their accuracy. Records of thermometer accuracy checks which specify date, standard used, method used, and person performing the test should be maintained. Each thermometer should have a tag, seal, or other means of identity that includes the date when it was last tested for accuracy. A thermometer that has a divided mercury column or that cannot be adjusted to the standard shall be repaired or replaced before further use of the retort. Thermometers

shall be installed where they can be accurately and easily read. Bulbs of indicating thermometers shall be located in such a position that they are beneath the surface of the water throughout the process. On horizontal retorts, this entry should be made in the side at the center, and the thermometer bulbs shall be inserted directly into the retort shell. In both vertical and horizontal retorts, the thermometer bulbs shall extend directly into the water a minimum of at least 2 inches without a separable well or sleeve. The mercury thermometer—not the recorder chart—shall be the reference instrument for indicating the processing temperature.

(2) *Temperature-recording device.* Each still retort shall have an accurate temperature-recording device. Graduations on the temperature-recording devices shall not exceed 2 °F within a range of 10 °F of the processing temperature. Each chart shall have a working scale of not more than 55 °F per inch within a range of 20 °F of the processing temperature. The temperature chart shall be adjusted to agree as nearly as possible with, but to be in no event higher than, the known accurate mercury-in-glass thermometer during the process time. A means of preventing unauthorized changes in adjustment shall be provided. A lock, or a notice from management posted at or near the recording device which provides a warning that only authorized persons are permitted to make adjustments, is a satisfactory means for preventing unauthorized changes. The recorder may be combined with the steam controller and may be a recording-controlling instrument. The recording-thermometer bulb should be located adjacent to the bulb of the mercury-in-glass thermometer, except in the case of a vertical retort equipped with a combination recorder-controller. In such vertical retorts, the temperature recorder-control bulb shall be located at the bottom of the retort below the lowest crate rest in such a position that the steam does not strike it directly. In horizontal retorts, the temperature recorder-control bulb shall be located between the water surface and the horizontal plane passing through the center of the retort so that there is no opportunity for direct steam impingement on the control

bulb. Air-operated temperature controllers should have adequate filter systems to ensure a supply of clean, dry air.

(3) *Pressure gages.* (i) Each retort should be equipped with a pressure gage, which should be graduated in divisions of 2 pounds or less.

(ii) Each retort should have an adjustable pressure relief or control valve of a capacity sufficient to prevent an undesired increase in retort pressure when the water valve is wide open and should be installed in the overflow line.

(4) *Steam controller.* Each retort shall be equipped with an automatic steam controller to maintain the retort temperature. This may be a recording-controlling instrument when combined with a recording thermometer.

(5) *Steam introduction.* Steam shall be distributed in the bottom of the retort in a manner adequate to provide uniform heat distribution throughout the retort. In vertical retorts, uniform steam distribution can be achieved by any of several methods. In horizontal retorts, the steam distributor shall run the length of the bottom of the retort with perforations distributed uniformly along the upper part of the pipe.

(6) *Crate supports.* A bottom crate support shall be used in vertical still retorts. Baffle plates shall not be used in the bottom of the retort. Centering guides should be installed so as to ensure that there is about a 1½-inch clearance between the side wall of the crate and the retort wall.

(7) *Stacking equipment and position of containers.* Crates, trays, gondolas, etc., for holding containers shall be made of strap iron, adequately perforated sheet metal, or other suitable material. When perforated sheet metal is used for the bottoms, the perforations should be approximately the equivalent of 1-inch holes on 2-inch centers. If divider plates are used between the layers of containers, they should be perforated as above. The positioning of containers in the retort, when specified in the scheduled process, shall be in accordance with that process. Dividers, racks, trays, or other means of positioning of flexible containers shall be designed and employed to ensure even circulation of heating medium around all containers in the retort.

(8) *Drain valve.* A nonclogging, water-tight valve shall be used. Screens should be installed over all drain openings.

(9) *Water level indicator.* There shall be a means of determining the water level in the retort during operation, e.g., by using a gage, water glass, or petcock(s). Water shall cover the top layer of containers during the entire come-up-time and processing periods and should cover the top layer of containers during the cooling periods. The operator shall check and record the water level at intervals sufficient to ensure its adequacy.

(10)(i) *Air supply and controls.* In both horizontal and vertical still retorts for pressure processing in water, a means shall be provided for introducing compressed air at the proper pressure and rate. The proper pressure shall be controlled by an automatic pressure control unit. A check valve shall be provided in the air supply line to prevent water from entering the system. Air or water circulation shall be maintained continuously during the come-up-time and during processing and cooling periods; the adequacy of the air or water circulation for uniform heat distribution within the retort shall be established in accordance with procedures recognized by a competent processing authority and records shall be kept on file; if air is used to promote circulation, it shall be introduced into the steam line at a point between the retort and the steam control valve at the bottom of the retort.

(ii) *Water circulation.* When a water circulating system is used for heat distribution, it shall be installed in such a manner that water will be drawn from the bottom of the retort through a suc-

tion manifold and discharged through a spreader which extends the length of the top of the retort. The holes in the water spreader shall be uniformly distributed and should have an aggregate area not greater than the cross-section area of the outlet line from the pump. The suction outlets should be protected with nonclogging screens to keep debris from entering the circulating system. The pump shall be equipped with a pilot light or other signaling device to warn the operator when it is not running, and with a bleeder to remove air when starting operations. Alternative methods for circulation of water in the retort may be used when established by a competent authority as adequate for even heat distribution.

(11) *Cooling water supply.* In vertical retorts the cooling water should be introduced at the top of the retort between the water and container levels; in horizontal retorts the cooling water should be introduced into the suction side of the pump. A check valve should be included in the cooling water line.

(12) *Retort headspace.* The headspace necessary to control the air pressure should be maintained between the water level and the top of the retort shell.

(13) *Vertical and horizontal still retorts.* Vertical and horizontal still retorts should follow the arrangements in the diagrams below in this paragraph. Other installation and operating procedures that deviate from these arrangements may be used, as long as there is evidence in the form of heat distribution data or other suitable information, which shall be kept on file, that demonstrates that the heat distribution is adequate.

Vertical Retorts

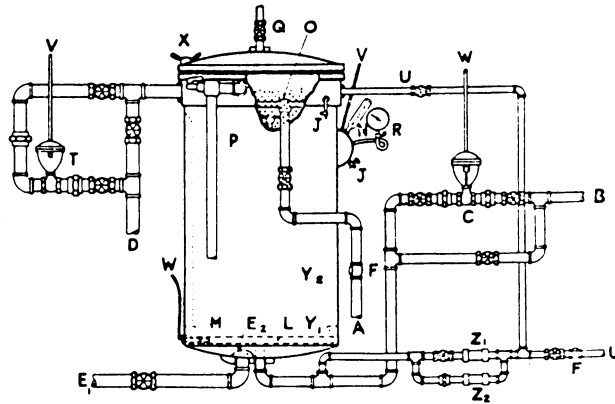

Horizontal Retorts

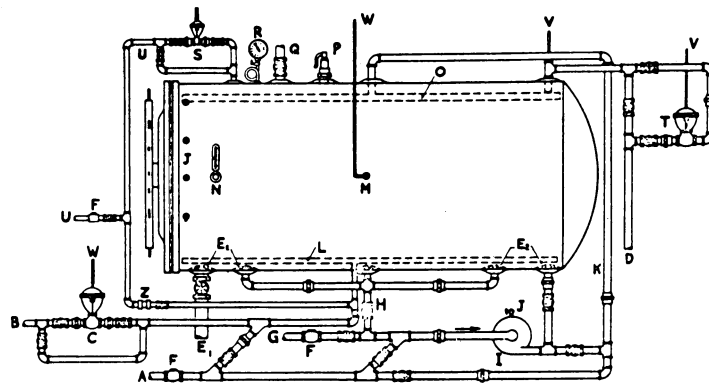

LEGEND FOR VERTICAL AND HORIZONTAL STILL RETORTS

- A—Water line.
- B—Steam line.
- C—Temperature control.
- D—Overflow line.
- E₁—Drain line.
- E₂—Screens.
- F—Check valves.
- G—Line from hot water storage.
- H—Suction line and manifold.
- I—Circulating pump.
- J—Petcocks.
- K—Recirculating line.
- L—Steam distributor.
- M—Temperature-controller bulb.
- N—Thermometer.

- O—Water spreader.
- P—Safety valve.
- Q—Vent valve for steam processing.
- R—Pressure gage.
- S—Inlet air control.
- T—Pressure control.
- U—Air line.
- V—To pressure control instrument.
- W—To temperature control instrument.
- X—Wing nuts.
- Y₁—Crate support.
- Y₂—Crate guides.
- Z—Constant flow orifice valve.
- Z₁—Constant flow orifice valve used during come-up.
- Z₂—Constant flow orifice valve used during cook.

(14) *Critical factors.* Critical factors specified in the scheduled process shall be measured and recorded on the processing record at intervals of sufficient frequency to ensure that the factors are within the limits specified in the scheduled process.

(i) When maximum fill-in or drained weight is specified in the scheduled process, it shall be measured and recorded at intervals of sufficient frequency to ensure that the weight of the product does not exceed the maximum for the given container size specified in the scheduled process.

(ii) Closing machine vacuum in vacuum-packed products shall be observed and recorded at intervals of sufficient frequency to ensure that the vacuum is as specified in the scheduled process.

(iii) Such measurements and recordings should be made at intervals not to exceed 15 minutes.

(iv) When the product style results in stratification or layering of the primary product in the containers, the positioning of containers in the retort shall be according to the scheduled process.

(c) *Equipment and procedures for pressure processing in steam in continuous agitating retorts—(1) Indicating mercury-in-glass thermometer.* Each retort shall be equipped with at least one mercury-in-glass thermometer whose divisions are easily readable to 1 °F and whose temperature range does not exceed 17 °F per inch of graduated scale. Thermometers shall be tested for accuracy against a known accurate standard thermometer upon installation and at least once a year thereafter, or more frequently if necessary, to ensure their accuracy. Records of thermometer accuracy checks which specify date, standard used, method used, and person performing the test should be maintained. Each thermometer should have a tag, seal, or other means of identity that includes the date on which it was last tested for accuracy. A thermometer that has a divided mercury column or that cannot be adjusted to the standard shall be repaired or replaced before further use of the retort. Thermometers shall be installed where they can be accurately and easily read. Bulbs in indicating thermometers shall be installed either within the retort

shell or in external wells attached to the retort. External wells or pipes shall be connected to the retort through at least a 3/4-inch diameter opening, and equipped with a 1/16-inch or larger bleeder opening so located as to provide a full flow of steam past the length of the thermometer bulb. The bleeders for external wells shall emit steam continuously during the entire processing period. The mercury thermometer—not the recorder chart—shall be the reference instrument for indicating the processing temperature.

(2) *Temperature-recording device.* Each retort shall have an accurate temperature-recording device. Graduations on the temperature-recording devices shall not exceed 2 °F within a range of 10 °F of the processing temperature. Each chart shall have a working scale of not more than 55 °F per inch within a range of 20 °F of the processing temperature. The temperature chart shall be adjusted to agree as nearly as possible with, but to be in no event higher than, the known accurate mercury-in-glass thermometer during the process time. A means of preventing unauthorized changes in adjustment shall be provided. A lock, or a notice from management posted at or near the recording device that provides a warning that only authorized persons are permitted to make adjustments, is a satisfactory means of preventing unauthorized changes. The recorder may be combined with the steam controller and may be a recording-controlling instrument. The temperature-recorder bulb shall be installed either within the retort shell or in a well attached to the shell. Each temperature-recorder bulb well shall have a 1/16-inch or larger bleeder opening emitting steam continuously during the processing period. Air-operated temperature controllers should have adequate filter systems to ensure a supply of clean, dry air.

(3) *Pressure gages.* Each retort should be equipped with a pressure gage that should be graduated in divisions of 2 pounds or less.

(4) *Steam controller.* Each retort shall be equipped with an automatic steam controller to maintain the retort temperature. This may be a recording-controlling instrument when combined with a recording thermometer. A

steam controller activated by the steam pressure of the retort is acceptable if it is carefully maintained mechanically so that it operates satisfactorily.

(5) *Bleeders.* Bleeders, except those for thermometer wells, shall be one-eighth inch or larger and shall be wide open during the entire process, including the come-up-time. Bleeders shall be located within approximately 1 foot of the outermost location of containers at each end along the top of the retort; additional bleeders shall be located not more than 8 feet apart along the top of the retort. All bleeders shall be arranged so that the operator can observe that they are functioning properly. The condensate bleeder shall be checked with sufficient frequency to ensure adequate removal of condensate or shall be equipped with an automatic alarm system(s) that would serve as a continuous monitor of condensate-bleeder functioning. Visual checks should be done at intervals of not more than 15 minutes. A record of such checks should be kept to show that the bleeder is functioning properly.

(6) *Venting and condensate removal.* Vents shall be located in that portion of the retort opposite the steam inlet. Air shall be removed before processing is started. Heat distribution data or documentary proof from the manufacturer or from a competent processing authority, demonstrating that adequate venting is achieved, shall be kept on file. At the time steam is turned on, the drain should be opened for a time sufficient to remove steam condensate from the retort, and provision shall be made for continuing drainage of condensate during the retort operation. The condensate bleeder in the bottom of the shell serves as an indicator of continuous condensate removal.

(7) *Retort speed timing.* The rotational speed of the retort shall be specified in the scheduled process. The speed shall be adjusted and recorded when the retort is started, at any time a speed change is made, and at intervals of sufficient frequency to ensure that the retort speed is maintained as specified in the scheduled process. These adjustments and recordings should be made every 4 hours or less. Alternatively, a recording tachometer may be used to

provide a continuous record of the speed. A means of preventing unauthorized speed changes on retorts shall be provided. A lock, or a notice from management posted at or near the speed adjustment device that provides a warning that only authorized persons are permitted to make adjustments, is a satisfactory means of preventing unauthorized changes.

(8) *Emergency stops.* If a retort jams or breaks down during processing operations, necessitating cooling the retort for repairs, the retort shall be operated in such a way that ensures that the product is commercially sterile, or the retort is to be cooled promptly and all containers either reprocessed, repacked and reprocessed, or discarded. When operated as a still retort, all containers shall be given a full still retort process before the retort is cooled. If, in such an emergency, a scheduled still process or another process established to ensure commercial sterility is to be used, it shall be made readily available to the retort operator.

(i) Any containers in the retort intake valve or in transfer valves between cooker shells of a continuous retort at the time of breakdown shall either be reprocessed, repacked and reprocessed, or discarded.

(ii) Both the time at which the reel stopped and the time the retort was used for a still retort process, if so used, shall be marked on the recording chart and entered on the other production records required in this chapter. If the alternative procedure of prompt cooling is followed, the subsequent handling methods used for the containers in the retort at the time of stopping and cooling shall be entered on the production records.

(9) *Temperature drop.* If the temperature of the continuous retort drops below the temperature specified in the scheduled process while containers are in the retort, the retort reel shall be stopped promptly. An automatic device should be used to stop the reel when the temperature drops below the specified process temperature. Before the reel is restarted, all containers in the retort shall be given a complete scheduled still retort process if the temperature drop was 10 °F or more below the specified temperature, or alternatively,

container entry to the retort shall be stopped and the reel restarted to empty the retort. The discharged containers shall be either reprocessed, repacked and reprocessed, or discarded. Both the time at which the reel stopped and the time the retort was used for a still retort process, if so used, shall be marked on the recording chart and entered on the other production records required in this chapter. If the alternative procedure of emptying the retort is followed, the subsequent handling methods used for the containers in the retort at the time of the temperature drop shall be entered on the production records. If the temperature drop was less than 10 °F, a scheduled authorized emergency still process approved by a qualified person(s) having expert knowledge of thermal processing requirements may be used before restarting the retort reel. Alternatively, container entry to the retort shall be stopped and an authorized emergency agitating process may be used before container entry to the retort is restarted. When emergency procedures are used, no containers may enter the retort and the process and procedures used shall be noted on the production records.

(10) *Critical factors.* Critical factors specified in the scheduled process shall be measured and recorded on the processing record at intervals of sufficient frequency to ensure that the factors are within the limits specified in the scheduled process. The minimum headspace of containers, if specified in the scheduled process, shall be measured and recorded at intervals of sufficient frequency to ensure that the headspace is as specified in the scheduled process. The headspace of solder-tipped, lapseam (vent hole) cans may be measured by net weight determinations. The headspace of double seamed cans may also be measured by net weight determinations for homogenous liquids, taking into account the specific can end profile and other factors which affect the headspace, if proof of the accuracy of such measurements is maintained and the procedure and resultant headspace is in accordance with the scheduled process. When the product consistency is specified in the scheduled process, the consistency of the product shall be determined by ob-

jective measurements on the product taken from the filler before processing and recorded at intervals of sufficient frequency to ensure that the consistency is as specified in the scheduled process. Minimum closing machine vacuum in vacuum-packed products, maximum fill-in or drained weight, minimum net weight, and percent solids shall be as specified in the scheduled process for all products when deviations from such specifications may affect the scheduled process. All measurements and recordings of critical factors should be made at intervals not to exceed 15 minutes.

(d) *Equipment and procedures for pressure processing in steam in discontinuous agitating retorts—(1) Indicating mercury-in-glass thermometer.* Each retort shall be equipped with at least one mercury-in-glass thermometer whose divisions are easily readable to 1 °F and whose temperature range does not exceed 17 °F per inch of graduated scale. Thermometers shall be tested for accuracy against a known accurate standard thermometer upon installation and at least once a year thereafter, or more frequently if necessary, to ensure their accuracy. Records of thermometer accuracy checks which specify date, standard used, method used, and person performing the test should be maintained. Each thermometer should have a tag, seal, or other means of identity that includes the date on which it was last tested for accuracy. A thermometer that has a divided mercury column or that cannot be adjusted to the standard shall be repaired or replaced before further use of the retort. Thermometers shall be installed where they can be accurately and easily read. Bulbs of indicating thermometers shall be installed either within the retort shell or in external wells attached to the retort. External wells or pipes shall be connected to the retort through at least a 3/4-inch-diameter opening, and equipped with a 1/16-inch or larger bleeder opening so located as to provide a full flow of steam past the length of the thermometer bulb. The bleeder for external wells shall emit steam continuously during the entire processing period. The mercury thermometer—not the recorder chart—

shall be the reference instrument for indicating the processing temperature.

(2) *Temperature-recording device.* Each retort shall have an accurate temperature-recording device. Graduations on the temperature-recording devices shall not exceed 2 °F within a range of 10 °F of the processing temperature. Each chart shall have a working scale of not more than 55 °F per inch within a range of 20 °F of the processing temperature. The temperature chart shall be adjusted to agree as nearly as possible with, but to be in no event higher than, the known accurate mercury-in-glass thermometer during the process time. A means of preventing unauthorized changes in adjustment shall be provided. A lock, or a notice from management posted at or near the recording device that provides a warning that only authorized persons are permitted to make adjustments, is a satisfactory means for preventing unauthorized changes. The recorder may be combined with the steam controller and may be a recording-controlling instrument. The temperature-recorder bulb shall be installed either within the retort shell or in a well attached to the shell. Each temperature-recorder bulb well shall have a 1/16-inch or larger bleeder opening emitting steam continuously during the processing period. Air-operated temperature controllers should have adequate filter systems to ensure a supply of clean, dry air.

(3) *Pressure gages.* Each retort should be equipped with a pressure gage, which should be graduated in divisions of 2 pounds or less.

(4) *Steam controller.* Each retort shall be equipped with an automatic steam controller to maintain the retort temperature. This may be a recording-controlling instrument when combined with a recording thermometer. A steam controller activated by the steam pressure of the retort is acceptable if it is mechanically maintained so that it operates satisfactorily.

(5) *Bleeders.* Bleeders, except those for thermometer wells, shall be one-eighth inch or larger and shall be wide open during the entire process, including the come-up-time. Bleeders shall be located within approximately 1 foot of the outermost location of containers, at each end along the top of the retort;

additional bleeders shall be located not more than 8 feet apart along the top. Bleeders may be installed at positions other than those specified above, as long as there is evidence in the form of heat distribution data that they accomplish adequate removal of air and circulation of heat within the retort. In retorts having top steam inlet and bottom venting, a bleeder shall be installed in the bottom of the retort to remove condensate. All bleeders shall be arranged in a way that enables the operator to observe that they are functioning properly.

(6) *Venting and condensate removal.* The air in each retort shall be removed before processing is started. Heat distribution data or documentary proof from the manufacturer or from a competent processing authority, demonstrating that adequate venting is achieved, shall be kept on file. At the time steam is turned on, the drain should be opened for a time sufficient to remove steam condensate from the retort and provision should be made for containing drainage of condensate during the retort operation.

(7) *Retort speed timing.* The rotational speed of the retort shall be specified in the schedules process. The speed shall be adjusted, as necessary, to ensure that the speed is as specified in the scheduled process. The rotational speed as well as the process time shall be recorded for each retort load processed. Alternatively, a recording tachometer may be used to provide a continuous record of the speed. A means of preventing unauthorized speed changes on retorts shall be provided. A lock, or a notice from management posted at or near the speed-adjustment device that provides a warning that only authorized persons are permitted to make adjustments, is a satisfactory means of preventing unauthorized changes.

(8) *Critical factors.* Critical factors specified in the schedules process shall be measured and recorded on the processing record at intervals of sufficient frequency to ensure that the factors are within the limits specified in the scheduled process. The minimum headspace of containers in each retort load to be processed, if specified in the scheduled process, shall be measured and recorded at intervals of sufficient

frequency to ensure that the headspace is as specified in the scheduled process. The headspace of solder-tipped, lap seam (vent hole) cans may be measured by net weight determinations. When the product consistency is specified in the scheduled process, the consistency of the product shall be determined by objective measurements on the product taken from the filler before processing and recorded at intervals of sufficient frequency to ensure that the consistency is as specified in the scheduled process. Minimum closing machine vacuum in vacuum-packed products, maximum fill-in or drained weight, minimum net weight, and percent solids shall be as specified in the scheduled process for all products for which deviations from such specifications may affect the scheduled process. All measurements and recordings of critical factors should be made at intervals not to exceed 15 minutes.

(e) *Equipment and procedures for pressure processing in water in discontinuous agitating retorts*—(1) *Indicating mercury-in-glass thermometer*. Each retort shall be equipped with at least one mercury-in-glass thermometer whose divisions are easily readable to 1 °F and whose temperature range does not exceed 17 °F per inch of graduated scale. Thermometers shall be tested for accuracy against a known accurate standard thermometer upon installation and at least once a year thereafter, or more frequently if necessary, to ensure their accuracy. Records of thermometer accuracy checks which specify date, standard use, method used, and person performing the test should be maintained. Each thermometer should have a tag, seal, or other means of identity that includes the date on which it was last tested for accuracy. A thermometer that has a divided mercury column or that cannot be adjusted to the standard shall be repaired or replaced before further use of the retort. Thermometers shall be installed where they can be accurately and easily read. Bulbs of indicating thermometers shall be installed either within the retort shell or in external wells attached to the retort. The mercury thermometer—not the recorder chart—shall be the reference instrument for indicating the processing temperature.

(2) *Temperature-recording device*. Each retort shall have an accurate temperature-recording device. Graduations on the temperature-recording devices shall not exceed 2 °F within a range of 10 °F of the processing temperature. Each chart shall have a working scale of not more than 55 °F per inch within a range of 20 °F of the processing temperature. The temperature chart shall be adjusted to agree as nearly as possible with, but to be in no event higher than, the known accurate mercury-in-glass thermometer during the process time. A means of preventing unauthorized changes in adjustment shall be provided. A lock, or a notice from management posted at or near the recording device that provides a warning that only authorized persons are permitted to make adjustment, is a satisfactory means for preventing unauthorized changes. This recorder may be combined with the steam controller and may be a recording-controlling instrument. The temperature-recorder bulb shall be installed either within the retort shell or in a well attached to the shell. Air-operated temperature controllers should have adequate filter systems to ensure a supply of clean dry air.

(3) *Pressure gages*. Each retort should be equipped with a pressure gage which should be graduated in divisions of 2 pounds or less.

(4) *Steam controller*. Each retort shall be equipped with an automatic steam controller to maintain the retort temperature. This may be a recording-controlling instrument when combined with a recording thermometer.

(5) *Retort speed timing*. The rotational speed of the retort shall be specified in the scheduled process. The speed shall be adjusted, as necessary, to ensure that the speed is as specified in the scheduled process. The rotational speed as well as the process time shall be recorded for each retort load processed. Alternatively, a recording tachometer may be used to provide a continuous record of the speed. A means of preventing unauthorized speed changes shall be provided. A lock, or a notice from management posted at or near the speed adjustment device that provides a warning that only authorized

persons are permitted to make adjustment, is a satisfactory means of preventing unauthorized changes.

(6) *Air supply and controls.* Means shall be provided for introducing compressed air at the proper pressure and rate, which shall be controlled by an automatic pressure control unit. A check valve shall be provided in the air supply line to prevent water from entering the system.

(7) *Critical factors.* Critical factors specified in the scheduled process shall be measured and recorded on the processing record at intervals of sufficient frequency to ensure that the factors are within the limits specified in the scheduled process. The minimum headspace of containers, if specified in the scheduled process, shall be measured and recorded at intervals of sufficient frequency to ensure that the headspace is as specified in the scheduled process. The headspace of solder-tipped, lap seam (vent hole) cans may be measured by net weight determinations. When the product consistency is specified in the scheduled process, the consistency of the product shall be determined by objective measurements on the product taken from the filler before processing and recorded at intervals of sufficient frequency to ensure that the consistency is as specified in the scheduled process. Minimum closing machine vacuum in vacuum-packed products, maximum fill-in or drained weight, minimum net weight, and percent solids shall be as specified in the scheduled process for all products when deviations from such specifications may affect the scheduled process. All measurements and recordings of critical factors should be made at intervals not to exceed 15 minutes.

(f) *Equipment and procedures for pressure processing in steam in hydrostatic retorts—(1) Indicating mercury-in-glass thermometer.* Each retort shall be equipped with at least one mercury-in-glass thermometer whose divisions are easily readable to 1 °F and whose temperature range does not exceed 17 °F per inch of graduated scale. Thermometer shall be tested for accuracy against a known accurate standard thermometer upon installation and at least once a year thereafter, or more frequently if necessary, to ensure their

accuracy. Records of thermometer accuracy checks which specify date, standard used, method used, and person performing the test should be maintained. Each thermometer should have a tag, seal, or other means of identity that includes the date on which it was last tested for accuracy. A thermometer that has a divided mercury column or that cannot be adjusted to the standard shall be repaired or replaced before further use of the retort. Thermometers shall be installed where they can be accurately and easily read. The thermometer shall be located in the steam dome near the steam-water interface. When the scheduled process specifies maintenance of particular temperatures in the hydrostatic water legs, a mercury-in-glass thermometer shall be located in each hydrostatic water leg in a position near the bottom automatic recorder. The mercury thermometer—not the recorder chart—shall be the reference instrument for indicating the processing temperature.

(2) *Temperature-recording device.* Each retort shall have an accurate temperature-recording device. Graduations on the temperature-recording devices shall not exceed 2 °F within a range of 10 °F of the processing temperature. Each chart shall have a working scale of not more than 55 °F per inch within a range of 20 °F of the processing temperature. The temperature chart shall be adjusted to agree as nearly as possible with, but to be in no event higher than, the known accurate mercury-in-glass thermometer during the process time. A means of preventing unauthorized changes in adjustment shall be provided. A lock, or a notice from management posted at or near the recording device that provides a warning that only authorized persons are permitted to make adjustments, is a satisfactory means for preventing unauthorized changes. The recorder may be combined with the steam controller and may be a recording-controlling instrument. The temperature-recorder bulb shall be installed either within the steam dome or in a well attached to the dome. Each temperature-recorder bulb well shall have a 1/16-inch or larger bleeder opening which emits steam continuously during the processing period. Additional temperature-recorder

bulbs shall be installed in the hydrostatic water legs if the scheduled process specified maintenance of particular temperatures in the hydrostatic water legs. Air-operated temperature controllers should have adequate filter systems to ensure a supply of clean dry air.

(3) *Pressure gages.* Each retort should be equipped with a pressure gage which should be graduated in divisions of 2 pounds or less.

(4) *Recording of temperatures.* Temperatures indicated by the mercury-in-glass thermometer or thermometers shall be entered on a suitable form during processing operations. Temperatures shall be recorded by an accurate automatic recorder or recorders at the following points:

(i) In the steam chamber between the steam-water interface and the lowest container position.

(ii) Near the top and the bottom of each hydrostatic water leg if the scheduled process specifies maintenance of particular temperatures in the legs.

(5) *Steam controller.* Each retort shall be equipped with an automatic steam controller to maintain the retort temperature. This may be a recording-controlling instrument when combined with a recording thermometer. A steam controller activated by the steam pressure of the retort is acceptable if it is carefully mechanically maintained so that it operates satisfactorily.

(6) *Venting.* Before the start of processing operations, the retort steam chamber or chambers shall be vented to ensure removal of air.

(7) *Bleeders.* Bleeder openings $\frac{1}{4}$ -inch or larger shall be located at the top of the steam chamber or chambers opposite the point of steam entry. Bleeders shall be wide open and shall emit steam continuously during the entire process, including the come-up-time. All bleeders shall be arranged in such a way that the operator can observe that they are functioning properly.

(8) *Retort speed.* The speed of the container-conveyor chain shall be specified in the scheduled process and shall be determined and recorded at the start of processing and at intervals of sufficient frequency to ensure that the retort speed is maintained as specified.

The speed should be determined and recorded every 4 hours. An automatic device should be used to stop the chain when the temperature drops below that specified in the scheduled process. A means of preventing unauthorized speed changes shall be provided. A lock, or a notice from management posted at or near the speed-adjusting device that provides a warning that only authorized persons are permitted to make adjustments, is a satisfactory means of preventing unauthorized changes.

(9) *Critical factors.* Critical factors specified in the scheduled process shall be measured and recorded on the processing record at intervals of sufficient frequency to ensure that the factors are within the limits specified in the scheduled process.

(i) When maximum fill-in or drained weight is specified in the scheduled process, it shall be measured and recorded at intervals of sufficient frequency to ensure that the weight of the product does not exceed the maximum for the given container size specified in the scheduled process.

(ii) Closing machine vacuum in vacuum-packed products shall be observed and recorded at intervals of sufficient frequency to ensure that the vacuum is as specified in the scheduled process.

(iii) Such measurements and recordings should be made at intervals not to exceed 15 minutes.

(g) *Aseptic processing and packaging systems—(1) Product sterilizer—(i) Equipment—(a) Temperature-indicating device.* Each product sterilizer shall be equipped with at least one mercury-in-glass thermometer or an equivalent temperature-indicating device, such as a thermocouple-recorder. Mercury-in-glass thermometers shall have divisions that are easily readable to 1 °F and whose temperature range does not exceed 17 °F per inch of graduated scale. Thermometers and temperature-indicating devices shall be tested for accuracy against a known accurate standard thermometer upon installation and at least once a year thereafter, or more frequently if necessary, to ensure their accuracy. Records of accuracy checks which specify date, standard used, method used, and person

performing the test should be maintained. Each thermometer and temperature-indicating device should have a tag, seal, or other means of identity that includes the date on which it was last tested for accuracy. A thermometer that has a divided mercury column or that cannot be adjusted to essential agreement with the standard shall be repaired or replaced. Thermometers and temperature-indicating devices shall be installed where they can be accurately and easily read. The temperature-indicating device shall be the reference instrument for indicating the processing temperature.

(b) *Temperature-recording device.* There shall be an accurate temperature recording device on each product sterilizer. The device shall be installed in the product at the holding-tube outlet between the holding tube and the inlet to the cooler. Temperature-recording devices shall have graduations that do not exceed 2 °F within a range of 10 °F of the processing temperature. Each chart shall have a working scale of not more than 55 °F per inch within a range of 20 °F of the desired product-sterilization temperature. The temperature chart shall be adjusted to agree as nearly as possible with, but to be in no event higher than, a known accurate mercury-in-glass thermometer. A means of preventing unauthorized changes in adjustment shall be provided. A lock; or a notice from management posted at or near the recording device that provides a warning that only authorized persons are permitted to make adjustments, is a satisfactory means of preventing unauthorized changes.

(c) *Temperature recorder-controller.* An accurate temperature recorder-controller shall be located in the product sterilizer at the final heater outlet. It shall be capable of ensuring that the desired product sterilization temperature is maintained. The chart graduations shall not exceed 2 °F within a range of 10 °F of the desired product sterilization temperature. Air-operated temperature controllers should have adequate filter systems to ensure a supply of clean, dry air.

(d) *Product-to-product regenerators.* When a product-to-product regenerator is used to heat the cold unsterilized

product entering the sterilizer by means of a heat exchange system, it shall be designed, operated, and controlled so that the pressure of the sterilized product in the regenerator is greater than the pressure of any unsterilized product in the regenerator to ensure that any leakage in the regenerator is from the sterilized product into the unsterilized product.

(e) *Differential pressure recorder-controller.* When a product-to-product regenerator is used, there shall be an accurate differential pressure recorder-controller installed on the regenerator. The scale divisions shall not exceed 2 pounds per square inch on the working scale of not more than 20 pounds per square inch per inch. The controller shall be tested for accuracy against a known accurate standard pressure indicator upon installation and at least once every 3 months of operation thereafter, or more frequently if necessary, to ensure its accuracy. One pressure sensor shall be installed at the sterilized product regenerator outlet and the other pressure sensor shall be installed at the unsterilized product regenerator inlet.

(f) *Metering pump.* A metering pump shall be located upstream from the holding tube and shall be operated to maintain the required rate of product flow. A means of preventing unauthorized speed changes shall be provided. A lock, or a notice from management posted at or near the speed-adjusting device that provides a warning that only authorized persons are permitted to make adjustments, is a satisfactory means of preventing unauthorized changes.

(g) *Product holding tube.* The product-sterilizing holding tube shall be designed to give continuous holding of every particle of food for at least the minimum holding time specified in the scheduled process. The holding tube shall be designed so that no portion of the tube between the product inlet and the product outlet can be heated, and it must be sloped upward at least 0.25 inch per foot.

(h) *Flow-diversion systems.* If a processor elects to install a flow-diversion system, it should be installed in the product piping located between the product cooler and the product filler or

aseptic surge tank and should be designed to divert flow away from the filler or aseptic surge tank automatically. Controls and/or warning systems should be designed and installed with necessary sensors and actuators to operate whenever the sterilizing temperature in the holding tube or pressure differential in the product regenerator drops below specified limits. Flow-diversion systems should be designed and operated in accordance with recommendations of an aseptic processing and packaging authority.

(i) *Equipment downstream from the holding tube.* Product coolers, aseptic surge tanks, or any other equipment downstream from the holding tube, with rotating or reciprocating shafts, valve stems, instrument connections, or other such points, are subject to potential entry of microorganisms into the product. Such locations in the system should be equipped with steam seals or other effective barriers at the potential access points. Appropriate means should be provided to permit the operator to monitor the performance of the seals or barriers during operations.

(ii) *Operation—(a) Startup.* Before the start of aseptic processing operations the product sterilizer and all product-contact surfaces downstream shall be brought to a condition of commercial sterility.

(b) *Temperature drop in product-sterilizing holding tube.* When product temperature in the holding tube drops below the temperature specified in the scheduled process, product flow should be diverted away from the filler or aseptic surge tank by means of a flow-diversion system. If for any reason product subjected to a temperature drop below the scheduled process is filled into containers, the product shall be segregated from product that received the scheduled process. The processing deviation shall be handled in accordance with §113.89. The product holding tube and any further system portions affected shall be returned to a condition of commercial sterility before product flow is resumed to the filler or to the aseptic surge tank.

(c) *Loss of proper pressures in the regenerator.* When a regenerator is used, the product may lose sterility whenever the pressure of sterilized product

in the regenerator is less than 1 pound per square inch greater than the pressure of unsterilized product in the regenerator. In this case, product flow should be diverted away from the filler or aseptic surge tank by means of the flow-diversion system. If for any reason the product is filled into containers, the product shall be segregated from product that received the scheduled process and shall be reprocessed or destroyed. Product flow to the filler or to the aseptic surge tank shall not be resumed until the cause of the improper pressure relationships in the regenerator has been corrected and the affected system(s) has been returned to a condition of commercial sterility.

(d) *Loss of sterile air pressure or other protection level in the aseptic surge tank.* When an aseptic surge tank is used, conditions of commercial sterility may be lost when the sterile air overpressure or other means of protection drops below the scheduled process value. Product flow to and/or from the aseptic surge tank shall not be resumed until the potentially contaminated product in the tank is removed, and the aseptic surge tank has been returned to a condition of commercial sterility.

(e) *Records.* Readings at the following points shall be observed and recorded at the start of aseptic packaging operations and at intervals of sufficient frequency to ensure that these values are as specified in the scheduled process: Temperature-indicating device in holding tube outlet; temperature recorder in holding tube outlet; temperature recorder-controller at final heater outlet; differential pressure recorder-controller, if a product-to-product regenerator is used; product flow rate as established by the metering pump or as determined by filling and closing rates and, if an aseptic surge tank is used, sterile air pressure or other protection means; and proper performance of seam seals or other similar devices. The measurements and recordings should be made at intervals not to exceed 1 hour.

(2) *Container sterilizing, filling, and closing operation—(i) Equipment—(a) Recording device.* The container and closure sterilization system and product

filling and closing system shall be instrumented to demonstrate that the required sterilization is being accomplished continuously. Automatic recording devices shall be used to record, when applicable, the sterilization media flow rates, temperature, concentration, or other factors. When a batch system is used for container sterilization, the sterilization conditions shall be recorded.

(b) *Timing method(s)*. A method(s) shall be used either to give the retention time of containers, and closures if applicable, in the sterilizing environment specified in the scheduled process, or to control the sterilization cycle at the rate specified in the scheduled process. A means of preventing unauthorized speed changes must be provided. A lock, or a notice from management posted at or near the speed adjusting device that provides a warning that only authorized persons are permitted to make adjustments, is a satisfactory means of preventing unauthorized changes.

(ii) *Operation—(a) Startup*. Before the start of packaging operations, both the container and closure sterilizing system and the product filling and closing system shall be brought to a condition of commercial sterility.

(b) *Loss of sterility*. A system shall be provided to stop packaging operations, or alternatively to ensure segregation of any product packaged when the packaging conditions fall below scheduled processes. Compliance with this requirement may be accomplished by diverting product away from the filler, by preventing containers from entering the filler, or by other suitable means. In the event product is packaged under conditions below those specified in the scheduled process, all such product shall be segregated and handled in accordance with § 113.89. In the event of loss of sterility, the system(s) shall be returned to a condition of commercial sterility before resuming packaging operations.

(c) *Records*. Observations and measurements of operating conditions shall be made and recorded at intervals of sufficient frequency to ensure that commercial sterility of the food product is being achieved; such measurements shall include the sterilization

media flow rates, temperatures, the container and closure rates (if applicable) through the sterilizing system, and the sterilization conditions if a batch system is used for container sterilization. The measurements and recordings should be made at intervals not to exceed 1 hour.

(3) *Incubation*. Incubation tests should be conducted on a representative sample of containers of product from each code; records of the test results should be maintained.

(4) *Critical factors*. Critical factors specified in the scheduled process shall be measured and recorded on the processing record at intervals of sufficient frequency to ensure that the factors are within the limits specified in the scheduled process. Such measurements and recordings should be done at intervals not to exceed 15 minutes.

(h) *Equipment and procedures for flame sterilizers*. The container conveyor speed shall be specified in the scheduled process. The container conveyor speed shall be measured and recorded at the start of operations and at intervals of sufficient frequency to ensure that the conveyor speed is as specified in the scheduled process. Such measurements and recordings should be done at 1-hour intervals. Alternatively, recording tachometer may be used to provide a continuous record of the speed. A means of preventing changes in flame intensity and unauthorized speed changes on the conveyor shall be provided. A lock, or a notice from management posted at or near the speed adjusting device that provides a warning that only authorized persons are permitted to make adjustments, is a satisfactory means of preventing unauthorized changes. The surface temperature of at least one container from each conveyor channel shall be measured and recorded at the entry and at the end of the holding period at intervals of sufficient frequency to ensure that the temperatures specified in the scheduled process are maintained. Such measurements and recordings should be done at intervals not to exceed 15 minutes.

(1) *Process interruption*. In the event of process interruption wherein the temperature of the product may have dropped, an authorized, scheduled

emergency plan approved by a qualified person having expert knowledge of the process requirements may be used.

(2) *Critical factors.* Critical factors specified in the scheduled process shall be measured and recorded on the processing record at intervals of sufficient frequency to ensure that the factors are within the limits specified in the scheduled process.

(i) *Equipment and procedures for thermal processing of foods wherein critical factors such as water activity are used in conjunction with thermal processing.* The methods and controls used for the manufacture, processing, and packing of such foods shall be as established in the scheduled process and shall be operated or administered in a manner adequate to ensure that the product is safe. The time and temperature of processing and other critical factors specified in the scheduled process shall be measured with instruments having the accuracy and dependability adequate to ensure that the requirements of the scheduled process are met. All measurements shall be made and recorded at intervals of sufficient frequency to ensure that the critical factors are within the limits specified in the scheduled process.

(j) *Other systems.* All systems, whether or not specifically mentioned in this part, for the thermal processing of low-acid foods in hermetically sealed containers shall conform to the applicable requirements of this part and the methods and controls used for the manufacture, processing, and packing of these foods shall be as established in the scheduled process. These systems shall be operated or administered in a manner adequate to ensure that commercial sterility is achieved. Critical factors specified in the scheduled process shall be measured and recorded at intervals of sufficient frequency to ensure that the critical factors are within the limits specified in the scheduled process.

[44 FR 16215, Mar. 16, 1979, as amended at 62 FR 31722, June 11, 1997]

Subpart D—Control of Components, Food Product Containers, Closures, and In-Process Materials

§ 113.60 Containers.

(a) *Closures.* Regular observations shall be maintained during production runs for gross closure defects. Any such defects shall be recorded and corrective action taken and recorded. At intervals of sufficient frequency to ensure proper closure, the operator, closure supervisor, or other qualified container closure inspection person shall visually examine either the top seam of a can randomly selected from each seaming head or the closure of any other type of container being used and shall record the observations made. For double-seam cans, each can should be examined for cutover or sharpness, skidding or deadheading, false seam, droop at the crossover or lap, and condition of inside of countersink wall for evidence of broken chuck. Such measurements and recordings should be made at intervals not to exceed 30 minutes. Additional visual closure inspections shall be made immediately following a jam in a closing machine, after closing machine adjustment, or after startup of a machine following a prolonged shutdown. All pertinent observations shall be recorded. When irregularities are found, the corrective action shall be recorded.

(1) Teardown examinations for double-seam cans shall be performed by a qualified individual and the results therefrom shall be recorded at intervals of sufficient frequency on enough containers from each seaming station to ensure maintenance of seam integrity. Such examinations and recordings should be made at intervals not to exceed 4 hours. The results of the teardown examinations shall be recorded and the corrective action taken, if any, shall be noted.

(i) Required and optional can seam measurements:

(a) Micrometer measurement system:

Required	Optional
Cover hook	Overlap (by calculation).
Body hook	Countersink.
Width (length, height)	
Tightness (observation for wrinkle)	

§ 113.60

Required	Optional
Thickness	

(b) Seam scope or projector:

21 CFR Ch. I (4-1-07 Edition)

Required	Optional
Body hook Overlap Tightness (observation for wrinkle) Thickness by micrometer	Width (length, height). Cover hook. Countersink.

(c) Can double seam terminology:

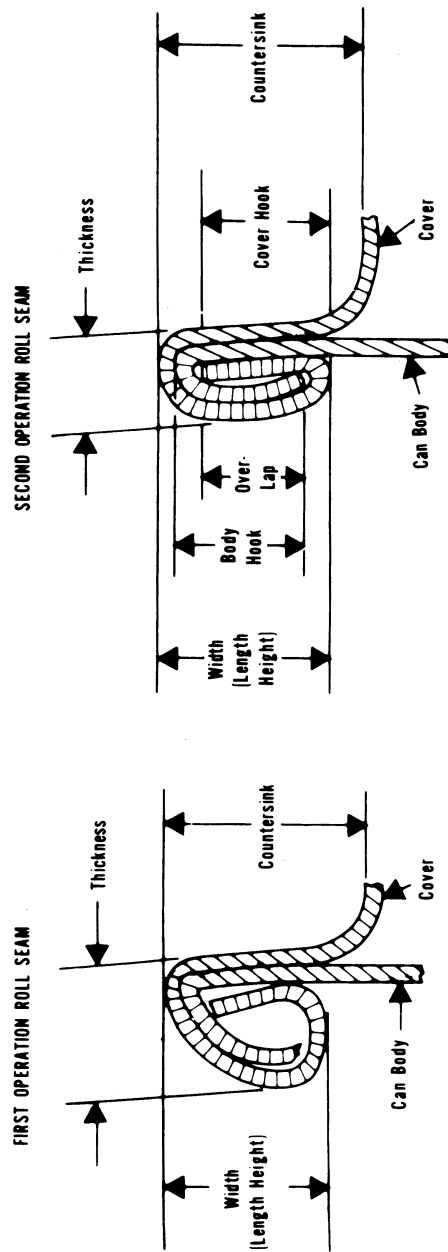

(1) "Crossover": The portion of a double seam at the lap.

(2) "Cutover": A fracture, sharp bend, or break in the metal at the top of the inside portion of the double seam.

§ 113.81

21 CFR Ch. I (4-1-07 Edition)

(3) "Deadhead": A seam which is incomplete due to chuck spinning in the countersink.

(4) "Droop": Smooth projection of double seam below bottom of normal seam.

(5) "False seam": A small seam breakdown where the cover hook and the body hook are not overlapped.

(6) "Lap": Two thicknesses of material bonded together.

(ii) Two measurements at different locations, excluding the side seam, shall be made for each double seam characteristic if a seam scope or seam projector is used. When a micrometer is used, three measurements shall be made at points approximately 120° apart, excluding the side seam.

(iii) Overlap length can be calculated by the following formula:

The theoretical overlap length=CH+BH+T - W, where

- CH=cover hook
- BH=body hook
- T=cover thickness, and
- W=seam width (height, length)

(2) For glass containers with vacuum closures, capper efficiency must be checked by a measurement of the cold water vacuum. This shall be done before actual filling operations, and the results shall be recorded.

(3) For closures other than double seams and glass containers, appropriate detailed inspections and tests shall be conducted by qualified personnel at intervals of sufficient frequency to ensure proper closing machine performance and consistently reliable hermetic seal production. Records of such tests shall be maintained.

(b) *Cooling water.* Container cooling water shall be chlorinated or otherwise sanitized as necessary for cooling canals and for recirculated water supplies. There should be a measurable residual of the sanitizer employed at the water discharge point of the container cooler.

(c) *Coding.* Each hermetically sealed container of low-acid processed food shall be marked with an identifying code that shall be permanently visible to the naked eye. When the container does not permit the code to be embossed or inked, the label may be leg-

ibly perforated or otherwise marked, if the label is securely affixed to the product container. The required identification shall identify in code the establishment where packed, the product contained therein, the year packed, the day packed, and the period during which packed. The packing period code shall be changed with sufficient frequency to enable ready identification of lots during their sale and distribution. Codes may be changed on the basis of one of the following: intervals of 4 to 5 hours; personnel shift changes; or batches, as long as the containers that constitute the batch do not extend over a period of more than one personnel shift.

(d) *Postprocess handling.* When cans are handled on belt conveyors, the conveyors should be so constructed as to minimize contact by the belt with the double seam, i.e., cans should not be rolled on the double seam. All worn and frayed belting, can retarders, cushions, etc. should be replaced with new nonporous material. All tracks and belts that come into contact with the can seams should be thoroughly scrubbed and sanitized at intervals of sufficient frequency to avoid product contamination. Automatic equipment used in handling filled containers should be so designed and operated as to preserve the can seam or other container closure integrity.

Subpart E—Production and Process Controls

§ 113.81 Product preparation.

(a) Before using raw materials and ingredients susceptible to microbiological contamination, the processor shall ensure that those materials and ingredients are suitable for use in processing low-acid food. Compliance with this requirement may be accomplished by receiving the raw materials and ingredients under a supplier's guarantee that they are suitable for use, by examining them for their microbiological condition, or by other acceptable means.

(b) Blanching by heat, when required in the preparation of food for canning, should be effected by heating the food to the required temperature, holding it at this temperature for the required

time, and then either rapidly cooling the food or passing it to subsequent processing without delay. Thermophilic growth and contamination in blanchers should be minimized by the use of adequate operating temperatures and by cleaning. If the blanched food product is washed before filling, potable water should be used.

(c) The filling of containers, either mechanically or by hand, shall be controlled so as to ensure that the filling requirements specified in the scheduled process are met.

(d) The exhausting of containers for the removal of air shall be controlled so as to meet the conditions for which the process was designed. Compliance with the requirement may be accomplished by heat exhausting, mechanical exhausting, hot brining, or steam injection.

(e) When the maintenance of pH (above 4.6) of a normally low-acid food is a basis for a scheduled process, there shall be careful supervision to ensure that the equilibrium pH of the finished product meets that of the scheduled process. The methodology described in § 114.90 of this chapter should be used.

(f) When the scheduled process sets forth critical factors to prevent the growth of microorganisms not destroyed by the thermal process, the factors shall be carefully controlled to ensure that the limits established in the scheduled process are not exceeded. When normally low-acid foods require sufficient solute to permit safe processing at low temperatures, such as in boiling water, there shall be careful supervision to ensure that the equilibrium water activity (a_w) of the finished product meets that of the scheduled process. The scheduled thermal processes for foods having an a_w greater than 0.85 and less than the a_w that would allow the growth of spores of microorganisms of public health significance shall be sufficient to render the food free of microorganisms capable of reproducing in the food under normal nonrefrigerated conditions of storage and distribution.

§ 113.83 Establishing scheduled processes.

Scheduled processes for low-acid foods shall be established by qualified

persons having expert knowledge of thermal processing requirements for low-acid foods in hermetically sealed containers and having adequate facilities for making such determinations. The type, range, and combination of variations encountered in commercial production shall be adequately provided for in establishing the scheduled process. Critical factors, e.g., minimum headspace, consistency, maximum fill-in or drained weight, a_w , etc., that may affect the scheduled process, shall be specified in the scheduled process. Acceptable scientific methods of establishing heat sterilization processes shall include, when necessary, but shall not be limited to, microbial thermal death time data, process calculations based on product heat penetration data, and inoculated packs. Calculation shall be performed according to procedures recognized by competent processing authorities. If incubation tests are necessary for process confirmation, they shall include containers from test trials and from actual commercial production runs during the period of instituting the process. The incubation tests for confirmation of the scheduled processes should include the containers from the test trials and a number of containers from each of four or more actual commercial production runs. The number of containers from actual commercial production runs should be determined on the basis of recognized scientific methods to be of a size sufficient to ensure the adequacy of the process. Complete records covering all aspects of the establishment of the process and associated incubation tests shall be prepared and shall be permanently retained by the person or organization making the determination.

§ 113.87 Operations in the thermal processing room.

(a) Operating processes and retort venting procedures to be used for each product and container size being packed shall either be posted in a conspicuous place near the processing equipment or be made readily available to the retort or processing system operator and any duly authorized employee of the Food and Drug Administration. Scheduled processes must be

§ 113.89

21 CFR Ch. I (4-1-07 Edition)

made readily available to the supervisor and any duly authorized employee of the Food and Drug Administration.

(b) A system for product traffic control in the retort room shall be established to prevent unretorted product from bypassing the retort process. Each retort basket, truck, car, or crate used to hold containers in a retort, or one or more containers therein, shall, if it contains any retorted food product, be plainly and conspicuously marked with a heat-sensitive indicator, or by other effective means that will indicate visually, to thermal processing personnel, those units that have been retorted. A visual check shall be performed to determine whether or not the appropriate change has occurred in the heat-sensitive indicator as a result of retorting for all retort baskets, trucks, cars, or crates, to ensure that each unit of product has been retorted. A written record of these checks should be made.

(c) The initial temperature of the contents of the containers to be processed shall be determined and recorded with sufficient frequency to ensure that the temperature of the product is no lower than the minimum initial temperature specified in the scheduled process. For those operations that use water during the filling of the retort or during processing, provision shall be made to ensure that the water will not, before the start of each thermal process, lower the initial temperature of the product below that specified in the scheduled process.

(d) Timing devices used in recording thermal process time information shall be accurate to the extent needed to ensure that the processing time and venting time specified in the scheduled process are achieved. Pocket or wrist watches are not considered satisfactory for timing purposes. Digital clocks may be used if the operating process and the venting schedule have a 1-minute or greater safety factor over the scheduled process.

(e) Clock times on recording-temperature charts should reasonably correspond to the time of day on the written processing records to provide correlation of these records.

(f) The steam supply to the thermal processing system shall be adequate to the extent needed to ensure that sufficient steam pressure is maintained during thermal processing, regardless of other demands of steam by the plant.

(g) If mufflers are used on bleeders or vent systems, evidence that the bleeders or vents are operated in a manner that does not significantly impede the removal of air shall be kept on file. This evidence may be in the form of heat distribution data or other satisfactory evidence such as a letter from the manufacturer, the designer, or a competent processing authority.

§ 113.89 Deviations in processing, venting, or control of critical factors.

Whenever any process is less than the scheduled process or when critical factors are out of control for any low-acid food or container system as disclosed from records by processor check or otherwise, the commercial processor of that low-acid food shall either fully reprocess that portion of the production involved, keeping full records of the reprocessing conditions or, alternatively, must set aside that portion of the product involved for further evaluation as to any potential public health significance. Such evaluation shall be made by a competent processing authority and shall be in accordance with procedures recognized by competent processing authorities as being adequate to detect any potential hazard to public health. Unless this evaluation demonstrates that the product had been given a thermal process that rendered it free of microorganisms of potential public health significance, the product set aside shall be either fully reprocessed to render it commercially sterile or destroyed. A record shall be made of the evaluation procedures used and the results. Either upon completion of full reprocessing and the attainment of commercial sterility or after the determination that no significant potential for public health hazard exists, that portion of the product involved may be shipped in normal distribution. Otherwise, the portion of the product involved shall be destroyed. All process deviations involving a failure to satisfy the minimum requirements of the

scheduled process, including emergencies arising from a jam or breakdown of a continuous agitating retort necessitating cooling the retort for repairs, shall be recorded and made the subject of a separate file (or a log identifying the appropriate data) detailing those deviations and the actions taken.

Subpart F—Records and Reports

§ 113.100 Processing and production records.

(a) Processing and production information shall be entered at the time it is observed by the retort or processing system operator, or other designated person, on forms that include the product, the code number, the date, the retort or processing system number, the size of container, the approximate number of containers per coding interval, the initial temperature, the actual processing time, the mercury-in-glass and recording thermometer readings, and other appropriate processing data. Closing machine vacuum in vacuum-packed products, maximum fill-in or drained weight, or other critical factors specified in the scheduled process shall also be recorded. In addition, the following records shall be maintained:

(1) *Still retorts.* Time steam on; time temperature up to processing temperature; time steam off; venting time and temperature to which vented.

(2) *Agitating retorts.* Functioning of condensate bleeder; retort speed; and, when specified in the scheduled process, headspace, consistency, maximum drained weight, minimum net weight, and percent solids.

(3) *Hydrostatic retorts.* The temperature in the steam chamber between the steam-water interface and the lowest container position; speed of the container conveyor chain; and, when the scheduled process specifies maintenance of particular temperatures in the hydrostatic water legs, the temperatures near the top and the bottom of each hydrostatic water leg.

(4) *Aseptic processing and packaging systems.* Product temperature in the holding tube outlet as indicated by the temperature-indicating device and the temperature recorder; product temperature in the final heater outlet as indicated by the temperature recorder-

controller; differential pressure as indicated by the differential pressure recorder-controller, if a product-to-product regenerator is used; product flow rate, as determined by the metering pump or by filling and closing rates; sterilization media flow rate or temperature or both; retention time of containers, and closures when applicable, in the sterilizing environment; and, when a batch system is used for container and/or closure sterilization, sterilization cycle times and temperatures.

(5) *Flame sterilizers.* Container conveyor speed; surface temperature at the beginning and at the end of the holding period; nature of container.

(6) *Food preservation methods wherein critical factors such as water activity are used in conjunction with thermal processing.* Product formulation and scheduled processes used, including the thermal process, its associated critical factors, as well as other critical factors, and results of a_w determinations.

(7) *Other systems.* Critical factors specified in the formulation of the product or in the scheduled process.

(b) Recording thermometer charts shall be identified by date, retort number, and other data as necessary, so they can be correlated with the written record of lots processed. Each entry on the processing and production records shall be made by the retort or processing system operator, or other designated person, at the time the specific retort or processing system condition or operation occurs, and this retort or processing system operator or other designated person shall sign or initial each record form. Not later than 1 working day after the actual process, and before shipment or release for distribution, a representative of plant management who is qualified by suitable training or experience shall review all processing and production records for completeness and to ensure that the product received the scheduled process. The records, including the recording thermometer chart(s), shall be signed or initialed and dated by the reviewer.

(c) Written records of all container closure examinations shall specify the

product code, the date and time of container closure inspections, the measurements obtained, and all corrective actions taken. Records shall be signed or initialed by the container closure inspector and reviewed by management with sufficient frequency to ensure that the containers are hermetically sealed.

(d) Records shall be maintained to identify the initial distribution of the finished product to facilitate, when necessary, the segregation of specific food lots that may have become contaminated or otherwise rendered unfit for their intended use.

(e) Copies of all records provided for in this part, except those required under §113.83 establishing scheduled processes, shall be retained at the processing plant for a period of not less than 1 year from the date of manufacture, and at the processing plant or other reasonably accessible location for an additional 2 years. If, during the first year of the 3-year record-retention period, the processing plant is closed for a prolonged period between seasonal packs, the records may be transferred to some other reasonably accessible location at the end of the seasonal pack.

PART 114—ACIDIFIED FOODS

Subpart A—General Provisions

Sec.

114.3 Definitions.

114.5 Current good manufacturing practices.

114.10 Personnel.

Subparts B–D [Reserved]

Subpart E—Production and Process Controls

114.80 Processes and controls.

114.83 Establishing scheduled processes.

114.89 Deviations from scheduled procedures.

114.90 Methodology.

Subpart F—Records and Reports

114.100 Records.

AUTHORITY: 21 U.S.C. 342, 371, 374; 42 U.S.C. 264.

SOURCE: 44 FR 16235, Mar. 16, 1979, unless otherwise noted.

Subpart A—General Provisions

§ 114.3 Definitions.

For the purposes of this part, the following definitions apply.

(a) *Acid foods* means foods that have a natural pH of 4.6 or below.

(b) *Acidified foods* means low-acid foods to which acid(s) or acid food(s) are added; these foods include, but are not limited to, beans, cucumbers, cabbage, artichokes, cauliflower, puddings, peppers, tropical fruits, and fish, singly or in any combination. They have a water activity (a_w) greater than 0.85 and have a finished equilibrium pH of 4.6 or below. These foods may be called, or may purport to be, “pickles” or “pickled _____.” Carbonated beverages, jams, jellies, preserves, acid foods (including such foods as standardized and nonstandardized food dressings and condiment sauces) that contain small amounts of low-acid food(s) and have a resultant finished equilibrium pH that does not significantly differ from that of the predominant acid or acid food, and foods that are stored, distributed, and retailed under refrigeration are excluded from the coverage of this part.

(c) *Lot* means the product produced during a period indicated by a specific code.

(d) *Low-acid foods* means any foods, other than alcoholic beverages, with a finished equilibrium pH greater than 4.6 and a water activity (a_w) greater than 0.85. Tomatoes and tomato products having a finished equilibrium pH less than 4.7 are not classed as low-acid foods.

(e) *Scheduled process* means the process selected by a processor as adequate for use under the conditions of manufacture for a food in achieving and maintaining a food that will not permit the growth of microorganisms having public health significance. It includes control of pH and other critical factors equivalent to the process established by a competent processing authority.

(f) *Shall* is used to state mandatory requirements.

(g) *Should* is used to state recommended or advisory procedures or to identify recommended equipment.

(h) *Water activity* (a_w) is a measure of the free moisture in a product and is the quotient of the water vapor pressure of the substance divided by the vapor pressure of pure water at the same temperature.

[44 FR 16235, Mar. 16, 1979, as amended at 61 FR 14245, Apr. 1, 1996]

§ 114.5 Current good manufacturing practice.

The criteria in §§ 114.10, 114.80, 114.83, 114.89, and 114.100, as well as the criteria in part 110 of this chapter, apply in determining whether an article of acidified food is adulterated (1) within the meaning of section 402(a)(3) of the act (21 U.S.C. 342(a)(3)) in that it has been manufactured under such conditions that it is unfit for food, or (2) within the meaning of section 402(a)(4) of the act (21 U.S.C. 342(a)(4)) in that it has been prepared, packed, or held under insanitary conditions whereby it may have become contaminated with filth, or whereby it may have been rendered injurious to health.

§ 114.10 Personnel.

All operators of processing and packaging systems shall be under the operating supervisions of a person who has attended a school approved by the Commissioner for giving instruction in food-handling techniques, food-protection principles, personal hygiene and plant sanitation practices, pH controls and critical factors in acidification, and who has been identified by that school as having satisfactorily completed the prescribed course of instruction. The Commissioner will consider students who have satisfactorily completed the required portions of the courses presented under § 108.35 and part 113 of this chapter before March 16, 1979, to be in compliance with the requirement of this section.

Subparts B–D [Reserved]

Subpart E—Production and Process Controls

§ 114.80 Processes and controls.

(a) *Processing operations.* The manufacturer shall employ appropriate quality control procedures to ensure that

finished foods do not present a health hazard.

(1) Acidified foods shall be so manufactured, processed, and packaged that a finished equilibrium pH value of 4.6 or lower is achieved within the time designated in the scheduled process and maintained in all finished foods. Manufacturing shall be in accordance with the scheduled process. Acidified foods shall be thermally processed to an extent that is sufficient to destroy the vegetative cells of microorganisms of public health significance and those of nonhealth significance capable of reproducing in the food under the conditions in which the food is stored, distributed, retailed and held by the user. Permitted preservatives may be used to inhibit reproduction of microorganisms of nonhealth significance (in lieu of thermal processing).

(2) Sufficient control, including frequent testing and recording of results, shall be exercised so that the finished equilibrium pH values for acidified foods are not higher than 4.6. Measurement of acidity of foods in-process may be made by potentiometric methods, titratable acidity, or colorimetric methods. If the finished equilibrium pH of the food is above 4.0, the measurement of the finished equilibrium pH shall be by a potentiometric method, and the in-process measurements by titration or colorimetry shall be related to the finished equilibrium pH. If the finished equilibrium pH is 4.0 or below, then the measurement of acidity of the final product may be made by any suitable method. Special care should be taken when food ingredients have been subjected to lye, lime, or similar high pH materials.

(3) Procedures for acidification to attain acceptable equilibrium pH levels in the final food include, but are not limited to, the following:

(i) Blanching of the food ingredients in acidified aqueous solutions.

(ii) Immersion of the blanched food in acid solutions. Although immersion of food in an acid solution is a satisfactory method for acidification, care must be taken to ensure that the acid concentration is properly maintained.

(iii) Direct batch acidification, which can be achieved by adding a known

§ 114.83

amount of an acid solution to a specified amount of food during acidification.

(iv) Direct addition of a predetermined amount of acid to individual containers during production. Liquid acids are generally more effective than solid or pelleted acids. Care must be taken to ensure that the proper amount of acid is added to each container.

(v) Addition of acid foods to low-acid foods in controlled proportions to conform to specific formulations.

(4) Testing and examinations of containers shall occur often enough to ensure that the container suitably protects the food from leakage or contamination.

(b) *Coding.* Each container or product shall be marked with an identifying code permanently visible to the naked eye. If the container does not permit the code to be embossed or inked, the label may be legibly perforated or otherwise marked, as long as the label is securely affixed to the product container. The required identification shall specify in code the establishment where the product was packed, the product contained therein, and the year, day, and period during which it was packed. The packing period code shall be changed often enough to enable ready identification of lots during their sale and distribution. Codes may be changed periodically on one of the following bases: intervals of 4 to 5 hours; personnel shift changes; or batches, as long as the containers constituting the batch do not represent those processed during more than one personnel shift.

§ 114.83 Establishing scheduled processes.

The scheduled process shall be established by a qualified person who has expert knowledge acquired through appropriate training and experience in the acidification and processing of acidified foods.

§ 114.89 Deviations from scheduled processes.

Whenever any process operation deviates from the scheduled process for any acidified food and/or the equilibrium pH of the finished product is higher

21 CFR Ch. I (4-1-07 Edition)

than 4.6, the commercial processor of the acidified food shall either: (a) Fully reprocess that portion of the food by a process established by a competent processing authority as adequate to ensure a safe product; (b) thermally process it as a low-acid food under part 113 of this chapter; or (c) set aside that portion of the food involved for further evaluation as to any potential public health significance. The evaluation shall be made by a competent processing authority and shall be in accordance with procedures recognized by competent processing authorities as being adequate to detect any potential hazard to public health. Unless the evaluation demonstrates that the food has undergone a process that has rendered it safe, the food set aside shall either be fully reprocessed to render it safe, or be destroyed. A record shall be made of the procedures used in the evaluation and the results. Either upon completion of full reprocessing and the attainment of a safe food, or after the determination that no significant potential for public health hazard exists, that portion of the food involved may be shipped in normal distribution. Otherwise, the portion of the food involved shall be destroyed.

§ 114.90 Methodology.

Methods that may be used to determine pH or acidity for acidified foods include, but are not limited to, the following:

(a) *Potentiometric method for the determination of pH—(1) Principles.* The term “pH” is used to designate the intensity or degree of acidity. The value of pH, the logarithm of the reciprocal of the hydrogen ion concentration in solution, is determined by measuring the difference in potential between two electrodes immersed in a sample solution. A suitable system consists of a potentiometer, a glass electrode, and a reference electrode. A precise pH determination can be made by making an electromotive force (emf) measurement of a standard buffer solution whose pH is known, and then comparing that measurement to an emf measurement of a sample of the solution to be tested.

(2) *Instruments.* The primary instrument for use in pH determination is the pH meter or potentiometer. For

most work, an instrument with a direct-reading pH scale is necessary. Battery and line-operated instruments are available commercially. If the line voltage is unstable, line-operated instruments should be fitted with voltage regulators to eliminate drifting of meter-scale readings. Batteries should be checked frequently to ensure proper operation of battery operated instruments. An instrument using an expanded unit scale or a digital readout system is preferred since it allows more precise measurements.

(3) *Electrodes*. The typical pH meter is equipped with a glass membrane electrode and a reference electrode or a single probe combination electrode. Various types of electrodes designed for specific uses are available. The most commonly used reference electrode is the calomel electrode, which incorporates a salt bridge filled with saturated potassium chloride solution.

(i) *Care and use of electrodes*. Calomel electrodes should be kept filled with saturated potassium chloride solution or other solution specified by the manufacturer because they may become damaged if they are allowed to dry out. For best results, electrodes should be soaked in buffer solution, distilled or deionized water, or other liquid specified by the manufacturer for several hours before using and kept ready by storing with tips immersed in distilled water or in buffer solution used for standardization. Electrodes should be rinsed with water before immersing in the standard buffers and rinsed with water or the solution to be measured next between sample determinations. A lag in meter response may indicate aging effects or fouling of the electrodes, and cleaning and rejuvenation of the electrodes may be necessary and may be accomplished by placing the electrodes in 0.1 molar sodium hydroxide solution for 1 minute and then transferring them to 0.1 molar hydrochloric acid solution for 1 minute. The cycle should be repeated two times, ending with the electrodes in the acid solution. The electrodes should then be thoroughly rinsed with water and blotted with soft tissue before proceeding with the standardization.

(ii) *Temperature*. To obtain accurate results, a uniform temperature should

be maintained for the electrodes, the standard buffer solutions, and the samples. Tests should be made at a temperature between 20° and 30 °C, the optimum being 25 °C. Any temperature determinations made without meter compensation may affect pH values. An automatic temperature compensator may be used.

(iii) *Accuracy*. The accuracy of most pH meters is stated to be approximately 0.1 pH unit, and reproducibility is usually ± 0.05 pH unit or less. Some meters permit the expansion of any pH unit range to cover the entire scale and have an accuracy of approximately ± 0.01 pH unit and a reproducibility of ± 0.005 pH units.

(4) *General procedure for determining pH*. When operating an instrument, the operator should use the manufacturer's instructions and should observe the following techniques for pH determinations:

(i) Switch the instrument on and allow the electronic components to warm up and stabilize before proceeding.

(ii) Standardize the instrument and electrodes with commercially prepared standard 4.0 pH buffer or with freshly prepared 0.05 molar potassium acid phthalate buffer solution prepared as outlined in "Official Methods of Analysis of the Association of Official Analytical Chemists" (AOAC, 13th Ed. (1980), section 50.007(c), under "Buffer Solutions for Calibration of pH Equipment—Official Final Action," which is incorporated by reference. Copies may be obtained from the AOAC INTERNATIONAL, 481 North Frederick Ave., suite 500, Gaithersburg, MD 20877, or may be examined at the National Archives and Records Administration (NARA). For information on the availability of this material at NARA, call 202-741-6030, or go to: http://www.archives.gov/federal_register/code_of_federal_regulations/ibr_locations.html. Note the temperature of the buffer solution and set the temperature compensator control at the observed temperature (room temperature is near 25 °C).

(iii) Rinse the electrodes with water and blot, but do not wipe, with soft tissue.

(iv) Immerse the tips in the buffer solution and take the pH reading, allowing about 1 minute for the meter to stabilize. Adjust the standardization control so that the meter reading corresponds to the pH of the known buffer (for example, 4.0) for the temperature observed. Rinse the electrodes with water and blot with soft tissue. Repeat procedure with fresh portions of buffer solution until the instrument remains in balance on two successive trials. To check the operation of the pH meter, check the pH reading using another standard buffer such as one having a pH of 7.0, or check it with freshly prepared 0.025 molar phosphate solution prepared as outlined in the AOAC, 13th Ed. (1980), section 50.007(e), which is incorporated by reference. The availability of this incorporation by reference is given in paragraph (a)(4)(ii) of this section. Expanded scale pH meters may be checked with pH 3.0 or pH 5.0 standard buffers. Buffers and instruments can be further checked by comparison with values obtained with a second properly standardized instrument.

(v) Indicating electrodes may be checked for proper operation by first using an acid buffer and then a base buffer. First standardize the electrodes using a pH 4.0 buffer at or near 25 °C. Standardization control should be adjusted so that the meter reads exactly 4.0. Electrodes should be rinsed with water, then blotted and immersed in a pH 9.18 borax buffer prepared as outlined in the AOAC, 13th Ed. (1980), section 50.007(f), which is incorporated by reference. The availability of this incorporation by reference is given in paragraph (a)(4)(ii) of this section. The pH reading should be within ± 0.3 units of the 9.18 value.

(vi) The pH meter can be tested for proper operation by shorting the glass and reference electrode inputs, thereby reducing the voltage to zero. In some meters this shorting is done by switching the instrument to standby, and in other instruments by use of a shorting strap. With the instrument shorted out, standardization control should be turned from one extreme to another. This operation should produce a deflection greater than ± 1.5 pH unit from center scale.

(5) *Determining pH on samples.* (i) Adjust the temperature of the sample to room temperature (25 °C), and set the temperature compensator control to the observed temperature. With some expanded scale instruments, the sample temperature must be the same as the temperature of the buffer solution used for the standardization.

(ii) Rinse and blot the electrodes. Immerse the electrodes in the sample and take the pH reading, allowing 1 minute for the meter to stabilize. Rinse and blot the electrodes and repeat on a fresh portion of sample. Oil and grease from the samples may coat the electrodes; therefore, it is advisable to clean and standardize the instrument frequently. When oily samples cause fouling problems, it may become necessary to rinse the electrodes with ethyl ether.

(iii) Determine two pH values on the well-mixed sample. These readings should agree with one another to indicate that the sample is homogeneous. Report values to the nearest 0.05 pH unit.

(6) *Preparation of samples.* Some food products may consist of a mixture of liquid and solid components that differ in acidity. Other food products may be semisolid in character. The following are examples of preparation procedures for pH testing for each of these categories:

(i) *Liquid and solid component mixtures.* Drain the contents of the container for 2 minutes on a U.S. standard No. 8 sieve (preferably stainless steel) inclined at a 17- to 20-degree angle. Record weight of the liquid and solid portions and retain each portion separately.

(a) If the liquid contains sufficient oil to cause electrode fouling, separate the layers with a separatory funnel and retain the aqueous layer. The oil layer may be discarded. Adjust the temperature of the aqueous layer to 25 °C and determine its pH.

(b) Remove the drained solids from the sieve, blend to a uniform paste, adjust the temperature of the paste to 25 °C and determine its pH.

(c) Mix aliquots of solid and liquid fractions in the same ratio as found in the original container and blend to a

uniform consistency. Adjust the temperature of the blend to 25 °C and determine the equilibrated pH. Alternatively, blend the entire contents of the container to a uniform paste, adjust the temperature of the paste to 25 °C, and determine the equilibrated pH.

(ii) *Marinated oil products.* Separate the oil from the solid product. Blend the solid in a blender to a paste consistency; it may become necessary to add a small amount of distilled water to some samples to facilitate the blending. A small amount of added water will not alter the pH of most food products, but caution must be exercised concerning poorly buffered foods. No more than 20 milliliters of distilled water should be added to each 100 grams of product. Determine the pH by immersing electrodes in the prepared paste after adjusting the temperature to 25 °C.

(iii) *Semisolid products.* Food products of a semisolid consistency, such as puddings, potato salad, etc., may be blended to a paste consistency, and the pH may be determined on the prepared paste. If more fluidity is required, 10 to 20 milliliters of distilled water may be added to 100 grams of product. Adjust the temperature of the prepared paste to 25 °C and determine its pH.

(iv) *Special product mixtures.* For special product mixtures such as anti-pasto, pour off the oil, blend the remaining product to a paste, and determine the pH of the blended paste. If more fluidity is required, add 10 to 20 milliliters of distilled water to each 100 grams of product and blend. Adjust the temperature of the prepared paste to 25 °C and determine its pH.

(7) *Process pH determination.* Obtain sample portions of material for pH determination.

(i) For process liquids, adjust the temperature of the liquid to 25 °C and determine the pH by immersing the electrodes in the liquid.

(ii) Drain solid materials on a sieve and blend to a workable paste. Adjust the temperature of the prepared paste to 25 °C and determine its pH.

(iii) If enough solid materials are available to make a paste, blend representative aliquots of liquid and solid materials to a workable paste. Adjust the temperature of the prepared paste

to 25 °C and determine the equilibrated pH. Alternatively, blend the entire contents of the container to a uniform paste, adjust the temperature of the paste to 25 °C, and determine the equilibrated pH.

(b) *Colorimetric methods for the determination of pH.* This method may be used in lieu of the potentiometric method if the pH is 4.0 or lower.

(1) *Principle.* The colorimetric method for pH involves the use of indicator dyes in solutions that gradually change color over limited pH ranges. An indicator that has the greatest color change at approximately the pH of the sample being tested is selected. The pH is determined by the color of the indicator when exposed to the sample under test.

(2) *Indicator solutions.* Most indicator solutions are prepared as a 0.04 percent solution of the indicator dye in alcohol. In testing, a few drops of indicator solution are added to 10-milliliter portions of the sample solution. Colors should be compared using a bright background. Approximate determinations can be made on white porcelain spot plates, the test colors being compared thereon with a set of color standards. More accurate colorimetric tests can be made using a comparator block fitted with sets of tubes of standard indicator solutions of known pH.

(3) *Indicator paper.* A paper tape treated with indicator dye is dipped into the sample solution. Depending upon the pH of the solution, the tape will change color and an approximate pH can be determined by comparison with a standard color chart.

(c) *Titratable acidity.* Acceptable methods for determining titratable acidity are described in the AOAC, 13th Ed. (1980), section 22.060, under "Titratable Acidity—Official Final Action," for "Indicator Method," and section 22.061 for "Glass Electrode Method—Official Final Action," which is incorporated by reference. The availability of this incorporation by reference is given in paragraph (a)(4)(ii) of this section. The procedure for preparing and standardizing the sodium hydroxide solution is described in the AOAC, 13th Ed. (1980), sections 50.032–50.035, under "Sodium Hydroxide—Official Final Action" by the "Standard

§ 114.100

Potassium Hydroxide Phthalate Method," which is also incorporated by reference and available as set forth in paragraph (a)(4)(ii) of this section.

[44 FR 16235, Mar. 16, 1979, as amended at 47 FR 11822, Mar. 19, 1982; 49 FR 5609, Feb. 14, 1984; 54 FR 24892, June 12, 1989; 63 FR 14035, Mar. 24, 1998]

Subpart F—Records and Reports

§ 114.100 Records.

(a) Records shall be maintained of examinations of raw materials, packaging materials, and finished products, and of suppliers' guarantees or certifications that verify compliance with Food and Drug Administration regulations and guidance documents or action levels.

(b) Processing and production records showing adherence to scheduled processes, including records of pH measurements and other critical factors intended to ensure a safe product, shall be maintained and shall contain sufficient additional information such as product code, date, container size, and product, to permit a public health hazard evaluation of the processes applied to each lot, batch, or other portion of production.

(c) All departures from scheduled processes having a possible bearing on public health or the safety of the food shall be noted and the affected portion of the product identified; these departures shall be recorded and made the subject of a separate file (or log identifying the appropriate data) delineating them, the action taken to rectify them, and the disposition of the portion of the product involved.

(d) Records shall be maintained identifying initial distribution of the finished product to facilitate, when necessary, the segregation of specific food lots that may have become contaminated or otherwise unfit for their intended use.

(e) Copies of all records provided for in paragraphs (b), (c), and (d) of this section shall be retained at the processing plant or other reasonably accessible location for a period of 3 years from the date of manufacture.

[44 FR 16235, Mar. 16, 1979, as amended at 65 FR 56479, Sept. 19, 2000]

21 CFR Ch. I (4–1–07 Edition)

PART 115—SHELL EGGS

AUTHORITY: 21 U.S.C. 342, 371; 42 U.S.C. 243, 264, 271.

§ 115.50 Refrigeration of shell eggs held for retail distribution.

(a) For purposes of this section a "retail establishment" is an operation that stores, prepares, packages, serves, vends, or otherwise provides food for human consumption directly to consumers.

(b) Except as provided in paragraph (c) of this section, all shell eggs, whether in intrastate or interstate commerce, held for retail distribution:

(1) Shall promptly be placed under refrigeration as specified in paragraph (b)(2) of this section upon receipt at a retail establishment, except that, when short delays are unavoidable, the eggs shall be placed under refrigeration, as soon as reasonably possible; and

(2) Shall be stored and displayed under refrigeration at an ambient temperature not greater than 7.2 °C (45 °F) while held at a retail establishment.

(c) Shell eggs that have been specifically processed to destroy all viable *Salmonella* shall be exempt from the requirements of paragraph (b) of this section.

(d) Under sections 311 and 361 of the Public Health Service Act (PHS Act), any State or locality that is willing and able to assist the agency in the enforcement of paragraph (b) of this section, and is authorized to inspect or regulate retail establishments, may, in its own jurisdiction, enforce paragraph (b) of this section through inspections under paragraph (f) of this section and through administrative enforcement remedies identified in paragraph (e) of this section until FDA notifies the State or locality in writing that such assistance is no longer needed. When providing assistance under paragraph (e) of this section, a State or locality may follow the hearing procedures set out in paragraphs (e)(2)(iii) through (e)(2)(iv) of this section, substituting, where necessary, appropriate State or local officials for designated FDA officials or may utilize State or local hearing procedures if such procedures satisfy due process.

(e) This section is established under authority of both the Federal Food, Drug, and Cosmetic Act (the act) and the PHS Act. Under the act, the agency can enforce the food adulteration provisions under 21 U.S.C. 331, 332, 333, and 334. However, 42 U.S.C. 264 provides for the issuance of implementing enforcement regulations; therefore, FDA has established the following administrative enforcement procedures for the diversion or destruction of shell eggs and for informal hearings under the PHS Act:

(1) Upon finding that any shell eggs have been held in violation of this section, an authorized FDA representative or a State or local representative in accordance with paragraph (d) of this section may order such eggs to be diverted, under the supervision of said representative, for processing in accordance with the Egg Products Inspection Act (EPIA) (21 U.S.C. 1031 *et seq.*) or destroyed by or under the supervision of an officer or employee of the FDA, or, if applicable, of the State or locality in accordance with the following procedures:

(i) *Order for diversion or destruction.* Any district office of FDA or any State or local agency acting under paragraph (d) of this section, upon finding shell eggs held in violation of this section, may serve upon the person in whose possession such eggs are found a written order that such eggs be diverted, under the supervision of an officer or employee of the issuing entity, for processing in accordance with the EPIA (21 U.S.C. 1031 *et seq.*) or destroyed by or under the supervision of said district office, within 10-working days from the date of receipt of the order.

(ii) *Issuance of order.* The order shall include the following information:

(A) A statement that the shell eggs identified in the order are subject to diversion for processing in accordance with the EPIA or destruction;

(B) A detailed description of the facts that justify the issuance of the order;

(C) The location of the eggs;

(D) A statement that these eggs shall not be sold, distributed, or otherwise disposed of or moved except as provided in paragraph (e)(1)(v) of this section;

(E) Identification or description of the eggs;

(F) The order number;

(G) The date of the order;

(H) The text of this entire section;

(I) A statement that the order may be appealed by written appeal or by requesting an informal hearing;

(J) The name and phone number of the person issuing the order; and

(K) The location and telephone number of the office or agency and the name of its director.

(iii) *Approval of District Director.* An order, before issuance, shall be approved by the Food and Drug Administration (FDA) District Director in whose district the shell eggs are located. If prior written approval is not feasible, prior oral approval shall be obtained and confirmed by written memorandum as soon as possible.

(iv) *Labeling or marking of shell eggs under order.* An FDA, State, or local agency representative issuing an order under paragraph (e)(1) of this section shall label or mark the shell eggs with official tags that include the following information:

(A) A statement that the shell eggs are detained in accordance with regulations issued under section 361(a) of the PHS Act (42 U.S.C. 264(a)).

(B) A statement that the shell eggs shall not be sold, distributed or otherwise disposed of or moved except, after notifying the issuing entity in writing, to:

(1) Divert them for processing in accordance with the EPIA or destroy them; or

(2) Move them to an another location for holding pending appeal.

(C) A statement that the violation of the order or the removal or alteration of the tag is punishable by fine or imprisonment or both (section 368 of the PHS Act, 42 U.S.C. 271).

(D) The order number and the date of the order, and the name of the government representative who issued the order.

(v) *Sale or other disposition of shell eggs under order.* After service of the order, the person in possession of the shell eggs that are the subject of the order shall not sell, distribute, or otherwise dispose of or move any eggs subject to the order unless and until the notice is

withdrawn after an appeal except, after notifying FDA's district office or, if applicable, the State or local agency in writing, to:

(A) Divert or destroy them as specified in paragraph (e)(1)(i) of this section; or

(B) Move them to another location for holding pending appeal.

(2) The person on whom the order for diversion or destruction is served may either comply with the order or appeal the order to the FDA Regional Food and Drug Director in accordance with the following procedures:

(i) *Appeal of a detention order.* Any appeal shall be submitted in writing to FDA's District Director in whose district the shell eggs are located within 5-working days of the issuance of the order. If the appeal includes a request for an informal hearing, the hearing shall be held within 5-working days after the appeal is filed or, if requested by the appellant, at a later date, which shall not be later than 20-calendar days after the issuance of the order. The order may also be appealed within the same period of 5-working days by any other person having an ownership or proprietary interest in such shell eggs. The appellant of an order shall state the ownership or proprietary interest the appellant has in the shell eggs.

(ii) *Summary decision.* A request for a hearing may be denied, in whole or in part and at any time after a request for a hearing has been submitted, if the FDA Regional Food and Drug Director or his or her designee determines that no genuine and substantial issue of fact has been raised by the material submitted in connection with the hearing or from matters officially noticed. If the FDA Regional Food and Drug Director determines that a hearing is not justified, written notice of the determination will be given to the parties explaining the reason for denial.

(iii) *Informal hearing.* Appearance by any appellant at the hearing may be by mail or in person, with or without counsel. The informal hearing shall be conducted by the FDA Regional Food and Drug Director or his designee, and a written summary of the proceedings shall be prepared by the FDA Regional Food and Drug Director.

(A) The FDA Regional Food and Drug Director may direct that the hearing be conducted in any suitable manner permitted by law and this section. The FDA Regional Food and Drug Director has the power to take such actions and make such rulings as are necessary or appropriate to maintain order and to conduct an informal fair, expeditious, and impartial hearing, and to enforce the requirements concerning the conduct of hearings.

(B) Employees of FDA will first give a full and complete statement of the action which is the subject of the hearing, together with the information and reasons supporting it, and may present oral or written information relevant to the hearing. The party requesting the hearing may then present oral or written information relevant to the hearing. All parties may conduct reasonable examination of any person (except for the presiding officer and counsel for the parties) who makes any statement on the matter at the hearing.

(C) The hearing shall be informal in nature, and the rules of evidence do not apply. No motions or objections relating to the admissibility of information and views will be made or considered, but any party may comment upon or rebut any information and views presented by another party.

(D) The party requesting the hearing may have the hearing transcribed, at the party's expense, in which case a copy of the transcript is to be furnished to FDA. Any transcript of the hearing will be included with the FDA Regional Food and Drug Director's report of the hearing.

(E) The FDA Regional Food and Drug Director shall prepare a written report of the hearing. All written material presented at the hearing will be attached to the report. Whenever time permits, the FDA Regional Food and Drug Director may give the parties the opportunity to review and comment on the report of the hearing.

(F) The FDA Regional Food and Drug Director shall include as part of the report of the hearing a finding on the credibility of witnesses (other than expert witnesses) whenever credibility is a material issue, and shall include a recommended decision, with a statement of reasons.

(iv) *Written appeal.* If the appellant appeals the detention order but does not request a hearing, the FDA Regional Food and Drug Director shall render a decision on the appeal affirming or revoking the detention within 5-working days after the receipt of the appeal.

(v) *Regional Food and Drug Director decision.* If, based on the evidence presented at the hearing or by the appellant in a written appeal, the Regional Food and Drug Director finds that the shell eggs were held in violation of this section, he shall affirm the order that they be diverted, under the supervision of an officer or employee of the FDA for processing under the EPIA or destroyed by or under the supervision of an officer or employee of the FDA; otherwise, the Regional Food and Drug Director shall issue a written notice that the prior order is withdrawn. If the Regional Food and Drug Director affirms the order he shall order that the diversion or destruction be accomplished within 10-working days from the date of the issuance of his decision. The Regional Food and Drug Director's decision shall be accompanied by a statement of the reasons for the decision. The decision of the Regional Food and Drug Director shall constitute final agency action, reviewable in the courts.

(vi) *No appeal.* If there is no appeal of the order and the person in possession of the shell eggs that are subject to the order fails to divert or destroy them within 10-working days, or if the demand is affirmed by the Regional Food and Drug Director after an appeal and the person in possession of such eggs fails to divert or destroy them within 10-working days, FDA's district office or appropriate State or local agency may designate an officer or employee to divert or destroy such eggs. It shall be unlawful to prevent or to attempt to prevent such diversion or destruction of the shell eggs by the designated officer or employee.

(f) *Inspection.* Persons engaged in retail distribution of shell eggs shall permit authorized representatives of FDA to make at any reasonable time such inspection of the retail establishment in which shell eggs are being held, including inspection and sampling of

such eggs and the equipment in which shell eggs are held and any records relating to such equipment or eggs, as may be necessary in the judgement of such representatives to determine compliance with the provisions of this section. Inspections may be made with or without notice and will ordinarily be made during regular business hours.

(g) *Preemption.* No State or local governing entity shall establish or continue in effect any law, rule, regulation, or other requirement allowing refrigeration of unpasteurized shell eggs at retail establishments at any temperature greater than 7.2 °C (45 °F).

[65 FR 76112, Dec. 5, 2000]

PART 119—DIETARY SUPPLEMENTS THAT PRESENT A SIGNIFICANT OR UNREASONABLE RISK

AUTHORITY: 21 U.S.C. 321, 342, 343, 371.

§ 119.1 Dietary supplements containing ephedrine alkaloids.

Dietary supplements containing ephedrine alkaloids present an unreasonable risk of illness or injury under conditions of use recommended or suggested in the labeling, or if no conditions of use are recommended or suggested in the labeling, under ordinary conditions of use. Therefore, dietary supplements containing ephedrine alkaloids are adulterated under section 402(f)(1)(A) of the Federal Food, Drug, and Cosmetic Act.

[69 FR 6853, Feb. 11, 2004]

PART 120—HAZARD ANALYSIS AND CRITICAL CONTROL POINT (HACCP) SYSTEMS

Subpart A—General Provisions

- Sec.
- 120.1 Applicability.
 - 120.3 Definitions.
 - 120.5 Current good manufacturing practice.
 - 120.6 Sanitation standard operating procedures.
 - 120.7 Hazard analysis.
 - 120.8 Hazard Analysis and Critical Control Point (HACCP) plan.
 - 120.9 Legal basis.
 - 120.10 Corrective actions.
 - 120.11 Verification and validation.
 - 120.12 Records.

§ 120.1

- 120.13 Training.
120.14 Application of requirements to imported products.

Subpart B—Pathogen Reduction

- 120.20 General.
120.24 Process controls.
120.25 Process verification for certain processors.

AUTHORITY: 21 U.S.C. 321, 342, 343, 346, 348, 371, 374, 379e, 381, 393; 42 U.S.C. 241, 242l, 264.

SOURCE: 66 FR 6197, Jan. 19, 2001, unless otherwise noted.

Subpart A—General Provisions

§ 120.1 Applicability.

(a) Any juice sold as such or used as an ingredient in beverages shall be processed in accordance with the requirements of this part. Juice means the aqueous liquid expressed or extracted from one or more fruits or vegetables, purees of the edible portions of one or more fruits or vegetables, or any concentrates of such liquid or puree. The requirements of this part shall apply to any juice regardless of whether the juice, or any of its ingredients, is or has been shipped in interstate commerce (as defined in section 201(b) of the Federal Food, Drug, and Cosmetic Act, 21 U.S.C. 321(b)). Raw agricultural ingredients of juice are not subject to the requirements of this part. Processors should apply existing agency guidance to minimize microbial food safety hazards for fresh fruits and vegetables in handling raw agricultural products.

(b) The regulations in this part shall be effective January 22, 2002. However, by its terms, this part is not binding on small and very small businesses until the dates listed in paragraphs (b)(1) and (b)(2) of this section.

(1) For small businesses employing fewer than 500 persons the regulations in this part are binding on January 21, 2003.

(2) For very small businesses that have either total annual sales of less than \$500,000, or if their total annual sales are greater than \$500,000 but their total food sales are less than \$50,000; or the person claiming this exemption employed fewer than an average of 100 full-time equivalent employees and fewer than 100,000 units of juice were

21 CFR Ch. I (4–1–07 Edition)

sold in the United States, the regulations are binding on January 20, 2004.

§ 120.3 Definitions.

The definitions of terms in section 201 of the Federal Food, Drug, and Cosmetic Act, §101.9(j)(18)(vi), and part 110 of this chapter are applicable to such terms when used in this part, except where redefined in this part. The following definitions shall also apply:

(a) *Cleaned* means washed with water of adequate sanitary quality.

(b) *Control* means to prevent, eliminate, or reduce.

(c) *Control measure* means any action or activity to prevent, reduce to acceptable levels, or eliminate a hazard.

(d) *Critical control point* means a point, step, or procedure in a food process at which a control measure can be applied and at which control is essential to reduce an identified food hazard to an acceptable level.

(e) *Critical limit* means the maximum or minimum value to which a physical, biological, or chemical parameter must be controlled at a critical control point to prevent, eliminate, or reduce to an acceptable level the occurrence of the identified food hazard.

(f) *Culled* means separation of damaged fruit from undamaged fruit. For processors of citrus juices using treatments to fruit surfaces to comply with §120.24, *culled* means undamaged, tree-picked fruit that is U.S. Department of Agriculture choice or higher quality.

(g) *Food hazard* means any biological, chemical, or physical agent that is reasonably likely to cause illness or injury in the absence of its control.

(h) *Importer* means either the U.S. owner or consignee at the time of entry of a food product into the United States, or the U.S. agent or representative of the foreign owner or consignee at the time of entry into the United States. The importer is responsible for ensuring that goods being offered for entry into the United States are in compliance with all applicable laws. For the purposes of this definition, the importer is ordinarily not the custom house broker, the freight forwarder, the carrier, or the steamship representative.

(i) *Monitor* means to conduct a planned sequence of observations or

measurements to assess whether a process, point, or procedure is under control and to produce an accurate record for use in verification.

(j)(1) *Processing* means activities that are directly related to the production of juice products.

(2) For purposes of this part, processing does not include:

(i) Harvesting, picking, or transporting raw agricultural ingredients of juice products, without otherwise engaging in processing; and

(ii) The operation of a retail establishment.

(k) *Processor* means any person engaged in commercial, custom, or institutional processing of juice products, either in the United States or in a foreign country, including any person engaged in the processing of juice products that are intended for use in market or consumer tests.

(l) *Retail establishment* is an operation that provides juice directly to the consumers and does not include an establishment that sells or distributes juice to other business entities as well as directly to consumers. "Provides" includes storing, preparing, packaging, serving, and vending.

(m) *Shall* is used to state mandatory requirements.

(n) *Shelf-stable product* means a product that is hermetically sealed and, when stored at room temperature, should not demonstrate any microbial growth.

(o) *Should* is used to state recommended or advisory procedures or to identify recommended equipment.

(p) *Validation* means that element of verification focused on collecting and evaluating scientific and technical information to determine whether the HACCP plan, when properly implemented, will effectively control the identified food hazards.

(q) *Verification* means those activities, other than monitoring, that establish the validity of the HACCP plan and that the system is operating according to the plan.

§ 120.5 Current good manufacturing practice.

Part 110 of this chapter applies in determining whether the facilities, methods, practices, and controls used to

process juice are safe, and whether the food has been processed under sanitary conditions.

§ 120.6 Sanitation standard operating procedures.

(a) *Sanitation controls*. Each processor shall have and implement a sanitation standard operating procedure (SSOP) that addresses sanitation conditions and practices before, during, and after processing. The SSOP shall address:

(1) Safety of the water that comes into contact with food or food contact surfaces or that is used in the manufacture of ice;

(2) Condition and cleanliness of food contact surfaces, including utensils, gloves, and outer garments;

(3) Prevention of cross contamination from insanitary objects to food, food packaging material, and other food contact surfaces, including utensils, gloves, and outer garments, and from raw product to processed product;

(4) Maintenance of hand washing, hand sanitizing, and toilet facilities;

(5) Protection of food, food packaging material, and food contact surfaces from adulteration with lubricants, fuel, pesticides, cleaning compounds, sanitizing agents, condensate, and other chemical, physical, and biological contaminants;

(6) Proper labeling, storage, and use of toxic compounds;

(7) Control of employee health conditions that could result in the microbiological contamination of food, food packaging materials, and food contact surfaces; and

(8) Exclusion of pests from the food plant.

(b) *Monitoring*. The processor shall monitor the conditions and practices during processing with sufficient frequency to ensure, at a minimum, conformance with those conditions and practices specified in part 110 of this chapter that are appropriate both to the plant and to the food being processed. Each processor shall correct, in a timely manner, those conditions and practices that are not met.

(c) *Records*. Each processor shall maintain SSOP records that, at a minimum, document the monitoring and corrections prescribed by paragraph (b)

§ 120.7

21 CFR Ch. I (4–1–07 Edition)

of this section. These records are subject to the recordkeeping requirements of § 120.12.

(d) *Relationship to Hazard Analysis and Critical Control Point (HACCP) plan.* Sanitation standard operating procedure controls may be included in the HACCP plan required under § 120.8(b). However, to the extent that they are implemented in accordance with this section, they need not be included in the HACCP plan.

§ 120.7 Hazard analysis.

(a) Each processor shall develop, or have developed for it, a written hazard analysis to determine whether there are food hazards that are reasonably likely to occur for each type of juice processed by that processor and to identify control measures that the processor can apply to control those hazards. The written hazard analysis shall consist of at least the following:

- (1) Identification of food hazards;
 - (2) An evaluation of each food hazard identified to determine if the hazard is reasonably likely to occur and thus, constitutes a food hazard that must be addressed in the HACCP plan. A food hazard that is reasonably likely to occur is one for which a prudent processor would establish controls because experience, illness data, scientific reports, or other information provide a basis to conclude that there is a reasonable possibility that, in the absence of those controls, the food hazard will occur in the particular type of product being processed. This evaluation shall include an assessment of the severity of the illness or injury if the food hazard occurs;
 - (3) Identification of the control measures that the processor can apply to control the food hazards identified as reasonably likely to occur in paragraph (a)(2) of this section;
 - (4) Review of the current process to determine whether modifications are necessary; and
 - (5) Identification of critical control points.
- (b) The hazard analysis shall include food hazards that can be introduced both within and outside the processing plant environment, including food hazards that can occur before, during, and after harvest. The hazard analysis shall

be developed by an individual or individuals who have been trained in accordance with § 120.13 and shall be subject to the recordkeeping requirements of § 120.12.

(c) In evaluating what food hazards are reasonably likely to occur, consideration should be given, at a minimum, to the following:

- (1) Microbiological contamination;
- (2) Parasites;
- (3) Chemical contamination;
- (4) Unlawful pesticides residues;
- (5) Decomposition in food where a food hazard has been associated with decomposition;
- (6) Natural toxins;
- (7) Unapproved use of food or color additives;
- (8) Presence of undeclared ingredients that may be allergens; and
- (9) Physical hazards.

(d) Processors should evaluate product ingredients, processing procedures, packaging, storage, and intended use; facility and equipment function and design; and plant sanitation, including employee hygiene, to determine the potential effect of each on the safety of the finished food for the intended consumer.

(e) HACCP plans for juice need not address the food hazards associated with microorganisms and microbial toxins that are controlled by the requirements of part 113 or part 114 of this chapter. A HACCP plan for such juice shall address any other food hazards that are reasonably likely to occur.

§ 120.8 Hazard Analysis and Critical Control Point (HACCP) plan.

(a) *HACCP plan.* Each processor shall have and implement a written HACCP plan whenever a hazard analysis reveals one or more food hazards that are reasonably likely to occur during processing, as described in § 120.7. The HACCP plan shall be developed by an individual or individuals who have been trained in accordance with § 120.13 and shall be subject to the recordkeeping requirements of § 120.12. A HACCP plan shall be specific to:

- (1) Each location where juice is processed by that processor; and
- (2) Each type of juice processed by the processor. The plan may group

types of juice products together, or group types of production methods together, if the food hazards, critical control points, critical limits, and procedures required to be identified and performed by paragraph (b) of this section are essentially identical, provided that any required features of the plan that are unique to a specific product or method are clearly delineated in the plan and are observed in practice.

(b) *The contents of the HACCP plan.* The HACCP plan shall, at a minimum:

(1) List all food hazards that are reasonably likely to occur as identified in accordance with §120.7, and that thus must be controlled for each type of product;

(2) List the critical control points for each of the identified food hazards that is reasonably likely to occur, including as appropriate:

(i) Critical control points designed to control food hazards that are reasonably likely to occur and could be introduced inside the processing plant environment; and

(ii) Critical control points designed to control food hazards introduced outside the processing plant environment, including food hazards that occur before, during, and after harvest;

(3) List the critical limits that shall be met at each of the critical control points;

(4) List the procedures, and the frequency with which they are to be performed, that will be used to monitor each of the critical control points to ensure compliance with the critical limits;

(5) Include any corrective action plans that have been developed in accordance with §120.10(a), and that are to be followed in response to deviations from critical limits at critical control points;

(6) List the validation and verification procedures, and the frequency with which they are to be performed, that the processor will use in accordance with §120.11; and

(7) Provide for a recordkeeping system that documents the monitoring of the critical control points in accordance with §120.12. The records shall contain the actual values and observations obtained during monitoring.

(c) *Sanitation.* Sanitation controls may be included in the HACCP plan. However, to the extent that they are monitored in accordance with §120.6, they are not required to be included in the HACCP plan.

§ 120.9 Legal basis.

Failure of a processor to have and to implement a Hazard Analysis and Critical Control Point (HACCP) system that complies with §§120.6, 120.7, and 120.8, or otherwise to operate in accordance with the requirements of this part, shall render the juice products of that processor adulterated under section 402(a)(4) of the Federal Food, Drug, and Cosmetic Act. Whether a processor's actions are consistent with ensuring the safety of juice will be determined through an evaluation of the processor's overall implementation of its HACCP system.

§ 120.10 Corrective actions.

Whenever a deviation from a critical limit occurs, a processor shall take corrective action by following the procedures set forth in paragraph (a) or paragraph (b) of this section.

(a) Processors may develop written corrective action plans, which become part of their HACCP plans in accordance with §120.8(b)(5), by which processors predetermine the corrective actions that they will take whenever there is a deviation from a critical limit. A corrective action plan that is appropriate for a particular deviation is one that describes the steps to be taken and assigns responsibility for taking those steps, to ensure that:

(1) No product enters commerce that is either injurious to health or is otherwise adulterated as a result of the deviation; and

(2) The cause of the deviation is corrected.

(b) When a deviation from a critical limit occurs, and the processor does not have a corrective action plan that is appropriate for that deviation, the processor shall:

(1) Segregate and hold the affected product, at least until the requirements of paragraphs (b)(2) and (b)(3) of this section are met;

§ 120.11

21 CFR Ch. I (4–1–07 Edition)

(2) Perform or obtain a review to determine the acceptability of the affected product for distribution. The review shall be performed by an individual or individuals who have adequate training or experience to perform such review;

(3) Take corrective action, when necessary, with respect to the affected product to ensure that no product enters commerce that is either injurious to health or is otherwise adulterated as a result of the deviation;

(4) Take corrective action, when necessary, to correct the cause of the deviation; and

(5) Perform or obtain timely verification in accordance with §120.11, by an individual or individuals who have been trained in accordance with §120.13, to determine whether modification of the HACCP plan is required to reduce the risk of recurrence of the deviation, and to modify the HACCP plan as necessary.

(c) All corrective actions taken in accordance with this section shall be fully documented in records that are subject to verification in accordance with §120.11(a)(1)(iv)(B) and the recordkeeping requirements of §120.12.

§ 120.11 Verification and validation.

(a) *Verification.* Each processor shall verify that the Hazard Analysis and Critical Control Point (HACCP) system is being implemented according to design.

(1) Verification activities shall include:

(i) A review of any consumer complaints that have been received by the processor to determine whether such complaints relate to the performance of the HACCP plan or reveal previously unidentified critical control points;

(ii) The calibration of process monitoring instruments;

(iii) At the option of the processor, the performance of periodic end-product or in-process testing; except that processors of citrus juice that rely in whole or in part on surface treatment of fruit shall perform end-product testing in accordance with §120.25.

(iv) A review, including signing and dating, by an individual who has been trained in accordance with §120.13, of the records that document:

(A) The monitoring of critical control points. The purpose of this review shall be, at a minimum, to ensure that the records are complete and to verify that the records document values that are within the critical limits. This review shall occur within 1 week (7 days) of the day that the records are made;

(B) The taking of corrective actions. The purpose of this review shall be, at a minimum, to ensure that the records are complete and to verify that appropriate corrective actions were taken in accordance with §120.10. This review shall occur within 1 week (7 days) of the day that the records are made; and

(C) The calibrating of any process monitoring instruments used at critical control points and the performance of any periodic end-product or in-process testing that is part of the processor's verification activities. The purpose of these reviews shall be, at a minimum, to ensure that the records are complete and that these activities occurred in accordance with the processor's written procedures. These reviews shall occur within a reasonable time after the records are made; and

(v) The following of procedures in §120.10 whenever any verification procedure, including the review of consumer complaints, establishes the need to take a corrective action; and

(vi) Additional process verification if required by §120.25.

(2) Records that document the calibration of process monitoring instruments, in accordance with paragraph (a)(1)(iv)(B) of this section, and the performance of any periodic end-product and in-process testing, in accordance with paragraph (a)(1)(iv)(C) of this section, are subject to the recordkeeping requirements of §120.12.

(b) *Validation of the HACCP plan.* Each processor shall validate that the HACCP plan is adequate to control food hazards that are reasonably likely to occur; this validation shall occur at least once within 12 months after implementation and at least annually thereafter or whenever any changes in the process occur that could affect the hazard analysis or alter the HACCP plan in any way. Such changes may include changes in the following: Raw materials or source of raw materials;

product formulation; processing methods or systems, including computers and their software; packaging; finished product distribution systems; or the intended use or consumers of the finished product. The validation shall be performed by an individual or individuals who have been trained in accordance with §120.13 and shall be subject to the recordkeeping requirements of §120.12. The HACCP plan shall be modified immediately whenever a validation reveals that the plan is no longer adequate to fully meet the requirements of this part.

(c) *Validation of the hazard analysis.* Whenever a juice processor has no HACCP plan because a hazard analysis has revealed no food hazards that are reasonably likely to occur, the processor shall reassess the adequacy of that hazard analysis whenever there are any changes in the process that could reasonably affect whether a food hazard exists. Such changes may include changes in the following: Raw materials or source of raw materials; product formulation; processing methods or systems, including computers and their software; packaging; finished product distribution systems; or the intended use or intended consumers of the finished product. The validation of the hazard analysis shall be performed by an individual or individuals who have been trained in accordance with §120.13, and, records documenting the validation shall be subject to the recordkeeping requirements of §120.12.

§ 120.12 Records.

(a) *Required records.* Each processor shall maintain the following records documenting the processor's Hazard Analysis and Critical Control Point (HACCP) system:

(1) Records documenting the implementation of the sanitation standard operating procedures (SSOP's) (see §120.6);

(2) The written hazard analysis required by §120.7;

(3) The written HACCP plan required by §120.8;

(4) Records documenting the ongoing application of the HACCP plan that include:

(i) Monitoring of critical control points and their critical limits, includ-

ing the recording of actual times, temperatures, or other measurements, as prescribed in the HACCP plan; and

(ii) Corrective actions, including all actions taken in response to a deviation; and

(5) Records documenting verification of the HACCP system and validation of the HACCP plan or hazard analysis, as appropriate.

(b) *General requirements.* All records required by this part shall include:

(1) The name of the processor or importer and the location of the processor or importer, if the processor or importer has more than one location;

(2) The date and time of the activity that the record reflects, except that records required by paragraphs (a)(2), (a)(3), and (a)(5) of this section need not include the time;

(3) The signature or initials of the person performing the operation or creating the record; and

(4) Where appropriate, the identity of the product and the production code, if any. Processing and other information shall be entered on records at the time that it is observed. The records shall contain the actual values and observations obtained during monitoring.

(c) *Documentation.* (1) The records in paragraphs (a)(2) and (a)(3) of this section shall be signed and dated by the most responsible individual onsite at the processing facility or by a higher level official of the processor. These signatures shall signify that these records have been accepted by the firm.

(2) The records in paragraphs (a)(2) and (a)(3) of this section shall be signed and dated:

(i) Upon initial acceptance;

(ii) Upon any modification; and

(iii) Upon verification and validation in accordance with §120.11.

(d) *Record retention.* (1) All records required by this part shall be retained at the processing facility or at the importer's place of business in the United States for, in the case of perishable or refrigerated juices, at least 1 year after the date that such products were prepared, and for, in the case of frozen, preserved, or shelf stable products, 2 years or the shelf life of the product, whichever is greater, after the date that the products were prepared.

§ 120.13

21 CFR Ch. I (4–1–07 Edition)

(2) Offsite storage of processing records required by paragraphs (a)(1) and (a)(4) of this section is permitted after 6 months following the date that the monitoring occurred, if such records can be retrieved and provided onsite within 24 hours of request for official review. Electronic records are considered to be onsite if they are accessible from an onsite location and comply with paragraph (g) of this section.

(3) If the processing facility is closed for a prolonged period between seasonal packs, the records may be transferred to some other reasonably accessible location at the end of the seasonal pack but shall be immediately returned to the processing facility for official review upon request.

(e) *Official review.* All records required by this part shall be available for review and copying at reasonable times.

(f) *Public disclosure.* (1) All records required by this part are not available for public disclosure unless they have been previously disclosed to the public, as defined in § 20.81 of this chapter, or unless they relate to a product or ingredient that has been abandoned and no longer represent a trade secret or confidential commercial or financial information as defined in § 20.61 of this chapter.

(2) Records required to be maintained by this part are subject to disclosure to the extent that they are otherwise publicly available, or that disclosure could not reasonably be expected to cause a competitive hardship, such as generic type HACCP plans that reflect standard industry practices.

(g) *Records maintained on computers.* The maintenance of computerized records, in accordance with part 11 of this chapter, is acceptable.

§ 120.13 Training.

(a) Only an individual who has met the requirements of paragraph (b) of this section shall be responsible for the following functions:

(1) Developing the hazard analysis, including delineating control measures, as required by § 120.7.

(2) Developing a Hazard Analysis and Critical Control Point (HACCP) plan that is appropriate for a specific proc-

essor, in order to meet the requirements of § 120.8;

(3) Verifying and modifying the HACCP plan in accordance with the corrective action procedures specified in § 120.10(b)(5) and the validation activities specified in § 120.11(b) and (c); and § 120.7;

(4) Performing the record review required by § 120.11(a)(1)(iv).

(b) The individual performing the functions listed in paragraph (a) of this section shall have successfully completed training in the application of HACCP principles to juice processing at least equivalent to that received under standardized curriculum recognized as adequate by the Food and Drug Administration, or shall be otherwise qualified through job experience to perform these functions. Job experience may qualify an individual to perform these functions if such experience has provided knowledge at least equivalent to that provided through the standardized curriculum. The trained individual need not be an employee of the processor.

§ 120.14 Application of requirements to imported products.

This section sets forth specific requirements for imported juice.

(a) *Importer requirements.* Every importer of juice shall either:

(1) Obtain the juice from a country that has an active memorandum of understanding (MOU) or similar agreement with the Food and Drug Administration, that covers the food and documents the equivalency or compliance of the inspection system of the foreign country with the U.S. system, accurately reflects the relationship between the signing parties, and is functioning and enforceable in its entirety; or

(2) Have and implement written procedures for ensuring that the juice that such importer receives for import into the United States was processed in accordance with the requirements of this part. The procedures shall provide, at a minimum:

(i) Product specifications that are designed to ensure that the juice is not adulterated under section 402 of the Federal Food, Drug, and Cosmetic Act because it may be injurious to health

or because it may have been processed under insanitary conditions; and

(ii) Affirmative steps to ensure that the products being offered for entry were processed under controls that meet the requirements of this part. These steps may include any of the following:

(A) Obtaining from the foreign processor the Hazard Analysis and Critical Control Point (HACCP) plan and prerequisite program of the standard operating procedure records required by this part that relate to the specific lot of food being offered for import;

(B) Obtaining either a continuing or lot specific certificate from an appropriate foreign government inspection authority or competent third party certifying that the imported food has been processed in accordance with the requirements of this part;

(C) Regularly inspecting the foreign processor's facilities to ensure that the imported food is being processed in accordance with the requirements of this part;

(D) Maintaining on file a copy, in English, of the foreign processor's hazard analysis and HACCP plan, and a written guarantee from the foreign processor that the imported food is processed in accordance with the requirements of this part;

(E) Periodically testing the imported food, and maintaining on file a copy, in English, of a written guarantee from the foreign processor that the imported food is processed in accordance with the requirements of this part; or

(F) Other such verification measures as appropriate that provide an equivalent level of assurance of compliance with the requirements of this part.

(b) *Competent third party.* An importer may hire a competent third party to assist with or perform any or all of the verification activities specified in paragraph (a)(2) of this section, including writing the importer's verification procedures on the importer's behalf.

(c) *Records.* The importer shall maintain records, in English, that document the performance and results of the affirmative steps specified in paragraph (a)(2)(ii) of this section. These records shall be subject to the applicable provisions of § 120.12.

(d) *Determination of compliance.* The importer shall provide evidence that all juice offered for entry into the United States has been processed under conditions that comply with this part. If assurances do not exist that an imported juice has been processed under conditions that are equivalent to those required of domestic processors under this part, the product will appear to be adulterated and will be denied entry.

Subpart B—Pathogen Reduction

§ 120.20 General.

This subpart augments subpart A of this part by setting forth specific requirements for process controls.

§ 120.24 Process controls.

(a) In order to meet the requirements of subpart A of this part, processors of juice products shall include in their Hazard Analysis and Critical Control Point (HACCP) plans control measures that will consistently produce, at a minimum, a 5 log (*i.e.*, 10⁵) reduction, for a period at least as long as the shelf life of the product when stored under normal and moderate abuse conditions, in the pertinent microorganism. For the purposes of this regulation, the "pertinent microorganism" is the most resistant microorganism of public health significance that is likely to occur in the juice. The following juice processors are exempt from this paragraph:

(1) A juice processor that is subject to the requirements of part 113 or part 114 of this chapter; and

(2) A juice processor using a single thermal processing step sufficient to achieve shelf-stability of the juice or a thermal concentration process that includes thermal treatment of all ingredients, provided that the processor includes a copy of the thermal process used to achieve shelf-stability or concentration in its written hazard analysis required by § 120.7.

(b) All juice processors shall meet the requirements of paragraph (a) of this section through treatments that are applied directly to the juice, except that citrus juice processors may use treatments to fruit surfaces, provided that the 5-log reduction process begins after culling and cleaning as defined in

§ 120.25

21 CFR Ch. I (4-1-07 Edition)

§ 120.3(a) and (f) and the reduction is accomplished within a single production facility.

(c) All juice processors shall meet the requirements of paragraphs (a) and (b) of this section and perform final product packaging within a single production facility operating under current good manufacturing practices. Processors claiming an exemption under paragraph (a)(1) or (a)(2) of this section shall also process and perform final product packaging of all juice subject to the claimed exemption within a single production facility operating under current good manufacturing practices.

§ 120.25 Process verification for certain processors.

Each juice processor that relies on treatments that do not come into direct contact with all parts of the juice to achieve the requirements of § 120.24 shall analyze the finished product for biotype I *Escherichia coli* as follows:

(a) One 20 milliliter (mL) sample (consisting of two 10 mL subsamples) for each 1,000 gallons of juice produced shall be sampled each production day. If less than 1,000 gallons of juice is produced per day, the sample must be taken for each 1,000 gallons produced but not less than once every 5 working days that the facility is producing that juice. Each subsample shall be taken by randomly selecting a package of juice ready for distribution to consumers.

(b) If the facility is producing more than one type of juice covered by this section, processors shall take subsamples according to paragraph (a) of this section for each of the covered juice products produced.

(c) Processors shall analyze each subsample for the presence of *E. coli* by the method entitled "Analysis for *Escherichia coli* in Citrus Juices—Modification of AOAC Official Method 992.30" or another method that is at least equivalent to this method in terms of accuracy, precision, and sensitivity in detecting *E. coli*. This method is designed to detect the presence or absence of *E. coli* in a 20 mL sample of juice (consisting of two 10 mL subsamples). The method is as follows:

(1) *Sample size*. Total—20 mL of juice; perform analysis using two 10 mL aliquots.

(2) *Media*. Universal Preenrichment Broth (Difco, Detroit, MI), EC Broth (various manufacturers).

(3) *Method*. ColiComplete (AOAC Official Method 992.30—modified).

(4) *Procedure*. Perform the following procedure two times:

(i) Aseptically inoculate 10 mL of juice into 90 mL of Universal Preenrichment Broth (Difco) and incubate at 35 °C for 18 to 24 hours.

(ii) Next day, transfer 1 mL of preenriched sample into 10 mL of EC Broth, without Durham gas vials. After inoculation, aseptically add a ColiComplete SSD disc into each tube.

(iii) Incubate at 44.5 °C for 18 to 24 hours.

(iv) Examine the tubes under longwave ultra violet light (366 nm). Fluorescent tubes indicate presence of *E. coli*.

(v) MUG positive and negative controls should be used as reference in interpreting fluorescence reactions. Use an *E. coli* for positive control and 2 negative controls—a MUG negative strain and an uninoculated tube media.

(d) If either 10 mL subsample is positive for *E. coli*, the 20 mL sample is recorded as positive and the processor shall:

(1) Review monitoring records for the control measures to attain the 5-log reduction standard and correct those conditions and practices that are not met. In addition, the processor may choose to test the sample for the presence of pathogens of concern.

(2) If the review of monitoring records or the additional testing indicates that the 5-log reduction standard was not achieved (*e.g.*, a sample is found to be positive for the presence of a pathogen or a deviation in the process or its delivery is identified), the processor shall take corrective action as set forth in § 120.10.

(e) If two samples in a series of seven tests are positive for *E. coli*, the control measures to attain the 5-log reduction standard shall be deemed to be inadequate and the processor shall immediately:

(1) Until corrective actions are completed, use an alternative process or

processes that achieve the 5-log reduction after the juice has been expressed;

(2) Perform a review of the monitoring records for control measures to attain the 5-log reduction standard. The review shall be sufficiently extensive to determine that there are no trends towards loss of control;

(i) If the conditions and practices are not being met, correct those that do not conform to the HACCP plan; or

(ii) If the conditions and practices are being met, the processor shall validate the HACCP plan in relation to the 5-log reduction standard; and

(3) Take corrective action as set forth in §120.10. Corrective actions shall include ensuring no product enters commerce that is injurious to health as set forth in §120.10(a)(1).

PART 123—FISH AND FISHERY PRODUCTS

Subpart A—General Provisions

Sec.

123.3 Definitions.

123.5 Current good manufacturing practice.

123.6 Hazard analysis and Hazard Analysis Critical Control Point (HACCP) plan.

123.7 Corrective actions.

123.8 Verification.

123.9 Records.

123.10 Training.

123.11 Sanitation control procedures.

123.12 Special requirements for imported products.

Subpart B—Smoked and Smoke-Flavored Fishery Products

123.15 General.

123.16 Process controls.

Subpart C—Raw Molluscan Shellfish

123.20 General.

123.28 Source controls.

AUTHORITY: 21 U.S.C. 321, 342, 343, 346, 348, 371, 374, 379e, 381, 393; 42 U.S.C. 241, 2411, 264.

SOURCE: 60 FR 65197, Dec. 18, 1995, unless otherwise noted.

Subpart A—General Provisions

§ 123.3 Definitions.

The definitions and interpretations of terms in section 201 of the Federal Food, Drug, and Cosmetic Act (the act) and in part 110 of this chapter are ap-

plicable to such terms when used in this part, except where they are herein redefined. The following definitions shall also apply:

(a) *Certification number* means a unique combination of letters and numbers assigned by a shellfish control authority to a molluscan shellfish processor.

(b) *Critical control point* means a point, step, or procedure in a food process at which control can be applied, and a food safety hazard can as a result be prevented, eliminated, or reduced to acceptable levels.

(c) *Critical limit* means the maximum or minimum value to which a physical, biological, or chemical parameter must be controlled at a critical control point to prevent, eliminate, or reduce to an acceptable level the occurrence of the identified food safety hazard.

(d) *Fish* means fresh or saltwater finfish, crustaceans, other forms of aquatic animal life (including, but not limited to, alligator, frog, aquatic turtle, jellyfish, sea cucumber, and sea urchin and the roe of such animals) other than birds or mammals, and all mollusks, where such animal life is intended for human consumption.

(e) *Fishery product* means any human food product in which fish is a characterizing ingredient.

(f) *Food safety hazard* means any biological, chemical, or physical property that may cause a food to be unsafe for human consumption.

(g) *Importer* means either the U.S. owner or consignee at the time of entry into the United States, or the U.S. agent or representative of the foreign owner or consignee at the time of entry into the United States, who is responsible for ensuring that goods being offered for entry into the United States are in compliance with all laws affecting the importation. For the purposes of this definition, ordinarily the importer is not the custom house broker, the freight forwarder, the carrier, or the steamship representative.

(h) *Molluscan shellfish* means any edible species of fresh or frozen oysters, clams, mussels, or scallops, or edible portions of such species, except when the product consists entirely of the shucked adductor muscle.

§ 123.5

(i) *Preventive measure* means physical, chemical, or other factors that can be used to control an identified food safety hazard.

(j) *Process-monitoring instrument* means an instrument or device used to indicate conditions during processing at a critical control point.

(k)(1) *Processing* means, with respect to fish or fishery products: Handling, storing, preparing, heading, eviscerating, shucking, freezing, changing into different market forms, manufacturing, preserving, packing, labeling, dockside unloading, or holding.

(2) The regulations in this part do not apply to:

(i) Harvesting or transporting fish or fishery products, without otherwise engaging in processing.

(ii) Practices such as heading, eviscerating, or freezing intended solely to prepare a fish for holding on board a harvest vessel.

(iii) The operation of a retail establishment.

(l) *Processor* means any person engaged in commercial, custom, or institutional processing of fish or fishery products, either in the United States or in a foreign country. A processing includes any person engaged in the production of foods that are to be used in market or consumer tests.

(m) *Scombroid toxin-forming species* means tuna, bluefish, mahi mahi, and other species, whether or not in the family Scombridae, in which significant levels of histamine may be produced in the fish flesh by decarboxylation of free histidine as a result of exposure of the fish after capture to temperatures that permit the growth of mesophilic bacteria.

(n) *Shall* is used to state mandatory requirements.

(o) *Shellfish control authority* means a Federal, State, or foreign agency, or sovereign tribal government, legally responsible for the administration of a program that includes activities such as classification of molluscan shellfish growing areas, enforcement of molluscan shellfish harvesting controls, and certification of molluscan shellfish processors.

(p) *Shellstock* means raw, in-shell molluscan shellfish.

21 CFR Ch. I (4–1–07 Edition)

(q) *Should* is used to state recommended or advisory procedures or to identify recommended equipment.

(r) *Shucked shellfish* means molluscan shellfish that have one or both shells removed.

(s) *Smoked or smoke-flavored fishery products* means the finished food prepared by:

(1) Treating fish with salt (sodium chloride), and

(2) Subjecting it to the direct action of smoke from burning wood, sawdust, or similar material and/or imparting to it the flavor of smoke by a means such as immersing it in a solution of wood smoke.

(t) *Tag* means a record of harvesting information attached to a container of shellstock by the harvester or processor.

§ 123.5 Current good manufacturing practice.

(a) Part 110 of this chapter applies in determining whether the facilities, methods, practices, and controls used to process fish and fishery products are safe, and whether these products have been processed under sanitary conditions.

(b) The purpose of this part is to set forth requirements specific to the processing of fish and fishery products.

§ 123.6 Hazard analysis and Hazard Analysis Critical Control Point (HACCP) plan.

(a) *Hazard analysis*. Every processor shall conduct, or have conducted for it, a hazard analysis to determine whether there are food safety hazards that are reasonably likely to occur for each kind of fish and fishery product processed by that processor and to identify the preventive measures that the processor can apply to control those hazards. Such food safety hazards can be introduced both within and outside the processing plant environment, including food safety hazards that can occur before, during, and after harvest. A food safety hazard that is reasonably likely to occur is one for which a prudent processor would establish controls because experience, illness data, scientific reports, or other information provide a basis to conclude that there is a reasonable possibility that it will

occur in the particular type of fish or fishery product being processed in the absence of those controls.

(b) *The HACCP plan.* Every processor shall have and implement a written HACCP plan whenever a hazard analysis reveals one or more food safety hazards that are reasonably likely to occur, as described in paragraph (a) of this section. A HACCP plan shall be specific to:

(1) Each location where fish and fishery products are processed by that processor; and

(2) Each kind of fish and fishery product processed by the processor. The plan may group kinds of fish and fishery products together, or group kinds of production methods together, if the food safety hazards, critical control points, critical limits, and procedures required to be identified and performed in paragraph (c) of this section are identical for all fish and fishery products so grouped or for all production methods so grouped.

(c) *The contents of the HACCP plan.* The HACCP plan shall, at a minimum:

(1) List the food safety hazards that are reasonably likely to occur, as identified in accordance with paragraph (a) of this section, and that thus must be controlled for each fish and fishery product. Consideration should be given to whether any food safety hazards are reasonably likely to occur as a result of the following:

- (i) Natural toxins;
- (ii) Microbiological contamination;
- (iii) Chemical contamination;
- (iv) Pesticides;
- (v) Drug residues;

(vi) Decomposition in scombroid toxin-forming species or in any other species where a food safety hazard has been associated with decomposition;

(vii) Parasites, where the processor has knowledge or has reason to know that the parasite-containing fish or fishery product will be consumed without a process sufficient to kill the parasites, or where the processor represents, labels, or intends for the product to be so consumed;

(viii) Unapproved use of direct or indirect food or color additives; and

- (ix) Physical hazards;

(2) List the critical control points for each of the identified food safety hazards, including as appropriate:

(i) Critical control points designed to control food safety hazards that could be introduced in the processing plant environment; and

(ii) Critical control points designed to control food safety hazards introduced outside the processing plant environment, including food safety hazards that occur before, during, and after harvest;

(3) List the critical limits that must be met at each of the critical control points;

(4) List the procedures, and frequency thereof, that will be used to monitor each of the critical control points to ensure compliance with the critical limits;

(5) Include any corrective action plans that have been developed in accordance with §123.7(b), to be followed in response to deviations from critical limits at critical control points;

(6) List the verification procedures, and frequency thereof, that the processor will use in accordance with §123.8(a);

(7) Provide for a recordkeeping system that documents the monitoring of the critical control points. The records shall contain the actual values and observations obtained during monitoring.

(d) *Signing and dating the HACCP plan.* (1) The HACCP plan shall be signed and dated, either by the most responsible individual onsite at the processing facility or by a higher level official of the processor. This signature shall signify that the HACCP plan has been accepted for implementation by the firm.

(2) The HACCP plan shall be dated and signed:

- (i) Upon initial acceptance;
- (ii) Upon any modification; and

(iii) Upon verification of the plan in accordance with §123.8(a)(1).

(e) *Products subject to other regulations.* For fish and fishery products that are subject to the requirements of part 113 or 114 of this chapter, the HACCP plan need not list the food safety hazard associated with the formation of *Clostridium botulinum* toxin in the finished, hermetically sealed container, nor list the controls to prevent

§ 123.7

21 CFR Ch. I (4–1–07 Edition)

that food safety hazard. A HACCP plan for such fish and fishery products shall address any other food safety hazards that are reasonably likely to occur.

(f) *Sanitation.* Sanitation controls may be included in the HACCP plan. However, to the extent that they are monitored in accordance with § 123.11(b) they need not be included in the HACCP plan, and vice versa.

(g) *Legal basis.* Failure of a processor to have and implement a HACCP plan that complies with this section whenever a HACCP plan is necessary, otherwise operate in accordance with the requirements of this part, shall render the fish or fishery products of that processor adulterated under section 402(a)(4) of the act. Whether a processor's actions are consistent with ensuring the safety of food will be determined through an evaluation of the processors overall implementation of its HACCP plan, if one is required.

§ 123.7 Corrective actions.

(a) Whenever a deviation from a critical limit occurs, a processor shall take corrective action either by:

(1) Following a corrective action plan that is appropriate for the particular deviation, or

(2) Following the procedures in paragraph (c) of this section.

(b) Processors may develop written corrective action plans, which become part of their HACCP plans in accordance with § 123.6(c)(5), by which they predetermine the corrective actions that they will take whenever there is a deviation from a critical limit. A corrective action plan that is appropriate for a particular deviation is one that describes the steps to be taken and assigns responsibility for taking those steps, to ensure that:

(1) No product enters commerce that is either injurious to health or is otherwise adulterated as a result of the deviation; and

(2) The cause of the deviation is corrected.

(c) When a deviation from a critical limit occurs and the processor does not have a corrective action plan that is appropriate for that deviation, the processor shall:

(1) Segregate and hold the affected product, at least until the require-

ments of paragraphs (c)(2) and (c)(3) of this section are met;

(2) Perform or obtain a review to determine the acceptability of the affected product for distribution. The review shall be performed by an individual or individuals who have adequate training or experience to perform such a review. Adequate training may or may not include training in accordance with § 123.10;

(3) Take corrective action, when necessary, with respect to the affected product to ensure that no product enters commerce that is either injurious to health or is otherwise adulterated as a result of the deviation;

(4) Take corrective action, when necessary, to correct the cause of the deviation;

(5) Perform or obtain timely reassessment by an individual or individuals who have been trained in accordance with § 123.10, to determine whether the HACCP plan needs to be modified to reduce the risk of recurrence of the deviation, and modify the HACCP plan as necessary.

(d) All corrective actions taken in accordance with this section shall be fully documented in records that are subject to verification in accordance with § 123.8(a)(3)(ii) and the record-keeping requirements of § 123.9.

§ 123.8 Verification.

(a) *Overall verification.* Every processor shall verify that the HACCP plan is adequate to control food safety hazards that are reasonably likely to occur, and that the plan is being effectively implemented. Verification shall include, at a minimum:

(1) *Reassessment of the HACCP plan.* A reassessment of the adequacy of the HACCP plan whenever any changes occur that could affect the hazard analysis or alter the HACCP plan in any way or at least annually. Such changes may include changes in the following: Raw materials or source of raw materials, product formulation, processing methods or systems, finished product distribution systems, or the intended use or consumers of the finished product. The reassessment shall be performed by an individual or individuals who have been trained in accordance with § 123.10. The HACCP plan shall be

modified immediately whenever a reassessment reveals that the plan is no longer adequate to fully meet the requirements of §123.6(c).

(2) *Ongoing verification activities.* Ongoing verification activities including:

(i) A review of any consumer complaints that have been received by the processor to determine whether they relate to the performance of critical control points or reveal the existence of unidentified critical control points;

(ii) The calibration of process-monitoring instruments; and,

(iii) At the option of the processor, the performing of periodic end-product or in-process testing.

(3) *Records review.* A review, including signing and dating, by an individual who has been trained in accordance with §123.10, of the records that document:

(i) The monitoring of critical control points. The purpose of this review shall be, at a minimum, to ensure that the records are complete and to verify that they document values that are within the critical limits. This review shall occur within 1 week of the day that the records are made;

(ii) The taking of corrective actions. The purpose of this review shall be, at a minimum, to ensure that the records are complete and to verify that appropriate corrective actions were taken in accordance with §123.7. This review shall occur within 1 week of the day that the records are made; and

(iii) The calibrating of any process control instruments used at critical control points and the performing of any periodic end-product or in-process testing that is part of the processor's verification activities. The purpose of these reviews shall be, at a minimum, to ensure that the records are complete, and that these activities occurred in accordance with the processor's written procedures. These reviews shall occur within a reasonable time after the records are made.

(b) *Corrective actions.* Processors shall immediately follow the procedures in §123.7 whenever any verification procedure, including the review of a consumer complaint, reveals the need to take a corrective action.

(c) *Reassessment of the hazard analysis.* Whenever a processor does not have a

HACCP plan because a hazard analysis has revealed no food safety hazards that are reasonably likely to occur, the processor shall reassess the adequacy of that hazard analysis whenever there are any changes that could reasonably affect whether a food safety hazard now exists. Such changes may include, but are not limited to changes in: Raw materials or source of raw materials, product formulation, processing methods or systems, finished product distribution systems, or the intended use or consumers of the finished product. The reassessment shall be performed by an individual or individuals who have been trained in accordance with §123.10.

(d) *Recordkeeping.* The calibration of process-monitoring instruments, and the performing of any periodic end-product and in-process testing, in accordance with paragraphs (a)(2)(ii) through (iii) of this section shall be documented in records that are subject to the recordkeeping requirements of §123.9.

§ 123.9 Records.

(a) *General requirements.* All records required by this part shall include:

(1) The name and location of the processor or importer;

(2) The date and time of the activity that the record reflects;

(3) The signature or initials of the person performing the operation; and

(4) Where appropriate, the identity of the product and the production code, if any. Processing and other information shall be entered on records at the time that it is observed.

(b) *Record retention.* (1) All records required by this part shall be retained at the processing facility or importer's place of business in the United States for at least 1 year after the date they were prepared in the case of refrigerated products and for at least 2 years after the date they were prepared in the case of frozen, preserved, or shelf-stable products.

(2) Records that relate to the general adequacy of equipment or processes being used by a processor, including the results of scientific studies and evaluations, shall be retained at the processing facility or the importer's place of business in the United States

§ 123.10

for at least 2 years after their applicability to the product being produced at the facility.

(3) If the processing facility is closed for a prolonged period between seasonal packs, or if record storage capacity is limited on a processing vessel or at a remote processing site, the records may be transferred to some other reasonably accessible location at the end of the seasonal pack but shall be immediately returned for official review upon demand.

(c) *Official review.* All records required by this part and all plans and procedures required by this part shall be available for official review and copying at reasonable times.

(d) *Public disclosure.* (1) Subject to the limitations in paragraph (d)(2) of this section, all plans and records required by this part are not available for public disclosure unless they have been previously disclosed to the public as defined in § 20.81 of this chapter or they relate to a product or ingredient that has been abandoned and they no longer represent a trade secret or confidential commercial or financial information as defined in § 20.61 of this chapter.

(2) However, these records and plans may be subject to disclosure to the extent that they are otherwise publicly available, or that disclosure could not reasonably be expected to cause a competitive hardship, such as generic-type HACCP plans that reflect standard industry practices.

(e) *Tags.* Tags as defined in § 123.3(t) are not subject to the requirements of this section unless they are used to fulfill the requirements of § 123.28(c).

(f) *Records maintained on computers.* The maintenance of records on computers is acceptable, provided that appropriate controls are implemented to ensure the integrity of the electronic data and signatures.

§ 123.10 Training.

At a minimum, the following functions shall be performed by an individual who has successfully completed training in the application of HACCP principles to fish and fishery product processing at least equivalent to that received under standardized curriculum recognized as adequate by the U.S. Food and Drug Administration or

21 CFR Ch. I (4–1–07 Edition)

who is otherwise qualified through job experience to perform these functions. Job experience will qualify an individual to perform these functions if it has provided knowledge at least equivalent to that provided through the standardized curriculum.

(a) Developing a HACCP plan, which could include adapting a model or generic-type HACCP plan, that is appropriate for a specific processor, in order to meet the requirements of § 123.6(b);

(b) Reassessing and modifying the HACCP plan in accordance with the corrective action procedures specified in § 123.7(c)(5), the HACCP plan in accordance with the verification activities specified in § 123.8(a)(1), and the hazard analysis in accordance with the verification activities specified in § 123.8(c); and

(c) Performing the record review required by § 123.8(a)(3); The trained individual need not be an employee of the processor.

§ 123.11 Sanitation control procedures.

(a) *Sanitation SOP.* Each processor should have and implement a written sanitation standard operating procedure (herein referred to as SSOP) or similar document that is specific to each location where fish and fishery products are produced. The SSOP should specify how the processor will meet those sanitation conditions and practices that are to be monitored in accordance with paragraph (b) of this section.

(b) *Sanitation monitoring.* Each processor shall monitor the conditions and practices during processing with sufficient frequency to ensure, at a minimum, conformance with those conditions and practices specified in part 110 of this chapter that are both appropriate to the plant and the food being processed and relate to the following:

(1) Safety of the water that comes into contact with food or food contact surfaces, or is used in the manufacture of ice;

(2) Condition and cleanliness of food contact surfaces, including utensils, gloves, and outer garments;

(3) Prevention of cross-contamination from insanitary objects to food, food packaging material, and other

food contact surfaces, including utensils, gloves, and outer garments, and from raw product to cooked product;

(4) Maintenance of hand washing, hand sanitizing, and toilet facilities;

(5) Protection of food, food packaging material, and food contact surfaces from adulteration with lubricants, fuel, pesticides, cleaning compounds, sanitizing agents, condensate, and other chemical, physical, and biological contaminants;

(6) Proper labeling, storage, and use of toxic compounds;

(7) Control of employee health conditions that could result in the microbiological contamination of food, food packaging materials, and food contact surfaces; and

(8) Exclusion of pests from the food plant.

The processor shall correct in a timely manner, those conditions and practices that are not met.

(c) *Sanitation control records.* Each processor shall maintain sanitation control records that, at a minimum, document the monitoring and corrections prescribed by paragraph (b) of this section. These records are subject to the requirements of §123.9.

(d) *Relationship to HACCP plan.* Sanitation controls may be included in the HACCP plan, required by §123.6(b). However, to the extent that they are monitored in accordance with paragraph (b) of this section they need not be included in the HACCP plan, and vice versa.

§ 123.12 Special requirements for imported products.

This section sets forth specific requirements for imported fish and fishery products.

(a) *Importer verification.* Every importer of fish or fishery products shall either:

(1) Obtain the fish or fishery product from a country that has an active memorandum of understanding (MOU) or similar agreement with the Food and Drug Administration, that covers the fish or fishery product and documents the equivalency or compliance of the inspection system of the foreign country with the U.S. system, accurately reflects the current situation between the signing parties, and is func-

tioning and enforceable in its entirety; or

(2) Have and implement written verification procedures for ensuring that the fish and fishery products that they offer for import into the United States were processed in accordance with the requirements of this part. The procedures shall list at a minimum:

(i) Product specifications that are designed to ensure that the product is not adulterated under section 402 of the Federal Food, Drug, and Cosmetic Act because it may be injurious to health or have been processed under insanitary conditions, and,

(ii) Affirmative steps that may include any of the following:

(A) Obtaining from the foreign processor the HACCP and sanitation monitoring records required by this part that relate to the specific lot of fish or fishery products being offered for import;

(B) Obtaining either a continuing or lot-by-lot certificate from an appropriate foreign government inspection authority or competent third party certifying that the imported fish or fishery product is or was processed in accordance with the requirements of this part;

(C) Regularly inspecting the foreign processor's facilities to ensure that the imported fish or fishery product is being processed in accordance with the requirements of this part;

(D) Maintaining on file a copy, in English, of the foreign processor's HACCP plan, and a written guarantee from the foreign processor that the imported fish or fishery product is processed in accordance with the requirements of the part;

(E) Periodically testing the imported fish or fishery product, and maintaining on file a copy, in English, of a written guarantee from the foreign processor that the imported fish or fishery product is processed in accordance with the requirements of this part or,

(F) Other such verification measures as appropriate that provide an equivalent level of assurance of compliance with the requirements of this part.

(b) *Competent third party.* An importer may hire a competent third party to assist with or perform any or all of the

§ 123.15

verification activities specified in paragraph (a)(2) of this section, including writing the importer's verification procedures on the importer's behalf.

(c) *Records.* The importer shall maintain records, in English, that document the performance and results of the affirmative steps specified in paragraph (a)(2)(ii) of this section. These records shall be subject to the applicable provisions of §123.9.

(d) *Determination of compliance.* There must be evidence that all fish and fishery products offered for entry into the United States have been processed under conditions that comply with this part. If assurances do not exist that the imported fish or fishery product has been processed under conditions that are equivalent to those required of domestic processors under this part, the product will appear to be adulterated and will be denied entry.

Subpart B—Smoked and Smoke-Flavored Fishery Products

§ 123.15 General.

This subpart augments subpart A of this part by setting forth specific requirements for processing smoked and smoke-flavored fishery products.

§ 123.16 Process controls.

In order to meet the requirements of subpart A of this part, processors of smoked and smoke-flavored fishery products, except those subject to the requirements of part 113 or 114 of this chapter, shall include in their HACCP plans how they are controlling the food safety hazard associated with the formation of toxin by *Clostridium botulinum* for at least as long as the shelf life of the product under normal and moderate abuse conditions.

Subpart C—Raw Molluscan Shellfish

§ 123.20 General.

This subpart augments subpart A of this part by setting forth specific requirements for processing fresh or frozen molluscan shellfish, where such processing does not include a treatment that ensures the destruction of

vegetative cells of microorganisms of public health concern.

§ 123.28 Source controls.

(a) In order to meet the requirements of subpart A of this part as they apply to microbiological contamination, chemical contamination, natural toxins, and related food safety hazards, processors shall include in their HACCP plans how they are controlling the origin of the molluscan shellfish they process to ensure that the conditions of paragraphs (b), (c), and (d) of this section are met.

(b) Processors shall only process molluscan shellfish harvested from growing waters approved for harvesting by a shellfish control authority. In the case of molluscan shellfish harvested from U.S. Federal waters, the requirements of this paragraph will be met so long as the shellfish have not been harvested from waters that have been closed to harvesting by an agency of the Federal government.

(c) To meet the requirements of paragraph (b) of this section, processors who receive shellstock shall accept only shellstock from a harvester that is in compliance with such licensure requirements as may apply to the harvesting of molluscan shellfish or from a processor that is certified by a shellfish control authority, and that has a tag affixed to each container of shellstock. The tag shall bear, at a minimum, the information required in §1240.60(b) of this chapter. In place of the tag, bulk shellstock shipments may be accompanied by a bill of lading or similar shipping document that contains the information required in §1240.60(b) of this chapter. Processors shall maintain records that document that all shellstock have met the requirements of this section. These records shall document:

- (1) The date of harvest;
- (2) The location of harvest by State and site;
- (3) The quantity and type of shellfish;
- (4) The date of receipt by the processor; and
- (5) The name of the harvester, the name or registration number of the harvester's vessel, or an identification number issued to the harvester by the shellfish control authority.

(d) To meet the requirements of paragraph (b) of this section, processors who receive shucked molluscan shellfish shall accept only containers of shucked molluscan shellfish that bear a label that complies with §1240.60(c) of this chapter. Processors shall maintain records that document that all shucked molluscan shellfish have met the requirements of this section. These records shall document:

- (1) The date of receipt;
- (2) The quantity and type of shellfish; and
- (3) The name and certification number of the packer or repacker of the product.

PART 129—PROCESSING AND BOTTLING OF BOTTLED DRINKING WATER

Subpart A—General Provisions

Sec.

- 129.1 Current good manufacturing practice.
129.3 Definitions.

Subpart B—Buildings and Facilities

- 129.20 Plant construction and design.
129.35 Sanitary facilities.
129.37 Sanitary operations.

Subpart C—Equipment

- 129.40 Equipment and procedures.

Subpart D [Reserved]

Subpart E—Production and Process Controls

- 129.80 Processes and controls.

AUTHORITY: 21 U.S.C. 342, 348, 371, 374; 42 U.S.C. 264.

SOURCE: 42 FR 14355, Mar. 15, 1977, unless otherwise noted.

Subpart A—General Provisions

§ 129.1 Current good manufacturing practice.

The applicable criteria in part 110 of this chapter, as well as the criteria in §§ 129.20, 129.35, 129.37, 129.40, and 129.80 shall apply in determining whether the facilities, methods, practices, and controls used in the processing, bottling, holding, and shipping of bottled drinking water are in conformance with or

are operated or administered in conformity with good manufacturing practice to assure that bottled drinking water is safe and that it has been processed, bottled, held, and transported under sanitary conditions.

§ 129.3 Definitions.

For the purposes of this part, the following definitions apply:

(a) *Approved source* when used in reference to a plant's product water or operations water means a source of water and the water therefrom, whether it be from a spring, artesian well, drilled well, municipal water supply, or any other source, that has been inspected and the water sampled, analyzed, and found to be of a safe and sanitary quality according to applicable laws and regulations of State and local government agencies having jurisdiction. The presence in the plant of current certificates or notifications of approval from the government agency or agencies having jurisdiction constitutes approval of the source and the water supply.

(b) *Bottled drinking water* means all water which is sealed in bottles, packages, or other containers and offered for sale for human consumption, including bottled mineral water.

(c) *Lot* means a collection of primary containers or unit packages of the same size, type, and style produced under conditions as nearly uniform as possible and designated by a common container code or marking.

(d) *Multiservice containers* means containers intended for use more than one time.

(e) *Nontoxic materials* means materials for product water contact surfaces utilized in the transporting, processing, storing, and packaging of bottled drinking water, which are free of substances which may render the water injurious to health or which may adversely affect the flavor, color, odor, or bacteriological quality of the water.

(f) *Operations water* means water which is delivered under pressure to a plant for container washing, hand washing, plant and equipment cleanup and for other sanitary purposes.

(g) *Primary container* means the immediate container in which the product water is packaged.

§ 129.20

(h) *Product water* means processed water used by a plant for bottled drinking water.

(i) *Shall and should*. “Shall” refers to mandatory requirements and “should” refers to recommended or advisory procedures or equipment.

(j) *Shipping case* means a container in which one or more primary containers of the product are held.

(k) *Single-service container* means a container intended for one time usage only.

(l) *Unit package* means a standard commercial package of bottled drinking water, which may consist of one or more containers.

[42 FR 14355, Mar. 6, 1977, as amended at 44 FR 12175, Mar. 6, 1979]

Subpart B—Buildings and Facilities

§ 129.20 Plant construction and design.

(a) The bottling room shall be separated from other plant operations or storage areas by tight walls, ceilings, and self-closing doors to protect against contamination. Conveyor openings shall not exceed the size required to permit passage of containers.

(b) If processing operations are conducted in other than a sealed system under pressure, adequate protection shall be provided to preclude contamination of the water and the system.

(c) Adequate ventilation shall be provided to minimize condensation in processing rooms, bottling rooms, and in container washing and sanitizing areas.

(d) The washing and sanitizing of containers for bottled drinking water shall be performed in an enclosed room. The washing and sanitizing operation shall be positioned within the room so as to minimize any possible post-sanitizing contamination of the containers before they enter the bottling room.

(e) Rooms in which product water is handled, processed, or held or in which containers, utensils, or equipment are washed or held shall not open directly into any room used for domestic household purposes.

21 CFR Ch. I (4–1–07 Edition)

§ 129.35 Sanitary facilities.

Each plant shall provide adequate sanitary facilities including, but not limited to, the following:

(a) *Product water and operations water*—(1) *Product water*. The product water supply for each plant shall be from an approved source properly located, protected, and operated and shall be easily accessible, adequate, and of a safe, sanitary quality which shall be in conformance at all times with the applicable laws and regulations of the government agency or agencies having jurisdiction.

(2) *Operations water*. If different from the product water supply, the operations water supply shall be obtained from an approved source properly located, protected, and operated and shall be easily accessible, adequate, and of a safe, sanitary quality which shall be in conformance at all times with the applicable laws and regulations of the government agency or agencies having jurisdiction.

(3) *Product water and operations water from approved sources*. (i) Samples of source water are to be taken and analyzed by the plant as often as necessary, but at a minimum frequency of once each year for chemical contaminants and once every 4 years for radiological contaminants. Additionally, source water obtained from other than a public water system is to be sampled and analyzed for microbiological contaminants at least once each week. This sampling is in addition to any performed by government agencies having jurisdiction. Records of approval of the source water by government agencies having jurisdiction and of sampling and analyses for which the plant is responsible are to be maintained on file at the plant.

(ii) Test and sample methods shall be those recognized and approved by the government agency or agencies having jurisdiction over the approval of the water source, and shall be consistent with the minimum requirements set forth in § 165.110(b) of this chapter.

(iii) Analysis of the sample may be performed for the plant by competent commercial laboratories (e.g., Environmental Protection Agency (EPA) and State-certified laboratories).

(4) *Source water testing exemptions.* (i) Firms that use a public water system for source water may substitute public water system testing results, or certificates showing full compliance with all provisions of EPA National Primary and Secondary Drinking Water Regulations pertaining to chemical contaminants (40 CFR parts 141 and 143), for the testing requirements of § 129.35(a)(3).

(ii) Firms that do not use a public water system as the source of their water may reduce the frequency of their testing of that source, as well as the number of chemical contaminants for which they test the source water, if they can document that such reduction is consistent with a State-issued waiver under EPA regulations (40 CFR parts 141 and 143).

(iii) Firms that do not use a public water system as the source of their water and whose source water has not been treated with a chlorine-based disinfectant or ozone do not have to test their source water for the residual disinfectants and DBP's listed in § 165.110(b)(4)(iii)(H) of this chapter. Firms that do not use a public water system as the source of their water but whose source water has been treated with a chlorine-based disinfectant or ozone must test their source water for the residual disinfectants and the DBP's listed in § 165.110(b)(4)(iii)(H) that are likely to result from such treatment.

(iv) The finished bottled water must comply with bottled water quality standards (21 CFR 165.110(b)) and section 402(a)(1) of the act dealing with adulterated foods.

(b) *Air under pressure.* Whenever air under pressure is directed at product water or a product water-contact surface, it shall be free of oil, dust, rust, excessive moisture, and extraneous materials; shall not affect the bacteriological quality of the water; and should not adversely affect the flavor, color, or odor of the water.

(c) *Locker and lunchrooms.* When employee locker and lunchrooms are provided, they shall be separate from plant operations and storage areas and shall be equipped with self-closing doors. The rooms shall be maintained in a clean and sanitary condition and refuse containers should be provided.

Packaging or wrapping material or other processing supplies shall not be stored in locker or lunchrooms.

[42 FR 14355, Mar. 15, 1977, as amended at 44 FR 12175, Mar. 6, 1979; 60 FR 57123, Nov. 13, 1995; 66 FR 16865, Mar. 28, 2001]

§ 129.37 Sanitary operations.

(a) The product water-contact surfaces of all multiservice containers, utensils, pipes, and equipment used in the transportation, processing, handling, and storage of product water shall be clean and adequately sanitized. All product water-contact surfaces shall be inspected by plant personnel as often as necessary to maintain the sanitary condition of such surfaces and to assure they are kept free of scale, evidence of oxidation, and other residue. The presence of any unsanitary condition, scale, residue, or oxidation shall be immediately remedied by adequate cleaning and sanitizing of that product water-contact surface prior to use.

(b) After cleaning, all multiservice containers, utensils, and disassembled piping and equipment shall be transported and stored in such a manner as to assure drainage and shall be protected from contamination.

(c) Single-service containers and caps or seals shall be purchased and stored in sanitary closures and kept clean therein in a clean, dry place until used. Prior to use they shall be examined, and as necessary, washed, rinsed, and sanitized and shall be handled in a sanitary manner.

(d) Filling, capping, closing, sealing, and packaging of containers shall be done in a sanitary manner so as to preclude contamination of the bottled drinking water.

Subpart C—Equipment

§ 129.40 Equipment and procedures.

(a) *Suitability.* (1) All plant equipment and utensils shall be suitable for their intended use. This includes all collection and storage tanks, piping, fittings, connections, bottle washers, fillers, cappers, and other equipment which may be used to store, handle, process, package, or transport product water.

(2) All product water contact surfaces shall be constructed of nontoxic and nonabsorbant material which can be

adequately cleaned and sanitized and is in compliance with section 409 of the act.

(b) *Design.* Storage tanks shall be of the type that can be closed to exclude all foreign matter and shall be adequately vented.

Subpart D [Reserved]

Subpart E—Production and Process Controls

§ 129.80 Processes and controls.

(a) *Treatment of product water.* All treatment of product water by distillation, ion-exchanging, filtration, ultraviolet treatment, reverse osmosis, carbonation, mineral addition, or any other process shall be done in a manner so as to be effective in accomplishing its intended purpose and in accordance with section 409 of the Federal Food, Drug, and Cosmetic Act. All such processes shall be performed in and by equipment and with substances which will not adulterate the bottled product. A record of the type and date of physical inspections of such equipment, conditions found, and the performance and effectiveness of such equipment shall be maintained by the plant. Product water samples shall be taken after processing and prior to bottling by the plant and analyzed as often as is necessary to assure uniformity and effectiveness of the processes performed by the plant. The methods of analysis shall be those approved by the government agency or agencies having jurisdiction.

(b) *Containers.* (1) Multiservice primary containers shall be adequately cleaned, sanitized, and inspected just prior to being filled, capped, and sealed. Containers found to be unsanitary or defective by the inspection shall be reprocessed or discarded. All multiservice primary containers shall be washed, rinsed, and sanitized by mechanical washers or by any other method giving adequate sanitary results. Mechanical washers shall be inspected as often as is necessary to assure adequate performance. Records of physical maintenance, inspections and conditions found, and performance of the mechanical washer shall be maintained by the plant.

(2) Multiservice shipping cases shall be maintained in such condition as to assure they will not contaminate the primary container or the product water. Adequate dry or wet cleaning procedures shall be performed as often as necessary to maintain the cases in satisfactory condition.

(c) *Cleaning and sanitizing solutions.* Cleaning and sanitizing solutions utilized by the plant shall be sampled and tested by the plant as often as is necessary to assure adequate performance in the cleaning and sanitizing operations. Records of these tests shall be maintained by the plant.

(d) *Sanitizing operations.* Sanitizing operations, including those performed by chemical means or by any other means such as circulation of live steam or hot water, shall be adequate to effect sanitization of the intended product water-contact surfaces and any other critical area. The plant should maintain a record of the intensity of the sanitizing agent and the time duration that the agent was in contact with the surface being sanitized. The following times and intensities shall be considered a minimum:

(1) Steam in enclosed system: At least 170 °F for at least 15 minutes or at least 200 °F for at least 5 minutes.

(2) Hot water in enclosed system: At least 170 °F for at least 15 minutes or at least 200 °F for at least 5 minutes.

(3) Chemical sanitizers shall be equivalent in bactericidal action to a 2-minute exposure of 50 parts per million of available chlorine at 57 °F when used as an immersion or circulating solution. Chemical sanitizers applied as a spray or fog shall have as a minimum 100 parts per million of available chlorine at 57 °F or its equivalent in bactericidal action.

(4) 0.1 part per million ozone water solution in an enclosed system for at least 5 minutes.

(5) When containers are sanitized using a substance other than one provided for in §178.1010 of this chapter, such substance shall be removed from the surface of the container by a rinsing procedure. The final rinse, prior to filling the container with product water, shall be performed with a disinfected water rinse free of pathogenic bacteria or by an additional sanitizing

procedure equivalent in bactericidal action to that required in paragraph (d)(3) of this section.

(e) *Unit package production code.* Each unit package from a batch or segment of a continuous production run of bottled drinking water shall be identified by a production code. The production code shall identify a particular batch or segment of a continuous production run and the day produced. The plant shall record and maintain information as to the kind of product, volume produced, date produced, lot code used, and the distribution of the finished product to wholesale and retail outlets.

(f) *Filling, capping, or sealing.* During the process of filling, capping or sealing either single-service or multi-service containers, the performance of the filler, capper or sealer shall be monitored and the filled containers visually or electronically inspected to assure they are sound, properly capped or sealed, and coded and labeled. Containers which are not satisfactory shall be reprocessed or rejected. Only nontoxic containers and closures shall be used. All containers and closures shall be sampled and inspected to ascertain that they are free from contamination. At least once each 3 months, a bacteriological swab and/or rinse count should be made from at least four containers and closures selected just prior to filling and sealing. No more than one of the four samples may exceed more than one bacteria per milliliter of capacity or one colony per square centimeter of surface area. All samples shall be free of coliform organisms. The procedure and apparatus for these bacteriological tests shall be in conformance with those recognized by the government agency or agencies having jurisdiction. Tests shall be performed either by qualified plant personnel or a competent commercial laboratory.

(g) *Compliance procedures.* A quality standard for bottled drinking water is established in §165.110(b) of this chapter. To assure that the plant's production of bottled drinking water complies with the applicable standards, laws, and regulations of the government agency or agencies having jurisdiction, the plant will analyze product samples as follows:

(1) For bacteriological purposes, take and analyze at least once a week a representative sample from a batch or segment of a continuous production run for each type of bottled drinking water produced during a day's production. The representative sample shall consist of primary containers of product or unit packages of product.

(2) For chemical, physical, and radiological purposes, take and analyze at least annually a representative sample from a batch or segment of a continuous production run for each type of bottled drinking water produced during a day's production. The representative sample(s) consists of primary containers of product of unit packages of product.

(3) Analyze such samples by methods approved by the government agency or agencies having jurisdiction. The plant shall maintain records of date of sampling, type of product sampled, production code, and results of the analysis.

(h) *Record retention.* All records required by §§129.1, 129.20, 129.35, 129.37, 129.40, and 129.80 shall be maintained at the plant for not less than 2 years. Plants shall also retain, on file at the plant, current certificates or notifications of approval issued by the government agency or agencies approving the plant's source and supply of product water and operations water. All required documents shall be available for official review at reasonable times.

[42 FR 14355, Mar. 15, 1977, as amended at 44 FR 12175, Mar. 6, 1979; 60 FR 57124, Nov. 13, 1995]

PART 130—FOOD STANDARDS: GENERAL

Subpart A—General Provisions

- Sec.
- 130.3 Definitions and interpretations.
 - 130.5 Procedure for establishing a food standard.
 - 130.6 Review of Codex Alimentarius food standards.
 - 130.8 Conformity to definitions and standards of identity.
 - 130.9 Sulfites in standardized food.
 - 130.10 Requirements for foods named by use of a nutrient content claim and a standardized term.
 - 130.11 Label designations of ingredients for standardized foods.

§ 130.3

130.12 General methods for water capacity and fill of containers.

130.14 General statements of substandard quality and substandard fill of container.

130.17 Temporary permits for interstate shipment of experimental packs of food varying from the requirements of definitions and standards of identity.

Subpart B—Food Additives in Standardized Foods

130.20 Food additives proposed for use in foods for which definitions and standards of identity are established.

AUTHORITY: 21 U.S.C. 321, 336, 341, 343, 371.

Subpart A—General Provisions

§ 130.3 Definitions and interpretations.

(a) The definitions and interpretations of terms contained in section 201 of the act shall be applicable also to such terms when used in regulations promulgated under the act.

(b) If a regulation prescribing a definition and standard of identity for a food has been promulgated under section 401 of the act and the name therein specified for the food is used in any other regulation under section 401 or any other provision of the act, such name means the food which conforms to such definition and standard, except as otherwise specifically provided in such other regulation.

(c) No provision of any regulation prescribing a definition and standard of identity or standard of quality or fill of container under section 401 of the act shall be construed as in any way affecting the concurrent applicability of the general provisions of the act and the regulations thereunder relating to adulteration and misbranding. For example, all regulations under section 401 contemplate that the food and all articles used as components or ingredients thereof shall not be poisonous or deleterious and shall be clean, sound, and fit for food. A provision in such regulations for the use of coloring or flavoring does not authorize such use under circumstances or in a manner whereby damage or inferiority is concealed or whereby the food is made to appear better or of greater value than it is.

(d) *Safe and suitable* means that the ingredient:

21 CFR Ch. I (4–1–07 Edition)

(1) Performs an appropriate function in the food in which it is used.

(2) Is used at a level no higher than necessary to achieve its intended purpose in that food.

(3) Is not a food additive or color additive as defined in section 201 (s) or (t) of the Federal Food, Drug, and Cosmetic Act as used in that food, or is a food additive or color additive as so defined and is used in conformity with regulations established pursuant to section 409 or 721 of the act.

(e) Section 403(i) of the act requires the listing of all ingredients in standardized foods. All ingredients must be listed in accordance with the requirements of part 101 of this chapter, except that where a definition and standard of identity has specific labeling provisions for optional ingredients, optional ingredients may be declared in accordance with those provisions.

[42 FR 14357, Mar. 15, 1977, as amended at 58 FR 2876, Jan. 6, 1993]

§ 130.5 Procedure for establishing a food standard.

(a) The procedure for establishing a food standard under section 401 of the act shall be governed by part 10 of this chapter.

(b) Any petition for a food standard shall show that the proposal, if adopted, would promote honesty and fair dealing in the interest of consumers.

(c) Any petition for a food standard shall assert that the petitioner commits himself to substantiate the information in the petition by evidence in a public hearing, if such a hearing becomes necessary.

(d) If a petitioner fails to appear, or to substantiate the information in his petition, at a public hearing on the matter, the Commissioner may either (1) withdraw the regulation and terminate the proceeding or (2) if he concludes that it is in accordance with the requirements of section 401 of the act, continue the proceeding and introduce evidence to substantiate such information.

[42 FR 14357, Mar. 15, 1977, as amended at 42 FR 15673, Mar. 22, 1977]

§ 130.6 Review of Codex Alimentarius food standards.

(a) All food standards adopted by the Codex Alimentarius Commission will be reviewed by the Food and Drug Administration and will be accepted without change, accepted with change, or not accepted.

(b) Review of Codex standards will be accomplished in one of the following three ways:

(1) Any interested person may petition the Commissioner to adopt a Codex standard, with or without change, by proposing a new standard or an appropriate amendment of an existing standard, pursuant to section 401 of the act. Any such petition shall specify any deviations from the Codex standard, and the reasons for any such deviations. The Commissioner shall publish such a petition in the FEDERAL REGISTER as a proposal, with an opportunity for comment, if reasonable grounds are provided in the petition. Any published proposal shall state any deviations from the Codex standard and the stated reasons therefor.

(2) The Commissioner may on his own initiative propose by publication in the FEDERAL REGISTER the adoption of a Codex standard, with or without change, through a new standard or an appropriate amendment to an existing standard, pursuant to section 401 of the act. Any such proposal shall specify any deviations from the Codex standard, and the reasons for any such deviations.

(3) Any Codex standard not handled under paragraph (b) (1) or (2) of this section may be published in the FEDERAL REGISTER for review and informal comment. Interested persons shall be requested to comment on the desirability and need for the standard, on the specific provisions of the standard, on additional or different provisions that should be included in the standard, and on any other pertinent points. After reviewing all such comments, the Commissioner either shall publish a proposal to establish a food standard pursuant to section 401 of the act covering the food involved, or shall publish a notice terminating consideration of such a standard.

(c) All interested persons are encouraged to confer with different interest

groups (consumers, industry, the academic community, professional organizations, and others) in formulating petitions or comments pursuant to paragraph (b) of this section. All such petitions or comments are requested to include a statement of any meetings and discussions that have been held with other interest groups. Appropriate weight will be given by the Commissioner to petitions or comments that reflect a consensus of different interest groups.

§ 130.8 Conformity to definitions and standards of identity.

In the following conditions, among others, a food does not conform to the definition and standard of identity therefor:

(a) If it contains an ingredient for which no provision is made in such definition and standard, unless such ingredient is an incidental additive introduced at a nonfunctional and insignificant level as a result of its deliberate and purposeful addition to another ingredient permitted by the terms of the applicable standard and the presence of such incidental additive in unstandardized foods has been exempted from label declaration as provided in §101.100 of this chapter.

(b) If it fails to contain any one or more ingredients required by such definition and standard;

(c) If the quantity of any ingredient or component fails to conform to the limitation, if any, prescribed therefor by such definition and standard.

§ 130.9 Sulfites in standardized food.

(a) Any standardized food that contains a sulfiting agent or combination of sulfiting agents that is functional and provided for in the applicable standard or that is present in the finished food at a detectable level is misbranded unless the presence of the sulfiting agent or agents is declared on the label of the food. A detectable amount of sulfiting agent is 10 parts per million or more of the sulfite in the finished food. The level of sulfite in the finished food will be determined using sections 20.123 through 20.125, "Sulfurous Acid (Total) in Food Modified Monier-Williams Method Final Action" in "Official Methods of Analysis of the

§ 130.10

Association of Official Analytical Chemists," 14th ed. (1984), which is incorporated by reference in accordance with 5 U.S.C. 552(a) and 1 CFR part 51, and the refinements of the "Total Sulfurous Acid" procedure in the "Monier-Williams Procedure (with Modifications) for Sulfites in Foods," which is appendix A to part 101 of this chapter. A copy of sections 20.123 through 20.125 of the "Official Methods of Analysis of the Association of Official Analytical Chemists" is available from AOAC INTERNATIONAL, 481 North Frederick Ave., suite 500, Gaithersburg, MD 20877, or available for at the National Archives and Records Administration (NARA). For information on the availability of this material at NARA, call 202-741-6030, or go to: http://www.archives.gov/federal_register/code_of_federal_regulations/ibr_locations.html.

(b) Any standardized food that, as a result of actions that are consistent with current good manufacturing practice, contains an indirectly added sulfiting agent that has no functional effect in the food and that would, in the absence of §101.100(a)(4) of this chapter, be considered to be an incidental additive for purposes of §130.8, conforms to the applicable definition and standard of identity if the presence of the sulfiting agent is declared on the label of the food.

[58 FR 2876, Jan. 6, 1993, as amended at 63 FR 14035, Mar. 24, 1998]

§ 130.10 Requirements for foods named by use of a nutrient content claim and a standardized term.

(a) *Description.* The foods prescribed by this general definition and standard of identity are those foods that substitute (see §101.13(d) of this chapter) for a standardized food defined in parts 131 through 169 of this chapter and that use the name of that standardized food in their statement of identity but that do not comply with the standard of identity because of a deviation that is described by an expressed nutrient content claim that has been defined by FDA regulation. The nutrient content claim shall comply with the requirements of §101.13 of this chapter and with the requirements of the regulations in part 101 of this chapter that

21 CFR Ch. I (4-1-07 Edition)

define the particular nutrient content claim that is used. The food shall comply with the relevant standard in all other respects except as provided in paragraphs (b), (c), and (d) of this section.

(b) *Nutrient addition.* Nutrients shall be added to the food to restore nutrient levels so that the product is not nutritionally inferior, as defined in §101.3(e)(4) of this chapter, to the standardized food as defined in parts 131 through 169 of this chapter. The addition of nutrients shall be reflected in the ingredient statement.

(c) *Performance characteristics.* Deviations from noningredient provisions of the standard of identity (e.g., moisture content, food solids content requirements, or processing conditions) are permitted in order that the substitute food possesses performance characteristics similar to those of the standardized food. Deviations from ingredient and noningredient provisions of the standard must be the minimum necessary to qualify for the nutrient content claim while maintaining similar performance characteristics as the standardized food, or the food will be deemed to be adulterated under section 402(b) of the act. The performance characteristics (e.g., physical properties, flavor characteristics, functional properties, shelf life) of the food shall be similar to those of the standardized food as produced under parts 131 through 169 of this chapter, except that if there is a significant difference in performance characteristics that materially limits the uses of the food compared to the uses of the standardized food, the label shall include a statement informing the consumer of such difference (e.g., if appropriate, "not recommended for cooking"). Such statement shall comply with the requirements of §101.13(d) of this chapter. The modified product shall perform at least one of the principal functions of the standardized product substantially as well as the standardized product.

(d) *Other ingredients.* (1) Ingredients used in the product shall be those ingredients provided for by the standard as defined in parts 131 through 169 of this chapter and in paragraph (b) of

this section, except that safe and suitable ingredients may be used to improve texture, add flavor, prevent syneresis, extend shelf life, improve appearance, or add sweetness so that the product is not inferior in performance characteristics to the standardized food defined in parts 131 through 169 of this chapter.

(2) An ingredient or component of an ingredient that is specifically required by the standard (i.e., a mandatory ingredient) as defined in parts 131 through 169 of this chapter, shall not be replaced or exchanged with a similar ingredient from another source unless the standard, as defined in parts 131 through 169 of this chapter, provides for the addition of such ingredient (e.g., vegetable oil shall not replace milkfat in light sour cream).

(3) An ingredient or component of an ingredient that is specifically prohibited by the standard as defined in parts 131 through 169 of this chapter, shall not be added to a substitute food under this section.

(4) An ingredient that is specifically required by the standard as defined in parts 131 through 169 of this chapter, shall be present in the product in a significant amount. A significant amount of an ingredient or component of an ingredient is at least that amount that is required to achieve the technical effect of that ingredient in the food.

(5) Water and fat analogs may be added to replace fat and calories in accordance with §130.10(c), (d)(1), and (d)(2).

(e) *Nomenclature.* The name of a substitute food that complies with all parts of this regulation is the appropriate expressed nutrient content claim and the applicable standardized term.

(f) *Label declaration.* (1) Each of the ingredients used in the food shall be declared on the label as required by the applicable sections of part 101 of this chapter and part 130.

(2) Ingredients not provided for, and ingredients used in excess of those levels provided for, by the standard as defined in parts 131 through 169 of this chapter, shall be identified as such with an asterisk in the ingredient statement, except that ingredients added to restore nutrients to the prod-

uct as required in paragraph (b) of this section shall not be identified with an asterisk. The statement “*Ingredient(s) not in regular _____” (fill in name of the traditional standardized food) or “*Ingredient(s) in excess of amount permitted in regular _____” (fill in name of the traditional standardized food) or both as appropriate shall immediately follow the ingredient statement in the same type size.

[58 FR 2446, Jan. 6, 1993]

§ 130.11 Label designations of ingredients for standardized foods.

Some definitions and standards of identity for foods set forth below require that designated optional ingredients such as spices, flavorings, colorings, emulsifiers, flavor enhancers, stabilizers, preservatives, and sweeteners be declared in a specified manner on the label wherever the name of the standardized food appears on the label so conspicuously as to be easily seen under customary conditions of purchase. Such requirements shall apply to a manufacturer, packer, or distributor of a standardized food only if the words or statements on the label of the standardized food significantly differentiate between two or more foods that comply with the same standard by describing the optional forms or varieties, the packing medium, or significant characterizing ingredients present in the food.

[58 FR 2876, Jan. 6, 1993]

§ 130.12 General methods for water capacity and fill of containers.

For the purposes of regulations promulgated under section 401 of the act:

(a) The term *general method for water capacity of containers* means the following method:

(1) In the case of a container with lid attached by double seam, cut out the lid without removing or altering the height of the double seam.

(2) Wash, dry, and weigh the empty container.

(3) Fill the container with distilled water at 68 °F to $\frac{3}{16}$ inch vertical distance below the top level of the container, and weigh the container thus filled.

(4) Subtract the weight found in paragraph (a)(2) of this section from the weight found in paragraph (a)(3) of this section. The difference shall be considered to be the weight of water required to fill the container.

In the case of a container with lid attached otherwise than by double seam, remove the lid and proceed as directed in paragraphs (a) (2) to (4) of this section, except that under paragraph (a)(3) of this section, fill the container to the level of the top thereof.

(b) The term *general method for fill of containers* means the following method:

(1) In the case of a container with lid attached by double seam, cut out the lid without removing or altering the height of the double seam.

(2) Measure the vertical distance from the top level of the container to the top level of the food.

(3) Remove the food from the container; wash, dry, and weigh the container.

(4) Fill the container with water to $\frac{3}{16}$ inch vertical distance below the top level of the container. Record the temperature of the water, weigh the container thus filled, and determine the weight of the water by subtracting the weight of the container found in paragraph (b)(3) of this section.

(5) Maintaining the water at the temperature recorded in paragraph (b)(4) of this section, draw off water from the container as filled in paragraph (b)(4) of this section to the level of the food found in paragraph (b)(2) of this section, weigh the container with remaining water, and determine the weight of the remaining water by subtracting the weight of the container found in paragraph (b)(3) of this section.

(6) Divide the weight of water found in paragraph (b)(5) of this section by the weight of water found in paragraph (b)(4) of this section, and multiply by 100. The result shall be considered to be the percent of the total capacity of the container occupied by the food.

In the case of a container with lid attached otherwise than by double seam, remove the lid and proceed as directed in paragraphs (b) (2) to (6) of this section, except that under paragraph (b)(4) of this section, fill the container to the level of the top thereof.

§ 130.14 General statements of substandard quality and substandard fill of container.

For the purposes of regulations promulgated under section 401 of the act:

(a) The term *general statement of substandard quality* means the statement "Below Standard in Quality Good Food—Not High Grade" printed in two lines of Cheltenham bold condensed caps. The words "Below Standard in Quality" constitute the first line, and the second immediately follows. If the quantity of the contents of the container is less than 1 pound, the type of the first line is 12-point, and of the second, 8-point. If such quantity is 1 pound or more, the type of the first line is 14-point, and of the second, 10-point. Such statement is enclosed within lines, not less than 6 points in width, forming a rectangle. Such statement, with enclosing lines, is on a strongly contrasting, uniform background, and is so placed as to be easily seen when the name of the food or any pictorial representation thereof is viewed, wherever such name or representation appears so conspicuously as to be easily seen under customary conditions of purchase.

(b) The term *general statement of substandard fill* means the statement "Below Standard in Fill" printed in Cheltenham bold condensed caps. If the quantity of the contents of the container is less than 1 pound, the statement is in 12-point type; if such quantity is 1 pound or more, the statement is in 14-point type. Such statement is enclosed within lines, not less than 6 points in width, forming a rectangle; but if the statement specified in paragraph (a) of this section is also used, both statements (one following the other) may be enclosed within the same rectangle. Such statement or statements, with enclosing lines, are on a strongly contrasting, uniform background, and are so placed as to be easily seen when the name of the food or any pictorial representation thereof is viewed, wherever such name or representation appears so conspicuously as to be easily seen under customary conditions of purchase.

§ 130.17 Temporary permits for interstate shipment of experimental packs of food varying from the requirements of definitions and standards of identity.

(a) The Food and Drug Administration recognizes that before petitions to amend food standards can be submitted, appropriate investigations of potential advances in food technology sometimes require tests in interstate markets of the advantages to and acceptance by consumers of experimental packs of food varying from applicable definitions and standards of identity prescribed under section 401 of the act.

(b) It is the purpose of the Food and Drug Administration to permit such tests when it can be ascertained that the sole purpose of the tests is to obtain data necessary for reasonable grounds in support of a petition to amend food standards, that the tests are necessary to the completion or conclusiveness of an otherwise adequate investigation, and that the interests of consumers are adequately safeguarded; permits for such tests shall normally be for a period not to exceed 15 months. The Food and Drug Administration, or good cause shown by the applicant, may provide for a longer test market period. The Food and Drug Administration will therefore refrain from recommending regulatory proceedings under the act on the charge that a food does not conform to an applicable standard, if the person who introduces or causes the introduction of the food into interstate commerce holds an effective permit from the Food and Drug Administration providing specifically for those variations in respect to which the food fails to conform to the applicable definition and standard of identity. The test period will begin on the date the person holding an effective permit from the Food and Drug Administration introduces or causes the introduction of the food covered by the permit into interstate commerce but not later than 3 months after notice of the issuance of the permit is published in the FEDERAL REGISTER. The Food and Drug Administration shall be notified in writing of the date on which the test period begins as soon as it is determined.

(c) Any person desiring a permit may file with the Team Leader, Conventional Foods Team, Division of Standards and Labeling Regulations, Office of Nutritional Products, Labeling and Dietary Supplements, Center for Food Safety and Applied Nutrition (HFS-822), 5100 Paint Branch Pkwy., College Park, MD 20740, a written application in triplicate containing as part thereof the following:

(1) Name and address of the applicant.

(2) A statement of whether or not the applicant is regularly engaged in producing the food involved.

(3) A reference to the applicable definition and standard of identity (citing applicable section of regulations).

(4) A full description of the proposed variation from the standard.

(5) The basis upon which the food so varying is believed to be wholesome and nondeleterious.

(6) The amount of any new ingredient to be added; the amount of any ingredient, required by the standard, to be eliminated; any change of concentration not contemplated by the standard; or any change in name that would more appropriately describe the new product under test. If such new ingredient is not a commonly known food ingredient, a description of its properties and basis for concluding that it is not a deleterious substance.

(7) The purpose of effecting the variation.

(8) A statement of how the variation is of potential advantage to consumers. The statement shall include the reasons why the applicant does not consider the data obtained in any prior investigations which may have been conducted sufficient to support a petition to amend the standard.

(9) The proposed label (or an accurate draft) to be used on the food to be market tested. The label shall conform in all respects to the general requirements of the act and shall provide a means whereby the consumer can distinguish between the food being tested and such food complying with the standard.

(10) The period during which the applicant desires to introduce such food into interstate commerce, with a statement of the reasons supporting the

need for such period. If a period longer than 15 months is requested, a detailed explanation of why a 15-month period is inadequate shall be provided.

(11) The probable amount of such food that will be distributed. The amount distributed should be limited to the smallest number of units reasonably required for a bona fide market test. Justification for the amount requested shall be included.

(12) The areas of distribution.

(13) The address at which such food will be manufactured.

(14) A statement of whether or not such food has been or is to be distributed in the State in which it was manufactured.

(15) If it has not been or is not to be so distributed, a statement showing why.

(16) If it has been or is to be so distributed, a statement of why it is deemed necessary to distribute such food in other States.

(d) The Food and Drug Administration may require the applicant to furnish samples of the food varying from the standard and to furnish such additional information as may be deemed necessary for action on the application.

(e) If the Food and Drug Administration concludes that the variation may be advantageous to consumers and will not result in failure of the food to conform to any provision of the act except section 403(g), a permit shall be issued to the applicant for interstate shipment of such food. The terms and conditions of the permit shall be those set forth in the application with such modifications, restrictions, or qualifications as the Food and Drug Administration may deem necessary and state in the permit.

(f) The terms and conditions of the permit may be modified at the discretion of the Food and Drug Administration or upon application of the permittee during the effective period of the permit.

(g) The Food and Drug Administration may revoke a permit for cause, which shall include but not be limited to the following:

(1) That the permittee has introduced a food into interstate commerce contrary to the terms and conditions of the permit.

(2) That the application for a permit contains an untrue statement of a material fact.

(3) That the need therefor no longer exists.

(h) During the period within which any permit is effective, it shall be deemed to be included within the terms of any guaranty or undertaking otherwise effective pursuant to the provisions of section 303(c) of the act.

(i) If an application is made for an extension of the permit, it shall be accompanied by a description of experiments conducted under the permit, tentative conclusions reached, and reasons why further experimental shipments are considered necessary. The application for an extension shall be filed not later than 3 months prior to the expiration date of the permit and shall be accompanied by a petition to amend the affected food standard. If the Food and Drug Administration concludes that it will be in the interest of consumers to issue an extension of the time period for the market test, a notice will be published in the FEDERAL REGISTER stating that fact. The notice will include an invitation to all interested persons to participate in the market test under the same conditions that applied to the initial permit holder, including labeling and the amount to be distributed, except that the designated area of distribution shall not apply. The extended market test period shall not begin prior to the publication of a notice in the FEDERAL REGISTER granting the extension and shall terminate either on the effective date of an affirmative order ruling on the proposal or 30 days after a negative order ruling on the proposal, whichever the case may be. Any interested person who accepts the invitation to participate in the extended market test shall notify the Food and Drug Administration in writing of that fact, the amount to be distributed, and the area of distribution; and along with such notification, he shall submit the labeling under which the food is to be distributed.

(j) Notice of the granting or revocation of any permit shall be published in the FEDERAL REGISTER.

(k) All applications for a temporary permit, applications for an extension of a temporary permit, and related

records are available for public disclosure when the notice of a permit or extension thereof is published in the FEDERAL REGISTER. Such disclosure shall be in accordance with the rules established in part 20 of this chapter.

(1) Any person who contests denial, modification, or revocation of a temporary permit shall have an opportunity for a regulatory hearing before the Food and Drug Administration pursuant to part 16 of this chapter.

[42 FR 14357, Mar. 15, 1977, as amended at 42 FR 15673, Mar. 22, 1977; 46 FR 37500, July 21, 1981; 54 FR 24892, June 12, 1989; 59 FR 15051, Mar. 31, 1994; 66 FR 17359, Mar. 30, 2001; 66 FR 56035, Nov. 6, 2001]

Subpart B—Food Additives in Standardized Foods

§ 130.20 Food additives proposed for use in foods for which definitions and standards of identity are established.

(a) Where a petition is received for the issuance or amendment of a regulation establishing a definition and standard of identity for a food under section 401 of the act, which proposes the inclusion of a food additive in such definition and standard of identity, the provisions of the regulations in part 171 of this chapter shall apply with respect to the information that must be submitted with respect to the food additive. Since section 409(b)(5) of the act requires that the Commissioner publish notice of a petition for the establishment of a food additive regulation within 30 days after filing, notice of a petition relating to a definition and standard of identity shall also be published within that time limitation if it includes a request, so designated, for the establishment of a regulation pertaining to a food additive.

(b) If a petition for a definition and standard of identity contains a proposal for a food additive regulation, and the petitioner fails to designate it as such, the Commissioner, upon determining that the petition includes a proposal for a food additive regulation, shall so notify the petitioner and shall thereafter proceed in accordance with the regulations in part 171 of this chapter.

PART 131—MILK AND CREAM

Subpart A—General Provisions

Sec.

131.3 Definitions.

131.25 Whipped cream products containing flavoring or sweetening.

Subpart B—Requirements for Specific Standardized Milk and Cream

- 131.110 Milk.
- 131.111 Acidified milk.
- 131.112 Cultured milk.
- 131.115 Concentrated milk.
- 131.120 Sweetened condensed milk.
- 131.125 Nonfat dry milk.
- 131.127 Nonfat dry milk fortified with vitamins A and D.
- 131.130 Evaporated milk.
- 131.147 Dry whole milk.
- 131.149 Dry cream.
- 131.150 Heavy cream.
- 131.155 Light cream.
- 131.157 Light whipping cream.
- 131.160 Sour cream.
- 131.162 Acidified sour cream.
- 131.170 Eggnog.
- 131.180 Half-and-half.
- 131.200 Yogurt.
- 131.203 Lowfat yogurt.
- 131.206 Nonfat yogurt.

AUTHORITY: 21 U.S.C. 321, 341, 343, 348, 371, 379e.

SOURCE: 42 FR 14360, Mar. 15, 1977, unless otherwise noted.

EDITORIAL NOTE: Nomenclature changes to part 131 appear at 63 FR 14035, Mar. 24, 1998.

Subpart A—General Provisions

§ 131.3 Definitions.

(a) *Cream* means the liquid milk product high in fat separated from milk, which may have been adjusted by adding thereto: Milk, concentrated milk, dry whole milk, skim milk, concentrated skim milk, or nonfat dry milk. Cream contains not less than 18 percent milkfat.

(b) *Pasteurized* when used to describe a dairy product means that every particle of such product shall have been heated in properly operated equipment to one of the temperatures specified in the table of this paragraph and held continuously at or above that temperature for the specified time (or other time/temperature relationship which has been demonstrated to be equivalent thereto in microbial destruction):

§ 131.25

21 CFR Ch. I (4–1–07 Edition)

Temperature	Time
145 °F ¹	30 minutes
161 °F ¹	15 seconds
191 °F	1 second
204 °F	0.05 second
212 °F	0.01 second

¹ If the dairy ingredient has a fat content of 10 percent or more, or if it contains added sweeteners, the specified temperature shall be increased by 5 °F.

(c) *Ultra-pasteurized* when used to describe a dairy product means that such product shall have been thermally processed at or above 280 °F for at least 2 seconds, either before or after packaging, so as to produce a product which has an extended shelf life under refrigerated conditions.

§ 131.25 Whipped cream products containing flavoring or sweetening.

The unqualified name “whipped cream” should not be applied to any product other than one made by whipping the cream that complies with the standards of identity for whipping cream (§§ 131.150 and 131.157 of this chapter). If flavoring and/or sweetening is added, the resulting product is a flavored and/or sweetened whipped cream, and should be so identified.

Subpart B—Requirements for Specific Standardized Milk and Cream

§ 131.110 Milk.

(a) *Description.* Milk is the lacteal secretion, practically free from colostrum, obtained by the complete milking of one or more healthy cows. Milk that is in final package form for beverage use shall have been pasteurized or ultrapasteurized, and shall contain not less than 8¼ percent milk solids not fat and not less than 3¼ percent milkfat. Milk may have been adjusted by separating part of the milkfat therefrom, or by adding thereto cream, concentrated milk, dry whole milk, skim milk, concentrated skim milk, or nonfat dry milk. Milk may be homogenized.

(b) *Vitamin addition* (Optional). (1) If added, vitamin A shall be present in such quantity that each quart of the food contains not less than 2000 International Units thereof within limits of good manufacturing practice.

(2) If added, vitamin D shall be present in such quantity that each quart of the food contains 400 International Units thereof within limits of good manufacturing practice.

(c) *Optional ingredients.* The following safe and suitable ingredients may be used:

(1) Carriers for vitamins A and D.

(2) Characterizing flavoring ingredients (with or without coloring, nutritive sweetener, emulsifiers, and stabilizers) as follows:

(i) Fruit and fruit juice (including concentrated fruit and fruit juice).

(ii) Natural and artificial food flavorings.

(d) *Methods of analysis.* Referenced methods are from “Official Methods of Analysis of the Association of Official Analytical Chemists,” 13th Ed. (1980), which is incorporated by reference. Copies may be obtained from the AOAC INTERNATIONAL, 481 North Frederick Ave., suite 500, Gaithersburg, MD 20877, or may be examined at the National Archives and Records Administration (NARA). For information on the availability of this material at NARA, call 202-741-6030, or go to: http://www.archives.gov/federal_register/code_of_federal_regulations/ibr_locations.html.

(1) Milkfat content—“Fat, Roesegottlieb Method—Official Final Action,” section 16.059.

(2) Milk solids not fat content—Calculated by subtracting the milk fat content from the total solids content as determined by the method “Total Solids, Method I—Official Final Action,” section 16.032.

(3) Vitamin D content—“Vitamin D—Official Final Action,” sections 43.195–43.208.

(e) *Nomenclature.* The name of the food is “milk”. The name of the food shall be accompanied on the label by a declaration indicating the presence of any characterizing flavoring, as specified in § 101.22 of this chapter.

(1) The following terms shall accompany the name of the food wherever it appears on the principal display panel or panels of the label in letters not less than one-half the height of the letters used in such name:

(i) If vitamins are added, the phrase “vitamin A” or “vitamin A added”, or

“vitamin D” or “vitamin D added”, or “vitamin A and D” or “vitamins A and D added”, as is appropriate. The word “vitamin” may be abbreviated “vit.”.

(ii) The word “ultra-pasteurized” if the food has been ultra-pasteurized.

(2) The following terms may appear on the label:

(i) The word “pasteurized” if the food has been pasteurized.

(ii) The word “homogenized” if the food has been homogenized.

(f) *Label declaration.* Each of the ingredients used in the food shall be declared on the label as required by the applicable sections of parts 101 and 130 of this chapter.

[42 FR 14360, Mar. 15, 1977, as amended at 47 FR 11822, Mar. 19, 1982; 49 FR 10090, Mar. 19, 1984; 54 FR 24892, June 12, 1989; 58 FR 2890, Jan. 6, 1993]

§ 131.111 Acidified milk.

(a) *Description.* Acidified milk is the food produced by souring one or more of the optional dairy ingredients specified in paragraph (c) of this section with one or more of the acidifying ingredients specified in paragraph (d) of this section, with or without the addition of characterizing microbial organisms. One or more of the other optional ingredients specified in paragraphs (b) and (e) of this section may also be added. When one or more of the ingredients specified in paragraph (e)(1) of this section are used, they shall be included in the souring process. All ingredients used are safe and suitable. Acidified milk contains not less than 3.25 percent milkfat and not less than 8.25 percent milk solids not fat and has a titratable acidity of not less than 0.5 percent, expressed as lactic acid. The food may be homogenized and shall be pasteurized or ultra-pasteurized prior to the addition of the microbial culture and, when applicable, the addition of flakes or granules of butterfat or milkfat.

(b) *Vitamin addition (optional).* (1) If added, vitamin A shall be present in such quantity that each 946 milliliters (quart) of the food contains not less than 2,000 International Units thereof, within limits of good manufacturing practice.

(2) If added, vitamin D shall be present in such quantity that each 946

milliliters (quart) of the food contains 400 International Units thereof, within limits of good manufacturing practice.

(c) *Optional dairy ingredients.* Cream, milk, partially skimmed milk, or skim milk, used alone or in combination.

(d) *Optional acidifying ingredients.* Acetic acid, adipic acid, citric acid, fumaric acid, glucono- δ -lactone, hydrochloric acid, lactic acid, malic acid, phosphoric acid, succinic acid, and tartaric acid.

(e) *Other optional ingredients.* (1) Concentrated skim milk, nonfat dry milk, buttermilk, whey, lactose, lactalbumins, lactoglobulins, or whey modified by partial or complete removal of lactose and/or minerals, to increase the nonfat solids content of the food: *Provided*, That the ratio of protein to total nonfat solids of the food, and the protein efficiency ratio of all protein present, shall not be decreased as a result of adding such ingredients.

(2) Nutritive carbohydrate sweeteners. Sugar (sucrose), beet or cane; invert sugar (in paste or sirup form); brown sugar; refiner’s sirup; molasses (other than blackstrap); high fructose corn sirup; fructose; fructose sirup; maltose; maltose sirup, dried maltose sirup; malt extract, dried malt extract; malt sirup, dried malt sirup; honey; maple sugar; or any of the sweeteners listed in part 168 of this chapter, except table sirup.

(3) Flavoring ingredients.

(4) Color additives that do not impart a color simulating that of milkfat or butterfat.

(5) Stabilizers.

(6) Butterfat or milkfat, which may or may not contain color additives, in the form of flakes or granules.

(7) Aroma- and flavor-producing microbial culture.

(8) Salt.

(9) Citric acid, in a maximum amount of 0.15 percent by weight of the milk used, or an equivalent amount of sodium citrate, as a flavor precursor.

(f) *Methods of analysis.* The following referenced methods of analysis are from “Official Methods of Analysis of the Association of Official Analytical Chemists,” 13th Ed. (1980), which is incorporated by reference. Copies are available from the AOAC INTERNATIONAL, 481 North Frederick Ave.,

§ 131.112

suite 500, Gaithersburg, MD 20877, or available for inspection at the National Archives and Records Administration (NARA). For information on the availability of this material at NARA, call 202-741-6030, or go to: http://www.archives.gov/federal_register/code_of_federal_regulations/ibr_locations.html.

(1) Milkfat content—As determined by the method prescribed in section 16.059, “Roese-Gottlieb Method (Reference Method) (11)—Official Final Action,” under the heading “Fat.”

(2) Milk solids not fat content—Calculated by subtracting the milkfat content from the total solids content as determined by the method prescribed in section 16.032, “Method I—Official Final Action,” under the heading “Total Solids.”

(3) Titratable acidity—As determined by the method prescribed in section 16.023, “Acidity (2)—Official Final Action,” or by an equivalent potentiometric method.

(g) *Nomenclature.* The name of the food is “acidified milk”. The full name of the food shall appear on the principal display panel of the label in type of uniform size, style, and color. The name of the food shall be accompanied by a declaration indicating the presence of any characterizing flavoring as specified in §101.22 of this chapter, and may be accompanied by a declaration such as a traditional name of the food or the generic name of the organisms used, thereby indicating the presence of the characterizing microbial organisms or ingredients when used, e.g., “acidified kefir milk”, “acidified acidophilus milk”, or when characterizing ingredients such as those in paragraphs (e) (6), (7), (8), and (9) of this section are used, the food may be named “acidified buttermilk”.

(1) The following terms shall accompany the name of the food wherever it appears on the principal display panel or panels of the label in letters not less than one-half of the height of the letters used in such name:

(i) The phrase “vitamin A” or “vitamin A added”, or “vitamin D” or “vitamin D added”, or “vitamins A and D added”, as appropriate. The word “vitamin” may be abbreviated “vit.”.

21 CFR Ch. I (4–1–07 Edition)

(ii) The word “sweetened” if nutritive carbohydrate sweetener is added without the addition of characterizing flavoring.

(2) The term “homogenized” may appear on the label if the dairy ingredients used are homogenized.

(h) *Label declaration.* Each of the ingredients used in the food shall be declared on the label as required by the applicable sections of parts 101 and 130 of this chapter.

[46 FR 9934, Jan. 30, 1981, as amended at 47 FR 11822, Mar. 19, 1982; 47 FR 41523, Sept. 21, 1982; 48 FR 24869, June 3, 1983; 54 FR 24892, June 12, 1989; 58 FR 2890, Jan. 6, 1993]

§ 131.112 Cultured milk.

(a) *Description.* Cultured milk is the food produced by culturing one or more of the optional dairy ingredients specified in paragraph (c) of this section with characterizing microbial organisms. One or more of the other optional ingredients specified in paragraphs (b) and (d) of this section may also be added. When one or more of the ingredients specified in paragraph (d)(1) of this section are used, they shall be included in the culturing process. All ingredients used are safe and suitable. Cultured milk contains not less than 3.25 percent milkfat and not less than 8.25 percent milk solids not fat and has a titratable acidity of not less than 0.5 percent, expressed as lactic acid. The food may be homogenized and shall be pasteurized or ultra-pasteurized prior to the addition to the microbial culture, and when applicable, the addition of flakes or granules of butterfat or milkfat.

(b) *Vitamin addition (optional).* (1) If added, vitamin A shall be present in such quantity that each 946 milliliters (quart) of the food contains not less than 2,000 International Units thereof, within limits of good manufacturing practice.

(2) If added, vitamin D shall be present in such quantity that each 946 milliliters (quart) of the food contains 400 International Units thereof, within limits of good manufacturing practice.

(c) *Optional dairy ingredients.* Cream, milk, partially skimmed milk, or skim milk, used alone or in combination.

(d) *Other optional ingredients.* (1) Concentrated skim milk, nonfat dry milk,

buttermilk, whey, lactose, lactalbumins, lactoglobulins, or whey modified by partial or complete removal of lactose and/or minerals, to increase the nonfat solids content of the food: *Provided*, That the ratio of protein to total nonfat solids of the food, and the protein efficiency ratio of all protein present, shall not be decreased as a result of adding such ingredients.

(2) Nutritive carbohydrate sweeteners. Sugar (sucrose), beet or cane; invert sugar (in paste or sirup form); brown sugar; refiner's sirup; molasses (other than blackstrap); high fructose corn sirup; fructose; fructose sirup; maltose; maltose sirup, dried maltose sirup; malt extract, dried malt extract; malt sirup, dried malt sirup; honey; maple sugar; or any of the sweeteners listed in part 168 of this chapter, except table sirup.

(3) Flavoring ingredients.

(4) Color additives that do not impart a color simulating that of milkfat or butterfat.

(5) Stabilizers.

(6) Butterfat or milkfat, which may or may not contain color additives, in the form of flakes or granules.

(7) Aroma- and flavor-producing microbial culture.

(8) Salt.

(9) Citric acid, in a maximum amount of 0.15 percent by weight of the milk used, or an equivalent amount of sodium citrate, as a flavor precursor.

(e) *Methods of analysis.* The following referenced methods of analysis are from "Official Methods of Analysis of the Association of Official Analytical Chemists," 13th Ed. (1980), which is incorporated by reference. Copies may be obtained from the AOAC INTERNATIONAL, 481 North Frederick Ave., suite 500, Gaithersburg, MD 20877, or available for inspection at the National Archives and Records Administration (NARA). For information on the availability of this material at NARA, call 202-741-6030, or go to: http://www.archives.gov/federal_register/code_of_federal_regulations/ibr_locations.html.

(1) Milkfat content—section 16.059, "Roese-Gottlieb Method (Reference Method) (11)—Official Final Action," under the heading "Fat."

(2) Milk solids not fat content—Calculated by subtracting the milkfat content from the total solids content as determined by the method prescribed in section 16.032, "Method I—Official Final Action," under the heading "Total Solids."

(3) Titratable acidity—As determined by the methods prescribed in section 16.023 "Acidity (2)—Official Final Action," or by an equivalent potentiometric method.

(f) *Nomenclature.* The name of the food is "cultured milk". The full name of the food shall appear on the principal display panel in type of uniform size, style, and color. The name of the food shall be accompanied by a declaration indicating the presence of any characterizing flavoring as specified in §101.22 of this chapter, and may be accompanied by a declaration such as a traditional name of the food or the generic name of the organisms used, thereby indicating the presence of the characterizing microbial organisms or ingredients, e.g., "kefir cultured milk", "acidophilus cultured milk", or when characterizing ingredients such as those in paragraphs (d) (6), (7), (8), and (9) of this section, and lactic acid-producing organisms are used the food may be named "cultured buttermilk".

(1) The following terms shall accompany the name of the food wherever it appears on the principal display panel or panels of the label in letters not less than one-half of the height of the letters used in such name:

(i) The phrase "vitamin A" or "vitamin A added", or "vitamin D" or "vitamin D added", or "vitamin A and D added", as appropriate. The word "vitamin" may be abbreviated "vit."

(ii) The word "sweetened" if nutritive carbohydrate sweetener is added without the addition of characterizing flavoring.

(2) The term "homogenized" may appear on the label if the dairy ingredients used are homogenized.

(g) *Label declaration.* Each of the ingredients used in the food shall be declared on the label as required by the

§ 131.115

21 CFR Ch. I (4–1–07 Edition)

applicable sections of parts 101 and 130 of this chapter.

[46 FR 9934, Jan. 30, 1981, as amended at 47 FR 11822, Mar. 19, 1982; 47 FR 41523, Sept. 21, 1982; 48 FR 24869, June 3, 1983; 54 FR 24892, June 12, 1989; 58 FR 2890, Jan. 6, 1993]

§ 131.115 Concentrated milk.

(a) *Description.* Concentrated milk is the liquid food obtained by partial removal of water from milk. The milkfat and total milk solids contents of the food are not less than 7.5 and 25.5 percent, respectively. It is pasteurized, but is not processed by heat so as to prevent spoilage. It may be homogenized.

(b) *Vitamin addition* (Optional). If added, vitamin D shall be present in such quantity that each fluid ounce of the food contains 25 International Units thereof, within limits of good manufacturing practice.

(c) *Optional ingredients.* The following safe and suitable optional ingredients may be used:

(1) Carrier for vitamin D.

(2) Characterizing flavoring ingredients, with or without coloring, as follows:

(i) Fruit and fruit juice, including concentrated fruit and fruit juice.

(ii) Natural and artificial food flavoring.

(d) *Methods of analysis.* Referenced methods are from “Official Methods of Analysis of the Association of Official Analytical Chemists,” 13th Ed. (1980), which is incorporated by reference. Copies may be obtained from the AOAC INTERNATIONAL, 481 North Frederick Ave., suite 500, Gaithersburg, MD 20877, or may be examined at the National Archives and Records Administration (NARA). For information on the availability of this material at NARA, call 202-741-6030, or go to: http://www.archives.gov/federal_register/code_of_federal_regulations/ibr_locations.html.

(1) Milkfat content—“Fat—Official Final Action,” section 16.172.

(2) Total milk solids—“Total Solids—Official Final Action,” section 16.169.

(3) Vitamin D content—“Vitamin D in Milk—Official Final Action,” sections 43.195–43.208.

(e) *Nomenclature.* The name of the food is “Concentrated milk” or alter-

natively “Condensed milk”. If the food contains added vitamin D, the phrase “vitamin D” or “vitamin D added” shall accompany the name of the food wherever it appears on the principal display panel or panels of the label in letters not less than one-half the height of the letters used in such name. The word “homogenized” may appear on the label if the food has been homogenized. The name of the food shall include a declaration of the presence of any characterizing flavoring, as specified in §101.22 of this chapter.

(f) *Label declaration.* Each of the ingredients used in the food shall be declared on the label as required by the applicable sections of parts 101 and 130 of this chapter.

[42 FR 14360, Mar. 15, 1977, as amended at 47 FR 11822, Mar. 19, 1982; 48 FR 13024, Mar. 29, 1983; 49 FR 10090, Mar. 19, 1984; 54 FR 24892, June 12, 1989; 58 FR 2890, Jan. 6, 1993]

§ 131.120 Sweetened condensed milk.

(a) *Description.* Sweetened condensed milk is the food obtained by partial removal of water only from a mixture of milk and safe and suitable nutritive carbohydrate sweeteners. The finished food contains not less than 8 percent by weight of milkfat, and not less than 28 percent by weight of total milk solids. The quantity of nutritive carbohydrate sweetener used is sufficient to prevent spoilage. The food is pasteurized and may be homogenized.

(b) *Optional ingredients.* The following safe and suitable characterizing flavoring ingredients, with or without coloring and nutritive carbohydrate sweeteners, may be used:

(1) Fruit and fruit juice, including concentrated fruit and fruit juice.

(2) Natural and artificial food flavoring.

(c) *Methods of analysis.* The milkfat content is determined by the method prescribed in “Official Methods of Analysis of the Association of Official Analytical Chemists,” 13th Ed. (1980), section 16.185, under “Fat—Official Final Action,” which is incorporated by reference. Copies may be obtained from the AOAC INTERNATIONAL, 481 North Frederick Ave., suite 500, Gaithersburg, MD 20877, or may be examined at the National Archives and Records Administration (NARA). For

information on the availability of this material at NARA, call 202-741-6030, or go to: http://www.archives.gov/federal_register/code_of_federal_regulations/ibr_locations.html.

(d) *Nomenclature.* The name of the food is “Sweetened condensed milk.” The word “homogenized” may appear on the label if the food has been homogenized. The name of the food shall include a declaration of the presence of any characterizing flavoring, as specified in § 101.22 of this chapter.

(e) *Label declaration.* Each of the ingredients used in the food shall be declared on the label as required by the applicable sections of parts 101 and 130 of this chapter.

[43 FR 21670, May 19, 1978, as amended at 47 FR 11823, Mar. 19, 1982; 49 FR 10091, Mar. 19, 1984; 54 FR 24892, June 12, 1989; 58 FR 2890, Jan. 6, 1993]

§ 131.125 Nonfat dry milk.

(a) *Description.* Nonfat dry milk is the product obtained by removal of water only from pasteurized skim milk. It contains not more than 5 percent by weight of moisture, and not more than 1½ percent by weight of milkfat unless otherwise indicated.

(b) *Optional ingredients.* Safe and suitable characterizing flavoring ingredients (with or without coloring and nutritive carbohydrate sweetener) as follows:

(1) Fruit and fruit juice, including concentrated fruit and fruit juice.

(2) Natural and artificial food flavorings.

(c) *Methods of analysis.* The following referenced methods of analysis are from “Official Methods of Analysis of the Association of Official Analytical Chemists,” 13th Ed. (1980), which is incorporated by reference. Copies may be obtained from the AOAC INTERNATIONAL, 481 North Frederick Ave., suite 500, Gaithersburg, MD 20877, or may be examined at the National Archives and Records Administration (NARA). For information on the availability of this material at NARA, call 202-741-6030, or go to: http://www.archives.gov/federal_register/code_of_federal_regulations/ibr_locations.html.

(1) Milkfat content—“Fat in Dried Milk—Official Final Action,” sections 16.199–16.200.

(2) Moisture content—“Moisture—Official Final Action,” section 16.192.

(d) *Nomenclature.* The name of the food is “Nonfat dry milk”. If the fat content is over 1½ percent by weight, the name of the food on the principal display panel or panels shall be accompanied by the statement “Contains __% milkfat”, the blank to be filled in with the percentage to the nearest one-tenth of 1 percent of fat contained, within limits of good manufacturing practice. The name of the food shall include a declaration of the presence of any characterizing flavoring, as specified in § 101.22 of this chapter.

(e) *Label declaration.* Each of the ingredients used in the food shall be declared on the label as required by the applicable sections of parts 101 and 130 of this chapter.

[42 FR 14360, Mar. 15, 1977, as amended at 43 FR 19836, May 9, 1978; 47 FR 11823, Mar. 19, 1982; 49 FR 10091, Mar. 19, 1984; 54 FR 24892, June 12, 1989; 58 FR 2890, Jan. 6, 1993]

§ 131.127 Nonfat dry milk fortified with vitamins A and D.

(a) *Description.* Nonfat dry milk fortified with vitamins A and D conforms to the standard of identity for nonfat dry milk, except that vitamins A and D are added as prescribed by paragraph (b) of this section.

(b) *Vitamin addition.* (1) Vitamin A is added in such quantity that, when prepared according to label directions, each quart of the reconstituted product contains 2000 International Units thereof.

(2) Vitamin D is added in such quantity that, when prepared according to label directions, each quart of the reconstituted product contains 400 International Units thereof.

(3) The requirements of this paragraph will be deemed to have been met if reasonable overages, within limits of good manufacturing practice, are present to ensure that the required levels of vitamins are maintained throughout the expected shelf life of the food under customary conditions of distribution.

§ 131.130

(c) *Optional ingredients.* The following safe and suitable optional ingredients may be used:

(1) Carriers for vitamins A and D.

(2) Characterizing flavoring ingredients, with or without coloring and nutritive carbohydrate sweetener, as follows:

(i) Fruit and fruit juice, including concentrated fruit and fruit juice.

(ii) Natural and artificial food flavorings.

(d) *Methods of analysis.* The following referenced methods of analysis are from "Official Methods of Analysis of the Association of Official Analytical Chemists," 13th Ed. (1980), which is incorporated by reference. Copies may be obtained from the AOAC INTERNATIONAL, 481 North Frederick Ave., suite 500, Gaithersburg, MD 20877, or may be examined at the National Archives and Records Administration (NARA). For information on the availability of this material at NARA, call 202-741-6030, or go to: http://www.archives.gov/federal_register/code_of_federal_regulations/ibr_locations.html.

(1) Milkfat content—"Fat in Dried Milk—Official Final Action," sections 16.199–16.200.

(2) Moisture content—"Moisture—Official Final Action," section 16.192.

(3) Vitamin D content—"Vitamin D—Official Final Action," sections 43.195–43.208.

(e) *Nomenclature.* The name of the food is "Nonfat dry milk fortified with vitamins A and D". If the fat content is over 1½ percent by weight, the name of the food on the principal display panel or panels shall be accompanied by the statement "Contains ___% milkfat", the blank to be filled in to the nearest one-tenth of 1 percent with the percentage of fat contained within limits of good manufacturing practice. The name of the food shall include a declaration of the presence of any characterizing flavoring, as specified in §101.22 of this chapter.

(f) *Label declaration.* Each of the ingredients used in the food shall be declared on the label as required by the

21 CFR Ch. I (4–1–07 Edition)

applicable sections of parts 101 and 130 of this chapter.

[42 FR 14360, Mar. 15, 1977, as amended at 43 FR 19836, May 9, 1978; 43 FR 29769, July 11, 1978; 43 FR 36622, Aug. 18, 1978; 47 FR 11823, Mar. 19, 1982; 49 FR 10091, Mar. 19, 1984; 54 FR 24892, June 12, 1989; 58 FR 2890, Jan. 6, 1993]

§ 131.130 Evaporated milk.

(a) *Description.* Evaporated milk is the liquid food obtained by partial removal of water only from milk. It contains not less than 6.5 percent by weight of milkfat, not less than 16.5 percent by weight of milk solids not fat, and not less than 23 percent by weight of total milk solids. Evaporated milk contains added vitamin D as prescribed by paragraph (b) of this section. It is homogenized. It is sealed in a container and so processed by heat, either before or after sealing, as to prevent spoilage.

(b) *Vitamin addition.* (1) Vitamin D shall be present in such quantity that each fluid ounce of the food contains 25 International Units thereof within limits of good manufacturing practice.

(2) Addition of vitamin A is optional. If added, vitamin A shall be present in such quantity that each fluid ounce of the food contains not less than 125 International Units thereof within limits of good manufacturing practice.

(c) *Optional ingredients.* The following safe and suitable ingredients may be used:

(1) Carriers for vitamins A and D.

(2) Emulsifiers.

(3) Stabilizers, with or without dioctyl sodium sulfosuccinate (when permitted by and complying with the provisions of §172.810 of this chapter) as a solubilizing agent.

(4) Characterizing flavoring ingredients, with or without coloring and nutritive carbohydrate sweeteners, as follows:

(i) Fruit and fruit juice, including concentrated fruit and fruit juice.

(ii) Natural and artificial food flavoring.

(d) *Methods of analysis.* The following referenced methods of analysis are from "Official Methods of Analysis of the Association of Official Analytical Chemists," 13th Ed. (1980), which is incorporated by reference. Copies may be

obtained from the AOAC INTERNATIONAL, 481 North Frederick Ave., suite 500, Gaithersburg, MD 20877, or may be examined at the National Archives and Records Administration (NARA). For information on the availability of this material at NARA, call 202-741-6030, or go to: http://www.archives.gov/federal_register/code_of_federal_regulations/ibr_locations.html.

(1) Milkfat content—"Fat—Official Final Action," section 16.172.

(2) Total milk solids—"Total Solids—Official Final Action," section 16.169.

(3) Vitamin D content—"Vitamin D in Milk—Official Final Action," sections 43.195–43.208.

(e) *Nomenclature.* The name of the food is "Evaporated milk." The phrase "vitamin D" or "vitamin D added", or "vitamins A and D" or "vitamins A and D added", as is appropriate, shall immediately precede or follow the name of the food wherever it appears on the principal display panel or panels of the label in letters not less than one-half the height of the letters used in such name. The name of the food shall include a declaration of the presence of any characterizing flavoring, as specified in §101.22 of this chapter.

(f) *Label declaration.* Each of the ingredients used in the food shall be declared on the label as required by the applicable sections of parts 101 and 130 of this chapter.

[43 FR 21670, May 19, 1978, as amended at 47 FR 11823, Mar. 19, 1982; 49 FR 10091, Mar. 19, 1984; 54 FR 24892, June 12, 1989; 58 FR 2890, Jan. 6, 1993; 59 FR 17691, Apr. 14, 1994]

§ 131.147 Dry whole milk.

(a) *Description.* Dry whole milk is the product obtained by removal of water only from pasteurized milk, as defined in §131.110(a), which may have been homogenized. Alternatively, dry whole milk may be obtained by blending fluid, condensed, or dried nonfat milk with liquid or dried cream or with fluid, condensed, or dried milk, as appropriate, provided the resulting dry whole milk is equivalent in composition to that obtained by the method described in the first sentence of this paragraph. It contains the lactose, milk proteins, milkfat, and milk minerals in the same relative proportions

as the milk from which it was made. It contains not less than 26 percent but less than 40 percent by weight of milkfat on an as is basis. It contains not more than 5 percent by weight of moisture on a milk solids not fat basis.

(b) *Vitamin addition.* (1) Addition of vitamin A is optional. If added, vitamin A shall be present in such quantity that, when prepared according to label directions, each quart of the reconstituted product shall contain not less than 2,000 International Units thereof.

(2) Addition of vitamin D is optional. If added, vitamin D shall be present in such quantity that, when prepared according to label directions, each quart of the reconstituted product shall contain 400 International Units thereof.

(3) The requirements of this paragraph will be met if reasonable overages, within limits of good manufacturing practice, are present to ensure that the required levels of vitamins are maintained throughout the expected shelf life of the food under customary conditions of distribution.

(c) *Optional ingredients.* The following safe and suitable optional ingredients may be used:

(1) Carriers for vitamins A and D.

(2) Emulsifiers.

(3) Stabilizers.

(4) Anticaking agents.

(5) Antioxidants.

(6) Characterizing flavoring ingredients (with or without coloring and nutritive carbohydrate sweetener) as follows:

(i) Fruit and fruit juice, including concentrated fruit and fruit juice.

(ii) Natural and artificial food flavoring.

(d) *Methods of analysis.* The following referenced methods of analysis are from "Official Methods of Analysis of the Association of Official Analytical Chemists," 13th Ed. (1980), which is incorporated by reference. Copies may be obtained from the AOAC INTERNATIONAL, 481 North Frederick Ave., suite 500, Gaithersburg, MD 20877, or may be examined at the National Archives and Records Administration (NARA). For information on the availability of this material at NARA, call 202-741-6030, or go to: http://www.archives.gov/federal_register/

code_of_federal_regulations/ibr_locations.html.

(1) Milkfat content—“Fat in Dried Milk—Official Final Action,” sections 16.199–16.200.

(2) Moisture content—“Moisture—Official Final Action,” section 16.192.

(3) Vitamin D content—“Vitamin D—Official Final Action,” sections 43.195–43.208.

(e) *Nomenclature.* The name of the food is “Dry whole milk.” The name of the food shall appear on the principal display panel of the label in type of uniform size, style, and color. The name of the food shall be accompanied by a declaration indicating the presence of any characterizing flavoring as specified in §101.22 of this chapter. The following phrases in type size not less than one-half the height of the type size used in such name shall accompany the name of the food wherever it appears on the principal display panel or panels.

(1) The phrase “Contains ___% milkfat”, the blank to be filled in with the whole number closest to the actual fat content of the food.

(2) If vitamins are “added”, the phrase “vitamin A”, or “vitamin A added”, or “vitamin D”, or “vitamin D added”, or “vitamins A and D”, or “vitamins A and D added”, as appropriate. The word “vitamin” may be abbreviated “vit.”

(f) *Label declaration.* Each of the ingredients used in the food shall be declared on the label as required by the applicable sections of parts 101 and 130 of this chapter.

[43 FR 19836, May 9, 1978, as amended at 47 FR 11824, Mar. 19, 1982; 49 FR 10092, Mar. 19, 1984; 54 FR 24893, June 12, 1989; 58 FR 2891, Jan. 6, 1993]

§ 131.149 Dry cream.

(a) *Description.* Dry cream is the product obtained by removal of water only from pasteurized milk or cream or a mixture thereof, which may have been homogenized. Alternatively, dry cream may be obtained by blending dry milks as defined in §§131.125(a) and 131.147(a) with dry cream as appropriate: *Provided*, That the resulting product is equivalent in composition to that obtained by the method described in the first sentence of this paragraph. It con-

tains not less than 40 percent but less than 75 percent by weight of milkfat on an as is basis. It contains not more than 5 percent by weight of moisture on a milk solids not fat basis.

(b) *Optional ingredients.* The following safe and suitable optional ingredients may be used:

(1) Emulsifiers.

(2) Stabilizers.

(3) Anticaking agents.

(4) Antioxidants.

(5) Nutritive carbohydrate sweeteners.

(6) Characterizing flavoring ingredients, with or without coloring, as follows:

(i) Fruit and fruit juice, including concentrated fruit and fruit juice.

(ii) Natural and artificial food flavoring.

(c) *Methods of analysis.* The following referenced methods of analysis are from “Official Methods of Analysis of the Association of Official Analytical Chemists,” 13th Ed. (1980), which is incorporated by reference. Copies may be obtained from the AOAC INTERNATIONAL, 481 North Frederick Ave., suite 500, Gaithersburg, MD 20877, or may be examined at the National Archives and Records Administration (NARA). For information on the availability of this material at NARA, call 202-741-6030, or go to: http://www.archives.gov/federal_register/code_of_federal_regulations/ibr_locations.html.

(1) Milkfat content—“Fat in Dried Milk—Official Final Action,” sections 16.199–16.200.

(2) Moisture content—“Moisture—Official Final Action,” section 16.192.

(d) *Nomenclature.* The name of the food is “Dry cream.” The name of the food shall appear on the principal display panel of the label in type of uniform size, style, and color. The name of the food shall be accompanied by a declaration indicating the presence of any characterizing flavoring as specified in §101.22 of this chapter. The following terms shall accompany the name of the food wherever it appears on the principal display panel or panels of the label, in letters not less than one-half of the height of the letters used in such name:

(1) The phrase “Contains ___% milkfat”, the blank to be filled in with the whole number closest to the actual fat content of the food.

(2) The word “sweetened” if no characterizing flavoring ingredients are used but nutritive carbohydrate sweetener is added.

(e) *Label declaration.* Each of the ingredients used in the food shall be declared on the label as required by the applicable sections of parts 101 and 130 of this chapter.

[43 FR 19836, May 9, 1978, as amended at 44 FR 3965, Jan. 19, 1979; 47 FR 11824, Mar. 19, 1982; 48 FR 13024, Mar. 29, 1983; 49 FR 10092, Mar. 19, 1984; 54 FR 24893, June 12, 1989; 58 FR 2891, Jan. 6, 1993; 61 FR 59002, Nov. 20, 1996]

§ 131.150 Heavy cream.

(a) *Description.* Heavy cream is cream which contains not less than 36 percent milkfat. It is pasteurized or ultra-pasteurized, and may be homogenized.

(b) *Optional ingredients.* The following safe and suitable optional ingredients may be used:

(1) Emulsifiers.

(2) Stabilizers.

(3) Nutritive sweeteners.

(4) Characterizing flavoring ingredients (with or without coloring) as follows:

(i) Fruit and fruit juice (including concentrated fruit and fruit juice).

(ii) Natural and artificial food flavoring.

(c) *Methods of analysis.* The milkfat content is determined by the method prescribed in “Official Methods of Analysis of the Association of Official Analytical Chemists,” 13th Ed. (1980), sections 16.156 and 16.059, under “Fat, Roese-Gottlieb Method—Official Final Action,” which is incorporated by reference. Copies may be obtained from the AOAC INTERNATIONAL, 481 North Frederick Ave., suite 500, Gaithersburg, MD 20877, or may be examined at the National Archives and Records Administration (NARA). For information on the availability of this material at NARA, call 202-741-6030, or go to: http://www.archives.gov/federal_register/code_of_federal_regulations/ibr_locations.html.

(d) *Nomenclature.* (1) The name of the food is “Heavy cream” or alternatively “Heavy whipping cream”. The name of

the food shall be accompanied on the label by a declaration indicating the presence of any characterizing flavoring, as specified in §101.22 of this chapter. The following terms shall accompany the name of the food wherever it appears on the principal display panel or panels of the label in letters not less than one-half the height of the letters used in such name:

(i) The word “ultra-pasteurized” if the food has been ultra-pasteurized.

(ii) The word “sweetened” if no characterizing flavoring ingredients are used, but nutritive sweetener is added.

(2) The following terms may appear on the label:

(i) The word “pasteurized” if the food has been pasteurized.

(ii) The word “homogenized” if the food has been homogenized.

(e) *Label declaration.* Each of the ingredients used in the food shall be declared on the label as required by the applicable sections of parts 101 and 130 of this chapter.

[42 FR 14360, Mar. 15, 1977, as amended at 47 FR 11824, Mar. 19, 1982; 49 FR 10092, Mar. 19, 1984; 54 FR 24893, June 12, 1989; 58 FR 2891, Jan. 6, 1993]

§ 131.155 Light cream.

(a) *Description.* Light cream is cream which contains not less than 18 percent but less than 30 percent milkfat. It is pasteurized or ultra-pasteurized, and may be homogenized.

(b) *Optional ingredients.* The following safe and suitable ingredients may be used:

(1) Stabilizers.

(2) Emulsifiers.

(3) Nutritive sweeteners.

(4) Characterizing flavoring ingredients (with or without coloring) as follows:

(i) Fruit and fruit juice (including concentrated fruit and fruit juice).

(ii) Natural and artificial food flavoring.

(c) *Methods of analysis.* The milkfat content is determined by the method prescribed in “Official Methods of Analysis of the Association of Official Analytical Chemists,” 13th Ed. (1980), sections 16.156 and 16.059, under “Fat, Roese-Gottlieb Method—Official Final Action,” which is incorporated by reference. Copies may be obtained from

the AOAC INTERNATIONAL, 481 North Frederick Ave., suite 500, Gaithersburg, MD 20877, or may be examined at the National Archives and Records Administration (NARA). For information on the availability of this material at NARA, call 202–741–6030, or go to: http://www.archives.gov/federal_register/code_of_federal_regulations/ibr_locations.html.

(d) *Nomenclature.* The name of the food is “Light cream”, or alternatively “Coffee cream” or “Table cream”. The name of the food shall be accompanied on the label by a declaration indicating the presence of any characterizing flavoring, as specified in §101.22 of this chapter.

(1) The following terms shall accompany the name of the food wherever it appears on the principal display panel or panels of the label in letters not less than one-half the height of the letters used in such name:

(i) The word “ultra-pasteurized” if the food has been ultra-pasteurized.

(ii) The word “sweetened” if no characterizing flavoring ingredients are used, but nutritive sweetener is added.

(2) The following terms may appear on the label:

(i) The word “pasteurized” if the food has been pasteurized.

(ii) The word “homogenized” if the food has been homogenized.

(e) *Label declaration.* Each of the ingredients used in the food shall be declared on the label as required by the applicable sections of parts 101 and 130 of this chapter.

[42 FR 14360, Mar. 15, 1977, as amended at 47 FR 11824, Mar. 19, 1982; 49 FR 10092, Mar. 1, 1984; 54 FR 24893, June 12, 1989; 58 FR 2891, Jan. 6, 1993]

§ 131.157 Light whipping cream.

(a) *Description.* Light whipping cream is cream which contains not less than 30 percent but less than 36 percent milkfat. It is pasteurized or ultra-pasteurized, and may be homogenized.

(b) *Optional ingredients.* The following safe and suitable optional ingredients may be used:

(1) Emulsifiers.

(2) Stabilizers.

(3) Nutritive sweeteners.

(4) Characterizing flavoring ingredients (with or without coloring) as follows:

(i) Fruit and fruit juice (including concentrated fruit and fruit juice).

(ii) Natural and artificial food flavoring.

(c) *Methods of analysis.* The milkfat content is determined by the method prescribed in “Official Methods of Analysis of the Association of Official Analytical Chemists,” 13th Ed. (1980), sections 16.156 and 16.059, under “Fat, Roesse-Gottlieb Method—Official Final Action,” which is incorporated by reference. Copies may be obtained from the AOAC INTERNATIONAL, 481 North Frederick Ave., suite 500, Gaithersburg, MD 20877, or may be examined at the National Archives and Records Administration (NARA). For information on the availability of this material at NARA, call 202–741–6030, or go to: http://www.archives.gov/federal_register/code_of_federal_regulations/ibr_locations.html.

(d) *Nomenclature.* The name of the food is “Light whipping cream” or alternatively “Whipping cream”. The name of the food shall be accompanied on the label by a declaration indicating the presence of any characterizing flavoring, as specified in §101.22 of this chapter.

(1) The following terms shall accompany the name of the food wherever it appears on the principal display panel or panels of the label in letters not less than one-half the height of the letters used in such name:

(i) The word “ultra-pasteurized” if the food has been ultra-pasteurized.

(ii) The word “sweetened” if no characterizing flavoring ingredients are used, but nutritive sweetener is added.

(2) The following terms may appear on the label:

(i) The word “pasteurized” if the food has been pasteurized.

(ii) The word “homogenized” if the food has been homogenized.

(e) *Label declaration.* Each of the ingredients used in the food shall be declared on the label as required by the

applicable sections of parts 101 and 130 of this chapter.

[42 FR 14360, Mar. 15, 1977, as amended at 47 FR 11824, Mar. 19, 1982; 49 FR 10092, Mar. 19, 1984; 54 FR 24893, June 12, 1989; 58 FR 2891, Jan. 6, 1993]

§ 131.160 Sour cream.

(a) *Description.* Sour cream results from the souring, by lactic acid producing bacteria, of pasteurized cream. Sour cream contains not less than 18 percent milkfat; except that when the food is characterized by the addition of nutritive sweeteners or bulky flavoring ingredients, the weight of the milkfat is not less than 18 percent of the remainder obtained by subtracting the weight of such optional ingredients from the weight of the food; but in no case does the food contain less than 14.4 percent milkfat. Sour cream has a titratable acidity of not less than 0.5 percent, calculated as lactic acid.

(b) *Optional ingredients.* (1) Safe and suitable ingredients that improve texture, prevent syneresis, or extend the shelf life of the product.

(2) Sodium citrate in an amount not more than 0.1 percent may be added prior to culturing as a flavor precursor.

(3) Rennet.

(4) Safe and suitable nutritive sweeteners.

(5) Salt.

(6) Flavoring ingredients, with or without safe and suitable coloring, as follows:

(i) Fruit and fruit juice (including concentrated fruit and fruit juice).

(ii) Safe and suitable natural and artificial food flavoring.

(c) *Methods of analysis.* Referenced methods in paragraph (c) (1) and (2) of this section are from "Official Methods of Analysis of the Association of Official Analytical Chemists," 13th Ed. (1980), which is incorporated by reference. Copies may be obtained from the AOAC INTERNATIONAL, 481 North Frederick Ave., suite 500, Gaithersburg, MD 20877, or may be examined at the National Archives and Records Administration (NARA). For information on the availability of this material at NARA, call 202-741-6030, or go to: http://www.archives.gov/federal_register/code_of_federal_regulations/ibr_locations.html.

(1) Milkfat content—"Fat—Official Final Action," section 16.172.

(2) Titratable acidity—"Acidity—Official Final Action," section 16.023.

(d) *Nomenclature.* The name of the food is "Sour cream" or alternatively "Cultured sour cream". The full name of the food shall appear on the principal display panel of the label in type of uniform size, style, and color. The name of the food shall be accompanied by a declaration indicating the presence of any flavoring that characterizes the product, as specified in §101.22 of this chapter. If nutritive sweetener in an amount sufficient to characterize the food is added without addition of characterizing flavoring, the name of the food shall be preceded by the word "sweetened".

(e) *Label declaration.* Each of the ingredients used in the food shall be declared on the label as required by the applicable sections of parts 101 and 130 of this chapter.

[42 FR 14360, Mar. 15, 1977, as amended at 47 FR 11824, Mar. 19, 1982; 49 FR 10092, Mar. 19, 1984; 54 FR 24893, June 12, 1989; 58 FR 2891, Jan. 6, 1993]

§ 131.162 Acidified sour cream.

(a) *Description.* Acidified sour cream results from the souring of pasteurized cream with safe and suitable acidifiers, with or without addition of lactic acid producing bacteria. Acidified sour cream contains not less than 18 percent milkfat; except that when the food is characterized by the addition of nutritive sweeteners or bulky flavoring ingredients, the weight of milkfat is not less than 18 percent of the remainder obtained by subtracting the weight of such optional ingredients from the weight of the food; but in no case does the food contain less than 14.4 percent milkfat. Acidified sour cream has a titratable acidity of not less than 0.5 percent, calculated as lactic acid.

(b) *Optional ingredients.* (1) Safe and suitable ingredients that improve texture, prevent syneresis, or extend the shelf life of the product.

(2) Rennet.

(3) Safe and suitable nutritive sweeteners.

(4) Salt.

(5) Flavoring ingredients, with or without safe and suitable coloring, as follows:

(i) Fruit and fruit juice, including concentrated fruit and fruit juice.

(ii) Safe and suitable natural and artificial food flavoring.

(c) *Methods of analysis.* Referenced methods in paragraphs (c) (1) and (2) of this section are from “Official Methods of Analysis of the Association of Official Analytical Chemists,” 13th Ed. (1980), which is incorporated by reference. Copies may be obtained from the AOAC INTERNATIONAL, 481 North Frederick Ave., suite 500, Gaithersburg, MD 20877, or may be examined at the National Archives and Records Administration (NARA). For information on the availability of this material at NARA, call 202-741-6030, or go to: http://www.archives.gov/federal_register/code_of_federal_regulations/ibr_locations.html.

(1) Milkfat content—“Fat—Official Final Action,” section 16.172.

(2) Titratable acidity—“Acidity—Official Final Action,” section 16.023.

(d) *Nomenclature.* The name of the food is “Acidified sour cream”. The full name of the food shall appear on the principal display panel of the label in type of uniform size, style, and color. The name of the food shall be accompanied by a declaration indicating the presence of any flavoring that characterizes the product, as specified in §101.22 of this chapter. If nutritive sweetener in an amount sufficient to characterize the food is added without addition of characterizing flavoring, the name of the food shall be preceded by the word “sweetened”.

(e) *Label declaration.* Each of the ingredients used in the food shall be declared on the label as required by the applicable sections of parts 101 and 130 of this chapter.

[42 FR 14360, Mar. 15, 1977, as amended at 47 FR 11825, Mar. 19, 1982; 49 FR 10092, Mar. 19, 1984; 54 FR 24893, June 12, 1989; 58 FR 2891, Jan. 6, 1993]

§ 131.170 Eggnog.

(a) *Description.* Eggnog is the food containing one or more of the optional dairy ingredients specified in paragraph (b), one or more of the optional egg yolk-containing ingredients speci-

fied in paragraph (c) of this section, and one or more of the optional nutritive carbohydrate sweeteners specified in paragraph (d) of this section. One or more of the optional ingredients specified in paragraph (e) of this section may also be added. All ingredients used are safe and suitable. Eggnog contains not less than 6 percent milkfat and not less than 8.25 percent milk solids not fat. The egg yolk solids content is not less than 1 percent by weight of the finished food. The food shall be pasteurized or ultra-pasteurized and may be homogenized. Flavoring ingredients and color additives may be added after the food is pasteurized or ultra-pasteurized.

(b) *Optional dairy ingredients.* Cream, milk, partially skimmed milk, or skim milk, used alone or in combination.

(c) *Egg yolk-containing ingredients.* Liquid egg yolk, frozen egg yolk, dried egg yolk, liquid whole eggs, frozen whole eggs, dried whole eggs, or any one or more of the foregoing ingredients with liquid egg white or frozen egg white.

(d) *Nutritive carbohydrate sweeteners.* Sugar (sucrose), beet or cane; invert sugar (in paste or sirup form); brown sugar; refiner’s sirup; molasses (other than blackstrap); high fructose corn sirup; fructose; fructose sirup; maltose; maltose sirup, dried maltose sirup; malt extract, dried malt extract; malt sirup, dried malt sirup; honey; maple sugar; or any of the sweeteners listed in part 168 of this chapter, except table sirup.

(e) *Other optional ingredients.* (1) Concentrated skim milk, nonfat dry milk, buttermilk, whey, lactose, lactalbumins, lactoglobulins, or whey modified by partial or complete removal of lactose and/or minerals, to increase the nonfat solids content of the food: *Provided*, That the ratio of protein to total nonfat solids of the food, and the protein efficiency ratio of all protein present shall not be decreased as a result of adding such ingredients.

(2) Salt.

(3) Flavoring ingredients.

(4) Color additives that do not impart a color simulating that of egg yolk, milkfat, or butterfat.

(5) Stabilizers.

(f) *Methods of analysis.* The following referenced methods of analysis are from “Official Methods of Analysis of the Association of Official Analytical Chemists,” 13th Ed. (1980), which is incorporated by reference. Copies are available from the AOAC INTERNATIONAL, 481 North Frederick Ave., suite 500, Gaithersburg, MD 20877, or available for inspection at the National Archives and Records Administration (NARA). For information on the availability of this material at NARA, call 202-741-6030, or go to: http://www.archives.gov/federal_register/code_of_federal_regulations/ibr_locations.html.

(1) Milkfat content—As determined by the method prescribed in section 16.059, “Roese-Gottlieb Method (Reference Method) (1)—Official Final Action,” under the heading “Fat.”

(2) Milk solids not fat content—Calculated by subtracting the milkfat content from the total solids content as determined by the method prescribed in section 16.032, “Method I—Official Final Action,” under the heading “Total Solids.”

(g) *Nomenclature.* The name of the food is “eggnog”. The name of the food shall be accompanied by a declaration indicating the presence of any characterizing flavoring as specified in §101.22 of this chapter. If the food is ultra-pasteurized, the phrase “ultra-pasteurized” shall accompany the name of the food wherever it appears on the label in letters not less than one-half of the height of the letters used in the name. The following terms may accompany the name of the food on the label:

(1) The word “pasteurized” if the food has been pasteurized.

(2) The word “homogenized” if the food has been homogenized.

(h) *Label declaration.* Each of the ingredients used in the food shall be declared on the label as required by the applicable sections of parts 101 and 130 of this chapter.

[46 FR 9938, Jan. 30, 1981, as amended at 47 FR 11825, Mar. 19, 1982; 47 FR 41524, Sept. 21, 1982; 47 FR 49638, Nov. 2, 1982; 48 FR 24869, June 3, 1983; 54 FR 24893, June 12, 1989; 58 FR 2891, Jan. 6, 1993]

§ 131.180 Half-and-half.

(a) *Description.* Half-and-half is the food consisting of a mixture of milk and cream which contains not less than 10.5 percent but less than 18 percent milkfat. It is pasteurized or ultra-pasteurized, and may be homogenized.

(b) *Optional ingredients.* The following safe and suitable optional ingredients may be used:

(1) Emulsifiers.

(2) Stabilizers.

(3) Nutritive sweeteners.

(4) Characterizing flavoring ingredients (with or without coloring) as follows:

(i) Fruit and fruit juice (including concentrated fruit and fruit juice).

(ii) Natural and artificial food flavoring.

(c) *Methods of analysis.* The milkfat content is determined by the method prescribed in “Official Methods of Analysis of the Association of Official Analytical Chemists,” 13th Ed. (1980), in sections 16.156 and 16.059, under “Fat, Roese-Gottlieb Method—Official Final Action,” which is incorporated by reference. Copies may be obtained from the AOAC INTERNATIONAL, 481 North Frederick Ave., suite 500, Gaithersburg, MD 20877, at the National Archives and Records Administration (NARA). For information on the availability of this material at NARA, call 202-741-6030, or go to: http://www.archives.gov/federal_register/code_of_federal_regulations/ibr_locations.html.

(d) *Nomenclature.* The name of the food is “Half-and-half”. The name of the food shall be accompanied on the label by a declaration indicating the presence of any characterizing flavoring, as specified in §101.22 of this chapter.

(1) The following terms shall accompany the name of the food wherever it appears on the principal display panel or panels of the label in letters not less than one-half the height of the letters used in such name:

(i) The word “ultra-pasteurized” if the food has been ultra-pasteurized.

(ii) The word “sweetened” if no characterizing flavor ingredients are used, but nutritive sweetener is added.

(2) The following terms may appear on the label:

§ 131.200

21 CFR Ch. I (4–1–07 Edition)

(i) The word “pasteurized” if the food has been pasteurized.

(ii) The word “homogenized” if the food has been homogenized.

(e) *Label declaration.* Each of the ingredients used in the food shall be declared on the label as required by the applicable sections of parts 101 and 130 of this chapter.

[42 FR 14360, Mar. 15, 1977, as amended at 47 FR 11825, Mar. 19, 1982; 49 FR 10092, Mar. 19, 1984; 54 FR 24893, June 12, 1989; 58 FR 2891, Jan. 6, 1993]

§ 131.200 **Yogurt.**

(a) *Description.* Yogurt is the food produced by culturing one or more of the optional dairy ingredients specified in paragraph (c) of this section with a characterizing bacterial culture that contains the lactic acid-producing bacteria, *Lactobacillus bulgaricus* and *Streptococcus thermophilus*. One or more of the other optional ingredients specified in paragraphs (b) and (d) of this section may also be added. When one or more of the ingredients specified in paragraph (d)(1) of this section are used, they shall be included in the culturing process. All ingredients used are safe and suitable. Yogurt, before the addition of bulky flavors, contains not less than 3.25 percent milkfat and not less than 8.25 percent milk solids not fat, and has a titratable acidity of not less than 0.9 percent, expressed as lactic acid. The food may be homogenized and shall be pasteurized or ultra-pasteurized prior to the addition of the bacterial culture. Flavoring ingredients may be added after pasteurization or ultra-pasteurization. To extend the shelf life of the food, yogurt may be heat treated after culturing is completed, to destroy viable microorganisms.

(b) *Vitamin addition (optional).* (1) If added, vitamin A shall be present in such quantity that each 946 milliliters (quart) of the food contains not less than 2,000 International Units thereof, within limits of current good manufacturing practice.

(2) If added, vitamin D shall be present in such quantity that each 946 milliliters (quart) of the food contains 400 International Units thereof, within limits of current good manufacturing practice.

(c) *Optional dairy ingredients.* Cream, milk, partially skimmed milk, or skim milk, used alone or in combination.

(d) *Other optional ingredients.* (1) Concentrated skim milk, nonfat dry milk, buttermilk, whey, lactose, lactalbumins, lactoglobulins, or whey modified by partial or complete removal of lactose and/or minerals, to increase the nonfat solids content of the food: *Provided*, That the ratio of protein to total nonfat solids of the food, and the protein efficiency ratio of all protein present shall not be decreased as a result of adding such ingredients.

(2) Nutritive carbohydrate sweeteners. Sugar (sucrose), beet or cane; invert sugar (in paste or sirup form); brown sugar; refiner’s sirup; molasses (other than blackstrap); high fructose corn sirup; fructose; fructose sirup; maltose; maltose sirup, dried maltose sirup; malt extract, dried malt extract; malt sirup, dried malt sirup; honey; maple sugar; or any of the sweeteners listed in part 168 of this chapter, except table sirup.

(3) Flavoring ingredients.

(4) Color additives.

(5) Stabilizers.

(e) *Methods of analysis.* The following referenced methods of analysis are from “Official Methods of Analysis of the Association of Official Analytical Chemists,” 13th Ed. (1980), which is incorporated by reference. Copies are available from the AOAC INTERNATIONAL, 481 North Frederick Ave., suite 500, Gaithersburg, MD 20877, or available for inspection at the National Archives and Records Administration (NARA). For information on the availability of this material at NARA, call 202-741-6030, or go to: http://www.archives.gov/federal_register/code_of_federal_regulations/ibr_locations.html.

(1) Milkfat content—As determined by the method prescribed in section 16.059 “Roese-Gottlieb Method (Reference Method) (11)—Official Final Action,” under the heading “Fat.”

(2) Milk solids not fat content—Calculated by subtracting the milkfat content from the total solids content as determined by the method prescribed in section 16.032, “Method I—Official Final Action,” under the heading “Total Solids.”

(3) Titratable acidity—As determined by the method prescribed in section 16.023, “Acidity (2)—Official Final Action,” or by an equivalent potentiometric method.

(f) *Nomenclature.* The name of the food is “yogurt”. The name of the food shall be accompanied by a declaration indicating the presence of any characterizing flavoring as specified in §101.22 of this chapter.

(1) The following terms shall accompany the name of the food wherever it appears on the principal display panel or panels of the label in letters not less than one-half of the height of the letters used in such name:

(i) The word “sweetened” if nutritive carbohydrate sweetener is added without the addition of characterizing flavor.

(ii) The parenthetical phrase “(heat-treated after culturing)” shall follow the name of the food if the dairy ingredients have been heat-treated after culturing.

(iii) The phrase “vitamin A” or “vitamin A added”, or “vitamin D” or “vitamin D added”, or “vitamins A and D added”, as appropriate. The word “vitamin” may be abbreviated “vit”.

(2) The term “homogenized” may appear on the label if the dairy ingredients used are homogenized.

(g) *Label declaration.* Each of the ingredients used in the food shall be declared on the label as required by the applicable sections of parts 101 and 130 of this chapter.

[46 FR 9939, Jan. 30, 1981, as amended at 47 FR 11825, Mar. 19, 1982; 47 FR 41524, Sept. 21, 1982; 48 FR 24869, June 3, 1983; 54 FR 24893, June 12, 1989; 58 FR 2891, Jan. 6, 1993]

§ 131.203 Lowfat yogurt.

(a) *Description.* Lowfat yogurt is the food produced by culturing one or more of the optional dairy ingredients specified in paragraph (c) of this section with a characterizing bacterial culture that contains the lactic acid-producing bacteria, *Lactobacillus bulgaricus* and *Streptococcus thermophilus*. One or more of the other optional ingredients specified in paragraphs (b) and (d) of this section may also be added. When one or more of the ingredients specified in paragraph (d)(1) of this section are used, they shall be included in the cul-

turing process. All ingredients used are safe and suitable. Lowfat yogurt, before the addition of bulky flavors, contains not less than 0.5 percent nor more than 2 percent milkfat and not less than 8.25 percent milk solids not fat, and has a titratable acidity of not less than 0.9 percent, expressed as lactic acid. The food may be homogenized and shall be pasteurized or ultra-pasteurized prior to the addition of the bacterial culture. Flavoring ingredients may be added after pasteurization or ultra-pasteurization. To extend the shelf life of the food, lowfat yogurt may be heat treated after culturing is completed, to destroy viable microorganisms.

(b) *Vitamin addition (optional).* (1) If added, vitamin A shall be present in such quantity that each 946 milliliters (quart) of the food contains not less than 2,000 International Units thereof, within limits of current good manufacturing practice.

(2) If added, vitamin D shall be present in such quantity that each 946 milliliters (quart) of the food contains 400 International Units thereof, within limits of current good manufacturing practice.

(c) *Optional dairy ingredients.* Cream, milk, partially skimmed milk, or skim milk, used alone or in combination.

(d) *Other optional ingredients.* (1) Concentrated skim milk, nonfat dry milk, buttermilk, whey, lactose, lactalbumins, lactoglobulins, or whey modified by partial or complete removal of lactose and/or minerals, to increase the nonfat solids content of the food: *Provided*, That the ratio of protein to total nonfat solids of the food, and the protein efficiency ratio of all protein present shall not be decreased as a result of adding such ingredients.

(2) Nutritive carbohydrate sweeteners. Sugar (sucrose), beet or cane; invert sugar (in paste or sirup form); brown sugar; refiner’s sirup; molasses (other than blackstrap); high fructose corn sirup; fructose; fructose sirup; maltose, maltose sirup, dried maltose sirup; malt extract, dried malt extract; malt sirup, dried malt sirup; honey; maple sugar; or any of the sweeteners listed in part 168 of this chapter, except table sirup.

(3) Flavoring ingredients.

(4) Color additives.

(5) Stabilizers.

(e) *Methods of analysis.* The following referenced methods of analysis are from “Official Methods of Analysis of the Association of Official Analytical Chemists,” 13th Ed. (1980), which is incorporated by reference. Copies are available from the AOAC INTERNATIONAL, 481 North Frederick Ave., suite 500, Gaithersburg, MD 20877 or available for inspection at the National Archives and Records Administration (NARA). For information on the availability of this material at NARA, call 202-741-6030, or go to: http://www.archives.gov/federal_register/code_of_federal_regulations/ibr_locations.html.

(1) Milkfat content—As determined by the method prescribed in section 16.059 “Roese-Gottlieb Method (Reference Method) (11)—Official Final Action,” under the heading “Fat.”

(2) Milk solids not fat content—Calculated by subtracting the milkfat content from the total solids content as determined by the method prescribed in section 16.032, “Method I—Official Final Action,” under the heading “Total Solids.”

(3) Titratable acidity—As determined by the method prescribed in section 16.023, “Acidity (2)—Official Final Action,” or by an equivalent potentiometric method.

(f) *Nomenclature.* The name of the food is “lowfat yogurt”. The full name of the food shall appear on the principal display panel of the label in type of uniform size, style, and color. The name of the food shall be accompanied by a declaration indicating the presence of any characterizing flavoring as specified in §101.22 of this chapter.

(1) The following terms shall accompany the name of the food wherever it appears on the principal display panel or panels of the label in letters not less than one-half of the height of the letters used in such name.

(i) The phrase “_ % milkfat”, the blank to be filled in with the fraction $\frac{1}{2}$ or multiple thereof closest to the actual fat content of the food.

(ii) The word “sweetened” if nutritive carbohydrate sweetener is added without the addition of characterizing flavoring.

(iii) The parenthetical phrase “(heat-treated after culturing)” shall follow the name of the food if the dairy ingredients have been heat-treated after culturing.

(iv) The phrase “vitamin A” or “vitamin A added”, or “vitamin D” or “vitamin D added”, or “vitamins A and D added”, as appropriate. The word “vitamin” may be abbreviated “vit”.

(2) The term “homogenized” may appear on the label if the dairy ingredients used are homogenized.

(g) *Label declaration.* Each of the ingredients used in the food shall be declared on the label as required by the applicable sections of parts 101 and 130 of this chapter.

[46 FR 9939, Jan. 30, 1981, as amended at 47 FR 11825, Mar. 19, 1982; 47 FR 41524, Sept. 21, 1982; 48 FR 24869, June 3, 1983; 54 FR 24893, June 12, 1989; 58 FR 2891, Jan. 6, 1993]

§ 131.206 Nonfat yogurt.

(a) *Description.* Nonfat yogurt is the food produced by culturing one or more of the optional dairy ingredients specified in paragraph (c) of this section with a characterizing bacterial culture that contains the lactic acid-producing bacteria, *Lactobacillus bulgaricus* and *Streptococcus thermophilus*. One or more of the other optional ingredients specified in paragraphs (b) and (d) of this section may also be added. When one or more of the ingredients specified in paragraph (d)(1) of this section are used, they shall be included in the culturing process. All ingredients used are safe and suitable. Nonfat yogurt, before the addition of bulky flavors, contains less than 0.5 percent milkfat and not less than 8.25 percent milk solids not fat, and has a titratable acidity of not less than 0.9 percent, expressed as lactic acid. The food may be homogenized and shall be pasteurized or ultra-pasteurized prior to the addition of the bacterial culture. Flavoring ingredients may be added after pasteurization or ultra-pasteurization. To extend the shelf life of the food, nonfat yogurt may be heat treated after culturing is completed, to destroy viable microorganisms.

(b) *Vitamin addition (optional).* (1) If added, vitamin A shall be present in such quantity that each 946 milliliters (quart) of the food contains not less

than 2,000 International Units thereof, within limits of good manufacturing practice.

(2) If added, vitamin D shall be present in such quantity that each 946 milliliters (quart) of the food contains 400 International Units thereof, within limits of good manufacturing practice.

(c) *Optional dairy ingredients.* Cream, milk, partially skimmed milk, or skim milk, used alone or in combination.

(d) *Other optional ingredients.* (1) Concentrated skim milk, nonfat dry milk, buttermilk, whey, lactose, lactalbumins, lactoglobulins, or whey modified by partial or complete removal of lactose and/or minerals, to increase the nonfat solids content of the food: *Provided*, That the ratio of protein to total nonfat solids of the food, and the protein efficiency ratio of all protein present shall not be decreased as a result of adding such ingredients.

(2) Nutritive carbohydrate sweeteners. Sugar (sucrose), beet or cane; invert sugar (in paste or sirup form); brown sugar; refiner's sirup; molasses (other than blackstrap); high fructose corn sirup; fructose; fructose sirup; maltose; maltose sirup, dried maltose sirup; malt extract, dried malt extract; malt sirup, dried malt sirup; honey; maple sugar; or any of the sweeteners listed in part 168 of this chapter, except table sirup.

(3) Flavoring ingredients.

(4) Color additives.

(5) Stabilizers.

(e) *Methods of analysis.* The following referenced methods of analysis are from "Official Methods of Analysis of the Association of Official Analytical Chemists," 13th Ed. (1980), which is incorporated by reference. Copies are available from the AOAC INTERNATIONAL, 481 North Frederick Ave., suite 500, Gaithersburg, MD 20877, or available for inspection at the National Archives and Records Administration (NARA). For information on the availability of this material at NARA, call 202-741-6030, or go to: http://www.archives.gov/federal_register/code_of_federal_regulations/ibr_locations.html.

(1) Milkfat content—As determined by the method prescribed in section 16.059, "Roese-Gottlieb Method (Ref-

erence Method) (11)—Official Final Action," under the heading "Fat."

(2) Milk solids not fat content—Calculated by subtracting the milkfat content from the total solids content as determined by the method prescribed in section 16.032, "Method I—Official Final Action," under the heading "Total Solids."

(3) Titratable acidity—As determined by the method prescribed in section 16.023, "Acidity (2)—Official Final Action," or by an equivalent potentiometric method.

(f) *Nomenclature.* The name of the food is "nonfat yogurt". The full name of the food shall appear on the principal display panel of the label in type of uniform size, style, and color. The name of the food shall be accompanied by a declaration indicating the presence of any characterizing flavoring as specified in §101.22 of this chapter.

(1) The following terms shall accompany the name of the food wherever it appears on the principal display panel or panels of the label in letters not less than one-half of the height of the letters used in such name:

(i) The word "sweetened" if nutritive carbohydrate sweetener is added without the addition of characterizing flavoring.

(ii) The parenthetical phrase "(heat-treated after culturing)" shall follow the name of the food if the dairy ingredients have been heat-treated after culturing.

(iii) The phrase "vitamin A" or "vitamin A added", or "vitamin D" or "vitamin D added", or "vitamins A and D added", as appropriate. The word "vitamin" may be abbreviated "vit".

(2) The term "homogenized" may appear on the label if the dairy ingredients used are homogenized.

(g) *Label declaration.* Each of the ingredients used in the food shall be declared on the label as required by the applicable sections of parts 101 and 130 of this chapter.

[46 FR 9940, Jan. 30, 1981, as amended at 47 FR 11825, Mar. 19, 1982; 47 FR 41524, Sept. 21, 1982; 48 FR 24869, June 3, 1983; 54 FR 24893, June 12, 1989; 58 FR 2891, Jan. 6, 1993]

**PART 133—CHEESES AND RELATED
CHEESE PRODUCTS**

Subpart A—General Provisions

Sec.

- 133.3 Definitions.
133.5 Methods of analysis.
133.10 Notice to manufacturers, packers, and distributors of pasteurized blended cheese, pasteurized process cheese, cheese food, cheese spread, and related foods.

**Subpart B—Requirements for Specific
Standardized Cheese and Related
Products**

- 133.102 Asiago fresh and asiago soft cheese.
133.103 Asiago medium cheese.
133.104 Asiago old cheese.
133.106 Blue cheese.
133.108 Brick cheese.
133.109 Brick cheese for manufacturing.
133.111 Caciocavallo siciliano cheese.
133.113 Cheddar cheese.
133.114 Cheddar cheese for manufacturing.
133.116 Low sodium cheddar cheese.
133.118 Colby cheese.
133.119 Colby cheese for manufacturing.
133.121 Low sodium colby cheese.
133.123 Cold-pack and club cheese.
133.124 Cold-pack cheese food.
133.125 Cold-pack cheese food with fruits, vegetables, or meats.
133.127 Cook cheese, koch kaese.
133.128 Cottage cheese.
133.129 Dry curd cottage cheese.
133.133 Cream cheese.
133.134 Cream cheese with other foods.
133.136 Washed curd and soaked curd cheese.
133.137 Washed curd cheese for manufacturing.
133.138 Edam cheese.
133.140 Gammelost cheese.
133.141 Gorgonzola cheese.
133.142 Gouda cheese.
133.144 Granular and stirred curd cheese.
133.145 Granular cheese for manufacturing.
133.146 Grated cheeses.
133.147 Grated American cheese food.
133.148 Hard grating cheeses.
133.149 Gruyere cheese.
133.150 Hard cheeses.
133.152 Limburger cheese.
133.153 Monterey cheese and monterey jack cheese.
133.154 High-moisture jack cheese.
133.155 Mozzarella cheese and scamorza cheese.
133.156 Low-moisture mozzarella and scamorza cheese.
133.157 Part-skim mozzarella and scamorza cheese.
133.158 Low-moisture part-skim mozzarella and scamorza cheese.

- 133.160 Muenster and munster cheese.
133.161 Muenster and munster cheese for manufacturing.
133.162 Neufchatel cheese.
133.164 Nuworld cheese.
133.165 Parmesan and reggiano cheese.
133.167 Pasteurized blended cheese.
133.168 Pasteurized blended cheese with fruits, vegetables, or meats.
133.169 Pasteurized process cheese.
133.170 Pasteurized process cheese with fruits, vegetables, or meats.
133.171 Pasteurized process pimento cheese.
133.173 Pasteurized process cheese food.
133.174 Pasteurized process cheese food with fruits, vegetables, or meats.
133.175 Pasteurized cheese spread.
133.176 Pasteurized cheese spread with fruits, vegetables, or meats.
133.178 Pasteurized neufchatel cheese spread with other foods.
133.179 Pasteurized process cheese spread.
133.180 Pasteurized process cheese spread with fruits, vegetables, or meats.
133.181 Provolone cheese.
133.182 Soft ripened cheeses.
133.183 Romano cheese.
133.184 Roquefort cheese, sheep's milk blue-mold, and blue-mold cheese from sheep's milk.
133.185 Samsoe cheese.
133.186 Sap sago cheese.
133.187 Semisoft cheeses.
133.188 Semisoft part-skim cheeses.
133.189 Skim milk cheese for manufacturing.
133.190 Spiced cheeses.
133.191 Part-skim spiced cheeses.
133.193 Spiced, flavored standardized cheeses.
133.195 Swiss and emmentaler cheese.
133.196 Swiss cheese for manufacturing.

AUTHORITY: 21 U.S.C. 321, 341, 343, 348, 371, 379e.

Subpart A—General Provisions

§ 133.3 Definitions.

- (a) *Milk* means the lacteal secretion, practically free from colostrum, obtained by the complete milking of one or more healthy cows, which may be clarified and may be adjusted by separating part of the fat therefrom; concentrated milk, reconstituted milk, and dry whole milk. Water, in a sufficient quantity to reconstitute concentrated and dry forms, may be added.
- (b) *Nonfat milk* means skim milk, concentrated skim milk, reconstituted skim milk, and nonfat dry milk. Water, in a sufficient quantity to reconstitute concentrated and dry forms, may be added.

(c) *Cream* means cream, reconstituted cream, dry cream, and plastic cream. Water, in a sufficient quantity to reconstitute concentrated and dry forms, may be added.

(d) *Pasteurized* when used to describe a dairy ingredient means that every particle of such ingredient shall have been heated in properly operated equipment to one of the temperatures specified in the table of this paragraph and held continuously at or above that temperature for the specified time (or other time/temperature relationship which has been demonstrated to be equivalent thereto in microbial destruction):

Temperature	Time
145 °F ¹	30 min.
161 °F ¹	15 s.
191 °F	1 s.
204 °F	0.05 s.
212 °F	0.01 s.

¹ If the dairy ingredient has a fat content of 10 percent or more, the specified temperature shall be increased by 5 °F.

(e) *Ultrapasteurized* when used to describe a dairy ingredient means that such ingredient shall have been thermally processed at or above 280 °F for at least 2 seconds.

[48 FR 2742, Jan. 21, 1983; 48 FR 11426, Mar. 18, 1983]

§ 133.5 Methods of analysis.

Moisture, milkfat, and phosphatase levels in cheeses will be determined by the following methods of analysis from “Official Methods of Analysis of the Association of Official Analytical Chemists,” 13th ed., 1980, which is incorporated by reference (copies are available from the AOAC INTERNATIONAL, 481 North Frederick Ave., suite 500, Gaithersburg, MD 20877, or available for inspection at the National Archives and Records Administration (NARA). For information on the availability of this material at NARA, call 202-741-6030, or go to: http://www.archives.gov/federal_register/code_of_federal_regulations/ibr_locations.html):

(a) Moisture content—section 16.233 “Method I (52)—Official Final Action”, under the heading “Moisture”.

(b) Milkfat content—section 16.255 “Fat (60)—Official Final Action”.

(c) Phenol equivalent value—section 16.275 “Reagents”, section 16.276 “Sampling”, and section 16.277 “Determination”, under the heading “Residual Phosphatase (27) Official Final Action”.

(d) Milkfat in solids (fat on a dry basis)—Subtract the percent of moisture found from 100; divide the remainder into the percent milkfat found. The quotient, multiplied by 100, shall be considered to be the percent of milkfat contained in the solids.

[48 FR 2742, Jan. 21, 1983; 48 FR 11426, Mar. 18, 1983, as amended at 54 FR 24893, June 12, 1989; 63 FR 14035, Mar. 24, 1998]

§ 133.10 Notice to manufacturers, packers, and distributors of pasteurized blended cheese, pasteurized process cheese, cheese food, cheese spread, and related foods.

(a) Definitions and standards of identity have recently been promulgated under the authority of the Federal Food, Drug, and Cosmetic Act for a number of foods made in part from cheese, including pasteurized process cheese; pasteurized process cheese with fruits, vegetables, or meats; pasteurized blended cheese; pasteurized process cheese food; pasteurized process cheese spread, and related foods. These standards prescribe the name for each such food. The act requires that this name appear on the label. Many of these names consist of several words. In the past it has been the practice of some manufacturers to subordinate the words “pasteurized,” “blended,” “process,” “food,” and “spread” to give undue prominence to the word “cheese” and to words naming the variety of cheese involved.

(b) When placing the names of these foods on labels so as to comply with the requirements of section 403 (a), (f), and (g) of the act, all the words forming the name specified by a definition and standard of identity should be given equal prominence. This can readily be accomplished by printing the specified name of the food in letters of the same size, color, and style of type, and with the same background.

(c) Where the names of optional ingredients are required to appear on the

label, the designations of all such ingredients should be given equal prominence. The names of the optional ingredients should appear prominently and conspicuously but should not be displayed with greater prominence than the name of the food. The word “contains” may precede the names of the optional ingredients, and when so used will not be considered as intervening printed matter between name of food and name of optional ingredients required to be placed on the label.

(d) Where a manufacturer elects to include a label statement of fat and moisture content, the declaration should be on the basis of the food as marketed. A fat declaration on a moisture-free basis is likely to be misleading, and should not be used in labeling.

Subpart B—Requirements for Specific Standardized Cheese and Related Products

§ 133.102 Asiago fresh and asiago soft cheese.

(a) Asiago fresh cheese, asiago soft cheese, is the food prepared from milk and other ingredients specified in this section, by the procedure set forth in paragraph (b) of this section, or by another procedure which produces a finished cheese having the same physical and chemical properties as the cheese produced when the procedure set forth in paragraph (b) of this section is used. It contains not more than 45 percent of moisture, and its solids contain not less than 50 percent of milkfat, as determined by the methods prescribed in § 133.5 (a), (b), and (d). It is cured for not less than 60 days.

(b) Milk which may be pasteurized or clarified or both, and which may be warmed, is subjected to the action of harmless lactic-acid producing bacteria, present in such milk or added thereto. Harmless artificial blue or green coloring in a quantity which neutralizes any natural yellow coloring in the curd may be added. Sufficient rennet, or other safe and suitable milk-clotting enzyme that produces equivalent curd formation, or both, with or without purified calcium chloride in a quantity not more than 0.02 percent (calculated as anhydrous calcium chlo-

ride) of the weight of the milk, is added to set the milk to a semisolid mass. The mass is cut, stirred, and heated to promote and regulate separation of the whey from the curd. The whey is drained off. When the curd is sufficiently firm it is removed from the kettle or vat, further drained for a short time, packed into hoops, and pressed. The pressed curd is salted in brine and cured in a well-ventilated room. During curing the surface of the cheese is occasionally rubbed with a vegetable oil. A harmless preparation of enzymes of animal or plant origin capable of aiding in the curing or development of flavor of asiago fresh cheese may be added during the procedure in such quantity that the weight of the solids of such preparation is not more than 0.1 percent of the weight of the milk used.

(c)(1) For the purposes of this section, the word “milk” means cow’s milk, which may be adjusted by separating part of the fat therefrom or by adding thereto one or more of the following: Cream, skim milk, concentrated skim milk, nonfat dry milk, water in a quantity sufficient to reconstitute any concentrated skim milk or nonfat dry milk used.

(2) Such milk may be bleached by the use of benzoyl peroxide or a mixture of benzoyl peroxide with potassium alum, calcium sulfate, and magnesium carbonate; but the weight of the benzoyl peroxide is not more than 0.002 percent of the weight of the milk bleached, and the weight of the potassium alum, calcium sulfate, and magnesium carbonate, singly or combined, is not more than six times the weight of the benzoyl peroxide used. If milk is bleached in this manner, sufficient vitamin A is added to the curd to compensate for the vitamin A or its precursors destroyed in the bleaching process, and artificial coloring is not used.

(d) Safe and suitable antimycotic agent(s), the cumulative levels of which shall not exceed current good manufacturing practice, may be added to the surface of the cheese.

(e) Label declaration: Each of the ingredients used in the food shall be declared on the label as required by the applicable sections of parts 101 and 130 of this chapter, except that enzymes of

animal, plant, or microbial origin may be declared as “enzymes”.

[42 FR 14366, Mar. 15, 1977, as amended at 48 FR 49013, Oct. 24, 1983; 49 FR 10093, Mar. 19, 1984; 58 FR 2891, Jan. 6, 1993]

§ 133.103 Asiago medium cheese.

Asiago medium cheese conforms to the definition and standard of identity and is subject to the requirements for label statement of ingredients prescribed by §133.102 for asiago fresh cheese, except that it contains not more than 35 percent moisture, its solids contain not less than 45 percent of milkfat, and it is cured for not less than 6 months.

[58 FR 2892, Jan. 6, 1993]

§ 133.104 Asiago old cheese.

Asiago old cheese conforms to the definition and standard of identity and is subject to the requirements for label statement of ingredients prescribed by §133.102 for asiago fresh cheese, except that it contains not more than 32 percent moisture, its solids contain not less than 42 percent of milk fat, and it is cured for not less than 1 year.

[58 FR 2892, Jan. 6, 1993]

§ 133.106 Blue cheese.

(a) *Description.* (1) Blue cheese is the food prepared by the procedure set forth in paragraph (a)(2), of this section, or by any other procedure which produces a finished cheese having the same physical and chemical properties. It is characterized by the presence of bluish-green mold, *Penicillium roquefortii*, throughout the cheese. The minimum milkfat content is 50 percent by weight of the solids and the maximum moisture content is 46 percent by weight, as determined by the methods described in §133.5. The dairy ingredients used may be pasteurized. Blue cheese is at least 60 days old.

(2) One or more of the dairy ingredients specified in paragraph (b)(1) of this section may be homogenized, bleached, warmed, and is subjected to the action of a lactic acid-producing bacterial culture. One or more of the clotting enzymes specified in paragraph (b)(2) of this section is added to set the dairy ingredients to a semisolid mass. The mass is cut into smaller por-

tions and allowed to stand for a time. The mixed curd and whey is placed in forms permitting further drainage. While the curd is being placed in forms, spores of the mold *Penicillium roquefortii* are added. The forms are turned several times during drainage. When sufficiently drained, the shaped curd is removed from the forms and salted with dry salt or brine. Perforations are then made in the shaped curd, and it is held at a temperature of approximately 50 °F. at 90 to 95 percent relative humidity, until the characteristic mold growth has developed. During storage the surface of the cheese may be scraped to remove surface growth of undesirable microorganisms. Antimycotics may be applied to the surface of the whole cheese. One or more of the other optional ingredients specified in paragraph (b)(3) of this section may be added during the procedure.

(b) *Optional ingredients.* The following safe and suitable ingredients may be used:

(1) *Dairy ingredients.* Milk, nonfat milk, or cream, as defined in §133.3, used alone or in combination.

(2) *Clotting enzymes.* Rennet and/or other clotting enzymes of animal, plant, or microbial origin.

(3) *Other optional ingredients.* (i) Blue or green color in an amount to neutralize the natural yellow color of the curd.

(ii) Calcium chloride in an amount not more than 0.02 percent (calculated as anhydrous calcium chloride) of the weight of the dairy ingredients, used as a coagulation aid.

(iii) Enzymes of animal, plant, or microbial origin, used in curing or flavor development.

(iv) Antimycotic agents, applied to the surface of slices or cuts in consumer-sized packages or to the surface of the bulk cheese during curing.

(v) Benzoyl peroxide or a mixture of benzoyl peroxide with potassium alum, calcium sulfate, and magnesium carbonate used to bleach the dairy ingredients. The weight of the benzoyl peroxide is not more than 0.002 percent of the weight of the milk being bleached, and the weight of the potassium alum, calcium sulfate, and magnesium carbonate, singly or combined, is not more

than six times the weight of the benzoyl peroxide used. If milk is bleached in this manner, vitamin A is added to the curd in such quantity as to compensate for the vitamin A or its precursors destroyed in the bleaching process, and artificial coloring is not used.

(vi) Vegetable fats or oils, which may be hydrogenated, used as a coating for the rind.

(c) *Nomenclature.* The name of the food is “blue cheese.”

(d) *Label declaration.* Each of the ingredients used in the food shall be declared on the label as required by the applicable sections of parts 101 and 130 of this chapter, except that:

(1) Enzymes of animal, plant, or microbial origin may be declared as “enzymes”; and

(2) The dairy ingredients may be declared, in descending order of predominance, by the use of the terms “milkfat and nonfat milk” or “nonfat milk and milkfat”, as appropriate.

[48 FR 2742, Jan. 21, 1983, as amended at 54 FR 32052, Aug. 4, 1989; 58 FR 2892, Jan. 6, 1993]

§ 133.108 Brick cheese.

(a) *Description.* (1) Brick cheese is the food prepared from dairy ingredients and other ingredients specified in this section by the procedure set forth in paragraph (a)(3) of this section, or by any other procedure which produces a finished cheese having the same physical and chemical properties. The minimum milkfat content is 50 percent by weight of the solids and the maximum moisture content is 44 percent by weight, as determined by the methods described in §133.5. If the dairy ingredients used are not pasteurized, the cheese is cured at a temperature of not less than 35 °F for at least 60 days.

(2) If pasteurized dairy ingredients are used, the phenol equivalent value of 0.25 gram of brick cheese is not more than 5 micrograms as determined by the method described in §133.5.

(3) One or more of the dairy ingredients specified in paragraph (b)(1) of this section is brought to a temperature of about 88 °F and subjected to the action of a lactic acid-producing bacterial culture. One or more of the clotting enzymes specified in paragraph (b)(2) of this section is added to set the dairy ingredients to a semisolid mass.

The mass is cut into cubes with sides approximately ¾ inch long, and stirred and heated so that the temperature rises slowly to about 96 °F. The stirring is continued until the curd is sufficiently firm. Part of the whey is then removed, and the mixture diluted with water or salt brine to control the acidity. The curd is transferred to forms, and drained. During drainage it is pressed and turned. After drainage the curd is salted, and the biological curing agents characteristic of brick cheese are applied to the surface. The cheese is then cured to develop the characteristics of brick cheese. One or more of the other optional ingredients specified in paragraph (b)(3) of this section may be added during the procedure.

(b) *Optional ingredients.* The following safe and suitable ingredients may be used:

(1) *Dairy ingredients.* Milk, nonfat milk, or cream, as defined in §133.3, used alone or in combination.

(2) *Clotting enzymes.* Rennet and/or other clotting enzymes of animal, plant, or microbial origin.

(3) *Other optional ingredients.* (i) Coloring.

(ii) Calcium chloride in an amount not more than 0.02 percent (calculated as anhydrous calcium chloride) of the weight of the dairy ingredients, used as a coagulation aid.

(iii) Enzymes of animal, plant, or microbial origin, used in curing or flavor development.

(iv) Antimycotic agents, the cumulative level of which shall not exceed current good manufacturing practice, may be added to the surface of the cheese.

(c) *Nomenclature.* The name of the food is “brick cheese”.

(d) *Label declaration.* Each of the ingredients used in the food shall be declared on the label as required by the applicable sections of parts 101 and 130 of this chapter, except that:

(1) Enzymes of animal, plant, or microbial origin may be declared as “enzymes”; and

(2) The dairy ingredients may be declared, in descending order of predominance, by the use of the terms “milkfat

and nonfat milk” or “nonfat milk and milkfat”, as appropriate.

[54 FR 32052, Aug. 4, 1989; 54 FR 35756, Aug. 29, 1989, as amended at 58 FR 2892, Jan. 6, 1993; 58 FR 17105, Apr. 1, 1993]

§ 133.109 Brick cheese for manufacturing.

Brick cheese for manufacturing conforms to the definition and standard of identity for brick cheese prescribed by § 133.108, except that the dairy ingredients are not pasteurized and curing is not required.

[54 FR 32053, Aug. 4, 1989]

§ 133.111 Caciocavallo siciliano cheese.

(a) Caciocavallo siciliano cheese is the food prepared from cow's milk or sheep's milk or goat's milk or mixtures of two or all of these and other ingredients specified in this section, by the procedure set forth in paragraph (b) of this section, or by another procedure which produces a finished cheese having the same physical and chemical properties as the cheese produced when the procedure set forth in paragraph (b) of this section is used. It has a stringy texture, and is made in oblong shapes. It contains not more than 40 percent of moisture, and its solids contain not less than 42 percent milkfat as determined by the methods prescribed in § 133.5 (a), (b), and (d). It is cured for not less than 90 days at a temperature of not less than 35 °F.

(b) Milk, which may be pasteurized or clarified or both, and which may be warmed, is subjected to the action of harmless lactic-acid-producing bacteria, present in such milk or added thereto. Harmless artificial blue or green coloring in a quantity which neutralizes any natural yellow coloring in the curd may be added. Sufficient rennet, rennet paste, extract of rennet paste, or other safe and suitable milk-clotting enzyme that produces equivalent curd formation, singly or in any combination (with or without purified calcium chloride in a quantity not more than 0.02 percent, calculated as anhydrous calcium chloride, of the weight of the milk) is added to set the milk to a semisolid mass. The mass is cut, stirred, and heated so as to promote and regulate the separation of

whey from curd. The whey is drained off, and the curd is removed to another vat containing hot whey, in which it is soaked for several hours. This whey is withdrawn, the curd is allowed to mat, and is cut into blocks. These are washed in hot whey until the desired elasticity is obtained. The curd is removed from the vat, drained, pressed into oblong forms, dried, and salted in brine, and cured. It may be paraffined. A harmless preparation of enzymes of animal or plant origin capable of aiding in the curing or development of flavor of caciocavallo siciliano cheese may be added during the procedure, in such quantity that the weight of the solids of such preparation is not more than 0.1 percent of the weight of the milk used.

(c)(1) For the purposes of this section, the word “milk” means cow's milk or goat's milk or sheep's milk or mixtures of two or all of these. Such milk may be adjusted by separating part of the fat therefrom or (in the case of cow's milk) by adding one or more of the following: Cream, skim milk, concentrated skim milk, nonfat dry milk; (in the case of goat's milk) the corresponding products from goat's milk; (in the case of sheep's milk) the corresponding products from sheep's milk; water in a quantity sufficient to reconstitute any such concentrated or dried products used.

(2) Such milk may be bleached by the use of benzoyl peroxide or a mixture of benzoyl peroxide with potassium alum, calcium sulfate, and magnesium carbonate; but the weight of the benzoyl peroxide is not more than 0.002 percent of the weight of the milk bleached, and the weight of the potassium alum, calcium sulfate, and magnesium carbonate, singly or combined, is not more than six times the weight of the benzoyl peroxide used. If milk is bleached in this manner, sufficient vitamin A is added to the curd to compensate for the vitamin A or its precursors destroyed in the bleaching process, and artificial coloring is not used.

(d) Safe and suitable antimycotic agent(s), the cumulative levels of which shall not exceed current good manufacturing practice, may be added to the cheese during the kneading and

§ 133.113

21 CFR Ch. I (4-1-07 Edition)

stretching process and/or applied to the surface of the cheese.

(e) When *caciocavallo siciliano* cheese is made solely from cow's milk, the name of such cheese is "*Caciocavallo siciliano* cheese". When made from sheep's milk or goat's milk or mixtures of these, or one or both of these with cow's milk, the name is followed by the words "made from _____", the blank being filled in with the name or names of the milks used, in order of predominance by weight.

(f) Label declaration: Each of the ingredients used in the food shall be declared on the label as required by the applicable sections of parts 101 and 130 of this chapter, except that enzymes of animal, plant, or microbial origin may be declared as "enzymes".

[42 FR 14366, Mar. 15, 1977, as amended at 42 FR 39102, Aug. 2, 1977; 48 FR 49013, Oct. 24, 1983; 49 FR 10093, Mar. 19, 1984; 58 FR 2892, Jan. 6, 1993]

§ 133.113 Cheddar cheese.

(a) *Description.* (1) Cheddar cheese is the food prepared by the procedure set forth in paragraph (a)(3) of this section, or by any other procedure which produces a finished cheese having the same physical and chemical properties. The minimum milkfat content is 50 percent by weight of the solids, and the maximum moisture content is 39 percent by weight, as determined by the methods described in §133.5. If the dairy ingredients used are not pasteurized, the cheese is cured at a temperature of not less than 35 °F for at least 60 days.

(2) If pasteurized dairy ingredients are used, the phenol equivalent value of 0.25 gram of cheddar cheese is not more than 3 micrograms as determined by the method described in §133.5.

(3) One or more of the dairy ingredients specified in paragraph (b)(1) of this section may be warmed, treated with hydrogen peroxide/catalase, and is subjected to the action of a lactic acid-producing bacterial culture. One or more of the clotting enzymes specified in paragraph (b)(2) of this section is added to set the dairy ingredients to a semisolid mass. The mass is so cut, stirred, and heated with continued stirring, as to promote and regulate the separation of whey and curd. The whey

is drained off, and the curd is matted into a cohesive mass. The mass is cut into slabs, which are so piled and handled as to promote the drainage of whey and the development of acidity. The slabs are then cut into pieces, which may be rinsed by sprinkling or pouring water over them, with free and continuous drainage; but the duration of such rinsing is so limited that only the whey on the surface of such pieces is removed. The curd is salted, stirred, further drained, and pressed into forms. One or more of the other optional ingredients specified in paragraph (b)(3) of this section may be added during the procedure.

(b) *Optional ingredients.* The following safe and suitable ingredients may be used:

(1) *Dairy ingredients.* Milk, nonfat milk, or cream, as defined in §133.3, used alone or in combination.

(2) *Clotting enzymes.* Rennet and/or other clotting enzymes of animal, plant, or microbial origin.

(3) *Other optional ingredients.* (i) Coloring.

(ii) Calcium chloride in an amount not more than 0.02 percent (calculated as anhydrous calcium chloride) of the weight of the dairy ingredients, used as a coagulation aid.

(iii) Enzymes of animal, plant, or microbial origin, used in curing or flavor development.

(iv) Antimycotic agents, applied to the surface of slices or cuts in consumer-sized packages.

(v) Hydrogen peroxide, followed by a sufficient quantity of catalase preparation to eliminate the hydrogen peroxide. The weight of the hydrogen peroxide shall not exceed 0.05 percent of the weight of the milk and the weight of the catalase shall not exceed 20 parts per million of the weight of the milk treated.

(c) *Nomenclature.* The name of the food is "cheddar cheese".

(d) *Label declaration.* Each of the ingredients used in the food shall be declared on the label as required by the applicable sections of parts 101 and 130 of this chapter, except that:

(1) Enzymes of animal, plant, or microbial origin may be declared as "enzymes"; and

(2) The dairy ingredients may be declared, in descending order or predominance, by the use of the terms “milkfat and nonfat milk” or “nonfat milk and milkfat”, as appropriate.

[48 FR 2743, Jan. 21, 1983; 48 FR 11426, Mar. 18, 1983, as amended at 58 FR 2892, Jan. 6, 1993]

§ 133.114 Cheddar cheese for manufacturing.

Cheddar cheese for manufacturing conforms to the definition and standard of identity prescribed for cheddar cheese by § 133.113, except that the milk is not pasteurized, curing is not required, and the provisions of paragraph (b)(3)(iv) of that section do not apply.

[48 FR 2743, Jan. 21, 1983]

§ 133.116 Low sodium cheddar cheese.

Low sodium cheddar cheese is the food prepared from the same ingredients and in the same manner prescribed in § 133.113 for cheddar cheese and complies with all the provisions of § 133.113, including the requirements for label statement of ingredients, except that:

(a) It contains not more than 96 milligrams of sodium per pound of finished food.

(b) The name of the food is “low sodium cheddar cheese”. The letters in the words “low sodium” shall be of the same size and style of type as the letters in the words “cheddar cheese”, wherever such words appear on the label.

(c) If a salt substitute is used, the label shall bear the statement “_____ added as a salt substitute”, the blank being filled in with the common name or names of the ingredient or ingredients used as a salt substitute.

(d) Low sodium cheddar cheese is subject to § 105.69 of this chapter.

[48 FR 2743, Jan. 21, 1983]

§ 133.118 Colby cheese.

(a) Colby cheese is the food prepared from milk and other ingredients specified in this section, by the procedure set forth in paragraph (b) of this section, or by another procedure which produces a finished cheese having the same physical and chemical properties as the cheese produced when the procedure set forth in paragraph (b) of this

section is used. It contains not more than 40 percent of moisture, and its solids contain not less than 50 percent of milkfat, as determined by the methods prescribed in § 133.5 (a), (b), and (d). If the milk used is not pasteurized, the cheese so made is cured at a temperature of not less than 35 °F for not less than 60 days.

(b) Milk, which may be pasteurized or clarified or both, and which may be warmed, is subjected to the action of harmless lactic-acid-producing bacteria, present in such milk or added thereto. Harmless artificial coloring may be added. Sufficient rennet, or other safe and suitable milk-clotting enzyme that produces equivalent curd formation, or both, with or without purified calcium chloride in a quantity not more than 0.02 percent (calculated as anhydrous calcium chloride) of the weight of the milk, is added to set the milk to a semisolid mass. The mass is so cut, stirred, and heated with continued stirring, as to promote and regulate the separation of whey and curd. A part of the whey is drained off, and the curd is cooled by adding water, the stirring being continued so as to prevent the pieces of curd from matting. The curd is drained, salted, stirred, further drained, and pressed into forms. A harmless preparation of enzymes of animal or plant origin capable of aiding in the curing or development of flavor of colby cheese may be added during the procedure, in such quantity that the weight of the solids of such preparation is not more than 0.1 percent of the weight of the milk used.

(c) For the purposes of this section:

(1) The word “milk” means cow’s milk, which may be adjusted by separating part of the fat therefrom or by adding thereto one or more of the following: Cream, skim milk, concentrated skim milk, nonfat dry milk, water, in a quantity sufficient to reconstitute any concentrated skim milk or nonfat dry milk used.

(2) Milk shall be deemed to have been pasteurized if it has been held at a temperature of not less than 143 °F for a period of not less than 30 minutes, or for a time and at a temperature equivalent thereto in phosphatase destruction. Colby cheese shall be deemed not to have been made from pasteurized

§ 133.119

milk if 0.25 gram shows a phenol equivalent of more than 3 micrograms when tested by the method prescribed in § 133.5(c).

(3) During the cheesemaking process the milk may be treated with hydrogen peroxide/catalase as provided in § 133.113(a)(3).

(d)(1) Colby cheese in the form of slices or cuts may have added to it a clear aqueous solution prepared by condensing or precipitating wood smoke in water.

(2) Colby cheese in the form of slices or cuts in consumer-sized packages may contain an optional mold-inhibiting ingredient consisting of sorbic acid, potassium sorbate, sodium sorbate, or any combination of two or more of these, in an amount not to exceed 0.3 percent by weight calculated as sorbic acid.

(e)(1) If colby cheese has added to it a clear aqueous solution prepared by condensing or precipitating wood smoke in water as provided in paragraph (d)(1) of this section, the name of the food is immediately followed by the words "with added smoke flavoring" with all words in this phrase of the same type size, style, and color without intervening written, printed, or graphic matter.

(2) If colby cheese in sliced or cut form contains an optional mold-inhibiting ingredient as specified in paragraph (d)(2) of this section, the label shall bear the statement "_____ added to retard mold growth" or "_____ added as a preservative", the blank being filled in with the common name or names of the mold-inhibiting ingredient or ingredients used.

(3) Wherever the name of the food appears on the label so conspicuously as to be easily seen under customary conditions of purchase, the statement specified in paragraph (e)(2) of this section, showing the optional ingredient used, shall immediately and conspicuously precede or follow such name, without intervening written, printed, or graphic matter except for the statement "with added smoke flavoring," as set forth in paragraph (e)(1) of this section.

(f) Each of the ingredients used in the food shall be declared on the label as required by the applicable sections of

21 CFR Ch. I (4-1-07 Edition)

parts 101 and 130 of this chapter, except that enzymes of animal, plant, or microbial origin may be declared as "enzymes".

[42 FR 14366, Mar. 15, 1977, as amended at 49 FR 10093, Mar. 19, 1984; 58 FR 2892, Jan. 6, 1993]

§ 133.119 Colby cheese for manufacturing.

Colby cheese for manufacturing conforms to the definition and standard of identity prescribed for colby cheese by § 133.118, except that the milk is not pasteurized, curing is not required, and the provisions of paragraph (d) of that section do not apply.

§ 133.121 Low sodium colby cheese.

Low sodium colby cheese is the food prepared from the same ingredients and in the same manner prescribed in § 133.118 for colby cheese and complies with all the provisions of § 133.118, including the requirements for label statement of ingredients, except that:

(a) Salt is not used. Any safe and suitable ingredient or combination of ingredients that contains no sodium and that is recognized as a salt substitute may be used.

(b) Sodium sorbate is not used.

(c) It contains not more than 96 milligrams of sodium per pound of finished food.

(d) The name of the food is "low sodium colby cheese". The letters in the words "low sodium" shall be of the same size and style of type as the letters in the words "colby cheese", wherever such words appear on the label.

(e) If a salt substitute as provided for in paragraph (a) of this section is used, the label shall bear the statement "_____ added as a salt substitute", the blank being filled in with the common name or names of the ingredient or ingredients used as a salt substitute.

(f) Low sodium colby cheese is subject to § 105.69 of this chapter.

[42 FR 14366, Mar. 15, 1977, as amended at 58 FR 2892, Jan. 6, 1993]

§ 133.123 Cold-pack and club cheese.

(a)(1) Cold-pack cheese, club cheese, is the food prepared by comminuting, without the aid of heat, one or more

cheeses of the same or two or more varieties, except cream cheese, neufchatel cheese, cottage cheese, lowfat cottage cheese, cottage cheese dry curd, hard grating cheese, semisoft part-skim cheese, part-skim spiced cheese and skim milk cheese for manufacturing, into a homogeneous plastic mass. One or more of the optional ingredients designated in paragraph (c) of this section may be used.

(2) All cheeses used in a cold-pack cheese are made from pasteurized milk or are held for not less than 60 days at a temperature of not less than 35 °F before being comminuted.

(3)(i) The moisture content of a cold-pack cheese made from a single variety of cheese is not more than the maximum moisture content prescribed by the definition and standard of identity, if any there be, for the variety of cheese used. If there is no applicable definition and standard of identity, or if such standard contains no provision as to maximum moisture content, no water is used in the preparation of the cold-pack cheese.

(ii) The fat content of the solids of a cold-pack cheese made from a single variety of cheese is not less than the minimum prescribed by the definition and standard of identity, if any there be, for the variety of cheese used, but in no case is less than 47 percent, except that the fat content of the solids of cold-pack swiss cheese is not less than 43 percent, and the fat content of the solids of cold-pack gruyere cheese is not less than 45 percent.

(4)(i) The moisture content of a cold-pack cheese made from two or more varieties of cheese is not more than the arithmetical average of the maximum moisture contents prescribed by the definitions and standards of identity, if any there be, for the varieties of cheese used, but in no case is the moisture content more than 42 percent, except that the moisture content of a cold-pack cheese made from two or more of the varieties cheddar cheese, washed curd cheese, colby cheese, and granular cheese is not more than 39 percent.

(ii) The fat content of the solids of a cold-pack cheese made from two or more varieties of cheese is not less than the arithmetical average of the minimum percent of fat prescribed by

the definitions and standards of identity, if any there be, for the varieties of cheese used, but in no case is less than 47 percent, except that the fat content of the solids of a cold-pack cheese made from swiss cheese and gruyere cheese is not less than 45 percent.

(5) Moisture and fat are determined by the methods prescribed in §133.5(a), (b), and (d).

(6) The weight of each variety of cheese in a cold-pack cheese made from two varieties of cheese is not less than 25 percent of the total weight of both, except that the weight of blue cheese, nuworld cheese, roquefort cheese, or gorgonzola cheese is not less than 10 percent of the total weight of both, and the weight of limburger cheese is not less than 5 percent of the total weight of both. The weight of each variety of cheese in a cold-pack cheese made from three or more varieties of cheese is not less than 15 percent of the total weight of all, except that the weight of blue cheese, nuworld cheese, roquefort cheese, or gorgonzola cheese is not less than 5 percent of the total weight of all, and the weight of limburger cheese is not less than 3 percent of the total weight of all. These limits do not apply to the quantity of cheddar cheese, washed curd cheese, colby cheese, and granular cheese in mixtures which are designated as "American cheese" as prescribed in paragraph (d)(2) of this section. Such mixtures are considered as one variety of cheese for the purpose of this paragraph (a)(6).

(b) Cold-pack cheese may be smoked, or the cheese or cheeses from which it is made may be smoked, before comminuting and mixing, or it may contain substances prepared by condensing or precipitating wood smoke.

(c) The optional ingredients referred to in paragraph (a) of this section are:

(1) An acidifying agent consisting of one or any mixture of two or more of the following: A vinegar, lactic acid, citric acid, acetic acid, and phosphoric acid, in such quantity that the pH of the finished cold-pack cheese is not below 4.5. For the purposes of this section vinegar is considered to be acetic acid.

(2) Water.

(3) Salt.

(4) Harmless artificial coloring.

(5) Spices or flavorings, other than any which singly or in combination with other ingredients simulate the flavor of a cheese of any age or variety.

(6) Cold-pack cheese in consumer-sized packages may contain an optional mold-inhibiting ingredient consisting of sorbic acid, potassium sorbate, sodium sorbate, or any combination of two or more of these, in an amount not to exceed 0.3 percent by weight, calculated as sorbic acid or consisting of not more than 0.3 percent by weight of sodium propionate, calcium propionate, or a combination of sodium propionate and calcium propionate.

(d)(1) The name of a cold-pack cheese for which a definition and standard of identity is prescribed by this section is “Cold-pack _____ cheese”, “_____ cold-pack cheese” or “_____ club cheese”, the blanks being filled in with the name or names of the varieties of cheese used, in order of predominance by weight.

(2) If the cold-pack cheese is made of cheddar cheese, washed curd cheese, colby cheese, or granular cheese or any mixture of two or more of these, it may be designated “Cold-pack American cheese”; or when cheddar cheese, washed curd cheese, colby cheese, granular cheese, or any mixture of two or more of these is combined with other varieties of cheese in the cheese ingredient any of such cheeses or such mixture may be designated as “American cheese”.

(3) The full name of the food shall appear on the principal display panel of the label in type of uniform size, style, and color. Wherever any word or statement emphasizing the name of any ingredient appears on the label (other than in an ingredient statement as specified in paragraph (f) of this section) so conspicuously as to be easily seen under customary conditions of purchase, the full name of the food shall immediately and conspicuously precede or follow such word or statement in type of at least the same size as the type used in such word or statement.

(e) The name of the food shall include a declaration of any flavoring, including smoke and substances prepared by condensing or precipitating wood

smoke, that characterizes the product as specified in §101.22 of this chapter and a declaration of any spice that characterizes the product.

(f) Each of the ingredients used in the food shall be declared on the label as required by the applicable sections of parts 101 and 130 of this chapter, except that cheddar cheese, washed curd cheese, colby cheese, granular cheese, or any mixture of two or more of these, may be designated as “American cheese”.

(1) Artificial coloring need not be declared.

(2) If the cheese ingredient contains cheddar cheese, washed curd cheese, colby cheese, granular cheese, or any mixture of two or more of these, such cheese or such mixture may be designated as “American cheese”.

[42 FR 14366, Mar. 15, 1977, as amended at 49 FR 10093, Mar. 19, 1984; 58 FR 2892, Jan. 6, 1993]

§ 133.124 Cold-pack cheese food.

(a)(1) Cold-pack cheese food is the food prepared by comminuting and mixing, without the aid of heat, one or more of the optional cheese ingredients prescribed in paragraph (c) of this section with one or more of the optional dairy ingredients prescribed in paragraph (d) of this section, into a homogeneous plastic mass. One or more of the optional ingredients specified in paragraph (e) of this section may be used.

(2) All cheeses used in a cold-pack cheese food are made from pasteurized milk, or are held for not less than 60 days at a temperature of not less than 35 °F before being comminuted.

(3) The moisture content of a cold-pack cheese food is not more than 44 percent, and the fat content is not less than 23 percent.

(4) Moisture and fat are determined by the methods prescribed in §133.5 (a), (b), and (d), except that in determining moisture the loss in weight which occurs in drying for 5 hours, under the conditions prescribed in such method, is taken as the weight of moisture.

(5) The weight of the cheese ingredient prescribed by paragraph (a)(1) of this section constitutes not less than 51 percent of the weight of the finished cold-pack cheese food.

(6) The weight of each variety of cheese in the cold-pack cheese food made with two varieties of cheese is not less than 25 percent of the total weight of both, except that the weight of blue cheese, nuworld cheese, roquefort cheese, gorgonzola cheese, or limburger cheese is not less than 10 percent of the total weight of both. The weight of each variety of cheese in the cold-pack cheese food made with three or more varieties of cheese is not less than 15 percent of the total weight of all, except that the weight of blue cheese, nuworld cheese, roquefort cheese, gorgonzola cheese, or limburger cheese is not less than 5 percent of the total weight of all. These limits do not apply to the quantity of cheddar cheese, washed curd cheese, colby cheese, and granular cheese in mixtures which are designated as "American cheese" as prescribed in paragraph (h)(5) of this section. Such mixtures are considered as one variety of cheese for the purposes of this paragraph (a)(6).

(b) Cold-pack cheese food may be smoked, or the cheese or cheeses from which it is made may be smoked, before comminuting and mixing, or it may contain substances prepared by condensing or precipitating wood smoke.

(c) The optional cheese ingredients referred to in paragraph (a) of this section are: One or more cheeses of the same or two or more varieties, except that cream cheese, neufchatel cheese, cottage cheese, creamed cottage cheese, cook cheese, and skim-milk cheese for manufacturing are not used, and except that semisoft part-skim cheese, part-skim spiced cheese, and hard grating cheese may not be used, alone or in combination with each other, as the cheese ingredient.

(d) The optional dairy ingredients referred to in paragraph (a) of this section are: Cream, milk, skim milk, buttermilk, cheese whey, any of the foregoing from which part of the water has been removed, anhydrous milkfat, dehydrated cream, skim milk cheese for manufacturing, and albumin from cheese whey. All optional dairy ingredients used in cold-pack cheese food are pasteurized or made from products that have been pasteurized.

(e) The other optional ingredients referred to in paragraph (a) of this section are:

(1) An acidifying agent consisting of one or any mixture of two or more of the following: A vinegar, lactic acid, citric acid, acetic acid, and phosphoric acid, in such quantity that the pH of the finished cold-pack cheese food is not below 4.5.

(2) Water.

(3) Salt.

(4) Harmless artificial coloring.

(5) Spices or flavorings, other than any which singly or in combination with other ingredients simulate the flavor of cheese of any age or variety.

(6) A sweetening agent consisting of one or any mixture of two or more of the following: Sugar, dextrose, corn sugar, corn sirup, corn sirup solids, glucose sirup, glucose sirup solids, maltose, malt sirup, and hydrolyzed lactose, in a quantity necessary for seasoning.

(7) Cold-pack cheese food in consumer-sized packages may contain an optional mold-inhibiting ingredient consisting of sorbic acid, potassium sorbate, sodium sorbate, or any combination of two or more of these, in an amount not to exceed 0.3 percent by weight, calculated as sorbic acid or consisting of not more than 0.3 percent by weight of sodium propionate, calcium propionate, or a combination of sodium propionate and calcium propionate.

(8) In the preparation of cold-pack cheese food, guar gum or xanthan gum, or both, may be used, but the total quantity of such ingredient or combination is not to exceed 0.3 percent of the weight of the finished food. When one or both such optional ingredients is used, dioctyl sodium sulfosuccinate complying with the requirements of §172.810 of this chapter may be used in a quantity not in excess of 0.5 percent by weight of such ingredient or ingredients.

(f) The name of the food is "cold-pack cheese food". The full name of the food shall appear on the principal display panel of the label in type of uniform size, style, and color. Wherever any word or statement emphasizing the name of (other than in an ingredient statement any ingredient appears on

§ 133.125

the label as specified in paragraph (h) of this section) so conspicuously as to be easily seen under customary conditions of purchase, the full name of the food shall immediately and conspicuously precede or follow such word or statement in type of at least the same size as the type used in such word or statement.

(g) The name of the food shall include a declaration of any flavoring, including smoke and substances prepared by condensing or precipitating wood smoke, that characterizes the product as specified in §101.22 of this chapter and a declaration of any spice that characterizes the product.

(h) Each of the ingredients used in the food shall be declared on the label as required by the applicable sections of parts 101 and 130 of this chapter, except that cheddar cheese, washed curd cheese, colby cheese, granular cheese, or any mixture of two or more of these, may be designated as "American cheese".

[42 FR 14366, Mar. 15, 1977, as amended at 49 FR 10093, Mar. 19, 1984; 58 FR 2892, Jan. 6, 1993]

§ 133.125 Cold-pack cheese food with fruits, vegetables, or meats.

(a) Cold-pack cheese food with fruits, vegetables, or meats or mixtures of these is the food which conforms to the definition and standard of identity, and is subject to the requirements for label declaration of ingredients, prescribed for cold pack cheese food by §133.124, except that:

(1) Its milk fat content is not less than 22 percent.

(2) It contains one or any mixture of two or more of the following: Any properly prepared fresh, cooked, canned, or dried vegetable; any properly prepared cooked or canned meat.

(3) When the added fruits, vegetables, or meats contain fat, the method prescribed for the determination of fat by §133.5(b) and (d) is not applicable.

(b) The name of a cold-pack cheese food with fruits, vegetables or meats is "Cold-pack cheese food with _____", the blank being filled in with the common or usual name or names of the

21 CFR Ch. I (4-1-07 Edition)

fruits, vegetables, or meats used, in order of predominance by weight.

[42 FR 14366, Mar. 15, 1977, as amended at 49 FR 10093, Mar. 19, 1984; 58 FR 2892, Jan. 6, 1993]

§ 133.127 Cook cheese, koch kaese.

(a) *Description.* (1) Cook cheese, koch kaese, is the food prepared by the procedure set forth in paragraph (a)(3) of this section or by any other procedure which produces a finished cheese having the same physical and chemical properties. The maximum moisture content is 80 percent by weight, as determined by the method described in §133.5. The dairy ingredients used may be pasteurized.

(2) The phenol equivalent value of 0.25 gram of cook cheese is not more than 3 micrograms as determined by the method described in §133.5.

(3) One or more of the dairy ingredients specified in paragraph (b)(1) of this section may be warmed and is subjected to the action of a lactic acid-producing bacterial culture. One or more of the clotting enzymes specified in paragraph (b)(2) of this section is added to set the dairy ingredients to a semisolid mass. The mass is cut, stirred, and heated with continued stirring, so as to separate the curd and whey. The whey is drained from the curd and the curd is cured for 2 or 3 days. It is then heated to a temperature of not less than 180 °F until the hot curd will drop from a ladle with a consistency like that of honey. The hot cheese is filled into packages and cooled. One or more of the other optional ingredients specified in paragraph (b)(3) of this section may be added during the procedure.

(b) *Optional ingredients.* The following safe and suitable ingredients may be used:

(1) *Dairy ingredients.* Nonfat milk as defined in §133.3.

(2) *Clotting enzymes.* Rennet and/or other clotting enzymes of animal, plant, or microbial origin.

(3) *Other optional ingredients.* (i) Calcium chloride in an amount not more than 0.02 percent (calculated as anhydrous calcium chloride) of the weight of the dairy ingredients, used as a coagulation aid.

(ii) Culture of white mold.

- (iii) Pasteurized cream.
- (iv) Caraway seed.
- (v) Salt.

(c) *Nomenclature.* The name of the food is “cook cheese” or, alternatively, “koch kaese”.

(d) *Label declaration.* Each of the ingredients used in the food shall be declared on the label as required by the applicable sections of parts 101 and 130, except that enzymes of animal, plant, or microbial origin may be declared as “enzymes”.

[54 FR 32053, Aug. 4, 1989, as amended at 55 FR 51409, Dec. 14, 1990; 58 FR 2892, Jan. 6, 1993]

§ 133.128 Cottage cheese.

(a) Cottage cheese is the soft uncured cheese prepared by mixing cottage cheese dry curd with a creaming mixture as provided in paragraph (b) of this section. The milkfat content is not less than 4 percent by weight of the finished food, within limits of good manufacturing practice. The finished food contains not more than 80 percent of moisture, as determined by the method prescribed in § 133.129(a).

(b) The creaming mixture is prepared from safe and suitable ingredients including, but not limited to, milk or substances derived from milk. Any ingredients used that are not derived from milk shall serve a useful function other than building the total solids content of the finished food, and shall be used in a quantity not greater than is reasonably required to accomplish their intended effect. The creaming mixture shall be pasteurized; however, heat labile ingredients, such as bacterial starters, may be added following pasteurization.

(c) The name of the food consists of the following two phrases which shall appear together:

(1) The words “cottage cheese” which shall appear in type of the same size and style.

(2) The statement “not less than ___ percent milkfat” or “___ percent milkfat minimum”, the blank being filled in with the whole number that is closest to, but does not exceed, the actual fat content of the product. This statement of fat content shall appear in letters not less than one-half of the height of the letters in the phrase spec-

ified in paragraph (c)(1) of this section, but in no case less than one-eighth of an inch in height.

(d) When the optional process described in § 133.129(b)(1) (ii) or (iii) is used to make the cottage cheese dry curd used in cottage cheese, the label shall bear the statement “Directly set” or “Curd set by direct acidification”. Wherever the name of the food appears on the label so conspicuously as to be seen under customary conditions of purchase, the statement specified in this paragraph, showing the optional process used, shall immediately and conspicuously precede or follow such name without intervening written, printed, or graphic matter.

(e) Each of the ingredients used in the food shall be declared on the label as required by the applicable sections of parts 101 and 130 of this chapter, except that milk-clotting enzymes may be declared by the word “enzymes”.

[42 FR 14366, Mar. 15, 1977, as amended at 58 FR 2892, Jan. 6, 1993]

§ 133.129 Dry curd cottage cheese.

(a) Cottage cheese dry curd is the soft uncured cheese prepared by the procedure set forth in paragraph (b) of this section. The finished food contains less than 0.5 percent milkfat. It contains not more than 80 percent of moisture, as determined by the method prescribed in § 133.5(a).

(b)(1) One or more of the dairy ingredients specified in paragraph (b)(2) of this section is pasteurized; calcium chloride may be added in a quantity of not more than 0.02 percent (calculated as anhydrous calcium chloride) of the weight of the mix; thereafter one of the following methods is employed:

(i) Harmless lactic-acid-producing bacteria, with or without rennet and/or other safe and suitable milk-clotting enzyme that produces equivalent curd formation, are added and it is held until it becomes coagulated. The coagulated mass may be cut; it may be warmed; it may be stirred; it is then drained. The curd may be washed with water and further drained; it may be pressed, chilled, worked, seasoned with salt; or

(ii) Food grade phosphoric acid, lactic acid, citric acid, or hydrochloric acid, with or without rennet and/or

other safe and suitable milk-clotting enzyme that produces equivalent curd formation, is added in such amount as to reach a pH of between 4.5 and 4.7; coagulation to a firm curd is achieved while heating to a maximum of 120 °F without agitation during a continuous process. The coagulated mass may be cut; it may be warmed; it may be stirred; it is then drained. The curd is washed with water, stirred, and further drained. It may be pressed, chilled, worked, seasoned with salt.

(iii) Food grade acids as provided in paragraph (b)(1)(ii) of this section, D-Glucono-delta-lactone with or without rennet, and/or other safe and suitable milk clotting enzyme that produces equivalent curd formation, are added in such amounts as to reach a final pH value in the range of 4.5–4.8, and it is held until it becomes coagulated. The coagulated mass may be cut; it may be warmed; it may be stirred; it is then drained. The curd is then washed with water, and further drained. It may be pressed, chilled, worked, and seasoned with salt.

(2) The dairy ingredients referred to in paragraph (b)(1) of this section are sweet skim milk, concentrated skim milk, and nonfat dry milk. If concentrated skim milk or nonfat dry milk is used, water may be added in a quantity not in excess of that removed when the skim milk was concentrated or dried.

(3) For the purposes of this section the term “skim milk” means the milk of cows from which the milk fat has been separated, and “concentrated skim milk” means skim milk from which a portion of the water has been removed by evaporation.

(c) The name of the food consists of the following two phrases which shall appear together:

(1) The words “cottage cheese dry curd” or alternatively “dry curd cottage cheese” which shall all appear in type of the same size and style.

(2) The words “less than ½% milkfat” which shall all appear in letters not less than one-half of the height of the letters in the phrase specified in paragraph (c)(1) of this section, but in no case less than one-eighth of an inch in height.

(d) When either of the optional processes described in paragraph (b)(1) (ii) or (iii) of this section is used to make cottage cheese dry curd, the label shall bear the statement “Directly set” or “Curd set by direct acidification”. Wherever the name of the food appears on the label so conspicuously as to be seen under customary conditions of purchase, the statement specified in this paragraph, showing the optional process used, shall immediately and conspicuously precede or follow such name without intervening written, printed, or graphic matter.

(e) Each of the ingredients used in the food shall be declared on the label as required by the applicable sections of parts 101 and 130 of this chapter, except that milk-clotting enzymes may be declared by the word “enzymes”.

[42 FR 14366, Mar. 15, 1977, as amended at 47 FR 11826, Mar. 19, 1982; 49 FR 10093, Mar. 19, 1984; 58 FR 2892, Jan. 6, 1993]

§ 133.133 Cream cheese.

(a) *Description.* (1) Cream cheese is the soft, uncured cheese prepared by the procedure set forth in paragraph (a)(2) of this section, or by any other procedure which produces a finished cheese having the same physical and chemical properties. The minimum milkfat content is 33 percent by weight of the finished food, and the maximum moisture content is 55 percent by weight, as determined by the methods described in §133.5. The dairy ingredients used are pasteurized.

(2) One or more of the dairy ingredients specified in paragraph (b)(1) of this section may be homogenized and is subjected to the action of lactic acid-producing bacterial culture. One or more of the clotting enzymes specified in paragraph (b)(2) of this section is added to coagulate the dairy ingredients. The coagulated mass may be warmed and stirred and it is drained. The moisture content may be adjusted with one or more of the optional ingredients specified in paragraph (b)(3)(ii) of this section. The curd may be pressed, chilled, and worked and it may be heated until it becomes fluid. It may then be homogenized or otherwise mixed. One or more of the optional

dairy ingredients specified in paragraph (b)(1) and the other optional ingredients specified in paragraph (b)(3) of this section may be added during the procedure.

(b) *Optional ingredients.* The following safe and suitable ingredients may be used:

(1) *Dairy ingredients.* Milk, nonfat milk, or cream, as defined in §133.3, used alone or in combination.

(2) *Clotting enzymes.* Rennet and/or other clotting enzymes of animal, plant, or microbial origin.

(3) *Other optional ingredients.* (i) Salt.

(ii) Cheese whey, concentrated cheese whey, dried cheese whey, or reconstituted cheese whey prepared by addition of water to concentrated cheese whey or dried cheese whey.

(iii) Stabilizers, in a total amount not to exceed 0.5 percent of the weight of the finished food, with or without the addition of dioctyl sodium sulfosuccinate in a maximum amount of 0.5 percent of the weight of the stabilizer(s) used.

(c) *Nomenclature.* The name of the food is "cream cheese".

(d) *Label declaration.* Each of the ingredients used in the food shall be declared on the label as required by the applicable sections of parts 101 and 130 of this chapter, except that:

(1) Enzymes of animal, plant, or microbial origin may be declared as "enzymes"; and

(2) The dairy ingredients may be declared, in descending order of predominance, by the use of the terms "milkfat and nonfat milk" or "nonfat milk and milkfat", as appropriate.

[54 FR 32053, Aug. 4, 1989, as amended at 58 FR 2892, Jan. 6, 1993]

§ 133.134 Cream cheese with other foods.

(a) *Description.* Cream cheese with other foods is the class of foods prepared by mixing, with or without the aid of heat, cream cheese with one or a mixture of two or more types of foods (except other cheeses) listed in paragraph (b)(1) of this section, in an amount sufficient to differentiate the mixture from cream cheese. One or more of the other optional ingredients in paragraph (b)(2) of this section may be used. The maximum moisture con-

tent of the mixture is 60 percent by weight. The minimum milkfat is 33 percent by weight of the cream cheese and in no case less than 27 percent of the finished food. The moisture and fat contents will be determined by the methods described in §133.5, except that the method for determination of fat content is not applicable when the added food contains fat.

(b) *Optional ingredients.* The following safe and suitable optional ingredients may be used:

(1) *Foods.* Properly prepared fresh, cooked, canned, or dried fruits or vegetables; cooked or canned meats, relishes, pickles, or other suitable foods.

(2) *Other optional ingredients.* (i) Stabilizers, in a total amount not to exceed 0.8 percent, with or without the addition of dioctyl sodium sulfosuccinate in a maximum amount of 0.5 percent of the weight of the stabilizer(s) used.

(ii) Coloring.

(c) *Nomenclature.* The name of the food is "cream cheese with _____" or, alternatively, "cream cheese and _____", the blank being filled in with the name of the foods used in order of predominance by weight.

(d) *Label declaration.* Each of the ingredients used in the food shall be declared on the label as required by the applicable sections of parts 101 and 130 of this chapter, except that:

(1) Enzymes of animal, plant, or microbial origin may be declared as "enzymes"; and

(2) The dairy ingredients may be declared, in descending order of predominance, by the use of the terms "milkfat and nonfat milk" or "nonfat milk and milkfat", as appropriate.

[54 FR 32053, Aug. 4, 1989, as amended at 58 FR 2893, Jan. 6, 1993]

§ 133.136 Washed curd and soaked curd cheese.

(a) *Description.* (1) Washed curd, soaked curd cheese is the food prepared by the procedure set forth in paragraph (a)(3) of this section or by any other procedure which produces a finished cheese having the same physical and chemical properties. The minimum milkfat content is 50 percent by weight of the solids and the maximum moisture content is 42 percent by weight, as

§ 133.137

21 CFR Ch. I (4-1-07 Edition)

determined by the methods described in §133.5. If the dairy ingredients used are not pasteurized, the cheese is cured at a temperature of not less than 35 °F for at least 60 days.

(2) If pasteurized dairy ingredients are used, the phenol equivalent value of 0.25 gram of washed curd cheese is not more than 3 micrograms as determined by the method described in §133.5.

(3) One or more of the dairy ingredients specified in paragraph (b)(1) of this section may be warmed, treated with hydrogen peroxide/catalase, and is subjected to the action of a lactic acid-producing bacterial culture. One or more of the clotting enzymes specified in paragraph (b)(2) of this section is added to set the dairy ingredients to a semisolid mass. The mass is so cut, stirred, and heated with continued stirring, as to promote and regulate the separation of whey and curd. The whey is drained off, and the curd is matted into a cohesive mass. The mass is cut into slabs, which are so piled and handled as to promote the drainage of whey and the development of acidity. The slabs are then cut into pieces, cooled in water, and soaked therein until the whey is partly extracted and water is absorbed. The curd is drained, salted, stirred, and pressed into forms. One or more of the other optional ingredients specified in paragraph (b)(3) of this section may be added during the procedure.

(b) *Optional ingredients.* The following safe and suitable ingredients may be used:

(1) *Dairy ingredients.* Milk, nonfat milk, or cream, as defined in §133.3, used alone or in combination.

(2) *Clotting enzymes.* Rennet and/or other clotting enzymes of animal, plant, or microbial origin.

(3) *Other optional ingredients.* (i) Coloring.

(ii) Calcium chloride in an amount not more than 0.02 percent (calculated as anhydrous calcium chloride) of the weight of the dairy ingredients, used as a coagulation aid.

(iii) Enzymes of animal, plant, or microbial origin, used in curing or flavor development.

(iv) Antimycotic agents, the cumulative levels of which shall not exceed

current good manufacturing practice, may be added to the surface of the cheese.

(v) Hydrogen peroxide, followed by a sufficient quantity of catalase preparation to eliminate the hydrogen peroxide. The weight of the hydrogen peroxide shall not exceed 0.05 percent of the weight of the dairy ingredients and the weight of the catalase shall not exceed 20 parts per million of the weight of dairy ingredients treated.

(c) *Nomenclature.* The name of the food is “washed curd cheese” or, alternatively, “soaked curd cheese”.

(d) *Label declaration.* Each of the ingredients used in the food shall be declared on the label as required by the applicable sections of parts 101 and 130 of this chapter, except that:

(1) Enzymes of animal, plant or microbial origin may be declared as “enzymes”; and

(2) The dairy ingredients may be declared, in descending order of predominance, by the use of the terms “milkfat and nonfat milk” or “nonfat milk and milkfat”, as appropriate.

[54 FR 32054, Aug. 4, 1989, as amended at 58 FR 2893, Jan. 6, 1993]

§ 133.137 **Washed curd cheese for manufacturing.**

Washed curd cheese for manufacturing conforms to the definition and standard of identity prescribed for washed curd cheese by §133.136, except that the dairy ingredients are not pasteurized and curing is not required.

[54 FR 32054, Aug. 4, 1989]

§ 133.138 **Edam cheese.**

(a) *Description.* (1) Edam cheese is the food prepared by the procedure set forth in paragraph (a)(3) of this section or by any other procedure which produces a finished cheese having the same physical and chemical properties. The minimum milkfat content is 40 percent by weight of the solids and the maximum moisture content is 45 percent by weight, as determined by the methods described in §133.5. If the dairy ingredients used are not pasturized, the cheese is cured at a temperature of not less than than 35 °F for at least 60 days.

(2) If pasteurized dairy ingredients are used, the phenol equivalent value of 0.25 gram of edam cheese is not more than 3 micrograms, as determined by the method described in §133.5.

(3) One or more of the dairy ingredients specified in paragraph (b)(1) of this section may be warmed and is subjected to the action of a lactic acid-producing bacterial culture. One or more of the clotting enzymes specified in paragraph (b)(2) of this section is added to set the dairy ingredients to a semisolid mass. After coagulation the mass is cut into small cube-shaped pieces with sides approximately three-eighths-inch long. The mass is stirred and heated to about 90 °F. and so handled by further stirring, heating, dilution with water or salt brine, and salting as to promote and regulate the separation of curd and whey. When the desired curd is obtained, it is transferred to forms permitting drainage of whey. During drainage the curd is pressed and turned. After drainage the curd is removed from the forms and is salted and cured. One or more of the other optional ingredients specified in paragraph (b)(3) of this section may be added during the procedures.

(b) *Optional ingredients.* The following safe and suitable ingredients may be used:

(1) *Dairy ingredients.* Milk, nonfat milk, or cream, as defined in §133.3, used alone or in combination.

(2) *Clotting enzymes.* Rennet and/or other clotting enzymes of animal, plant, or microbial origin.

(3) *Other optional ingredients.* (i) Coloring.

(ii) Calcium chloride in an amount not more than 0.02 percent (calculated as anhydrous calcium chloride) of the weight of the dairy ingredients, used as a coagulation aid.

(iii) Enzymes of animal, plant, or microbial origin, used in curing or flavor development.

(iv) Antimycotic agents, the cumulative levels of which shall not exceed current good manufacturing practice, may be added to the surface of the cheese.

(c) *Nomenclature.* The name of the food is "edam cheese."

(d) *Label declaration.* Each of the ingredients used in the food shall be de-

clared on the label as required by the applicable sections of parts 101 and 130 of this chapter, except that:

(1) Enzymes of animal, plant, or microbial origin may be declared as "enzymes"; and

(2) The dairy ingredients may be declared, in descending order of predominance, by the use of the terms "milkfat and nonfat milk" or "nonfat milk and milkfat," as appropriate.

[48 FR 2743, Jan. 21, 1983; 48 FR 11426, Mar. 18, 1983, as amended at 55 FR 6795, Feb. 27, 1990; 58 FR 2893, Jan. 6, 1993]

§ 133.140 Gammelost cheese.

(a) *Description.* (1) Gammelost cheese is the food prepared from nonfat milk, as defined in §133.3, by the procedure set forth in paragraph (a)(2) of this section, or by any other procedure which produces a finished cheese having the same physical and chemical properties. The maximum moisture content is 52 percent by weight, as determined by the methods described in §133.5.

(2) The dairy ingredients are subjected to the action of a lactic acid-producing bacterial culture. The development of acidity is continued until the dairy ingredients coagulate to a semisolid mass. The mass is stirred and heated until a temperature of about 145 °F is reached, and is held at that temperature for at least 30 minutes. The whey is drained off and the curd removed and placed in forms and pressed. The shaped curd is placed in whey and heated for 3 or 4 hours, and may again be pressed. It is then stored under conditions suitable for curing.

(b) *Nomenclature.* The name of the food is "gammelost cheese".

(c) *Label declaration.* Each of the ingredients used in the food shall be declared on the label as required by the applicable sections of parts 101 and 130 of this chapter.

[54 FR 32054, Aug. 4, 1989, as amended at 58 FR 2893, Jan. 6, 1993]

§ 133.141 Gorgonzola cheese.

(a) *Description.* (1) Gorgonzola cheese is the food prepared by the procedure set forth in paragraph (a)(2) of this section or by any other procedure which produces a finished cheese having the same physical and chemical properties.

It is characterized by the presence of bluish-green mold, *Penicillium roquefortii*, throughout the cheese. The minimum milkfat content is 50 percent by weight of the solids and the maximum moisture content is 42 percent by weight, as determined by the methods described in §133.5. The dairy ingredients used may be pasteurized. Gorgonzola cheese is at least 90 days old.

(2) One or more of the dairy ingredients specified in paragraph (b)(1) of this section may be warmed and is subjected to the action of a lactic acid-producing bacterial culture. One or more of the clotting enzymes specified in paragraph (b)(2) of this section is added to set the dairy ingredients to a semisolid mass. The mass is cut into smaller portions and allowed to stand for a time. The mixed curd and whey is placed into forms permitting further drainage. While being placed in forms, spores of the mold *Penicillium roquefortii* are added. The forms are turned several times during drainage. When sufficiently drained, the shaped curd is removed from the forms and salted with dry salt or brine. Perforations are then made in the shaped curd and it is held at a temperature of approximately 50 °F at 90 to 95 percent relative humidity, until the characteristic mold growth has developed. During storage, the surface of the cheese may be scraped to remove surface growth of undesirable microorganisms. One or more of the other optional ingredients specified in paragraph (b)(3) of this section may be added during the procedure.

(b) *Optional ingredients.* The following safe and suitable ingredients may be used:

(1) *Dairy ingredients.* Milk, nonfat milk, or cream, as defined in §133.3, or corresponding products of goat origin, used alone or in combination.

(2) *Clotting enzymes.* Rennet and/or other clotting enzymes of animal, plant, or microbial origin.

(3) *Other optional ingredients.* (i) Blue or green color in an amount to neutralize the natural yellow color of the curd.

(ii) Calcium chloride in an amount not more than 0.02 percent (calculated as anhydrous calcium chloride) of the

weight of the dairy ingredients, used as a coagulation aid.

(iii) Enzymes of animal, plant, or microbial origin, used in curing or flavor development.

(iv) Antimycotic agents, the cumulative levels of which shall not exceed current good manufacturing practice, may be added to the surface of the cheese.

(v) Benzoyl peroxide, or a mixture of benzoyl peroxide with potassium alum, calcium sulfate, and magnesium carbonate used to bleach the dairy ingredients. The weight of the benzoyl peroxide is not more than 0.002 percent of the weight of the dairy ingredients being bleached, and the weight of the potassium alum, calcium sulfate, and magnesium carbonate, singly or combined, is not more than six times the weight of the benzoyl peroxide used. If the dairy ingredients are bleached in this manner, vitamin A is added to the curd in such quantity as to compensate for the vitamin A or its precursors destroyed in the bleaching process, and artificial coloring is not used.

(vi) Vegetable fats or oil which may be hydrogenated, used as a coating for the rind.

(c) *Nomenclature.* The name of the food is "gorgonzola cheese".

(d) *Label declaration.* Each of the ingredients used in the food shall be declared on the label as required by the applicable sections of parts 101 and 130 of this chapter, except that:

(1) Enzymes of animal, plant, or microbial origin may be declared as "enzymes"; and

(2) The dairy ingredients may be declared, in descending order of predominance, by the use of the terms "milkfat and nonfat milk" or "nonfat milk and milkfat", as appropriate; "milkfat from goat's milk and nonfat goat's milk", etc.

[54 FR 32054, Aug. 4, 1989, as amended at 58 FR 2893, Jan. 6, 1993]

§ 133.142 Gouda cheese.

Gouda cheese conforms to the definition and standard of identity and complies with the requirements for label declaration of ingredients prescribed for edam cheese by §133.138, except that

the minimum milkfat content is 46 percent by weight of the solids, as determined by the methods described in §133.5 and the maximum moisture content is 45 percent by weight.

[48 FR 2744, Jan. 21, 1983]

§ 133.144 Granular and stirred curd cheese.

(a) *Description.* (1) Granular cheese, stirred curd cheese is the food prepared by the procedure set forth in paragraph (a)(3) of this section or by any other procedure which produces a finished cheese having the same physical and chemical properties. The minimum milkfat content is 50 percent by weight of the solids and the maximum moisture content is 39 percent by weight as determined by the methods described in §133.5. If the dairy ingredients used are not pasteurized, the cheese is cured at a temperature of not less than 35 °F for at least 60 days.

(2) If pasteurized dairy ingredients are used, the phenol equivalent value of 0.25 gram of granular cheese is not more than 3 micrograms as determined by the method described in §133.5.

(3) One or more of the dairy ingredients specified in paragraph (b)(1) of this section may be warmed, treated with hydrogen peroxide/catalase, and is subjected to the action of a lactic acid-producing bacterial culture. One or more of the clotting enzymes specified in paragraph (b)(2) of this section is added to set the dairy ingredients to a semisolid mass. The mass is so cut, stirred, and heated with continued stirring, as to promote and regulate the separation of whey and curd. A part of the whey is drained off. The curd is then alternately stirred and drained to prevent matting and to remove whey from curd. The curd is then salted, stirred, drained, and pressed into forms. One or more of the other optional ingredients specified in paragraph (b)(3) of this section may be added during the procedure.

(b) *Optional ingredients.* The following safe and suitable ingredients may be used:

(1) *Dairy ingredients.* Milk, nonfat milk, or cream, as defined in §133.3, used alone or in combination.

(2) *Clotting enzymes.* Rennet and/or other clotting enzymes of animal, plant, or microbial origin.

(3) *Other optional ingredients.* (i) Coloring.

(ii) Calcium chloride in an amount not more than 0.02 percent (calculated as anhydrous calcium chloride) by weight of the dairy ingredients, used as a coagulation aid.

(iii) Enzymes of animal, plant, or microbial origin, used in curing or flavor development.

(iv) Antimycotic agents, the cumulative levels of which shall not exceed current good manufacturing practice, may be added to the surface of the cheese.

(v) Hydrogen peroxide, followed by a sufficient quantity of catalase preparation to eliminate the hydrogen peroxide. The weight of the hydrogen peroxide shall not exceed 0.05 percent of the weight of the dairy ingredients and the weight of the catalase shall not exceed 20 parts per million of the weight of the dairy ingredients treated.

(c) *Nomenclature.* The name of the food is "granular cheese" or, alternatively, "stirred curd cheese".

(d) *Label declaration.* Each of the ingredients used in the food shall be declared on the label as required by the applicable sections of parts 101 and 130 of this chapter, except that:

(1) Enzymes of animal, plant, or microbial origin may be declared as "enzymes"; and

(2) The dairy ingredients may be declared, in descending order of predominance, by the use of the terms "milkfat and nonfat milk" or "nonfat milk and milkfat", as appropriate.

[54 FR 32055, Aug. 4, 1989, as amended at 58 FR 2893, Jan. 6, 1993]

§ 133.145 Granular cheese for manufacturing.

Granular cheese for manufacturing conforms to the definition and standard of identity prescribed for granular cheese by §133.144, except that the dairy ingredients are not pasteurized and curing is not required.

[54 FR 32056, Aug. 4, 1989]

§ 133.146 Grated cheeses.

(a) *Description.* Grated cheeses is the class of foods prepared by grinding, grating, shredding, or otherwise comminuting cheese of one variety or a mixture of two or more varieties. The cheese varieties that may be used are those for which there are definitions and standards of identity, except that cream cheese, neufchatel cheese, cottage cheese, creamed cottage cheese, cook cheese, and skim milk cheese for manufacturing may not be used. All cheese ingredients used are either made from pasteurized milk or held at a temperature of not less than 35 °F for at least 60 days. Moisture may be removed from the cheese ingredients in the manufacture of the finished food, but no moisture is added. One or more of the optional ingredients specified in paragraph (c) of this section may be used.

(b) *Composition.* (1) Each cheese ingredient used is present at a minimum level of 2 percent of the weight of the finished food.

(2) When one variety of cheese is used, the minimum milkfat content of the food is not more than 1 percent lower than the minimum prescribed by the standard of identity for that cheese.

(3) When two or more varieties of cheese are used, the minimum milkfat content is not more than 1 percent below the arithmetical average of the minimum fat content percentages prescribed by the standards of identity for the varieties of cheese used, and in no case is the milkfat content less than 31 percent.

(4) Milkfat and moisture contents are determined by the methods described in § 133.5.

(c) *Optional ingredients.* The following safe and suitable ingredients may be used:

- (1) Antimycotics.
- (2) Anticaking agents.
- (3) Spices.

(4) Flavorings other than those which, singly or in combination with other ingredients, simulate the flavor of cheese of any age or variety.

(d) *Nomenclature.* (1) The name of the food is “grated cheese” or “grated cheeses”, as appropriate. The name of the food shall be accompanied by a dec-

laration of the specific variety of cheese(s) used in the food and by a declaration indicating the presence of any added spice or flavoring.

(2) Any cheese varietal names used in the name of the food are those specified by applicable standards of identity, except that the designation “American cheese” may be used for cheddar, washed curd, colby, or granular cheese or for any mixture of these cheeses.

(3) The following terms may be used in place of the name of the food to describe specific types of grated cheese:

(i) If only one variety of cheese is used, the name of the food is “grated _____ cheese”, the name of the cheese filling the blank.

(ii) If only parmesan and romano cheeses are used and each is present at a level of not less than 25 percent by weight of the finished food, the name of the food is “grated _____ and _____ cheese”, the blanks being filled with the names “parmesan” and “romano” in order of predominance by weight. The name “reggiano” may be used for “parmesan”.

(iii) If a mixture of cheese varieties (not including parmesan or romano) is used and each variety is present at a level of not less than 25 percent of the weight of the finished food, the name of the food is “grated _____ cheese”, the blank being filled in with the names of the varieties in order of predominance by weight.

(iv) If a mixture of cheese varieties in which one or more varieties (not including parmesan or romano) are each present at a level of not less than 25 percent by weight of the finished food, and one or more other varieties (which may include parmesan and romano cheese) are each present at a level of not less than 2 percent but in the aggregate not more than 10 percent of the weight of the finished food, the name of the food is “grated _____ cheese with other grated cheese” or “grated _____ cheese with other grated cheeses”, as appropriate, the blank being filled in with the name or names of those cheese varieties present at levels of not less than 25 percent by weight of the finished food in order of predominance, in letters not more than twice as high

as the letters in the phrase “with other grated cheese(s)”.

(4) The following terms may be used in place of “grated” to describe alternative forms of cheese:

(i) “Shredded”, if the particles of cheese are in the form of cylinders, shreds, or strings.

(ii) “Chipped” or “chopped”, if the particles of cheese are in the form of chips.

(e) *Label declaration.* Each of the ingredients used in the food shall be declared on the label as required by the applicable sections of parts 101 and 130 of this chapter, except that:

(1) Enzymes of animal, plant, or microbial origin may be declared as “enzymes”; and

(2) The dairy ingredients may be declared, in descending order of predominance, by the use of the terms “milkfat and nonfat milk” or “nonfat milk and milkfat”, “milkfat from goat’s milk and nonfat goat’s milk”, “milkfat from sheep’s milk and nonfat sheep’s milk”, etc., as appropriate.

[54 FR 32056, Aug. 4, 1989; 54 FR 35756, Aug. 29, 1989, as amended at 58 FR 2893, Jan. 6, 1993]

§ 133.147 Grated American cheese food.

(a)(1) Grated American cheese food is the food prepared by mixing, with or without the aid of heat, one or more of the optional cheese ingredients prescribed in paragraph (b) of this section with one or more of the optional ingredients prescribed in paragraph (c) of this section, into a uniformly blended, partially dehydrated, powdered, or granular mixture.

(2) Grated American cheese food contains not less than 23 percent of milkfat, as determined by the method prescribed in § 133.5(b).

(b) The optional cheese ingredients referred to in paragraph (a) of this section are cheddar cheese, washed curd cheese, colby cheese, and granular cheese.

(c) The other optional ingredients referred to in paragraph (a) of this section are:

(1) Nonfat dry milk.

(2) Dried whey.

(3) An emulsifying agent consisting of one or any mixture of two or more of the emulsifying ingredients named in

§ 133.173(e)(1), in such quantity that the weight of the solids thereof is not more than 3 percent of the weight of the grated American cheese food.

(4) An acidifying agent consisting of one or more of the acid-reacting ingredients named in § 133.173(e)(2).

(5) Salt.

(6) Artificial coloring.

(d) The name of the food is “Grated American cheese food”. The full name of the food shall appear on the principal display panel of the label in type of uniform size, style, and color. Whenever any word or statement emphasizing the name of any ingredient appears on the label (other than in an ingredient statement as specified in paragraph (e) of this section) so conspicuously as to be easily seen under customary conditions of purchase, the full name of the food shall immediately and conspicuously precede or follow such word or statement in type of at least the same size as the type used in such word or statement.

(e) Each of the ingredients used in the food shall be declared on the label as required by the applicable sections of parts 101 and 130 of this chapter, except that cheddar cheese, washed curd cheese, colby cheese, granular cheese, or any mixture of two or more of these may be designated “American cheese”.

[42 FR 14366, Mar. 15, 1977, as amended at 49 FR 10094, Mar. 19, 1984; 58 FR 2893, Jan. 6, 1993]

§ 133.148 Hard grating cheeses.

(a) The cheeses for which definitions and standards of identity are prescribed by this section are hard grating cheeses for which specifically applicable definitions and standards of identity are not prescribed by other sections of this part. They are made from milk and the other ingredients specified in this section, by the procedure set forth in paragraph (b) of this section. They contain not more than 34 percent of moisture, and their solids contain not less than 32 percent of milkfat, as determined by the methods prescribed in § 133.5 (a), (b), and (d). Hard grating cheeses are cured for not less than 6 months.

(b) Milk, which may be pasteurized or clarified or both, and which may be warmed, is subjected to the action of

harmless lactic-acid-producing bacteria or other harmless flavor-producing bacteria, present in such milk or added thereto. Sufficient rennet, rennet paste, extract of rennet paste, or other safe and suitable milk-clotting enzyme that produces equivalent curd formation, singly or in any combination (with or without purified calcium chloride in a quantity not more than 0.02 percent, calculated as anhydrous calcium chloride, of the weight of the milk) is added to set the milk to a semisolid mass. Harmless artificial coloring may be added. The mass is cut into small particles, stirred, and heated. The curd is separated from the whey, drained, shaped into forms, pressed, salted, and cured. The rind may be colored or rubbed with vegetable oil or both. A harmless preparation of enzymes of animal or plant origin capable of aiding in the curing or development of flavor of hard grating cheese may be added during the procedure, in such quantity that the weight of the solids of such preparation is not more than 0.1 percent of the weight of the milk used.

(c) For the purposes of this section, the word "milk" means cow's milk or goat's milk or sheep's milk or mixtures of two or all of these. Such milk may be adjusted by separating part of the fat therefrom or (in the case of cow's milk) by adding one or more of the following: Cream, skim milk, concentrated skim milk, nonfat dry milk; (in the case of goat's milk) the corresponding products from goat's milk; (in the case of sheep's milk) the corresponding products from sheep's milk; water in a quantity sufficient to reconstitute any such concentrated or dried products used.

(d) Safe and suitable antimycotic agent(s), the cumulative levels of which shall not exceed current good manufacturing practice, may be added to the surface of the cheese.

(e) The name of each hard grating cheese for which a definition and standard of identity is prescribed by this section is "Hard grating cheese", preceded or followed by:

(1) The specific common or usual name of such hard grating cheese, if any such name has become generally recognized therefor; or

(2) If no such specific common or usual name has become generally recognized therefor, an arbitrary or fanciful name that is not false or misleading in any particular.

(3) When milk other than cow's milk is used, in whole or in part, the statement "made from _____", the blank being filled in with the name or names of the milk used, in order of predominance by weight.

(f) Label declaration: Each of the ingredients used in the food shall be declared on the label as required by the applicable sections of parts 101 and 130 of this chapter, except that:

(1) When milk other than cow's milk is used, in whole or in part, the common or usual name of each such milk ingredient shall be declared in order of predominance by weight; and

(2) Enzymes of the animal, plant, or microbial origin may be declared as "enzymes".

[42 FR 14366, Mar. 15, 1977, as amended at 48 FR 49013, Oct. 24, 1983; 49 FR 10094, Mar. 19, 1984; 58 FR 2893, Jan. 6, 1993]

§ 133.149 Gruyere cheese.

(a) *Description.* (1) Gruyere cheese is the food prepared by the procedure set forth in paragraph (a)(3) of this section or by any other procedure which produces a finished cheese having the same physical and chemical properties. It contains small holes or eyes. It has a mild flavor, due in part to the growth of surface-curing agents. The minimum milkfat content is 45 percent by weight of the solids and the maximum moisture content is 39 percent by weight, as determined by the methods described in §133.5. The dairy ingredients used may be pasteurized. The cheese is at least 90 days old.

(2) If pasteurized dairy ingredients are used, the phenol equivalent value of 0.25 gram of gruyere cheese is not more than 3 micrograms as determined by the method described in §133.5.

(3) One or more of the dairy ingredients specified in paragraph (b)(1) of this section may be warmed and is subjected to the action of lactic acid-producing and propionic acid-producing bacterial cultures. One or more of the clotting enzymes specified in paragraph (b)(2) of this section is added to set the dairy ingredients to a semisolid

mass. The mass is cut into particles similar in size to wheat kernels. For about 30 minutes the particles are alternately stirred and allowed to settle. The temperature is raised to about 126 °F. Stirring is continued until the curd becomes firm. The curd is transferred to hoops or forms, and pressed until the desired shape and firmness are obtained. The cheese is surface-salted while held at a temperature of 48° to 54 °F for a few days. It is soaked for 1 day in a saturated salt solution. It is then held for 3 weeks in a salting cellar and wiped every 2 days with brine cloth to insure growth of biological curing agents on the rind. It is then removed to a heating room and held at progressively higher temperatures, finally reaching 65 °F with a relative humidity of 85 to 90 percent, for several weeks, during which time small holes, or so-called eyes, form. The cheese is then stored at a lower temperature for further curing. One or more of the other optional ingredients specified in paragraph (b)(3) of this section may be added during the procedure.

(b) *Optional ingredients.* The following safe and suitable ingredients may be used:

(1) *Dairy ingredients.* Milk, nonfat milk, or cream, as defined in §133.3, used alone or in combination.

(2) *Clotting enzymes.* Rennet and/or other clotting enzymes of animal, plant, or microbial origin.

(3) *Other optional ingredients.* (i) Calcium chloride in an amount not more than 0.02 percent (calculated as anhydrous calcium chloride) of the weight of the dairy ingredients, used as a coagulation aid.

(ii) Enzymes of animal, plant, or microbial origin, used in curing or flavor development.

(iii) Antimycotic agents, applied to the surface of slices or cuts in consumer-sized packages.

(c) *Nomenclature.* The name of the food is “gruyere cheese”.

(d) *Label declaration.* Each of the ingredients used in the food shall be declared on the label as required by the applicable sections of parts 101 and 130 of this chapter, except that:

(1) Enzymes of animal, plant, or microbial origin may be declared as “enzymes”; and

(2) The dairy ingredients may be declared, in descending order of predominance, by the use of the terms “milkfat and nonfat milk” or “nonfat milk and milkfat”, as appropriate.

[48 FR 2744, Jan. 21, 1983; 48 FR 11426, Mar. 18, 1983, as amended at 58 FR 2893, Jan. 6, 1993]

§ 133.150 Hard cheeses.

(a) The cheeses for which definitions and standards of identity are prescribed by this section are hard cheeses for which specifically applicable definitions and standards of identity are not prescribed by other sections of this part. They are made from milk and the other ingredients specified in this section, by the procedure set forth in paragraph (b) of this section. They contain not more than 39 percent of moisture, and their solids contain not less than 50 percent of milkfat, as determined by the methods prescribed in §133.5 (a), (b), and (d). If the milk used is not pasteurized, the cheese so made is cured at a temperature of not less than 35 °F for not less than 60 days.

(b) Milk, which may be pasteurized or clarified or both, and which may be warmed, is subjected to the action of harmless lactic-acid-producing bacteria, with or without other harmless flavor-producing bacteria, present in such milk or added thereto. Harmless artificial coloring may be added. Sufficient rennet, rennet paste, extract of rennet paste, or other safe and suitable milk-clotting enzyme that produces equivalent curd formation, singly or in any combination (with or without purified calcium chloride in a quantity not more than 0.02 percent, calculated as anhydrous calcium chloride, of the weight of the milk) is added to set the milk to a semisolid mass. The mass is cut into small particles, stirred, and heated. The curd is separated from the whey, drained, and shaped into forms, and may be pressed. The curd is salted at some stage of the manufacturing process. The shaped curd may be cured. The rind may be coated with paraffin or rubbed with vegetable oil. A harmless preparation of enzymes of animal or plant origin capable of aiding in the curing or development of flavor of hard cheese may be added during the procedure, in such quantity that the weight of the solids of such preparation is not

§ 133.152

21 CFR Ch. I (4-1-07 Edition)

more than 0.1 percent of the weight of the milk used. Harmless flavor-producing microorganisms may be added, and curing may be conducted under suitable conditions for the development of biological curing agents.

(c) For the purposes of this section:

(1) The word "milk" means cow's milk or goat's milk or sheep's milk or mixtures of two or all of these. Such milk may be adjusted by separating part of the fat therefrom, or (in the case of cow's milk) by adding one or more of the following: Cream, skim milk, concentrated skim milk, nonfat dry milk; (in the case of goat's milk) the corresponding products from goat's milk; (in the case of sheep's milk) the corresponding products from sheep's milk; water in a quantity sufficient to reconstitute any concentrated or dried products used.

(2) Milk shall be deemed to have been pasteurized if it has been held at a temperature of not less than 143 °F for a period of not less than 30 minutes, or for a time and at a temperature equivalent thereto in phosphatase destruction. A hard cheese shall be deemed not to have been made from pasteurized milk if 0.25 gram shows a phenol equivalent of more than 3 micrograms when tested by the method prescribed in §133.5(c).

(d) Safe and suitable antimycotic agent(s), the cumulative levels of which shall not exceed current good manufacturing practice, may be added to the surface of the cheese.

(e) The name of each hard cheese for which a definition and standard of identity is prescribed by this section is "Hard cheese", preceded or followed by:

(1) The specific common or unusual name of such hard cheese, if any such name has become generally recognized therefor; or

(2) If no such specific common or usual name has become generally recognized, therefor, an arbitrary or fanciful name that is not false or misleading in any particular.

(3) When milk other than cow's milk is used, in whole or in part, the statement "made from _____", the blank being filled in with the name or names of the milk used, in order of predominance by weight.

(f) Label declaration: Each of the ingredients used in the food shall be declared on the label as required by the applicable sections of parts 101 and 130 of this chapter, except that:

(1) When milk other than cow's milk is used, in whole or in part, the common or usual name of each such milk ingredient shall be declared in order of predominance by weight; and

(2) Enzymes of animal, plant, or microbial origin may be declared as "enzymes".

[42 FR 14366, Mar. 15, 1977, as amended at 48 FR 49013, Oct. 24, 1983; 49 FR 10094, Mar. 19, 1984; 58 FR 2893, Jan. 6, 1993]

§ 133.152 Limburger cheese.

(a) *Description.* (1) Limburger cheese is the food prepared by one of the procedures set forth in paragraph (a)(3) of this section, or by any other procedure which produces a finished cheese having the same physical and chemical properties. The minimum milkfat content is 50 percent by weight of the solids and the maximum moisture content is 50 percent by weight, as determined by the methods described in §133.5. If the dairy ingredients used are not pasteurized, the cheese is cured at a temperature of not less than 35 °F for at least 60 days.

(2) If pasteurized dairy ingredients are used, the phenol equivalent value of 0.25 gram of limburger cheese is not more than 4 micrograms as determined by the method described in §133.5.

(3) One of the following procedures may be followed for producing limburger cheese:

(i) One or more of the dairy ingredients, unpasteurized, specified in paragraph (b)(1) of this section is warmed to about 92 °F and subjected to the action of a lactic acid-producing bacterial culture. One or more of the clotting enzymes specified in paragraph (b)(2) of this section is added to set the dairy ingredients to a semisolid mass. The mass is cut into cubes with sides approximately one-half inch long. After a few minutes the mass is stirred and heated, gradually raising the temperature to 96° to 98 °F. The curd is then allowed to settle, most of the whey is drained off, and the remaining curd and whey dipped into molds. During drainage the curd may be pressed.

It is turned at regular intervals. After drainage the curd is cut into pieces of desired size and dry-salted at intervals for 24 to 48 hours. The cheese is then cured with frequent applications of a weak brine solution to the surface, until the proper growth of surface-curing organisms is obtained. It is then wrapped and held in storage for development of as much additional flavor as is desired. One or more of the other optional ingredients specified in paragraph (b)(3) of this section may be added during the procedure.

(ii) One or more of the dairy ingredients specified in paragraph (b)(1) of this section is pasteurized, brought to a temperature of 89° to 90 °F. after pasteurization, and is subjected to the action of a lactic acid-producing bacterial culture. The procedure is then the same as in paragraph (a)(3)(i) of this section, except that heating is to 94 °F. After most of the whey is drained off, salt brine at a temperature of 66° to 70 °F is added, so that the pH of the curd is about 4.8. The mixed curd, whey, and brine is dipped into molds, and the remaining procedure specified in paragraph (a)(3)(i) of this section is followed.

(b) *Optional ingredients.* The following safe and suitable ingredients may be used:

(1) *Dairy ingredients.* Milk, nonfat milk, or cream, as defined in §133.3, used alone or in combination.

(2) *Clotting enzymes.* Rennet and/or other clotting enzymes of animal, plant, or microbial origin.

(3) *Other optional ingredients.* (i) Coloring.

(ii) Calcium chloride in an amount not more than 0.02 percent (calculated as anhydrous calcium chloride) by weight of the dairy ingredients, used as a coagulation aid.

(iii) Enzymes of animal, plant, or microbial origin, used in curing or flavor development.

(c) *Nomenclature.* The name of the food is "limburger cheese".

(d) *Label declaration.* Each of the ingredients used in the food shall be declared on the label as required by the applicable sections of parts 101 and 130 of this chapter, except that:

(1) Enzymes of animal, plant, or microbial origin may be declared as "enzymes"; and

(2) The dairy ingredients may be declared, in descending order of predominance, by the use of the terms "milkfat and nonfat milk" or "nonfat milk and milkfat", as appropriate.

[48 FR 2744, Jan. 21, 1983; 48 FR 11426, Mar. 18, 1983, as amended at 58 FR 2893, Jan. 6, 1993]

§ 133.153 Monterey cheese and monterey jack cheese.

(a) *Description.* (1) Monterey cheese, monterey jack cheese is the food prepared by the procedure set forth in paragraph (a)(3) of this section, or by any other procedure which produces a finished cheese having the same physical and chemical properties. The minimum milkfat content is 50 percent by weight of the solids, and the maximum moisture content is 44 percent by weight, as determined by the methods described in §133.5. The dairy ingredients used are pasteurized.

(2) The phenol equivalent of 0.25 gram of monterey cheese is not more than 3 micrograms, as determined by the method described in §133.5.

(3) One or more of the dairy ingredients specified in paragraph (b)(1) of this section is subjected to the action of a lactic acid-producing bacterial culture. One or more of the clotting enzymes specified in paragraph (b)(2) of this section is added to set the dairy ingredients to a semisolid mass. The mass is so cut, stirred, and heated with continued stirring, as to promote and regulate the separation of whey and curd. Part of the whey is drained off, and water or salt brine may be added. The curd is drained and placed in a muslin or sheeting cloth, formed into a ball, and pressed; or the curd is placed in a cheese hoop and pressed. Later, the cloth bandage is removed, and the cheese may be covered with a suitable coating. One or more of the other optional ingredients specified in paragraph (b)(3) of this section may be added during the procedure.

(b) *Optional ingredients.* The following safe and suitable ingredients may be used:

(1) *Dairy ingredients.* Milk, nonfat milk, or cream, as defined in §133.3, used alone or in combination.

§ 133.154

21 CFR Ch. I (4-1-07 Edition)

(2) *Clotting enzymes.* Rennet and/or other clotting enzymes of animal, plant, or microbial origin.

(3) *Other optional ingredients.* (i) Calcium chloride in an amount not more than 0.02 percent (calculated as anhydrous calcium chloride) by weight of the dairy ingredients, used as a coagulation aid.

(ii) Enzymes of animal, plant, or microbial origin, used in curing or flavor development.

(iii) Salt.

(iv) Antimycotic agents, the cumulative levels of which shall not exceed current good manufacturing practice, may be added to the surface of the cheese.

(v) Vegetable oil, with or without rice flour sprinkled on the surface, used as a coating for the rind.

(c) *Nomenclature.* The name of the food is "monterey cheese" or alternatively, "monterey jack cheese".

(d) *Label declaration.* Each of the ingredients used in the food shall be declared on the label as required by the applicable sections of parts 101 and 130 of this chapter, except that:

(1) Enzymes of animal, plant, or microbial origin may be declared as "enzymes", and

(2) The dairy ingredients may be declared, in descending order of predominance, by the use of the terms "milkfat and nonfat milk" or "nonfat milk and milkfat", as appropriate.

[54 FR 32056, Aug. 4, 1989, as amended at 58 FR 2893, Jan. 6, 1993]

§ 133.154 High-moisture jack cheese.

High-moisture jack cheese conforms to the definition and standard of identity and is subject to the requirement for label statement of ingredients prescribed for monterey cheese by § 133.153, except that its moisture content is more than 44 percent but less than 50 percent.

[58 FR 2893, Jan. 6, 1993]

§ 133.155 Mozzarella cheese and scamorza cheese.

(a) *Description.* (1) Mozzarella cheese, scamorza cheese is the food prepared from dairy ingredients and other ingredients specified in this section by the procedure set forth in paragraph (a)(3)

of this section, or by any other procedure which produces a finished cheese having the same physical and chemical properties. It may be molded into various shapes. The minimum milkfat content is 45 percent by weight of the solids, and the moisture content is more than 52 percent but not more than 60 percent by weight as determined by the methods described in § 133.5. The dairy ingredients are pasteurized.

(2) The phenol equivalent value of 0.25 gram of mozzarella cheese is not more than 3 micrograms as determined by the method described in § 133.5.

(3) One or more of the dairy ingredients specified in paragraph (b)(1) of this section is warmed to approximately 88 °F (31.1 °C) and subjected to the action of a lactic acid-producing bacterial culture. One or more of the clotting enzymes specified in paragraph (b)(2) of this section is added to set the dairy ingredients to a semisolid mass. The mass is cut, and it may be stirred to facilitate separation of whey from the curd. The whey is drained, and the curd may be washed with cold water and the water drained off. The curd may be collected in bundles for further drainage and for ripening. The curd may be iced, it may be held under refrigeration, and it may be permitted to warm to room temperature and ripen further. The curd may be cut. It is immersed in hot water or heated with steam and is kneaded and stretched until smooth and free of lumps. It is then cut and molded. The molded curd is firmed by immersion in cold water and drained. One or more of the other optional ingredients specified in paragraph (b)(3) of this section may be added during the procedure.

(b) *Optional ingredients.* The following safe and suitable ingredients may be used:

(1) *Dairy ingredients.* Cow's milk, nonfat milk, or cream, as defined in § 133.3, or the corresponding products of water buffalo origin, except that cow's milk products are not combined with water buffalo products.

(2) *Clotting enzymes.* Rennet and/or other clotting enzymes of animal, plant, or microbial origin.

(3) *Other optional ingredients.* (i) Vinegar.

(ii) Coloring to mask any natural yellow color in the curd.

(iii) Salt.

(iv) Antimicrobials, the cumulative levels of which shall not exceed current good manufacturing practice, may be added to the cheese during the kneading and stretching process and/or applied to the surface of the cheese.

(c) *Nomenclature.* The name of the food is "mozzarella cheese" or, alternatively, "scamorza cheese". When the food is made with water buffalo milk, the name of the food is accompanied by the phrase "made with water buffalo milk".

(d) *Label declaration.* Each of the ingredients used in the food shall be declared on the label as required by the applicable sections of parts 101 and 130 of this chapter, except that:

(1) Enzymes of animal, plant, or microbial origin may be declared as "enzymes"; and

(2) The dairy ingredients may be declared, in descending order of predominance, by the use of the terms "milkfat and nonfat milk" or "nonfat milk and milkfat", "milkfat from water buffalo milk and nonfat buffalo milk" or "nonfat water buffalo milk and milkfat from water buffalo milk," as appropriate.

[53 FR 3743, Feb. 9, 1988, as amended at 58 FR 2893, Jan. 6, 1993]

§ 133.156 Low-moisture mozzarella and scamorza cheese.

(a) *Description.* (1) Low-moisture mozzarella cheese, low-moisture scamorza cheese is the food prepared from dairy ingredients and other ingredients specified in this section by the procedure set forth in paragraph (a)(3) of this section, or by any other procedure which produces a finished cheese having the same physical and chemical properties. It may be molded into various shapes. The minimum milkfat content is 45 percent by weight of the solids and the moisture content is more than 45 percent but not more than 52 percent by weight as determined by the methods described in §133.5. The dairy ingredients are pasteurized.

(2) The phenol equivalent value of 0.25 gram of low-moisture mozzarella cheese is not more than 3 micrograms

as determined by the method described in §133.5.

(3) One or more of the dairy ingredients specified in paragraph (b)(1) of this section may be warmed and is subjected to the action of a lactic acid-producing bacterial culture. One or more of the clotting enzymes specified in paragraph (b)(2) of this action is added to set the dairy ingredients to a semisolid mass. The mass is cut, stirred, and allowed to stand. It may be reheated and again stirred. The whey is drained and the curd may be cut and piled to promote further separation of whey. It may be washed with cold water and the water drained off. The curd may be collected in bundles for further drainage and for ripening. The curd may be iced, it may be held under refrigeration, and it may be permitted to warm to room temperature and ripen further. The curd may be cut. It is immersed in hot water or heated with steam and is kneaded and stretched until smooth and free of lumps. It is then cut and molded. In molding, the curd is kept sufficiently warm to cause proper sealing of the surface. The molded curd is firmed by immersion in cold water and drained. One or more of the other optional ingredients specified in paragraph (b)(3) of this section may be added during the procedure.

(b) *Optional ingredients.* The following safe and suitable ingredients may be used:

(1) *Dairy ingredients.* Cow's milk, nonfat milk, or cream, as defined in §133.3, or the corresponding products of water buffalo origin, except that cow's milk products are not combined with water buffalo products.

(2) *Clotting enzymes.* Rennet and/or clotting enzymes of animal, plant, or microbial origin.

(3) *Other optional ingredients.* (i) Vinegar.

(ii) Coloring to mask any natural yellow color in the curd.

(iii) Salt.

(iv) Calcium chloride in an amount not more than 0.02 percent (calculated as anhydrous calcium chloride) of the weight of the dairy ingredients, used as a coagulation aid.

(v) Antimicrobials, the cumulative levels of which shall not exceed current

§ 133.157

good manufacturing practices, may be added to the cheese during the kneading and stretching process and/or applied to the surface of the cheese.

(c) *Nomenclature.* The names of the food is “low-moisture mozzarella cheese” or, alternatively, “low-moisture scamorza cheese”. When the food is made with water buffalo milk, the name of the food is accompanied by the phrase “made with water buffalo milk”.

(d) *Label declaration.* Each of the ingredients used in the food shall be declared on the label as required by the applicable sections of parts 101 and 130 of this chapter, except that:

(1) Enzymes of animal, plant, or microbial origin may be declared as “enzymes”; and

(2) The dairy ingredients may be declared, in descending order of predominance, by the use of the terms “milkfat and nonfat milk” or “nonfat milk and milkfat”, “milkfat from water buffalo milk and nonfat water buffalo milk” or “nonfat water buffalo) The dairy ingredients may be declared, in descending order of predominance, by the use of the terms “milkfat and nonfat milk” or “nonfat milk and milkfat”, “milkfat from water buffalo milk and nonfat water buffalo milk” or “nonfat water buffalo milk and milkfat from water buffalo milk”, as appropriate.

[53 FR 3743, Feb. 9, 1988, as amended at 58 FR 2893, Jan. 6, 1993]

§ 133.157 Part-skim mozzarella and scamorza cheese.

Part-skim mozzarella cheese, part-skim scamorza cheese conforms to the definition and standard of identity as prescribed for mozzarella cheese by §133.155, except that its milk fat content, calculated on the solids basis, is less than 45 percent but not less than 30 percent.

§ 133.158 Low-moisture part-skim mozzarella and scamorza cheese.

Low-moisture part-skim mozzarella cheese and low-moisture part-skim scamorza cheese conform to the definition and standard of identity and comply with the requirements for label declaration of ingredients prescribed for low-moisture mozzarella cheese and low-moisture scamorza cheese by

21 CFR Ch. I (4–1–07 Edition)

§133.156, except that their milkfat content, calculated on the solids basis, is less than 45 percent but not less than 30 percent.

[58 FR 2894, Jan. 6, 1993]

§ 133.160 Muenster and munster cheese.

(a) *Description.* (1) Muenster cheese, munster cheese, is the food prepared by the procedure set forth in paragraph (a)(3) of this section or by any other procedure which produces a finished cheese having the same physical and chemical properties. The minimum milkfat content is 50 percent by weight of the solids and the maximum moisture content is 46 percent by weight, as determined by the methods described in §133.5. The dairy ingredients used are pasteurized.

(2) The phenol equivalent of 0.25 gram of muenster cheese is not more than 3 micrograms, as determined by the methods described in §133.5.

(3) One or more of the dairy ingredients specified in paragraph (b)(1) of this section may be warmed and is subjected to the action of a harmless lactic acid-producing bacterial culture. One or more of the clotting enzymes specified in paragraph (b)(2) of this section is added to set the dairy ingredients to a semisolid mass. After coagulation the mass is divided into small portions, stirred, and heated, with or without dilution with water or salt brine, so as to promote and regulate the separation of whey and curd. The curd is transferred to forms permitting drainage of the whey. During drainage the curd may be pressed and turned. After drainage the curd is removed from the forms and is salted. One or more of the other optional ingredients specified in paragraph (b)(3) of this section may be added during the procedure.

(b) *Optional ingredients.* The following safe and suitable ingredients may be used:

(1) *Dairy ingredients.* Milk, nonfat milk, or cream, as defined in §133.3, used alone or in combination.

(2) *Clotting enzymes.* Rennet and/or other clotting enzymes of animal, plant, or microbial origin.

(3) *Other optional ingredients.* (i) Coloring.

(ii) Calcium chloride in an amount not more than 0.02 percent (calculated as anhydrous calcium chloride) of the weight of the dairy ingredients, used as a coagulation aid.

(iii) Enzymes of animal, plant, or microbial origin used in curing or flavor development.

(iv) Antimycotic agents, the cumulative levels of which shall not exceed current good manufacturing practice, may be added to the surface of the cheese.

(v) Vegetable oil, used as a coating for the rind.

(c) *Nomenclature.* The name of the food is "muenster cheese" or, alternatively, "munster cheese".

(d) *Label declaration.* Each of the ingredients used in the food shall be declared on the label as required by the applicable sections of parts 101 and 130 of this chapter, except that:

(1) Enzymes of animal, plant, or microbial origin may be declared as "enzymes"; and

(2) The dairy ingredients may be declared, in descending order of predominance, by the use of the terms "milkfat and nonfat milk" or "nonfat milk and milkfat", as appropriate.

[54 FR 32057, Aug. 4, 1989; 54 FR 35756, Aug. 29, 1989, as amended at 58 FR 2894, Jan. 6, 1993]

§ 133.161 Muenster and munster cheese for manufacturing.

Muenster cheese for manufacturing conforms to the definition and standard of identity for muenster cheese prescribed by §133.160, except that the dairy ingredients are not pasteurized.

[54 FR 32057, Aug. 4, 1989]

§ 133.162 Neufchatel cheese.

(a) *Description.* (1) Neufchatel cheese is the soft uncured cheese prepared by the procedure set forth in paragraph (a)(2) of this section or by any other procedure which produces a finished cheese having the same physical and chemical properties. The milkfat content is not less than 20 percent but less than 33 percent by weight of the finished food and the maximum moisture content is 65 percent by weight, as determined by the methods described in §133.5. The dairy ingredients used are pasteurized.

(2) One or more of the dairy ingredients specified in paragraph (b)(1) of this section is subjected to the action of a harmless lactic acid-producing bacterial culture, with or without one or more of the clotting enzymes specified in paragraph (b)(2) of this section. The mixture is held until the dairy ingredients coagulate. The coagulated mass may be warmed and stirred and it is drained. The moisture content may be adjusted with one of the optional ingredients in paragraph (b)(3)(ii) of this section. The curd may be pressed, chilled, worked, and heated until it becomes fluid. It may then be homogenized or otherwise mixed. One or more of the dairy ingredients specified in paragraph (b)(1) of this section or the other optional ingredients specified in paragraph (b)(3) of this section may be added during the procedure.

(b) *Optional ingredients.* The following safe and suitable ingredients may be used:

(1) *Dairy ingredients.* Milk, nonfat milk, or cream, as defined in §133.3.

(2) *Clotting enzymes.* Rennet and/or other clotting enzymes of animal, plant, or microbial origin.

(3) *Other optional ingredients.* (i) Salt.

(ii) Cheese whey, concentrated cheese whey, dried cheese whey, or reconstituted cheese whey prepared by addition of water to concentrated cheese whey or dried cheese whey.

(iii) Stabilizers, in a total amount not to exceed 0.5 percent of the weight of the finished food, with or without the addition of dioctyl sodium sulfosuccinate in a maximum amount of 0.5 percent of the weight of the stabilizer(s) used.

(c) *Nomenclature.* The name of the food is "neufchatel cheese".

(d) *Label declaration.* Each of the ingredients used in the food shall be declared on the label as required by the applicable sections of parts 101 and 130 of this chapter, except that:

(1) Enzymes of animal, plant, or microbial origin may be declared as "enzymes"; and

(2) The dairy ingredients may be declared, in descending order of predominance, by use of the terms "milkfat

§ 133.164

and nonfat milk” or “nonfat milk and milkfat”, as appropriate.

[54 FR 32057, Aug. 4, 1989, as amended at 58 FR 2894, Jan. 6, 1993]

§ 133.164 Nuworld cheese.

(a) *Description.* (1) Nuworld cheese is the food prepared by the procedure set forth in paragraph (a)(2) of this section or by any other procedure which produces a finished cheese having the same physical and chemical properties. It is characterized by the presence of creamy-white mold, a white mutant of *Penicillium roquefortii*, throughout the cheese. The minimum milkfat content is 50 percent by weight of the solids and the maximum moisture content is 46 percent by weight, as determined by the methods described in §133.5. The dairy ingredients used may be pasteurized. Nuworld cheese is at least 60 days old.

(2) One or more of the dairy ingredients specified in paragraph (b)(1) of this section may be warmed and is subjected to the action of a lactic acid-producing bacterial culture. One or more of the clotting enzymes specified in paragraph (b)(2) of this section is added to set the dairy ingredients to a semisolid mass. The mass is cut into smaller portions and allowed to stand for a time. The mixed curd and whey is placed into forms permitting further drainage. While being placed in forms, spores of a white mutant of the mold *Penicillium roquefortii* are added. The forms are turned several times during drainage. When sufficiently drained, the shaped curd is removed from the forms and salted with dry salt or brine. Perforations are then made in the shaped curd and it is held at a temperature of approximately 50 °F at 90 to 95 percent relative humidity, until the characteristic mold growth has developed. During storage, the surface of the cheese may be scraped to remove surface growth of undesirable microorganisms. One or more of the other optional ingredients specified in paragraph (b)(3) of this section may be added during the procedure.

(b) *Optional ingredients.* The following safe and suitable ingredients may be used:

21 CFR Ch. I (4–1–07 Edition)

(1) *Dairy ingredients.* Milk, nonfat milk, or cream, as defined in §133.3, used alone or in combination.

(2) *Clotting enzymes.* Rennet and/or other clotting enzymes of animal, plant, or microbial origin.

(3) *Other optional ingredients.* (i) Blue or green color in an amount to neutralize the natural yellow color of the curd.

(ii) Calcium chloride in an amount not more than 0.02 percent (calculated as anhydrous calcium chloride) of the weight of the dairy ingredients, used as a coagulation aid.

(iii) Enzymes of animal, plant, or microbial origin, used in curing or flavor development.

(c) *Nomenclature.* The name of the food is “nuworld cheese”.

(d) *Label declaration.* Each of the ingredients used in the food shall be declared on the label as required by the applicable sections of parts 101 and 130 of this chapter, except that:

(1) Enzymes of animal, plant, or microbial origin may be declared as “enzymes”; and

(2) The dairy ingredients may be declared, in descending order of predominance, by the use of the terms “milkfat and nonfat milk” or “nonfat milk and milkfat”, as appropriate.

[54 FR 32058, Aug. 4, 1989, as amended at 58 FR 2894, Jan. 6, 1993]

§ 133.165 Parmesan and reggiano cheese.

(a) Parmesan cheese, reggiano cheese, is the food prepared from milk and other ingredients specified in this section, by the procedure set forth in paragraph (b) of this section, or by another procedure which produces a finished cheese having the same physical and chemical properties as the cheese produced when the procedure set forth in paragraph (b) of this section is used. It is characterized by a granular texture and a hard and brittle rind. It grates readily. It contains not more than 32 percent of moisture, and its solids contain not less than 32 percent of milkfat, as determined by the methods prescribed in §133.5 (a), (b), and (d). It is cured for not less than 10 months.

(b) Milk, which may be pasteurized or clarified or both, and which may be warmed, is subjected to the action of

harmless lactic-acid-producing bacteria, present in such milk or added thereto. Sufficient rennet, or other safe and suitable milk-clotting enzyme that produces equivalent curd formation, or both, with or without purified calcium chloride in a quantity not more than 0.02 percent (calculated as anhydrous calcium chloride) of the weight of the milk, is added to set the milk to a semisolid mass. Harmless artificial coloring may be added. The mass is cut into pieces no larger than wheat kernels, heated, and stirred until the temperature reaches between 115 °F and 125 °F. The curd is allowed to settle and is then removed from the kettle or vat, drained for a short time, placed in hoops, and pressed. The pressed curd is removed and salted in brine, or dry-salted. The cheese is cured in a cool, ventilated room. The rind of the cheese may be coated or colored. A harmless preparation of enzymes of animal or plant origin capable of aiding in the curing or development of flavor of parmesan cheese may be added during the procedure, in such quantity that the weight of the solids of such preparation is not more than 0.1 percent of the weight of the milk used.

(c)(1) For the purposes of this section, the word "milk" means cow's milk, which may be adjusted by separating part of the fat therefrom or by adding thereto one or more of the following: Cream, skim milk, concentrated skim milk, nonfat dry milk, water in a quantity sufficient to reconstitute any concentrated skim milk or nonfat dry milk used.

(2) Such milk may be bleached by the use of benzoyl peroxide or a mixture of benzoyl peroxide with potassium alum, calcium sulfate, and magnesium carbonate; but the weight of the benzoyl peroxide is not more than 0.002 percent of the weight of the milk bleached, and the weight of the potassium alum, calcium sulfate, and magnesium carbonate, singly or combined, is not more than six times the weight of the benzoyl peroxide used. If milk is bleached in this manner, sufficient vitamin A is added to the curd to compensate for the vitamin A or its precursors destroyed in the bleaching process, and artificial coloring is not used.

(d) Safe and suitable antimycotic agent(s), the cumulative levels of which shall not exceed current good manufacturing practice may be added to the surface of the cheese.

(e) Label declaration: Each of the ingredients used in the food shall be declared on the label as required by the applicable sections of parts 101 and 130 of this chapter, except that enzymes of animal, plant, or microbial origin may be declared as "enzymes".

[42 FR 14366, Mar. 15, 1977, as amended at 48 FR 49014, Oct. 24, 1983; 49 FR 10095, Mar. 19, 1984; 58 FR 2894, Jan. 6, 1993]

§ 133.167 Pasteurized blended cheese.

Pasteurized blended cheese conforms to the definition and standard of identity, and is subject to the requirements for label statement of ingredients, prescribed for pasteurized process cheese by § 133.169, except that:

(a) In mixtures of two or more cheeses, cream cheese or neufchatel cheese may be used.

(b) None of the ingredients prescribed or permitted for pasteurized process cheese by § 133.169 (c) and (d)(1) is used.

(c) In case of mixtures of two or more cheeses containing cream cheese or neufchatel cheese, the moisture content is not more than the arithmetical average of the maximum moisture contents prescribed by the definitions and standards of identity for the varieties of cheeses blended, for which such limits have been prescribed.

(d) The word "process" is replaced by the word "blended" in the name prescribed by § 133.169(e).

[42 FR 14366, Mar. 15, 1977, as amended at 58 FR 2894, Jan. 6, 1993]

§ 133.168 Pasteurized blended cheese with fruits, vegetables, or meats.

(a) Pasteurized blended cheese with fruits, vegetables, or meats, or mixtures of these is the food which conforms to the definition and standard of identity, and is subject to the requirements for label statement of ingredients, prescribed for pasteurized blended cheese by § 133.167, except that:

(1) Its moisture content may be 1 percent more, and the milk fat content of its solids may be 1 percent less, than the limits prescribed by § 133.167 for

§ 133.169

21 CFR Ch. I (4-1-07 Edition)

moisture and milk fat in the corresponding pasteurized blended cheese.

(2) It contains one or any mixture of two or more of the following: Any properly prepared cooked, canned, or dried fruit; any properly prepared cooked, canned, or dried vegetable; any properly prepared cooked or canned meat.

(3) When the added fruits, vegetables, or meats contain fat, the method prescribed for the determination of fat by § 133.5(b) is not applicable.

(b) The name of a pasteurized blended cheese with fruits, vegetables, or meats is the name prescribed by § 133.167 for the applicable pasteurized blended cheese, followed by the term "with _____", the blank being filled in with the common or usual name or names of the fruits, vegetables, or meats used, in order of predominance by weight.

[42 FR 14366, Mar. 15, 1977, as amended at 49 FR 10095, Mar. 19, 1977; 58 FR 2894, Jan. 6, 1993]

§ 133.169 Pasteurized process cheese.

(a)(1) Pasteurized process cheese is the food prepared by comminuting and mixing, with the aid of heat, one or more cheeses of the same or two or more varieties, except cream cheese, neufchatel cheese, cottage cheese, lowfat cottage cheese, cottage cheese dry curd, cook cheese, hard grating cheese, semisoft part-skim cheese, part-skim spiced cheese, and skim milk cheese for manufacturing with an emulsifying agent prescribed by paragraph (c) of this section into a homogeneous plastic mass. One or more of the optional ingredients designated in paragraph (d) of this section may be used.

(2) During its preparation, pasteurized process cheese is heated for not less than 30 seconds at a temperature of not less than 150 °F. When tested for phosphatase by the method prescribed in § 133.5(c), the phenol equivalent of 0.25 gram of pasteurized process cheese is not more than 3 micrograms.

(3)(i) The moisture content of a pasteurized process cheese made from a single variety of cheese is not more than 1 percent greater than the maximum moisture content prescribed by the definition and standard of identity, if any there be, for the variety of cheese used; but in no case is more

than 43 percent, except that the moisture content of pasteurized process washed curd cheese or pasteurized process colby cheese is not more than 40 percent; the moisture content of pasteurized process swiss cheese or pasteurized process gruyere cheese is not more than 44 percent; and the moisture content of pasteurized process limburger cheese is not more than 51 percent.

(ii) The fat content of the solids of a pasteurized process cheese made from a single variety of cheese is not less than the minimum prescribed by the definition and standard of identity, if any there be, for the variety of cheese used, but in no case is less than 47 percent; except that the fat content of the solids of pasteurized process swiss cheese is not less than 43 percent, and the fat content of the solids of pasteurized process gruyere cheese is not less than 45 percent.

(4)(i) The moisture content of a pasteurized process cheese made from two or more varieties of cheese is not more than 1 percent greater than the arithmetical average of the maximum moisture contents prescribed by the definitions and standards of identity, if any there be, for the varieties of cheese used; but in no case is the moisture content more than 43 percent, except that the moisture content of a pasteurized process cheese made from two or more of the varieties cheddar cheese, washed curd cheese, colby cheese, and granular cheese is not more than 40 percent, and the moisture content of a mixture of swiss cheese and gruyere cheese is not more than 44 percent.

(ii) The fat content of the solids of a pasteurized process cheese made from two or more varieties of cheese is not less than the arithmetical average of the minimum fat contents prescribed by the definitions and standards of identity, if any there be, for the varieties of cheese used, but in no case is less than 47 percent, except that the fat content of the solids of a pasteurized process gruyere cheese made from a mixture of swiss cheese and gruyere cheese is not less than 45 percent.

(5) Moisture and fat are determined by the methods prescribed in § 133.5(a), (b), and (d).

(6) The weight of each variety of cheese in a pasteurized process cheese made from two varieties of cheese is not less than 25 percent of the total weight of both, except that the weight of blue cheese, nuworld cheese, roquefort cheese, or gorgonzola cheese is not less than 10 percent of the total weight of both, and the weight of limburger cheese is not less than 5 percent of the total weight of both. The weight of each variety of cheese in a pasteurized process cheese made from three or more varieties of cheese is not less than 15 percent of the total weight of all, except that the weight of blue cheese, nuworld cheese, roquefort cheese, or gorgonzola cheese is not less than 5 percent of the total weight of all, and the weight of limburger cheese is not less than 3 percent of the total weight of all. These limits do not apply to the quantity of cheddar cheese, washed curd cheese, colby cheese and granular cheese in mixtures which are designated as "American cheese" as prescribed in paragraph (e)(2)(ii) of this section. Such mixtures are considered as one variety of cheese for the purposes of this paragraph (a)(6).

(7) For the purposes of this section, cheddar cheese for manufacturing, washed curd cheese for manufacturing, colby cheese for manufacturing, granular cheese for manufacturing, brick cheese for manufacturing, muenster cheese for manufacturing, and swiss cheese for manufacturing are considered as cheddar cheese, washed curd cheese, colby cheese, granular cheese, brick cheese, muenster cheese, and swiss cheese, respectively.

(b) Pasteurized process cheese may be smoked, or the cheese or cheeses from which it is made may be smoked, before comminuting and mixing, or it may contain substances prepared by condensing or precipitating wood smoke.

(c) The emulsifying agent referred to in paragraph (a) of this section is one or any mixture of two or more of the following: Monosodium phosphate, disodium phosphate, dipotassium phosphate, trisodium phosphate, sodium metaphosphate (sodium hexametaphosphate), sodium acid pyrophosphate, tetrasodium pyrophosphate, sodium aluminum

phosphate, sodium citrate, potassium citrate, calcium citrate, sodium tartrate, and sodium potassium tartrate, in such quantity that the weight of the solids of such emulsifying agent is not more than 3 percent of the weight of the pasteurized process cheese.

(d) The optional ingredients referred to in paragraph (a) of this section are:

(1) An acidifying agent consisting of one or any mixture of two or more of the following: A vinegar, lactic acid, citric acid, acetic acid, and phosphoric acid, in such quantity that the pH of the pasteurized process cheese is not below 5.3.

(2) Cream, anhydrous milkfat, dehydrated cream, or any combination of two or more of these, in such quantity that the weight of the fat derived therefrom is less than 5 percent of the weight of the pasteurized process cheese.

(3) Water.

(4) Salt.

(5) Harmless artificial coloring.

(6) Spices or flavorings, other than any which singly or in combination with other ingredients simulate the flavor of a cheese of any age or variety.

(7) Pasteurized process cheese in the form of slices or cuts in consumer-sized packages may contain an optional mold-inhibiting ingredient consisting of not more than 0.2 percent by weight of sorbic acid, potassium sorbate, sodium sorbate, or any combination of two or more of these, or consisting of not more than 0.3 percent by weight of sodium propionate, calcium propionate, or a combination of sodium propionate and calcium propionate.

(8) Pasteurized process cheese in the form of slices or cuts in consumer-sized packages may contain lecithin as an optional anti-sticking agent in an amount not to exceed 0.03 percent by weight of the finished product.

(9) Safe and suitable enzyme modified cheese.

(e) The name of a pasteurized process cheese for which a definition and standard of identity is prescribed by this section is as follows:

(1) In case it is made from a single variety of cheese, its name is "Pasteurized process _____ cheese", the blank being filled in with the name of the variety of cheese used.

§ 133.170

21 CFR Ch. I (4-1-07 Edition)

(2) In case it is made from two or more varieties of cheese, its name is "Pasteurized process _____ and _____ cheese", or "Pasteurized process _____ blended with _____ cheese", or "Pasteurized process blend of _____ and _____ cheese", the blanks being filled in with the names of the varieties of cheeses used, in order of predominance by weight; except that:

(i) In case it is made from gruyere cheese and swiss cheese, and the weight of gruyere cheese is not less than 25 percent of the weight of both, it may be designated "Pasteurized process gruyere cheese"; and

(ii) In case it is made of cheddar cheese, washed curd cheese, colby cheese, or granular cheese or any mixture of two or more of these, it may be designated "Pasteurized process American cheese"; or when cheddar cheese, washed curd cheese, colby cheese, granular cheese, or any mixture of two or more of these is combined with other varieties of cheese in the cheese ingredient, any of such cheeses or such mixture may be designated as "American cheese".

The full name of the food shall appear on the principal display panel of the label in type of uniform size, style, and color. Wherever any word or statement emphasizing the name of any ingredient appears on the label (other than in an ingredient statement as specified in paragraph (g) of this section) so conspicuously as to be easily seen under customary conditions of purchase, the full name of the food shall immediately and conspicuously precede or follow such word or statement in type of at least the same size as the type used in such word or statement.

(f) The name of the food shall include a declaration of any flavoring, including smoke and substances prepared by condensing or precipitating wood smoke, that characterizes the product as specified in §101.22 of this chapter and a declaration of any spice that characterizes the product.

(g) Each of the ingredients used in the food shall be declared on the label as required by the applicable sections of parts 101 and 130 of this chapter, except that cheddar cheese, washed curd cheese, colby cheese, granular cheese, or any mixture of two or more of these

may be designated as "American cheese".

[42 FR 14366, Mar. 15, 1977, as amended at 49 FR 10095, Mar. 19, 1984; 58 FR 2894, Jan. 6, 1993]

§ 133.170 Pasteurized process cheese with fruits, vegetables, or meats.

(a) Unless a definition and standard of identity specifically applicable is established by another section of this part, a pasteurized process cheese with fruits, vegetables, or meats, or mixtures of these is a food which conforms to the definition and standard of identity, and is subject to the requirements for label statement of ingredients, prescribed for pasteurized process cheese by §133.169, except that:

(1) Its moisture content may be 1 percent more, and the milk fat content of its solids may be 1 percent less than the limits prescribed by §133.169 for moisture and fat in the corresponding pasteurized process cheese.

(2) It contains one or any mixture of two or more of the following: Any properly prepared cooked, canned, or dried fruit; any properly prepared cooked, canned, or dried vegetable; any properly prepared cooked or canned meat.

(3) When the added fruits, vegetables, or meats contain fat, the method prescribed for the determination of fat by §133.5(b) is not applicable.

(b) The name of a pasteurized process cheese with fruits, vegetables, or meats is the name prescribed by §133.169 for the applicable pasteurized process cheese, followed by the term "with _____", the blank being filled in with the common or usual name or names of the fruits, vegetables, or meats used, in order of predominance by weight.

[42 FR 14366, Mar. 15, 1977, as amended at 49 FR 10095, Mar. 19, 1984; 58 FR 2894, Jan. 6, 1993]

§ 133.171 Pasteurized process pimento cheese.

Pasteurized process pimento cheese is the food which conforms to the definition and standard of identity for pasteurized process cheese with fruits, vegetables, or meats, and is subject to the requirement for label statement of ingredients, except that:

(a) Its moisture content is not more than 41 percent, and the fat content of its solids is not less than 49 percent.

(b) The cheese ingredient is cheddar cheese, washed curd cheese, colby cheese, granular cheese or any mixture of two or more of these in any proportion.

(c) For the purposes of this section, cheddar cheese for manufacturing, washed curd cheese for manufacturing, colby cheese for manufacturing, and granular cheese for manufacturing shall be considered as cheddar cheese, washed curd cheese, colby cheese, and granular cheese, respectively.

(d) The only fruit, vegetable, or meat ingredient is pimentos in such quantity that the weight of the solids thereof is not less than 0.2 percent of the weight of the finished pasteurized process pimento cheese.

(e) The optional ingredients designated in § 133.169(b) and (d)(6) are not used.

[42 FR 14366, Mar. 15, 1977, as amended at 58 FR 2894, Jan. 6, 1993]

§ 133.173 Pasteurized process cheese food.

(a)(1) A pasteurized process cheese food is the food prepared by comminuting and mixing, with the aid of heat, one or more of the optional cheese ingredients prescribed in paragraph (c) of this section, with one or more of the optional dairy ingredients prescribed in paragraph (d) of this section, into a homogeneous plastic mass. One or more of the optional ingredients specified in paragraph (e) of this section may be used.

(2) During its preparation, a pasteurized process cheese food is heated for not less than 30 seconds, at a temperature of not less than 150 °F. When tested for phosphatase by the method prescribed in § 133.5(c), the phenol equivalent of 0.25 gram of pasteurized process cheese food is not more than 3 micrograms.

(3) The moisture content of a pasteurized process cheese food is not more than 44 percent, and the fat content is not less than 23 percent.

(4) Moisture and fat are determined by the methods prescribed in § 133.5(a) and (b), except that in determining moisture the loss in weight which oc-

curs in drying for 5 hours, under the conditions prescribed in such method, is taken as the weight of the moisture.

(5) The weight of the cheese ingredient prescribed by paragraph (a)(1) of this section constitutes not less than 51 percent of the weight of the finished pasteurized process cheese food.

(6) The weight of each variety of cheese in a pasteurized process cheese food made with two varieties of cheese is not less than 25 percent of the total weight of both, except that the weight of blue cheese, nuworld cheese, roquefort cheese, gorgonzola cheese, or limburger cheese is not less than 10 percent of the total weight of both. The weight of each variety of cheese in a pasteurized process cheese food made with three or more varieties of cheese is not less than 15 percent of the total weight of all, except that the weight of blue cheese, nuworld cheese, roquefort cheese, gorgonzola cheese, or limburger cheese is not less than 5 percent of the total weight of all. These limits do not apply to the quantity of cheddar cheese, washed curd cheese, colby cheese, and granular cheese in mixtures which are designated as "American cheese" as prescribed in paragraph (h)(5) of this section. Such mixtures are considered as one variety of cheese for the purposes of this subparagraph.

(7) For the purposes of this section, cheddar cheese for manufacturing, washed curd cheese for manufacturing, colby cheese for manufacturing, granular cheese for manufacturing, brick cheese for manufacturing, muenster cheese for manufacturing, and swiss cheese for manufacturing are considered as cheddar cheese, washed curd cheese, colby cheese, granular cheese, brick cheese, muenster cheese, and swiss cheese, respectively.

(b) Pasteurized process cheese food may be smoked, or the cheese or cheeses from which it is made may be smoked, before comminuting and mixing, or it may contain substances prepared by condensing or precipitating wood smoke.

(c) The optional cheese ingredients referred to in paragraph (a) of this section are one or more cheeses of the same or two or more varieties, except cream cheese, neufchatel cheese, cottage cheese, creamed cottage cheese,

cook cheese, and skim-milk cheese for manufacturing, and except that hard grating cheese, semisoft part skim cheese, and part-skim spiced cheese are not used alone or in combination with each other as the cheese ingredient.

(d) The optional dairy ingredients referred to in paragraph (a) of this section are cream, milk, skim milk, buttermilk, cheese whey, any of the foregoing from which part of the water has been removed, anhydrous milkfat, dehydrated cream, albumin from cheese whey, and skim milk cheese for manufacturing.

(e) The other optional ingredients referred to in paragraph (a) of this section are:

(1) An emulsifying agent consisting of one or any mixture of two or more of the following: Monosodium phosphate, disodium phosphate, dipotassium phosphate, trisodium phosphate, sodium metaphosphate (sodium hexametaphosphate), sodium acid pyrophosphate, tetrasodium pyrophosphate, sodium aluminum phosphate, sodium citrate, potassium citrate, calcium citrate, sodium tartrate, and sodium potassium tartrate, in such quantity that the weight of the solids of such emulsifying agent is not more than 3 percent of the weight of the pasteurized process cheese food.

(2) An acidifying agent consisting of one or any mixture of two or more of the following: A vinegar, lactic acid, citric acid, acetic acid, and phosphoric acid in such quantity that the pH of the pasteurized process cheese food is not below 5.0.

(3) Water.

(4) Salt.

(5) Harmless artificial coloring.

(6) Spices or flavorings other than any which singly or in combination with other ingredients simulate the flavor of cheese of any age or variety.

(7) Pasteurized process cheese food in the form of slices or cuts in consumer-sized packages may contain an optional mold-inhibiting ingredient consisting of not more than 0.2 percent by weight of sorbic acid, potassium sorbate, sodium sorbate, or any combination of two or more of these, or consisting of not more than 0.3 percent by weight of sodium propionate, calcium

propionate, or a combination of sodium propionate and calcium propionate.

(8) Pasteurized process cheese food in the form of slices or cuts in consumer-sized packages may contain lecithin as an optional anti-sticking agent in an amount not to exceed 0.03 percent by weight of the finished product.

(9) Safe and suitable enzyme modified cheese.

(f) The name of the food is "Pasteurized process cheese food". The full name of the food shall appear on the principal display panel of the label in type of uniform size, style, and color. Wherever any word or statement emphasizing the name of any ingredient appears on the label (other than in an ingredient statement as specified in paragraph (h) of this section) so conspicuously as to be easily seen under customary conditions of purchase, the full name of the food shall immediately and conspicuously precede or follow such word or statement in type of at least the same size as the type used in such word or statement.

(g) The name of the food shall include a declaration of any flavoring, including smoke and substances prepared by condensing or precipitating wood smoke, that characterizes the product as specified in §101.22 of this chapter and a declaration of any spice that characterizes the product.

(h) Each of the ingredients used in the food shall be declared on the label as required by the applicable sections of parts 101 and 130 of this chapter, except that cheddar cheese, washed curd cheese, colby cheese, granular cheese, or any mixture of two or more of these may be designated as "American cheese".

[42 FR 14366, Mar. 15, 1977, as amended at 49 FR 10095, Mar. 19, 1984; 58 FR 2894, Jan. 6, 1993]

§ 133.174 Pasteurized process cheese food with fruits, vegetables, or meats.

(a) Pasteurized process cheese food with fruits, vegetables, or meats, or mixtures of these is the food which conforms to the definition and standard of identity, and is subject to the requirements for label statement of ingredients, prescribed for pasteurized

process cheese food by §133.173, except that:

(1) Its milk fat content is not less than 22 percent.

(2) It contains one or any mixture of two or more of the following: Any properly prepared cooked, canned, or dried fruit; any properly prepared cooked, canned, or dried vegetable; any properly prepared cooked or canned meat.

(3) When the added fruits, vegetables, or meats contain fat, the method prescribed for the determination of fat by §133.5(b) is not applicable.

(b) The name of a pasteurized process cheese food with fruits, vegetables, or meats is "Pasteurized process cheese food with _____", the blank being filled in with the common or usual name or names of the fruits, vegetables, or meats used, in order of predominance by weight.

(c) If the only vegetable ingredient is pimento, and no meat or fruit ingredient is used, the weight of the solids of such pimentos is not less than 0.2 percent of the weight of the finished food. The name of this food is "Pimento pasteurized process cheese food" or "Pasteurized process pimento cheese food".

[42 FR 14366, Mar. 15, 1977, as amended at 49 FR 10095, Mar. 19, 1984; 58 FR 2894, Jan. 6, 1993]

§ 133.175 Pasteurized cheese spread.

Pasteurized cheese spread is the food which conforms to the definition and standard of identity, and is subject to the requirements for label statement of ingredients, prescribed for pasteurized process cheese spread by §133.179, except that no emulsifying agent as prescribed by §133.179(e) is used.

[58 FR 2894, Jan. 6, 1993]

§ 133.176 Pasteurized cheese spread with fruits, vegetables, or meats.

(a) Pasteurized cheese spread with fruits, vegetables, or meats, or mixtures of these is a food which conforms to the definition and standard of identity, and is subject to the requirements for label statement of ingredients, prescribed for pasteurized cheese spread by §133.175, except that:

(1) It contains one or any mixture of two or more of the following: Any prop-

erly prepared cooked, canned, or dried fruit; any properly prepared cooked, canned, or dried vegetable; any properly prepared cooked or canned meat.

(2) When the added fruits, vegetables, or meats contain fat, the method prescribed for the determination of fat by §133.5(b) is not applicable.

(b) The name of a pasteurized cheese spread with fruits, vegetables, or meats is "Pasteurized cheese spread with _____", the blank being filled in with the name or names of the fruits, vegetables, or meats used, in order of predominance by weight.

[42 FR 14366, Mar. 15, 1977, as amended at 49 FR 10095, Mar. 19, 1984; 58 FR 2894, Jan. 6, 1993]

§ 133.178 Pasteurized neufchatel cheese spread with other foods.

(a)(1) Pasteurized neufchatel cheese spread with other foods is the class of foods each of which is prepared by mixing, with the aid of heat, neufchatel cheese with one or a mixture of two or more properly prepared foods (except other cheeses), such as fresh, cooked, canned, or dried fruits or vegetables; cooked or canned meats; relishes, pickles or other foods suitable for blending with neufchatel cheese. It may contain one or any mixture of two or more of the optional ingredients named in paragraph (b) of this section. The amount of the added food or foods must be sufficient to so differentiate the blend that it does not simulate neufchatel cheese. It is spreadable at 70 °F.

(2) During its preparation the mixture is heated for not less than 30 seconds at a temperature of not less than 150 °F. When tested for phosphatase by the method prescribed in §133.5(c), the phenol equivalent of 0.25 gram of such food is not more than 3 micrograms.

(3)(i) No water other than that contained in the ingredients used is added to this food, but the moisture content in no case is more than 65 percent.

(ii) The milk fat is not less than 20 percent by weight of the finished food.

(b) The optional ingredients referred to in paragraph (a) of this section are:

(1)(i) One or any mixture of two or more of the following: Gum karaya, gum tragacanth, carob bean gum, gelatin, algin (sodium alginate), propylene glycol alginate, guar gum, sodium

§ 133.179

21 CFR Ch. I (4-1-07 Edition)

carboxymethylcellulose (cellulose gum), carrageenan, oat gum, or xanthan gum. The total quantity of any such substances, including that contained in the neufchatel cheese, is not more than 0.8 percent by weight of the finished food.

(ii) When one or more of the optional ingredients in paragraph (b)(1)(i) of this section are used, dioctyl sodium sulfosuccinate complying with the requirements of §172.810 of this chapter may be used in a quantity not in excess of 0.5 percent by weight of such ingredients.

(2) Artificial coloring, unless such addition conceals damage or inferiority or makes the finished food appear better or of greater value than it is.

(3) An acidifying agent consisting of one or a mixture of two or more of the following: A vinegar, acetic acid, lactic acid, citric acid, phosphoric acid.

(4) A sweetening agent consisting of one or a mixture of two or more of the following: Sugar, dextrose, corn sirup, corn sirup solids, glucose sirup, glucose sirup solids, maltose, malt sirup, hydrolyzed lactose.

(5) Cream, milk, skim milk, butter-milk, cheese whey, any of the foregoing from which part of the water has been removed, anhydrous milkfat, dehydrated cream, and albumin from cheese whey.

(c) The name of the food is "pasteurized Neufchatel cheese spread with _____" or "pasteurized Neufchatel cheese spread and _____", the blank being filled in with the common names of the foods added, in order of predominance by weight. The full name of the food shall appear on the principal display panel of the label in type of uniform size, style, and color. Wherever any word or statement emphasizing the name of any ingredient appears on the label (other than in an ingredient statement as specified in paragraph (d) of this section) so conspicuously as to be easily seen under customary conditions of purchase, the full name of the food shall immediately and conspicuously precede or follow such word or statement in type of at least the same size as the type used in such word or statement.

(d) Each of the ingredients used in the food shall be declared on the label

as required by the applicable sections of parts 101 and 130 of this chapter.

[42 FR 14366, Mar. 15, 1977, as amended at 49 FR 10095, Mar. 19, 1984; 58 FR 2894, Jan. 6, 1993]

§ 133.179 Pasteurized process cheese spread.

(a)(1) Pasteurized process cheese spread is the food prepared by comminuting and mixing, with the aid of heat, one or more of the optional cheese ingredients prescribed in paragraph (c) of this section, with or without one or more of the optional dairy ingredients prescribed in paragraph (d) of this section, with one or more of the emulsifying agents prescribed in paragraph (e) of this section, and with or without one or more of the optional ingredients prescribed by paragraph (f) of this section, into a homogeneous plastic mass, which is spreadable at 70 °F.

(2) During its preparation, a pasteurized process cheese spread is heated for not less than 30 seconds at a temperature of not less than 150 °F. When tested for phosphatase by the method prescribed in §133.5(c), the phenol equivalent of 0.25 gram of pasteurized process cheese spread is not more than 3 micrograms.

(3) The moisture content of a pasteurized process cheese spread is more than 44 percent but not more than 60 percent, and the milk fat content is not less than 20 percent.

(4) Moisture and fat are determined by the methods prescribed in §133.5(a) and (b), except that in determining moisture the loss in weight which occurs in drying for 5 hours, under the conditions prescribed in such method, is taken as the weight of the moisture.

(5) The weight of the cheese ingredient referred to in paragraph (a)(1) of this section constitutes not less than 51 percent of the weight of the pasteurized process cheese spread.

(6) The weight of each variety of cheese in a pasteurized process cheese spread made with two varieties of cheese is not less than 25 percent of the total weight of both, except that the weight of blue cheese, nuworld cheese, roquefort cheese, gorgonzola cheese, or limburger cheese is not less than 10 percent of the total weight of both. The weight of each variety of cheese in a

pasteurized process cheese spread made with three or more varieties of cheese is not less than 15 percent of the total weight of all, except that the weight of blue cheese, nuworld cheese, roquefort cheese, gorgonzola cheese, or limburger cheese is not less than 5 percent of the total weight of all. These limits do not apply to the quantity of cheddar cheese, washed curd cheese, colby cheese, and granular cheese in mixtures which are designated as "American cheese" as prescribed in paragraph (i)(5) of this section. Such mixtures are considered as one variety of cheese for the purposes of this paragraph (a)(6).

(7) For the purposes of this section, cheddar cheese for manufacturing, washed curd cheese for manufacturing, colby cheese for manufacturing, granular cheese for manufacturing, brick cheese for manufacturing, muenster cheese for manufacturing, and swiss cheese for manufacturing are considered as cheddar cheese, washed curd cheese, colby cheese, granular cheese, brick cheese, muenster cheese, and swiss cheese, respectively.

(b) Pasteurized process cheese spread may be smoked, or the cheese or cheeses from which it is made may be smoked, before comminuting and mixing, or it may contain substances prepared by condensing or precipitating wood smoke.

(c) The optional cheese ingredients referred to in paragraph (a) of this section are one or more cheeses of the same or two or more varieties, except that skim-milk cheese for manufacturing may not be used, and except that cream cheese, neufchatel cheese, cottage cheese, creamed cottage cheese, cook cheese, hard grating cheese, semisoft part-skim cheese, and part-skim spiced cheese are not used, alone or in combination with each other, as the cheese ingredient.

(d) The optional dairy ingredients referred to in paragraph (a) of this section are cream, milk, skim milk, buttermilk, cheese whey, any of the foregoing from which part of the water has been removed, anhydrous milkfat, dehydrated cream, albumin from cheese whey, and skim milk cheese for manufacturing.

(e) The emulsifying agents prescribed in paragraph (a) of this section are one

or any mixture of two or more of the following: Monosodium phosphate, disodium phosphate, dipotassium phosphate, trisodium phosphate, sodium metaphosphate (sodium hexametaphosphate), sodium acid pyrophosphate, tetrasodium pyrophosphate, sodium aluminum phosphate, sodium citrate, potassium citrate, calcium citrate, sodium tartrate, and sodium potassium tartrate, in such quantity that the weight of the solids of such emulsifying agent is not more than 3 percent of the weight of the pasteurized process cheese spread.

(f) The other optional ingredients referred to in paragraph (a) of this section are:

(1)(i) One or any mixture of two or more of the following: Carob bean gum, gum karaya, gum tragacanth, guar gum, gelatin, sodium carboxymethylcellulose (cellulose gum), carrageenan, oat gum, algin (sodium alginate), propylene glycol alginate, or xanthan gum. The total weight of such substances is not more than 0.8 percent of the weight of the finished food.

(ii) When one or more of the optional ingredients in paragraph (f)(1)(i) of this section are used, dioctyl sodium sulfosuccinate complying with the requirements of §172.810 of this chapter may be used in a quantity not in excess of 0.5 percent by weight of such ingredients.

(2) An acidifying agent consisting of one or any mixture of two or more of the following: A vinegar, lactic acid, citric acid, acetic acid, and phosphoric acid, in such quantity that the pH of the pasteurized process cheese spread is not below 4.0.

(3) A sweetening agent consisting of one or any mixture of two or more of the following: Sugar, dextrose, corn sugar, corn sirup, corn sirup solids, glucose sirup, glucose sirup solids, maltose, malt sirup, and hydrolyzed lactose, in a quantity necessary for seasoning.

(4) Water.

(5) Salt.

(6) Harmless artificial coloring.

(7) Spices or flavorings other than any which singly or in combination with other ingredients simulates the flavor of a cheese of any age or variety.

§ 133.180

(8) Pasteurized process cheese spread in consumer-sized packages may contain an optional mold-inhibiting ingredient consisting of sorbic acid, potassium sorbate, sodium sorbate, or any combination of two or more of these, in an amount not to exceed 0.2 percent by weight, calculated as sorbic acid or consisting of not more than 0.3 percent by weight of sodium propionate, calcium propionate, or a combination of sodium propionate and calcium propionate.

(9) Pasteurized process cheese spread in consumer-sized packages may contain lecithin as an optional anti-sticking agent in an amount not to exceed 0.03 percent by weight of the finished product.

(10) Safe and suitable enzyme modified cheese.

(11) Nisin preparation in an amount which results in not more than 250 parts per million nisin in the food.

(g) The name of the food is "pasteurized process cheese spread". The full name of the food shall appear on the principal display panel of the label in type of uniform size, style, and color. Wherever any word or statement emphasizing the name of any ingredient appears on the label (other than in an ingredient statement as specified in paragraph (i) of this section) so conspicuously as to be easily seen under customary conditions of purchase, the full name of the food shall immediately and conspicuously precede or follow such word or statement in type of at least the same size as the type used in such word or statement.

(h) The name of the food shall include a declaration of any flavoring, including smoke and substances prepared by condensing or precipitating wood smoke, that characterizes the product as specified in §101.22 of this chapter and a declaration of any spice that characterizes the product.

(i) Each of the ingredients used in the food shall be declared on the label as required by the applicable sections of parts 101 and 130 of this chapter, except that cheddar cheese, washed curd cheese, colby cheese, granular cheese, or any mixture of two or more of these

21 CFR Ch. I (4-1-07 Edition)

may be designated as "American cheese".

[42 FR 14366, Mar. 15, 1977, as amended at 49 FR 10095, Mar. 19, 1984; 54 FR 6121, Feb. 8, 1989; 54 FR 22741, May 26, 1989; 58 FR 2895, Jan. 6, 1993]

§ 133.180 Pasteurized process cheese spread with fruits, vegetables, or meats.

(a) Pasteurized process cheese spread with fruits, vegetables, or meats, or mixtures of these is a food which conforms to the definition and standard of identity, and is subject to the requirements for label statement of ingredients, prescribed for pasteurized process cheese spread by §133.179, except that:

(1) It contains one or any mixture of two or more of the following: Any properly prepared cooked, canned, or dried fruit; any properly prepared cooked, canned, or dried vegetable; any properly prepared cooked or canned meat.

(2) When the added fruits, vegetables, or meats contain fat, the method prescribed for the determination of fat by §133.5(b) is not applicable.

(b) The name of a pasteurized process cheese spread with fruits, vegetables, or meats is "Pasteurized process cheese spread with _____", the blank being filled in with the name or names of the fruits, vegetables, or meats used, in order of predominance by weight.

[42 FR 14366, Mar. 15, 1977, as amended at 49 FR 10095, Mar. 19, 1984; 58 FR 2895, Jan. 6, 1993]

§ 133.181 Provolone cheese.

(a) *Description.* (1) Provolone, a pasta filata or stretched curd-type cheese, is the food prepared by the procedure set forth in paragraph (a)(3) of this section, or by any other method which produces a finished cheese having the same physical and chemical properties. It has a stringy texture. The minimum milkfat content is 45 percent by weight of the solids, as determined by the methods described in §133.5 and the maximum moisture content is 45 percent by weight. If the dairy ingredients used are not pasteurized, the cheese is cured at a temperature of not less than 35 °F for at least 60 days.

(2) If pasteurized dairy ingredients are used, the phenol equivalent value of 0.25 gram of provolone cheese is not

more than 3 micrograms as determined by the method described in § 133.5.

(3) One or more of the dairy ingredients specified in paragraph (b)(1) of this section may be bleached, warmed, and is subjected to the action of a lactic acid-producing bacterial culture. One or more of the clotting enzymes specified in paragraph (b)(2) of this section is added to set the dairy ingredients to a semisolid mass. The mass is cut, stirred, and heated so as to promote and regulate the separation of whey from the curd. The whey is drained off, and the curd is matted and cut, immersed in hot water, and kneaded and stretched until it is smooth and free from lumps. Antimycotics may be added to the curd during the kneading and stretching process. Then it is cut and molded. During the molding the curd is kept sufficiently warm to cause proper sealing of the surface. The molded curd is then firmed by immersion in cold water, salted in brine, and dried. It is given some additional curing. Provolone cheese may be smoked, and one or more of the other optional ingredients specified in paragraph (b)(3) of this section may be added during the procedure.

(b) *Optional ingredients.* The following safe and suitable ingredients may be used:

(1) *Dairy ingredients.* Milk, nonfat milk, or cream, as defined in § 133.3, used alone or in combination.

(2) *Clotting enzymes.* Rennet and/or other clotting enzymes of animal, plant, or microbial origin.

(3) *Other optional ingredients.* (i) Blue or green color in an amount to neutralize the natural yellow color of the curd.

(ii) Calcium chloride in an amount not more than 0.02 percent (calculated as anhydrous calcium chloride) by weight of the dairy ingredients, used as a coagulation aid.

(iii) Enzymes of animal, plant, or microbial origin, used in curing or flavor development.

(iv) Safe and suitable antimicrobial agent(s), the cumulative levels of which shall not exceed current good manufacturing practice, may be added to the cheese during the kneading and stretching process and/or applied to the surface of the cheese.

(v) Benzoyl peroxide or a mixture of benzoyl peroxide with potassium alum, calcium sulfate, and magnesium carbonate used to bleach the dairy ingredients. The weight of the benzoyl peroxide is not more than 0.002 percent of the weight of the milk being bleached, and the weight of the potassium alum, calcium sulfate, and magnesium carbonate, singly or combined, is not more than six times the weight of the benzoyl peroxide used. If milk is bleached in this manner, vitamin A is added to the curd in such quantity as to compensate for the vitamin A or its precursors destroyed in the bleaching process, and artificial coloring is not used.

(c) *Nomenclature.* (1) The name of the food is "provolone cheese". The name of the food may include the common name of the shape of the cheese, such as "salami provolone".

(2) One of the following terms, in letters not less than one-half the height of the letters used in the name of the food, shall accompany the name of the food wherever it appears on the principal display panel or panels:

(i) "Smoked" if the food has been smoked.

(ii) "Not smoked" if the food has not been smoked.

(d) *Label declaration.* Each of the ingredients used in the food shall be declared on the label as required by the applicable sections of parts 101 and 130 of this chapter, except that:

(1) Enzymes of animal, plant, or microbial origin may be declared as "enzymes"; and

(2) The dairy ingredients may be declared, in descending order of predominance, by the use of the terms "milkfat and nonfat milk" or "nonfat milk and milkfat", as appropriate.

[48 FR 2745, Jan. 21, 1983, as amended at 48 FR 49014, Oct. 24, 1983; 58 FR 2895, Jan. 6, 1993]

§ 133.182 Soft ripened cheeses.

(a) The cheeses for which definitions and standards of identity are prescribed by this section are soft ripened cheeses for which specifically applicable definitions and standards of identity are not prescribed by other sections of this part. They are made from milk and other ingredients specified in this section, by the procedure set forth

in paragraph (b) of this section. Their solids contain not less than 50 percent of milkfat, as determined by the methods prescribed in § 133.5(a), (b), and (d). If the milk used is not pasteurized, the cheese so made is cured at a temperature of not less than 35 °F for not less than 60 days.

(b) Milk, which may be pasteurized or clarified or both, and which may be warmed, is subjected to the action of harmless lactic-acid-producing bacteria or other harmless flavor-producing bacteria, present in such milk or added thereto. Sufficient rennet, rennet paste, extract of rennet paste, or other safe and suitable milk-clotting enzyme that produces equivalent curd formation, singly or in any combination (with or without purified calcium chloride in a quantity not more than 0.02 percent, calculated as anhydrous calcium chloride, of the weight of the milk) is added to set the milk to a semisolid mass. Harmless artificial coloring may be added. After coagulation the mass is so treated as to promote and regulate the separation of whey and curd. Such treatment may include one or more of the following: Cutting, stirring, heating, dilution with water or brine. The whey, or part of it, is drained off, and the curd is collected and shaped. It may be placed in forms, and may be pressed. Harmless flavor-producing microorganisms may be added. It is cured under conditions suitable for development of biological curing agents on the surface of the cheese, and the curing is conducted so that the cheese cures from the surface toward the center. Salt may be added during the procedure. A harmless preparation of enzymes of animal or plant origin capable of aiding in the curing or development of flavor of soft ripened cheeses may be added, in such quantity that the weight of the solids of such preparation is not more than 0.1 percent of the weight of the milk used.

(c) For the purposes of this section:

(1) The word "milk" means cow's milk or goat's milk or sheep's milk or mixtures of two or all of these. Such milk may be adjusted by separating part of the fat therefrom or (in the case of cow's milk) by adding one or more of the following: Cream, skim milk, concentrated skim milk, nonfat dry milk;

(in the case of goat's milk) the corresponding products from goat's milk; (in the case of sheep's milk) the corresponding products from sheep's milk; water, in a quantity sufficient to reconstitute any such concentrated or dried products used.

(2) Milk shall be deemed to have been pasteurized if it has been held at a temperature of not less than 143 °F for a period of not less than 30 minutes, or for a time and at a temperature equivalent thereto in phosphatase destruction.

(d) The name of each soft ripened cheese for which a definition and standard of identity is prescribed by this section is "Soft ripened cheese", preceded or followed by:

(1) The specific common or usual name of such soft ripened cheese, if any such name has become generally recognized therefor; or

(2) If no such specific common or usual name has become generally recognized therefor, an arbitrary or fanciful name which is not false or misleading in any particular.

(e) When milk other than cow's milk is used in whole or in part, the name of the cheese includes the statement "made from _____", the blank being filled in with the name or names of the milk used, in order of predominance by weight.

(f) Each of the ingredients used in the food shall be declared on the label as required by the applicable sections of parts 101 and 130 of this chapter.

[42 FR 14366, Mar. 15, 1977, as amended at 49 FR 10095, Mar. 19, 1984; 58 FR 2895, Jan. 6, 1993]

§ 133.183 Romano cheese.

(a) Romano cheese is the food prepared from cow's milk or sheep's milk or goat's milk or mixtures of two or all of these and other ingredients specified in this section, by the procedure set forth in paragraph (b) of this section, or by another procedure which produces a finished cheese having the same physical and chemical properties as the cheese produced when the procedure set forth in paragraph (b) of this section is used. It grates readily, and has a granular texture and a hard and brittle rind. It contains not more than 34 percent of moisture, and its solids

contain not less than 38 percent of milkfat, as determined by the methods prescribed in §133.5(a), (b), and (d). It is cured for not less than 5 months.

(b) Milk, which may be pasteurized or clarified or both, and which may be warmed, is subjected to the action of harmless lactic-acid-producing bacteria present in such milk or added thereto. Harmless artificial blue or green coloring in a quantity which neutralizes any natural yellow coloring in the curd may be added. Rennet, rennet paste, extract of rennet paste, or other safe and suitable milk-clotting enzyme that produces equivalent curd formation, singly or in any combination (with or without purified calcium chloride in a quantity not more than 0.02 percent, calculated as anhydrous calcium chloride, of the weight of the milk) is added to set the milk to be a semisolid mass. The mass is cut into particles no larger than corn kernels, stirred, and heated to a temperature of about 120 °F. The curd is allowed to settle to the bottom of the kettle or vat, and is then removed and drained for a short time, packed in forms or hoops, and pressed. The pressed curd is salted by immersing in brine for about 24 hours and is then removed from the brine and the surface allowed to dry. It is then alternately rubbed with salt and washed at intervals. It may be perforated with needles. It is finally drycured. During curing it is turned and scraped. The surface may be rubbed with vegetable oil. A harmless preparation of enzymes of animal or plant origin capable of aiding in the curing or development of flavor of romano cheese may be added during the procedure, in such quantity that the weight of the solids of such preparation is not more than 0.1 percent of the weight of the milk used.

(c)(1) For the purposes of this section, the word "milk" means cow's milk or goat's milk or sheep's milk or mixtures of two or all of these. Such milk may be adjusted by separating part of the fat therefrom or (in the case of cow's milk) by adding one or more of the following: Cream, skim milk, concentrated skim milk, nonfat dry milk; (in the case of goat's milk) the corresponding products from goat's milk; (in the case of sheep's milk) the cor-

responding products from sheep's milk; water in a quantity sufficient to reconstitute any such concentrated or dried products used.

(2) Such milk may be bleached by the use of benzoyl peroxide or a mixture of benzoyl peroxide with potassium alum, calcium sulfate, and magnesium carbonate; but the weight of the benzoyl peroxide is not more than 0.002 percent of the weight of the milk bleached, and the weight of the potassium alum, calcium, sulfate, and magnesium carbonate, singly or combined, is not more than six times the weight of the benzoyl peroxide used. If milk is bleached in this manner, sufficient vitamin A is added to the curd to compensate for the vitamin A or its precursors destroyed in the bleaching process, and artificial coloring is not used.

(d) Safe and suitable antimycotic agent(s), the cumulative levels of which shall not exceed current good manufacturing practice, may be added to the surface of the cheese.

(e) When romano cheese is made solely from cow's milk, the name of such cheese is "Romano cheese made from cow's milk", and may be preceded by the word "Vaccino" (or "Vacchino"); when made solely from sheep's milk, the name is "Romano cheese made from sheep's milk", and may be preceded by the word "Pecorino"; when made solely from goat's milk, the name is "Romano cheese made from goat's milk", and may be preceded by the word "Caprino"; and when a mixture of two or all of the milks specified in this section is used, the name of the cheese is "Romano cheese made from _____", the blank being filled in with the names of the milks used, in order of predominance by weight.

(f) *Label declaration.* Each of the ingredients used in the food shall be declared on the label as required by the applicable sections of parts 101 and 130 of this chapter, except that:

(1) When milk other than cow's milk is used, in whole or in part, the common or usual name of each such milk ingredient shall be declared in order of predominance by weight; and

§ 133.184

21 CFR Ch. I (4-1-07 Edition)

(2) Enzymes of animal, plant, or microbial origin may be declared as “enzymes”.

[42 FR 14366, Mar. 15, 1977, as amended at 48 FR 49014, Oct. 24, 1983; 49 FR 10095, Mar. 19, 1984; 58 FR 2895, Jan. 6, 1993]

§ 133.184 Roquefort cheese, sheep's milk blue-mold, and blue-mold cheese from sheep's milk.

(a) *Description.* (1) Roquefort cheese, sheep's milk blue-mold cheese, blue-mold cheese from sheep's milk, is the food prepared by the procedure set forth in paragraph (a)(2) of this section or by any other procedure which produces a finished cheese having the same physical and chemical properties. It is characterized by the presence of bluish-green mold, *Penicillium roquefortii*, throughout the cheese. The minimum milkfat content is 50 percent by weight of the solids and the maximum moisture content is 45 percent by weight, as determined by the methods described in §133.5. The dairy ingredients used may be pasteurized. Roquefort cheese is at least 60 days old.

(2) One or more of the dairy ingredients specified in paragraph (b)(1) of this section may be warmed and is subjected to the action of a lactic acid-producing bacterial culture. One or more of the clotting enzymes specified in paragraph (b)(2) of this section is added to set the dairy ingredients to a semisolid mass. The mass is cut into smaller portions and allowed to stand for a time. The mixed curd and whey is placed into forms permitting further drainage. While being placed in forms, spores of the mold *Penicillium roquefortii* are added. The forms are turned several times during drainage. When sufficiently drained, the shaped curd is removed from the forms and salted with dry salt or brine. Perforations are then made in the shaped curd and it is held at a temperature of approximately 50 °F at 90 to 95 percent relative humidity, until the characteristic mold growth has developed. During storage, the surface of the cheese may be scraped to remove surface growth of undesirable microorganisms. One or more of the other optional ingredients specified in paragraph (b)(3) of this section may be added during the procedure.

(b) *Operational ingredients.* The following safe and suitable ingredients may be used:

(1) *Dairy ingredients.* Forms of milk, nonfat milk, or cream, as defined in §133.3, of sheep origin, used alone or in combination.

(2) *Clotting enzymes.* Rennet and/or other clotting enzymes of animal, plant, or microbial origin.

(3) *Other optional ingredients.* Enzymes of animal, plant, or microbial origin, used in curing or flavor development.

(c) *Nomenclature.* The name of the food is “roquefort cheese”, or alternatively, “sheep's milk blue-mold cheese” or “blue-mold cheese from sheep's milk.”

(d) *Label declaration.* Each of the ingredients used in the food shall be declared on the label as required by the applicable sections of parts 101 and 130 of this chapter, except that:

(1) Enzymes of animal, plant, or microbial origin may be declared as “enzymes”; and

(2) The dairy ingredients may be declared, in descending order of predominance, by the use of the terms “milkfat from sheep's milk and nonfat sheep's milk” or “nonfat sheep's milk and milkfat from sheep's milk”, as appropriate.

[54 FR 32058, Aug. 4, 1989, as amended at 58 FR 2895, Jan. 6, 1993]

§ 133.185 Samsøe cheese.

(a) *Description.* (1) Samsøe cheese is the food prepared by the procedure set forth in paragraph (a)(3) of this section or by any other procedure which produces a finished cheese having the same physical and chemical properties. It has a small amount of eye formation of approximately uniform size of about five-sixteenths inch (8 millimeters). The minimum milkfat content is 45 percent by weight of the solids and the maximum moisture content is 41 percent by weight, as determined by the methods described in §133.5. The dairy ingredients used may be pasteurized. Samsøe cheese is cured at not less than 35 °F for at least 60 days.

(2) If pasteurized dairy ingredients are used, the phenol equivalent value of 0.25 gram of samsøe cheese is not

more than 3 micrograms as determined by the method described in §133.5.

(3) One or more of the dairy ingredients specified in paragraph (b)(1) of this section may be warmed and is subjected to the action of a lactic acid-producing bacterial culture. One or more of the clotting enzymes specified in paragraph (b)(2) of this section is added to set the dairy ingredients to a semisolid mass. After coagulation the mass is cut into small cube-shaped pieces with sides approximately three-eighths inch (1 centimeter). The mass is stirred and heated to about 102 °F, and so handled by further stirring, heating, dilution with water, and salting as to promote and regulate the separation of curd and whey. When the desired curd is obtained, it is transferred to forms permitting drainage of whey. During drainage, the curd is pressed. After drainage, the curd is removed from the forms and is further salted by immersing in a concentrated salt solution for about 3 days. The curd is then cured at a temperature of from 60° to 70 °F for 3 to 5 weeks to obtain the desired eye formation. Further curing is conducted at a lower temperature. One or more of the other optional ingredients specified in paragraph (b)(3) of this section may be added during the procedure.

(b) *Optional ingredients.* The following safe and suitable ingredients may be used:

(1) *Dairy ingredients.* Milk, nonfat milk, or cream, as defined in §133.3, used alone or in combination.

(2) *Clotting enzymes.* Rennet and/or other clotting enzymes of animal, plant, or microbial origin.

(3) *Other optional ingredients.* (i) Coloring.

(ii) Calcium chloride in an amount not more than 0.02 percent (calculated as anhydrous calcium chloride) by weight of the dairy ingredients, used as a coagulation aid.

(iii) Enzymes of animal, plant, or microbial origin, used in curing or flavor development.

(iv) Antimycotic agents, applied to the surface of slices or cuts in consumer-sized packages.

(c) *Nomenclature.* The name of the food is "samsoe cheese".

(d) *Label declaration.* Each of the ingredients used in the food shall be declared on the label as required by the applicable sections of parts 101 and 130 of this chapter, except that:

(1) Enzymes of animal, plant, or microbial origin may be declared as "enzymes"; and

(2) The dairy ingredients may be declared, in descending order of predominance, by the use of the terms "milkfat and nonfat milk" or "nonfat milk and milkfat", as appropriate.

[48 FR 2745, Jan. 21, 1983; 48 FR 11426, Mar. 18, 1983, as amended at 58 FR 2895, Jan. 6, 1993]

§ 133.186 Sap sago cheese.

(a) *Description.* (1) Sap sago cheese is the food prepared by the procedure set forth in paragraph (a)(2) of this section or by any other procedure which produces a finished cheese having the same physical and chemical properties. The cheese is pale green in color and has the shape of a truncated cone. The maximum moisture content is 38 percent by weight, as determined by the method described in §133.5. Sap sago cheese is not less than 5 months old.

(2) One or more of the dairy ingredients specified in paragraph (b)(1) of this section is allowed to become sour, and is heated to boiling temperature, with stirring. Sufficient sour whey is added to precipitate the casein. The curd is removed, spread out in boxes, and pressed, and while under pressure is allowed to drain and ferment. It is ripened for not less than 5 weeks. The ripened curd is dried and ground; salt and dried clover of the species *Melilotus coerulea* are added. The mixture is shaped into truncated cones and ripened. The optional ingredient in paragraph (b)(2) of this section may be added during this procedure.

(b) *Optional ingredients.* The following safe and suitable ingredients may be used:

(1) *Dairy ingredients.* Nonfat milk, as defined in §133.3.

(2) *Other optional ingredients.* Butter-milk.

(c) *Nonmenclature.* The name of the food is "sap sago cheese".

(d) *Label declaration.* Each of the ingredients used in the food shall be declared on the label as required by the

§ 133.187

21 CFR Ch. I (4-1-07 Edition)

applicable sections of parts 101 and 130 of this chapter.

[54 FR 32058, Aug. 4, 1989, as amended at 58 FR 2895, Jan. 6, 1993]

§ 133.187 Semisoft cheeses.

(a) The cheeses for which definitions and standards of identity are prescribed by this section are semisoft cheeses for which specifically applicable definitions and standards of identity are not prescribed by other sections of this part. They are made from milk and other ingredients specified in this section, by the procedure set forth in paragraph (b) of this section. They contain more than 39 percent, but not more than 50 percent, of moisture, and their solids contain not less than 50 percent of milkfat, as determined by the methods prescribed in §133.5 (a), (b), and (d). If the milk used is not pasteurized, the cheese so made is cured at a temperature of not less than 35 °F for not less than 60 days.

(b) Milk, which may be pasteurized or clarified or both, and which may be warmed, is subjected to the action of harmless lactic-acid-producing bacteria or other harmless flavor-producing bacteria, present in such milk or added thereto. Sufficient rennet, rennet paste, extract of rennet paste, or other safe and suitable milk-clotting enzyme that produces equivalent curd formation, singly or in any combination (with or without purified calcium chloride in a quantity not more than 0.02 percent, calculated as anhydrous calcium chloride, of the weight of the milk) is added to set the milk to a semisolid mass. Harmless artificial coloring may be added. After coagulation the mass is so treated as to promote and regulate the separation of whey and curd. Such treatment may include one or more of the following: cutting, stirring, heating, dilution with water or brine. The whey, or part of it, is drained off, and the curd is collected and shaped. It may be placed in forms, and may be pressed. Harmless flavor-producing microorganisms may be added. It may be cured in a manner to promote the growth of biological curing agents. Salt may be added during the procedure. A harmless preparation of enzymes of animal or plant origin capable of aiding in the curing or de-

velopment of flavor of semisoft cheese may be added, in such quantity that the weight of the solids of such preparation is not more than 0.1 percent of the weight of the milk used.

(c) For the purposes of this section:

(1) The word "milk" means cow's milk or goat's milk or sheep's milk or mixtures of two or all of these. Such milk may be adjusted by separating part of the fat therefrom, or (in the case of cow's milk) by adding one or more of the following: Cream, skim milk, concentrated skim milk, nonfat dry milk; (in the case of goat's milk) the corresponding products from goat's milk; (in the case of sheep's milk) the corresponding products from sheep's milk; water in a quantity sufficient to reconstitute any concentrated or dried products used.

(2) Milk shall be deemed to have been pasteurized if it has been held at a temperature of not less than 143 °F for a period of not less than 30 minutes, or for a time and at a temperature equivalent thereto in phosphatase destruction. A semisoft cheese shall be deemed not to have been made from pasteurized milk if 0.25 gram shows a phenol equivalent of more than 5 micrograms when tested by the method prescribed in §133.5(c).

(d) Semisoft cheeses in the form of slices or cuts in consumer-sized packages may contain an optional mold-inhibiting ingredient consisting of sorbic acid, potassium sorbate, sodium sorbate, or any combination of two or more of these, in an amount not to exceed 0.3 percent by weight, calculated as sorbic acid.

(e) The name of each semisoft cheese for which a definition and standard of identity is prescribed by this section is "Semisoft cheese", preceded or followed by:

(1) The specific common or usual name of such semisoft cheese, if any such name has become generally recognized therefor; or

(2) If no such specific common or usual name has become generally recognized therefor, an arbitrary or fanciful name which is not false or misleading in any particular.

(f)(1) When milk other than cow's milk is used in whole or in part, the

name of the cheese includes the statement "made from _____", the blank being filled in with the name or names of the milk used, in order of predominance by weight.

(2) If semisoft cheese in sliced or cut form contains an optional mold-inhibiting ingredient as specified in paragraph (d) of this section, the label shall bear the statement "_____ added to retard mold growth" or "_____ added as a preservative", the blank being filled in with the common name or names of the mold-inhibiting ingredient or ingredients used.

(3) Wherever the name of the food appears on the label so conspicuously as to be easily seen under customary conditions of purchase, the words and statements prescribed by this section, showing the optional ingredient used, shall immediately and conspicuously precede or follow such name, without intervening written, printed, or graphic matter.

(g) *Label declaration.* Each of the ingredients used in the food shall be declared on the label as required by the applicable sections of parts 101 and 130 of this chapter.

[42 FR 14366, Mar. 15, 1977, as amended at 49 FR 10096, Mar. 19, 1984; 58 FR 2895, Jan. 6, 1993]

§ 133.188 Semisoft part-skim cheeses.

(a) The cheeses for which definitions and standards of identity are prescribed by this section are semisoft part-skim cheeses for which specifically applicable definitions and standards of identity are not prescribed by other sections of this part. They are made from partly skimmed milk and other ingredients specified in this section, by the procedure set forth in paragraph (b) of this section. They contain not more than 50 percent of moisture, and their solids contain not less than 45 percent, but less than 50 percent, of milkfat, as determined by the methods set forth in §133.5 (a), (b), and (d). If the milk used is not pasteurized, the cheese so made is cured at a temperature of not less than 35 °F, for not less than 60 days.

(b) Milk, which may be pasteurized or clarified or both, and which may be warmed, is subjected to the action of harmless lactic-acid-producing bac-

teria or other harmless flavor-producing bacteria, present in such milk or added thereto. Sufficient rennet, rennet paste, extract of rennet paste, or other safe and suitable milk-clotting enzyme that produces equivalent curd formation singly or in any combination (with or without purified calcium chloride in a quantity not more than 0.02 percent, calculated as anhydrous calcium chloride, of the weight of the milk) is added to set the milk to a semisolid mass. Harmless artificial coloring may be added. After coagulation the mass is so treated as to promote and regulate the separation of whey and curd. Such treatment may include one or more of the following: Cutting, stirring, heating, dilution with water or brine. The whey, or part of it, is drained off, and the curd is collected and shaped. It may be placed in forms, and it may be pressed. Harmless flavor-producing microorganisms may be added. It may be cured in a manner to promote the growth of biological curing agents. Salt may be added during the procedure. A harmless preparation of enzymes of animal or plant origin capable of aiding in the curing or development of flavor of semisoft part-skim cheese may be added in such quantity that the weight of the solids of such preparation is not more than 0.1 percent of the weight of the milk used.

(c) For the purposes of this section:

(1) The word "milk" means cow's milk or goat's milk or sheep's milk or mixtures of two or all of these. Such milk may be adjusted by separating part of the fat therefrom or (in the case of cow's milk) by adding one or more of the following: Cream, skim milk, concentrated skim milk, nonfat dry milk; (in the case of goat's milk) the corresponding products from goat's milk; (in the case of sheep's milk) the corresponding products from sheep's milk; water in a quantity sufficient to reconstitute any such concentrated or dried products used.

(2) Milk shall be deemed to have been pasteurized if it has been held at a temperature of not less than 143 °F for a period of not less than 30 minutes, or for a time and at a temperature equivalent thereto in phosphatase destruction. A semisoft part-skim cheese shall

§ 133.189

21 CFR Ch. I (4-1-07 Edition)

be deemed not to have been made from pasteurized milk if 0.25 gram shows a phenol equivalent of more than 5 micrograms when tested by the method prescribed in §133.5(c).

(d) Semisoft part-skim cheeses in the form of slices or cuts in consumer-sized packages may contain an optional mold-inhibiting ingredient consisting of sorbic acid, potassium sorbate, sodium sorbate, or any combination of two or more of these, in an amount not to exceed 0.3 percent by weight, calculated as sorbic acid.

(e) The name of each semisoft part-skim cheese for which a definition and standard of identity is prescribed by this section is "Semisoft part-skim cheese," preceded or followed by:

(1) The specific common or usual name of such semisoft cheese, if any such name has become generally recognized therefor; or

(2) If no such specific common or usual name has become generally recognized therefor, an arbitrary or fanciful name which is not false or misleading in any particular.

(f)(1) When milk other than cow's milk is used in whole or in part, the name of the cheese includes the statement "made from _____", the blank being filled in with the name or names of the milk used, in order of predominance by weight.

(2) If semi-soft part-skim cheese in sliced or cut form contains an optional mold-inhibiting ingredient as specified in paragraph (d) of this section, the label shall bear the statement "_____ added to retard mold growth" or "_____ added as a preservative", the blank being filled in with the common name or names of the mold-inhibiting ingredient or ingredients used.

(3) Wherever the name of the food appears on the label so conspicuously as to be easily seen under customary conditions of purchase, the words and statements prescribed by this section, showing the optional ingredient used, shall immediately and conspicuously precede or follow such name, without intervening written, printed, or graphic matter.

(g) Each of the ingredients used in the food shall be declared on the label

as required by the applicable sections of parts 101 and 130 of this chapter.

[42 FR 14366, Mar. 19, 1977, as amended at 49 FR 10096, Mar. 19, 1984; 58 FR 2895, Jan. 6, 1993]

§ 133.189 Skim milk cheese for manufacturing.

(a) Skim milk cheese for manufacturing is the food prepared from skim milk and other ingredients specified in this section, by the procedure set forth in paragraph (b) of this section, or by another procedure which produces a finished cheese having the same physical and chemical properties as the cheese produced when the procedure set forth in paragraph (b) of this section is used. It contains not more than 50 percent of moisture, as determined by the method prescribed in §133.5 (a). It is coated with blue-colored paraffin or other tightly adhering coating, colored blue.

(b) Skim milk or the optional dairy ingredients specified in paragraph (c) of this section, which may be pasteurized, and which may be warmed, are subjected to the action of harmless lactic-acid-producing bacteria, present in such milk or added thereto. Harmless artificial coloring may be added. Sufficient rennet, or other safe and suitable milk-clotting enzyme that produces equivalent curd formation, or both, with or without purified calcium chloride in a quantity not more than 0.02 percent (calculated as anhydrous calcium chloride) of the weight of the skim milk, is added to set the skim milk to a semisolid mass. The mass is so cut, stirred, and heated with continued stirring, as to promote and regulate the separation of whey and curd. The whey is drained off, and the curd is matted into a cohesive mass. Proteins from the whey may be incorporated. The mass is cut into slabs which are so piled and handled as to promote the drainage of whey and the development of acidity. The slabs are then cut into pieces, which may be rinsed by pouring or sprinkling water over them, with free and continuous drainage; but the duration of such rinsing is so limited that only the whey on the surface of such pieces is removed. The curd is salted, stirred, further drained, and

pressed into forms. A harmless preparation of enzymes of animal or plant origin capable of aiding in the curing or development of flavor of skim milk cheese for manufacturing may be added during the procedure, in such quantity that the weight of the solids of such preparation is not more than 0.1 percent of the weight of the milk used.

(c) The optional dairy ingredients referred to in paragraph (b) of this section are: Skim milk or concentrated skim milk or nonfat dry milk or a mixture of any two or more of these, with water in a quantity not in excess of that sufficient to reconstitute any concentrated skim milk or nonfat dry milk used.

(d) For the purposes of this section, "skim milk" means cow's milk from which the milk fat has been separated.

(e) Each of the ingredients used in the food shall be declared on the label as required by the applicable sections of parts 101 and 130 of this chapter.

[42 FR 14366, Mar. 15, 1977, as amended at 49 FR 10096, Mar. 19, 1984; 58 FR 2895, Jan. 6, 1993]

§ 133.190 Spiced cheeses.

(a) *Description.* (1) Spiced cheeses are cheeses for which specifically applicable definitions and standards of identity are not prescribed by other sections of this part. The food is prepared by the procedure set forth in paragraph (a)(3) of this section or by any other procedure which produces a finished cheese having the same physical and chemical properties. The minimum milkfat content is 50 percent by weight of the solids, as determined by the method described in §133.5. The food contains spices, in a minimum amount of 0.015 ounce per pound of cheese, and may contain spice oils. If the dairy ingredients are not pasteurized, the cheese is cured at a temperature of not less than 35 °F for at least 60 days.

(2) The phenol equivalent of 0.25 gram of spiced cheese is not more than 3 micrograms, as determined by the method described in §133.5.

(3) One or more of the dairy ingredients specified in paragraph (b)(1) of this section may be warmed and is subjected to the action of a harmless lactic acid-producing bacterial culture. One or more of the clotting enzymes

specified in paragraph (b)(2) of this section is added to set the dairy ingredients to a semisolid mass. The mass is divided into smaller portions and so handled by stirring, heating, and diluting with water or salt brine as to promote and regulate the separation of whey and curd. The whey is drained off. The curd is removed and may be further drained. The curd is then shaped into forms, and may be pressed. At some time during the procedure, spices are added so as to be evenly distributed throughout the finished cheese. One or more of the other optional ingredients specified in paragraph (b)(3) of this section may be added during the procedure.

(b) *Optional ingredients.* The following safe and suitable ingredients may be used:

(1) *Dairy ingredients.* Milk, nonfat milk, or cream, as defined in §133.3, or corresponding products of goat or sheep origin, used alone or in combination.

(2) *Clotting enzymes.* Rennet and/or other clotting enzymes of animal, plant, or microbial origin.

(3) *Other optional ingredients.* (i) Coloring.

(ii) Calcium chloride in an amount not more than 0.02 percent (calculated as anhydrous calcium chloride) of the weight of the dairy ingredients, used as a coagulation aid.

(iii) Salt.

(iv) Spice oils which do not, alone or in combination with other ingredients, simulate the flavor of cheese of any age or variety.

(v) Enzymes of animal, plant, or microbial origin, used in curing or flavor development.

(vi) Antimycotic agents, applied to the surface of slices or cuts in consumer-sized packages.

(c) *Nomenclature.* The name of the food is "spiced cheese". The following terms shall accompany the name of the food, as appropriate:

(1) The specific common or usual name of the spiced cheese, if any such name has become generally recognized; or

(2) An arbitrary or fanciful name that is not false or misleading in any particular.

§ 133.191

(d) *Label declaration.* Each of the ingredients used in the food shall be declared on the label as required by the applicable sections of parts 101 and 130 of this chapter, except that:

(1) Enzymes of animal, plant, or microbial origin may be declared as “enzymes”; and

(2) The dairy ingredients may be declared, in descending order of predominance, by the use of the terms “milkfat and nonfat milk” or “nonfat milk and milkfat”, or “milkfat from goat’s milk and nonfat goat’s milk”, etc., as appropriate.

[54 FR 32059, Aug. 4, 1989, as amended at 58 FR 2895, Jan. 6, 1993]

§ 133.191 Part-skim spiced cheeses.

Part-skim spiced cheeses conform to the definition and standard of identity, and are subject to the requirements for label statement of ingredients prescribed for spiced cheeses by § 133.190, except that their solids contain less than 50 percent, but not less than 20 percent, of milkfat.

[58 FR 2895, Jan. 6, 1993]

§ 133.193 Spiced, flavored standardized cheeses.

(a) Except as otherwise provided for herein and in applicable sections in this part, a spiced or flavored standardized cheese conforms to the applicable definitions, standard of identity and requirements for label statement of ingredients prescribed for that specific natural cheese variety promulgated pursuant to section 401 of the Federal Food, Drug, and Cosmetic Act. In addition a spiced and/or flavored standardized cheese shall contain one or more safe and suitable spices and/or flavorings, in such proportions as are reasonably required to accomplish their intended effect: *Provided*, That, no combination of ingredients shall be used to simulate the flavor of cheese of any age or variety.

(b) The name of a spiced or flavored standardized cheese shall include in addition to the varietal name of the natural cheese, a declaration of any flavor and/or spice that characterizes the

21 CFR Ch. I (4–1–07 Edition)

food, in the manner prescribed in § 101.22 of this chapter.

[42 FR 14366, Mar. 15, 1977, as amended at 58 FR 2895, Jan. 6, 1993]

§ 133.195 Swiss and emmentaler cheese.

(a) *Description.* (1) Swiss cheese, emmentaler cheese, is the food prepared by the procedure set forth in paragraph (a)(3) of this section, or by any other procedure which produces a finished cheese having the same physical and chemical properties. It has holes or eyes developed throughout the cheese. The minimum milkfat content is 43 percent by weight of the solids and the maximum moisture content is 41 percent by weight, as determined by the methods described in § 133.5. The dairy ingredients used may be pasteurized. Swiss cheese is at least 60 days old.

(2) If pasteurized dairy ingredients are used, the phenol equivalent value of 0.25 gram of swiss cheese is not more than 3 micrograms as determined by the method described in § 133.5.

(3) One or more of the dairy ingredients specified in paragraph (b)(1) of this section may be bleached, warmed, or treated with hydrogen peroxide/catalase, and is subjected to the action of lactic acid-producing and propionic acid-producing bacterial cultures. One or more of the clotting enzymes specified in paragraph (b)(2) of this section is added to set the dairy ingredients to a semisolid mass. The mass is cut into particles similar in size to wheat kernels. For about 30 minutes the particles are alternately stirred and allowed to settle. The temperature is raised to about 126 °F. Stirring is continued until the curd becomes firm. The acidity of the whey at this point, calculated as lactic acid, does not exceed 0.13 percent. The curd is transferred to hoops or forms and pressed until the desired shape and firmness are obtained. The cheese is then salted by immersing it in a saturated salt solution for about 3 days. It is then held at a temperature of about 50° to 60 °F. for a period of 5 to 10 days, after which it is held at a temperature of about 75 °F. until it is approximately 30 days old, or until the so-called eyes form. Salt, or a solution of salt in water, is

added to the surface of the cheese at some time during the curing process. The cheese is then stored at a lower temperature for further curing. One or more of the optional ingredients specified in paragraph (b)(3) of this section may be added during the procedure.

(b) *Optional ingredients.* The following safe and suitable ingredients may be used:

(1) *Dairy ingredients.* Milk, nonfat milk, or cream, as defined in §133.3, used alone or in combination.

(2) *Clotting enzymes.* Rennet and/or other clotting enzymes of animal, plant, or microbial origin.

(3) *Other optional ingredients.* (i) Coloring.

(ii) Calcium chloride in an amount not more than 0.02 percent (calculated as anhydrous calcium chloride) by weight of the dairy ingredients, used as a coagulation aid.

(iii) Enzymes of animal, plant, or microbial origin, used in curing or flavor development.

(iv) Antimycotic agents, the cumulative levels of which shall not exceed good manufacturing practice, may be added to the surface of the cheese.

(v) Benzoyl peroxide or a mixture of benzoyl peroxide with potassium alum, calcium sulfate, and magnesium carbonate used to bleach the dairy ingredients. The weight of the benzoyl peroxide is not more than 0.002 percent of the weight of the milk being bleached, and the weight of the potassium alum, calcium sulfate, and magnesium carbonate, singly or combined, is not more than six times the weight of the benzoyl peroxide used. If milk is bleached in this manner, vitamin A is added to the curd in such quantity as to compensate for the vitamin A or its precursors destroyed in the bleaching process, and artificial coloring is not used.

(vi) Hydrogen peroxide, followed by a sufficient quantity of catalase preparation to eliminate the hydrogen peroxide. The weight of the hydrogen peroxide shall not exceed 0.05 percent of the weight of the milk and the weight of the catalase shall not exceed 20 parts per million of the weight of the milk treated.

(c) *Nomenclature.* The name of the food is "swiss cheese", or alternatively, "emmentaler cheese".

(d) *Label declaration.* Each of the ingredients used in the food shall be declared on the label as required by the applicable sections of parts 101 and 130 of this chapter, except that:

(1) Enzymes of animal, plant, or microbial origin may be declared as "enzymes"; and

(2) The dairy ingredients may be declared, in descending order of predominance, by the use of the terms "milkfat and nonfat milk" or "nonfat milk and milkfat", as appropriate.

[48 FR 2746, Jan. 21, 1983; 48 FR 11426, Mar. 18, 1983, as amended at 55 FR 6795, Feb. 27, 1990; 58 FR 2895, Jan. 6, 1993]

§ 133.196 Swiss cheese for manufacturing.

Swiss cheese for manufacturing conforms to the definition and standard of identity prescribed for swiss cheese by §133.195, except that the holes, or eyes, have not developed throughout the entire cheese.

[55 FR 6795, Feb. 27, 1990]

PART 135—FROZEN DESSERTS

Subpart A—General Provisions

Sec.
135.3 Definitions.

Subpart B—Requirements for Specific Standardized Frozen Desserts

135.110 Ice cream and frozen custard.
135.115 Goat's milk ice cream.
135.130 Mellorine.
135.140 Sherbet.
135.160 Water ices.

AUTHORITY: 21 U.S.C. 321, 341, 343, 348, 371, 379e.

Subpart A—General Provisions

§ 135.3 Definitions.

For the purposes of this part, a pasteurized mix is one in which every particle of the mix has been heated in properly operated equipment to one of the temperatures specified in the table in this section and held continuously at or above that temperature for the specified time (or other time/temperature relationship which has been demonstrated to be equivalent thereto in microbial destruction):

§ 135.110

21 CFR Ch. I (4-1-07 Edition)

Temperature	Time
155 °F	30 min.
175 °F	25 sec.

[42 FR 19132, Apr. 12, 1977]

Subpart B—Requirements for Specific Standardized Frozen Deserts

§ 135.110 Ice cream and frozen custard.

(a) *Description.* (1) Ice cream is a food produced by freezing, while stirring, a pasteurized mix consisting of one or more of the optional dairy ingredients specified in paragraph (b) of this section, and may contain one or more of the optional caseinates specified in paragraph (c) of this section subject to the conditions hereinafter set forth, one or more of the optional hydrolyzed milk proteins as provided for in paragraph (d) of this section subject to the conditions hereinafter set forth, and other safe and suitable nonmilk-derived ingredients; and excluding other food fats, except such as are natural components of flavoring ingredients used or are added in incidental amounts to accomplish specific functions. Ice cream is sweetened with safe and suitable sweeteners and may be characterized by the addition of flavoring ingredients.

(2) Ice cream contains not less than 1.6 pounds of total solids to the gallon, and weighs not less than 4.5 pounds to the gallon. Ice cream contains not less than 10 percent milkfat, nor less than 10 percent nonfat milk solids, except that when it contains milkfat at 1 percent increments above the 10 percent minimum, it may contain the following milkfat-to-nonfat milk solids levels:

Percent milkfat	Minimum percent nonfat milk solids
10	10
11	9
12	8
13	7
14	6

Except that when one or more bulky flavors are used, the weights of milkfat and total milk solids are not less than

10 percent and 20 percent, respectively, of the remainder obtained by subtracting the weight of the bulky flavors from the weight of the finished food; but in no case is the weight of milkfat or total milk solids less than 8 percent and 16 percent, respectively, of the weight of the finished food. Except in the case of frozen custard, ice cream contains less than 1.4 percent egg yolk solids by weight of the food, exclusive of the weight of any bulky flavoring ingredients used. Frozen custard shall contain 1.4 percent egg yolk solids by weight of the finished food: *Provided, however,* That when bulky flavors are added the egg yolk solids content of frozen custard may be reduced in proportion to the amount by weight of the bulky flavors added, but in no case is the content of egg yolk solids in the finished food less than 1.12 percent. A product containing egg yolk solids in excess of 1.4 percent, the maximum set forth in this paragraph for ice cream, may be marketed if labeled as specified by paragraph (e)(1) of this section.

(3) When calculating the minimum amount of milkfat and nonfat milk solids required in the finished food, the solids of chocolate or cocoa used shall be considered a bulky flavoring ingredient. In order to make allowance for additional sweetening ingredients needed when certain bulky ingredients are used, the weight of chocolate or cocoa solids used may be multiplied by 2.5; the weight of fruit or nuts used may be multiplied by 1.4; and the weight of partially or wholly dried fruits or fruit juices may be multiplied by appropriate factors to obtain the original weights before drying and this weight may be multiplied by 1.4.

(b) *Optional dairy ingredients.* The optional dairy ingredients referred to in paragraph (a) of this section are: Cream; dried cream; plastic cream (sometimes known as concentrated milkfat); butter; butter oil; milk; concentrated milk; evaporated milk; sweetened condensed milk; superheated condensed milk; dried milk; skim milk; concentrated skim milk; evaporated skim milk; condensed skim milk; superheated condensed skim milk; sweetened condensed skim milk; sweetened condensed part-skim milk; nonfat

dry milk; sweet cream buttermilk; condensed sweet cream buttermilk; dried sweet cream buttermilk; skim milk, that may be concentrated, and from which part or all of the lactose has been removed by a safe and suitable procedure; skim milk in concentrated or dried form that has been modified by treating the concentrated skim milk with calcium hydroxide and disodium phosphate; and whey and those modified whey products (e.g., reduced lactose whey, reduced minerals whey, and whey protein concentrate) that have been determined by FDA to be generally recognized as safe (GRAS) for use in this type of food. Water may be added, or water may be evaporated from the mix. The sweet cream buttermilk and the concentrated sweet cream buttermilk or dried sweet cream buttermilk, when adjusted with water to a total solids content of 8.5 percent, has a titratable acidity of not more than 0.17 percent, calculated as lactic acid. The term "milk" as used in this section means cow's milk. Any whey and modified whey products used contribute, singly or in combination, not more than 25 percent by weight of the total nonfat milk solids content of the finished food. The modified skim milk, when adjusted with water to a total solids content of 9 percent, is substantially free of lactic acid as determined by titration with 0.1N NaOH, and it has a Ph value in the range of 8.0 to 8.3.

(c) *Optional caseinates.* The optional caseinates referred to in paragraph (a) of this section that may be added to ice cream mix containing not less than 20 percent total milk solids are: Casein prepared by precipitation with gums, ammonium caseinate, calcium caseinate, potassium caseinate, and sodium caseinate. Caseinate may be added in liquid or dry form, but must be free of excess alkali.

(d) *Optional hydrolyzed milk proteins.* One or more of the optional hydrolyzed milk proteins referred to in paragraph (a) of this section may be added as stabilizers at a level not to exceed 3 percent by weight of ice cream mix containing not less than 20 percent total milk solids, provided that any whey and modified whey products used contribute, singly or in combination, not more than 25 percent by weight of the

total nonfat milk solids content of the finished food. Further, when hydrolyzed milk proteins are used in the food, the declaration of these ingredients on the food label shall comply with the requirements of §102.22 of this chapter.

(e) *Methods of analysis.* The fat content shall be determined by the method prescribed in "Official Methods of Analysis of the Association of Official Analytical Chemists," 13th Ed. (1980), sections 16.287 and 16.059, under "Fat, Roese-Gottlieb Method—Official Final Action," which is incorporated by reference. Copies may be obtained from the AOAC INTERNATIONAL, 481 North Frederick Ave., suite 500, Gaithersburg, MD 20877, or may be examined at the National Archives and Records Administration (NARA). For information on the availability of this material at NARA, call 202-741-6030, or go to: http://www.archives.gov/federal_register/code_of_federal_regulations/ibr_locations.html.

(f) *Nomenclature.* (1) The name of the food is "ice cream"; except that when the egg yolk solids content of the food is in excess of that specified for ice cream by paragraph (a) of this section, the name of the food is "frozen custard" or "french ice cream" or "french custard ice cream".

(2)(i) If the food contains no artificial flavor, the name on the principal display panel or panels of the label shall be accompanied by the common or usual name of the characterizing flavor, e.g., "vanilla", in letters not less than one-half the height of the letters used in the words "ice cream".

(ii) If the food contains both a natural characterizing flavor and an artificial flavor simulating it, and if the natural flavor predominates, the name on the principal display panel or panels of the label shall be accompanied by the common name of the characterizing flavor, in letters not less than one-half the height of the letters used in the words "ice cream", followed by the word "flavored", in letters not less than one-half the height of the letters in the name of the characterizing flavor, e.g., "Vanilla flavored", or "Peach flavored", or "Vanilla flavored and Strawberry flavored".

(iii) If the food contains both a natural characterizing flavor and an artificial flavor simulating it, and if the artificial flavor predominates, or if artificial flavor is used alone the name on the principal display panel or panels of the label shall be accompanied by the common name of the characterizing flavor in letters not less than one-half the height of the letters used in the words "ice cream", preceded by "artificial" or "artificially flavored", in letters not less than one-half the height of the letters in the name of the characterizing flavor, e.g., "artificial Vanilla", or "artificially flavored Strawberry" or "artificially flavored Vanilla and artificially flavored Strawberry".

(3)(i) If the food is subject to the requirements of paragraph (f)(2)(ii) of this section or if it contains any artificial flavor not simulating the characterizing flavor, the label shall also bear the words "artificial flavor added" or "artificial _____ flavor added", the blank being filled with the common name of the flavor simulated by the artificial flavor in letters of the same size and prominence as the words that precede and follow it.

(ii) Wherever the name of the characterizing flavor appears on the label so conspicuously as to be easily seen under customary conditions of purchase, the words prescribed by this paragraph shall immediately and conspicuously precede or follow such name, in a size reasonably related to the prominence of the name of the characterizing flavor and in any event the size of the type is not less than 6-point on packages containing less than 1 pint, not less than 8-point on packages containing at least 1 pint but less than one-half gallon, not less than 10-point on packages containing at least one-half gallon but less than 1 gallon, and not less than 12-point on packages containing 1 gallon or over: *Provided, however,* That where the characterizing flavor and a trademark or brand are presented together, other written, printed, or graphic matter that is a part of or is associated with the trademark or brand, may intervene if the required words are in such relationship with the trademark or brand as to be clearly related to the characterizing flavor: *And provided further,* That if the

finished product contains more than one flavor of ice cream subject to the requirements of this paragraph, the statements required by this paragraph need appear only once in each statement of characterizing flavors present in such ice cream, e.g., "Vanilla flavored, Chocolate, and Strawberry flavored, artificial flavors added".

(4) If the food contains both a natural characterizing flavor and an artificial flavor simulating the characterizing flavor, any reference to the natural characterizing flavor shall, except as otherwise authorized by this paragraph, be accompanied by a reference to the artificial flavor, displayed with substantially equal prominence, e.g., "strawberry and artificial strawberry flavor".

(5) An artificial flavor simulating the characterizing flavor shall be deemed to predominate:

(i) In the case of vanilla beans or vanilla extract used in combination with vanillin if the amount of vanillin used is greater than 1 ounce per unit of vanilla constituent, as that term is defined in §169.3(c) of this chapter.

(ii) In the case of fruit or fruit juice used in combination with artificial fruit flavor, if the quantity of the fruit or fruit juice used is such that, in relation to the weight of the finished ice cream, the weight of the fruit or fruit juice, as the case may be (including water necessary to reconstitute partially or wholly dried fruits or fruit juices to their original moisture content) is less than 2 percent in the case of citrus ice cream, 6 percent in the case of berry or cherry ice cream, and 10 percent in the case of ice cream prepared with other fruits.

(iii) In the case of nut meats used in combination with artificial nut flavor, if the quantity of nut meats used is such that, in relation to the finished ice cream the weight of the nut meats is less than 2 percent.

(iv) In the case of two or more fruits or fruit juices, or nut meats, or both, used in combination with artificial flavors simulating the natural flavors and dispersed throughout the food, if the quantity of any fruit or fruit juice or nut meat is less than one-half the applicable percentage specified in paragraph (e)(5) (ii) or (iii) of this section.

For example, if a combination ice cream contains less than 5 percent of bananas and less than 1 percent of almonds it would be “artificially flavored banana-almond ice cream”. However, if it contains more than 5 percent of bananas and more than 1 percent of almonds it would be “banana-almond flavored ice cream”.

(6) If two or more flavors of ice cream are distinctively combined in one package, e.g., “Neapolitan” ice cream, the applicable provisions of this paragraph shall govern each flavor of ice cream comprising the combination.

(7) Until September 14, 1998, when safe and suitable sweeteners other than nutritive carbohydrate sweeteners are used in the food, their presence shall be declared by their common or usual name on the principal display panel of the label as part of the statement of identity in letters that shall be no less than one-half the size of the type used in the term “ice cream” but in any case no smaller than one-sixteenth of an inch. If the food purports to be or is represented for special dietary use, it shall bear labeling in accordance with the requirements of part 105 of this chapter.

(g) *Label declaration.* Each of the ingredients used shall be declared on the label as required by the applicable sections of parts 101 and 130 of this chapter, except that the sources of milkfat or milk solids not fat may be declared in descending order of predominance either by the use of all the terms “milkfat and nonfat milk” when one or any combination of two or more of the ingredients listed in §101.4(b)(3), (b)(4), (b)(8), and (b)(9) of this chapter are used or, alternatively, as permitted in §101.4 of this chapter. Under section 403(k) of the Federal Food, Drug, and Cosmetic Act, artificial color need not be declared in ice cream, except as required by §101.22(c) or (k) of this chapter. Voluntary declaration of all colors used in ice cream and frozen custard is recommended.

[43 FR 4598, Feb. 3, 1978, as amended at 45 FR 63838, Sept. 26, 1980; 46 FR 44433, Sept. 4, 1981; 47 FR 11826, Mar. 19, 1982; 49 FR 10096, Mar. 19, 1984; 54 FR 24894, June 12, 1989; 58 FR 2896, Jan. 6, 1993; 59 FR 47079, Sept. 14, 1994; 63 FR 14035, Mar. 24, 1998; 63 FR 14818, Mar. 27, 1998]

§ 135.115 Goat’s milk ice cream.

(a) *Description.* Goat’s milk ice cream is the food prepared in the same manner prescribed in §135.110 for ice cream, and complies with all the provisions of §135.110, except that the only optional dairy ingredients that may be used are those in paragraph (b) of this section; caseinates and hydrolyzed milk proteins may not be used; and paragraphs (f)(1) and (g) of §135.110 shall not apply.

(b) *Optional dairy ingredients.* The optional dairy ingredients referred to in paragraph (a) of this section are goat’s skim milk, goat’s milk, and goat’s cream. These optional dairy ingredients may be used in liquid, concentrated, and/or dry form.

(c) *Nomenclature.* (1) The name of the food is “goat’s milk ice cream” or, alternatively, “ice cream made with goat’s milk”, except that when the egg yolk solids content of the food is in excess of that specified for ice cream in paragraph (a) of §135.110, the name of the food is “goat’s milk frozen custard” or, alternatively, “frozen custard made with goat’s milk”, or “goat’s milk french ice cream”, or, alternatively, “french ice cream made with goat’s milk”, or “goat’s milk french custard ice cream”, or, alternatively, “french custard ice cream made with goat’s milk”.

(2) Until September 14, 1998, when safe and suitable sweeteners other than nutritive carbohydrate sweeteners are used in the food, their presence shall be declared by their common or usual name on the principal display panel of the label as part of the statement of identity in letters that shall be no less than one-half the size of the type used in the term “goat’s milk ice cream” but in any case no smaller than one-sixteenth of an inch. If the food purports to be or is represented for special dietary use, it shall bear labeling in accordance with the requirements of part 105 of this chapter.

(d) *Label declaration.* Each of the ingredients used in the food shall be declared on the label as required by the applicable sections of parts 101 and 130 of this chapter.

[47 FR 41526, Sept. 21, 1982, as amended at 58 FR 2896, Jan. 6, 1993; 59 FR 47080, Sept. 14, 1994]

§ 135.130 Mellorine.

(a) *Description.* (1) Mellorine is a food produced by freezing, while stirring, a pasteurized mix consisting of safe and suitable ingredients including, but not limited to, milk-derived nonfat solids and animal or vegetable fat, or both, only part of which may be milkfat. Mellorine is sweetened with nutritive carbohydrate sweetener and is characterized by the addition of flavoring ingredients.

(2) Mellorine contains not less than 1.6 pounds of total solids to the gallon, and weighs not less than 4.5 pounds to the gallon. Mellorine contains not less than 6 percent fat and 2.7 percent protein having a protein efficiency ratio (PER) not less than that of whole milk protein (108 percent of casein) by weight of the food, exclusive of the weight of any bulky flavoring ingredients used. In no case shall the fat content of the finished food be less than 4.8 percent or the protein content be less than 2.2 percent. The protein to meet the minimum protein requirements shall be provided by milk solids, not fat and/or other milk-derived ingredients.

(3) When calculating the minimum amount of milkfat and protein required in the finished food, the solids of chocolate or cocoa used shall be considered a bulky flavoring ingredient. In order to make allowance for additional sweetening ingredients needed when certain bulky ingredients are used, the weight of chocolate or cocoa solids used may be multiplied by 2.5; the weight of fruit or nuts used may be multiplied by 1.4; and the weight of partially or wholly dried fruits or fruit juices may be multiplied by appropriate factors to obtain the original weights before drying and this weight may be multiplied by 1.4.

(b) *Fortification.* Vitamin A is present in a quantity which will ensure that 40 international units (IU) are available for each gram of fat in mellorine, within limits of good manufacturing practice.

(c) *Methods of analysis.* Fat and protein content, and the PER shall be determined by following the methods contained in "Official Methods of Analysis of the Association of Official Analytical Chemists," 13th Ed. (1980),

which is incorporated by reference. Copies may be obtained from the AOAC INTERNATIONAL, 481 North Frederick Ave., suite 500, Gaithersburg, MD 20877, or may be examined at the National Archives and Records Administration (NARA). For information on the availability of this material at NARA, call 202-741-6030, or go to: http://www.archives.gov/federal_register/code_of_federal_regulations/ibr_locations.html.

(1) Fat content shall be determined by the method: "Fat, Roesse-Gottlieb Method—Official Final Action," section 16.287.

(2) Protein content shall be determined by one of the following methods: "Nitrogen—Official Final Action," Kjeldahl Method, section 16.285, or Dye Binding Method, section 16.286.

(3) PER shall be determined by the method: "Biological Evaluation of Protein Quality—Official Final Action," sections 43.212–43.216.

(d) *Nomenclature.* The name of the food is "mellorine". The name of the food on the label shall be accompanied by a declaration indicating the presence of characterizing flavoring in the same manner as is specified in § 135.110(c).

(e) *Label declaration.* Each of the ingredients used shall be declared on the label as required by the applicable sections of parts 101 and 130 of this chapter, except that sources of milkfat or milk solids not fat may be declared in descending order of predominance either by the use of the terms "milkfat and nonfat milk" when one or any combination of two or more of the ingredients listed in § 101.4(b)(3), (b)(4), (b)(8), and (b)(9) of this chapter are used, or alternatively as permitted in § 101.4 of this chapter.

[42 FR 19137, Apr. 12, 1977, as amended at 47 FR 11826, Mar. 19, 1982; 49 FR 10096, Mar. 19, 1984; 54 FR 24894, June 12, 1989; 58 FR 2896, Jan. 6, 1993; 63 FR 14035, Mar. 24, 1998]

§ 135.140 Sherbet.

(a) *Description.* (1) Sherbet is a food produced by freezing, while stirring, a pasteurized mix consisting of one or more of the optional dairy ingredients specified in paragraph (b) of this section, and may contain one or more of the optional caseinates specified in

paragraph (c) of this section subject to the conditions hereinafter set forth, and other safe and suitable nonmilk-derived ingredients; and excluding other food fats, except such as are added in small amounts to accomplish specific functions or are natural components of flavoring ingredients used. Sherbet is sweetened with nutritive carbohydrate sweeteners and is characterized by the addition of one or more of the characterizing fruit ingredients specified in paragraph (d) of this section or one or more of the nonfruit-characterizing ingredients specified in paragraph (e) of this section.

(2) Sherbet weighs not less than 6 pounds to the gallon. The milkfat content is not less than 1 percent nor more than 2 percent, the nonfat milk-derived solids content not less than 1 percent, and the total milk or milk-derived solids content is not less than 2 percent nor more than 5 percent by weight of the finished food. Sherbet that is characterized by a fruit ingredient shall have a titratable acidity, calculated as lactic acid, of not less than 0.35 percent.

(b) *Optional dairy ingredients.* The optional dairy ingredients referred to in paragraph (a) of this section are: Cream, dried cream, plastic cream (sometimes known as concentrated milkfat), butter, butter oil, milk, concentrated milk, evaporated milk, superheated condensed milk, sweetened condensed milk, dried milk, skim milk, concentrated skim milk, evaporated skim milk, condensed skim milk, sweetened condensed skim milk, sweetened condensed part-skim milk, nonfat dry milk, sweet cream buttermilk, condensed sweet cream buttermilk, dried sweet cream buttermilk, skim milk that has been concentrated and from which part of the lactose has been removed by crystallization, and whey and those modified whey products (e.g., reduced lactose whey, reduced minerals whey, and whey protein concentrate) that have been determined by FDA to be generally recognized as safe (GRAS) for use in this type of food. Water may be added, or water may be evaporated from the mix. The sweet cream buttermilk and the concentrated sweet cream buttermilk or dried sweet cream buttermilk, when adjusted with water to a

total solids content of 8.5 percent, has a titratable acidity of not more than 0.17 percent calculated as lactic acid. The term "milk" as used in this section means cow's milk.

(c) *Optional caseinates.* The optional caseinates referred to in paragraph (a) of this section which may be added to sherbet mix are: Casein prepared by precipitation with gums, ammonium caseinate, calcium caseinate, potassium caseinate, and sodium caseinate. Caseinates may be added in liquid or dry form, but must be free of excess alkali, such caseinates are not considered to be milk solids.

(d) *Optional fruit-characterizing ingredients.* The optional fruit-characterizing ingredients referred to in paragraph (a) of this section are any mature fruit or the juice of any mature fruit. The fruit or fruit juice used may be fresh, frozen, canned, concentrated, or partially or wholly dried. The fruit may be thickened with pectin or other optional ingredients. The fruit is prepared by the removal of pits, seeds, skins, and cores, where such removal is usual in preparing that kind of fruit for consumption as fresh fruit. The fruit may be screened, crushed, or otherwise comminuted. It may be acidulated. In the case of concentrated fruit or fruit juices, from which part of the water is removed, substances contributing flavor volatilized during water removal may be condensed and reincorporated in the concentrated fruit or fruit juice. In the case of citrus fruits, the whole fruit, including the peel but excluding the seeds, may be used, and in the case of citrus juice or concentrated citrus juices, cold-pressed citrus oil may be added thereto in an amount not exceeding that which would have been obtained if the whole fruit had been used. The quantity of fruit ingredients used is such that, in relation to the weight of the finished sherbet, the weight of fruit or fruit juice, as the case may be (including water necessary to reconstitute partially or wholly dried fruits or fruit juices to their original moisture content), is not less than 2 percent in the case of citrus sherbets, 6 percent in the case of berry sherbets, and 10 percent in the case of sherbets prepared with other fruits. For the purpose of

§ 135.160

21 CFR Ch. I (4-1-07 Edition)

this section, tomatoes and rhubarb are considered as kinds of fruit.

(e) *Optional nonfruit characterizing ingredients.* The optional nonfruit characterizing ingredients referred to in paragraph (a) of this section include but are not limited to the following:

(1) Ground spice or infusion of coffee or tea.

(2) Chocolate or cocoa, including sirup.

(3) Confectionery.

(4) Distilled alcoholic beverage, including liqueurs or wine, in an amount not to exceed that required for flavoring the sherbet.

(5) Any natural or artificial food flavoring (except any having a characteristic fruit or fruit-like flavor).

(f) *Nomenclature.* (1) The name of each sherbet is as follows:

(i) The name of each fruit sherbet is “_____ sherbet”, the blank being filled in with the common name of the fruit or fruits from which the fruit ingredients used are obtained. When the names of two or more fruits are included, such names shall be arranged in order of predominance, if any, by weight of the respective fruit ingredients used.

(ii) The name of each nonfruit sherbet is “_____ sherbet”, the blank being filled in with the common or usual name or names of the characterizing flavor or flavors; for example, “peppermint”, except that if the characterizing flavor used is vanilla, the name of the food is “_____ sherbet”, the blank being filled in as specified by §135.110(e)(2) and (5)(i).

(2) When the optional ingredients, artificial flavoring, or artificial coloring are used in sherbet, they shall be named on the label as follows:

(i) If the flavoring ingredient or ingredients consists exclusively of artificial flavoring, the label designation shall be “artificially flavored”.

(ii) If the flavoring ingredients are a combination of natural and artificial flavors, the label designation shall be “artificial and natural flavoring added”.

(iii) The label shall designate artificial coloring by the statement “artificially colored”, “artificial coloring added”, “with added artificial coloring”, or “_____, an artificial color

added”, the blank being filled in with the name of the artificial coloring used.

(g) *Characterizing flavor(s).* Wherever there appears on the label any representation as to the characterizing flavor or flavors of the food and such flavor or flavors consist in whole or in part of artificial flavoring, the statement required by paragraph (f)(2)(i) and (ii) of this section, as appropriate, shall immediately and conspicuously precede or follow such representation, without intervening written, printed, or graphic matter (except that the word “sherbet” may intervene) in a size reasonably related to the prominence of the name of the characterizing flavor and in any event the size of the type is not less than 6-point on packages containing less than 1 pint, not less than 8-point on packages containing at least 1 pint but less than one-half gallon, not less than 10-point on packages containing at least one-half gallon but less than 1 gallon, and not less than 12-point on packages containing 1 gallon or over.

(h) *Display of statements required by paragraph (f)(2).* Except as specified in paragraph (g) of this section, the statements required by paragraph (f)(2) of this section shall be set forth on the principal display panel or panels of the label with such prominence and conspicuousness as to render them likely to be read and understood by the ordinary individual under customary conditions of purchase and use.

(i) *Label declaration.* Each of the ingredients used in the food shall be declared on the label as required by the applicable sections of parts 101 and 130 of this chapter.

[43 FR 4599, Feb. 3, 1978, as amended at 46 FR 44434, Sept. 4, 1981; 58 FR 2896, Jan. 6, 1993]

§ 135.160 Water ices.

(a) *Description.* Water ices are the foods each of which is prepared from the same ingredients and in the same manner prescribed in §135.140 for sherbets, except that the mix need not be pasteurized, and complies with all the provisions of §135.140 (including the requirements for label statement of ingredients), except that no milk or milk-derived ingredient and no egg ingredient, other than egg white, is used.

(b) *Nomenclature.* The name of the food is “_____ ice”, the blank being filled in, in the same manner as specified in §135.140(f)(1) (i) and (ii), as appropriate.

[42 FR 19132, Apr. 12, 1977, as amended 58 FR 2876, Jan. 6, 1993]

PART 136—BAKERY PRODUCTS

Subpart A—General Provisions

Sec.

136.3 Definitions.

Subpart B—Requirements for Specific Standardized Bakery Products

- 136.110 Bread, rolls, and buns.
- 136.115 Enriched bread, rolls, and buns.
- 136.130 Milk bread, rolls, and buns.
- 136.160 Raisin bread, rolls, and buns.
- 136.180 Whole wheat bread, rolls, and buns.

AUTHORITY: 21 U.S.C. 321, 341, 343, 348, 371, 379e.

Subpart A—General Provisions

§ 136.3 Definitions.

For purposes of this part, the following definitions apply:

(a) The word *bread* when used in the name of the food means the unit weighs one-half pound or more after cooling.

(b) The words *rolls* and *buns* when used in the name of the food mean the unit weighs less than one-half pound after cooling.

Subpart B—Requirements for Specific Standardized Bakery Products

§ 136.110 Bread, rolls, and buns.

(a) Bread, white bread, and rolls, white rolls, or buns, and white buns are the foods produced by baking mixed yeast-leavened dough prepared from one or more of the farinaceous ingredients listed in paragraph (c)(1) of this section and one or more of the moistening ingredients listed in paragraphs (c) (2), (6), (7), and (8) of this section and one or more of the leavening agents provided for by paragraph (c)(3) of this section. The food may contain additional ingredients as provided for by paragraph (c) of this section. Each

of the finished foods contains not less than 62 percent total solids as determined by the method prescribed in paragraph (d) of this section.

(b) All ingredients from which the food is fabricated shall be safe and suitable.

(c) The following optional ingredients are provided for:

(1) Flour, bromated flour, phosphated flour, or a combination of two or more of these. The potassium bromate in any bromated flour used and the monocalcium phosphate in any phosphated flour used are deemed to be additional optional ingredients in the bread, rolls, or buns. All ingredients in any flour, bromated flour, or phosphated flour used are deemed to be optional ingredients of the bread, rolls, or buns prepared therefrom.

(2) Water.

(3) Yeast—any type which produces the necessary leavening effect.

(4) Salt.

(5) Shortening, in which or in conjunction with which may be used one or any combination of two or more of the following:

(i) Lecithin, hydroxylated lecithin complying with the provisions of part 172 of this chapter, either of which may include related phosphatides derived from the corn oil or soybean oil from which such ingredients were obtained.

(ii) Mono- and diglycerides of fat-forming fatty acids, diacetyl tartaric acid esters of mono- and diglycerides of fat-forming fatty acids, propylene glycol mono- and diesters of fat-forming fatty acids, and other ingredients that perform a similar function.

(6) Milk and/or other dairy products in such quantity and composition as not to meet the requirements for milk and/or other dairy products prescribed for milk bread by §136.130. Whenever nonfat milk solids in any form are used, carrageenan or salts of carrageenan complying with the provisions of part 172 of this chapter may be used in a quantity not in excess of 0.8 percent by weight of such nonfat milk solids.

(7) Egg products.

(8) Nutritive carbohydrate sweeteners.

(9) Enzyme active preparations.

(10) Lactic-acid-producing bacteria.

(11) Nonwheat flours, nonwheat meals, nonwheat grits, wheat and nonwheat starches, any of which may be wholly or in part dextrinized, dextrinized wheat flour, or any combination of 2 or more of these, if the total quantity is not more than 3 parts for each 100 parts by weight of flour used.

(12) Ground dehulled soybeans which may be heat-treated, and from which oil may be removed, but which retain enzymatic activity, if the quantity is not more than 0.5 part for each 100 parts by weight of flour used.

(13) Yeast nutrients and calcium salts, if the total quantity of such ingredients, with the exception of monocalcium phosphate and calcium propionate, is not more than 0.25 part for each 100 parts by weight of flour used. The quantity of monocalcium phosphate, including any quantity in the flour used, is not more than 0.75 part for each 100 parts by weight of flour used. Any calcium propionate used as a preservative in bread, rolls, or buns is not subject to the limitation prescribed in this paragraph.

(14)(i) Potassium bromate, calcium bromate, potassium iodate, calcium iodate, calcium peroxide, or any combination of 2 or more of these if the total quantity, including the potassium bromate in any bromated flour used, is not more than 0.0075 part for each 100 parts by weight of flour used.

(ii) Azodicarbonamide, if the total quantity, including any quantity in the flour used, is not more than 0.0045 part for each 100 parts by weight of flour used.

(15) Dough strengtheners and other dough conditioners not listed or referred to in this paragraph, if the total quantities of such ingredients or combination is not more than 0.5 part for each 100 parts by weight of flour used.

(16) Spices, spice oil, and spice extract.

(17) Coloring may not be added as such or as part of another ingredient except as permitted by paragraph (c)(16) of this section and except that coloring which may be present in butter or margarine if the intensity of the butter or margarine color does not exceed "medium high" (MH) when viewed under diffused light (7400 Kelvin)

against the Munsell Butter Color Comparator. The MH designation corresponds to the Munsell renotation of 3.8Y7.9/7.6.

(18) Other ingredients that do not change the basic identity or adversely affect the physical and nutritional characteristics of the food.

(d) Total solids are determined by the method prescribed in "Official Methods of Analysis of the Association of Official Analytical Chemists," 13th Ed. (1980), section 14.091(a), which is incorporated by reference, except that if the baked unit weighs 454 grams (1 pound) or more, one entire unit is used for the determination; if the baked unit weighs less than 454 grams, enough units to weigh 454 grams or more are used. Copies of the material incorporated by reference may be obtained from the AOAC INTERNATIONAL, 481 North Frederick Ave., suite 500, Gaithersburg, MD 20877, or may be examined at the National Archives and Records Administration (NARA). For information on the availability of this material at NARA, call 202-741-6030, or go to: http://www.archives.gov/federal_register/code_of_federal_regulations/ibr_locations.html.

(e)(1) The name of the food is "bread", "white bread", "rolls", "white rolls", "buns", "white buns", as applicable. When the food contains not less than 2.56 percent by weight of whole egg solids, the name of the food may be "egg bread", "egg rolls", or "egg buns", as applicable, accompanied by the statement "Contains ___ medium-sized egg(s) per pound" in the manner prescribed by §102.5(c)(3) of this chapter, the blank to be filled in with the number which represents the whole egg content of the food expressed to the nearest one-fifth egg but not greater than the amount actually present. For the purpose of this regulation, whole egg solids are the edible contents of eggs calculated on a moisture-free basis and exclusive of any nonegg solids which may be present in standardized and other commercial egg products. One medium-sized egg is equivalent to 0.41 ounce of whole egg solids.

(2) When the label bears any representation, other than in the ingredient listing, of the presence of egg in the food, e.g., the word egg or any phonetic equivalent spelling of the word egg, or a picture of an egg, the food shall contain not less than 2.56 percent of whole egg solids.

(f) *Label declaration.* Each of the ingredients used shall be declared on the label as required by the applicable sections of parts 101 and 130 of this chapter.

[42 FR 14400, Mar. 15, 1977, as amended at 43 FR 47177, Oct. 13, 1978; 47 FR 11826, Mar. 19, 1982; 49 FR 10096, Mar. 19, 1984; 49 FR 13692, Apr. 6, 1984; 54 FR 24894, June 12, 1989; 58 FR 2877, Jan. 6, 1993; 63 FR 14035, Mar. 24, 1998]

§136.115 Enriched bread, rolls, and buns.

(a) Each of the foods enriched bread, enriched rolls, and enriched buns conforms to the definition and standard of identity and is subject to the requirements for label statement of ingredients prescribed for bread, rolls or buns by §136.110, except that:

(1) Each such food contains in each pound 1.8 milligrams of thiamin, 1.1 milligrams of riboflavin, 15 milligrams of niacin, 0.43 milligrams of folic acid, and 12.5 milligrams of iron.

(2) Each such food may contain added calcium in such quantity that the total calcium content is 600 milligrams per pound. If insufficient calcium is added to meet the 600-milligram level per pound of the finished food, no claim may be made on the label for calcium as a nutrient except as a part of nutrition labeling.

(3) The requirements of paragraphs (a) (1) and (2) of this section will be deemed to have been met if reasonable overages of the vitamins and minerals, within the limits of good manufacturing practice, are present to ensure that the required levels of the vitamins and minerals are maintained throughout the expected shelf life of the food under customary conditions of distribution and storage. The quantitative content of the following vitamins shall be calculated in terms of the following chemically identifiable reference forms:

Vitamin	Reference form		
	Name	Empirical formula	Molecular weight
Thiamine ...	Thiamine chloride hydrochloride.	C ₁₂ H ₁₇ ClN ₄ OS·HCl	337.28
Riboflavin ..	Riboflavin	C ₁₇ H ₂₀ N ₄ O ₆	376.37
Niacin	Niacin	C ₆ H ₅ NO ₂	123.11

(4) Each such food may also contain wheat germ or partly defatted wheat germ, but the total quantity thereof, including any wheat germ or partly defatted wheat germ in any enriched flour used, shall not be more than 5 percent of the flour ingredient.

(5) Enriched flour may be used, in whole or in part, instead of flour. As used in this section, the term “enriched flour” includes enriched bromated flour.

(6) The limitation prescribed by §136.110(c)(6) on the quantity and composition of milk and/or other dairy products does not apply.

(7) The vitamins and minerals added to the food for enrichment purposes may be supplied by any safe and suitable substances. Niacin equivalents as derived from tryptophan content shall not be used in determining total niacin content.

(b) The name of the food is “enriched bread”, “enriched rolls”, or “enriched buns”, as applicable. When the food contains not less than 2.56 percent by weight of whole egg solids, the name of the food may be “enriched egg bread”, “enriched egg rolls”, or “enriched egg buns”, as applicable, accompanied by the statement “Contains __ medium-sized egg(s) per pound” in the manner prescribed by §102.5(c)(3) of this chapter, the blank to be filled in with the number which represents the whole egg content of the food expressed to the nearest one-fifth egg but not greater than the amount actually present. For the purpose of this regulation, whole egg solids are the edible contents of eggs calculated on a moisture-free basis and exclusive of any non-egg solids which may be present in standardized and other commercial egg products. One medium-sized egg is equivalent to 0.41 ounce of whole egg solids. When the food complies with the requirements for milk and/or other dairy products content in §136.130 for milk

§ 136.130

bread, the name of the food may be “enriched milk bread”, “enriched milk rolls”, or “enriched milk buns”, as applicable. When the food complies with the requirements for both enriched egg bread and enriched milk bread in this section, the name of the food may be “enriched milk and egg bread”, “enriched milk and egg rolls”, or “enriched milk and egg buns”, as applicable accompanied by the statement “Contains medium-sized egg(s) per pound” in the manner prescribed by §102.5(c)(3) of this chapter, the blank to be filled in with the number which represents the whole egg content of the food expressed to the nearest one-fifth egg but no greater than the amount actually present. For purposes of this regulation, whole egg solids are the edible contents of eggs calculated on a moisture-free basis and exclusive of any non-egg solids which may be present in standardized or other commercial egg products. One medium-sized egg is equivalent to 0.41 ounce of whole egg solids.

[42 FR 14400, Mar. 15, 1977, as amended at 43 FR 38578, Aug. 29, 1978; 46 FR 43413, Aug. 28, 1981; 61 FR 8796, Mar. 5, 1996; 61 FR 14245, Apr. 1, 1996]

§ 136.130 Milk bread, rolls, and buns.

(a) Each of the foods milk bread, milk rolls, and milk buns conforms to the definition and standard of identity and is subject to the requirements for label statement of ingredients prescribed for bread, rolls or buns by §136.110 except that:

(1) The only moistening ingredient permitted in the preparation of the dough is milk or, as an alternative, a combination of dairy products in such a proportion that the weight of the nonfat milk solids is not more than 2.3 times and not less than 1.2 times the weight of the milkfat therein, with or without water, in a quantity that provides not less than 8.2 parts milk solids for each 100 parts by weight of flour.

(2) No buttermilk, buttermilk product, cheese whey, cheese whey product, or milk protein is used.

(b) The name of the food is “milk bread”, “milk rolls”, “milk buns”, as applicable.

21 CFR Ch. I (4–1–07 Edition)

§ 136.160 Raisin bread, rolls, and buns.

(a) Each of the foods raisin bread, raisin rolls, and raisin buns conforms to the definition and standard of identity and is subject to the requirements for label statement of ingredients prescribed for bread, rolls or buns by §136.110, except that:

(1) Not less than 50 parts by weight of seeded or seedless raisins are used for each 100 parts by weight of flour used.

(2) Water extract of raisins may be used, but not to replace raisins.

(3) The baked units may bear icing or frosting.

(4) The limitation prescribed by §136.110(c)(6) on the quantity and composition of milk and/or other dairy products does not apply.

(5) The total solids are determined by the method prescribed in §136.110(d), except that section 14.091(b) of “Official Methods of Analysis of the Association of Official Analytical Chemists,” 13th Ed. (1980), which is incorporated by reference, will apply. Copies may be obtained from the AOAC INTERNATIONAL, 481 North Frederick Ave., suite 500, Gaithersburg, MD 20877, or may be examined at the National Archives and Records Administration (NARA). For information on the availability of this material at NARA, call 202-741-6030, or go to: http://www.archives.gov/federal_register/code_of_federal_regulations/ibr_locations.html.

(b) The name of the food is “raisin bread”, “raisin rolls”, “raisin buns”, as applicable. When the food contains not less than 2.56 percent by weight of whole egg solids, the name of the food may be “raisin and egg bread”, “raisin and egg rolls”, or “raisin and egg buns”, as applicable, accompanied by the statement “Contains medium-sized egg(s) per pound” in the manner prescribed by §102.5(c)(3) of this chapter, the blank to be filled in with the number which represents the whole egg content of the food expressed to the nearest one-fifth egg but not greater than the amount actually present. For purposes of this regulation, whole egg solids are the edible contents of eggs calculated on a moisture-free basis and exclusive of any nonegg solids which may be present in standardized and other commercial egg products. One

Food and Drug Administration, HHS

§ 137.105

medium-sized egg is equivalent to 0.41 ounce of whole egg solids.

[42 FR 14400, Mar. 15, 1977, as amended at 47 FR 11826, Mar. 19, 1982; 49 FR 10096, Mar. 19, 1984; 54 FR 24894, June 12, 1989; 63 FR 14035, Mar. 24, 1998]

§ 136.180 Whole wheat bread, rolls, and buns.

(a) Each of the foods whole wheat bread, graham bread, entire wheat bread, whole wheat rolls, graham rolls, entire wheat rolls, whole wheat buns, graham buns, and entire wheat buns conforms to the definition and standard of identity and is subject to the label statement of ingredients prescribed for bread, rolls and buns by §136.110, except that:

(1) The dough is made from the optional ingredient whole wheat flour, bromated whole wheat flour, or a combination of these. No flour, bromated flour, or phosphated flour is used. The potassium bromate in any bromated whole wheat flour used is deemed to be an additional optional ingredient in the whole wheat bread, whole wheat rolls, or whole wheat buns.

(2) The limitation prescribed by §136.110(c)(6) on the quantity and composition of milk and/or other dairy products does not apply.

(b) The name of the food is "whole wheat bread", "graham bread", "entire wheat bread", "whole wheat rolls", "graham rolls", "entire wheat rolls", "whole wheat buns", "graham buns", "entire wheat buns", as applicable.

PART 137—CEREAL FLOURS AND RELATED PRODUCTS

Subpart A [Reserved]

Subpart B—Requirements for Specific Standardized Cereal Flours and Related Products

- Sec.
- 137.105 Flour.
- 137.155 Bromated flour.
- 137.160 Enriched bromated flour.
- 137.165 Enriched flour.
- 137.170 Instantized flours.
- 137.175 Phosphated flour.
- 137.180 Self-rising flour.
- 137.185 Enriched self-rising flour.
- 137.190 Cracked wheat.
- 137.195 Crushed wheat.
- 137.200 Whole wheat flour.

- 137.205 Bromated whole wheat flour.
- 137.211 White corn flour.
- 137.215 Yellow corn flour.
- 137.220 Durum flour.
- 137.225 Whole durum flour.
- 137.250 White corn meal.
- 137.255 Bolted white corn meal.
- 137.260 Enriched corn meals.
- 137.265 Degerminated white corn meal.
- 137.270 Self-rising white corn meal.
- 137.275 Yellow corn meal.
- 137.280 Bolted yellow corn meal.
- 137.285 Degerminated yellow corn meal.
- 137.290 Self-rising yellow corn meal.
- 137.300 Farina.
- 137.305 Enriched farina.
- 137.320 Semolina.
- 137.350 Enriched rice.

AUTHORITY: 21 U.S.C. 321, 341, 343, 348, 371, 379e.

SOURCE: 42 FR 14402, Mar. 15, 1977, unless otherwise noted.

EDITORIAL NOTE: Nomenclature changes to part 137 appear at 63 FR 14035, Mar. 24, 1998.

Subpart A [Reserved]

Subpart B—Requirements for Specific Standardized Cereal Flours and Related Products

§ 137.105 Flour.

(a) Flour, white flour, wheat flour, plain flour, is the food prepared by grinding and bolting cleaned wheat, other than durum wheat and red durum wheat. To compensate for any natural deficiency of enzymes, malted wheat, malted wheat flour, malted barley flour, or any combination of two or more of these, may be used; but the quantity of malted barley flour so used is not more than 0.75 percent. Harmless preparations of α -amylase obtained from *Aspergillus oryzae*, alone or in a safe and suitable carrier, may be used. When tested for granulation as prescribed in paragraph (c)(4) of this section, not less than 98 percent of the flour passes through a cloth having openings not larger than those of woven wire cloth designated "212 μ m (No. 70)" complying with the specifications for such cloth set forth in "Official Methods of Analysis of the Association of Official Analytical Chemists" (AOAC), 13th Ed. (1980), Table 1, "Nominal Dimensions of Standard Test Sieves (U.S.A. Standard Series)," under the heading "Definitions of Terms and

Explanatory Notes,” which is incorporated by reference. Copies may be obtained from the AOAC INTERNATIONAL, 481 North Frederick Ave., suite 500, Gaithersburg, MD 20877, or may be examined at the National Archives and Records Administration (NARA). For information on the availability of this material at NARA, call 202-741-6030, or go to: http://www.archives.gov/federal_register/code_of_federal_regulations/ibr_locations.html. The flour is freed from bran coat, or bran coat and germ, to such extent that the percent of ash therein, calculated to a moisture-free basis, is not more than the sum of 1/20 of the percent of protein therein, calculated to a moisture-free basis, plus 0.35. Its moisture content is not more than 15 percent. It may contain ascorbic acid in a quantity not to exceed 200 parts per million as a dough conditioner. Unless such addition conceals damage or inferiority or makes the flour appear to be better or of greater value than it is, one or any combination of two or more of the following optional bleaching ingredients may be added in a quantity not more than sufficient for bleaching or, in case such ingredient has an artificial aging effect, in a quantity not more than sufficient for bleaching and such artificial aging effect:

- (1) Oxides of nitrogen.
- (2) Chlorine.
- (3) Nitrosyl chloride.
- (4) Chlorine dioxide.
- (5) One part by weight of benzoyl peroxide mixed with not more than six parts by weight of one or any mixture of two or more of the following: potassium alum, calcium sulfate, magnesium carbonate, sodium aluminum sulfate, dicalcium phosphate, tricalcium phosphate, starch, calcium carbonate.
- (6) Acetone peroxides complying with the provisions of §172.802 of this chapter.
- (7) Azodicarbonamide (complying with the requirements of §172.806 of this chapter, including the quantitative limit of not more than 45 parts per million).

(b)(1) Label declaration. Each of the ingredients used in the food shall be declared on the label as required by the

applicable sections of parts 101 and 130 of this chapter.

(2) When ascorbic acid is added, the label shall bear the statement “Ascorbic acid added as a dough conditioner”. When the optional ingredient *α*-amylase obtained from *Aspergillus oryzae* is used, it may alternatively be declared in the list of ingredients as “Fungal *α*-amylase,” “Fungal *α*-amylase”, “Enzyme”, or “Enzyme added for improved baking”. When any optional bleaching ingredient is used, the label shall bear the word “Bleached”. Wherever the name of the food appears on the label so conspicuously as to be easily seen under customary conditions of purchase, the word “Bleached” shall immediately and conspicuously precede or follow such name, without intervening written, printed, or graphic matter; except that where such name is a part of a trademark or brand, other written, printed, or graphic matter, which is also a part of such trademark or brand, may so intervene if the word “Bleached” is in such juxtaposition with such trademark or brand as to be conspicuously related to such name.

(c) For the purposes of this section:

(1) Ash is determined by the method prescribed in the AOAC, 13th Ed. (1980), section 14.006, “Direct Method—Official Final Action,” under the heading “Ash (5),” which is incorporated by reference. The availability of this incorporation by reference is given in paragraph (a) of this section. Ash is calculated to a moisture-free basis by subtracting the percent of moisture in the flour from 100, dividing the remainder into the percent of ash, and multiplying the quotient by 100.

(2) Protein is 5.7 times the nitrogen as determined by the method prescribed in section 2.057, “Improved Kjeldahl Methods for Nitrate-Free Samples (20)—Official Final Action,” AOAC, 13th Ed. (1980), which is incorporated by reference. The availability of this incorporation by reference is given in paragraph (a) of this section. Protein is calculated to a moisture-free basis by subtracting the percent of moisture in the flour from 100, dividing the remainder into the percent of protein, and multiplying the quotient by 100.

(3) Moisture is determined by the method prescribed in the AOAC, 13th Ed. (1980), sections 14.002 and 14.003, "Vacuum Oven Method (2)—Official Final Action," under the heading "Total Solids Moisture, Indirect Method," which is incorporated by reference. The availability of this incorporation by reference is given in paragraph (a) of this section.

(4) Granulation is determined as follows: Use No. 70 sieve complying with the specifications for "Nominal Dimensions of Standard Test Sieves (U.S.A. Standard Series)" prescribed in paragraph (a) of this section. Attach bottom pan to sieve in Ro-Tap sifter (or an equivalent sifter). Place half of a rubber ball or other sieving aid in the sieve. Pour 100 grams of the sample in the sieve and turn on the sifter with knocker. Sift exactly 5 minutes. Weigh the residue on the No. 70 sieve and convert to percentage.

[42 FR 14402, Mar. 15, 1977, as amended at 47 FR 11827, Mar. 19, 1982; 47 FR 24693, June 8, 1982; 47 FR 43363, Oct. 1, 1982; 49 FR 10097, Mar. 19, 1984; 54 FR 24894, June 12, 1989; 58 FR 2877, Jan. 6, 1993]

§ 137.155 Bromated flour.

Bromated flour conforms to the definition and standard of identity, and is subject to the requirements for label statement of ingredients, prescribed for flour by §137.105, except that potassium bromate is added in a quantity not exceeding 50 parts to each million parts of the finished bromated flour, and is added only to flours whose baking qualities are improved by such addition.

[57 FR 2877, Jan. 6, 1993]

§ 137.160 Enriched bromated flour.

Enriched bromated flour conforms to the definition and standard of identity, and is subject to the requirements for label statement of ingredients, prescribed for enriched flour by §137.165, except that potassium bromate is added in a quantity not exceeding 50 parts to each million parts of the finished enriched bromated flour, and is added only to enriched flours whose baking qualities are improved by such addition.

[58 FR 2877, Jan. 6, 1993]

§ 137.165 Enriched flour.

Enriched flour conforms to the definition and standard of identity, and is subject to the requirements for label statement of ingredients, prescribed for flour by §137.105, except that:

(a) It contains in each pound 2.9 milligrams of thiamin, 1.8 milligrams of riboflavin, 24 milligrams of niacin, 0.7 milligrams of folic acid, and 20 milligrams of iron.

(b) It may contain added calcium in such quantity that the total calcium content is 960 milligrams per pound. Enriched flour may be acidified with monocalcium phosphate within the limits prescribed by §137.175 for phosphated flour, but, if insufficient additional calcium is present to meet the 960 milligram level, no claim may be made on the label for calcium as a nutrient;

(c) The requirement of paragraphs (a) and (b) of this section will be deemed to have been met if reasonable overages of the vitamins and minerals, within the limits of good manufacturing practice, are present to insure that the required levels of the vitamins and minerals are maintained throughout the expected shelf life of the food under customary conditions of distribution and storage. The quantitative content of the following vitamins shall be calculated in terms of the following chemically identifiable reference forms:

Vitamin	Reference form		
	Name	Empirical formula	Molecular weight
Thiamine ...	Thiamine chloride hydrochloride.	C ₁₂ H ₁₇ CIN ₄ OS·HCl	337.28
Riboflavin ..	Riboflavin	C ₁₇ H ₂₀ N ₄ O ₆	376.37
Niacin	Niacin	C ₆ H ₅ NO ₂	123.11

(d) It may contain not more than 5 percent by weight of wheat germ or partly defatted wheat germ;

(e) In determining whether the ash content complies with the requirements of this section, ash resulting from any added iron or salts of iron or calcium or wheat germ is excluded in calculating ash content.

(f) All ingredients from which the food is fabricated shall be safe and suitable. The vitamins and minerals added

§ 137.170

to the food for enrichment purposes may be supplied by any safe and suitable substance. Niacin equivalents as derived from tryptophan content shall not be used in determining total niacin content.

[42 FR 14402, Mar. 15, 1977, as amended at 43 FR 38578, Aug. 29, 1978; 46 FR 43414, Aug. 28, 1981; 58 FR 2877, Jan. 6, 1993; 61 FR 8796, Mar. 5, 1996]

§ 137.170 Instantized flours.

(a) Instantized flours, instant blending flours, and quick-mixing flours, are the foods each of which conforms to the definition and standard of identity and is subject to the requirement for label statement of ingredients prescribed for the corresponding kind of flour by §§137.105, 137.155, 137.160, 137.165, 137.175, 137.180, and 137.185, except that each such flour has been made by one of the optional procedures set forth in paragraph (b) of this section, and is thereby made readily pourable. Such flours will all pass through a No. 20 mesh U.S. standard sieve (840-micron opening), and not more than 20 percent will pass through a 200 mesh U.S. standard sieve (74-micron opening).

(b) The optional procedures referred to in paragraph (a) of this section are:

(1) A selective grinding and bolting procedure or other milling procedure, whereby controlled techniques are used to obtain a food too fine to meet the granulation specification prescribed in §137.300(a) for farina.

(2) An agglomerating procedure, whereby flour that originally meets the granulation specification prescribed in §137.105(a) has been modified by further processing, so that a number of the individual flour particles have been combined into agglomerates conforming to the granulation specifications set out in paragraph (a) of this section.

(c) The name of each product covered by this section is the name prescribed by the definition and standard of identity for the corresponding kind of flour as referred to in paragraph (a) of this section, preceded immediately and conspicuously by the words "Instantized", "Instant blending", or "Quick-mixing".

[42 FR 14402, Mar. 15, 1977, as amended at 58 FR 2877, Jan. 6, 1993]

21 CFR Ch. I (4-1-07 Edition)

§ 137.175 Phosphated flour.

Phosphated flour, phosphated white flour, and phosphated wheat flour, conform to the definition and standard of identity, and are subject to the requirements for label declaration of ingredients, prescribed for flour by §137.105, except that:

(a) Monocalcium phosphate is added in a quantity not less than 0.25 percent and not more than 0.75 percent of the weight of the finished phosphated flour; and

(b) In determining whether the ash content complies with the requirements of this section allowance is made for the added monocalcium phosphate.

[42 FR 14402, Mar. 15, 1977, as amended at 58 FR 2877, Jan. 6, 1993]

§ 137.180 Self-rising flour.

(a) Self-rising flour, self-rising white flour, self-rising wheat flour, is an intimate mixture of flour, sodium bicarbonate, and one or more of the acid-reacting substances monocalcium phosphate, sodium acid pyrophosphate, and sodium aluminum phosphate. It is seasoned with salt. When it is tested by the method prescribed in paragraph (c) of this section not less than 0.5 percent of carbon dioxide is evolved. The acid-reacting substance is added in sufficient quantity to neutralize the sodium bicarbonate. The combined weight of such acid-reacting substance and sodium bicarbonate is not more than 4.5 parts to each 100 parts of flour used. Subject to the conditions and restrictions prescribed by §137.105(a), the bleaching ingredients specified in such section may be added as optional ingredients. If the flour used in making the self-rising flour is bleached, the optional bleaching ingredient used therein (see §137.105(a)) is also an optional ingredient of the self-rising flour.

(b) Label declaration. Each of the ingredients used in the food, shall be declared on the label as required by the applicable sections of parts 101 and 130 of this chapter.

(c) The method referred to in paragraph (a) of this section is the method prescribed in "Official Methods of Analysis of the Association of Official Analytical Chemists" (AOAC), 13th Ed.

(1980), section 8.002, "Reagent (Displacement soln.)," and section 8.003, "Chittick apparatus," under the heading "Total Carbon Dioxide (1)—Official Final Action," which is incorporated by reference. Copies may be obtained from the AOAC INTERNATIONAL, 481 North Frederick Ave., suite 500, Gaithersburg, MD 20877, or may be examined at the National Archives and Records Administration (NARA). For information on the availability of this material at NARA, call 202-741-6030, or go to: http://www.archives.gov/federal_register/code_of_federal_regulations/ibr_locations.html. The following procedure is substituted for the procedure specified in the AOAC, under section 8.004, "Determination":

(1) Weigh 17 grams of the official sample into flask A, add 15-20 glass beads (4-6 mm. diameter), and connect this flask with the apparatus (fig. 22). Open stopcock C and by means of the leveling bulb E bring the displacement solution to the 25 cc. graduation above the zero mark. (This 25 cc. is a partial allowance for the volume of acid to be used in the decomposition.) Allow the apparatus to stand 1-2 minutes to insure that the temperature and pressure within the apparatus are the same as those of the room. Close the stopcock, lower the leveling bulb somewhat to reduce the pressure within the apparatus, and slowly run into the decomposition flask from burette F 45 cc. of sulfuric acid (1+5). To prevent the liberated carbon dioxide from escaping through the acid burette into the air, keep the displacement solution in the leveling bulb at all times during the decomposition at a lower level than that in the gas-measuring tube. Rotate and then vigorously agitate the decomposition flask for three minutes to mix the contents intimately. Allow to stand for 10 minutes to bring to equilibrium. Equalize the pressure in the measuring tube by means of the leveling bulb and read the volume of gas from the zero point on the tube. Deduct 20 cc. from this reading (this 20 cc. together with previous allowance of 25 cc. compensates for the 45 cc. acid used in the decomposition). Observe the temperature of the air surrounding the apparatus and also the barometric pressure and multiply the

number of mL of gas evolved by the factor given in section 52.007, "Correction factors for gasometric determination of carbon dioxide," AOAC, 13th Ed. (1980), which is incorporated by reference (the availability of this incorporation by reference is given in paragraph (c) of this section), for the temperature and pressure observed. Divide the corrected reading by 100 to obtain the apparent percent by weight of carbon dioxide in the official sample.

(2) Correct the apparent percent of carbon dioxide to compensate for varying atmospheric conditions by immediately assaying a synthetic sample by the same method in the same apparatus.

(3) Prepare the synthetic sample with 16.2 grams of flour, 0.30 gram of monocalcium phosphate, 0.30 gram of salt, and a sufficient quantity of sodium bicarbonate U.S.P. (dried over sulfuric acid) to yield the amount of carbon dioxide recovered in assay of official sample. Determine this quantity by multiplying weight of carbon dioxide recovered in assay of official sample by 1.91.

(4) Divide the weight of carbon dioxide recovered from synthetic sample by weight of carbon dioxide contained in sodium bicarbonate used.

(5) Divide the quotient into the apparent percent of carbon dioxide in official sample to obtain percent of carbon dioxide evolved from the official sample.

[42 FR 14402, Mar. 15, 1977, as amended at 47 FR 11827, Mar. 19, 1982; 49 FR 10097, Mar. 19, 1984; 54 FR 24894, June 12, 1989; 58 FR 2877, Jan. 6, 1993]

§ 137.185 Enriched self-rising flour.

Enriched self-rising flour conforms to the definition and standard of identity, and is subject to the requirements for label statement of ingredients, prescribed for self-rising flour by § 137.180, except that:

(a) It contains in each pound 2.9 milligrams of thiamin, 1.8 milligrams of riboflavin, 24 milligrams of niacin, 0.7 milligrams of folic acid, and 20 milligrams of iron.

(b) It contains added calcium in such quantity that the total calcium content is 960 milligrams per pound. If a

§ 137.190

21 CFR Ch. I (4-1-07 Edition)

calcium compound is added for technical purposes to give self-rising characteristics to the flour, the amount of calcium per pound of flour may exceed 960 milligrams provided that the excess is no greater than necessary to accomplish the intended effect. However, if such calcium is insufficient to meet the 960-milligram level, no claim may be made on the label for calcium as a nutrient.

(c) The requirements of paragraphs (a) and (b) of this section will be deemed to have been met if reasonable overages of the vitamins and minerals, within the limits of good manufacturing practice, are present to insure that the required levels of the vitamins and minerals are maintained throughout the expected shelf life of the food under customary conditions of distribution and storage. The quantitative content of the following vitamins shall be calculated in terms of the following chemically identifiable reference forms:

Vitamin	Reference form		
	Name	Empirical formula	Molecular weight
Thiamine ...	Thiamine chloride hydrochloride.	C ₁₂ H ₁₇ ClN ₄ OS·HCl	337.28
Riboflavin ..	Riboflavin	C ₁₇ H ₂₀ N ₄ O ₆	376.37
Niacin	Niacin	C ₆ H ₅ NO ₂	123.11

(d) It may contain not more than 5 percent by weight of wheat germ or partly defatted wheat germ;

(e) When calcium is added as dicalcium phosphate, such dicalcium phosphate is also considered to be an acid-reacting substance;

(f) When calcium is added as carbonate, the method set forth in §137.180(c) does not apply as a test for carbon dioxide evolved; but in such case the quantity of carbon dioxide evolved under ordinary conditions of use of the enriched self-rising flour is not less than 0.5 percent of the weight thereof;

(g) All ingredients from which the food is fabricated shall be safe and suitable. The vitamins and minerals added to the food for enrichment purposes may be supplied by any safe and suitable substances. Niacin equivalents as derived from tryptophan content shall

not be used in determining total niacin content.

[42 FR 14402, Mar. 15, 1977, as amended at 43 FR 38578, Aug. 29, 1978; 46 FR 43414, Aug. 28, 1981; 58 FR 2877, Jan. 6, 1993; 61 FR 8796, Mar. 5, 1996]

§ 137.190 Cracked wheat.

Cracked wheat is the food prepared by so cracking or cutting into angular fragments cleaned wheat other than durum wheat and red durum wheat that, when tested by the method prescribed in §137.200(c)(2), not less than 90 percent passes through a No. 8 sieve and not more than 20 percent passes through a No. 20 sieve. The proportions of the natural constituents of such wheat, other than moisture, remain unaltered. Cracked wheat contains not more than 15 percent of the moisture as determined by the method prescribed in "Official Methods of Analysis of the Association of Official Analytical Chemists," 13th Ed. (1980), section 7.002 under "Preparation of Sample—Official Final Action," and section 7.003 under "Moisture—Official Final Action. I. Drying in Vacuo at 95–100° (2)," which is incorporated by reference. Copies may be obtained from the AOAC INTERNATIONAL, 481 North Frederick Ave., suite 500, Gaithersburg, MD 20877, or may be examined at the National Archives and Records Administration (NARA). For information on the availability of this material at NARA, call 202-741-6030, or go to: http://www.archives.gov/federal_register/code_of_federal_regulations/ibr_locations.html.

[42 FR 14402, Mar. 15, 1977, as amended at 47 FR 11827, Mar. 19, 1982; 49 FR 10097, Mar. 19, 1984; 54 FR 24894, June 12, 1989]

§ 137.195 Crushed wheat.

Crushed wheat, coarse ground wheat, is the food prepared by so crushing cleaned wheat other than durum wheat and red durum wheat that, when tested by the method prescribed in §137.200(c)(2), 40 percent or more passes through a No. 8 sieve and less than 50 percent passes through a No. 20 sieve. The proportions of the natural constituents of such wheat, other than moisture, remain unaltered. Crushed wheat contains not more than 15 percent of moisture as determined by the

method prescribed in "Official Methods of Analysis of the Association of Official Analytical Chemists," 13th Ed. (1980), section 7.002 under "Preparation of Sample—Official Final Action," and section 7.003 under "Moisture—Official Final Action. I. Drying in Vacuo at 95–100° (2)," which is incorporated by reference. Copies may be obtained from the AOAC INTERNATIONAL, 481 North Frederick Ave., suite 500, Gaithersburg, MD 20877, or may be examined at the National Archives and Records Administration (NARA). For information on the availability of this material at NARA, call 202–741–6030, or go to: http://www.archives.gov/federal_register/code_of_federal_regulations/ibr_locations.html.

[42 FR 14402, Mar. 15, 1977, as amended at 47 FR 11827, Mar. 19, 1982; 49 FR 10097, Mar. 19, 1984; 54 FR 24894, June 12, 1989]

§ 137.200 Whole wheat flour.

(a) Whole wheat flour, graham flour, entire wheat flour is the food prepared by so grinding cleaned wheat, other than durum wheat and red durum wheat, that when tested by the method prescribed in paragraph (c)(2) of this section, not less than 90 percent passes through a 2.36 mm (No. 8) sieve and not less than 50 percent passes through a 850 µm (No. 20) sieve. The proportions of the natural constituents of such wheat, other than moisture, remain unaltered. To compensate for any natural deficiency of enzymes, malted wheat, malted wheat flour, malted barley flour, or any combination of two or more of these, may be used; but the quantity of malted barley flour so used is not more than 0.75 percent. It may contain harmless preparations of α -amylase obtained from *Aspergillus oryzae*, alone or in a safe and suitable carrier. The moisture content of whole wheat flour is not more than 15 percent. It may contain ascorbic acid in a quantity not to exceed 200 parts per million as a dough conditioner. Unless such addition conceals damage or inferiority or makes the whole wheat flour appear to be better or of greater value than it is, the optional bleaching ingredient azodicarbonamide (complying with the requirements of §172.806 of this chapter, including the quantitative limit of not more than 45 parts per million) or

chlorine dioxide, or chlorine, or a mixture of nitrosyl chloride and chlorine, may be added in a quantity not more than sufficient for bleaching and artificial aging effects.

(b)(1) Label declaration. Each of the ingredients used in the food shall be declared on the label as required by the applicable sections of parts 101 and 130 of this chapter.

(2) When ascorbic acid is added, the label shall bear the statement "Ascorbic acid added as a dough conditioner". When the optional ingredient " α "-amylase obtained from *Aspergillus oryzae*" is used, it may alternatively be declared in the list of ingredients as "Fungal α -amylase," "Fungal α -amylase", "Enzyme", or "Enzyme added for improved baking". When any optional bleaching ingredient is used, the label shall bear the word "Bleached". Wherever the name of the food appears on the label so conspicuously as to be easily seen under customary conditions of purchase, the word "Bleached" shall immediately and conspicuously precede or follow such name, without intervening written, printed, or graphic matter; except that where such name is a part of a trademark or brand, other written, printed or graphic matter, which is also a part of such trademark or brand, may so intervene if the word "Bleached" is in such juxtaposition with such trademark or brand as to be conspicuously related to such name.

(c) For the purposes of this section:

(1) Moisture is determined by the method prescribed in "Official Methods of Analysis of the Association of Official Analytical Chemists" (AOAC), 13th Ed. (1980), section 14.002. "Vacuum Oven Method—Official Final Action," and section 14.003, "Determination," which is incorporated by reference. Copies may be obtained from the AOAC INTERNATIONAL, 481 North Frederick Ave., suite 500, Gaithersburg, MD 20877, or may be examined at the National Archives and Records Administration (NARA). For information on the availability of this material at NARA, call 202–741–6030, or go to: http://www.archives.gov/federal_register/code_of_federal_regulations/ibr_locations.html.

(2) The method referred to in paragraph (a) of this section is as follows: Use No. 8 and No. 20 sieves, having standard 8-inch full-height frames, complying with the specifications set forth in the AOAC, Table 1, "Nominal Dimensions of Standard Test Sieves (U.S.A. Standard Series)," under the heading "Definitions of Terms and Explanatory Notes," which is incorporated by reference. The availability of this incorporation by reference is given in paragraph (c)(1) of this section. Fit a No. 8 sieve into a No. 20 sieve. Attach bottom pan to the No. 20 sieve. Pour 100 gm. of the sample into the No. 8 sieve. Attach cover and hold the assembly in a slightly inclined position with one hand. Shake the sieves by striking the sides against the other hand with an upward stroke, at the rate of about 150 times per minute. Turn the sieves about one-sixth of a revolution each time in the same direction, after each 25 strokes. Continue shaking for 2 minutes. Weigh the material which fails to pass through the No. 8 sieve and the material which passes through the No. 20 sieve.

[42 FR 14402, Mar. 15, 1977, as amended at 47 FR 11827, Mar. 19, 1982; 47 FR 24693, June 8, 1982; 47 FR 43364, Oct. 1, 1982; 49 FR 10097, Mar. 19, 1984; 54 FR 24894, June 12, 1989; 58 FR 2877, Jan. 6, 1993]

§ 137.205 Bromated whole wheat flour.

Bromated whole wheat flour conforms to the definition and standard of identity, and is subject to the requirements for label statement of ingredients, prescribed for whole wheat flour by § 137.200, except that potassium bromate is added in a quantity not exceeding 75 parts to each million parts of finished bromated whole wheat flour.

[58 FR 2877, Jan. 6, 1993]

§ 137.211 White corn flour.

(a) White corn flour is the food prepared by so grinding and bolting cleaned white corn that when tested by the method prescribed in paragraph (b)(2) of this section, not less than 98 percent passes through a No. 50 sieve and not less than 50 percent passes through No. 70 woven-wire cloth. Its moisture content is not more than 15 percent. In its preparation, part of the ground corn may be removed, but in

any such case, the content (on a moisture-free basis) of neither the crude fiber nor fat in the finished white corn flour exceeds the content (on a moisture-free basis) of such substance in the cleaned corn from which it was ground.

(b)(1) For the purpose of this section, moisture, fat, and crude fiber are determined by methods therefore referred to in § 137.250(b)(1).

(2) The method referred to in paragraph (a) of this section is as follows: Weigh 5 grams of sample into a tared truncated metal cone (top diameter 5 centimeters, bottom diameter 2 centimeters, height 4 centimeters), fitted at bottom with 70-mesh wire cloth complying with the specifications for No. 70 wire cloth in "Official Methods of Analysis of the Association of Official Analytical Chemists," 13th Ed. (1980), Table 1, "Nominal Dimensions of Standard Test Sieves (U.S.A. Standard Series)," under the heading "Definitions of Terms and Explanatory Notes," which is incorporated by reference. Copies may be obtained from the AOAC INTERNATIONAL, 481 North Frederick Ave., suite 500, Gaithersburg, MD 20877, or may be examined at the National Archives and Records Administration (NARA). For information on the availability of this material at NARA, call 202-741-6030, or go to: http://www.archives.gov/federal_register/code_of_federal_regulations/ibr_locations.html. Attach cone to a suction flask. Wash with 150 ml. of petroleum ether applied in a small stream without suction, while gently stirring the sample with a small glass rod. Apply suction for 2 minutes after washing is completed, then shake the cone for 2 minutes with a vigorous horizontal motion, striking the side against the hand, and then weigh. The decrease in weight of sample, calculated as percent by weight of sample shall be considered the percent passing through No. 70 wire cloth. Transfer the residue from cone to a No. 50 sieve having a standard 20.3 centimeter (8-inch) diameter full-height frame, complying with the specifications for wire cloth and sieve frame in "Nominal Dimensions of Standard Test Sieves (U.S.A. Standard Series)." Shake for 2 minutes with a vigorous horizontal motion,

striking the side against the hand; remove and weigh the residue; calculate the weight of residue as percent by weight of sample, and subtract from 100 percent to obtain the percent of sample passing through the No. 50 sieve.

[42 FR 14402, Mar. 15, 1977, as amended at 47 FR 11827, Mar. 19, 1982; 49 FR 10098, Mar. 19, 1984; 54 FR 24894, June 12, 1989]

§ 137.215 Yellow corn flour.

Yellow corn flour conforms to the definition and standard of identity prescribed by §137.211 for white corn flour except that cleaned yellow corn is used instead of clean white corn.

§ 137.220 Durum flour.

(a) Durum flour is the food prepared by grinding and bolting cleaned durum wheat. When tested for granulation as prescribed in §137.105(c)(4), not less than 98 percent of such flour passes through the No. 70 sieve. It is freed from bran coat, or bran coat and germ, to such extent that the percent of ash therein, calculated to a moisture-free basis, is not more than 1.5 percent. Its moisture content is not more than 15 percent.

(b) For the purpose of this section, ash, moisture, and granulation are determined by the methods prescribed in §137.105(c).

§ 137.225 Whole durum flour.

Whole durum wheat flour conforms to the definition and standard of identity, and is subject to the requirements for label statement of ingredients, prescribed for whole wheat flour by §137.200, except that cleaned durum wheat, instead of cleaned wheat other than durum wheat and red durum wheat, is used in its preparation.

[58 FR 2877, Jan. 6, 1993]

§ 137.250 White corn meal.

(a) White corn meal is the food prepared by so grinding cleaned white corn that when tested by the method prescribed in paragraph (b)(2) of this section not less than 95 percent passes through a No. 12 sieve, not less than 45 percent through a No. 25 sieve, but not more than 35 percent through a No. 72 grits gauze. Its moisture content is not more than 15 percent. In its prepara-

tion coarse particles of the ground corn may be separated and discarded, or re-ground and recombined with all or part of the material from which they were separated, but in any such case the crude fiber content of the finished corn meal is not less than 1.2 percent and not more than that of the cleaned corn from which it was ground, and its fat content does not differ more than 0.3 percent from that of such corn. The contents of crude fiber and fat in all the foregoing provisions relating thereto are on a moisture-free basis.

(b)(1) For the purposes of this section, moisture, fat, and crude fiber content will be determined by the following methods of analysis from "Official Methods of Analysis of the Association of Official Analytical Chemists," 13th Ed. (1980), which is incorporated by reference (copies may be obtained from the AOAC INTERNATIONAL, 481 North Frederick Ave., suite 500, Gaithersburg, MD 20877, or may be examined at the National Archives and Records Administration (NARA). For information on the availability of this material at NARA, call 202-741-6030, or go to: http://www.archives.gov/federal_register/code_of_federal_regulations/ibr_locations.html):

(i) Moisture content—sections 14.062 and 14.063 (Official Final Action).

(ii) Fat content—sections 14.062 and 14.067 (Official Final Action).

(iii) Crude fiber content—sections 14.062 and 14.065 (Official Final Action).

(2) The method referred to in paragraph (a) of this section is as follows: Use No. 12 and No. 25 sieves, having standard 20.3 centimeter (8-inch) diameter full-height frames, complying with the specifications for wire cloth and sieve frames in "Nominal Dimensions of Standard Test Sieves (U.S.A. Standard Series)" prescribed in §137.105(a), which is incorporated by reference. Copies may be obtained from the AOAC INTERNATIONAL, 481 North Frederick Ave., suite 500, Gaithersburg, MD 20877, or may be examined at the National Archives and Records Administration (NARA). For information on the availability of this material at NARA, call 202-741-6030, or go to: http://www.archives.gov/federal_register/code_of_federal_regulations/

§ 137.255

21 CFR Ch. I (4-1-07 Edition)

ibr_locations.html. A sieve with frame of the same dimensions as the Nos. 12 and 25 and fitted with 72 XXX grits gauze is used as the third sieve. It is referred to hereafter as the No. 72 sieve. The 72 XXX grits gauze has openings equivalent in size with those of No. 70 woven-wire cloth, complying with specifications for such cloth contained in such "Standard Specifications for Sieves." Attach bottom pan to No. 72 sieve. Fit the No. 25 sieve into the No. 72 sieve and the No. 12 sieve into the No. 25 sieve. Pour 100 grams of sample into the No. 12 sieve, attach cover and hold the assembly in a slightly inclined position and shake the assembly of sieves by striking the sides against one hand with an upward stroke, at the rate of about 150 times per minute. Turn the assembly of sieves about one-sixth of a revolution, each time in the same direction, after each 25 strokes. Continue shaking for 2 minutes. Weigh separately the material remaining on each sieve and in the pan, and calculate each weight as percent of sample. Sometimes when meals are tested, fine particles clog the sieve openings. If any sieve is clogged by fine material smaller than its openings, empty the contents onto a piece of paper. Remove the entrapped material on the bottom of the sieve by a hair brush and add to the sieve below. In like manner, clean the adhering material from inside the sieve and add to the material on the paper. Return mixture on the paper to the sieve, reassemble the sieves, and shake in the same manner as before for 1 minute. Repeat cleaning procedure if necessary until a 5-gram or less loss in weight occurs in any sieve during a 1-minute shaking. The percent of sample passing through No. 12 sieve shall be determined by subtracting from 100 percent, the percent of material remaining on the No. 12 sieve. The percent passing through a No. 25 sieve shall be determined by adding the percents remaining on the No. 72 sieve and the percent in pan. The percent in the pan shall be considered as the percent passing through a No. 72 XXX grits gauze.

[42 FR 14402, Mar. 15, 1977, as amended at 47 FR 11828, Mar. 19, 1982; 49 FR 10098, Mar. 19, 1984; 54 FR 24894, June 12, 1989]

§ 137.255 Bolted white corn meal.

(a) Bolted white corn meal is the food prepared by so grinding and sifting cleaned white corn that:

(1) Its crude fiber content is less than 1.2 percent but its fat content is not less than 2.25 percent; and

(2) When tested by the method prescribed in §137.250(b)(2), except that a No. 20 standard sieve is used instead of the No. 12 sieve, not less than 95 percent passes through a No. 20 sieve, not less than 45 percent through a No. 25 sieve, but not more than 25 percent through No. 72 XXX grits gauze. Its moisture content is not more than 15 percent. In its preparation particles of ground corn which contain germ may be separated, reground, and recombined with all or part of the material from which it was separated, but in any such case the fat content of the finished bolted white corn meal does not exceed by more than 0.3 percent the fat content of the cleaned corn from which it was ground. The contents of crude fiber and fat in all the foregoing provisions relating thereto are on a moisture-free basis.

(b) For the purposes of this section, moisture, fat and crude fiber are determined by the methods therefor referred to in § 137.250(b)(1).

§ 137.260 Enriched corn meals.

(a) Enriched corn meals are the foods, each of which conforms to the definition and standard of identity prescribed for a kind of corn meal by §§ 137.250, 137.255, 137.265, 137.270, 137.275, 137.280, 137.285, and 137.290, except that:

(1) It contains in each pound not less than 2.0 milligrams (mg) and not more than 3.0 mg of thiamin, not less than 1.2 mg and not more than 1.8 mg of riboflavin, not less than 16 mg and not more than 24 mg of niacin or niacinamide, not less than 0.7 mg and not more than 1.0 mg of folic acid, and not less than 13 mg and not more than 26 mg of iron (Fe);

(2) It may contain in each pound not less than 250 U.S.P. units and not more than 1,000 U.S.P. units of vitamin D; and

(3) It may contain in each pound not less than 500 milligrams and not more than 750 milligrams of calcium (Ca); *Provided, however,* That enriched self-

rising corn meals shall contain in each pound not more than 1,750 milligrams of calcium (Ca). Iron and calcium may be added only in forms which are harmless and assimilable. The substances referred to in this paragraph (a)(3) and in paragraphs (a) (1) and (2) of this section may be added in a harmless carrier which does not impair the enriched corn meal; such carrier is used only in the quantity necessary to effect an intimate and uniform admixture of such substances with the kind of corn meal used. Dried yeast in quantities not exceeding 1.5 percent by weight of the finished food may be used.

(b) The name of each kind of enriched corn meal is the word "Enriched" followed by the name of the kind of corn meal used which is prescribed in the definition and standard of identity therefor.

(c) *Label declaration.* Each of the ingredients used in the food shall be declared on the label as required by the applicable sections of parts 101 and 130 of this chapter.

[42 FR 14402, Mar. 15, 1977, as amended at 58 FR 2878, Jan. 6, 1993; 61 FR 8796, Mar. 5, 1996]

§ 137.265 Degerminated white corn meal.

(a) Degerminated white corn meal, depermed white corn meal, is the food prepared by grinding cleaned white corn and removing bran and germ so that:

(1) On a moisture-free basis, its crude fiber content is less than 1.2 percent and its fat content is less than 2.25 percent; and

(2) When tested by the method prescribed in §137.250(b)(2), except that a No. 20 standard sieve is used instead of a No. 12 sieve, not less than 95 percent passes through a No. 20 sieve, not less than 45 percent through a No. 25 sieve, but not more than 25 percent through No. 72 XXX grits gauze. Its moisture content is not more than 15 percent.

(b) For the purposes of this section, moisture, fat and crude fiber are determined by methods therefor referred to in §137.250(b)(1).

§ 137.270 Self-rising white corn meal.

(a) Self-rising white corn meal is an intimate mixture of white corn meal, sodium bicarbonate, and one or both of

the acid-reacting substances monocalcium phosphate and sodium aluminum phosphate. It is seasoned with salt. When it is tested by the method prescribed in paragraph (b) of this section, not less than 0.5 percent of carbon dioxide is evolved. The acid-reacting substance is added in sufficient quantity to neutralize the sodium bicarbonate. The combined weight of such acid-reacting substance and sodium bicarbonate is not more than 4.5 parts to each 100 parts of white corn meal used.

(b) The method referred to in paragraph (a) of this section is the method prescribed in "Official Methods of Analysis of the Association of Official Analytical Chemists" (AOAC), 13th Ed. (1980), section 8.002, "Reagent (Displacement soln.)," and section 8.003, "Chittick apparatus," under the heading "Total Carbon Dioxide (1)—Official Final Action," which is incorporated by reference. Copies may be obtained from the AOAC INTERNATIONAL, 481 North Frederick Ave., suite 500, Gaithersburg, MD 20877, or may be examined at the National Archives and Records Administration (NARA). For information on the availability of this material at NARA, call 202-741-6030, or go to: http://www.archives.gov/federal_register/code_of_federal_regulations/ibr_locations.html. The following procedure is substituted for the procedure specified in the AOAC, under section 8.004, "Determination":

(1) Weigh 17 grams of the official sample into flask *A*, add 15–20 glass beads (4–6 mm. diameter), and connect this flask with the apparatus (fig. 25). Open stopcock *C* and by means of the leveling bulb *E* bring the displacement solution to the 25 cc. graduation above the zero mark. (This 25 cc. is a partial allowance for the volume of acid to be used in the decomposition.) Allow the apparatus to stand 1–2 minutes to insure that the temperature and pressure within the apparatus are the same as those of the room. Close the stopcock, lower the leveling bulb somewhat to reduce the pressure within the apparatus, and slowly run into the decomposition flask from burette *F* 45 cc. of sulfuric acid (1+5). To prevent the liberated carbon dioxide from escaping through the

§ 137.275

acid burette into the air keep the displacement solution in the leveling bulb at all times during the decomposition at a lower level than that in the gas-measuring tube. Rotate and then vigorously agitate the decomposition flask for 3 minutes to mix the contents intimately. Allow to stand for 10 minutes to bring to equilibrium. Equalize the pressure in the measuring tube by means of the leveling bulb and read the volume of gas from the zero point on the tube. Deduct 20 cc. from this reading (this 20 cc. together with previous allowance of 25 cc. compensates for the 45 cc. acid used in the decomposition). Observe the temperature of the air surrounding the apparatus and also the barometric pressure and multiply the number of mL of gas evolved by the factor given in the AOAC, 13th Ed. (1980), section 52.007 under Reference Tables for the temperature and pressure observed, which is incorporated by reference. The availability of this incorporation by reference is given in paragraph (b) of this section. Divide the corrected reading by 100 to obtain the apparent percent by weight of carbon dioxide in the official sample.

(2) Correct the apparent percent of carbon dioxide to compensate for varying atmospheric conditions by immediately assaying a synthetic sample by the same method in the same apparatus.

(3) Prepare the synthetic sample with 16.2 grams of corn meal, 0.30 gram of monocalcium phosphate, 0.30 gram of salt, and a sufficient quantity of sodium bicarbonate U.S.P. (dried over sulfuric acid) to yield the amount of carbon dioxide recovered in assay of official sample. Determine this quantity by multiplying weight of carbon dioxide recovered in assay of official sample by 1.91.

(4) Divide the weight of carbon dioxide recovered from synthetic sample by weight of carbon dioxide contained in sodium bicarbonate used.

(5) Divide the quotient into the apparent percent of carbon dioxide in official sample to obtain percent of carbon dioxide evolved from the official sample.

(c) *Label declaration.* Each of the ingredients used in the food shall be declared on the label as required by the

21 CFR Ch. I (4-1-07 Edition)

applicable sections of parts 101 and 130 of this chapter.

[42 FR 14402, Mar. 15, 1977, as amended at 47 FR 11828, Mar. 19, 1982; 49 FR 10098, Mar. 19, 1984; 54 FR 24894, June 12, 1989; 58 FR 2878, Jan. 6, 1993]

§ 137.275 Yellow corn meal.

Yellow corn meal conforms to the definition and standard of identity prescribed by §137.250 for white corn meal except that cleaned yellow corn is used instead of cleaned white corn.

§ 137.280 Bolted yellow corn meal.

Bolted yellow corn meal conforms to the definition and standard of identity prescribed by §137.255 for bolted white corn meal except that cleaned yellow corn is used instead of cleaned white corn.

§ 137.285 Degerminated yellow corn meal.

Degerminated yellow corn meal, degermed yellow corn meal, conforms to the definition and standard of identity prescribed by §137.265 for degerminated white corn meal except that cleaned yellow corn is used instead of cleaned white corn.

§ 137.290 Self-rising yellow corn meal.

Self-rising yellow corn meal conforms to the definition and standard of identity prescribed by §137.270 for self-rising white corn meal except that yellow corn meal is used instead of white corn meal.

§ 137.300 Farina.

(a) Farina is the food prepared by grinding and bolting cleaned wheat, other than durum wheat and red durum wheat, to such fineness that, when tested by the method prescribed in paragraph (b)(2) of this section, it passes through a No. 20 sieve, but not more than 3 percent passes through a No. 100 sieve. It is freed from bran coat, or bran coat and germ, to such extent that the percent of ash therein, calculated to a moisture-free basis, is not more than 0.6 percent. Its moisture content is not more than 15 percent.

(b) For the purposes of this section:

(1) Ash and moisture are determined by the methods therefor referred to in §137.105(c).

(2) The method referred to in paragraph (a) of this section is as follows: Use No. 20 and No. 100 sieves, having standard 20.3 centimeter (8-inch) full-height frames, complying with the specifications for such cloth set forth in "Official Methods of Analysis of the Association of Official Analytical Chemists," 13th Ed. (1980), Table 1, "Nominal Dimensions of Standard Test Sieves (U.S.A. Standard Series)," under the heading "Definitions of Terms and Explanatory Notes," which is incorporated by reference. Copies may be obtained from the AOAC INTERNATIONAL, 481 North Frederick Ave., suite 500, Gaithersburg, MD 20877, or may be at the National Archives and Records Administration (NARA). For information on the availability of this material at NARA, call 202-741-6030, or go to: http://www.archives.gov/federal_register/code_of_federal_regulations/ibr_locations.html. Fit a No. 20 sieve into a No. 100 sieve. Attach bottom pan to the No. 100 sieve. Pour 100 grams of the sample into the No. 20 sieve. Attach cover and hold the assembly in a slightly inclined position with one hand. Shake the sieves by striking the sides against the other hand with an upward stroke, at the rate of about 150 times per minute. Turn the sieves about one-sixth of a revolution, each time in the same direction, after each 25 strokes. Continue shaking for 2 minutes. Weigh the material which fails to pass through the No. 20 sieve and the material which passes through the No. 100 sieve.

[42 FR 14402, Mar. 15, 1977, as amended at 47 FR 11828, Mar. 19, 1982; 49 FR 10098, Mar. 19, 1984; 54 FR 24894, June 12, 1989]

§ 137.305 Enriched farina.

(a) Enriched farina conforms to the definition and standard of identity prescribed for farina by § 137.300, except that:

(1) It contains in each pound not less than 2.0 milligrams (mg) and not more than 2.5 mg of thiamin, not less than 1.2 mg and not more than 1.5 mg of riboflavin, not less than 16.0 mg and not more than 20.0 mg of niacin or niacinamide, not less than 0.7 mg and not more than 0.87 mg of folic acid, and not less than 13.0 mg of iron (Fe).

(2) Vitamin D may be added in such quantity that each pound of the finished enriched farina contains not less than 250 U.S.P. units of the optional ingredient vitamin D.

(3) Calcium may be added in such quantity that each pound of the finished enriched farina contains not less than 500 milligrams of the optional ingredient calcium (Ca).

(4) It may contain not more than 8 percent by weight of the optional ingredient wheat germ or partly defatted wheat germ.

(5)(i) It may contain not less than 0.5 percent and not more than 1 percent by weight of the optional ingredient disodium phosphate; or

(ii) It may be treated with one of the proteinase enzymes papain or pepsin to reduce substantially the time required for cooking. In such treatment papain or pepsin, in an amount not to exceed 0.1 percent by weight, is added to the farina, which is moistened, warmed, and subsequently heated sufficiently to inactivate the enzyme and to dry the product to comply with the limit for moisture prescribed by § 137.300(a).

(6) In determining whether the ash content complies with the requirements of this section allowance is made for ash resulting from any added iron or salts of iron or calcium, or from any added disodium phosphate, or from any added wheat germ or partly defatted wheat germ.

Iron and calcium may be added only in forms which are harmless and assimilable. Dried irradiated yeast may be used as a source of vitamin D. The substances referred to in paragraphs (a) (1) and (2) of this section may be added in a harmless carrier which does not impair the enriched farina; such carrier is used only in the quantity necessary to effect an intimate and uniform admixture of such substances with the farina.

(b)(1) Label declaration. Each of the ingredients used in the food shall be declared on the label as required by the applicable sections of parts 101 and 130 of this chapter.

(2)(i) When the optional ingredient disodium phosphate is used, the label shall bear the statement "Disodium phosphate added for quick cooking".

(ii) When the proteinase enzyme treatment is used, the label shall bear

§ 137.320

21 CFR Ch. I (4-1-07 Edition)

the statement “Enzyme treated for quicker cooking”.

(3) Wherever the name of the food appears on the label so conspicuously as to be easily seen under customary conditions of purchase, the statements prescribed by paragraph (b)(2) of this section shall immediately and conspicuously precede or follow such name without intervening written, printed, or graphic matter; except that where the name of the food is a part of a trademark or brand, then other written, printed, or graphic matter that is also a part of the trademark or brand may so intervene, if such statement is in such juxtaposition with the trademark or brand as to be conspicuously related to the name of the food.

[42 FR 14402, Mar. 15, 1977, as amended at 58 FR 2878, Jan. 6, 1993; 61 FR 8796, Mar. 5, 1996]

§ 137.320 Semolina.

(a) Semolina is the food prepared by grinding and bolting cleaned durum wheat to such fineness that, when tested by the method prescribed in §137.300(b)(2), it passes through a No. 20 sieve, but not more than 3 percent passes through a No. 100 sieve. It is freed from bran coat, or bran coat and germ, to such extent that the percent of ash therein, calculated to a moisture-free basis, is not more than 0.92 percent. Its moisture content is not more than 15 percent.

(b) For the purpose of this section, ash and moisture are determined by the methods therefor referred to in §137.105(c).

§ 137.350 Enriched rice.

(a) The foods for which definitions and standards of identity are prescribed by this section are forms of milled rice (except rice coated with talc and glucose and known as coated rice), to which nutrients have been added so that each pound of the rice contains:

(1) Not less than 2.0 milligrams (mg) and not more than 4.0 mg of thiamin, not less than 1.2 mg and not more than 2.4 mg of riboflavin, not less than 16 mg and not more than 32 mg of niacin or niacinamide, not less than 0.7 mg and not more than 1.4 mg of folic acid, and not less than 13 mg and not more than 26 mg of iron (Fe).

(2) Each pound may contain not less than 250 U.S.P. units and not more than 1,000 U.S.P. units of vitamin D.

(3) Each pound may contain not less than 500 milligrams and not more than 1,000 milligrams of calcium (Ca). Calcium carbonate derived from the use of this substance in milling rice, when present in quantities that furnish less than 500 milligrams of calcium (Ca) per pound, is considered a normal ingredient of the milled rice used and not an optional ingredient of the enriched rice unless such enriched rice is labeled to show it contains the optional ingredient calcium. Iron and calcium may be added only in forms that are harmless and assimilable. The vitamins referred to in paragraphs (a) (1) and (2) of this section may be combined with harmless substances to render them insoluble in water, if the water-insoluble products are assimilable.

(4) In the case of enriched parboiled rice, butylated hydroxytoluene may be added as an optional ingredient in an amount not to exceed 0.0033 percent by weight of the finished food.

(b) The substances referred to in paragraphs (a) (1), (2), and (3) of this section may be added in a harmless carrier. Such carrier is used only in the quantity necessary to effect an intimate and uniform mixture of such substances with the rice.

(c) Unless the label of the food bears the statement “To retain vitamins do not rinse before or drain after cooking” immediately preceding or following the name of the food and in letters not less than one-fourth the point size of type used for printing the name of the food (but in no case less than 8-point type) and the label bears no cooking directions calling for washing or draining or unless the food is precooked and it is packaged in consumer packages which are conspicuously and prominently labeled with directions for preparation which, if followed, will avoid washing away or draining off enriching ingredients, the substances named in paragraphs (a) (1), (2), and (3) of this section shall be present in such quantity or in such form that when the enriched rice is washed as prescribed in paragraph (e) of this section, the washed rice contains not less than 85 percent of the minimum quantities of the substances

named in paragraph (a)(1) of this section, as required for enriched rice; and in case any optional ingredients named in paragraphs (a) (2) and (3) of this section are used, the washed rice also contains not less than 85 percent of the minimum quantity specified for the substance or substances used.

(d) The name specified for each food for which a definition and standard of identity is prescribed by this section is the common name of the kind of milled rice to which the enriching substances are added, preceded by the word "enriched" as, for example, "Enriched rice" or "Enriched parboiled rice".

(e) The method referred to in paragraph (c) of this section is as follows: Mix the contents of one or more containers and transfer ½ pound thereof to a 4-liter flask containing 2 liters of distilled water at room temperature (but not below 20 °C). Stopper the flask and swirl it moderately for ½ minute so that the rice is in motion and in uniform suspension. Allow the rice to settle for ½ minute, then pour off 1,600 milliliters of the water, together with any floating and suspended matter, and discard. To the contents of the flask, add 1,600 milliliters of distilled water and 20 milliliters of 10 N hydrochloric acid. Agitate vigorously and wash down the sides of the flask with 150 milliliters of 0.1 N hydrochloric acid. In order to avoid excess foaming during the extraction, heat the mixture slowly to about 100 °C, agitate if necessary, and maintain at this temperature until air is expelled. Again wash down the sides of the flask with 150 milliliters of 0.1 N hydrochloric acid. Heat the mixture in an autoclave at 120 °C to 123 °C for 30 minutes, remove and cool to room temperature. Dilute the mixture with distilled water so that the total volume is 2,500 milliliters. Swirl the flask, and while the solids are in uniform suspension pour off about 250 milliliters of the mixture for later determination of iron (and calcium, if this is to be determined). With filter paper that has been shown not to adsorb thiamine, riboflavin, or niacin, filter enough of the remaining mixture for determination of thiamine, riboflavin, and niacin. (In the case of a mixture difficult to filter, centrifuging or filtering through fritted glass, or both,

using a suitable analytical filter-aid, may be substituted for, or may precede, filtering through paper.) Dilute an aliquot of filtrate with 0.1 N hydrochloric acid, so that each milliliter contains about 0.2 microgram of thiamine, and determine thiamine by the "Rapid Fluorometric Method—Official Final Action," in section 43.034 of "Official Methods of Analysis of the Association of Official Analytical Chemists" (AOAC), 13th Ed. (1980), which is incorporated by reference. Copies may be obtained from the AOAC INTERNATIONAL, 481 North Frederick Ave., suite 500, Gaithersburg, MD 20877, or may be examined at the National Archives and Records Administration (NARA). For information on the availability of this material at NARA, call 202-741-6030, or go to: http://www.archives.gov/federal_register/code_of_federal_regulations/ibr_locations.html. With a suitable aliquot determine riboflavin by the method prescribed in section 43.041(a) by the "Fluorometric Method—Official Final Action," AOAC, 13th Ed. (1980), beginning with the third sentence of the second paragraph, "Adjust, with vigorous agitation * * *." Determine niacin in a 200-milliliter aliquot of the filtrate by the "Colorimetric Method—Official Final Action," in section 43.045, AOAC, 13th Ed. (1980), beginning with the sixth sentence of the first paragraph, "Adjust to pH 4.5 with * * *." Evaporate to dryness a 100-milliliter aliquot of the nonfiltered material withdrawn while agitating, and determine iron using the method "Iron—Official Final Action," in sections 14.011, 14.012, and 14.013, AOAC, 13th Ed. (1980), and, if required, determine calcium as directed in section 14.014 under the heading "Calcium—Official Final Action," AOAC, 13th Ed. (1980).

(f) When the optional ingredient specified in paragraph (a)(4) of this section is added, the statement "Butylated hydroxytoluene added as a preservative" shall be placed on the label prominently and with such conspicuousness (as compared with other words, statements, designs, or devices in the label) as to render it likely to be read and understood by the ordinary individual under customary conditions of purchase.

(g) *Label declaration.* Each of the ingredients used in the food shall be declared on the label as required by the applicable sections of parts 101 and 130 of this chapter.

NOTE: The Order of the Commissioner of Food and Drugs appearing at 23 FR 1170, Feb. 25, 1958, amending paragraphs (a)(1) and (c) provides in part as follows: The regulations in §137.350 (formerly §15.525) are stayed insofar as they require each pound of the food to contain not less than 1.2 milligrams and not more than 2.4 milligrams of riboflavin. This stay shall continue until final action is taken disposing of the objections, after public hearing thereon.

[42 FR 14402, Mar. 15, 1977, as amended at 47 FR 11828, Mar. 19, 1982; 49 FR 10098, Mar. 19, 1984; 54 FR 24894, June 12, 1989; 58 FR 2878, Jan. 6, 1993; 61 FR 8796, Mar 5, 1996]

PART 139—MACARONI AND NOODLE PRODUCTS

Subpart A [Reserved]

Subpart B—Requirements for Specific Standardized Macaroni and Noodle Products

Sec.

- 139.110 Macaroni products.
- 139.115 Enriched macaroni products.
- 139.117 Enriched macaroni products with fortified protein.
- 139.120 Milk macaroni products.
- 139.121 Nonfat milk macaroni products.
- 139.122 Enriched nonfat milk macaroni products.
- 139.125 Vegetable macaroni products.
- 139.135 Enriched vegetable macaroni products.
- 139.138 Whole wheat macaroni products.
- 139.140 Wheat and soy macaroni products.
- 139.150 Noodle products.
- 139.155 Enriched noodle products.
- 139.160 Vegetable noodle products.
- 139.165 Enriched vegetable noodle products.
- 139.180 Wheat and soy noodle products.

AUTHORITY: 21 U.S.C. 321, 341, 343, 348, 371, 379e.

SOURCE: 42 FR 14409, Mar. 15, 1977, unless otherwise noted.

Subpart A [Reserved]

Subpart B—Requirements for Specific Standardized Macaroni and Noodle Products

§ 139.110 Macaroni products.

(a) Macaroni products are the class of food each of which is prepared by drying formed units of dough made from semolina, durum flour, farina, flour, or any combination of two or more of these, with water and with or without one or more of the optional ingredients specified in paragraphs (a) (1) to (6), inclusive, of this section.

(1) Egg white, frozen egg white, dried egg white, or any two or all of these, in such quantity that the solids thereof are not less than 0.5 percent and not more than 2.0 percent of the weight of the finished food.

(2) Disodium phosphate, in a quantity not less than 0.5 percent and not more than 1.0 percent of the weight of the finished food.

(3) Onions, celery, garlic, bay leaf, or any two or more of these, in a quantity which seasons the food.

(4) Salt, in a quantity which seasons the food.

(5) Gum gluten, in such quantity that the protein content of the finished food is not more than 13 percent by weight. The finished macaroni product contains not less than 87 percent of total solids as determined by the method prescribed in “Official Methods of Analysis of the Association of Official Analytical Chemists,” 13th Ed. (1980), in section 14.133, under the heading “Vacuum Oven Method—Official Final Action,” which is incorporated by reference. Copies may be obtained from the AOAC INTERNATIONAL, 481 North Frederick Ave., suite 500, Gaithersburg, MD 20877, or may be examined at the National Archives and Records Administration (NARA). For information on the availability of this material at NARA, call 202–741–6030, or go to: http://www.archives.gov/federal_register/code_of_federal_regulations/ibr_locations.html.

(6) Concentrated glyceryl monostearate (containing not less than 90 percent monoester), in a quantity not exceeding 2 percent by weight of the finished food.

(b) Macaroni is the macaroni product the units of which are tube-shaped and

more than 0.11 inch but not more than 0.27 inch in diameter.

(c) Spaghetti is the macaroni product the units of which are tube-shaped or cord-shaped (not tubular) and more than 0.06 inch but not more than 0.11 inch in diameter.

(d) Vermicelli is the macaroni product the units of which are cord-shaped (not tubular) and not more than 0.06 inch in diameter.

(e) The name of each food for which a definition and standard of identity is prescribed by this section is "Macaroni product"; or alternatively, the name is "Macaroni", "Spaghetti", or "Vermicelli", as the case may be, when the units of the food are of the shapes and sizes specified in paragraph (b), (c), or (d), respectively, of this section.

(f)(1) When disodium phosphate is used the label shall bear the statement "Disodium phosphate added for quick cooking".

(2) When any ingredient specified in paragraph (a)(3) of this section is used the label shall bear the statement "Seasoned with _____", the blank being filled in with the common name of the ingredient; or in the case of bay leaves the statement "Spiced", "Spice added", or "Spiced with bay leaves".

(3) When the ingredient specified in paragraph (a)(6) of this section is used, the label shall bear the statement "Glyceryl monostearate added" or the statement "With added glyceryl monostearate".

(4) Wherever the name of the food appears on the label so conspicuously as to be easily seen under customary conditions of purchase, the words and statements prescribed in this section, showing the optional ingredients used, shall immediately and conspicuously precede or follow, or in part precede and in part follow, such name, without intervening written, printed, or graphic matter.

(g) Label declaration. Each of the ingredients used in the food shall be declared on the label as required by the applicable sections of parts 101 and 130 of this chapter.

[42 FR 14409, Mar. 15, 1977, as amended at 47 FR 11828, Mar. 19, 1982; 49 FR 10099, Mar. 19, 1984; 54 FR 24894, June 12, 1989; 58 FR 2878, Jan. 6, 1993; 63 FR 14035, Mar. 24, 1998]

§ 139.115 Enriched macaroni products.

(a) Description. Enriched macaroni products are the class of food each of which conforms to the definition and standard of identity and is subject to the requirements for label statement of ingredients, prescribed for macaroni products by §139.110(a), (f), and (g), except that:

(1) Each such food contains in each pound not less than 4.0 milligrams (mg) and not more than 5.0 mg of thiamin, not less than 1.7 mg and not more than 2.2 mg of riboflavin, not less than 27 mg and not more than 34 mg of niacin or niacinamide, not less than 0.9 mg and not more than 1.2 mg of folic acid, and not less than 13 mg and not more than 16.5 mg of iron (Fe);

(2) Each such food may also contain as an optional ingredient added vitamin D in such quantity that each pound of the finished food contains not less than 250 U.S.P. units and not more than 1000 U.S.P. units of vitamin D.

(3) Each such food may also contain as an optional ingredient added calcium in such quantity that each pound of the finished food contains not less than 500 mg. and not more than 625 mg. of calcium (Ca);

(4) Each such food may also contain as an optional ingredient partly defatted wheat germ but the amount thereof does not exceed 5 percent of the weight of the finished food;

(5) Each such food may be supplied, wholly or in part, with the prescribed quantity of any substance referred to in paragraphs (a) (1), (2), and (3) of this section through the use of dried yeast, dried torula yeast, partly defatted wheat germ, enriched farina, or enriched flour, or through the direct additions of any of the substances prescribed in paragraphs (a) (1), (2), and (3) of this section.

Iron and calcium may be added only in forms which are harmless and assimilable. The substances referred to in paragraphs (a) (1) and (2) of this section may be added in a harmless carrier which does not impair the enriched macaroni product, such carrier being used only in the quantity reasonably necessary to effect an intimate and

uniform distribution of such substances in the finished enriched macaroni product.

(b) Enriched macaroni is the enriched macaroni product the units of which conform to the specifications of shape and size prescribed for macaroni by § 139.110(b).

(c) Enriched spaghetti is the enriched macaroni product the units of which conform to the specifications of shape and size prescribed for spaghetti by § 139.110(c).

(d) Enriched vermicelli is the enriched macaroni product the units of which conform to the specifications of shape and size prescribed for vermicelli by § 139.110(d).

(e) The name of each food for which a definition and standard of identity is prescribed by this section is "Enriched Macaroni product"; or alternatively, the name is "Enriched macaroni", "Enriched spaghetti", or "Enriched vermicelli", as the case may be, when the units of the food comply with the requirements of paragraphs (b), (c), or (d) respectively of this section.

[42 FR 14409, Mar. 15, 1977, as amended at 58 FR 2878, Jan. 6, 1993; 61 FR 8797, Mar. 5, 1996]

§ 139.117 Enriched macaroni products with fortified protein.

(a)(1) Each of the foods for which a standard of identity is prescribed by this section is produced by drying formed units of dough made with one or more of the milled wheat ingredients designated in §§ 139.110(a) and 139.138(a), and other ingredients to enable the finished food to meet the protein requirements set out in paragraph (a)(2)(i) of this section. Edible protein sources, including food grade flours or meals made from nonwheat cereals or from oilseeds, may be used. Vitamin and mineral enrichment nutrients are added to bring the food into conformity with the requirements of paragraph (b) of this section. Safe and suitable ingredients, as provided for in paragraph (c) of this section, may be added. The proportion of the milled wheat ingredient is larger than the proportion of any other ingredient used.

(2) Each such finished food, when tested by the methods described in the cited sections of "Official Methods of Analysis of the Association of Official

Analytical Chemists," 13th Ed. (1980), which is incorporated by reference (copies may be obtained from the AOAC INTERNATIONAL, 481 North Frederick Ave., suite 500, Gaithersburg, MD 20877, or may be examined at the National Archives and Records Administration (NARA). For information on the availability of this material at NARA, call 202-741-6030, or go to: http://www.archives.gov/federal_register/code_of_federal_regulations/ibr_locations.html), meets the following specifications:

(i) The protein content ($N \times 6.25$) is not less than 20 percent by weight (on a 13 percent moisture basis) as determined by the method in section 14.142. The protein quality is not less than 95 percent that of casein as determined on the cooked food by the method in sections 43.212 through 43.216 of the official methods.

(ii) The total solids content is not less than 87 percent by weight as determined by the method in section 14.133 of the official methods.

(b)(1) Each food covered by this section contains in each pound 5 milligrams of thiamin, 2.2 milligrams of riboflavin, 34 milligrams of niacin or niacinamide, and 16.5 milligrams of iron.

(2) Each pound of such food may also contain 625 milligrams of calcium.

(3) Iron and calcium may be added only in forms which are harmless and assimilable. The enrichment nutrients may be added in a harmless carrier used only in a quantity necessary to effect a uniform distribution of the nutrients in the finished food. The requirements of paragraphs (b) (1) and (2) of this section shall be deemed to have been met if reasonable overages, within the limits of good manufacturing practice, are present to assure that the prescribed levels of the vitamins and mineral(s) are maintained throughout the expected shelf life of the food under customary conditions of distribution.

(c) The safe and suitable ingredients referred to in paragraph (a) of this section are ingredients that serve a useful purpose, e.g., to fortify the protein or facilitate production of the food, but they do not include color additives, artificial flavorings, artificial sweeteners, chemical preservatives, or starches. Ingredients deemed suitable

for use by this paragraph are added in amounts that are not in excess of those reasonably required to achieve their intended purposes. Ingredients are deemed to be safe if they are not food additives within the meaning of section 201(s) of the Federal Food, Drug, and Cosmetic Act, or in case they are food additives, if they are used in conformity with regulations established pursuant to section 409 of the act.

(d)(1) The name of any food covered by this section is "Enriched Wheat _____ Macaroni Product—with Fortified Protein", the blank being filled in with appropriate word(s) such as "Soy" to show the source of any flours or meals used that were made from nonwheat cereals or from oilseeds. In lieu of the words "Macaroni Product" the word "Macaroni", "Spaghetti", or "Vermicelli", as appropriate, may be used if the units conform in shape and size to the requirements of § 139.110 (b), (c), or (d).

(2) When any ingredient, not designated in the part of the name prescribed in paragraph (d)(1) of this section, is added in such proportion as to contribute 10 percent or more of the quantity of protein contained in the finished food, the name shall include the statement "Made with _____", the blank being filled in with the name of each such ingredient, e.g., "Made with nonfat milk".

(3) When, in conformity with paragraph (d) (1) or (2) of this section, two or more ingredients are listed in the name, their designations shall be arranged in descending order of predominance by weight.

(4) In the case of a food made to comply with another section of this part, but which also meets the compositional requirements of this section, it may alternatively bear the name set out in that other section.

(e) Label declaration. Each of the ingredients used in the food shall be declared on the label as required by the applicable sections of parts 101 and 130 of this chapter.

[42 FR 14409, Mar. 15, 1977, as amended at 47 FR 11829, Mar. 19, 1982; 49 FR 10099, Mar. 19, 1984; 54 FR 24894, June 12, 1989; 58 FR 2878, Jan. 6, 1993; 63 FR 14035, Mar. 24, 1998]

EFFECTIVE DATE NOTE: Section 139.117 was stayed in its entirety at 43 FR 11695, Mar. 21, 1978.

§ 139.120 Milk macaroni products.

(a) Milk macaroni products are the class of food, each of which conforms to the definition and standard of identity and is subject to the requirements for label statement of ingredients prescribed for macaroni products by § 139.110(a), (f)(2), (f)(3), and (g), except that:

(1) Milk is used as the sole moistening ingredient in preparing the dough; or in lieu of milk one or more of the milk ingredients specified in paragraph (f) of this section is used, with or without water, in such quantity that the weight of milk solids therein is not less than 3.8 percent of the weight of the finished milk macaroni product; and

(2) None of the optional ingredients permitted by § 139.110(a) (1) and (2) is used. When the optional ingredient gum gluten (§ 139.110(a)(5)) is added, the quantity is such that the protein derived therefrom, together with the protein derived from semolina, durum flour, farina, flour, or any combination of these used, does not exceed 13 percent of the weight of the finished food.

(b) Milk macaroni is the milk macaroni product the units of which conform to the specifications of shape and size prescribed for macaroni by § 139.110(b).

(c) Milk spaghetti is the milk macaroni product the units of which conform to the specifications of shape and size prescribed for spaghetti by § 139.110(c).

(d) Milk vermicelli is the milk macaroni product the units of which conform to the specifications of shape and size prescribed for vermicelli by § 139.110(d).

(e) The name of each food for which a definition and standard of identity is prescribed by this section is "Milk Macaroni Product"; or alternatively, the name is "Milk macaroni", "Milk spaghetti", or "Milk vermicelli", as the case may be, when the units of the food comply with the requirements of paragraph (b), (c), or (d), respectively, of this section.

§ 139.121

(f) The milk ingredients referred to in paragraph (a)(1) of this section are concentrated milk, evaporated milk, dried milk, and a mixture of butter with skim milk, concentrated skim milk, evaporated skim milk, nonfat dry milk (dried skim milk), or any two or more of these, in such proportion that the weight of nonfat milk solids in such mixture is not more than 2.275 times the weight of milk fat therein.

[42 FR 14409, Mar. 15, 1977, as amended at 58 FR 2878, Jan. 6, 1993]

§ 139.121 Nonfat milk macaroni products.

(a) Each of the macaroni products made with nonfat milk for which a definition and standard of identity is prescribed by this section conforms to the definition and standard of identity, and is subject to the requirements for label statement of ingredients, prescribed for macaroni products by §139.110(a), (f)(2), (f)(3), (f)(4), and (g), except that:

(1)(i) In preparing the dough, nonfat dry milk or concentrated skim milk, or a mixture of these, is used in an amount such that the finished macaroni product made with nonfat milk contains by weight not less than 12 percent and not more than 25 percent of milk solids-not-fat. Carrageenan or salts of carrageenan conforming to the requirements of §172.620 and §172.626 of this chapter may be used in a quantity not in excess of 0.833 percent by weight of the milk solids-not-fat used.

(ii) When the ingredient carrageenan or the salts of carrageenan specified in paragraph (a)(1)(i) of this section is used, the label shall bear the statement, "Carrageenan added" or "Salts of carrageenan added" or the statement "With added carrageenan" or "With added salts of carrageenan", in the manner further prescribed by §139.110(f)(4).

(2) None of the optional ingredients permitted by §139.110(a) (1), (2), and (5) are used.

(b) The name of each food for which a definition and standard of identity is prescribed by this section is "Macaroni products made with nonfat milk" or, alternatively, the name is "Macaroni made with nonfat milk", "Spaghetti made with nonfat milk" or "Vermicelli made with nonfat milk", as the case

21 CFR Ch. I (4-1-07 Edition)

may be when the units of the food conform to the specifications of shape and size prescribed by §139.110 (b), (c), or (d), respectively.

[42 FR 14409, Mar. 15, 1977, as amended at 58 FR 2878, Jan. 6, 1993]

§ 139.122 Enriched nonfat milk macaroni products.

(a) Each of the enriched macaroni products made with nonfat milk for which a definition and standard of identity is prescribed by this section conforms to the definition and standard of identity, and is subject to the requirements for label statement of ingredients, prescribed for macaroni products by §139.110(a), (f)(2), (f)(3), (f)(4), and (g), except that:

(1)(i) In preparing the dough, nonfat dry milk or concentrated skim milk, or a mixture of these, is used in an amount such that the finished enriched macaroni product made with nonfat milk contains by weight not less than 12 percent and not more than 25 percent of milk solids-not-fat. Carrageenan or the salts of carrageenan conforming to the requirements of §172.620 and §172.626 of this chapter may be used in a quantity not in excess of 0.833 percent by weight of the milk solids-not-fat used.

(ii) When the ingredient carrageenan or the salts of carrageenan specified in paragraph (a)(1)(i) of this section is used, the label shall bear the statement, "Carrageenan added" or "Salts of carrageenan added" or the statement "With added carrageenan" or "With added salts of carrageenan", in the manner further prescribed by §139.110(f)(4).

(2) None of the optional ingredients permitted by §139.110(a) (1), (2), and (5) are used.

(3) Each such food contains in each pound not less than 4.0 milligrams (mg) and not more than 5.0 mg of thiamin, not less than 1.7 mg and not more than 2.2 mg of riboflavin, not less than 27 mg and not more than 34 mg of niacin or niacinamide, not less than 0.9 mg and not more than 1.2 mg of folic acid, and not less than 13 mg and not more than 16.5 mg of iron (Fe). These substances may be added through direct addition or wholly or in part through the use of dried yeast, dried torula yeast, partly

defatted wheat germ (as provided for in paragraph (a)(4) of this section), enriched farina, or enriched flour. They may be added in a harmless carrier, such carrier being used only in the quantity reasonably necessary to effect an intimate and uniform distribution of such substances in the finished food. Iron may be added only in a form that is harmless and assimilable.

(4) Each such food may also contain as an optional ingredient partly defatted wheat germ, but the amount thereof does not exceed 5 percent by weight of the finished food.

(b) The name of each food for which a definition and standard of identity is prescribed by this section is "Enriched macaroni product made with nonfat milk" or, alternatively, the name is "Enriched macaroni made with nonfat milk", "Enriched spaghetti made with nonfat milk", or "Enriched vermicelli made with nonfat milk," as the case may be when the units of the food conform to the specifications of shape and size prescribed by §139.110 (b), (c), or (d), respectively.

[42 FR 14409, Mar. 15, 1977, as amended at 58 FR 2878, Jan. 6, 1993]

§ 139.125 Vegetable macaroni products.

(a) Vegetable macaroni products are the class of food each of which conforms to the definition and standard of identity and is subject to the requirements for label statement of ingredients prescribed for macaroni products by §139.110(a), (f)(2), (f)(3), and (g), except that:

(1) Tomato (of any red variety), artichoke, beet, carrot, parsley, or spinach is added in such quantity that the solids thereof are not less than 3 percent by weight of the finished vegetable macaroni product (the vegetable used may be fresh, canned, dried, or in the form of puree or paste); and

(2) None of the optional ingredients permitted by §139.110(a) (1) and (2) is used. When the optional ingredient gum gluten (§139.110(a)(5)) is added, the quantity is such that the protein derived therefrom, together with the protein derived from the semolina, durum flour, farina, flour or any combination of these used, does not exceed 13 percent of the weight of the finished food.

(b) Vegetable macaroni is the vegetable macaroni product the units of which conform to the specifications of shape and size prescribed for macaroni by §139.110(b).

(c) Vegetable spaghetti is the vegetable macaroni product the units of which conform to the specifications of shape and size prescribed for spaghetti by §139.110(c).

(d) Vegetable vermicelli is the vegetable macaroni product, the units of which conform to the specifications of shape and size prescribed for vermicelli by §139.110(d).

(e) The name of each food for which a definition and standard of identity is prescribed by this section is "_____ macaroni product", the blank being filled in with the name whereby the vegetable used is designated in paragraph (a) of this section; or alternatively, the name is "_____ macaroni", "_____ spaghetti", or "_____ vermicelli", as the case may be, when the units of the food comply with the requirements of paragraph (b), (c), or (d) of this section, respectively, the blank in each instance being filled in with the name whereby the vegetable used is designated in paragraph (a) of this section.

[42 FR 14409, Mar. 15, 1977, as amended at 58 FR 2878, Jan. 6, 1993]

§ 139.135 Enriched vegetable macaroni products.

(a) Each of the macaroni products for which a definition and standard of identity is prescribed by this section conforms to the definition and standard of identity and is subject to the requirements for label statement of ingredients prescribed for macaroni products by §139.110(a), (f), and (g), and in addition is enriched to meet the requirements prescribed for enriched macaroni products by §139.115 and contains a vegetable ingredient in compliance with the requirements prescribed for vegetable macaroni products by §139.125.

(b) The name of each food for which a definition and standard of identity is prescribed by this section is "Enriched _____ macaroni product", or, alternatively, the name is "Enriched _____ macaroni", "Enriched _____ spaghetti", or "Enriched _____

§ 139.138

vermicelli”, when the units comply with the shape and size requirements prescribed for macaroni, spaghetti, or vermicelli in §139.110 (b), (c), or (d). The blank in each instance is filled in with the name of the vegetable used, as specified in §139.125(a). For example, the name of an enriched macaroni product containing the prescribed amount of spinach and made in units not conforming in shape and size to the requirements for macaroni, spaghetti, or vermicelli is “Enriched spinach macaroni product”.

[42 FR 14409, Mar. 15, 1977, as amended at 58 FR 2878, Jan. 6, 1993]

§ 139.138 Whole wheat macaroni products.

(a) Whole wheat macaroni products are the class of food each of which conforms to the definition and standard of identity and is subject to the requirements for label statement of ingredients, prescribed for macaroni products by §139.110(a), (f)(2), (f)(3), and (g), except that:

(1) Whole wheat flour or whole durum wheat flour or both are used as the sole wheat ingredient; and

(2) None of the optional ingredients permitted by §139.110(a) (1), (2), and (5) is used.

(b) Whole wheat macaroni is the whole wheat macaroni product the units of which conform to the specifications of shape and size prescribed for macaroni by §139.110(b).

(c) Whole wheat spaghetti is the whole wheat macaroni product the units of which conform to the specifications of shape and size prescribed for spaghetti by §139.110(c).

(d) Whole wheat vermicelli is the whole wheat macaroni product the units of which conform to the specifications of shape and size prescribed for vermicelli by §139.110(d).

(e) The name of each food for which a definition and standard of identity is prescribed by this section is “Whole wheat macaroni product”; or alternatively, the name is “Whole wheat macaroni”, “Whole wheat spaghetti”, or “Whole wheat vermicelli”, as the case may be, when the units of the food comply with the requirements of para-

21 CFR Ch. I (4–1–07 Edition)

graph (b), (c), or (d), respectively, of this section.

[42 FR 14409, Mar. 15, 1977, as amended at 58 FR 2878, Jan. 6, 1993]

§ 139.140 Wheat and soy macaroni products.

(a) Wheat and soy macaroni products are the class of food each of which conforms to the definition and standard of identity and is subject to the requirements for label statement of ingredients, prescribed for macaroni products by §139.110(a), (f)(2), (f)(3), and (g), except that:

(1) Soy flour is added in a quantity not less than 12.5 percent of the combined weight of the wheat and soy ingredients used (the soy flour used is made from heat-processed, dehulled soybeans, with or without the removal of fat therefrom); and

(2) None of the optional ingredients permitted by §139.110(a) (1) and (2) is used. When the optional ingredient gum gluten (§139.110(a)(5)) is added, the quantity is such that the protein derived therefrom, together with the protein derived from semolina, durum flour, farina, flour or any combination of these used, does not exceed 13 percent of the weight of the finished food.

(b) Wheat and soy macaroni is the wheat and soy macaroni product the units of which conform to the specifications of shape and size prescribed for macaroni by §139.110(b).

(c) Wheat and soy spaghetti is the wheat and soy macaroni product the units of which conform to the specifications of shape and size prescribed for spaghetti by §139.110(c).

(d) Wheat and soy vermicelli is the wheat and soy macaroni product the units of which conform to the specifications of shape and size prescribed for vermicelli by §139.110(d).

(e) The name of each food for which a definition and standard of identity is prescribed by this section is “Wheat and soy macaroni product”, “Wheat and soybean macaroni product”, “_____ and soy macaroni product”, or “_____ and soybean macaroni product”, the blank in each instance being filled in with the name whereby the wheat ingredient used is designated in §139.110(a); or alternatively, the name is “Wheat and soy macaroni”, “Wheat

and soybean macaroni”, “_____ and soy macaroni”, or “_____ and soybean macaroni” when the units of the food comply with the requirements of paragraph (b) of this section; or “Wheat and soy spaghetti”, “Wheat and soybean spaghetti”, “_____ and soy spaghetti”, or “_____ and soybean spaghetti” when such units comply with the requirements of paragraph (c) of this section; or “Wheat and soy vermicelli”, “Wheat and soybean vermicelli”, “_____ and soy vermicelli”, or “_____ and soybean vermicelli” when such units comply with the requirements of paragraph (d) of this section, the blank in each instance being filled in with the name whereby the wheat ingredient used is designated in § 139.110(a).

[42 FR 14409, Mar. 15, 1977, as amended at 58 FR 2878, Jan. 6, 1993]

§ 139.150 Noodle products.

(a) Noodle products are the class of food each of which is prepared by drying formed units of dough made from semolina, durum flour, farina, flour, or any combination of two or more of these, with liquid eggs, frozen eggs, dried eggs, egg yolks, frozen yolks, dried yolks, or any combination of two or more of these, with or without water and with or without one or more of the optional ingredients specified in paragraphs (a) (1) to (4) of this section inclusive:

(1) Onions, celery, garlic, bay leaf, or any two or more of these, in a quantity which seasons the food.

(2) Salt, in a quantity which seasons the food.

(3) Gum gluten, in such quantity that the protein derived therefrom, together with the protein derived from semolina, durum flour, farina, flour or any combination of these used, does not exceed 13 percent of the weight of the finished food.

(4) Concentrated glyceryl monostearate (containing not less than 90 percent monoester) in a quantity not exceeding 3 percent by weight of the finished food.

The finished noodle product contains not less than 87 percent of total solids as determined by the method prescribed in “Official Methods of Analysis of the Association of Official Analytical Chemists,” 13th Ed. (1980), in

section 14.133, under the heading “Vacuum Oven Method—Official Final Action,” which is incorporated by reference. Copies may be obtained from the AOAC INTERNATIONAL, 481 North Frederick Ave., suite 500, Gaithersburg, MD 20877, or may be examined at the National Archives and Records Administration (NARA). For information on the availability of this material at NARA, call 202-741-6030, or go to: http://www.archives.gov/federal_register/code_of_federal_regulations/ibr_locations.html. The total solids of noodle products contains not less than 5.5 percent by weight of the solids of egg, or egg yolk.

(b) Noodles, egg noodles, is the noodle product the units of which are ribbon-shaped.

(c) Egg macaroni is the noodle product the units of which are tube-shaped and more than 0.11 inch but not more than 0.27 inch in diameter.

(d) Egg spaghetti is the noodle product the units of which are tube-shaped or cord-shaped (not tubular) and more than 0.06 inch but not more than 0.11 inch in diameter.

(e) Egg vermicelli is the noodle product the units of which are cord-shaped (not tubular) and not more than 0.06 inch in diameter.

(f) The name of each food for which a definition and standard of identity is prescribed by this section is “Noodle product” or “Egg noodle product”; or alternatively, the name is “Noodles” or “Egg noodles”, “Egg macaroni”, “Egg spaghetti”, or “Egg vermicelli”, as the case may be, when the units of the food are of the shapes and sizes specified in paragraph (b), (c), (d), or (e), respectively, of this section.

(g)(1) When any ingredient specified in paragraph (a)(1) of this section is used, the label of the noodle product shall bear the statement “Seasoned with _____”, the blank being filled in with the common name of the ingredient; or in the case of bay leaves, the statement “Spiced”, “Spice added”, or “Spiced with bay leaves”.

(2) When the ingredient specified in paragraph (a)(4) of this section is used, the label shall bear the statement “Glyceryl monostearate added” or the statement “With added glyceryl monostearate”.

§ 139.155

21 CFR Ch. I (4–1–07 Edition)

(h) Wherever the name of the food appears on such label so conspicuously as to be easily seen under customary conditions of purchase, the words and statements prescribed in this section, showing the ingredients used shall immediately and conspicuously precede or follow, or in part precede and in part follow, such name without intervening written, printed, or other graphic matter.

(i) Label declaration. Each of the ingredients used in the food shall be declared on the label as required by the applicable sections of parts 101 and 130 of this chapter.

[42 FR 14409, Mar. 15, 1977, as amended at 47 FR 11829, Mar. 19, 1982; 49 FR 10099, Mar. 19, 1984; 54 FR 24894, June 12, 1989; 58 FR 2879, Jan. 6, 1993; 63 FR 14035, Mar. 24, 1998]

§ 139.155 Enriched noodle products.

(a) Enriched noodle products are the class of food each of which conforms to the definition and standard of identity, and is subject to the requirements for label statement of ingredients, prescribed for noodle products by § 139.150 (a), (g), and (i), except that:

(1) Each such food contains in each pound not less than 4 milligrams (mg) and not more than 5 mg of thiamin, not less than 1.7 mg and not more than 2.2 mg of riboflavin, not less than 27 mg and not more than 34 mg of niacin or niacinamide, not less than 0.9 mg and not more than 1.2 mg of folic acid, and not less than 13 mg and not more than 16.5 mg of iron (Fe);

(2) Each such food may also contain as an optional ingredient added vitamin D in such quantity that each pound of the finished food contains not less than 250 U.S.P. units and not more than 1000 U.S.P. units of vitamin D;

(3) Each such food may also contain as an optional ingredient added calcium in such quantity that each pound of the finished food contains not less than 500 mg. and not more than 625 mg. of calcium (Ca);

(4) Each such food may also contain as an optional ingredient partly defatted wheat germ, but the amount thereof does not exceed 5 percent of the weight of the finished food;

(5) Each such food may be supplied, wholly or in part, with the prescribed quantity of any substance referred to

in paragraphs (a) (1), (2), and (3) of this section through the use of dried yeast, dried torula yeast, partly defatted wheat germ, enriched farina, or enriched flour, or through the direct additions of any of the substances prescribed in paragraphs (a) (1), (2), and (3) of this section.

Iron and calcium may be added only in forms which are harmless and assimilable. The substances referred to in paragraphs (a) (1) and (2) of this section may be added in a harmless carrier which does not impair the enriched noodle product, such carrier being used only in the quantity reasonably necessary to effect an intimate and uniform distribution of such substances in the finished enriched noodle product.

(b) Enriched noodles, enriched egg noodles are the enriched noodle products the units of which conform to the specifications of shape and size prescribed for noodles in § 139.150(b).

(c) Enriched egg macaroni is the enriched noodle product the units of which conform to the specifications of shape and size prescribed for egg macaroni in § 139.150(c).

(d) Enriched egg spaghetti is the enriched noodle product the units of which conform to the specifications of shape and size prescribed for egg spaghetti in § 139.150(d).

(e) Enriched egg vermicelli is the enriched noodle product the units of which conform to the specifications of shape and size prescribed for egg vermicelli in § 139.150(e).

(f) The name of each food for which a definition and standard of identity is prescribed by this section is “Enriched noodle product” or “Enriched egg noodle product”; or alternatively, the name is “Enriched noodles”, or “Enriched egg noodles”, “Enriched egg macaroni”, “Enriched egg spaghetti”, or “Enriched egg vermicelli”, as the case may be, when the units of the food comply with the requirements of paragraph (b), (c), (d), or (e) respectively of this section.

[42 FR 14409, Mar. 15, 1977, as amended at 58 FR 2879, Jan. 6, 1993]

§ 139.160 Vegetable noodle products.

(a) Vegetable noodle products are the class of food each of which conforms to the definition and standard of identity,

and is subject to the requirements for label statement of ingredients, prescribed for noodle products by §139.150(a), (g), and (i), except that tomato (of any red variety), artichoke, beet, carrot, parsley, or spinach is added in such quantity that the solids thereof are not less than 3 percent by weight of the finished vegetable noodle product (the vegetable used may be fresh, canned, dried, or in the form of puree or paste).

(b) Vegetable noodles, vegetable egg noodles, is the vegetable noodle product the units of which are ribbon-shaped.

(c) Vegetable egg macaroni is the vegetable noodle product the units of which conform to the specifications of shape and size prescribed for egg macaroni by §139.150(c).

(d) Vegetable egg spaghetti is the vegetable noodle product the units of which conform to the specifications of shape and size prescribed for egg spaghetti by §139.150(d).

(e) Vegetable egg vermicelli is the vegetable noodle product the units of which conform to the specifications of shape and size prescribed for egg vermicelli by §139.150(e).

(f) The name of each food for which a definition and standard of identity is prescribed by this section is “_____ noodle product” or “_____ egg noodle product”, the blank being filled in with the name whereby the vegetable used is designated in paragraph (a) of this section; or alternatively, the name is “_____ noodles” or “_____ egg noodles”, “_____ egg macaroni”, “_____ egg spaghetti”, or “_____ egg vermicelli”, as the case may be, when the units of the food comply with the requirements of paragraph (b), (c), (d), or (e) of this section, respectively, the blank in each instance being filled in with the name whereby the vegetable is designated in paragraph (a) of this section.

[42 FR 14409, Mar. 15, 1977, as amended at 58 FR 2879, Jan. 6, 1993]

§ 139.165 Enriched vegetable noodle products.

(a) Each of the noodle products for which a definition and standard of identity is prescribed by this section conforms to the definition and stand-

ard of identity and is subject to the requirements for label declaration of ingredients prescribed for noodle products by §139.150 (a), (g), (h), and (i), and in addition is enriched to meet the requirements prescribed for enriched noodle products by §139.155 and, except as hereinafter provided, contains a vegetable ingredient in compliance with the requirements prescribed for vegetable noodle products by §139.160. Because they are apt to impart an egg-yolk color, carrots are not used in enriched vegetable noodle products.

(b) The name of each food for which a definition and standard of identity is prescribed by this section is “Enriched _____ noodle product”, “Enriched _____ egg noodle product”, or, alternatively, the name is “Enriched _____ noodles”, or “Enriched _____ egg noodles”, “Enriched _____ egg macaroni”, “Enriched _____ egg spaghetti”, or “Enriched _____ egg vermicelli”, when the units comply with the size and shape requirements for noodles, macaroni, spaghetti, or vermicelli in §139.150 (b), (c), (d), or (e). The blank in each instance is filled in with the name of the vegetable used, as specified in §139.160(a).

[42 FR 14409, Mar. 15, 1977, as amended at 58 FR 2879, Jan. 6, 1993]

§ 139.180 Wheat and soy noodle products.

(a) Wheat and soy noodle products are the class of food each of which conforms to the definition and standard of identity and is subject to the requirements for label statement of ingredients prescribed for noodle products by §139.150(a), (g), and (i), except that soy flour is added in a quantity not less than 12.5 percent of the combined weight of the wheat and soy ingredients used (the soy flour used is made from heat-processed, dehulled soybeans, with or without the removal of fat therefrom).

(b) Wheat and soy noodles, wheat and soy egg noodles, is the wheat and soy noodle product the units of which are ribbon-shaped.

(c) Wheat and soy egg macaroni is the wheat and soy noodle product the units of which conform to the specifications of shape and size prescribed for egg macaroni by §139.150(c).

(d) Wheat and soy egg spaghetti is the wheat and soy noodle product the units of which conform to the specifications of shape and size prescribed for egg spaghetti by §139.150(d).

(e) Wheat and soy egg vermicelli is the wheat and soy noodle product the units of which conform to the specifications of shape and size prescribed for egg vermicelli by §139.150(e).

(f) The name of each food for which a definition and standard of identity is prescribed by this section is “Wheat and soy noodle product”, “Wheat and soy egg noodle product”, “Wheat and soybean noodle product”, “Wheat and soybean egg noodle product”, “_____ and soy noodle product”, “_____ and soy egg noodle product”, “_____ and soybean noodle product”, or “_____ and soybean egg noodle product”, the blank in each instance being filled in with the name whereby the wheat ingredient used is designated in §139.150(a); or alternatively, the name is “Wheat and soy noodles”, “Wheat and soy egg noodles”, “Wheat and soybean noodles”, “Wheat and soybean egg noodles”, “_____ and soy noodles”, “_____ and soy egg noodles”, “_____ and soybean noodles”, or “_____ and soybean egg noodles” when the units of the food comply with the requirements of paragraph (b) of this section; or “Wheat and soy egg macaroni”, “Wheat and soybean egg macaroni”, “_____ and soy egg macaroni”, or “_____ and soybean egg macaroni” when such units comply with the requirements of paragraph (c) of this section; or “Wheat and soy egg spaghetti”, “Wheat and soybean egg spaghetti”, “_____ and soy egg spaghetti”, or “_____ and soybean egg spaghetti” when such units comply with the requirements of paragraph (d) of this section; or “Wheat and soy egg vermicelli”, “Wheat and soybean egg vermicelli”, “_____ and soy egg vermicelli”, or “_____ and soybean egg vermicelli”, when such units comply with the requirements of paragraph (e) of this section, the blank in each instance being filled in with the name whereby the wheat ingredient used is designated in §139.150(a).

[42 FR 14409, Mar. 15, 1977, as amended at 58 FR 2879, Jan. 6, 1993]

PART 145—CANNED FRUITS

Subpart A—General Provisions

Sec.

145.3 Definitions.

Subpart B—Requirements for Specific Standardized Canned Fruits

- 145.110 Canned applesauce.
- 145.115 Canned apricots.
- 145.116 Artificially sweetened canned apricots.
- 145.120 Canned berries.
- 145.125 Canned cherries.
- 145.126 Artificially sweetened canned cherries.
- 145.130 Canned figs.
- 145.131 Artificially sweetened canned figs.
- 145.134 Canned preserved figs.
- 145.135 Canned fruit cocktail.
- 145.136 Artificially sweetened canned fruit cocktail.
- 145.140 Canned seedless grapes.
- 145.145 Canned grapefruit.
- 145.170 Canned peaches.
- 145.171 Artificially sweetened canned peaches.
- 145.175 Canned pears.
- 145.176 Artificially sweetened canned pears.
- 145.180 Canned pineapple.
- 145.181 Artificially sweetened canned pineapple.
- 145.185 Canned plums.
- 145.190 Canned prunes.

AUTHORITY: 21 U.S.C. 321, 341, 343, 348, 371, 379e.

SOURCE: 42 FR 14414, Mar. 15, 1977, unless otherwise noted.

Subpart A—General Provisions

§145.3 Definitions.

For the purposes of this part:

(a) The term *corn sirup* means a clarified, concentrated aqueous solution of the products obtained by the incomplete hydrolysis of cornstarch, and includes dried corn sirup. The solids of corn sirup and of dried corn sirup contain not less than 40 percent by weight of reducing sugars calculated as anhydrous dextrose.

(b) The term *dextrose* means the hydrated or anhydrous, refined monosaccharide obtained from hydrolyzed starch.

(c) The term *dried glucose sirup* means the product obtained by drying “glucose sirup.”

(d) The term *glucose sirup* means a clarified, concentrated, aqueous solution of the products obtained by the incomplete hydrolysis of any edible starch. The solids of glucose sirup contain not less than 40 percent by weight of reducing sugars calculated as anhydrous dextrose.

(e) The term *invert sugar sirup* means an aqueous solution of inverted or partly inverted, refined or partly refined sucrose, the solids of which contain not more than 0.3 percent by weight of ash, and which is colorless, odorless, and flavorless, except for sweetness.

(f) The term *sugar* means refined sucrose.

(g) The terms *edible organic acid* and *edible organic salt* refer to any edible organic acid and any edible organic salt added for the purpose of flavor enhancement that either is not a food additive as defined in section 201(s) of the Federal Food, Drug, and Cosmetic Act or, if it is a food additive as so defined, is used in conformity with regulations established pursuant to section 409 of the act.

(h) The term *water* means, in addition to water, any mixture of water and fruit juice in which the fruit juice(s) is less than 50 percent of such mixture, including any water contributed by the use of liquid nutritive carbohydrate sweeteners.

(i) The term *fruit juice(s) and water* means any mixture of fruit juice as herein defined and water, including any water contributed by the use of liquid nutritive carbohydrate sweeteners, in which the fruit juice(s) is 50 percent, or more, of such mixture except that water used in preparing equivalent single strength juice(s) from concentrate(s) shall not be considered to be a mixture of fruit juice and water.

(j) The term *fruit juice(s)* means single strength expressed juice(s) of sound, mature fruit(s). It may be fresh, frozen, canned, or made from concentrate(s). However, if it is made from concentrate(s), the juice(s) shall be reconstituted with water to not less than the soluble solids that such fruit juice had before concentration. Fruit juice(s) may be used singly or in combination. If a fruit juice(s) is used which is regulated by a standard of identity of this

chapter, it shall conform to the compositional requirements prescribed by such standard prior to the addition of any sweetener which may be used.

(k) The term *clarified juice* means the liquid expressed wholly or in part from fruit peelings, fruit shells, fruit cores, or from the fruit flesh or parts thereof, which is clarified and may be further refined or concentrated.

(l) The term *solid pack* means the product contains practically all fruit with only the very little free flowing liquid that is expressed from the fruit and to which no packing media have been added.

(m) The procedure for determining the densities of the packing media means the following: The density of the packing medium, when measured 15 days or more after packing, or the density of the blended homogenized slurry of the comminuted entire contents of the container, when measured less than 15 days after canning, is determined according to "Official Methods of Analysis of the Association of Official Analytical Chemists," 13th Ed. (1980), which is incorporated by reference, section 31.6F011 (Solids) "By Means of the Refractometer—Official Final Action" (and sections 52.012 and 52.015) with result expressed as percent by weight of sucrose (degrees Brix) with correction for temperature to the equivalent at 20 °C, but without correction for invert sugar or other substances. Copies of the material incorporated by reference may be obtained from the AOAC INTERNATIONAL, 481 North Frederick Ave., suite 500, Gaithersburg, MD 20877, or may be examined at the National Archives and Records Administration (NARA). For information on the availability of this material at NARA, call 202-741-6030, or go to: http://www.archives.gov/federal_register/code_of_federal_regulations/ibr_locations.html.

(n) The procedure for determining drained weight is as follows: Tilt the opened container so as to distribute the contents evenly over the meshes of a circular sieve which has previously been weighed. The diameter of the sieve is 20.3 centimeters (8 inches) if the quantity of contents of the container is less than 1.4 kilograms (3 pounds) and 30.5 centimeters (12 inches)

§ 145.3

21 CFR Ch. I (4-1-07 Edition)

if such quantity is 1.4 kilograms (3 pounds) or more. The bottom of the sieve is woven-wire cloth which complies with the specifications for the No. 8 sieve set forth in the "Definitions of Terms and Explanatory Notes" of the "Official Methods of Analysis of the Association of Official Analytical Chemists," 13th Ed. (1980), which is incorporated by reference. The availability of this incorporation by reference is given in paragraph (m) of this section. Carefully invert by hand all fruits having cups or cavities if they fall on the sieve with cups or cavities up. Cups or cavities in soft products may be drained by tilting sieve. Without further shifting the material on the sieve, incline the sieve at an angle of 17° to 20° to facilitate drainage. Two minutes after the drainage begins, weigh the sieve and drained fruit. The weight so found, less the weight of the sieve, shall be considered to be the weight of the drained fruit.

(o) Compliance means the following: Unless otherwise provided in a standard, a lot of canned fruits shall be deemed in compliance for the following factors, to be determined by the sampling and acceptance procedure as provided in paragraph (p) of this section, namely:

(1) *Packing medium density.* A lot shall be deemed to be in compliance for packing medium density based on the average sucrose value for all samples analyzed according to the sampling plans, but no container may have a sucrose value lower than that of the next lower category or 2 percent by weight sucrose (degrees Brix) lower if no lower category exists.

(2) *Quality.* The quality of a lot shall be considered acceptable when the number of defectives does not exceed the acceptance number in the sampling plans.

(3) *Fill of container.* A lot shall be deemed to be in compliance for fill of container (packing medium and fruit ingredient) when the number of defectives does not exceed the acceptance number (c) in the sampling plans.

(4) *Drained weight.* A lot shall be deemed to be in compliance for drained weight based on the average value of all samples analyzed according to the

sampling plans. The sample unit shall be the entire contents of the container.

(p) The sampling and acceptance procedure means the following:

(1) *Definitions*—(i) *Lot.* A collection of primary containers or units of the same size, type, and style manufactured or packed under similar conditions and handled as a single unit of trade.

(ii) *Lot size.* The number of primary containers or units in the lot.

(iii) *Sample size.* The total number of sample units drawn for examination from a lot.

(iv) *Sample unit.* A container, a portion of the contents of a container, or a composite mixture of product from small containers that is sufficient for the examination or testing as a single unit.

(v) *Defective.* Any sample unit shall be regarded as defective when the sample unit does not meet the criteria set forth in the standards.

(vi) *Acceptance number (c).* The maximum number of defective sample units permitted in the sample in order to consider the lot as meeting the specified requirements.

(vii) *Acceptable quality level (AQL).* The maximum percent of defective sample units permitted in a lot that will be accepted approximately 95 percent of the time.

(2) *Sampling plans:*

Lot size (primary containers)	Size in container	
	<i>n</i> ¹	<i>c</i> ²
NET WEIGHT EQUAL TO OR LESS THAN 1 KG (2.2 LB)		
4,800 or less	13	2
4,801 to 24,000	21	3
24,001 to 48,000	29	4
48,001 to 84,000	48	6
84,001 to 144,000	84	9
144,001 to 240,000	126	13
Over 240,000	200	19
NET WEIGHT GREATER THAN 1 KG (2.2 LB) BUT NOT MORE THAN 4.5 KG (10 LB)		
2,400 or less	13	2
2,401 to 15,000	21	3
15,001 to 24,000	29	4
24,001 to 42,000	48	6
42,001 to 72,000	84	9
72,001 to 120,000	126	13
Over 120,000	200	19
NET WEIGHT GREATER THAN 4.5 KG (10 LB)		
600 or less	13	2
601 to 2,000	21	3
2,001 to 7,200	29	4

Lot size (primary containers)	Size in container	
	n ¹	c ²
7,201 to 15,000	48	6
15,001 to 24,000	84	9
24,001 to 42,000	126	13
Over 42,000	200	19

¹ n=number of primary containers in sample.
² c=acceptance number.

[42 FR 14414, Mar. 15, 1977, as amended at 47 FR 11829, Mar. 19, 1982; 49 FR 10099, Mar. 19, 1984; 54 FR 24894, June 12, 1989; 63 FR 14035, Mar. 24, 1998]

Subpart B—Requirements for Specific Standardized Canned Fruits

§ 145.110 Canned applesauce.

(a) *Identity*—(1) *Definition*. Canned applesauce is the food prepared from comminuted or chopped apples (*Malus domestica* Borkhausen), which may or may not be peeled and cored, and which may have added thereto one or more of the optional ingredients specified in paragraph (a)(2) of this section. The apple ingredient is heated and, in accordance with good manufacturing practices, bruised apple particles, peel, seed, core material, carpel tissue, and other coarse, hard, or extraneous materials are removed. The food is sealed in containers. It is so processed by heat, either before or after sealing, as to prevent spoilage. The soluble solids content, measured by refractometer and expressed as percent sucrose (degrees Brix) with correction for temperature to the equivalent at 20 °C (68 °F), is not less than 9 percent (exclusive of the solids of any added optional nutritive carbohydrate sweeteners) as determined by the method prescribed in “Official Methods of Analysis of the Association of Official Analytical Chemists,” 13th Ed. (1980), section 22.024, “Soluble Solids by Refractometer in Fresh and Canned Fruits, Jams, Marmalades, and Preserves—Official First Action,” which is incorporated by reference, but without correction for invert sugar or other substances. Copies may be obtained from the AOAC INTERNATIONAL, 481 North Frederick Ave., suite 500, Gaithersburg, MD 20877, or may be examined at the National Archives and Records Administration (NARA). For information on the avail-

ability of this material at NARA, call 202-741-6030, or go to: http://www.archives.gov/federal_register/code_of_federal_regulations/ibr_locations.html.

(2) *Optional ingredients*. The following safe and suitable optional ingredients may be used:

- (i) Water.
- (ii) Apple juice.
- (iii) Salt.
- (iv) Any organic acid added for the purpose of acidification. (Organic acids generally recognized as having a preservative effect are not permitted in applesauce except as provided for in paragraph (a)(2)(viii) of this section.)
- (v) Nutritive carbohydrate sweeteners.
- (vi) Spices.
- (vii) Natural and artificial flavoring.
- (viii) Either of the following:

(a) Erythorbic acid or ascorbic acid as an antioxidant preservative in an amount not to exceed 150 parts per million; or

(b) Ascorbic acid (vitamin C) in a quantity such that the total vitamin C in each 113 g (4 ounces) by weight of the finished food amounts to 60 mg. This requirement will be deemed to have been met if a reasonable overage of the vitamin, within limits of good manufacturing practice, is present to insure that the required level is maintained throughout the expected shelf life of the food under customary conditions of distribution.

(ix) Color additives in such quantity as to distinctly characterize the food unless such addition conceals damage or inferiority or makes the finished food appear better or of greater value than it is.

(3) *Nomenclature*. The name of the food is “applesauce”. The name of the food shall include a declaration indicating the presence of any flavoring that characterizes the product as specified in §101.22 of this chapter and a declaration of any spice that characterizes the product. If a nutritive sweetener as provided for in paragraph (a)(2)(v) of this section is added and the soluble solids content of the finished food is not less than 16.5 percent as determined by the method referred to in paragraph (a)(1) of this section, the

§ 145.115

21 CFR Ch. I (4-1-07 Edition)

name may include the word “sweetened”. If no such sweetener is added, the name may include the word “unsweetened”.

(4) *Label declaration.* Each of the ingredients used in the food shall be declared on the label as required by the applicable sections of parts 101 and 130 of this chapter. However, when ascorbic acid (vitamin C) is added as provided for in paragraph (a)(2)(viii)(b) of this section, after the application of heat to the apples, preservative labeling requirements do not apply.

(b) [Reserved]

(c) *Fill of container.* (1) The standard of fill of container for canned applesauce is a fill of not less than 90 percent of the total capacity of the container, as determined by the general method for fill of containers prescribed in §130.12(b) of this chapter; except that in the case of glass containers having a total capacity of 192 ml (6½ fluid ounces) or less, the fill is not less than 85 percent.

(2) Sampling and acceptance procedure: A lot will be deemed to fall below the standard of fill when the number of “defectives” exceeds the acceptance number “c” in the sampling plans prescribed in paragraph (c)(2)(ii) of this section.

(i) Definitions of terms to be used in the sampling plans in paragraph (c)(2)(ii) of this section are as follows:

(a) *Lot.* A collection of primary containers or units of the same size, type, and style manufactured or packed under similar conditions and handled as a single unit of trade.

(b) *Lot size.* The number of primary containers or units in the lot.

(c) *Sample size “n.”* The total number of sample units drawn for examination from a lot as indicated in paragraph (c)(2)(ii) of this section.

(d) *Sample unit.* A container, the entire contents of a container, a portion of the contents of a container, or a composite mixture of product from small containers that is sufficient for examination or testing as a single unit.

(e) *Defective.* A container that falls below the requirement for minimum fill prescribed in paragraph (c)(1) of this section is considered a “defective.”

(f) *Acceptable number “c.”* The maximum number of defective sample units permitted in the sample in order to consider the lot as meeting the specified requirements.

(g) *Acceptable quality level (AQL).* The maximum percent of defective sample units permitted in a lot that will be accepted approximately 95 percent of the time.

(ii) Sampling and acceptance:

ACCEPTABLE QUALITY LEVEL (AQL) 6.5

Lot size (primary containers)	Size of container	
	<i>n</i> ¹	<i>c</i> ²
NET WEIGHT EQUAL TO OR LESS THAN 1 KG (2.2 LB)		
4,800 or less	13	2
4,801 to 24,000	21	3
24,001 to 48,000	29	4
48,001 to 84,000	48	6
84,001 to 144,000	84	9
144,001 to 240,000	126	13
Over 240,000	200	19
NET WEIGHT GREATER THAN 1 KG (2.2 LB) BUT NOT MORE THAN 4.5 KG (10 LB)		
2,400 or less	13	2
2,401 to 15,000	21	3
15,001 to 24,000	29	4
24,001 to 42,000	48	6
42,001 to 72,000	84	9
72,001 to 120,000	126	13
Over 120,000	200	19
NET WEIGHT GREATER THAN 4.5 KG (10 LB)		
600 or less	13	2
601 to 2,000	21	3
2,001 to 7,200	29	4
7,201 to 15,000	48	6
15,001 to 24,000	84	9
24,001 to 42,000	126	13
Over 42,000	200	19

¹ *n*=number of primary containers in sample.
² *c*=acceptance number.

(3) If canned applesauce falls below the standard of fill of container prescribed in paragraph (c)(1) of this section, the label shall bear the general statement of substandard fill specified in §130.14(b) of this chapter, in the manner and form therein specified.

[42 FR 14414, Mar. 15, 1977, as amended at 47 FR 11829, Mar. 19, 1982; 49 FR 10099, Mar. 19, 1984; 54 FR 24894, June 12, 1989; 58 FR 2879, Jan. 6, 1993; 63 FR 14035, Mar. 24, 1998]

§ 145.115 Canned apricots.

(a) *Identity*—(1) *Ingredients.* Canned apricots is the food prepared from mature apricots of one of the optional styles specified in paragraph (a)(2) of

this section, which may be packed as solid pack or in one of the optional packing media specified in paragraph (a)(3) of this section. Such food may also contain one, or any combination of two or more of the following safe and suitable optional ingredients:

- (i) Natural and artificial flavors.
- (ii) Spice.
- (iii) Vinegar, lemon juice, or organic acids.
- (iv) Apricot pits, except in the cases of unpeeled whole apricots and peeled whole apricots, in a quantity not more than 1 apricot pit to each 227 grams (8 ounces) of finished canned apricots.
- (v) Apricot kernels, except in the cases of unpeeled whole apricots and peeled whole apricots, and except when optional ingredient under paragraph (a)(4) of this section is used.
- (vi) Ascorbic acid in an amount no greater than necessary to preserve color.

Such food is sealed in a container and before or after sealing is so processed by heat as to prevent spoilage.

(2) *Optional styles of the apricot ingredient.* The optional styles of the apricot ingredient referred to in paragraph (a) of this section are peeled or unpeeled:

- (i) Whole.
- (ii) Halves.
- (iii) Quarters.
- (iv) Slices.
- (v) Pieces or irregular pieces.

Each such ingredient, except in the cases of unpeeled whole apricots and peeled whole apricots, is pitted.

(3) *Packing media.* (i) The optional packing media referred to in paragraph (a)(1) of this section, as defined in §145.3 are:

- (a) Water.
- (b) Fruit juice(s) and water.
- (c) Fruit juice(s).

Such packing media may be used as such or any one or any combination of two or more safe and suitable nutritive carbohydrate sweetener(s) may be added. Sweeteners defined in §145.3 shall be as defined therein, except that a nutritive carbohydrate sweetener for which a standard of identity has been established in part 168 of this chapter shall comply with such standard in lieu of any definition that may appear in §145.3.

(ii) When a sweetener is added as a part of any such liquid packing medium, the density range of the resulting packing medium expressed as percent by weight of sucrose (degrees Brix) as determined by the procedure prescribed in §145.3(m) shall be designated by the appropriate name for the respective density ranges, namely:

(a) When the density of the solution is 10 percent or more but less than 16 percent, the medium shall be designated as "slightly sweetened water"; or "extra light sirup"; "slightly sweetened fruit juice(s) and water"; or "slightly sweetened fruit juice(s)", as the case may be.

(b) When the density of the solution is 16 percent or more but less than 21 percent, the medium shall be designated as "light sirup"; "lightly sweetened fruit juice(s) and water"; or "lightly sweetened fruit juice(s)", as the case may be.

(c) When the density of the solution is 21 percent or more but less than 25 percent, the medium shall be designated as "heavy sirup"; "heavily sweetened fruit juice(s) and water"; or "heavily sweetened fruit juice(s)", as the case may be.

(d) When the density of the solution is 25 percent or more but not more than 40 percent, the medium shall be designated as "extra heavy sirup"; "extra heavily sweetened fruit juice(s) and water"; or "extra heavily sweetened fruit juice(s)", as the case may be.

(4) *Labeling requirements.* (i) The name of the food is "apricots". The name of the food shall also include a declaration of any flavoring that characterizes the product as specified in §101.22 of this chapter and a declaration of any spice or seasoning that characterizes the product; for example, "Spice Added", or in lieu of the word "Spice", the common name of the spice, "Seasoned with Vinegar" or "Seasoned with Apricot Kernels". When two or more of the optional ingredients specified in paragraphs (a)(1) (ii) through (iv), inclusive, of this section are used, such words may be combined as for example, "Seasoned with Cider Vinegar, Cloves, Cinnamon Oil and Apricot Kernels".

(ii) The style of the apricot ingredient as provided in paragraph (a)(2) of

this section and the name of the packing medium as used in paragraphs (a)(3)(i) and (ii) of this section, preceded by "In" or "Packed in" or the words "solid pack", where applicable, shall be included as part of the name or in close proximity to the name of the food, except that pieces or irregular pieces shall be designated "Pieces", "Irregular pieces", or "Mixed pieces of irregular sizes and shapes". The style of the apricot ingredient shall be preceded or followed by "Unpeeled" or "Peeled", as the case may be. "Halves" may be alternatively designated "Halved", "Quarters" as "Quartered" and "Slices" as "Sliced". When the packing medium is prepared with a sweetener(s) which imparts a taste, flavor or other characteristic to the finished food in addition to sweetness, the name of the packing medium shall be accompanied by the name of such sweetener(s), as for example in the case of a mixture of brown sugar and honey, an appropriate statement would be "_____ sirup of brown sugar and honey" the blank to be filled in with the word "light", "heavy", or "extra heavy" as the case may be. When the liquid portion of the packing media provided for in paragraphs (a)(3) (i) and (ii) of this section consists of fruit juice(s), such juice(s) shall be designated in the name of the packing medium as:

(a) In the case of a single fruit juice, the name of the juice shall be used in lieu of the word "fruit".

(b) In the case of a combination of two or more fruit juices, the names of the juices in the order of predominance by weight shall either be used in lieu of the word "fruit" in the name of the packing medium, or be declared on the label as specified in paragraph (a)(4)(iii) of this section, and

(c) In the case of a single fruit juice or a combination of two or more fruit juices any of which are made from concentrate(s), the words "from concentrate(s)" shall follow the word "juice(s)" in the name of the packing medium and in the name(s) of such juice(s) when declared as specified in paragraph (a)(4)(iii) of this section.

(iii) Whenever the names of the fruit juices used do not appear in the name of the packing medium as provided in

paragraph (a)(4)(ii)(b) of this section, such names and the words "from concentrate," as specified in paragraph (a)(4)(ii)(c) of this section, shall appear in an ingredient statement pursuant to the requirements of §101.3(d) of this chapter.

(iv) Label declaration. Each of the ingredients used in the food shall be declared on the label as required by the applicable sections of parts 101 and 130 of this chapter.

(b) *Quality.* (1) The standard of quality for canned apricots is as follows:

(i) All units tested in accordance with the method prescribed in paragraph (b)(2) of this section are pierced by a weight of not more than 300 grams.

(ii) In the cases of whole apricots, halves, and quarters, the weight of the largest unit in the container is not more than twice the weight of the smallest unit therein.

(iii) Not more than 20 percent of the units in the container are blemished with scab, hail injury, discoloration, or other abnormalities.

(iv) In the cases of whole apricots, halves, and quarters, all units are untrimmed, or are so trimmed as to preserve normal shape.

(v) Except in the case of mixed pieces of irregular sizes and shapes, not more than 5 percent of the units in a container of 20 or more units, and not more than 1 unit in a container of less than 20 units, are crushed or broken. (A unit which has lost its normal shape because of ripeness and which bears no mark of crushing shall not be considered to be crushed or broken.)

(2) Canned apricots shall be tested by the following method to determine whether or not they meet the requirements of paragraph (b)(1)(i) of this section: So trim a test piece from the unit as to fit, with peel surface up, into a supporting receptacle. If the unit is of different firmness in different parts of its peel surface, trim the piece from the firmest part. If the piece is unpeeled, remove the peel. The top of the receptacle is circular in shape, of $1\frac{1}{8}$ inches inside diameter, with vertical sides; or rectangular in shape, $\frac{3}{4}$ inch by 1 inch inside measurements, with ends vertical and sides sloping downward and joining at the center at

a vertical depth of $\frac{3}{4}$ inch. Use the circular receptacle for testing units of such size that a test piece can be trimmed therefrom to fit it. Use the rectangular receptacle for testing other units. Test no unit from which a test piece with rectangular peel surface at least $\frac{1}{2}$ inch by 1 inch cannot be trimmed. Test the piece by means of a round metal rod $\frac{3}{16}$ inch in diameter. To the upper end of the rod is affixed a device to which weight can be added. The rod is held vertically by a support through which it can freely move upward or downward. The lower end of the rod is a plane surface to which the vertical axis of the rod is perpendicular. Adjust the combined weight of the rod and device to 100 grams. Set the receptacle so that the surface of the test piece is held horizontally. Lower the end of the rod to the approximate center of such surface, and add weight to the device at a uniform, continuous rate of 12 grams per second until the rod pierces the test piece. Weigh the rod and weighted device. Test all units in containers of 50 units or less, except those units too small for testing or too soft for trimming. Test at least 50 units, taken at random, in containers of more than 50 units; but if less than 50 units are of sufficient size and firmness for testing, test those which are of sufficient size and firmness.

(3) If the quality of canned apricots falls below the standard prescribed in paragraph (b)(1) of this section, the label shall bear the general statement of substandard quality specified in §130.14(a) of this chapter, in the manner and form therein specified; but in lieu of such general statement of substandard quality, the label may bear the alternative statement "Below standard in quality _____", the blank to be filled in with the words specified after the corresponding number of each subparagraph of paragraph (b)(1) of this section which such canned apricots fail to meet, as follows:

- (i) "Not tender";
- (ii) "Mixed sizes";
- (iii) "Blemished";
- (iv) "Unevenly trimmed";
- (v) "Partly crushed or broken".

Such alternative statement shall immediately and conspicuously precede

or follow, without intervening written, printed, or graphic matter, the name "apricots" and any words and statements required or authorized to appear with such name by §145.115(a)(2).

(c) *Fill of container.* (1) The standard of fill of container for canned apricots is the maximum quantity of the optional apricot ingredient that can be sealed in the container and processed by heat to prevent spoilage, without crushing or breaking such ingredient.

(2) If canned apricots fall below the standard of fill of container prescribed in paragraph (c)(1) of this section, the label shall bear the general statement of substandard fill specified in §130.14(b) of this chapter, in the manner and form therein specified.

[42 FR 14414, Mar. 15, 1977, as amended at 58 FR 2879, Jan. 6, 1993]

§ 145.116 Artificially sweetened canned apricots.

(a) Artificially sweetened canned apricots is the food which conforms to the definition and standard of identity prescribed for canned apricots by §145.115(a), except that in lieu of a packing medium specified in §145.115(a)(3), the packing medium used is water artificially sweetened with saccharin, sodium saccharin, or a combination of both. Such packing medium may be thickened with pectin and may contain any mixture of any edible organic salt or salts and any edible organic acid or acids as a flavor-enhancing agent, in a quantity not more than is reasonably required for that purpose.

(b)(1) The specified name of the food is "artificially sweetened _____", the blank being filled in with the name prescribed by §145.115(a) for canned apricots having the same optional apricot ingredient.

(2) The artificially sweetened food is subject to the requirements for label statement of ingredients used, as prescribed for canned apricots by §145.115(a). If the packing medium is thickened with pectin, the label shall bear the statement "thickened with pectin". When any organic salt or acid or any mixture of two or more of these

§ 145.120

21 CFR Ch. I (4-1-07 Edition)

is added, the label shall bear the common or usual name of each such ingredient.

[42 FR 14414, Mar. 15, 1977, as amended at 58 FR 2879, Jan. 6, 1993]

§ 145.120 Canned berries.

(a) *Identity*—(1) *Ingredients*. Canned berries is the food prepared from any suitable variety of one of the optional berry ingredients specified in paragraph (a)(2) of this section, which may be packed in one of the optional packing media specified in paragraph (a)(3) of this section, and may contain one or any combination of two or more of the safe and suitable optional ingredients specified in paragraph (a)(4) of this section. Such food is sealed in a container and before or after sealing is so processed by heat to prevent spoilage.

(2) *Varietal types*. The optional berry ingredients referred to in paragraph (a)(1) of this section are prepared from stemmed fruit of the following optional varietal types of berry ingredient; namely:

- (i) Raspberry varieties conforming to the characteristics of *Rubus idaeus* L. or *Rubus occidentalis* L.
- (ii) Blackberries.
- (iii) Blueberries.
- (iv) Boysenberries.
- (v) Dewberries.
- (vi) Gooseberries.
- (vii) Huckleberries.
- (viii) Loganberries.
- (ix) Strawberry varieties conforming to the characteristics of *Fragaria*.
- (x) Youngberries.

(3) *Packing media*. (i) The optional packing media referred to in paragraph (a)(1) of this section as defined in §145.3 are:

- (a) Water.
- (b) Fruit juice(s) and water.

(c) Fruit juice(s).

Such packing media may be used as such or any one or any combination of two or more safe and suitable nutritive carbohydrate sweeteners may be added. Sweeteners listed in §145.3 shall be as defined therein, except that a nutritive carbohydrate sweetener for which a standard of identity has been established in part 168 of this chapter shall comply with such standard in lieu of any definition that may appear in §145.3.

(ii) When a sweetener is added as a part of any such liquid packing medium, the four density ranges of the resulting packing media hereinafter specified for each berry ingredient, expressed as percent by weight of sucrose (degrees Brix) as determined by the procedure described in §145.3(m), shall be designated by the appropriate name for each of the respective density ranges for each berry ingredient as:

- (a) "Slightly sweetened water"; or "extra light sirup"; "slightly sweetened fruit juice(s) and water"; or "slightly sweetened fruit juice(s)", as the case may be.
- (b) "Light sirup", when the liquid used is water, "lightly sweetened fruit juice(s) and water"; or "lightly sweetened fruit juice(s)", as the case may be.
- (c) "Heavy sirup", when the liquid used is water; or "heavily sweetened fruit juice(s) and water"; or "heavily sweetened fruit juice(s)", as the case may be.
- (d) "Extra heavy sirup", when the liquid used is water; or "extra heavily sweetened fruit juice(s) and water"; or "extra heavily sweetened fruit juice(s)", as the case may be.

The density ranges referred to herein are:

Optional berry ingredient	Density ranges							
	(a)		(b)		(c)		(d)	
	Min-imum	Max-imum less than	Min-imum	Max-imum less than	Min-imum	Max-imum less than	Min-imum	Max-imum not more than
Blackberries	14	14	19	19	24	24	24	35
Blueberries	15	15	20	20	25	25	25	35
Boysenberries	14	14	19	19	24	24	24	35
Dewberries	14	14	19	19	24	24	24	35
Gooseberries	14	14	20	20	25	25	25	35
Huckleberries	15	15	20	20	25	25	25	35
Loganberries	14	14	19	19	24	24	24	35

Optional berry ingredient	Density ranges							
	(a)		(b)		(c)		(d)	
	Min-imum	Max-imum less than	Min-imum	Max-imum less than	Min-imum	Max-imum less than	Min-imum	Max-imum not more than
Raspberries	11	15	15	20	20	27	27	35
Strawberries	10	14	14	19	19	27	27	35
Youngberries		14	14	19	19	24	24	35

(a) "Slightly sweetened water." (b) "Light sirup." (c) "Heavy sirup." (d) "Extra heavy sirup."

(4) *Optional ingredients.* The optional ingredients referred to in paragraph (a)(1) of this section are:

- (i) Natural and artificial flavors.
- (ii) Calcium salts as firming agents provided that the calcium added is no more than 0.035 percent, calculated as calcium, of the weight of the finished canned berries.
- (iii) Organic acids.

(5) *Labeling requirements.* (i) The name of the food is the appropriate name of the berry ingredient specified in paragraph (a)(2) of this section.

(ii) The name of the packing medium, as used in paragraph (a)(3)(i) of this section preceded by "In" or "Packed in." as provided in paragraph (a)(3) of this section and, in the case of raspberries other than red raspberries provided for in paragraph (a)(2) of this section, the name of such packing medium and the color of such raspberry shall be included as part of the name or in close proximity to the name of the food. When the liquid portion of the packing media provided for in paragraphs (a)(3)(i) and (ii) of this section consists of fruit juice(s), such juice(s) shall be designated in the name of the packing medium as:

- (a) In the cases of a single fruit juice, the name of the juice shall be used in lieu of the word "fruit";
- (b) In the case of a combination of two or more fruit juices, the names of the juices in the order of predominance by weight shall either be used in lieu of the word "fruit" in the name of the packing medium, or be declared on the label as specified in paragraph (a)(3) of this section; and
- (c) In the case of a single fruit juice or a combination of two or more fruit juices any of which are made from concentrate(s), the words "from concentrate(s)" shall follow the word

"juice(s)" in the name of the packing medium and in the name(s) of such juice(s) when declared as specified in paragraph (a)(5)(iii) of this section.

(iii) Whenever the names of the fruit juices used do not appear in the name of the packing medium as provided in paragraph (a)(5)(ii)(b) of this section, such names and the words "from concentrate", as specified in paragraph (a)(5)(ii)(c) of this section, shall appear in an ingredient statement pursuant to the requirements of §101.3(d) of this chapter.

(iv) Label declaration. Each of the ingredients used in the food shall be declared on the label as required by the applicable sections of parts 101 and 130 of this chapter.

(b) [Reserved]

[46 FR 2339, Jan. 9, 1981; 47 FR 6426, Feb. 12, 1982, as amended at 48 FR 2748, Jan. 21, 1983; 58 FR 2879, Jan. 6, 1993]

§ 145.125 Canned cherries.

(a) *Identity—(1) Ingredients.* Canned cherries is the food prepared from one of the optional fresh or previously canned cherry ingredients specified in paragraph (a)(2) of this section, which may be packed in one of the optional packing media specified in paragraph (a)(3) of this section. Such food may also contain one, or any combination of two or more, of the following safe and suitable optional ingredients:

- (i) Natural and artificial flavors.
- (ii) Spice.
- (iii) Vinegar, lemon juice, or organic acids. Such food is sealed in a container and before or after sealing is so processed by heat as to prevent spoilage.

(2) *Varietal types and styles.* The optional cherry ingredients referred to in

§ 145.125

21 CFR Ch. I (4-1-07 Edition)

paragraph (a)(1) of this section are prepared from mature pitted or unpitted cherries of the red tart or alternatively, red sour, light sweet or dark sweet varietal group.

(3) *Packing media.* (i) The optional packing media referred to in paragraph (a)(1) of this section, as defined in §145.3 are:

- (a) Water.
- (b) Fruit juice(s) and water.
- (c) Fruit juice(s).

Such packing media may be used as such or any one or any combination of two or more safe and suitable nutritive carbohydrate sweetener(s) may be added. Sweeteners defined in §145.3 shall be as defined therein, except that a nutritive carbohydrate sweetener for which a standard of identity has been established in part 168 of this chapter shall comply with such standard in lieu of any definition that may appear in §145.3.

(ii) When a sweetener is added as a part of any such liquid packing medium, the density range of the resulting packing medium expressed as percent by weight of sucrose (degrees Brix) as determined by the procedure prescribed in §145.3(m) shall be designated by the appropriate name for the respective density ranges, namely:

(a) In the case of sweet cherries:

(i) When the density of the solution is less than 16 percent, the medium shall be designated as “slightly sweetened water”; or “extra light sirup”; “slightly sweetened fruit juice(s) and water”; or “slightly sweetened fruit juice(s)”, as the case may be.

(ii) When the density of the solution is 16 percent or more but less than 20 percent, the medium shall be designated as “light sirup”; “lightly sweetened fruit juice(s) and water”; or “lightly sweetened fruit juice(s)”, as the case may be.

(iii) When the density of the solution is 20 percent or more but less than 25 percent, the medium shall be designated as “heavy sirup”; “heavily sweetened fruit juice(s) and water”; or “heavily sweetened fruit juice(s)”, as the case may be.

(iv) When the density of the solution is 25 percent or more but not more than 35 percent, the medium shall be designated as “extra heavy sirup”;

“extra heavily sweetened fruit juice(s) and water”; or “extra heavily sweetened fruit juice(s)”, as the case may be.

(b) In the case of red tart cherries:

(i) When the density of the solution is less than 18 percent, the medium shall be designated as “slightly sweetened water”; “slightly sweetened fruit juice(s) and water”; or “slightly sweetened fruit juice(s)”, as the case may be.

(ii) When the density of the solution is 18 percent or more but less than 22 percent, the medium shall be designated as “light sirup”; “lightly sweetened fruit juice(s) and water”; or “lightly sweetened fruit juice(s)”, as the case may be.

(iii) When the density of the solution is 22 percent or more but less than 28 percent, the medium shall be designated as “heavy sirup”; “heavily sweetened fruit juice(s) and water”; or “heavily sweetened fruit juice(s)”, as the case may be.

(iv) When the density of the solution is 28 percent or more but not more than 45 percent, the medium shall be designated as “extra heavy sirup”; “extra heavily sweetened fruit juice(s) and water”; or “extra heavily sweetened fruit juice(s)”, as the case may be.

(4) *Labeling requirements.* (i) The name of the food is “cherries”. The optional varietal type as set forth in paragraph (a)(2) of this section, preceded or followed by the word “pitted” when this is the fact, shall be a part of the name. The name of the food shall also include a declaration of any flavoring that characterizes the product as specified in §101.22 of this chapter and a declaration of any spice or seasoning that characterizes the product; for example, “Spice added”, or in lieu of the word “Spice”, the common name of the spice, or “Seasoned with lemon juice”. When two or more of the optional ingredients specified in paragraph (a)(1) (ii) and (iii) of this section are used, such words may be combined as for example, “Seasoned with cider vinegar, cloves, and cinnamon oil”.

(ii) The color type and style of the cherry ingredient as provided in paragraph (a)(2) of this section and the name of the packing medium specified in paragraphs (a)(3) (i) and (ii) of this section, preceded by “In” or “Packed in” or the words “solid pack”, where

applicable, shall be included as part of the name or in close proximity to the name of the food. When the packing medium is prepared with a sweetener(s) which imparts a taste, flavor or other characteristic to the finished food in addition to sweetness, the name of the packing medium shall be accompanied by the name of such sweetener(s), as for example in the case of a mixture of brown sugar and honey, an appropriate statement would be “_____ sirup of brown sugar and honey” the blank to be filled in with the word “light”, “heavy”, or “extra heavy” as the case may be. When the liquid portion of the packing media provided for in paragraphs (a)(3) (i) and (ii) of this section consists of fruit juice(s), such juice(s) shall be designated in the name of the packing medium as:

(a) In the case of a single fruit juice, the name of the juice shall be used in lieu of the word “fruit”;

(b) In the case of a combination of two or more fruit juices, the names of the juices in the order of predominance by weight shall either be used in lieu of the word “fruit” in the name of the packing medium, or be declared on the label as specified in paragraph (a)(4)(iii) of this section; and

(c) In the case of a single fruit juice or a combination of two or more fruit juices any of which are made from concentrate(s), the words “from concentrate(s)” shall follow the word “juice(s)” in the name of the packing medium and in the name(s) of such juice(s) when declared as specified in paragraph (a)(4)(iii) of this section.

(iii) Whenever the names of the fruit juices used do not appear in the name of the packing medium as provided in paragraph (a)(4)(ii)(b) of this section, such names and the words “from concentrate”, as specified in paragraph (a)(4)(ii)(c) of this section, shall appear in an ingredient statement pursuant to the requirements of §101.3(d) of this chapter.

(iv) Label declaration. Each of the ingredients used in the food shall be declared on the label as required by the applicable sections of parts 101 and 130 of this chapter.

(b) *Quality.* (1) The standard of quality for canned cherries is as follows:

(i) In the case of pitted cherries, not more than 1 pit is present in each 20 ounces of canned cherries, as determined by the method prescribed in paragraph (b)(2)(i) of this section.

(ii) In the case of unpitted cherries, the weight of each cherry in the container is not less than $\frac{1}{10}$ ounce.

(iii) In the case of unpitted cherries, the weight of the largest cherry in the container is not more than twice the weight of the smallest cherry therein.

(iv) In the case of unpitted cherries, the total weight of pits is not more than 12 percent of the weight of drained cherries, as determined by the method prescribed in paragraph (b)(2)(ii) of this section.

(v) Not more than 15 percent by count of the cherries in the container are blemished with scab, hail injury, discoloration, scar tissue or other abnormality. A cherry showing skin discoloration (other than scald) having an aggregate area exceeding that of a circle $\frac{3}{32}$ inch in diameter is considered to be blemished. A cherry showing discoloration of any area but extending into the fruit tissue is also considered to be blemished.

(2)(i) Pitted canned cherries shall be tested by the following method to determine whether or not they comply with the requirements of paragraph (b)(1)(i) of this section: Take at random such number of containers as to have a total quantity of contents of at least 24 pounds. Open the containers and weigh the contents. Count the pits and pieces of pit shell in such total quantity. Count a piece of pit shell equal to or smaller than one-half pit shell as one-half pit, and a piece of pit shell larger than one-half pit shell as one pit; but when two or more pieces of pit shell are within or attached to a single cherry, count such pieces as one-half pit if their combined size is equivalent to that of one-half pit shell or less, and as one pit if their combined size is equivalent to that of more than one-half pit shell. From the total number of pits so counted and the combined weight of the contents of all the containers, calculate the number of pits present in each 20 ounces of canned cherries.

(ii) Unpitted canned cherries shall be tested by the following method to determine whether or not they comply

with the requirements of paragraph (b)(1)(iv) of this section: Tilt the opened container so as to distribute the contents over the meshes of a circular sieve which has previously been weighed. The diameter of the sieve is 8 inches if the quantity of the contents of the container is less than 3 pounds, or 12 inches if such quantity is 3 pounds or more. The bottom of the sieve is No. 8 woven-wire cloth that complies with the specifications for such cloth set forth in the "Official Methods of Analysis of the Association of Official Analytical Chemists," 13th Ed. (1980), Table 1, "Nominal Dimensions of Standard Test Sieves (U.S.A. Standard Series)," under the heading "Definitions of Terms and Explanatory Notes," which is incorporated by reference. Copies may be obtained from the AOAC INTERNATIONAL, 481 North Frederick Ave., suite 500, Gaithersburg, MD, 20877-2504, or may be examined at the National Archives and Records Administration (NARA). For information on the availability of this material at NARA, call 202-741-6030, or go to: http://www.archives.gov/federal_register/code_of_federal_regulations/ibr_locations.html. Without shifting the cherries, so incline the sieve as to facilitate drainage. Two minutes from the time drainage begins, weigh the sieve and drained cherries. The weight so found, less the weight of the sieve, shall be considered to be the weight of drained cherries. Pit the cherries and wash the pits free from adhering flesh. Drain and weigh the pits by the method prescribed above. Divide the weight of pits so found by the weight of drained cherries, and multiply by 100.

(3) If the quality of canned cherries falls below the standard prescribed in paragraph (b)(1) of this section, the label shall bear the general statement of substandard quality specified in §130.14(a) of this chapter, in the manner and form therein specified; but in lieu of such general statement of substandard quality, the label may bear the alternative statement "Below Standard in Quality _____", the blank to be filled in with the words specified after the corresponding number of each subparagraph of paragraph (b)(1) of this section which such canned cherries fail to meet, as follows:

- (i) "Partially pitted";
- (ii) "Small";
- (iii) "Mixed sizes";
- (iv) "Thin-fleshed";
- (v) "Blemished".

Such alternative statement shall immediately and conspicuously precede or follow, without intervening written, printed, or graphic matter, the name "Cherries" and any words and statements required or authorized to appear with such name by §145.125(a)(2).

(c) *Fill of container.* (1) The standard of fill of container for canned cherries is the maximum quantity of the optional cherry ingredient that can be sealed in the container and processed by heat to prevent spoilage, without crushing such ingredient.

(2) If canned cherries fall below the standard of fill of container prescribed in paragraph (c)(1) of this section, the label shall bear the general statement of substandard fill specified in §130.14(b) of this chapter, in the manner and form therein specified.

[42 FR 14414, Mar. 15, 1977, as amended at 47 FR 11829, Mar. 19, 1982; 49 FR 10099, Mar. 19, 1984; 54 FR 24895, June 12, 1989; 58 FR 2879, Jan. 6, 1993; 63 FR 14035, Mar. 24, 1998]

§ 145.126 Artificially sweetened canned cherries.

(a) Artificially sweetened canned cherries is the food which conforms to the definition and standard of identity prescribed for canned cherries by §145.125(a), except that in lieu of a packing medium specified in §145.125(a)(3), the packing medium used is water artificially sweetened with saccharin, sodium saccharin, or a combination of both. Such packing medium may be thickened with pectin and may contain any mixture of any edible organic salt or salts and any edible organic acid or acids as a flavor-enhancing agent, in a quantity not more than is reasonably required for that purpose.

(b)(1) The specified name of the food is "artificially sweetened _____", the blank being filled in with the name prescribed by §145.125(a) for canned cherries having the same optional cherry ingredient.

(2) The artificially sweetened food is subject to the requirements for label statement of ingredients used, as prescribed for canned cherries by

§145.125(a). If the packing medium is thickened with pectin, the label shall bear the statement “thickened with pectin”. When any organic salt or acid or any mixture of two or more of these is added, the label shall bear the common or usual name of each such ingredient.

[42 FR 14414, Mar. 15, 1977, as amended at 58 FR 2879, Jan. 6, 1993]

§ 145.130 Canned figs.

(a) *Ingredients.* Canned figs is the food prepared from one of the optional fig ingredients specified in paragraph (b) of this section and one of the optional packing media specified in paragraph (c) of this section, to which lemon juice, concentrated lemon juice or organic acid(s) is added, when necessary to reduce the pH of the finished product to pH 4.9 or below. Such food may also contain one, or any combination of two or more of the following safe and suitable optional ingredients:

- (1) Natural and artificial flavoring.
- (2) Spice.
- (3) Vinegar.
- (4) Unpeeled segments of citrus fruits.
- (5) Salt.

Such food is sealed in a container and before or after sealing is so processed by heat as to prevent spoilage.

(b) *Varietal types.* The optional fig ingredients referred to in paragraph (a) of this section are prepared from mature figs of the light or dark varieties. Figs (or whole figs), split figs (or broken figs), or any combination thereof are optional fig ingredients. A “whole fig” is one which is whole, but may be slightly cracked, provided it retains its natural conformation without exposing the interior. A “split” or “broken” fig is one that is open to such an extent that the seed cavity is exposed. The shape of the fruit may be distorted, and the fruit may or may not be broken apart into entirely separate pieces.

(c) *Packing media.* (1) The optional packing media referred to in paragraph (a) of this section, as defined in §145.3 are:

- (i) Water.
- (ii) Fruit juice(s) and water.
- (iii) Fruit juice(s).

Such packing media may be used as such or any one or any combination of two or more safe and suitable nutritive carbohydrate sweetener(s) may be added. Sweeteners defined in §145.3 shall be as defined therein, except that a nutritive carbohydrate sweetener for which a standard of identity has been established in part 168 of this chapter shall comply with such standard in lieu of any definition that may appear in §145.3.

(2) When a sweetener is added as a part of any such liquid packing medium, the density range of the resulting packing medium expressed as percent by weight of sucrose (degrees Brix) as determined by the procedure prescribed in §145.3(m) shall be designated by the appropriate name for the respective density ranges, namely:

(i) When the density of the solution is 11 percent or more but less than 16 percent, the medium shall be designated as “slightly sweetened water”; or “extra light sirup”; “slightly sweetened fruit juice(s) and water”; or “slightly sweetened fruit juice(s)”, as the case may be.

(ii) When the density of the solution is 16 percent or more but less than 21 percent, the medium shall be designated as “light sirup”; “lightly sweetened fruit juice(s) and water”; or “lightly sweetened fruit juice(s)”, as the case may be.

(iii) When the density of the solution is 21 percent or more but less than 26 percent, the medium shall be designated as “heavy sirup”; “heavily sweetened fruit juice(s) and water”; or “heavily sweetened fruit juice(s)”, as the case may be.

(iv) When the density of the solution is 26 percent or more but not more than 35 percent, the medium shall be designated as “extra heavy sirup”; “extra heavily sweetened fruit juice(s) and water”; or “extra heavily sweetened fruit juice(s)”, as the case may be.

(d) *Labeling requirements.* (1) The name of the food is “figs”. The words “broken” or “split” shall be a part of the name when the optional fig ingredient is a broken or split fig. The name of the food shall also include a declaration of any flavoring that characterizes the product as specified in §101.22 of this chapter and a declaration of any

§ 145.131

spice or seasoning that characterizes the product; for example, "Spice added", or in lieu of the word "Spice", the common name of the spice, "Seasoned with vinegar" or "Seasoned with unpeeled segments of citrus fruits". When two or more of the optional ingredients specified in paragraphs (a) (2) through (5), inclusive, of this section are used, such words may be combined as for example, "Seasoned with cider vinegar, cloves, cinnamon oil and unpeeled segments of citrus fruits."

(2) The name of the packing medium as used in paragraph (c)(1) of this section, preceded by "In" or "Packed in", as provided in paragraph (c) of this section, shall be included as part of the name or in close proximity to the name of the food. When the packing medium is prepared with a sweetener(s) which imparts a taste, flavor or other characteristic to the finished food other than sweetness, as for example, a mixture of brown sugar and honey, the statement "_____ sirup of brown sugar and honey" the blank to be filled in with the word "light", "heavy", or "extra heavy", as the case may be, shall be included as part of the name or in close proximity to the name of the food. When the liquid portion of the packing media provided for in paragraphs (c) (1) and (2) of this section consists of fruit juice(s), such juice(s) shall be designated in the name of the packing medium as:

(i) In the case of a single fruit juice, the name of the juice shall be used in lieu of the word "fruit";

(ii) In the case of a combination of two or more fruit juices, the names of the juices in the order of predominance by weight shall either be used in lieu of the word "fruit" in the name of the packing medium, or be declared on the label as specified in paragraph (d)(3) of this section; and

(iii) In the case of a single fruit juice or a combination of two or more fruit juices any of which are made from concentrate(s), the words "from concentrate(s)" shall follow the word "juice(s)" in the name of the packing medium and in the name(s) of such juice(s) when declared as specified in paragraph (d)(3) of this section.

(3) Whenever the names of the fruit juices used do not appear in the name

21 CFR Ch. I (4-1-07 Edition)

of the packing medium as provided in paragraph (d)(2)(ii) of this section, such names and the words "from concentrate", as specified in paragraph (d)(2)(iii) of this section, shall appear in an ingredient statement pursuant to the requirements of §101.3(d) of this chapter.

(4) Label declaration. Each of the ingredients used in the food shall be declared on the label as required by the applicable sections of parts 101 and 130 of this chapter.

[42 FR 14414, Mar. 15, 1977, as amended at 58 FR 2879, Jan. 6, 1993]

§ 145.131 Artificially sweetened canned figs.

(a) Artificially sweetened canned figs is the food which conforms to the definition and standard of identity prescribed for canned figs by §145.130, except that in lieu of a packing medium specified in §145.130(c), the packing medium used is water artificially sweetened with saccharin, sodium saccharin, or a combination of both. Such packing medium may be thickened with pectin and may contain any mixture of any edible organic salt or salts and any edible organic acid or acids as a flavor-enhancing agent, in a quantity not more than is reasonably required for that purpose.

(b)(1) The specified name of the food is "artificially sweetened _____", the blank being filled in with the name prescribed by §145.130 for canned figs having the same optional fig ingredient.

(2) The artificially sweetened food is subject to the requirements for label statement of ingredients used, as prescribed for canned figs by §145.130. If the packing medium is thickened with pectin, the label shall bear the statement "thickened with pectin". When any organic salt or acid or any mixture of two or more of these is added, the label shall bear the common or usual name of each such ingredient.

[42 FR 14414, Mar. 15, 1977, as amended at 58 FR 2880, Jan. 6, 1993]

§ 145.134 Canned preserved figs.

(a) Canned preserved figs is the food prepared from one of the optional fig ingredients specified in paragraph (b) of this section and the packing medium

specified in paragraph (c) of this section, to which citric acid or lemon juice or concentrated lemon juice is added, if necessary, in such quantity as to reduce the pH of the finished product to 4.9 or below. The figs are precooked in the packing medium, sealed in a container, and so processed by heat, either before or after sealing, as to prevent spoilage.

(b) The optional fig ingredients referred to in paragraph (a) of this section are whole mature figs of the light or dark varieties that may be either peeled or unpeeled.

(c)(1) The packing medium referred to in paragraph (a) of this section is prepared from water and one of the following optional sweetening ingredients:

(i) Sugar.

(ii) Invert sugar sirup.

(iii) Any mixture of optional sweetening ingredients designated in paragraphs (c)(1) (i) and (ii) of this section.

(iv) Any of the optional sweetening ingredients designated in paragraphs (c)(1) (i), (ii), and (iii) of this section with dextrose: *Provided*, That the weight of the solids of dextrose does not exceed one-third of the total weight of the solids of the combined sweetening ingredients.

(v) Any of the optional sweetening ingredients designated in paragraphs (c)(1) (i), (ii), and (iii) of this section with corn sirup or with dried corn sirup or with glucose sirup or with dried glucose sirup, or with any two or more of these: *Provided*, That the weight of the solids of corn sirup, dried corn sirup, glucose sirup, dried glucose sirup or the sum of the weights of the solids of corn sirup, dried corn sirup, glucose sirup, and dried glucose sirup, in case two or more of these are used, does not exceed one-fourth of the total weight of the solids of the combined sweetening ingredients.

(vi) Any mixture of the optional ingredients designated in paragraphs (c)(1) (iv) and (v) of this section.

(2) The density of the packing medium described in paragraph (c)(1) of this section, as measured on the Brix hydrometer 15 days or more after the figs are canned, is not less than 50° and not more than 55°.

(d)(1) The name of the food is "Preserved Figs—Precooked in Sirup". For the purpose of label declaration, the words "Precooked in Sirup" may appear immediately below the words "Preserved Figs", but there shall be no intervening written, printed, or graphic matter, and the letters used for the words "Precooked in Sirup" shall be of the same type style and not less than one-half the height of the letters in the words "Preserved Figs".

(2) The label shall indicate which optional fig ingredient specified in paragraph (b) of this section is used.

(e) Wherever the name of the food appears on the label so conspicuously as to be easily seen under customary conditions of purchase, the words herein specified, showing the optional fig ingredient used, shall immediately and conspicuously precede or follow such name without intervening written, printed, or graphic matter, except that the varietal name of the figs may so intervene.

(f) Label declaration. Each of the ingredients used in the food shall be declared on the label as required by the applicable sections of parts 101 and 130 of this chapter.

[42 FR 14414, Mar. 15, 1977, as amended at 58 FR 2880, Jan. 6, 1993]

§ 145.135 Canned fruit cocktail.

(a) *Identity*—(1) *Ingredients*. Canned fruit cocktail, canned cocktail fruits, canned fruits for cocktail, is the food prepared from the mixture of fresh, frozen, or previously canned fruit ingredients of mature fruits in the forms and proportions as provided in paragraph (a)(2) of this section, and one of the optional packing media specified in paragraph (a)(3) of this section. Such food may also contain one, or any combination of two or more, of the following safe and suitable optional ingredients:

(i) Natural and artificial flavors.

(ii) Spice.

(iii) Vinegar, lemon juice, or organic acids.

(iv) Ascorbic acid in an amount no greater than necessary to preserve color. Such food is sealed in a container and before or after sealing is so processed by heat as to prevent spoilage.

(2) *Varietal types and styles.* The fruit ingredients referred to in paragraph (a)(1) of this section, the forms of each, and the percent by weight of each in the mixture of drained fruit from the finished canned fruit cocktail are as follows:

(i) *Peaches.* Any firm yellow variety of the species *Prunus persica* L., excluding nectarine varieties, which are pitted, peeled, and diced, not less than 30 percent and not more than 50 percent.

(ii) *Pears.* Any variety, of the species *Pyrus communis* L. or *Pyrus sinensis* L., which are peeled, cored, and diced, not less than 25 percent and not more than 45 percent.

(iii) *Pineapples.* Any variety, of the species *Ananas comosus* L., which are peeled, cored, and cut into sectors or into dice, not less than 6 percent and not more than 16 percent.

(iv) *Grapes.* Any seedless variety, of the species *Vitis vinifera* L., or *Vitis labrusca* L., not less than 6 percent and not more than 20 percent.

(v) *Cherries.* Approximate halves or whole pitted cherries of the species *Prunus cerasus* L., not less than 2 percent and not more than 6 percent, of the following types:

(a) Cherries of any light, sweet variety;

(b) Cherries artificially colored red; or

(c) Cherries artificially colored red and flavored, natural or artificial.

Provided, That each 127.5 grams (4½ ounces avoirdupois) of the finished canned fruit cocktail and each fraction thereof greater than 56.7 grams (2 ounces avoirdupois) contain not less than 2 sectors or 3 dice of pineapple and not less than 1 approximate half of the optional cherry ingredient.

(3) *Packing media.* (i) The optional packing media referred to in paragraph (a)(1) of this section, as defined in §145.3 are:

(a) Water.

(b) Fruit juice(s) and water.

(c) Fruit juice(s).

Such packing media may be used as such or any one or any combination of two or more safe and suitable nutritive carbohydrate sweetener(s) may be added. Sweeteners defined in §145.3 shall be as defined therein, except that

a nutritive carbohydrate sweetener for which a standard of identity has been established in part 168 of this chapter shall comply with such standard in lieu of any definition that may appear in §145.3.

(ii) When a sweetener is added as a part of any such liquid packing medium, the density range of the resulting packing medium expressed as percent by weight of sucrose (degrees Brix) as determined by the procedure prescribed in §145.3(m) shall be designated by the appropriate name for the respective density ranges, namely:

(a) When the density of the solution is 10 percent or more, but less than 14 percent, the medium shall be designated as “slightly sweetened water”; or “extra light sirup”; “slightly sweetened fruit juice(s) and water”; or “slightly sweetened fruit juice(s)”, as the case may be.

(b) When the density of the solution is 14 percent or more but less than 18 percent, the medium shall be designated as “light sirup”; “lightly sweetened fruit juice(s) and water”; or “lightly sweetened fruit juice(s)”, as the case may be.

(c) When the density of the solution is 18 percent or more but less than 22 percent, the medium shall be designated as “heavy sirup”; “heavily sweetened fruit juice(s) and water”; or “heavily sweetened fruit juice(s)”, as the case may be.

(d) When the density of the solution is 22 percent or more but not more than 35 percent, the medium shall be designated as “extra heavy sirup”; “extra heavily sweetened fruit juice(s) and water”; or “extra heavily sweetened fruit juice(s)”, as the case may be.

(4) *Labeling requirements.* (i) The name of the food is “fruit cocktail”, “cocktail fruits”, or “fruits for cocktail”. The name of the food shall also include a declaration of any flavoring that characterizes the product as specified in §101.22 of this chapter and a declaration of any spice or seasoning that characterizes the product; for example, “Spice added”, or in lieu of the word “Spice”, the common name of the spice, “Seasoned with vinegar” or “Seasoned with lemon juice”. When two or more of the optional ingredients specified in paragraphs (a)(1) (ii) and

(iii) of this section are used, such words may be combined as for example, "Seasoned with cider vinegar, cloves, cinnamon oil and lemon juice".

(ii) The name of the packing medium as used in paragraphs (a)(3) (i) and (ii) of this section, preceded by "In" or "Packed in" shall be included as part of the name or in close proximity to the name of the food. When the packing medium is prepared with a sweetener(s) which imparts a taste, flavor or other characteristic to the finished food in addition to sweetness, the name of the packing medium shall be accompanied by the name of such sweetener(s), as for example, in the case of a mixture of brown sugar and honey, an appropriate statement would be "_____ sirup of brown sugar and honey" the blank to be filled in with the word "light", "heavy", or "extra heavy" as the case may be. When the liquid portion of the packing media provided for in paragraphs (a)(3) (i) and (ii) of this section consists of fruit juice(s), such juice(s) shall be designated in the packing medium as:

(a) In the case of a single fruit juice, the name of the juice shall be used in lieu of the word "fruit";

(b) In the case of a combination of two or more fruit juices, the names of the juices in the order of predominance by weight shall either be used in lieu of the word "fruit" in the name of the packing medium, or be declared on the label as specified in paragraph (a)(4)(iii) of this section; and

(c) In the case of a single fruit juice or a combination of two or more fruit juices any of which are made from concentrate(s), the words "from concentrate(s)" shall follow the word "juice(s)" in the name of the packing medium and in the name(s) of such juice(s) when declared as specified in paragraph (a)(4)(iii) of this section.

(iii) Whenever the names of the fruit juices used do not appear in the name of the packing medium as provided in paragraph (a)(4)(ii)(b) of this section, such names and the words "from concentrate", as specified in paragraph (a)(4)(ii)(c) of this section, shall appear in an ingredient statement pursuant to the requirements of §101.3(d) of this chapter.

(iv) Label declaration. Each of the ingredients used in the food shall be declared on the label as required by the applicable sections of parts 101 and 130 of this chapter.

(b) *Quality.* (1) The standard of quality for canned fruit cocktail is as follows:

(i) Not more than 20 percent by weight of the units in the container of peach or pear, or of pineapple if the units thereof are diced, are more than $\frac{3}{4}$ inch in greatest edge dimension, or pass through the meshes of a sieve designated as $\frac{5}{16}$ inch that complies with the specifications for such cloth set forth in the "Official Methods of Analysis of the Association of Official Analytical Chemists," 13th Ed. (1980), Table 1, "Nominal Dimensions of Standard Test Sieves (U.S.A. Standard Series)," under the heading "Definitions of Terms and Explanatory Notes," which is incorporated by reference. Copies may be obtained from the AOAC INTERNATIONAL, 481 North Frederick Ave., suite 500, Gaithersburg, MD 20877, or may be examined at the National Archives and Records Administration (NARA). For information on the availability of this material at NARA, call 202-741-6030, or go to: http://www.archives.gov/federal_register/code_of_federal_regulations/ibr_locations.html. If the units of pineapple are in the form of sectors, not more than 20 percent of such sectors in the container fail to conform to the following dimensions: The length of the outside arc is not more than $\frac{3}{4}$ inch but is more than $\frac{3}{8}$ inch; the thickness is not more than $\frac{1}{2}$ inch but is more than $\frac{5}{16}$ inch; the length (measured along the radius from the inside arc to the outside arc) is not more than $1\frac{1}{4}$ inches but is more than $\frac{3}{4}$ inch.

(ii) Not more than 10 percent of the grapes in a container containing 10 grapes or more, and not more than 1 grape in a container containing less than 10 grapes, are cracked to the extent of being severed into two parts or are crushed to the extent that their normal shape is destroyed.

(iii) Not more than 10 percent of the grapes in a container containing 10 grapes or more, and not more than a grape in a container containing less

than 10 grapes, have the cap stem attached.

(iv) There is present in the finished canned fruit cocktail not more than 1 square inch of pear peel per each 1 pound of drained weight of units of pear plus the weight of a proportion of the packing medium which is the same proportion as the drained weight of the units of pear bears to the drained weight of the entire contents of the can. Such drained weights shall be determined by the method prescribed in paragraph (c) of this section.

(v) There is present in the finished canned fruit cocktail not more than 1 square inch of peach peel per each 1 pound of drained weight of units of peach plus the weight of a proportion of the packing medium which is the same proportion as the drained weight of units of peach bears to the drained weight of the entire contents of the can. Such drained weights shall be determined by the method prescribed in paragraph (c) of this section.

(vi) Not more than 15 percent of the units of cherry ingredient, and not more than 20 percent of the units of peach, pear, or grape, in the container are blemished with scab, hail injury, scar tissue or other abnormality.

(vii) If the cherry ingredient is artificially colored, the color of not more than 15 percent of the units thereof in a container containing more than six units and of not more than one unit in a container containing six units or less, is other than evenly distributed in the unit or other than uniform with the color of the other units of the cherry ingredient.

(2) If the quality of canned fruit cocktail falls below the standard prescribed in paragraph (b)(1) of this section, the label shall bear the general statement of substandard quality specified in § 130.14(a) of this chapter, in the manner and form therein specified.

(c) *Fill of container.* (1) The standard of fill of container for canned fruit cocktail is a fill such that the total weight of drained fruit is not less than 65 percent of the water capacity of the container, as determined by the general method for water capacity of containers prescribed in § 130.12(a) of this chapter. Such total weight of drained fruit is determined by the following

method: Tilt the opened container so as to distribute the contents evenly over the meshes of a circular sieve which has been previously weighed. The diameter of the sieve is 8 inches if the quantity of contents of the container is less than 3 pounds, and 12 inches if such quantity is 3 pounds or more. The bottom of the sieve is woven-wire cloth that complies with the specifications for such cloth set forth under "2.38 mm (No. 8)" in Table 1, "Nominal Dimensions of Standard Test Sieves (U.S.A. Standard Series)," prescribed in paragraph (b)(1)(i) of this section, which is incorporated by reference. The availability of this incorporation by reference is given in paragraph (b)(1)(i) of this section. Without shifting the material on the sieve so incline the sieve as to facilitate drainage. Two minutes from the time drainage begins, weigh the sieve and drained fruit. The weight so found, less the weight of the sieve, shall be considered to be the total weight of drained fruit.

(2) If canned fruit cocktail falls below the standard of fill of container prescribed in paragraph (c)(1) of this section, the label shall bear the general statement of substandard fill specified in § 130.14(b) of this chapter, in the manner and form therein prescribed.

[42 FR 14414, Mar. 15, 1977, as amended at 47 FR 11829, Mar. 19, 1982; 49 FR 10100, Mar. 19, 1984; 54 FR 24895, June 12, 1989; 58 FR 2880, Jan. 6, 1993; 63 FR 14035, Mar. 24, 1998]

§ 145.136 Artificially sweetened canned fruit cocktail.

(a) Artificially sweetened canned fruit cocktail is the food which conforms to the definition and standard of identity prescribed for canned fruit cocktail by § 145.135(a), except that in lieu of a packing medium specified in § 145.135(a)(3), the packing medium used is water artificially sweetened with saccharin, sodium saccharin, or a combination of both. Such packing medium may be thickened with pectin and may contain any mixture of any edible organic salt or salts and any edible organic acid or acids as a flavor-enhancing agent, in a quantity not more than is reasonably required for that purpose.

(b)(1) The specified name of the food is "artificially sweetened fruit cocktail".

(2) The artificially sweetened food is subject to the requirements for label statement of ingredients used, as prescribed for canned fruit cocktail by §145.135(a). If the packing medium is thickened with pectin, the label shall bear the statement “thickened with pectin”. When any organic salt or acid or any mixture of two or more of these is added, the label shall bear the common or usual name of each such ingredient.

[42 FR 14414, Mar. 15, 1977, as amended at 58 FR 2880, Jan. 6, 1993]

§ 145.140 Canned seedless grapes.

(a) *Ingredients.* Canned seedless grapes is the food prepared from one of the fresh or previously canned optional grape ingredients specified in paragraph (b) of this section which may be packed in one of the optional packing media specified in paragraph (c) of this section. Such food may also contain one, or any combination of two or more, of the following safe and suitable optional ingredients:

- (1) Natural and artificial flavors.
- (2) Spice.
- (3) Vinegar, lemon juice, or organic acids.

Such food is sealed in a container and before or after sealing is so processed by heat as to prevent spoilage.

(b) *Varietal types and styles.* The optional grape ingredients referred to in paragraph (a) of this section are prepared from stemmed grapes of the light or dark seedless varieties or from unstemmed clusters of such grapes. For the purposes of paragraph (d) of this section, the names of such optional grape ingredients are “light seedless grapes” or “dark seedless grapes”, as the case may be, preceded by the words “unstemmed clusters” where applicable.

(c) *Packing media.* (1) The optional packing media referred to in paragraph (a) of this section, as defined in §145.3 are:

- (i) Water.
- (ii) Fruit juice(s) and water.
- (iii) Fruit juice(s).

Such packing media may be used as such or any one or any combination of two or more safe and suitable nutritive carbohydrate sweetener(s) may be

added. Sweeteners defined in §145.3 shall be as defined therein, except that a nutritive carbohydrate sweetener for which a standard of identity has been established in part 168 of this chapter shall comply with such standard in lieu of any definition that may appear in §145.3.

(2) When a sweetener is added as a part of any such liquid packing medium, the density range of the resulting packing medium expressed as percent by weight of sucrose (degrees Brix) as determined by the procedure prescribed in §145.3(m) shall be designated by the appropriate name for the respective density ranges, namely:

(i) When the density of the solution is less than 14 percent, the medium shall be designated as “slightly sweetened water”; or “extra light sirup”; “slightly sweetened fruit juice(s) and water”; or “slightly sweetened fruit juice(s)”, as the case may be.

(ii) When the density of the solution is 14 percent or more but less than 18 percent, the medium shall be designated as “light sirup”; “lightly sweetened fruit juice(s) and water”; or “lightly sweetened fruit juice(s)”, as the case may be.

(iii) When the density of the solution is 18 percent or more but less than 22 percent, the medium shall be designated as “heavy sirup”; “heavily sweetened fruit juice(s) and water”; or “heavily sweetened fruit juice(s)”, as the case may be.

(iv) When the density of the solution is 22 percent or more but not more than 35 percent, the medium shall be designated as “extra heavy sirup”; “extra heavily sweetened fruit juice(s) and water”; or “extra heavily sweetened fruit juice(s)”, as the case may be.

(d) *Labeling requirements.* (1) The name of the food is “seedless grapes.” The name of the food shall also include a declaration of any flavoring that characterizes the product as specified in §101.22 of this chapter and a declaration of any spice or seasoning that characterizes the product; for example, “Spice added”, or in lieu of the word “Spice”, the common name of the spice, or “Seasoned with lemon juice”. When two or more of the optional ingredients specified in paragraphs (a) (2) and (3) of this section are used, such

words may be combined as for example, "Seasoned with cider vinegar, cloves, and cinnamon oil".

(2) The color type and style of the grape ingredient as provided in paragraph (b) of this section and the name of the packing medium specified in paragraphs (c) (1) and (2) of this section, preceded by "In" or "Packed in" or the words "solid pack", where applicable, shall be included as part of the name or in close proximity to the name of the food. When the packing medium is prepared with a sweetener(s) which imparts a taste, flavor or other characteristic to the finished food in addition to sweetness, the name of the packing medium shall be accompanied by the name of such sweetener(s), as for example in the case of a mixture of brown sugar and honey, an appropriate statement would be "_____ sirup of brown sugar and honey" the blank to be filled in with the word "light", "heavy", or "extra heavy" as the case may be. When the liquid portion of the packing media provided for in paragraphs (c) (1) and (2) of this section consists of fruit juice(s), such juice(s) shall be designated in the packing medium as:

(i) In the case of a single fruit juice, the name of the juice shall be used in lieu of the word "fruit";

(ii) In the case of a combination of two or more fruit juices, the names of the juices in the order of predominance by weight shall either be used in lieu of the word "fruit" in the name of the packing medium, or be declared on the label as specified in paragraph (d)(3) of this section; and

(iii) In the case of a single fruit juice or a combination of two or more fruit juices any of which are made from concentrate(s), the words "from concentrate(s)" shall follow the word "juice(s)" in the name of the packing medium and in the name(s) of such juice(s) when declared as specified in paragraph (d)(3) of this section.

(3) Whenever the names of the fruit juices used do not appear in the name of the packing medium as provided in paragraph (d)(2)(ii) of this section, such names and the words "from concentrate", as specified in paragraph (d)(2)(iii) of this section, shall appear in an ingredient statement pursuant to

the requirements of §101.3(d) of this chapter.

(4) Label declaration. Each of the ingredients used in the food shall be declared on the label as required by the applicable sections of parts 101 and 130 of this chapter.

[42 FR 14414, Mar. 15, 1977, as amended at 58 FR 2880, Jan. 6, 1993]

§ 145.145 Canned grapefruit.

(a) *Identity*—(1) *Product identification*. Canned grapefruit is the food prepared from one of the optional grapefruit ingredients specified in paragraph (a)(2) of this section and one of the optional packing media specified in paragraph (a)(3) of this section. Such food may also contain one or more of the following safe and suitable optional ingredients:

(i) Spices.

(ii) Natural and artificial flavoring.

(iii) Lemon juice.

(iv) Citric acid.

(v) Calcium chloride or calcium lactate or a mixture of the two calcium salts in a quantity reasonably necessary to firm the grapefruit sections, but in no case in a quantity such that the calcium contained in such calcium salt or mixture is more than 0.035 percent by weight of the finished food.

Such food is sealed in a container and, before or after sealing, is so processed by heat as to prevent spoilage.

(2) *Optional grapefruit ingredient*. The optional grapefruit ingredients referred to in paragraph (a)(1) of this section are prepared from sound, mature grapefruit (*Citrus paradisi* Macfadyen) of the color types white—produced from white-fleshed grapefruit, and pink—produced from pink or red-fleshed grapefruit and are in the following forms of units: Whole sections or broken sections. Each such form of units or a mixture of such forms of units prepared from a single varietal group (color type) is an optional grapefruit ingredient. The core, seeds, and major portions of membrane of such ingredient are removed. For the purpose of this section, a grapefruit section is considered whole when the unit is intact or an intact portion of such unit is not less than 75 percent of its apparent

original size and is not excessively trimmed.

(i) For the purpose of paragraph (a)(4) of this section, the name of the optional grapefruit ingredient is:

(a) "Section" or "segments", if 50 percent or more of the drained weight of the food consists of whole sections.

(b) "Broken sections" or "broken segments", if less than 50 percent of the drained weight of the food consists of whole sections.

(ii) The drained weight is determined by the method prescribed in the standard of fill of container for canned grapefruit set forth in paragraph (c)(2) of this section.

(3) *Packing media.* (i) The optional packing media referred to in paragraph (a)(1) of this section are:

(a) Water.

(b) Grapefruit juice and water.

(c) Grapefruit juice.

(d) Slightly sweetened sirup or slightly sweetened water.

(e) Light sirup.

(f) Heavy sirup.

(g) Slightly sweetened grapefruit juice and water.

(h) Lightly sweetened grapefruit juice and water.

(i) Heavily sweetened grapefruit juice and water.

(j) Slightly sweetened grapefruit juice.

(k) Lightly sweetened grapefruit juice.

(l) Heavily sweetened grapefruit juice.

As used in paragraph (a)(3)(i) of this section, the optional packing medium "water" means, in addition to water, any mixture of water and grapefruit juice in which there is less than 50 percent grapefruit juice; the optional packing medium "grapefruit juice and water" means the liquid packing medium in which juice of mature grapefruit and water are combined as a liquid packing medium with not less than 50 percent grapefruit juice and the term "grapefruit juice" means single strength expressed juice of sound, mature fruit. It may be fresh, canned, or made from concentrate. However, if it is made from concentrate, the juice shall be reconstituted with water to not less than the soluble solids the

grapefruit juice had before concentration.

(ii) Each of the packing media in paragraph (a)(3)(i) (d) to (l) of this section is prepared with a liquid ingredient and one or more safe and suitable nutritive carbohydrate sweeteners. Water is the liquid ingredient from which packing media in paragraph (a)(3)(i) (d) to (f) of this section are prepared. Grapefruit juice and water are the liquid ingredients from which the packing media in paragraph (a)(3)(i) (g) to (i) of this section are prepared. Grapefruit juice is the liquid ingredient from which the packing media in paragraph (a)(3)(i) (j) to (l) of this section are prepared. If one or more liquid nutritive carbohydrate sweeteners and grapefruit juice are combined as a liquid packing medium with not less than 50 percent grapefruit juice, the packing medium is as set forth in paragraph (a)(3)(i) (g) to (i) of this section.

(iii) The respective densities of packing media in paragraph (a)(3)(i) (d) to (i) of this section as measured on the refractometer, expressed as percent by weight sucrose (degrees Brix) with correction for temperature to the equivalent at 20 °C (68 °F), 15 days or more after the grapefruit are canned or the blended homogenized slurry of the comminuted entire contents of the container if canned for less than 15 days, according to the "Official Methods of Analysis of the Association of Official Analytical Chemists" (AOAC), 13th Ed. (1980), section 31.011 under "Solids By Means of Refractometer—Official Final Action," and Reference Tables, section 52.012 (Refractive indices (n) of sucrose solutions at 20°) and section 52.015 (Refractive indices of invert sugar solutions), which is incorporated by reference (copies may be obtained from the AOAC INTERNATIONAL, 481 North Frederick Ave., suite 500, Gaithersburg, MD 20877, or may be examined at the National Archives and Records Administration (NARA). For information on the availability of this material at NARA, call 202-741-6030, or go to: http://www.archives.gov/federal_register/code_of_federal_regulations/ibr_locations.html), but without correction for invert sugar or other substances, are as follows:

(a) Packing media in paragraph (a)(3)(i) (d), (g), and (j) of this section: Twelve percent or more but less than 16 percent.

(b) Packing media in paragraph (a)(3)(i) (e), (h), and (k) of this section: Sixteen percent or more but less than 18 percent.

(c) Packing media in paragraph (a)(3)(i) (f), (i), and (l) of this section: Eighteen percent or more. A lot shall be deemed to be in compliance for packing medium density based on the average value for all the samples analyzed according to paragraph (b)(2) of this section but no container may have a value lower than that of the next lower category or 2 percent by weight sucrose (degrees Brix) lower if no lower category exists.

(4) *Labeling requirements.* (i) The name of the food is “grapefruit” or “pink grapefruit”, as appropriate for the color type of the grapefruit used. The name of the food shall also include a declaration of any flavoring that characterizes the product as specified in §101.22 of this chapter and a declaration of any spice or seasoning that characterizes the product; for example, “with added spice”. Whenever the word “sirup” is used, it may be alternatively spelled “syrup”. When two or more of the optional ingredients specified in paragraphs (a)(1) (i), (ii), and (iii) of this section are used, such words may be combined; for example, “with added cloves and cinnamon oil”.

(ii) The form and style of the grapefruit ingredient as provided for in paragraph (a)(2) of this section and the name of the packing medium as used in paragraph (a)(3) of this section preceded by “In” or “Packed in” shall be included as part of the name. When the packing medium is prepared from concentrated grapefruit juice, the words “from concentrate” shall follow the words “grapefruit juice” in the name of the packing medium.

(iii) Label declaration. Each of the ingredients used in the food shall be declared on the label as required by the applicable sections of parts 101 and 130 of this chapter.

(b) *Quality.* (1) The standard of quality for canned grapefruit is as follows:

(i) The food is free from extraneous material such as leaves, portions of leaves, and pieces of peel.

(ii) The finished food contains per 500 grams (17.6 ounces) not more than:

(a) An aggregate area of 20 square centimeters (3.1 square inches) of tough membrane or albedo on the units.

(b) Four developed seeds. A seed is considered a developed seed when it measures more than 9.0 millimeters (0.35 inches) in any dimension.

(iii) Not more than 15 percent by weight of the drained grapefruit may be blemished units. A blemished unit is a grapefruit section or any portion thereof which is damaged by lye peeling, by discoloration, or by other visible injury. The drained weight is determined by the method prescribed in the standard of fill of container for canned grapefruit set forth in paragraph (c)(2) of this section.

(2) *Sampling and acceptance procedure.* A lot is to be considered acceptable when the number of “defectives” does not exceed the acceptance number in the sampling plans given in paragraph (b)(2)(ii) of this section.

(i) Definitions of terms to be used in the sampling plans in paragraph (b)(2)(ii) of this section are as follows:

(a) *Lot.* A collection of primary containers or units of the same size, type and style manufactured or packed under similar conditions and handled as a single unit of trade.

(b) *Lot size.* The number of primary containers or units in the lot.

(c) *Sample size (n).* The total number of sample units drawn for examination from a lot.

(d) *Sample unit.* A container, the entire contents of a container, a portion of the contents of a container, or a composite mixture of product from small containers that is sufficient for the examination or testing as a single unit.

(e) *Defective.* Any sample unit shall be regarded as defective when any of the defects or conditions specified in the quality standard (paragraph (b)(1) of this section) and paragraph (c)(3)(i) of this section for minimum fill of container are present in excess of the stated tolerances.

(f) *Accepted number (c)*. The maximum number of defective sample units permitted in the sample in order to consider the lot as meeting the specified requirements.

(g) *Acceptable quality level (AQL)*. The maximum percent of defective sample units permitted in a lot that will be accepted approximately 95 percent of the time.

(ii) Sampling plans and acceptance procedure:

Lot size (primary containers)	Size of container	
	<i>n</i> ¹	<i>c</i> ²
NET WEIGHT EQUAL TO OR LESS THAN 1 KG (2.2 LB)		
4,800 or less	13	2
4,801–24,000	21	3
24,001–48,000	29	4
48,001–84,000	48	6
84,001–144,000	84	9
144,001–240,000	126	13
Over 240,000	200	19
NET WEIGHT GREATER THAN 1 KG (2.2 LB) BUT NOT MORE THAN 4.5 KG (10 LB)		
2,400 or less	13	2
2,401–15,000	21	3
15,001–24,000	29	4
24,001–42,000	48	6
42,001–72,000	84	9
72,001–120,000	126	13
Over 120,000	200	19
NET WEIGHT GREATER THAN 4.5 KG (10 LB)		
600 or less	13	2
601–2,000	21	3
2,001–7,200	29	4
7,201–15,000	48	6
15,001–24,000	84	9
24,001–42,000	126	13
Over 42,000	200	19

¹ *n*=number of primary containers in sample
² *c*=acceptance number

(3) If the quality of canned grapefruit falls below the standard prescribed in paragraph (b)(1) of this section, the label shall bear the general statement of substandard quality specified in §130.14(a) of this chapter, in the manner and form therein specified; however, if the quality of the canned grapefruit falls below standard with respect to only one of the factors of quality specified by paragraph (b)(1) (i), (ii), or (iii) of this section, there may be substituted for the second line of such general statement of substandard quality, "Good Food—Not High Grade", a new line as specified after the corresponding designation of paragraph

(b)(1) of this section which the canned grapefruit fail to meet:

- (i) "Contains extraneous material".
- (ii)(a) "Excessive tough membrane".
- (b) "Excessive seeds".
- (iii) "Excessive blemished units".

(c) *Fill of container*.(1) The standard of fill of container for canned grapefruit is:

(i) The fill of grapefruit and packing medium, as determined by the general method for fill of container prescribed in §130.12(b) of this chapter, is not less than 90 percent of the total capacity of the container.

(ii) The drained weight of grapefruit ingredient is not less than 50 percent of the water capacity of the container, as determined by the method prescribed in paragraph (c)(2) of this section and the general method for water capacity of containers prescribed in §130.12(a) of this chapter.

(2) Drained weight is determined by the following method: Tilt the opened container so as to distribute the contents evenly over the meshes of a circular sieve which has previously been weighed. The diameter of the sieve is 20.3 centimeters (8 inches) if the quantity of contents of the container is less than 1.4 kilograms (3 pounds) and 30.5 centimeters (12 inches) if such quantity is 1.4 kilograms (3 pounds) or more. The bottom of the sieve is woven-wire cloth that complies with the specifications for the No. 8 sieve set forth in the "Definitions of Terms and Explanatory Notes" of the AOAC, 13th Ed. (1980), Table 1, which is incorporated by reference. The availability of this incorporation by reference is given in paragraph (a)(3)(iii) of this section. Without shifting the material on the sieve, incline the sieve at an angle of 17° to 20° to facilitate drainage. Two minutes after the drainage begins, weigh the sieve and drained grapefruit. The weight so found, less the weight of the sieve, shall be considered to be the weight of the drained grapefruit.

(3)(i) A container that falls below the requirement for minimum fill prescribed in paragraph (c)(1)(i) of this section shall be considered a "defective". The food will be deemed to fall below the standard of fill when the number of defectives exceeds the acceptance number (c) in the sampling

§ 145.170

21 CFR Ch. I (4-1-07 Edition)

plans prescribed in paragraph (b)(2) of this section.

(ii) Canned grapefruit will be deemed to fall below the standard of fill when the average drained weight of all containers analyzed when sampled according to the sampling plans prescribed in paragraph (b)(2) of this section is less than that prescribed in paragraph (c)(1)(ii) of this section.

(4) If canned grapefruit falls below the standard of fill of container prescribed in paragraph (c)(1) of this section, the label shall bear the statement of substandard fill specified in §130.14(b) of this chapter, in the manner and form therein specified.

[42 FR 14414, Mar. 15, 1977, as amended at 47 FR 11830, Mar. 19, 1982; 49 FR 10100, Mar. 19, 1984; 54 FR 24895, June 12, 1989; 58 FR 2880, Jan. 6, 1993; 63 FR 14035, Mar. 24, 1998]

§ 145.170 Canned peaches.

(a) *Identity*—(1) *Ingredients*. Canned peaches is the food prepared from one of the fresh, frozen, or previously canned optional peach ingredients *Prunus persica* L., of commercial canning varieties, but excluding nectarine varieties, specified in paragraph (a)(2) of this section, which may be packed as a solid pack or in one of the optional packing media specified in paragraph (a)(3) of this section. Such food may also contain one, or any combination of two or more, of the following safe and suitable optional ingredients:

(i) Natural and artificial flavors.

(ii) Spice.

(iii) Vinegar, lemon juice, or organic acids.

(iv) Peach pits, except in the cases of peeled whole peaches, in a quantity not more than 1 peach pit to each 227 grams (8 ounces) of finished canned peaches.

(v) Peach kernels, except in the cases of peeled whole peaches and except when the optional ingredient in paragraph (a)(1)(iv) of this section is used.

(vi) Ascorbic acid in an amount no greater than necessary to preserve color. Such food is sealed in a container and before or after sealing is so processed by heat as to prevent spoilage.

(2) *Varietal types and styles*. The optional peach ingredients referred to in paragraph (a)(1) of this section are pre-

pared from mature peaches of the following optional varietal and color types and styles of peach ingredients; namely:

(i) *The optional varietal types*. (a) *Freestone* is the distinct varietal type where the pit separates readily from the flesh.

(b) *Clingstone* is the distinct varietal type where the pit adheres to the flesh.

(ii) *The optional color types*—(a) *Yellow*—the varietal types in which the predominant color ranges from pale yellow to rich red orange.

(b) *White*—the varietal types in which the predominant color ranges from white to yellow-white.

(c) *Red*—the varietal types in which the predominant color ranges from pale yellow to orange red and with variegated red coloring other than that associated with the pit cavity.

(d) *Green*—varietal types in which the flesh has a green tint even when mature.

(iii) *The optional styles of the peach ingredients*—(a) *Whole*—consisting of whole peeled unpitted peaches.

(b) *Halves*—consisting of peeled pitted peaches cut into two approximately equal parts.

(c) *Halves and pieces*—consisting of a mixture in which the peeled pitted peach halves are more than 50 percent by weight.

(d) *Quarters*—consisting of peeled pitted peaches cut into four approximately equal parts.

(e) *Slices*—consisting of peeled pitted peaches cut into wedge-shaped sectors.

(f) *Dice*—consisting of peeled pitted peaches cut into cube-like parts.

(g) *Chunky*—consisting of peeled pitted peaches cut into parts 13 millimeters (0.5 inch) or greater in the smallest dimension and 44 millimeters (1.75 inches) or less in the largest dimension.

(h) *Pieces or irregular pieces*—consisting of peeled pitted peaches cut into parts of irregular shapes and sizes.

(3) *Packing media*. (i) The optional packing media referred to in paragraph (a)(1) of this section, as defined in §145.3 are:

(a) Water.

(b) Fruit juice(s) and water.

(c) Fruit juice(s).

Such packing media may be used as such or any one or any combination of two or more safe and suitable nutritive carbohydrate sweetener(s) may be added. Sweeteners defined in §145.3 shall be as defined therein, except that a nutritive carbohydrate sweetener for which a standard of identity has been established in part 168 of this chapter shall comply with such standard in lieu of any definition that may appear in §145.3.

(ii) When a sweetener is added as a part of any such liquid packing medium, the density range of the resulting packing medium, expressed as percent by weight of sucrose (degrees Brix) as determined by the procedure prescribed in §145.3(m), shall be designated by the appropriate name for the respective density ranges, namely:

(a) When the density of the solution is 10 percent or more but less than 14 percent, the medium shall be designated as "slightly sweetened water"; or "extra light sirup"; "slightly sweetened fruit juice(s) and water"; or "slightly sweetened fruit juice(s)", as the case may be.

(b) When the density of the solution is 14 percent or more but less than 18 percent, the medium shall be designated as "light sirup"; "lightly sweetened fruit juice(s) and water"; or "lightly sweetened fruit juice(s)", as the case may be.

(c) When the density of the solution is 18 percent or more but less than 22 percent, the medium shall be designated as "heavy sirup"; "heavily sweetened fruit juice(s) and water"; or "heavily sweetened fruit juice(s)", as the case may be.

(d) When the density of the solution is 22 percent or more but not more than 35 percent, the medium shall be designated as "extra heavy sirup"; "extra heavily sweetened fruit juice(s) and water"; or "extra heavily sweetened fruit juice(s)" as the case may be.

(4) *Labeling requirements.* (i) The name of the food is "peaches". The optional varietal type as set forth in paragraph (a)(2)(i) of this section shall be a part of the name. The name of the food shall also include a declaration of any flavoring that characterizes the product as specified in §101.22 of this chapter and a declaration of any spice or sea-

soning that characterizes the product; for example, "Spice added", or in lieu of the word "Spice", the common name of the spice, "Seasoned with vinegar" or "Seasoned with peach kernels". When two or more of the optional ingredients specified in paragraphs (a)(1) (ii) through (v) of this section are used, such words may be combined as for example, "Seasoned with cider vinegar, cloves, cinnamon oil and peach kernels".

(ii) The color type and style of the peach ingredient as provided for in paragraphs (a)(2) (ii) and (iii) of this section and the name of the packing medium specified in paragraphs (a)(3) (i) and (ii) of this section, preceded by "In" or "Packed in" or the words "Solid pack", where applicable, shall be included as part of the name or in close proximity to the name of the food, except that "Halves" may be alternately designated as "Halved", "Halves and pieces" as "Halved and pieces", "Quarters" as "Quartered", "Slices" as "Sliced", and "Dice" as "Diced". Pieces or irregular pieces shall be designated "Pieces", "Irregular pieces", or "Mixed pieces of irregular sizes and shapes". "Chunky" may be designated as "Chunks". The terms "Cling" and "Free" may be used as optional designations for "Clingstone" and "Freestone", respectively. When the packing medium is prepared with a sweetener(s) which imparts a taste, flavor, or other characteristic to the finished food in addition to sweetness, the name of the packing medium shall be accompanied by the name of such sweetener(s); as for example in the case of a mixture of brown sugar and honey, an appropriate statement would be "_____ sirup of brown sugar and honey" the blank to be filled in with the word "light", "heavy", or "extra heavy" as the case may be. When the liquid portion of the packing media provided for in paragraphs (a)(3) (i) and (ii) of this section consists of fruit juices(s), such juice(s) shall be designated in the name of the packing medium as:

(a) In the case of a single fruit juice, the name of the juice shall be used in lieu of the word "fruit";

(b) In the case of a combination of two or more fruit juices, the names of

the juices in the order of predominance by weight shall either be used in lieu of the word "fruit" in the name of the packing medium, or be declared on the label as specified in paragraph (a)(4)(iii) of this section; and

(c) In the case of a single fruit juice or a combination of two or more fruit juices any of which are made from concentrate(s), the words "from concentrate(s)" shall follow the word "juices(s)" in the name of the packing medium and in the name(s) of such juice(s) when declared as specified in paragraph (a)(4)(iii) of this section.

(iii) Whenever the names of the fruit juices used do not appear in the name of the packing medium as provided in paragraph (a)(4)(ii)(b) of this section, such names and the words "from concentrate", as specified in paragraph (a)(4)(ii)(c) of this section, shall appear in an ingredient statement pursuant to the requirements of §101.3(d) of this chapter.

(iv) Label declaration. Each of the ingredients used in the food shall be declared on the label as required by the applicable sections of parts 101 and 130 of this chapter.

(b) *Quality.* (1) The standard of quality for canned peaches is as follows:

(i) *Maturity.* All units tested in accordance with the method prescribed in paragraph (b)(2) of this section are pierced by weight of not more than 300 grams (10.6 ounces).

(ii) *Minimum size.* In the case of halves and quarters styles, the weight of each unit is not less than 17 grams (0.6 ounce) and 8.5 grams (0.3 ounce), respectively.

(iii) *Uniformity of size—(a) Whole, halves, and quarters.* In the case of whole, halves, and quarters styles, the diameter (width) of the largest unit is not more than 1.5 centimeters (0.6 inch) greater than the diameter (width) of the smallest unit. In containers with more than 20 units, 2 units may be disregarded in making the determination. Where a unit has broken in the container, the combined broken pieces are to be reassembled to approximate a single unit of the appropriate style.

(b) *Chunky.* In the case of chunky style, not more than 25 percent of the drained weight of the contents of the container consists of units that will

pass through an opening 13 millimeters (0.5 inch) wide or that are more than 44 millimeters (1.75 inches) along the longest cut edge.

(iv) *Peel.* Not more than 15 square centimeters aggregate area of peel per 1,000 grams (1.05 square inches per 16 ounces) of net weight. Include any peel adhering to the peach or loose in the container.

(v) *Blemished units.* Not more than 20 percent by count of the units in the container are blemished, e.g., with scab, hail injury, discoloration, or other abnormalities. Blemished units are units which contain surface discolorations that definitely contrast with the overall color and may penetrate into the flesh.

(vi) *Trimmed units.* In the case of whole, halves, quarters, and slices styles, all units are untrimmed or are so trimmed as to preserve normal shape of the units.

(vii) *Crushed or broken units.* In the case of whole, halves, halves and pieces, quarters, slices, dice and chunky styles, not more than 5 percent by count of the units in containers of 20 or more units and not more than 1 unit in containers of fewer than 20 units are crushed or broken. A unit that has lost its normal shape because of ripeness and bears no mark of crushing shall not be considered crushed or broken.

(viii) *Pits and pieces of pit.* In the case of all styles, except whole peaches and when whole peach pits or peach kernels are used as seasoning ingredients, there is not more than one loose pit or one loose large hard piece of pit (10 millimeters ($\frac{3}{8}$ inch) or larger) or one unit of peach (e.g., peach half or peach slice) to which one or more large hard pieces of pit are attached per 5.67 kilograms (200 ounces) net weight. In addition, there is not more than three of any one or any combination of two or more, per 2.83 kilograms (100 ounces) net weight of the following: (a) A unit to which one or more small hard pieces of pit less than 10 millimeters ($\frac{3}{8}$ inch) but not less than 1.6 millimeters ($\frac{1}{16}$ inch) are attached, (b) a unit to which three or more small pieces of pit less than 1.6 millimeters ($\frac{1}{16}$ inch) are attached, or (c) a loose small hard piece of pit less than 10 millimeters ($\frac{3}{8}$ inch).

(2) Canned peaches shall be tested by the following method to determine whether or not they meet the requirements of paragraph (b)(1)(i) of this section: So trim a test piece from the unit as to fit, with peel surface up, into a supporting receptacle. If the unit is of different firmness in different parts of its peel surface, trim the piece from the firmest part. If the piece is unpeeled, remove the peel. The top of the receptacle is circular in shape, of 29 millimeters (1.125 inches) inside diameter, with vertical sides; or rectangular in shape, 19 millimeters (0.75 inch) by 25 millimeters (1 inch) inside measurements, with ends vertical and sides sloping downward and joining at the center at a vertical depth of 19 millimeters (0.75 inch). Use the circular receptacle for testing units of such size that a test piece can be trimmed therefrom to fit it. Use the rectangular receptacle for testing other units. Test no unit from which a test piece with a rectangular peel surface at least 13 millimeters (0.51 inch) by 25 millimeters (1 inch) cannot be trimmed. Test the piece by means of a round metal rod 4 millimeters (0.16 inch) in diameter. To the upper end of the rod is affixed a device to which weight can be added. The rod is held vertically by a support through which it can freely move upward or downward. The lower end of the rod is a plane surface to which the vertical axis of the rod is perpendicular. Adjust the combined weight of the rod and device to 100 grams (3.53 ounces). Set the receptacle so that the surface of test piece is held horizontally. Lower the end of the rod to the approximate center of such surface, and add weight to the device at a uniform, continuous rate of 12 grams (0.45 ounce) per second until the rod pierces the test piece. Weigh the rod and weighted device. Test all units in containers of 50 units or less, except those units too small for testing or too soft for trimming. Test at least 50 units, taken at random, in containers of more than 50 units; but if less than 50 units are of sufficient size and firmness for testing, test those which are of sufficient size and firmness.

(3) Determine compliance as specified in §145.3(o) except that a lot shall be deemed to be in compliance for peel,

pits, and pieces of pit based on the average of all samples analyzed according to the sampling plans set out in §145.3(p).

(4) If the quality of canned peaches falls below the standard prescribed in paragraph (b)(1) of this section, the label shall bear the general statement of substandard quality defined in §130.14(a) of this chapter, in the manner and form therein specified; however, if the quality of the canned peaches falls below standard with respect to only one of the factors of quality specified in paragraph (b)(1) (i) through (viii) of this section, there may be substituted for the second line of such general statement of substandard quality ("Good Food—Not High Grade") a new line, as specified after the corresponding designation of paragraph (b)(1) of this section which the canned peaches fail to meet, as follows: (i) "Not tender"; (ii) "Small halves" or "Small quarters" as the case may be; (iii) (a) "Mixed sizes"; (b) "Undersized and/or oversized pieces"; (iv) "Excess peel"; (v) "Blemished"; (vi) "Unevenly trimmed"; (vii) "Partly crushed or broken"; (viii) "Contains pits or pit fragments". Such alternative statement shall immediately and conspicuously precede or follow, without intervening written, printed, or graphic matter, the name "peaches" and any words and statements required or authorized to appear with such name by paragraph (a)(2) of this section.

(c) *Fill of container.* (1) The standard of fill of container for canned peaches is the maximum quantity of the optional peach ingredient that can be sealed in the container and processed by heat to prevent spoilage, without crushing or breaking such ingredient.

(2) If canned peaches fall below the standard of fill of container prescribed in paragraph (c)(1) of this section, the label shall bear the general statement of substandard fill specified in §130.14(b) of this chapter, in the manner and form therein specified.

[42 FR 14414, Mar. 15, 1977, as amended at 46 FR 33028, June 26, 1981; 50 FR 34677, Aug. 27, 1985; 51 FR 11434, Apr. 3, 1986; 58 FR 2880, Jan. 6, 1993]

§ 145.171 Artificially sweetened canned peaches.

(a) Artificially sweetened canned peaches is the food which conforms to the definition and standard of identity prescribed for canned peaches by §145.170(a), except that in lieu of a packing medium specified in §145.170(a)(3), the packing medium used is water artificially sweetened with saccharin, sodium saccharin, or a combination of both. Such packing medium may be thickened with pectin and may contain any mixture of any edible organic salt or salts and any edible organic acid or acids as a flavor-enhancing agent, in a quantity not more than is reasonably required for that purpose.

(b)(1) The specified name of the food is “artificially sweetened _____”, the blank being filled in with the name prescribed by §145.170(a) for canned peaches having the same optional peach ingredient.

(2) The artificially sweetened food is subject to the requirements for label statement of ingredients used, as prescribed for canned peaches by §145.170(a). If the packing medium is thickened with pectin, the label shall bear the statement “thickened with pectin”. When any organic salt or acid or any mixture of two or more of these is added, the label shall bear the common or usual name of each such ingredient.

[42 FR 14414, Mar. 15, 1977, as amended at 58 FR 2880, Jan. 6, 1993]

§ 145.175 Canned pears.

(a) *Identity*—(1) *Ingredients*. Canned pears is the food prepared from one of the fresh or previously canned optional pear ingredients *Pyrus communis* or *Pyrus sinensis* specified in paragraph (a)(2) of this section which may be packed in one of the optional packing media specified in paragraph (a)(3) of this section. Such food may also contain one, or any combination of two or more, of the following safe and suitable optional ingredients.

- (i) Natural and artificial flavors.
- (ii) Spice.
- (iii) Vinegar, lemon juice, or organic acids.
- (iv) Artificial colors.

Such food is sealed in a container and before or after sealing is so processed by heat as to prevent spoilage.

(2) *Styles and forms of units*. The optional pear styles and forms of units referred to in paragraph (a)(1) of this section are:

(i) *Whole*—consisting of peeled or unpeeled pears with cores removed or left in.

(ii) *Halves*—consisting of peeled or unpeeled pears with cores removed and cut into two approximately equal parts.

(iii) *Quarters*—consisting of peeled pears with cores removed and cut into four approximately equal parts.

(iv) *Slices*—consisting of peeled pears with cores removed and cut into wedge-shaped sectors.

(v) *Dice*—consisting of peeled pears with cores removed and cut into cube-like parts.

(vi) *Pieces or irregular pieces*—consisting of peeled pears with cores removed and cut into parts of irregular shapes and sizes.

(vii) *Chunky*—consisting of peeled pears with cores removed and cut into parts 13 millimeters (0.51 inch) or greater in the smallest dimension and 44 millimeters (1.75 inches) or less in the largest dimension.

(3) *Packing media*. (i) The optional packing media referred to in paragraph (a)(1) of this section, as defined in §145.3 are:

- (a) Water.
- (b) Fruit juice(s) and water.
- (c) Fruit juice(s).
- (d) Clarified juice.

Such packing media may be used as such or any one or any combination of two or more safe and suitable nutritive carbohydrate sweetener(s) may be added. Sweeteners defined in §145.3 shall be as defined therein, except that a nutritive carbohydrate sweetener for which a standard of identity has been established in part 168 of this chapter shall comply with such standard in lieu of any definition that may appear in §145.30.

(ii) If the concentration of clarified juice is such that the packing medium forms to the density range for one of the sirups under paragraph (a)(3)(ii) (a), (b), (c), or (d) of this section, the concentrated clarified juice is considered

to be light sirup, heavy sirup, or extra heavy sirup, as the case may be. When a sweetener is added as a part of any such liquid packing medium, the density range of the resulting packing medium expressed as percent by weight of sucrose (degrees Brix) as determined by the procedure in §145.3(m) shall be designated by the appropriate name for the respective density ranges, namely:

(a) When the density of the solution is less than 14 percent, the medium shall be designated as "slightly sweetened water"; or "extra light sirup"; "slightly sweetened fruit juice(s) and water"; or "slightly sweetened fruit juice(s)", as the case may be.

(b) When the density of the solution is 14 percent or more but less than 18 percent, the medium shall be designated as "light sirup"; "lightly sweetened fruit juice(s) and water"; or "lightly sweetened fruit juice(s)" as the case may be.

(c) When the density of the solution is 18 percent or more but less than 22 percent, the medium shall be designated as "heavy sirup"; "heavily sweetened fruit juice(s) and water"; or "heavily sweetened fruit juice(s)", as the case may be.

(d) When the density of the solution is 22 percent or more but not more than 35 percent, the medium shall be designated as "extra heavy sirup"; "extra heavily sweetened fruit juice(s) and water"; or "extra heavily sweetened fruit juice(s)", as the case may be.

(4) *Labeling requirements.* (i) The name of the food is "pears". The name of the food shall also include a declaration of any flavoring that characterizes the product as specified in §101.22 of this chapter and a declaration of any spice or seasoning that characterizes the product; for example, "Spice added", or in lieu of the word "Spice", the common name of the spice, "Seasoned with vinegar". When two or more of the optional ingredients specified in paragraphs (a)(1) (ii) and (iii) of this section are used, such words may be combined as for example, "Seasoned with cider vinegar, cloves, and cinnamon oil".

(ii) The style and forms of units of the pear ingredient as provided in paragraph (a)(2) of this section and the name of the packing medium specified in paragraph (a)(3) (i) and (ii) of this

section, preceded by "In" or "Packed in" or the words "Solid pack", where applicable, shall be included as part of the name or in close proximity to the name of the food, except that "Halves" may be alternatively designated as "Halved", "Quarters" as "Quartered", "Slices" as "Sliced", and "Dice" as "Diced". "Pieces" or "Irregular pieces" shall be designated as "Pieces", "Irregular pieces", or "Mixed pieces of irregular sizes and shapes". "Chunky" may be designated as "Chunks". The style of the pear ingredient shall be preceded or followed by "Unpeeled" when the units are whole or halves and are unpeeled. When the packing medium is prepared with a sweetener(s) which imparts a taste, flavor or other characteristic to the finished food in addition to sweetness, the name of the packing medium shall be accompanied by the name of such sweetener(s), as for example in the case of a mixture of brown sugar and honey, an appropriate statement would be "_____ sirup of brown sugar and honey" the blank to be filled in with the word "light", "heavy", or "extra heavy", as the case may be. When the liquid portion of the packing media provided for in paragraphs (a)(3) (i) and (ii) of this section consists of fruit juice(s), such juice(s) shall be designated in the name of the packing medium as:

(a) In the case of a single fruit juice, the name of the juice shall be used in lieu of the word "fruit";

(b) In the case of a combination of two or more fruit juices, the names of the juices in the order of predominance by weight shall either be used in lieu of the word "fruit" in the name of the packing medium, or be declared on the label as specified in paragraph (a)(4)(iii) of this section; and

(c) In the case of a single fruit juice or a combination of two or more fruit juices any of which are made from concentrate(s), the words "from concentrate(s)" shall follow the word "juice(s)" in the name of the packing medium and in the name(s) of such juice(s) when declared as specified in paragraph (a)(4)(iii) of this section.

(iii) Whenever the names of the fruit juices used do not appear in the name of the packing medium as provided in

paragraph (a)(4)(ii)(b) of this section, such names and the words “from concentrate”, as specified in paragraph (a)(4)(ii)(c) of this section, shall appear in an ingredient statement pursuant to the requirements of §101.3(d) of this chapter.

(iv) *Label declaration.* Each of the ingredients used in the food shall be declared on the label as required by the applicable sections of parts 101 and 130 of this chapter.

(b) *Quality.* (1) The standard of quality for canned pears is as follows:

(i) *Maturity.* All units tested in accordance with the method prescribed in paragraph (b)(2) of this section are pierced by a weight of not more than 300 grams (10.6 ounces).

(ii) *Minimum size.* In the case of halves and quarters styles, the weight of each unit is not less than 17 grams (0.6 ounce) and 8.5 grams (0.3 ounce), respectively.

(iii) *Uniformity of size—(a) Whole, halves, and quarters.* In the case of whole, halves, and quarters styles, among those units comprising 95 percent by count of those present in the container that are most uniform in size, the weight of the largest unit is not more than twice the weight of the smallest unit. In containers with fewer than 20 units, 1 unit may be disregarded in making the determination. Where a unit has broken in the container, reassemble the broken pieces to approximate a single unit of the appropriate style.

(b) *Chunky.* In the case of chunky style, not more than 25 percent of the drained weight of the contents of the container consists of units that will pass through an opening 13 millimeters (0.51 inch) wide or that are more than 44 millimeters (1.75 inches) along the longest cut edge.

(iv) *Peel (except unpeeled style).* Not more than 10 square centimeters (1.6 square inches) of peel adhering to pears or loose in the container per kilogram (35.3 ounces) of net weight.

(v) *Blemished units.* Not more than 20 percent by count of the units in the container are blemished with scab, hail injury, discoloration, or other abnormality aggregating the area of a circle more than 6.5 millimeters (0.25 inch) in diameter; corky or hard spots on outer

surfaces aggregating the area of a circle more than 13 millimeters (0.51 inch) in diameter; or dark brown areas aggregating the area of a circle less than 6.5 millimeters (0.25 inch) in diameter which penetrate into the flesh or affect the appearance of the unit.

(vi) *Trimmed units.* In the case of whole, halves, and quarters styles, all units are untrimmed or are so trimmed as to preserve normal shape of the unit.

(vii) *Crushed or broken units.* In the case of whole, halves, quarter, slices, dice, and chunky styles, not more than 10 percent by count of the units in containers of 10 or more units and not more than 1 unit in containers of less than 10 units are crushed or broken. A unit that lost its normal shape because of ripeness and bears no mark of crushing shall not be considered to be crushed or broken.

(viii) *Loose core material in all styles except uncored whole style.* Not more than two units of loose core material per kilogram (35.3 ounces) of net weight. A unit of such material is defined as a portion of loose core, with or without seeds, aggregating approximately one-half of a pear core.

(ix) *Partially cored units in all styles except uncored whole style.* Not more than 40 percent by count partially cored units in halves, quarters, slices, and pieces or irregular pieces styles and not more than 5 percent by weight in dice style. A partially cored unit is a unit of pear that contains an attached portion of the seed cell cavity.

(x) *Seeds in all styles except whole uncured style.* Not more than 8 seeds or the equivalent in pieces of seeds per kilogram (35.3 ounces) of net weight. Seeds included as cored material in paragraph (b)(1) (viii) and (ix) of this section shall not be counted a second time.

(2) Canned pears shall be tested by the following method to determine whether they meet the requirements of paragraph (b)(1)(i) of this section: So trim a test piece from the unit as to fit, with peel surface up, into a supporting receptacle. If the unit is of different firmness in different parts of its peel surface, trim the piece from the firmest part. If the piece is unpeeled,

remove the peel. The top of the receptacle is circular in shape, of 28.6 millimeters (1.12 inches) inside diameter, with vertical sides; or rectangular in shape, 19 millimeters (0.75 inch) by 25.4 millimeters (1 inch) inside measurements, with ends vertical and sides sloping downward and joining at the center at a vertical depth of 19 millimeters (0.75 inch). Use the circular receptacle for testing units of such size that a test piece can be trimmed therefrom to fit it. Use the rectangular receptacle for testing other units. Test no unit from which a test piece with rectangular peel surface at least 13 millimeters (0.51 inch) by 25.4 millimeters (1 inch) cannot be trimmed. Test the piece by means of a round metal rod 4 millimeters (0.16 inch) in diameter. To the upper end of the rod is affixed a device to which weight can be added. The rod is held vertically by the support through which it can freely move upward or downward. The lower end of the rod is a plane surface to which the vertical axis of the rod is perpendicular. Adjust the combined weight of the rod and device to 100 grams (3.5 ounces). Set the receptacle so that the surface of the test piece is held horizontally. Lower the end of the rod to the approximate center of such surface, and add weight to the device at a uniform, continuous rate of 12 grams (0.42 ounce) per second until the rod pierces the test piece. Weigh the rod and weighted device. Test all units in containers of 50 units or less except those units too small for testing or too soft for trimming. Test at least 50 units, taken at random in containers of more than 50 units; but if less than 50 units are of sufficient size and firmness for testing, test those which are of sufficient size and firmness.

(3) Determine compliance as specified in §145.3(o) except that a lot shall be deemed to be in compliance for peel in all styles except unpeeled styles and seeds in all styles except whole uncored style based on the average of all samples analyzed according to the sampling plans set out in §145.3(p).

(4) If the quality of canned pears falls below the standard prescribed in paragraph (b)(1) of this section, the label shall bear the general statement of substandard quality specified in

§130.14(a) of this chapter, in the manner and form therein specified; however, if the quality of the canned pears falls below standard with respect to only one of the factors of quality specified in paragraph (b)(1) (i) through (x) of this section, there may be substituted for the second line of such general statement of substandard quality ("Good Food—Not High Grade") a new line, as specified after the corresponding designation of paragraph (b)(1) of this section which the canned pears fail to meet, as follows:

- (i) "Not tender";
- (ii) "Small halves" or "small quarters", as the case may be;
- (iii)(a) "Mixed sizes";
- (b) "Undersized and/or oversized pieces";
- (iv) "Excessive peel";
- (v) "Blemished";
- (vi) "Unevenly trimmed";
- (vii) "Partly crushed or broken";
- (viii) "Excessive core";
- (ix) "Excessive core";
- (x) "Excessive seeds".

Such alternative statement shall immediately and conspicuously precede or follow, without intervening written, printed, or graphic matter, the name "pears" and any words and statements required or authorized to appear with such name by paragraph (a)(2) of this section.

(c) *Fill of container.* (1) The standard of fill of container for canned pears is the maximum quantity of the optional pear ingredient that can be sealed in the container and processed by heat to prevent spoilage, without crushing or breaking such ingredient.

(2) If canned pears fall below the standard of fill of container prescribed in paragraph (c)(1) of this section, the label shall bear the general statement of substandard fill specified in §130.14(b) of this chapter, in the manner and form therein specified.

[42 FR 14414, Mar. 15, 1977, as amended at 47 FR 41528, 41530, Sept. 21, 1982; 58 FR 2880, Jan. 6, 1993]

§ 145.176 Artificially sweetened canned pears.

(a) Artificially sweetened canned pears is the food which conforms to the definition and standard of identity prescribed for canned pears by §145.175(a)

except that in lieu of a packing medium specified in §145.175(a)(3), the packing medium used is water artificially sweetened with saccharin, sodium saccharin, or a combination of both. Such packing medium may be thickened with pectin and may contain any mixture of any edible organic salt or salts and any edible organic acid or acids as a flavor-enhancing agent, in a quantity not more than is reasonably required for that purpose.

(b)(1) The specified name of the food is "artificially sweetened _____", the blank being filled in with the name prescribed by §145.175(a) for canned pears having the same optional pear ingredient.

(2) The artificially sweetened food is subject to the requirements for label statement of ingredients used, as prescribed for canned pears by §145.175(a). If the packing medium is thickened with pectin, the label shall bear the statement "thickened with pectin". When any organic salt or acid or any mixture of two or more of these is added, the label shall bear the common or usual name of each such ingredient.

[42 FR 14414, Mar. 15, 1977, as amended at 58 FR 2880, Jan. 6, 1993]

§ 145.180 Canned pineapple.

(a) *Identity*—(1) *Ingredients*. Canned pineapple is the food prepared from mature, fresh or previously canned, pineapple conforming to the characteristics of *Ananas comosus* (L.) Merrill and from which peel and core have been removed. The food consists of one of the optional styles of the pineapple ingredient specified in paragraph (a)(2) of this section and may be packed in one of the optional packing media specified in paragraph (a)(3) of this section, except water is not a suitable packing medium for crushed style. Crushed style additionally may be packed as heavy or solid pack as specified in paragraph (a)(4) of this section. The food may also contain one, or any combination of two or more, of the following safe and suitable optional ingredients:

- (i) Natural fruit flavors.
- (ii) Mint flavor.
- (iii) Spices, spice oils.
- (iv) Vinegar or organic acids.

(v) Dimethylpolysiloxane in an amount not greater than 10 milligrams/kilogram (10 parts per million) by weight of the finished food as a defoaming agent.

The food is sealed in a container and, before or after sealing, is so processed by heat as to prevent spoilage.

(2) *Styles of pack*. The optional styles of the pineapple ingredients referred to in paragraph (a)(1) of this section are:

(i) *Slices or whole slices or rings*—consisting of uniformly cut circular slices or rings cut across the axis of the peeled, cored pineapple cylinders.

(ii) *Half slices*—consisting of uniformly cut, approximately semi-circular halves of slices.

(iii) *Quarter slices*—consisting of uniformly cut, one-fourth portions of slices.

(iv) *Broken slices*—consisting of arc-shaped portions which may not be uniform in size and/or shape.

(v) *Spears or fingers*—consisting of long, slender pieces cut radially and lengthwise of the cored pineapple cylinder, predominantly 65 millimeters (2.5 inches) or longer.

(vi) *Tidbits*—consisting of reasonably uniform, wedge-shaped sectors cut from slices or portions thereof, predominantly from 8 millimeters (0.31 inch) to 13 millimeters (0.51 inch) thick.

(vii) *Chunks*—consisting of short, thick pieces cut from thick slices and/or from peeled cored pineapple and predominantly more than 13 millimeters (0.51 inch) in both thickness and width, and less than 38 millimeters (1.5 inches) in length and does not include large cubes.

(viii) *Small cubes or dice*—consisting of reasonably uniform, cube-shaped pieces, predominately 14 millimeters (0.55 inch) or less in the longest edge dimensions.

(ix) *Pieces or irregular pieces*—consisting of irregular shapes and sizes not identifiable as a specific style and does not include chunks.

(x) *Crushed*—consisting of finely cut or finely shredded or grated or diced pieces of pineapple.

(xi) *Large cubes*—consisting of reasonably uniform, cube-shaped pieces, longer than 14 millimeters (0.55 inch) along any edge, but predominately 25

millimeters (1 inch) or less in the longest edge dimensions.

(3) *Packing media.* (i) The optional packing media referred to in paragraph (a)(1) of this section and defined in §145.3 are:

- (a) Water.
- (b) Pineapple juice and water.
- (c) Pineapple juice.
- (d) Clarified pineapple juice.

Such packing media may be used as such, or any one of the optional sweetening ingredients specified in paragraph (a)(3)(ii) of this section may be added.

(ii) The optional sweetening ingredients referred to in paragraph (a)(3)(i) of this section are:

- (a) Sugar.
- (b) Invert sugar sirup.
- (c) Any mixture of optional sweetening ingredients designated in paragraph (a)(3)(ii)(a) and (b) of this section.
- (d) Any of the optional sweetening ingredients designated in paragraph (a)(3)(ii)(a), (b), and (c) of this section with dextrose, as long as the weight of the solids of dextrose does not exceed one-third of the total weight of the solids of the combined sweetening ingredients.
- (e) Any of the optional sweetening ingredients designated in paragraph (a)(3)(ii)(a), (b), and (c) of this section with corn sirup or with dried corn sirup or with glucose sirup or with dried glucose sirup, or with any two or more of these, as long as the weight of the solids of corn sirup, dried corn sirup, glucose sirup, dried glucose sirup, or the sum of the weights of the solids of corn sirup, dried corn sirup, glucose sirup, and dried glucose sirup, in case two or more of these are used, does not exceed one-fourth of the total weight of the solids of the combined sweetening ingredients.
- (f) Any mixture of the optional ingredients designated in paragraph (a)(3)(ii)(d) and (e) of this section.

(iii) If the concentration of clarified pineapple juice is such that the packing medium conforms to the density range for one of the sirups provided for in paragraph (a)(3)(iv)(b), (c), or (d) of this section, the concentrated clarified juice is considered to be light sirup,

heavy sirup, or extra heavy sirup, as the case may be.

(iv) When a sweetener is added as a part of any liquid packing medium as provided for in paragraph (a)(3)(i)(a), (b), and (c) of this section, the density range of the resulting packing medium, expressed as percent by weight of sucrose (degrees Brix) as determined by the procedure in §145.3(m), shall be designated by the appropriate name for the respective density ranges, namely:

(a) When the density of the solution is 10 percent or more but less than 14 percent, the medium shall be designated as "slightly sweetened water" or "extra light sirup"; "slightly sweetened pineapple juice and water"; or "slightly sweetened pineapple juice", as the case may be.

(b) When the density of the solution is 14 percent or more but less than 18 percent, the medium shall be designated as "light sirup"; "lightly sweetened pineapple juice and water"; or "lightly sweetened pineapple juice," as the case may be.

(c) When the density of the solution is 18 percent or more but less than 22 percent, the medium shall be designated as "heavy sirup"; "heavily sweetened pineapple juice and water"; or "heavily sweetened pineapple juice", as the case may be.

(d) When the density of the solution is 22 percent or more but not more than 35 percent, the medium shall be designated as "extra heavy sirup"; "extra heavily sweetened pineapple juice and water"; or "extra heavily sweetened pineapple juice", as the case may be.

(v) Determine compliance as specified in §145.3(o).

(4) *Types of pack.* The optional types of pack for crushed style referred to in paragraph (a)(1) of this section are as follows:

(i) Any pack: Crushed style with or without sweetening ingredients and containing at least 73 percent drained fruit weight, as determined by the procedure set forth in §145.3(n).

(ii) Solid pack: Crushed style with or without sweetening ingredients and containing at least 78 percent drained fruit weight, as determined by the procedure set forth in §145.3(n).

(5) *Labeling requirements.* (i) The name of the food is “pineapple”. The name of the food shall also include a declaration of any flavoring that characterizes the product as specified in §101.22 of this chapter and a declaration of any spice or seasoning that characterizes the product; for example, “Spice added”, or, in lieu of the word “Spice”, the common name of the spice; or “Seasoned with vinegar” or, in lieu of the word “vinegar”, the name of the vinegar used. When two or more of the optional ingredients specified in paragraph (a)(1)(i) through (iv) of this section are used, such words may be combined, as, for example, “Seasoned with cider vinegar, cloves, and cinnamon oil”.

(ii) The style of the pineapple ingredient as provided for in paragraph (a)(2) of this section and the name of the packing medium as specified in paragraph (a)(3)(i) and (ii) of this section, preceded by “In” or “Packed in” or the words “Heavy pack” or “Solid pack” as specified in paragraph (a)(4) of this section, where applicable, shall be included as part of the name or in close proximity to the name of the food. The word “slices” may be alternatively designated “sliced,” “dice” as “diced,” and “pieces” or “irregular pieces” as “mixed pieces of irregular sizes and shapes.” Whenever pineapple juice, as provided for in paragraph (a)(3)(i)(c) of this section, is used, the declaration may be preceded by an appropriate statement such as “unsweetened”.

(iii) Label declaration. Each of the ingredients used in the food shall be declared on the label as required by the applicable sections of parts 101 and 130 of this chapter.

(b) *Quality.* (1) The standard of quality for canned pineapple is as follows:

(i) *Core material.* In the case of all styles, not more than 7 percent of the drained weight of the contents of the container consists of core material as determined by the method prescribed in paragraph (b)(3)(ii) of this section.

(ii) *Uniformity of weight and shape—*
(a) *Slices.* The drained weight of the largest unit in the container is not more than 1.4 times the drained weight of the smallest unit.

(b) *Half slices and quarter slices.* The drained weight of the largest unit in a

container is not more than 1.75 times the drained weight of the smallest unit, except for an occasional broken piece due to splitting or an occasional whole slice not completely cut through.

(c) *Broken slices.* (1) Not more than 10 percent of the drained weight of the contents of the container consists of pieces having an arc of less than 90°.

(2) Not more than 5 percent of the drained weight of the contents of the container:

(i) Consists of pieces that measure in thickness less than 8 millimeters (0.31 inch) or more than 25 millimeters (1 inch); or

(ii) Consists of pieces that measure less than 19 millimeters (0.75 inch) in width as measured from the outer edge to the inner edge.

(3) Not more than 5 percent of the drained weight of the contents of the container consists of broken slices having an outside diameter differing by as much as 9.5 millimeters (0.37 inch) from that of those present in greatest proportion by weight.

(d) *Spears.* The drained weight of the largest unit in the container is not more than 1.4 times the drained weight of the smallest unit.

(e) *Tidbits.* Not more than 15 percent of the drained weight of the contents of the container consists of units each of which weighs less than three-fourths as much as the average drained weight of all the untrimmed units in the container.

(f) *Chunks.* Not more than 15 percent of the drained weight of the contents of the container consists of pieces weighing less than 5 grams (0.18 ounce) each.

(g) *Cubes.* (1) Not more than 10 percent of the drained weight of the contents of the container consists of pieces that will pass through a screen with square openings of 8 millimeters (0.31 inch) in the case of the small cubes or large cubes.

(2) Not more than 15 percent of the drained weight consists of pieces weighing more than 3 grams (0.11 ounce) each for small cubes and 18 grams (0.63 ounce) each for large cubes.

(h) *Pieces.* Not more than 20 percent of the drained weight of the contents of the container consists of units that

will pass through a screen with square openings of 8 millimeters (0.31 inch).

(iii) *Blemishes*. Blemishes consist of surface areas and spots that contrast strongly in color or texture with the normal pineapple tissue or that may penetrate the flesh. Blemishes are normally removed in preparation of pineapple for culinary use and include any of the following, if in excess of 1.6 millimeters (0.06 inch) in the longest dimension on the exposed surface of the unit: deep fruit eyes, pieces of shell, brown spots, bruised portions, and other abnormalities.

(a) *Slices, half slices, quarter slices, broken slices, spears, tidbits, chunks, cubes, and pieces*. Not more than 12.5 percent by count of the units in the container may be blemished; but in containers having not more than 5 units, 1 unit may be blemished; in containers having more than 5 units, but not more than 10 units, 2 units may be blemished and in containers having more than 10 units, but not more than 32 units, 4 units may be blemished.

(b) *Crushed*. Not more than 1.5 percent of the drained weight of the contents of the container consists of fragments bearing blemishes.

(iv) *Excessively trimmed*. Slices, half slices, and quarter slices are considered excessively trimmed if the portion trimmed away exceeds 5 percent of the apparent physical bulk of the perfectly formed unit and if the trimming destroys the normal circular shape of the outer or inner edge of the unit. Broken slices, spears, and tidbits are excessively trimmed if the trimming destroys the normal shape of the unit.

(a) *Slices, half slices, and quarter slices*. Not more than 7.5 percent by count of the units in the container may be excessively trimmed, but in containers having not more than 10 units, 1 unit may be excessively trimmed; and in containers having more than 10 units, but not more than 27 units, 2 units may be excessively trimmed.

(b) *Broken slices and spears*. Not more than 15 percent by count of the total units in the container may be excessively trimmed.

(c) *Tidbits*. Not more than 15 percent of the drained weight of the contents of the container consists of excessively trimmed units.

(v) *Mashed*. A unit that has lost its normal shape because of ripeness that bears no mark of mechanical injury is not to be considered mashed.

(a) *Slices, half slices, and quarter slices*. Not more than one unit in containers of 25 units or less, and not more than 3 units in containers of more than 25 units, are mashed.

(b) *Broken slices*. Not more than 5 percent by count of the units in the container are mashed.

(c) *Spears*. Not more than 1 unit in the container is mashed.

(d) *Tidbits*. Not more than 3 units in containers of less than 150 units, and not more than 2 percent of the units in containers of 150 units or more, are mashed.

(e) *Chunks*. Not more than 3 units in containers of less than 70 units, and not more than 5 percent of the units in containers of 70 units or more, are mashed.

(vi) *Acidity*. In the case of all styles, not more than 1.35 grams of acid, calculated as anhydrous citric acid, is contained in 100 milliliters of the liquid drained from the product 15 days or more after the pineapple is canned.

(vii) *Excessive liquid*. The drained weight of crushed pineapple is not less than 63 percent of the net weight of the contents of the container.

(2) Sampling and acceptance: Determine compliance as specified in §145.3(o).

(3) Methodology: The method to be employed to determine whether canned pineapple meets the requirements of paragraph (b)(1) (i) through (vi) of this section are as follows:

(i) Determine the drained weight of the canned pineapple by the procedure prescribed in §145.3(n).

(ii) Identify and separate any core material cleanly from each of the units in the container, and weigh the aggregate of the core material. Calculate the percent core material to determine compliance with paragraph (b)(1)(i) of this section.

(iii) In the case of slices, half slices, quarter slices, spears, tidbits, chunks, and pieces, check the weight of the units against the requirements of paragraph (b)(1)(ii) (a), (b), (d), (e), (f), and (h) of this section.

(iv) In the case of broken slices, check the dimensions of each unit against the requirements of paragraph (b)(1)(ii)(c) of this section.

(v) In the case of cubes, and pieces, determine compliance with paragraph (b)(1)(ii) (g) and (h) of this section by placing the units, a few at a time, on the mesh of a U.S. Standard No. 8 sieve (8-millimeter (0.31 inch)) mesh. After shaking gently, remove those units that remain on the sieve before testing the next portion. Continue portion-wise until all units are tested, then determine the aggregate weight of those units that have passed through the sieve.

(vi) Except in the case of crushed pineapple, segregate and count each unit that is blemished as defined in paragraph (b)(1)(iii) of this section. In the case of crushed pineapple, segregate each fragment of crushed pineapple bearing a blemish and determine the aggregate weight of such fragments to determine compliance with paragraph (b)(1)(iii)(b) of this section.

(vii) Except in the case of chunks, cubes, pieces, and crushed pineapple, inspect all the units in the container to determine those that have been excessively trimmed, as defined in paragraph (b)(1)(iv) of this section.

(viii) Except in the case of cubes, pieces, and crushed pineapple, count the total units in the container and the number of mashed units to determine compliance with paragraph (b)(1)(v) of this section.

(ix) Determine the total acidity of the drained liquid by titration, using the following method: Measure with a pipette 10 milliliters of the unfiltered drained liquid into a 250-milliliter Erlenmeyer flask. Add 25 milliliters of distilled or deionized water and 0.3 milliliter of 1-percent phenolphthalein solution. Titrate with one-tenth normal sodium hydroxide solution to a faint, permanently pink coloration. Multiply the number of milliliters of one-tenth normal sodium hydroxide required by 0.064 to calculate the number of grams of anhydrous citric acid per 100 milliliters of drained liquid to determine compliance with paragraph (b)(3)(vi) of this section.

(4) If the quality of canned pineapple falls below the standard prescribed in

paragraph (b)(1) of this section, the label shall bear the general statement of substandard quality specified in §130.14(a) of this chapter, in the manner and form specified in that section; however, if the quality of the canned pineapple falls below standard with respect to only one of the factors of quality specified in paragraph (b)(1)(i) through (vii) of this section, there may be substituted for the second line of the general statement of substandard quality (“Good Food—Not High Grade”) one of the following new lines, placed after the corresponding designation of paragraph (b)(1) of this section that the canned pineapple fails to meet:

(i) “Poorly cored” or “Excessive core”.

(ii) “Mixed sizes” or “Irregular small pieces”, as appropriate.

(iii) “Blemished” or “Contains blemished pieces”.

(iv) “Excessively trimmed”.

(v) “Mashed units” or “Contains mashed units”.

(vi) “Excessively tart”.

(vii) “Contains excess liquid”.

(c) *Fill of Container.* (1) The standard of fill of container for canned crushed pineapple is a fill of not less than 90 percent of the total capacity of the container, as determined by the general method for fill of container prescribed in §130.12(b) of this chapter.

(2) If canned crushed pineapple falls below the standard of fill of container prescribed in paragraph (c)(1) of this section, the label shall bear the general statement of substandard fill specified in §130.14(b) of this chapter, in the manner and form therein specified.

[42 FR 14414, Mar. 15, 1977, as amended at 44 FR 40279, July 10, 1979; 45 FR 43391 and 43392, June 27, 1980; 46 FR 57475, Nov. 24, 1981; 48 FR 39916, Sept. 2, 1983; 58 FR 2880, Jan. 6, 1993]

§ 145.181 Artificially sweetened canned pineapple.

(a) Artificially sweetened canned pineapple is the food that conforms to the definition and standard of identity prescribed for canned pineapple by §145.180(a), except that in lieu of a packing medium specified in §145.180(a)(2), the packing medium used is water artificially sweetened with

saccharin, sodium saccharin, or a combination of both. Such packing medium may be thickened with pectin.

(b)(1) The specified name of the food is “artificially sweetened _____”, the blank being filled in with the name prescribed by §145.180(a) for canned pineapple having the same optional pineapple ingredient.

(2) The artificially sweetened food is subject to the requirements for label statement of ingredients used, as prescribed for canned pineapple by §145.180(a). If the packing medium is thickened with pectin, the label shall bear the statement “thickened with pectin”.

[42 FR 14414, Mar. 15, 1977, as amended at 58 FR 2880, Jan. 6, 1993]

§ 145.185 Canned plums.

(a) *Identity*—(1) *Ingredients*. Canned plums is the food prepared from clean, sound, and mature fruit of plum varieties conforming to the characteristics of *Prunus domestica* L., greengage varieties conforming to the characteristics of *Prunus italica* L., mirabelle or damson varieties conforming to the characteristics of *Prunus insititia* L., or cherry varieties conforming to the characteristics of *Prunus cerasifera* Ehrh. The food consists of one of the optional styles of the plum ingredient, specified in paragraph (a)(2) of this section, and one of the optional packing media specified in paragraph (a)(3) of this section. Such food may also contain one, or any combination of two or more of the following safe and suitable optional ingredients:

- (i) Natural and artificial flavors.
- (ii) Spice.
- (iii) Vinegar, lemon juice, or organic acids.
- (iv) Artificial coloring.

Such food is sealed in a container and before or after sealing is so processed by heat so as to prevent spoilage.

(2) *Optional styles of the plum ingredient*. The optional plum ingredients specified in paragraph (a)(1) of this section are peeled or unpeeled:

- (i) Whole.
- (ii) Halves.

Peeled or unpeeled whole plums are pitted or, alternatively, unpitted.

Peeled or unpeeled plum halves are pitted.

(3) *Packing media*. (i) The optional packing media referred to in paragraph (a)(1) of this section, as defined in §145.3 are:

- (a) Water.
- (b) Fruit juice(s) and water.
- (c) Fruit juice(s).

Such packing media may be used as such or any one or any combination of two or more safe and suitable nutritive carbohydrate sweetener(s) may be added. Sweeteners defined in §145.3 shall be as defined therein, except that a nutritive carbohydrate sweetener for which a standard of identity has been established in part 168 of this chapter shall comply with such standard in lieu of any definition that may appear in §145.3.

(ii) When a sweetener is added as a part of any such liquid packing medium, the density range of the resulting packing medium expressed as percent by weight of sucrose (degrees Brix) as determined by the procedure prescribed in §145.3(m) shall be designated by the appropriate name for the respective density ranges, namely:

(a) When the density of the solution is 11 percent or more but less than 15 percent, the medium shall be designated as “slightly sweetened water”, or “extra light sirup”, “slightly sweetened fruit juice(s) and water” or “slightly sweetened fruit juice(s)”, as the case may be.

(b) When the density of the solution is 15 percent or more, but less than 19 percent, the medium shall be designated as “light sirup”, “lightly sweetened fruit juice(s) and water”, or “lightly sweetened fruit juice(s)”, as the case may be.

(c) When the density of the solution is 19 percent or more, but less than 25 percent, the medium shall be designated as “heavy sirup”, “heavily sweetened fruit juice(s) and water”, or “heavily sweetened fruit juice(s)”, as the case may be.

(d) When the density of the solution is 25 percent or more, but less than 35 percent, the medium shall be designated as “extra heavy sirup”, “extra heavily sweetened fruit juice(s) and water”, or “extra heavily sweetened fruit juice(s)”, as the case may be.

(4) *Labeling requirements.* (i) The name of the food is “plums” accompanied by the color designation “yellow” or “golden” or “red” or “purple”, as appropriate, or the specific name of the variety or “Greengage plums”, “Damsion plums”, “Cherry plums”, “Mirabelle plums”. The name of the food shall also include a declaration of any flavoring that characterizes the product as specified in §101.22 of this chapter and a declaration of any spice or seasoning that characterizes the product; for example, “Spice added”, or in lieu of the word “Spice”, the common name of the spice; “Seasoned with vinegar”. When two or more of the optional ingredients specified in paragraphs (a)(1)(ii) and (iii) of this section are used, such words may be combined as for example, “Seasoned with cider vinegar, cloves, and cinnamon oil”.

(ii) The style of the plum ingredient as provided in paragraph (a)(2) of this section and the name of the packing medium specified in paragraphs (a)(3)(i) and (ii) of this section, preceded by “In” or “Packed in” shall be included as part of the name or in close proximity to the name of the food. The style of the plum ingredient shall be preceded or followed by “Peeled” when the plums are peeled and by “Pitted” in the case of whole pitted plums. “Halves” may be alternatively designated “Halved”. When the packing medium is prepared with a sweetener(s) which imparts a taste, flavor or other characteristics to the finished food in addition to sweetness, the name of the packing medium shall be accompanied by the name of such sweetener(s), as for example, in the case of a mixture of brown sugar and honey, an appropriate statement would be “_____ sirup of brown sugar and honey”, the blank to be filled in with the word “light”, “heavy”, or “extra heavy”, as the case may be. When the liquid portion of the packing media provided for in paragraphs (a)(3)(i) and (ii) of this section consists of fruit juice(s), such juice(s) shall be designated in the name of the packing medium as:

(a) In the case of a single fruit juice, the name of the juice shall be used in lieu of the word “fruit”,

(b) In the case of a combination of two or more fruit juices, the names of

the juices in the order of predominance by weight shall either be used in lieu of the word “fruit” in the name of the packing medium, or be declared on the label as specified in paragraph (a)(4)(iii) of this section, and

(c) In the case of a single fruit juice or a combination of two or more fruit juices any of which are made from concentrate(s), the words “from concentrate(s)” shall follow the word “juice(s)” in the name of the packing medium and in the name(s) of such juice(s) when declared as specified in paragraph (a)(4)(iii) of this section.

(iii) Whenever the names of the fruit juices used do not appear in the name of the packing medium as provided in paragraph (a)(4)(ii)(b) of this section, such names and the words “from concentrate”, as specified in paragraph (a)(4)(ii)(c) of this section, shall appear in an ingredient statement pursuant to the requirements of §101.3(d) of this chapter.

(iv) *Label declaration.* Each of the ingredients used in the food shall be declared on the label as required by the applicable sections of parts 101 and 130 of this chapter.

(b) *Quality.* (1) The standard of quality for canned plums is as follows:

(i) *Blemishes (damaged).* After draining in accordance with the procedure set out in §145.3(n) not more than 30 percent by weight of the drained plums consists of plums which have been blemished or damaged by any of the following factors either singly or in combination: Damaged by insects; appearance or eating quality materially affected by friction, disease, external stone gum or discoloration.

(ii) *Crushed or broken units in whole and halves styles.* In the case of the whole styles, not more than 25 percent by weight of the drained plums are deformed or broken to an extent that the normal shape of the fruit is seriously affected. In the case of the halves style, not more than 25 percent by weight of the drained plums are damaged or torn to such an extent that they are smaller than 50 percent of a plum half.

(iii) *Blemishes and crushed or broken units.* Not more than 35 percent by weight of the drained plums consist of both blemishes as specified in paragraph (b)(1)(i) of this section and

crushed or broken units in the case of the whole and halves styles as specified in paragraph (b)(2)(ii) of this section.

(iv) *Extraneous plant material.* Not more than one piece of stalk or stem from the plum tree or other harmless extraneous plant material per 200 grams (7 ounces) of drained plums.

(v) *Loose pits in whole style.* Not more than three loose pits per 500 grams (17.6 ounces) of drained plums.

(vi) *Pits or pieces of pits in whole pitted and halves styles.* Not more than two pits or pieces of pits per 500 grams (17.8 ounces) of drained plums.

(2) Determine compliance as specified in §145.3(o) except that a lot shall be deemed to be in compliance for extraneous plant material, loose pits in whole style, and pits or pieces of pits in whole pitted and halves styles based on the average of all samples analyzed according to the sampling plans set out in §145.3(p).

(3) If the quality of canned plums falls below the standard prescribed in paragraph (b)(1) of this section, the label shall bear the general statement of substandard quality specified in §130.14(a) of this chapter, in the manner and form therein specified; however, if the quality of the canned plums falls below standard with respect to only one of the factors of quality specified in paragraphs (b)(1) (i) through (vi) of this section, there may be substituted for the second line of such general statement of substandard quality ("Good Food—Not High Grade") a new line, as specified after the corresponding designation of paragraph (b)(1) of this section which the canned plums fail to meet, as follows:

- (i) "Blemished";
- (ii) "Partly crushed or broken";
- (iii) "Blemished and partly crushed or broken";
- (iv) "Contains extraneous plant material";
- (v) "Contains loose pits"; or
- (vi) "Contains pits" or "Contains pieces of pits".

(c) *Fill of container.* (1) The standard of fill of container for canned plums is:

(i) The fill of the plums and packing medium, as determined by the general method for fill of container prescribed in §130.12(b) of this chapter, is not less

than 90 percent of the total capacity of the container.

(ii) The drained weight of the plum ingredient as determined by the method prescribed in §145.3(n) is not less than 50 percent for whole styles and 55 percent for halves styles based on the water capacity of containers as determined in §130.12(a) of this chapter.

(2) Determine compliance for fill of container as specified in §145.3(o).

(3) If canned plums fall below the standard of fill of container prescribed in paragraph (c)(1) of this section, the label shall bear the statement of substandard fill specified in §130.14(b) of this chapter, in the manner and form therein specified. If canned plums fall below the standard of fill of container in respect to drained weight, the words "Low drained weight" shall follow the general statement of substandard fill on the label.

[42 FR 14414, Mar. 15, 1977, as amended at 58 FR 2880, Jan. 6, 1993]

§ 145.190 Canned prunes.

(a) *Ingredients.* Canned prunes is the food prepared from dried prunes, which may be packed as a solid pack or in one of the optional packing media specified in paragraph (b) of this section. Such food may also contain one, or any combination of two or more, of the following safe and suitable optional ingredients:

- (1) Natural and artificial flavors.
- (2) Spice.
- (3) Vinegar, lemon juice, or organic acids.
- (4) Unpeeled pieces of citrus fruits.

Such food is sealed in a container and before or after sealing is so processed by heat as to prevent spoilage.

(b) *Packing media.* (1) The optional packing media referred to in paragraph (a) of this section, as defined in §145.3 are:

- (i) Water.
- (ii) Fruit juice(s) and water.
- (iii) Fruit juice(s).

Such packing media may be used as such or any one or any combination of two or more safe and suitable nutritive carbohydrate sweetener(s) may be added. Sweeteners defined in §145.3 shall be as defined therein, except that a nutritive carbohydrate sweetener for

which a standard of identity has been established in part 168 of this chapter shall comply with such standard in lieu of any definition that may appear in §145.3.

(2) When a sweetener is added as a part of any such liquid packing medium, the density range of the resulting packing medium expressed as percent by weight of sucrose (degrees Brix) as determined by the procedure prescribed in §145.3(m) shall be designated by the appropriate name for the respective density ranges, namely:

(i) When the density of the solution is less than 20 percent, the medium shall be designated as “slightly sweetened water”; or “extra light sirup”; “slightly sweetened fruit juice(s) and water”; or “slightly sweetened fruit juice(s)”, as the case may be.

(ii) When the density of the solution is 20 percent or more but less than 24 percent, the medium shall be designated as “light sirup”; “lightly sweetened fruit juice(s) and water”; or “lightly sweetened fruit juice(s)”, as the case may be.

(iii) When the density of the solution is 24 percent or more but less than 30 percent, the medium shall be designated as “heavy sirup”; “heavily sweetened fruit juice(s) and water”; or “heavily sweetened fruit juice(s)”, as the case may be.

(iv) When the density of the solution is 30 percent or more but not more than 45 percent, the medium shall be designated as “extra heavy sirup”; “extra heavily sweetened fruit juice(s) and water”; or “extra heavily sweetened fruit juice(s)”, as the case may be.

(c) *Labeling requirements.* (1) The name of the food is “prunes—prepared from dried prunes”. The words “prepared from dried prunes” shall be in close proximity to the word “prunes” and shall be of the same style and not less than ½ of the point size of the type used for the word “prunes”. The name of the food shall also include a declaration of any flavoring that characterizes the product as specified in §101.22 of this chapter and a declaration of any spice or seasoning that characterizes the product; for example, “Spice added”, or in lieu of the word “Spice”, the common name of the spice, “Seasoned with vinegar” or “Seasoned with

unpeeled pieces of citrus fruit”. When two or more of the optional ingredients specified in paragraphs (a) (2) through (4) of this section are used, such words may be combined as for example, “Seasoned with cider vinegar, cloves, cinnamon oil and unpeeled pieces of citrus fruit.”

(2) When the food is prepared with a packing medium, the name of the packing medium specified in paragraphs (b) (1) and (2) of this section, preceded by “In” or “Packed in” and the words “cooked”, “stewed”, or “prepared”, shall be included as part of the name or in close proximity to the name of the food. When no packing medium is used, the words “solid pack” or “moist pack” or the word “moistened” followed by the words “without sirup” shall be included as part of the name or in close proximity to the name of the food. When the packing medium is prepared with a sweetener(s) which imparts a taste, flavor or other characteristic to the finished food in addition to sweetness, the name of the packing medium shall be accompanied by the name of such sweetener(s), as for example in the case of a mixture of brown sugar and honey, an appropriate statement would be “_____ sirup of brown sugar and honey”, the blank to be filled in with the word “light”, “heavy”, or “extra heavy” as the case may be. When the liquid portion of the packing media provided for in paragraphs (b) (1) and (2) of this section consists of fruit juice(s), such juice(s) shall be designated in the name of the packing medium as:

(i) In the case of a single fruit juice, the name of the juice shall be used in lieu of the word “fruit”.

(ii) In the case of a combination of two or more fruit juices, the names of the juices in the order of predominance by weight shall either be used in lieu of the word “fruit” in the name of the packing medium, or be declared on the label as specified in paragraph (c)(3) of this section, and

(iii) In the case of the single fruit juice or a combination of two or more fruit juices any of which are made from concentrate(s), the words “from concentrate(s)” shall follow the word “juice(s)” in the name of the packing medium and in the name(s) of such

juice(s) when declared as specified in paragraph (c)(3) of this section.

(3) Whenever the names of the fruit juices used do not appear in the name of the packing medium as provided in paragraph (c)(2)(ii) of this section, such names and the words “from concentrate”, as specified in paragraph (c)(2)(iii) of this section, shall appear in an ingredient statement pursuant to the requirements of §101.3(d) of this chapter.

(4) Label declaration. Each of the ingredients used in the food shall be declared on the label as required by the applicable sections of parts 101 and 130 of this chapter.

[42 FR 14414, Mar. 15, 1977, as amended at 58 FR 2880, Jan. 6, 1993]

PART 146—CANNED FRUIT JUICES

Subpart A—General Provisions

Sec.

146.3 Definitions.

Subpart B—Requirements for Specific Standardized Canned Fruit Juices and Beverages

- 146.114 Lemon juice.
- 146.120 Frozen concentrate for lemonade.
- 146.121 Frozen concentrate for artificially sweetened lemonade.
- 146.126 Frozen concentrate for colored lemonade.
- 146.132 Grapefruit juice.
- 146.135 Orange juice.
- 146.137 Frozen orange juice.
- 146.140 Pasteurized orange juice.
- 146.141 Canned orange juice.
- 146.145 Orange juice from concentrate.
- 146.146 Frozen concentrated orange juice.
- 146.148 Reduced acid frozen concentrated orange juice.
- 146.150 Canned concentrated orange juice.
- 146.151 Orange juice for manufacturing.
- 146.152 Orange juice with preservative.
- 146.153 Concentrated orange juice for manufacturing.
- 146.154 Concentrated orange juice with preservative.
- 146.185 Pineapple juice.
- 146.187 Canned prune juice.

AUTHORITY: 21 U.S.C. 321, 341, 343, 348, 371, 379e.

SOURCE: 42 FR 14433, Mar. 15, 1977, unless otherwise noted.

Subpart A—General Provisions

§ 146.3 Definitions.

For the purposes of this part:

(a) The term *corn sirup* means a clarified, concentrated, aqueous solution of the products obtained by the incomplete hydrolysis of cornstarch, and includes dried corn sirup. The solids of corn sirup and of dried corn sirup contain not less than 40 percent by weight of reducing sugars calculated as anhydrous dextrose.

(b) The term *dextrose* means the hydrated or anhydrous, refined monosaccharide obtained from hydrolyzed starch.

(c) The term *dried glucose sirup* means the product obtained by drying glucose sirup.

(d) The term *glucose sirup* means a clarified, concentrated, aqueous solution of the products obtained by the incomplete hydrolysis of any edible starch. The solids of glucose sirup contain not less than 40 percent by weight of reducing sugars calculated as anhydrous dextrose.

(e) The term *invert sugar sirup* means an aqueous solution of inverted or partly inverted, refined or partly refined sucrose, the solids of which contain not more than 0.3 percent by weight of ash, and which is colorless, odorless, and flavorless, except for sweetness.

(f) The term *sugar* means refined sucrose.

(g) Compliance means the following: Unless otherwise provided in a standard, a lot of canned fruits shall be deemed in compliance for the following factors, to be determined by the sampling and acceptance procedure as provided in paragraph (h) of this section, namely:

(1) *Quality*. The quality of a lot shall be considered acceptable when the number of defectives does not exceed the acceptance number in the sampling plans.

(2) *Fill of container*. A lot shall be deemed to be in compliance for fill of container when the number of defectives does not exceed the acceptance number (c) in the sampling plans.

(h) The sampling and acceptance procedure means the following:

§ 146.114

21 CFR Ch. I (4-1-07 Edition)

(1) *Definitions*—(i) *Lot*. A collection of primary containers or units of the same size, type, and style manufactured or packed under similar conditions and handled as a single unit of trade.

(ii) *Lot size*. The number of primary containers or units in the lot.

(iii) *Sample size*. The total number of sample units drawn for examination from a lot.

(iv) *Sample unit*. A container, a portion of the contents of a container, or a composite mixture of product from small containers that is sufficient for the examination or testing as a single unit.

(v) *Defective*. Any sample unit shall be regarded as defective when the sample unit does not meet the criteria set forth in the standards.

(vi) *Acceptance number (c)*. The maximum number of defective sample units permitted in the sample in order to consider the lot as meeting the specified requirements.

(vii) *Acceptable quality level (AQL)*. The maximum percent of defective sample units permitted in a lot that will be accepted approximately 95 percent of the time.

(2) *Sampling plans*:

Lot size (primary containers)	Size of container	
	<i>n</i> ¹	<i>c</i> ²
NET WEIGHT EQUAL TO OR LESS THAN 1 KG (2.2 LB)		
4,800 or less	13	2
4,801 to 24,000	21	3
24,001 to 48,000	29	4
48,001 to 84,000	48	6
84,001 to 144,000	84	9
144,001 to 240,000	126	13
Over 240,000	200	19
NET WEIGHT GREATER THAN 1 KG (2.2 LB) BUT NOT MORE THAN 4.5 KG (10 LB)		
2,400 or less	13	2
2,401 to 15,000	21	3
15,001 to 24,000	29	4
24,001 to 42,000	48	6
42,001 to 72,000	84	9
72,001 to 120,000	126	13
Over 120,000	200	19
NET WEIGHT GREATER THAN 4.5 KG (10 LB)		
600 or less	13	2
601 to 2,000	21	3
2,001 to 7,200	29	4
7,201 to 15,000	48	6
15,001 to 24,000	84	9
24,001 to 42,000	126	13

Lot size (primary containers)	Size of container	
	<i>n</i> ¹	<i>c</i> ²
Over 42,000	200	19

¹ *n*=number of primary containers in sample.
² *c*=acceptance number.

Subpart B—Requirements for Specific Standardized Canned Fruit Juices and Beverages

§ 146.114 **Lemon juice.**

(a) *Identity*—(1) *Description*. Lemon juice is the unfermented juice, obtained by mechanical process, from sound, mature lemons (*Citrus limon* (L.) Burm. f.), from which seeds (except embryonic seeds and small fragments of seed which cannot be separated by good manufacturing practice) and excess pulp are removed. The juice may be adjusted by the addition of the optional concentrated lemon juice ingredient specified in paragraph (a)(2) of this section in such quantity so that the increase in acidity, calculated as anhydrous citric acid, does not exceed 15 percent of the acidity of the finished food. The lemon oil and lemon essence (derived from lemons) content may be adjusted in accordance with good manufacturing practice. The juice may have been concentrated and later reconstituted. When prepared from concentrated lemon juice, the finished food contains not less than 6 percent, by weight, of soluble solids taken as the refractometric sucrose value (of the filtrate), corrected to 20 °C, but uncorrected for acidity, in accordance with the “International Scale of Refractive Indices of Sucrose Solutions” in section 52.012 of “Official Methods of Analysis of the Association of Official Analytical Chemists,” 13th Ed. (1980), which is incorporated by reference, and has a titratable acidity content of not less than 4.5 percent, by weight, calculated as anhydrous citrus acid. Copies of the incorporation by reference may be obtained from the AOAC INTERNATIONAL, 481 North Frederick Ave., suite 500, Gaithersburg, MD 20877, or may be examined at the National Archives and Records Administration (NARA). For information on the availability of this material at NARA, call 202-741-6030, or go to: http://www.archives.gov/federal_register/

code_of_federal_regulations/ibr_locations.html. The food may contain one or any combination of the safe and suitable optional ingredients specified in paragraph (a)(2) of this section. Lemon juice, as defined in this paragraph, may be preserved by heat sterilization (canning), refrigeration, freezing, or by the addition of safe and suitable preservatives. When sealed in a container to be held at ambient temperatures, it is preserved by the addition of safe and suitable preservatives or so processed by heat, before or after sealing, as to prevent spoilage.

(2) *Optional ingredients.* The optional safe and suitable ingredients referred to in paragraph (a)(1) of this section are:

(i) Concentrated lemon juice (lemon juice from which part of the water has been removed).

(ii) Water and/or lemon juice to reconstitute concentrated lemon juice in the manufacture of lemon juice from concentrate.

(iii) Preservatives.

(3) *Labeling.* (i) The name of the food is:

(a) "Lemon juice" (1) if the food is prepared from unconcentrated, undiluted liquid extracted from mature lemons; or (2) if the food is prepared from unconcentrated, undiluted liquid extracted from mature lemons to which concentrated lemon juice is added to adjust acidity as provided for in paragraph (a)(1) of this section.

(b) "Lemon juice from concentrate" or "reconstituted lemon juice" (1) if the food is prepared from concentrated lemon juice and water and/or lemon juice; or (2) if the food is prepared from lemon juice from concentrate and lemon juice. The words "from concentrate" or "reconstituted" shall be shown in letters not less than one-half the height of the letters in the word "lemon juice."

(ii) Label declaration. Each of the ingredients used in the food shall be declared on the label as required by the applicable sections of parts 101 and 130 of this chapter.

(b) [Reserved]

(c) *Fill of container.* (1) The standard of fill of container for lemon juice, except when the food is frozen, is not less than 90 percent of the total capacity of

the container as determined by the general method for fill of container prescribed in §130.12(b) of this chapter, except (i) when the food is frozen or (ii) when the food is packaged in individual serving-size packages, containing ½ fluid ounce or less, for use as described in §1.24(a)(3) of this chapter.

(2) Compliance is determined as specified in §146.3(g)(2).

(3) If the lemon juice fails to meet the standard of fill as prescribed in paragraph (c) (1) and (2) of this section, the label shall bear the general statement of substandard fill specified in §130.14(b) of this chapter, in the manner and form therein prescribed.

[45 FR 7786, Feb. 5, 1980, as amended at 47 FR 11830, Mar. 19, 1982; 49 FR 10100, Mar. 19, 1984; 54 FR 24895, June 12, 1989; 58 FR 2881, Jan. 6, 1993; 63 FR 14035, Mar. 24, 1998]

§ 146.120 Frozen concentrate for lemonade.

(a) Frozen concentrate for lemonade is the frozen food prepared from one or both of the lemon juice ingredients specified in paragraph (b) of this section together with one or any mixture of safe and suitable nutritive carbohydrate sweeteners. The product contains not less than 48.0 percent by weight of soluble solids taken as the sucrose value determined by refractometer and corrected for acidity prescribed in "Official Methods of Analysis of the Association of Official Analytical Chemists," 13th Ed. (1980), section 22.025, "Frozen Concentrate for Lemonade (12)," under the heading "Soluble Solids by Refractometer—Official First Action," which is incorporated by reference. Copies may be obtained from the AOAC INTERNATIONAL, 481 North Frederick Ave., suite 500, Gaithersburg, MD 20877, or may be examined at the National Archives and Records Administration (NARA). For information on the availability of this material at NARA, call 202-741-6030, or go to: http://www.archives.gov/federal_register/code_of_federal_regulations/ibr_locations.html When the product is diluted according to directions for making lemonade which shall appear on the label, the acidity of the lemonade, calculated as anhydrous citric acid, shall be not less than 0.70 gram

§ 146.121

21 CFR Ch. I (4-1-07 Edition)

per 100 milliliters, and the soluble solids, measured as described for the concentrate, shall be not less than 10.5 percent by weight.

(b) The lemon juice ingredients referred to in paragraph (a) of this section are:

(1) Lemon juice or frozen lemon juice or a mixture of these.

(2) Concentrated lemon juice or frozen concentrated lemon juice or a mixture of these.

For the purposes of this section, lemon juice is the undiluted juice expressed from mature lemons of an acid variety; and concentrated lemon juice is lemon juice from which part of the water has been removed. In the preparation of the lemon juice ingredients, the lemon oil content may be adjusted by the addition of lemon oil or concentrated lemon oil in accordance with good manufacturing practice, and the lemon pulp in the juice as expressed may be left in the juice or may be separated. Lemon pulp that has been separated, which may have been preserved by freezing, may be added in preparing frozen concentrate for lemonade, provided that the amount of pulp added does not raise the proportion of pulp in the finished food to a level in excess of that which would be present by using lemon juice ingredients from which pulp has not been separated. The lemon juice ingredients may be treated by heat, either before or after the other ingredients are added, to reduce the enzymatic activity and the number of viable microorganisms.

(c) Label declaration. Each of the ingredients used in the food shall be declared on the label as required by the applicable sections of parts 101 and 130 of this chapter.

[42 FR 14433, Mar. 15, 1977, as amended at 47 FR 11830, Mar. 19, 1982; 49 FR 10100, Mar. 19, 1984; 54 FR 24895, June 12, 1989; 58 FR 2881, Jan. 6, 1993; 63 FR 14035, Mar. 24, 1998]

§ 146.121 Frozen concentrate for artificially sweetened lemonade.

(a) Frozen concentrate for artificially sweetened lemonade conforms to the definition and standard of identity prescribed for frozen concentrate for lemonade by §146.120, except that in lieu of nutritive sweeteners it is sweetened with one or more of the artificial

sweetening ingredients listed in and complying with the requirements of parts 172, 180 or 184 of this chapter, and the soluble solids specifications prescribed in §146.120(a) do not apply. When the product is diluted according to directions which shall appear on the label, the acidity of the artificially sweetened lemonade, calculated as anhydrous citric acid, shall be not less than 0.70 gram per 100 milliliters. It may contain one or more safe and suitable dispersing ingredients serving the function of distributing the lemon oil throughout the food. It may also contain one or more safe and suitable thickening ingredients. Such dispersing and thickening ingredients are not food additives as defined in section 201(s) of the Federal Food, Drug, and Cosmetic Act; or if they are food additives as so defined, they are used in conformity with regulations established pursuant to section 409 of the act.

(b) [Reserved]

(c) The name of the food is “Frozen concentrate for artificially sweetened lemonade”. The words “artificially sweetened” shall be of the same size and style of type as the word “lemonade”.

(d) If an optional thickening or dispersing ingredient referred to in paragraph (a) of this section is used, the label shall bear the statement “_____ added” or “with added _____”, the blank being filled in with the common name of the thickening or dispersing agent used. Such statement shall be set forth on the label with such prominence and conspicuousness as to render it likely to be read and understood by the ordinary individual under customary conditions of purchase.

(e) Frozen concentrate for artificially sweetened lemonade is labeled to conform to the labeling requirements prescribed for foods which purport to be or are represented for special dietary use by regulations promulgated pursuant to section 403(j) of the act.

(f) Label declaration. Each of the ingredients used in the food shall be declared on the label as required by the applicable sections of parts 101 and 130 of this chapter.

[42 FR 14433, Mar. 15, 1977, as amended at 58 FR 2881, Jan. 6, 1993]

§ 146.126 Frozen concentrate for colored lemonade.

(a) Frozen concentrate for colored lemonade conforms to the definition and standard of identity prescribed for frozen concentrate for lemonade by § 146.120, except that it is colored with a safe and suitable fruit juice, vegetable juice, or any such juice in concentrated form, or with any other color additive ingredient suitable for use in food, including artificial coloring, used in conformity with regulations established pursuant to section 721 of the Federal Food, Drug, and Cosmetic Act.

(b) The name of the food is "Frozen concentrate for _____ lemonade", the blank being filled in with the word describing the color: for example, "Frozen concentrate for pink lemonade".

(c) Label declaration. Each of the ingredients used in the food shall be declared on the label as required by the applicable sections of parts 101 and 130 of this chapter.

[42 FR 14433, Mar. 15, 1977, as amended at 58 FR 2881, Jan. 6, 1993]

§ 146.132 Grapefruit juice.

(a) *Identity*—(1) *Description*. Grapefruit juice is the unfermented juice, intended for direct consumption, obtained by mechanical process from sound, mature grapefruit (*Citrus paradisi* Macfadyen) from which seeds and peel (except embryonic seeds and small fragments of seeds and peel which cannot be separated by good manufacturing practice) and excess pulp are removed and to which may be added not more than 10 percent by volume of the unfermented juice obtained from mature hybrids of grapefruit. The juice may be adjusted by the addition of the optional concentrated grapefruit juice ingredients specified in paragraph (a)(2) of this section, but the quantity of such concentrated grapefruit juice ingredient added shall not contribute more than 15 percent of the grapefruit juice soluble solids in the finished food. The grapefruit pulp, grapefruit oil, and grapefruit essence (components derived from grapefruit) content may be adjusted in accordance with good manufacturing practice. The juice may have been concentrated and later reconstituted with water suitable for the pur-

pose of maintaining essential composition and quality factors of the juice. It may be sweetened with the dry nutritive sweeteners referred to in paragraph (a)(2)(iii) of this section. If the grapefruit juice is prepared from concentrate, such sweeteners, in liquid form, referred to in paragraph (a)(2)(iii) of this section, also may be used. When prepared from concentrated grapefruit juice, exclusive of added sweeteners, the finished food contains not less than 10 percent, by weight, of soluble solids taken as the refractometric sucrose value (of the filtrate), corrected to 20 °C, and corrected for acidity by adding $(0.012+0.193x-0.0004x^2)$, where x equals the percent anhydrous citric acid in the sample, to the refractometrically obtained sucrose value by the first method prescribed in "Correction of Refractometer Sucrose Readings for Citric Acid Content for Lemonade," by Yeatman, Senzel, and Springer, "Journal of the Association of Official Analytical Chemists," vol. 59 p. 368 (1976). Copies are available from the AOAC INTERNATIONAL, 481 North Frederick Ave., suite 500, Gaithersburg, MD 20877, or available for inspection at the National Archives and Records Administration (NARA). For information on the availability of this material at NARA, call 202-741-6030, or go to: http://www.archives.gov/federal_register/code_of_federal_regulations/ibr_locations.html. The food may contain one or any combination of the optional ingredients specified in paragraph (a)(2) of this section. Grapefruit juice, as defined in this paragraph, may be preserved by heat sterilization (canning), refrigeration, or freezing. When sealed in a container to be held at ambient temperatures, it is so processed by heat, before or after sealing, as to prevent spoilage.

(2) *Optional ingredients*. The optional ingredients referred to in paragraph (a)(1) of this section are:

(i) Concentrated grapefruit juice (grapefruit juice from which part of the water has been removed).

(ii) Water and/or grapefruit juice to reconstitute concentrated grapefruit juice in the manufacture of grapefruit juice from concentrate.

(iii) One or any combination of two or more of the dry or liquid forms of

§ 146.135

sugar, invert sugar sirup, dextrose, glucose sirup, and fructose. Sweeteners defined in part 168 of this chapter shall be as defined therein.

(3) *Labeling.* (i) The name of the food is:

(a) "Grapefruit juice" (1) if the food is prepared from unconcentrated, undiluted liquid extracted from mature grapefruit; or (2) if the food is prepared from unconcentrated, undiluted liquid extracted from mature grapefruit to which concentrated grapefruit juice is added to adjust soluble solids as provided for in paragraph (a)(1) of this section.

(b) "Grapefruit juice from concentrate" (1) if the food is prepared from concentrated grapefruit juice and water and/or grapefruit juice; or (2) if the food is prepared from grapefruit juice from concentrate and grapefruit juice. The words "from concentrate" shall be shown in letters not less than one-half the height of the letters in the words "grapefruit juice."

(ii) If any nutritive sweetener is added, the principal display panel of the label shall bear the statement "Sweetener added." If no sweetener is added, the word "unsweetened" may immediately precede or follow the words "Grapefruit Juice" or "Grapefruit Juice from Concentrate."

(iii) Label declaration. Each of the ingredients used in the food shall be declared on the label as required by the applicable sections of parts 101 and 130 of this chapter.

(b) [Reserved]

(c) *Fill of container.* (1) The standard of fill of container for grapefruit juice, except when the food is frozen, is not less than 90 percent of the total capacity of the container as determined by the general method for fill of container prescribed in §130.12(b) of this chapter.

(2) Compliance is determined as specified in §146.3(g)(2).

(3) If the grapefruit juice fails to meet the standard of fill as prescribed in paragraphs (c) (1) and (2) of this section, the label shall bear the general statement of substandard fill specified

21 CFR Ch. I (4-1-07 Edition)

in §130.14(b) of this chapter, in the manner and form therein prescribed.

[46 FR 8464, Jan. 27, 1981; 46 FR 21359, Apr. 10, 1981; 46 FR 26300, May 12, 1981, as amended at 47 FR 11830, Mar. 19, 1982; 47 FR 24287, June 4, 1982; 47 FR 43364, Oct. 1, 1982; 58 FR 2881, Jan. 6, 1993; 66 FR 17359, Mar. 30, 2001]

§ 146.135 Orange juice.

(a) Orange juice is the unfermented juice obtained from mature oranges of the species *Citrus sinensis* or of the citrus hybrid commonly called "Ambersweet" (1/2 *Citrus sinensis* X 3/8 *Citrus reticulata* X 1/8 *Citrus paradisi* (USDA Selection:1-100-29; 1972 Whitmore Foundation Farm)). Seeds (except embryonic seeds and small fragments of seeds that cannot be separated by current good manufacturing practice) and excess pulp are removed. The juice may be chilled, but it is not frozen.

(b) The name of the food is "orange juice". The name "orange juice" may be preceded on the label by the varietal name of the oranges used, and if the oranges grew in a single State, the name of such State may be included in the name, as for example, "California Valencia orange juice".

[42 FR 14433, Mar. 15, 1977, as amended at 57 FR 57667, Dec. 7, 1992]

§ 146.137 Frozen orange juice.

(a) Frozen orange juice is orange juice as defined in §146.135, except that it is frozen.

(b) The name of the food is "Frozen orange juice". Such name may be preceded on the label by the varietal name of the oranges used, and if the oranges grew in a single State, the name of such State may be included in the name, as for example, "California Valencia frozen orange juice".

§ 146.140 Pasteurized orange juice.

(a) Pasteurized orange juice is the food prepared from unfermented juice obtained from mature oranges as specified in §146.135, to which may be added not more than 10 percent by volume of the unfermented juice obtained from mature oranges of the species *Citrus reticulata* or *Citrus reticulata* hybrids (except that this limitation shall not apply to the hybrid species described in §146.135). Seeds (except embryonic

seeds and small fragments of seeds that cannot be separated by good manufacturing practice) are removed, and pulp and orange oil may be adjusted in accordance with good manufacturing practice. If the adjustment involves the addition of pulp, then such pulp shall not be of the washed or spent type. The solids may be adjusted by the addition of one or more of the optional concentrated orange juice ingredients specified in paragraph (b) of this section. One or more of the optional sweetening ingredients listed in paragraph (c) of this section may be added in a quantity reasonably necessary to raise the Brix or the Brix-acid ratio to any point within the normal range usually found in unfermented juice obtained from mature oranges as specified in §146.135. The orange juice is so treated by heat as to reduce substantially the enzymatic activity and the number of viable microorganisms. Either before or after such heat treatment, all or a part of the product may be frozen. The finished pasteurized orange juice contains not less than 10.5 percent by weight of orange juice soluble solids, exclusive of the solids of any added optional sweetening ingredients, and the ratio of the Brix hydrometer reading to the grams of anhydrous citric acid per 100 milliliters of juice is not less than 10 to 1.

(b) The optional concentrated orange juice ingredients referred to in paragraph (a) of this section are frozen concentrated orange juice as specified in §146.146 and concentrated orange juice for manufacturing as specified in §146.153 when made from mature oranges; but the quantity of such concentrated orange juice ingredients added shall not contribute more than one-fourth of the total orange juice solids in the finished pasteurized orange juice.

(c) The optional sweetening ingredients referred to in paragraph (a) of this section are sugar, invert sugar, dextrose, dried corn sirup, dried glucose sirup.

(d)(1) The name of the food is "Pasteurized orange juice". If the food is filled into containers and preserved by freezing, the label shall bear the name "Frozen pasteurized orange juice". The words "pasteurized" or "frozen pas-

teurized" shall be shown on labels in letters not less than one-half the height of the letters in the words "orange juice".

(2) If the pasteurized orange juice is filled into containers and refrigerated, the label shall bear the name of the food, "chilled pasteurized orange juice". If it does not purport to be either canned orange juice or frozen pasteurized orange juice, the word "chilled" may be omitted from the name. The words "pasteurized" or "chilled pasteurized" shall be shown in letters not less than one-half the height of the letters in the words "orange juice".

(e)(1) If a concentrated orange juice ingredient specified in paragraph (b) of this section is used in adjusting the orange juice solids of the pasteurized orange juice, the label shall bear the statement "prepared in part from concentrated orange juice" or "with added concentrated orange juice" or "concentrated orange juice added".

(2) If one or more of the sweetening ingredients specified in paragraph (c) of this section are added to the pasteurized orange juice, the label shall bear the statement "_____ added", the blank being filled in with the name or an appropriate combination of the names of the sweetening ingredients used. However, for the purpose of this section, the name "sweetener" may be used in lieu of the specific name or names of the sweetening ingredients.

(f) Wherever the name of the food appears on the label so conspicuously as to be easily seen under customary conditions of purchase, the statements specified in this section for naming the optional ingredients used shall immediately and conspicuously precede or follow the name of the food, without intervening written, printed, or graphic matter.

(g) Label declaration. Each of the ingredients used in the food shall be declared on the label as required by the applicable sections of parts 101 and 130 of this chapter.

[42 FR 14433, Mar. 15, 1977, as amended at 57 FR 57667, Dec. 7, 1992; 58 FR 2881, Jan. 6, 1993]

§ 146.141 Canned orange juice.

(a) Canned orange juice is the food prepared from orange juice as specified

§ 146.145

in §146.135 or frozen orange juice as specified in §146.137, or a combination of both, to which may be added not more than 10 percent by volume of the unfermented juice obtained from mature oranges of the species *Citrus reticulata* or *Citrus reticulata* hybrids (except that this limitation shall not apply to the hybrid species described in §146.135). Seeds (except embryonic seeds and small fragments of seeds that cannot be separated by good manufacturing practice) are removed. Orange oil and pulp may be adjusted in accordance with good manufacturing practice. The adjustment of pulp referred to in this paragraph does not permit the addition of washed or spent pulp. Liquid condensate recovered from the deoiling operation may be added back. One or more of the optional sweetening ingredients named in paragraph (b) of this section may be added, in a quantity reasonably necessary to raise the Brix or the Brix-acid ratio to any point within the normal range usually found in unfermented juice obtained from mature oranges as specified in §146.135. The food is sealed in containers and so processed by heat, either before or after sealing, as to prevent spoilage. The finished canned orange juice tests not less than 10° Brix, and the ratio of the Brix hydrometer reading to the grams of anhydrous citric acid per 100 milliliters of juice is not less than 9 to 1.

(b) The optional sweetening ingredients referred to in paragraph (a) of this section are sugar, invert sugar, dextrose, dried corn sirup, dried glucose sirup.

(c) The name of the food is "Canned orange juice". All the words in the name shall appear in the same size, color, and style of type and on the same color-contrasting background. If the food is not sold under refrigeration and if it does not purport to be chilled pasteurized orange juice or frozen pasteurized orange juice, the word "canned" may be omitted from the name.

(d) If one or more of the sweetening ingredients specified in paragraph (b) of this section are added to the canned orange juice, the label shall bear the statement "_____ added", the blank being filled in with the name or an ap-

21 CFR Ch. I (4-1-07 Edition)

propriate combination of the names of the sweetening ingredients used. However, for the purpose of this section, the name "sweetener" may be used in lieu of the specific name or names of the sweetening ingredients.

(e) Wherever the name of the food appears on the label so conspicuously as to be easily seen under customary conditions of purchase, the statement specified in this section for naming the optional ingredients used shall immediately and conspicuously precede or follow the name of the food, without intervening written, printed, or graphic matter.

(f) Label declaration. Each of the ingredients used in the food shall be declared on the label as required by the applicable sections of parts 101 and 130 of this chapter.

[42 FR 14433, Mar. 15, 1977, as amended at 57 FR 57667, Dec. 7, 1992; 58 FR 2881, Jan. 6, 1993]

§ 146.145 Orange juice from concentrate.

(a) Orange juice from concentrate is the food prepared by mixing water with frozen concentrated orange juice as defined in §146.146 or with concentrated orange juice for manufacturing as defined in §146.153 (when made from mature oranges), or both. To such mixture may be added orange juice as defined in §146.135, frozen orange juice as defined in §146.137, pasteurized orange juice as defined in §146.140, orange juice for manufacturing as defined in §146.151 (when made from mature oranges and preserved by chilling or freezing but not by canning), orange oil, orange pulp, and one or more of the sweetening ingredients listed in paragraph (b) of this section. The finished orange juice from concentrate contains not less than 11.8 percent orange juice soluble solids, exclusive of solids of any added optional sweetening ingredients. It may be so treated by heat as to reduce substantially the enzymatic activity and the number of viable microorganisms.

(b) The sweetening ingredients referred to in paragraph (a) of this section are sugar, sugar sirup, invert sugar, invert sugar sirup, dextrose, corn sirup, dried corn sirup, glucose sirup, dried glucose sirup.

(c) The name of the food is "Orange juice from concentrate". The words "from concentrate" shall be shown in letters not less than one-half the height of the letters in the words "orange juice".

(d) When orange juice from concentrate contains any optional sweetening ingredient as listed in paragraph (b) of this section, whether added directly as such or indirectly as an added ingredient of any orange juice product used, the label shall bear the statement "_____ added", the blank being filled in with the name or an appropriate combination of the names of the sweetening ingredients added. However, for the purposes of this section the name "sweetener" may be used in lieu of the specific name or names of the sweetening ingredients.

(e) Wherever the name of the food appears on the label so conspicuously as to be easily seen under customary conditions of purchase, the statements specified in this section for naming the optional ingredients used shall immediately and conspicuously precede or follow the name of the food, without intervening written, printed, or graphic matter.

(f) Label declaration. Each of the ingredients used in the food shall be declared on the label as required by the applicable sections of parts 101 and 130 of this chapter.

[42 FR 14433, Mar. 15, 1977, as amended at 58 FR 2881, Jan. 6, 1993]

§ 146.146 Frozen concentrated orange juice.

(a) Frozen concentrated orange juice is the food prepared by removing water from the juice of mature oranges as provided in §146.135, to which may be added unfermented juice obtained from mature oranges of the species *Citrus reticulata*, other *Citrus reticulata* hybrids, or of *Citrus aurantium*, or both. However, in the unconcentrated blend, the volume of juice from *Citrus reticulata* or *Citrus reticulata* hybrids shall not exceed 10 percent (except that this limitation shall not apply to the hybrid species described in §146.135) and from *Citrus aurantium* shall not exceed 5 percent. The concentrate so obtained is frozen. In its preparation, seeds (except embryonic seeds and

small fragments of seeds that cannot be separated by good manufacturing practice) and excess pulp are removed, and a properly prepared water extract of the excess pulp so removed may be added. Orange oil, orange pulp, orange essence (obtained from orange juice), orange juice and other orange juice concentrate as provided in this section or concentrated orange juice for manufacturing provided in §146.153 (when made from mature oranges), water, and one or more of the optional sweetening ingredients specified in paragraph (b) of this section may be added to adjust the final composition. The juice of *Citrus reticulata* and *Citrus aurantium*, as permitted by this paragraph, may be added in single strength or concentrated form prior to concentration of the *Citrus sinensis* juice, or in concentrated form during adjustment of the composition of the finished food. The addition of concentrated juice from *Citrus reticulata* or *Citrus aurantium*, or both, shall not exceed, on a single-strength basis, the 10 percent maximum for *Citrus reticulata* and the 5 percent maximum for *Citrus aurantium* prescribed by this paragraph. Any of the ingredients of the finished concentrate may have been so treated by heat as to reduce substantially the enzymatic activity and the number of viable microorganisms. The finished food is of such concentration that when diluted according to label directions the diluted article will contain not less than 11.8 percent by weight of orange juice soluble solids, exclusive of the solids of any added optional sweetening ingredients. The dilution ratio shall be not less than 3 plus 1. For the purposes of this section and §146.150, the term "dilution ratio" means the whole number of volumes of water per volume of frozen concentrate required to produce orange juice from concentrate having orange juice soluble solids of not less than 11.8 percent by weight exclusive of the solids of any added optional sweetening ingredients.

(b) The optional sweetening ingredients referred to in paragraph (a) of this section are sugar, sugar sirup, invert sugar, invert sugar sirup, dextrose, corn sirup, dried corn sirup, glucose sirup, and dried glucose sirup.

§ 146.148

21 CFR Ch. I (4-1-07 Edition)

(c) If one or more of the sweetening ingredients specified in paragraph (b) of this section are added to the frozen concentrated orange juice, the label shall bear the statement “_____ added”, the blank being filled in with the name or an appropriate combination of names of the sweetening ingredients used. However, for the purpose of this section, the name “sweetener” may be used in lieu of the specific name or names of the sweetening ingredients.

(d) The name of the food concentrated to a dilution ratio of 3 plus 1 is “frozen concentrated orange juice” or “frozen orange juice concentrate”. The name of the food concentrated to a dilution ratio greater than 3 plus 1 is “frozen concentrated orange juice, _____ plus 1” or “frozen orange juice concentrate, _____ plus 1”, the blank being filled in with the whole number showing the dilution ratio; for example, “frozen orange juice concentrate, 4 plus 1”. However, where the label bears directions for making 1 quart of orange juice from concentrate (or multiples of a quart), the blank in the name may be filled in with a mixed number; for example, “frozen orange juice concentrate, 4½ plus 1”. For containers larger than 1 pint, the dilution ratio in the name may be replaced by the concentration of orange juice soluble solids in degrees Brix; for example, a 62° Brix concentrate in 3½-gallon cans may be named on the label “frozen concentrated orange juice, 62° Brix”.

(e) Wherever the name of the food appears on the label so conspicuously as to be easily seen under customary conditions of purchase, the statements specified in this section for naming the optional ingredients used shall immediately and conspicuously precede or follow the name of the food, without intervening written, printed, or graphic matter.

(f) Nothing in this section is intended to interfere with the adoption and enforcement by any State, in regulating the production of frozen concentrated orange juice in such State, of State standards, consistent with this section, but which impose higher or more restrictive requirements than those set forth in this section.

(g) Label declaration. Each of the ingredients used in the food shall be declared on the label as required by the applicable sections of parts 101 and 130 of this chapter.

[42 FR 14433, Mar. 15, 1977, as amended at 57 FR 57667, Dec. 7, 1992; 58 FR 2881, Jan. 6, 1993]

§ 146.148 Reduced acid frozen concentrated orange juice.

(a) Reduced acid frozen concentrated orange juice is the food that complies with the requirements for composition and label declaration of ingredients prescribed for frozen concentrated orange juice by §146.146, except that it may not contain any added sweetening ingredient. A process involving the use of anionic ion-exchange resins permitted by §173.25 of this chapter is used to reduce the acidity of the food so that the ratio of the Brix reading to the grams of acid, expressed as anhydrous citric acid, per 100 grams of juice is not less than 21 to 1 or more than 26 to 1.

(b) The name of the food is “Reduced acid frozen concentrated orange juice”.

[45 FR 12414, Feb. 26, 1980, as amended at 58 FR 2881, Jan. 6, 1993]

§ 146.150 Canned concentrated orange juice.

(a) Canned concentrated orange juice is the food that complies with the requirements of composition, definition of dilution ratio, and labeling of ingredients prescribed for frozen concentrated orange juice by §146.146, except that it is not frozen and it is sealed in containers and so processed by heat, either before or after sealing, so as to prevent spoilage.

(b) The name of the food when concentrated to a dilution ratio of 3 plus 1 is “Canned concentrated orange juice” or “Canned orange juice concentrate”. The name of the food when concentrated to a dilution ratio greater than 3 plus 1 is “Canned concentrated orange juice, _____ plus 1” or “Canned orange juice concentrate, _____ plus 1”, the blank being filled in with the whole number showing the dilution ratio; for example, “Canned orange juice concentrate, 4 plus 1”. However, where the label bears directions for making 1 quart of single-strength diluted product (or multiples of a quart)

the blank in the name may be filled in with a mixed number; for example, "Canned orange juice concentrate, $4\frac{1}{2}$ plus 1". For containers larger than 1 pint, the dilution ratio in the name may be replaced by the concentration of orange juice soluble solids in degrees Brix; for example, a 62° Brix concentrate in 1-gallon cans may be named on the label "canned concentrated orange juice, 62° Brix". If the food does not purport to be frozen concentrated orange juice, the word "canned" may be omitted from the name.

[42 FR 14433, Mar. 15, 1977, as amended at 58 FR 2881, Jan. 6, 1993]

§ 146.151 Orange juice for manufacturing.

(a) Orange juice for manufacturing is the food prepared for further manufacturing use. It is prepared from unfermented juice obtained from oranges as provided in §146.135, except that the oranges may deviate from the standards for maturity in that they are below the minimum for Brix and Brix-acid ratio for such oranges, and to which juice may be added not more than 10 percent by volume of the unfermented juice obtained from oranges of the species *Citrus reticulata* or *Citrus reticulata* hybrids (except that this limitation shall not apply to the hybrid species described in §146.135). Seeds (except embryonic seeds and small fragments of seeds that cannot be separated by good manufacturing practice) are removed, and pulp and orange oil may be adjusted in accordance with good manufacturing practice. If pulp is added it shall be other than washed or spent pulp. The juice or portions thereof may be so treated by heat as to reduce substantially the enzymatic activity and number of viable microorganisms, and it may be chilled or frozen, or it may be so treated by heat, either before or after sealing in containers, as to prevent spoilage.

(b) The name of the food is "Orange juice for manufacturing".

[42 FR 14433, Mar. 15, 1977, as amended at 57 FR 57667, Dec. 7, 1992]

§ 146.152 Orange juice with preservative.

(a) Orange juice with preservative is the food prepared for further manufac-

turing use. It complies with the requirements for composition of orange juice for manufacturing as provided for in §146.151, except that a preservative is added to inhibit spoilage. It may be heat-treated to reduce substantially the enzymatic activity and the number of viable microorganisms.

(b) The preservatives referred to in paragraph (a) of this section are any safe and suitable preservatives or combinations thereof.

(c) The name of the food is "Orange juice with preservative".

(d) Label declaration. Each of the ingredients used in the food shall be declared on the label as required by the applicable sections of parts 101 and 130 of this chapter. In addition, the name of each preservative shall be preceded by a statement of the percent by weight of the preservative used. If the food is packed in container sizes that are less than 19 liters (5 gallons), the label shall bear a statement indicating that the food is for further manufacturing use only.

(e) Wherever the name of the food appears on the label so conspicuously as to be easily seen under customary conditions of purchase, the statement specified in paragraph (d) of this section for naming the preservative ingredient used shall immediately and conspicuously precede or follow the name of the food, without intervening written, printed, or graphic matter.

[42 FR 14414, Mar. 15, 1977, as amended at 44 FR 36378, June 22, 1979; 58 FR 2881, Jan. 6, 1993]

§ 146.153 Concentrated orange juice for manufacturing.

(a) Concentrated orange juice for manufacturing is the food that complies with the requirements of composition and label declaration of ingredients prescribed for frozen concentrated orange juice by §146.146, except that it is either not frozen or is less concentrated, or both, and the oranges from which the juice is obtained may deviate from the standards for maturity in that they are below the minimum Brix and Brix-acid ratio for such oranges: *Provided*, however, that the concentration of orange juice soluble solids is not less than 20° Brix.

§ 146.154

21 CFR Ch. I (4-1-07 Edition)

(b) The name of the food is “Concentrated orange juice for manufacturing, _____” or “_____ orange juice concentrate for manufacturing”, the blank being filled in with the figure showing the concentration of orange juice soluble solids in degrees Brix.

[42 FR 14433, Mar. 15, 1977, as amended at 58 FR 2881, Jan. 6, 1993]

§ 146.154 Concentrated orange juice with preservative.

(a) Concentrated orange juice with preservative complies with the requirements for composition and labeling of optional ingredients prescribed for concentrated orange juice for manufacturing by §146.153, except that a preservative is added to inhibit spoilage.

(b) The preservatives referred to in paragraph (a) of this section are any safe and suitable preservatives or combinations thereof.

(c) The name of the food is “Concentrated orange juice with preservative, _____”, the blank being filled in with the figure showing the concentration of orange juice soluble solids in degrees Brix.

(d) *Label declaration.* Each of the ingredients used in the food shall be declared on the label as required by the applicable sections of parts 101 and 130 of this chapter. In addition, the name of each preservative shall be preceded by a statement of the percent by weight of the preservative used. If the food is packed in container sizes that are less than 19 liters (5 gallons), the label shall bear a statement indicating that the food is for further manufacturing use only.

(e) Wherever the name of the food appears on the label so conspicuously as to be easily seen under customary conditions of purchase, the statement specified in paragraph (d) of this section for naming the preservative ingredient used shall immediately and conspicuously precede or follow the name of the food, without intervening written, printed, or graphic matter.

[42 FR 14414, Mar. 15, 1977, as amended at 44 FR 36378, June 22, 1979; 58 FR 2882, Jan. 6, 1993]

§ 146.185 Pineapple juice.

(a) *Identity.* (1) Pineapple juice is the juice, intended for direct consumption,

obtained by mechanical process from the flesh or parts thereof, with or without core material, of sound, ripe pineapple (*Ananas comosus* L. Merrill). The juice may have been concentrated and later reconstituted with water suitable for the purpose of maintaining essential composition and quality factors of the juice. Pineapple juice may contain finely divided insoluble solids, but it does not contain pieces of shell, seeds, or other coarse or hard substances or excess pulp. It may be sweetened with any safe and suitable dry nutritive carbohydrate sweetener. However, if the pineapple juice is prepared from concentrate, such sweeteners, in liquid form, also may be used. It may contain added vitamin C in a quantity such that the total vitamin C in each 4 fluid ounces of the finished food amounts to not less than 30 milligrams and not more than 60 milligrams. In the processing of pineapple juice, dimethylpolysiloxane complying with the requirements of §173.340 of this chapter may be employed as a defoaming agent in an amount not greater than 10 parts per million by weight of the finished food. Such food is prepared by heat sterilization, refrigeration, or freezing. When sealed in a container to be held at ambient temperatures, it is so processed by heat, before or after sealing, as to prevent spoilage.

(2) The name of the food is “Pineapple juice” if the juice from which it is prepared has not been concentrated and/or diluted with water. The name of the food is “Pineapple juice from concentrate” if the finished juice has been made from pineapple juice concentrate as specified in paragraph (a) of this section. If a nutritive sweetener is added, the label shall bear the statement “Sweetener added.” If no sweetener is added, the word “Unsweetened” may immediately precede or follow the words “Pineapple juice” or “Pineapple juice from concentrate.”

(3) *Label declaration.* Each of the ingredients used in the food shall be declared on the label as required by the applicable sections of parts 101 and 130 of this chapter.

(b) *Quality.* (1) The standard of quality for pineapple juice is as follows:

(i) The soluble solids content of pineapple juice (exclusive of added sugars)

without added water shall not be less than 10.5° Brix as determined by refractometer at 20 °C uncorrected for acidity and read as degrees Brix on International Sucrose Scales. Where the juice has been obtained using concentrated juice with addition of water, the soluble pineapple juice solids content (exclusive of added sugars) shall be not less than 12.8° Brix, uncorrected for acidity and read as degrees Brix on the International Sucrose Scales.

(ii) The acidity, as determined by the method prescribed in paragraph (b)(2)(ii) of this section, is not more than 1.35 grams of anhydrous citric acid per 100 milliliters of the juice.

(iii) The ratio of the degrees Brix to total acidity, as determined by the method prescribed in paragraph (b)(2)(iii) of this section, is not less than 12.

(iv) The quantity of finely divided “insoluble solids”, as determined by the method prescribed in paragraph (b)(2)(iv) of this section, is not less than 5 percent nor more than 30 percent.

(2) The methods referred to in paragraph (b)(1) of this section are as follows:

(i) Determine the degrees Brix of the pineapple juice by the method prescribed in “Official Methods of Analysis of the Association of Official Analytical Chemists,” 13th Ed. (1980), section 31.009, “Solids by Means of Spindle—Official Final Action,” which is incorporated by reference. Copies may be obtained from the AOAC INTERNATIONAL, 481 North Frederick Ave., suite 500, Gaithersburg, MD 20877, or may be examined at the National Archives and Records Administration (NARA). For information on the availability of this material at NARA, call 202-741-6030, or go to: http://www.archives.gov/federal_register/code_of_federal_regulations/ibr_locations.html.

(ii) Determine the total acidity of the pineapple juice by titration by the method prescribed in §145.180(b)(2)(ix) of this chapter.

(iii) Divide the degrees Brix determined as prescribed in paragraph (b)(2)(i) of this section by the grams of anhydrous citric acid per 100 milliliters of juice, determined as prescribed in

paragraph (b)(2)(ii) of this section, and report the results as ratio of degrees Brix to total acidity.

(iv) Determine the quantity of “insoluble solids” in pineapple juice as follows: Measure 50 milliliters of thoroughly stirred pineapple juice into a cone-shaped graduated tube of the long-cone type, measuring approximately 4³/₁₆ inches from tip to top calibration and having a capacity of 50 milliliters. Place the tube in a suitable centrifuge the approximate speed of which is related to diameter of swing in accordance with the table immediately below. The word “diameter” means the over-all distance between the tips of opposing centrifuge tubes in operating position.

Diameter (inches)	Approximate revolutions per minute
10	1,609
10½	1,570
11	1,534
11½	1,500
12	1,468
12½	1,438
13	1,410
13½	1,384
14	1,359
14½	1,336
15	1,313
15½	1,292
16	1,271
16½	1,252
17	1,234
17½	1,216
18	1,199
18½	1,182
19	1,167
19½	1,152
20	1,137

The milliliter reading at the top of the layer of “insoluble solids,” after centrifuging 3 minutes, is multiplied by two to obtain the percentage of “insoluble solids.”

(3) If the quality of pineapple juice falls below the standard prescribed in paragraph (b)(1) of this section, the label shall bear the general statement of substandard quality specified in §130.14 (a) of this chapter, in the manner and form therein specified.

(c) *Fill of container.* (1) The standard of fill of container for pineapple juice, except when the food is frozen, is not less than 90 percent of the total capacity of the container, as determined by the general method for fill of container prescribed in §130.12(b) of this chapter.

(2) If pineapple juice falls below the standard of fill of container prescribed in paragraph (c)(1) of this section, the label shall bear the statement of substandard fill specified in §130.14(b) of this chapter, in the manner and form therein specified.

[42 FR 14433, Mar. 15, 1977, as amended at 47 FR 11831, Mar. 19, 1982; 47 FR 52694, Nov. 23, 1982; 49 FR 10101, Mar. 19, 1984; 50 FR 19524, May 9, 1985; 54 FR 24895, June 12, 1989; 58 FR 2882, Jan. 6, 1993; 63 FR 14035, Mar. 24, 1998]

§ 146.187 Canned prune juice.

(a) Canned prune juice is the food prepared from a water extract of dried prunes and contains not less than 18.5 percent by weight of water-soluble solids extracted from dried prunes. The quantity of prune solids may be adjusted by the concentration, dilution, or both, of the water extract or extracts made. Such food may contain one or more of the optional acidifying ingredients specified in paragraph (b)(1) of this section, in a quantity sufficient to render the food slightly tart; it may contain honey added within the quantitative limits prescribed by paragraph (b)(2) of this section; and it may contain added vitamin C in a quantity prescribed by paragraph (b)(3) of this section. Such food is sealed in a container and so processed by heat, before or after sealing, as to prevent spoilage.

(b) The optional ingredients referred to in paragraph (a) of this section are:

(1) One or any combination of two or more of the following acidifying ingredients:

- (i) Lemon juice.
- (ii) Lime juice.
- (iii) Citric acid.

(2) Honey, in a quantity not less than 2 percent and not more than 3 percent by weight of the finished food.

(3) Vitamin C, in a quantity such that the total vitamin C in each 6 fluid ounces of the finished food amounts to not less than 30 milligrams and not more than 50 milligrams.

(c)(1) The name of the food is “Prune juice—a water extract of dried prunes”. For the purposes of the Federal Food, Drug, and Cosmetic Act concerning the label declaration of the name of the food, the explanatory statement “A water extract of dried prunes” may appear immediately below the words

“prune juice”, but there shall be no intervening written, printed, or graphic matter, and the type used for the words “A water extract of dried prunes” shall be of the same style and not less than half the print size of the type used for the words “prune juice”.

(2)(i) When one or more of the acidifying ingredients specified in paragraph (b)(1) of this section are used, the label shall bear the statement “_____ added” or “with added _____”, the blank being filled in with the name or names of the optional ingredients used.

(ii) When honey, as specified in paragraph (b)(2) of this section, is used the label shall bear the statement “with _____ honey” or “_____ honey added”, the blank to be filled in with the percent by weight of the honey in the finished food or with the statement “between 2 and 3%”.

(iii) When one or more of the ingredients designated in paragraph (b)(1) of this section and the ingredient designated in paragraph (b)(2) of this section are used, the statements specified in paragraphs (c)(2) (i) and (ii) of this section may be combined, as for example, “with lemon juice and between 2 and 3% honey added”.

(iv) When vitamin C is added as provided in paragraph (b)(3) of this section, it shall be designated on the label as “vitamin C added” or “with added vitamin C”.

(3) Wherever the name of the food appears on the label so conspicuously as to be easily seen under customary conditions of purchase, the words specified in this paragraph, showing the optional ingredients used, shall immediately and conspicuously precede or follow such name, without intervening written, printed, or graphic matter.

(d) Label declaration. Each of the ingredients used in the food shall be declared on the label as required by the applicable sections of parts 101 and 130 of this chapter.

[42 FR 14433, Mar. 15, 1977, as amended at 58 FR 2882, Jan. 6, 1993]

PART 150—FRUIT BUTTERS, JELLIES, PRESERVES, AND RELATED PRODUCTS

Subpart A [Reserved]

Subpart B—Requirements for Specific Standardized Fruit Butters, Jellies, Preserves, and Related Products

Sec.

- 150.110 Fruit butter.
- 150.140 Fruit jelly.
- 150.141 Artificially sweetened fruit jelly.
- 150.160 Fruit preserves and jams.
- 150.161 Artificially sweetened fruit preserves and jams.

AUTHORITY: 21 U.S.C. 321, 341, 343, 348, 371, 379e.

SOURCE: 42 FR 14445, Mar. 15, 1977, unless otherwise noted.

Subpart A [Reserved]

Subpart B—Requirements for Specific Standardized Fruit Butters, Jellies, Preserves, and Related Products

§ 150.110 Fruit butter.

(a) The fruit butters for which definitions and standards of identity are prescribed by this section are the smooth, semisolid foods each of which is made from a mixture of one or a permitted combination of the optional fruit ingredients specified in paragraph (b) of this section and one or any combination of the optional ingredients specified in paragraph (c) of this section, which meets the specifications in paragraph (d) of this section, and which is labeled in accordance with paragraph (e) of this section. Such mixture is concentrated with or without heat. The volatile flavoring materials or essence from such mixture may be captured during concentration, separately concentrated, and added back to any such mixture, together with any concentrated essence accompanying any optional fruit ingredient.

(b)(1) Each of the optional fruit ingredients referred to in paragraph (a) of this section is prepared by cooking one of the following fresh, frozen, canned, and/or dried (evaporated) mature fruits, with or without added

water, and screening out skins, seeds, pits, and cores:

FACTOR REFERRED TO IN PARAGRAPH (D)(2) OF THIS SECTION

Name of fruit	
Apple	7.5
Apricot	7.0
Grape	7.0
Peach	8.5
Pear	6.5
Plum (other than prune)	7.0
Prune	7.0
Quince	7.5

(2) The permitted combinations are of two, three, four, and five of the fruit ingredients specified in paragraph (b)(1) of this section; the weight of each is not less than one-fifth of the weight of the combination. Each such fruit ingredient in any such combination is an optional ingredient.

(c) The following safe and suitable optional ingredients may be used:

- (1) Nutritive carbohydrate sweeteners.
- (2) Spice.
- (3) Flavoring (other than artificial flavoring).
- (4) Salt.
- (5) Acidifying agents.
- (6) Fruit juice or diluted fruit juice or concentrated fruit juice, in a quantity not less than one-half the weight of the optional fruit ingredient.
- (7) Preservatives.
- (8) Antifoaming agents except those derived from animal fats.
- (9) Pectin, in a quantity which reasonably compensates for deficiency, if any, of the natural pectin content of the fruit ingredient.

(d) For the purposes of this section:

(1) The mixture referred to in paragraph (a) of this section shall contain not less than five parts by weight of the fruit ingredient as measured in accordance with paragraph (d)(2) of this section to each two parts by weight of nutritive carbohydrate sweetener as measured in accordance with paragraph (d)(4) of this section.

(2) Any requirement with respect to the weight of any optional fruit ingredient, whether concentrated, unconcentrated, or diluted, means the weight determined by the following method: (i) Determine the percent of

§ 150.140

21 CFR Ch. I (4–1–07 Edition)

soluble solids in the optional fruit ingredient by the method for soluble solids referred to in paragraph (d)(3) of this section; (ii) multiply the percent so found by the weight of such fruit ingredient; (iii) divide the result by 100; (iv) subtract from the quotient the weight of any nutritive sweetener solids or other added solids; and (v) multiply the remainder by the factor for such ingredient prescribed in paragraph (b)(1) of this section. The result is the weight of the optional fruit ingredient.

(3) The soluble solids content of the finished fruit butter is not less than 43 percent, as determined by the method prescribed in “Official Methods of Analysis of the Association of Official Analytical Chemists” (AOAC), 13th Ed. (1980), section 22.024, under “Soluble Solids by Refractometer in Fresh and Canned Fruits, Fruit Jellies, Marmalades, and Preserves—Official Final Action,” which is incorporated by reference, except that no correction is made for water-insoluble solids. Copies may be obtained from the AOAC INTERNATIONAL, 481 North Frederick Ave., suite 500, Gaithersburg, MD 20877, or may be examined at the National Archives and Records Administration (NARA). For information on the availability of this material at NARA, call 202-741-6030, or go to: http://www.archives.gov/federal_register/code_of_federal_regulations/ibr_locations.html.

(4) The weight of any nutritive carbohydrate sweetener means the weight of the solids of such ingredient.

(5) The weight of fruit juice or diluted fruit juice or concentrated fruit juice (optional ingredient, paragraph (c)(6)) from a fruit specified in paragraph (b)(1) of this section is the weight of such juice, as determined by the method prescribed in paragraph (d)(2) of this section, except that the percent of soluble solids is determined by the method prescribed in the AOAC, 13th Ed. (1980), section 31.011, under “Solids by Means of Refractometer—Official Final Action,” which is incorporated by reference; the weight of diluted concentrated juice from any other fruits is the original weight of the juice before it was diluted or concentrated. The availability of this in-

corporation by reference is given in paragraph (d)(3) of this section.

(e)(1) *Label declaration.* Each of the ingredients used in the food shall be declared on the label as required by the applicable sections of parts 101 and 130 of this chapter, except that:

(i) In case the fruit butter is made from a single fruit ingredient, the name is “Butter”, preceded by the name where by such fruit is designated in paragraph (b)(1) of this section.

(ii) In case the fruit butter is made from a combination of two, three, four, or five fruit ingredients, the name is “Butter”, preceded by the words “Mixed fruit” or by the names whereby such fruits are designated in paragraph (b)(1) of this section, in the order of predominance, if any, of the weight of such fruit ingredients in the combination.

(2) Each of the optional ingredients specified in paragraphs (b) and (c) of this section shall be declared on the label as required by the applicable sections of part 101 of this chapter, except that:

(i) Other than in the case of dried (evaporated) fruit the name(s) of the fruit or fruits used may be declared without specifying the particular form of the fruit or fruits used. When the optional fruit ingredient is prepared in whole or in part from dried fruit, the label shall bear the words “prepared from” or “prepared in part from”, as the case may be, followed by the word “evaporated” or “dried”, followed by the name whereby such fruit is designated in paragraph (c) of this section. When two or more such optional fruit ingredients are used, such names, each preceded by the word “evaporated” or “dried”, shall appear in the order of predominance, if any, of the weight of such ingredients in the combination.

(ii) [Reserved]

[42 FR 14445, Mar. 15, 1977, as amended at 47 FR 11831, Mar. 19, 1982; 49 FR 10101, Mar. 19, 1984; 54 FR 24895, June 12, 1989; 58 FR 2882, Jan. 6, 1993; 63 FR 14035, Mar. 24, 1998]

§ 150.140 Fruit jelly.

(a) The jellies for which definitions and standards of identity are prescribed by this section are the jelled foods each of which is made from a

mixture of one or a permitted combination of the fruit juice ingredients specified in paragraph (b) of this section and one or any combination of the optional ingredients specified in paragraph (c) of this section, which meets the specifications in paragraph (d) of this section and which is labeled in accordance with paragraph (e) of this section. Such mixture is concentrated with or without heat. The volatile flavoring materials or essence from such mixture may be captured during concentration, separately concentrated, and added back to any such mixture, together with any concentrated essence accompanying any optional fruit ingredient.

(b)(1) Each of the fruit juice ingredients referred to in paragraph (a) of this section is the filtered or strained liquid extracted with or without the application of heat and with or without the addition of water, from one of the following mature, properly prepared fruits which are fresh, frozen and/or canned:

FACTOR REFERRED TO IN PARAGRAPH (D)(2) OF THIS SECTION

Name of fruit	
Apple	7.5
Apricot	7.0
Blackberry (other than dewberry)	10.0
Black raspberry	9.0
Boysenberry	10.0
Cherry	7.0
Crabapple	6.5
Cranberry	9.5
Damson, damson plum	7.0
Dewberry (other than boysenberry, loganberry, and youngberry)	10.0
Fig	5.5
Gooseberry	12.0
Grape	7.0
Grapefruit	11.0
Greengage, greengage plum	7.0
Guava	13.0
Loganberry	9.5
Orange	8.0
Peach	8.5
Pineapple	7.0
Plum (other than damson, greengage, and prune)	7.0
Pomegranate	5.5
Prickly pear	11.0
Quince	7.5
Raspberry, red raspberry	9.5
Red currant, currant (other than black currant)	9.5
Strawberry	12.5
Youngberry	10.0

(2) The permitted combinations are of two, three, four, or five of the fruit juice ingredients specified in paragraph (b)(1) of this section, the weight of each is not less than one-fifth of the weight

of the combination. Each such fruit juice ingredient in any such combination is an optional ingredient.

(c) The following safe and suitable optional ingredients may be used:

- (1) Nutritive carbohydrate sweeteners.
- (2) Spice.
- (3) Acidifying agents.
- (4) Pectin, in a quantity which reasonably compensates for deficiency, if any, of the natural pectin content of the fruit juice ingredient.
- (5) Buffering agents.
- (6) Preservatives.
- (7) Antifoaming agents except those derived from animal fats.
- (8) Mint flavoring and artificial green coloring, in case the fruit juice ingredient or combination of fruit juice ingredients is extracted from apple, crabapple, pineapple, or two or all of such fruits.
- (9) Cinnamon flavoring, other than artificial flavoring, and artificial red coloring in case the fruit juice ingredient or combination of fruit juice ingredients is extracted from apple or crabapple or both such fruits.

(d) For the purposes of this section:

(1) The mixture referred to in paragraph (a) of this section shall contain not less than 45 parts by weight of the fruit juice ingredients as measured in accordance with paragraph (d)(2) of this section to each 55 parts by weight of saccharine ingredient as measured in accordance with paragraph (d)(4) of this section.

(2) Any requirement with respect to the weight of any fruit juice ingredient, whether prepared from concentrated, unconcentrated, or diluted fruit juice means the weight determined by the following method: (i) Determine the percent of soluble solids in such fruit juice ingredient by the method for soluble solids referred to in paragraph (d)(3) of this section; (ii) multiply the percent so found by the weight of such fruit juice ingredient; (iii) divide the result by 100; (iv) subtract from the quotient the weight of any added saccharine ingredient solids or other added solids; and (v) multiply the remainder by the factor for such fruit juice ingredient prescribed in

§ 150.141

21 CFR Ch. I (4–1–07 Edition)

paragraph (b) of this section. The result is the weight of the fruit juice ingredient.

(3) The soluble-solids content of the finished jelly is not less than 65 percent, as determined by the method prescribed in “Official Methods of Analysis of the Association of Official Analytical Chemists,” 13th Ed. (1980), section 31.011, under “Solids by Means of Refractometer—Official Final Action,” which is incorporated by reference. Copies may be obtained from the AOAC INTERNATIONAL, 481 North Frederick Ave., suite 500, Gaithersburg, MD 20877, or may be examined at the National Archives and Records Administration (NARA). For information on the availability of this material at NARA, call 202-741-6030, or go to: http://www.archives.gov/federal_register/code_of_federal_regulations/ibr_locations.html.

(4) The weight of any optional saccharine ingredient means the weight of the solids of such ingredient.

(e)(1) The name of each jelly for which a definition and standard of identity is prescribed by this section is as follows:

(i) In case the jelly is made with a single fruit juice ingredient, the name is “Jelly”, preceded or followed by the name or synonym whereby the fruit from which such fruit juice ingredient was extracted is designated in paragraph (b) of this section.

(ii) In case the jelly is made with a combination of two, three, four, or five fruit juice ingredients, the name is “Jelly”, preceded or followed by the words “Mixed fruit” or by the names or synonyms whereby the fruits from which the fruit juice ingredients were extracted are designated in paragraph (b) of this section, in the order of predominance, if any, of the weights of any such fruit juice ingredients in the combination.

(2) Label declaration. Each of the ingredients used in the food shall be declared on the label as required by the applicable sections of parts 101 and 130 of this chapter, except that:

(i) The name(s) of the fruit or fruits used may be declared without specifying the particular form of the fruit or fruits used.

(ii) When the optional ingredients listed in paragraphs (c) (3), (4), and (5) of this section are declared on the label, the declaration may be followed by the statement “Used as needed” on all jellies to which they are customarily, but not always, added to compensate for natural variations in the fruit juice ingredients used.

[42 FR 14445, Mar. 15, 1977, as amended at 47 FR 11831, Mar. 19, 1982; 49 FR 10101, Mar. 19, 1984; 54 FR 24895, June 12, 1989; 58 FR 2882, Jan. 6, 1993; 63 FR 14035, Mar. 24, 1998]

§ 150.141 Artificially sweetened fruit jelly.

(a) The artificially sweetened fruit jellies for which definitions and standards of identity are prescribed by this section are the jellied foods made from a fruit juice ingredient as specified in paragraph (b) of this section and an artificial sweetening ingredient as specified in paragraph (c) of this section, with a jelling ingredient as specified in paragraph (d) of this section. Water may be added. The quantity of the fruit juice ingredient, calculated as set out in § 150.140(b), amounts to not less than 55 percent by weight of the finished food. The article is sealed in containers and so processed by heat, either before or after sealing, as to prevent spoilage. Such food may also contain one or more of the following optional ingredients:

(1) Spice, spice oil, spice extract.

(2) A vinegar, lemon juice, lime juice, citric acid, lactic acid, malic acid, tartaric acid, fumaric acid, or any combination of two or more of these, in a quantity which reasonably compensates for deficiency, if any, of the natural acidity of the fruit juice ingredient.

(3) Sodium citrate, sodium acetate, sodium tartrate, monosodium phosphate, disodium phosphate, trisodium phosphate, sodium potassium tartrate, potassium citrate, potassium acid tartrate, or any combination thereof, in an amount not exceeding 2 ounces avoirdupois per 100 pounds of the finished food.

(4) Sodium hexametaphosphate in an amount not exceeding 8 ounces avoirdupois per 100 pounds of the finished food.

(5) Purified calcium chloride, calcium citrate, calcium gluconate, calcium lactate, calcium sulfate, monocalcium phosphate, potassium chloride, or any combination of two or more of these salts, in a quantity reasonably necessary to enable the jelling ingredients to produce a jellied finished product.

(6) Ascorbic acid, sorbic acid, sodium sorbate, potassium sorbate, sodium propionate, calcium propionate, sodium benzoate, benzoic acid, methylparaben (methyl-*p*-hydroxybenzoate), propylparaben (propyl-*p*-hydroxybenzoate), or any combination of two or more of these, in a quantity reasonably necessary as a preservative, but not to exceed 0.1 percent by weight of the finished food.

(b) The fruit juice ingredient referred to in paragraph (a) of this section is any one, or any combination of two, three, four, or five of the fruit juice ingredients complying with the requirements of §150.140(c). Except as paragraph (d) of this section permits the use of pectin, carrageenan, or salts of carrageenan standardized with nutritive sweetener, no nutritive sweetening ingredient is added, either directly or indirectly, to the fruit juice ingredient used to make artificially sweetened fruit jelly.

(c) The artificial sweetening ingredients referred to in paragraph (a) of this section are saccharin, sodium saccharin, calcium saccharin, or any combination of two or more of these.

(d) The jelling ingredients referred to in paragraph (a) of this section are pectin, agar-agar, carob bean gum (also called locust bean gum), guar gum, gum karaya, gum tragacanth, algin (sodium alginate), sodium carboxymethylcellulose (cellulose gum), methylcellulose (meeting U.S.P. requirements and with methoxy content not less than 27.5 percent and not more than 31.5 percent on a dry-weight basis), carrageenan or salts of carrageenan complying with the requirements of §172.620 or §172.626 of this chapter, or any combination of two or more of these. Pectin may be standardized with a nutritive sweetening ingredient, but such sweetening ingredient shall not amount to more than 44 percent by weight of the standardized pectin and the quantity of such standard-

ized pectin used shall not exceed 3 percent by weight of the finished food. Carrageenan or salts of carrageenan may be standardized with a nutritive sweetening ingredient, but such sweetening ingredient shall not amount to more than 25 percent by weight of the standardized carrageenan or salts of carrageenan and the quantity of such standardized carrageenan or salts of carrageenan used shall not exceed 2 percent by weight of the finished food.

(e) The name of each artificially sweetened fruit jelly for which a definition and standard of identity is prescribed by this section consists of the words "artificially sweetened", immediately followed by the name prescribed by §150.140(e)(1) for the fruit jelly which corresponds in its fruit ingredient to the artificially sweetened article. The words "artificially sweetened" shall be prominently and conspicuously displayed in letters not smaller than the largest letter used in any other word in the name of the food.

(f)(1) The jelling ingredient used shall be named on the label by a statement "_____ added" or "with added _____", the blank being filled in with the common name of the jelling ingredient used; for example, "pectin and methylcellulose added".

(2) When one of the optional ingredients specified in paragraph (a)(1) of this section is used, the label shall bear the statement "_____ added" or "with added _____", the blank being filled in with the words "spice", "spice oil", or "spice extract" as appropriate, but in lieu of the word "spice" in such statement the common name of the spice may be used.

(3) When the optional ingredient specified in paragraph (a)(4) of this section is used, the label shall bear the words "sodium hexametaphosphate added" or "with added sodium hexametaphosphate".

(4) When any optional ingredient listed in paragraph (a)(6) of this section is used, the label shall bear the statement "_____ added as a preservative", the blank being filled in with the common name of the preservative ingredient used as designated in paragraph (a)(6) of this section.

(g) Wherever the name of the food appears on the label of the artificially

§ 150.160

21 CFR Ch. I (4-1-07 Edition)

sweetened fruit jelly so conspicuously as to be easily seen under customary conditions of purchase, the words and statements specified in this section, showing the optional ingredients used, shall immediately and conspicuously precede or follow such name, without intervening written, printed, or graphic matter, except that the varietal name of the fruit source of the fruit juice ingredient used in preparing such jelly may so intervene.

(h) Label declaration. Each of the ingredients used in the food shall be declared on the label as required by the applicable sections of parts 101 and 130 of this chapter.

[42 FR 14445, Mar. 15, 1977, as amended at 58 FR 2882, Jan. 6, 1993]

§ 150.160 Fruit preserves and jams.

(a) The preserves or jams for which definitions and standards of identity are prescribed by this section are the viscous or semi-solid foods, each of which is made from a mixture composed of one or a permitted combination of the fruit ingredients specified in paragraph (b) of this section and one or any combination of the optional ingredients specified in paragraph (c) of this section which meets the specifications in paragraph (d) of this section, and which is labeled in accordance with paragraph (e) of this section. Such mixture, with or without added water, is concentrated with or without heat. The volatile flavoring material from such mixture may be captured during concentration, separately concentrated, and added back to any such mixture, together with any concentrated essence accompanying any optional fruit ingredient.

(b)(1) The fruit ingredients referred to in paragraph (a) of this section are the following mature, properly prepared fruits which are fresh, concentrated, frozen and/or canned:

GROUP I

Blackberry (other than dewberry), Black raspberry, Blueberry, Boysenberry, Cherry, Crabapple, Dewberry (other than boysenberry, loganberry, and youngberry) Elderberry, Grape, Grapefruit, Huckleberry, Loganberry, Orange, Pineapple, Raspberry, red raspberry, Rhubarb, Strawberry, Tangerine, Tomato, Yellow tomato, Youngberry

GROUP II

Apricot, Cranberry, Damson, damson plum, Fig, Gooseberry, Greengage, greengage plum, Guava, Nectarine, Peach, Pear, Plum (other than greengage plum and damson plum), Quince, Red currant, currant (other than black currant)

(2) The following combinations of fruit ingredients may be used:

(i) Any combination of two, three, four, or five of such fruits in which the weight of each is not less than one-fifth of the weight of the combination; except that the weight of pineapple may be not less than one-tenth of the weight of the combination.

(ii) Any combination of apple and one, two, three, or four of such fruits in which the weight of each is not less than one-fifth and the weight of apple is not more than one-half of the weight of the combination; except that the weight of pineapple may be not less than one-tenth of the weight of the combination.

In any combination of two, three, four, or five fruits, each such fruit is an optional ingredient. For the purposes of this section the word "fruit" includes the vegetables specified in this paragraph.

(c) The following safe and suitable optional ingredients may be used:

(1) Nutritive carbohydrate sweeteners.

(2) Spice.

(3) Acidifying agents.

(4) Pectin, in a quantity which reasonably compensates for deficiency, if any, of the natural pectin content of the fruit ingredient.

(5) Buffering agents.

(6) Preservatives.

(7) Antifoaming agents, except those derived from animal fat.

(d) For the purposes of this section:

(1) The mixture referred to in paragraph (a) of this section shall be composed of not less than: (i) In the case of a fruit ingredient consisting of a Group I fruit or a permitted combination exclusively of Group I fruits, 47 parts by weight of the fruit ingredient to each 55 parts by weight of the saccharine ingredient; and (ii) in all other cases, 45 parts by weight of the fruit ingredient to each 55 parts by weight of the saccharine ingredient. The weight of the fruit ingredient shall be determined in

accordance with paragraph (d)(2) of this section, and the weight of the saccharine ingredient shall be determined in accordance with paragraph (d)(5) of this section.

(2) Any requirement with respect to the weight of any fruit, combination of fruits, or fruit ingredient means:

(i) The weight of fruit exclusive of the weight of any sugar, water, or other substance added for any processing or packing or canning, or otherwise added to such fruit.

(ii) In the case of fruit prepared by the removal, in whole or in part, of pits, seeds, skins, cores, or other parts; the weight of such fruit, exclusive of the weight of all such substances removed therefrom.

(iii) In the cases of apricots, cherries, grapes, nectarines, peaches, and all varieties of plums, whether or not pits and seeds are removed therefrom; the weight of such fruit, exclusive of the weight of such pits and seeds.

(iv) In the case of concentrated fruit, the weight of the properly prepared fresh fruit used to produce such concentrated fruit.

(3) The term *concentrated fruit* means a concentrate made from the properly prepared edible portion of mature fresh or frozen fruits by removal of moisture with or without the use of heat or vacuum, but not to the point of drying. Such concentrate is canned or frozen without the addition of sugar or other sweetening agents and is identified to show or permit the calculation of the weight of the properly prepared fresh fruit used to produce any given quantity of such concentrate. The volatile flavoring material or essence from such fruits may be captured during concentration and separately concentrated for subsequent addition to the concentrated fruit either directly or during manufacture of the preserve or jam, in the original proportions present in the fruit.

(4) The weight of any optional saccharine ingredient means the weight of the solids of such ingredient.

(5) The soluble-solids content of the finished jam or preserve is not less than 65 percent, as determined by the method prescribed in "Official Methods of Analysis of the Association of Official Analytical Chemists," 13th Ed.

(1980), section 22.024, under "Soluble Solids by Refractometer in Fresh and Canned Fruits, Jellies, Marmalades, and Preserves—Official Final Action," which is incorporated by reference, except that no correction is made for water-insoluble solids. Copies may be obtained from the AOAC INTERNATIONAL, 481 North Frederick Ave., suite 500, Gaithersburg, MD 20877, or may be examined at the National Archives and Records Administration (NARA). For information on the availability of this material at NARA, call 202-741-6030, or go to: http://www.archives.gov/federal_register/code_of_federal_regulations/ibr_locations.html.

(e)(1) The name of each preserve or jam for which a definition and standard of identity is prescribed by this section is as follows:

(i) If the fruit ingredient is a single fruit, the name is "Preserve" or "Jam", preceded or followed by the name or synonym whereby such fruit is designated in paragraph (b) of this section.

(ii) If the fruit ingredient is a combination of two, three, four, or five fruits, the name is "Preserve" or "Jam", preceded or followed by the words "Mixed fruit" or by the names or synonyms whereby such fruits are designated in paragraph (b) of this section, in the order of predominance, if any, of the weights of such fruits in the combination.

(2) *Label declaration.* Each of the ingredients used in the food shall be declared on the label as required by the applicable sections of parts 101 and 130 of this chapter, except that:

(i) The name(s) of the fruit or fruits used may be declared without specifying the particular form of the fruit or fruits used.

(ii) When the optional ingredients listed in paragraphs (c) (3), (4), and (5) of this section are declared on the label, the declaration may be followed by the statement "used as needed" on all preserves or jams to which they are customarily, but not always, added to

compensate for natural variations in the fruit ingredients used.

[42 FR 14445, Mar. 15, 1977, as amended at 47 FR 11831, Mar. 19, 1982; 49 FR 10101, Mar. 19, 1984; 54 FR 24895, June 12, 1989; 58 FR 2882, Jan. 6, 1993; 63 FR 14035, Mar. 24, 1998]

§ 150.161 Artificially sweetened fruit preserves and jams.

(a) The artificially sweetened fruit preserves or artificially sweetened fruit jams for which definitions and standards of identity are prescribed by this section are the viscous or semi-solid foods made from a fruit ingredient as specified in paragraph (b) of this section and an artificial sweetening ingredient as specified in paragraph (c) of this section, and with or without water and a jelling ingredient as specified in paragraph (d) of this section. The quantity of the fruit ingredient amounts to not less than 55 percent by weight of the finished food. The article is sealed in containers and so processed by heat, either before or after sealing, as to prevent spoilage. Such food may also contain one or more of the following optional ingredients:

(1) Spice, spice oil, spice extract.

(2) A vinegar, lemon juice, lime juice, citric acid, lactic acid, malic acid, tartaric acid, fumaric acid, or any combination of two or more of these, in a quantity which reasonably compensates for deficiency, if any, of the natural acidity of the fruit ingredient.

(3) Sodium citrate, sodium acetate, sodium tartrate, monosodium phosphate, disodium phosphate, trisodium phosphate, sodium potassium tartrate, potassium citrate, potassium acid tartrate, or any combination thereof, in an amount not exceeding 2 ounces avoirdupois per 100 pounds of the finished food.

(4) Sodium hexametaphosphate in an amount not exceeding 8 ounces avoirdupois per 100 pounds of the finished food.

(5) Purified calcium chloride, calcium citrate, calcium gluconate, calcium lactate, calcium sulfate, monocalcium phosphate, potassium chloride, or any combination of two or more of these salts, in a quantity reasonably necessary to enable the jelling ingredients to produce a jelled finished product.

(6) Ascorbic acid, sorbic acid, sodium sorbate, potassium sorbate, sodium propionate, calcium propionate, sodium benzoate, benzoic acid, methylparaben (methyl-*p*-hydroxybenzoate), propylparaben (propyl-*p*-hydroxybenzoate), or any combination of two or more of these, in a quantity reasonably necessary as a preservative but not to exceed 0.1 percent by weight of the finished food.

(b) The fruit ingredient referred to in paragraph (a) of this section is any one, or any combination of two, three, four, or five of the fruit ingredients complying with the requirements of § 150.160 (b) and (c). Except as paragraph (d) of this section permits the use of pectin, carrageenan, or salts of carrageenan standardized with nutritive sweetener, no nutritive sweetening ingredient is added, either directly or indirectly, to the fruit ingredient used to make artificially sweetened fruit preserves or artificially sweetened fruit jam.

(c) The artificial sweetening ingredients referred to in paragraph (a) of this section are saccharin, sodium saccharin, calcium saccharin, or any combination of two or more of these.

(d) The jelling ingredients referred to in paragraph (a) of this section are pectin, agar-agar, carob bean gum (also called locust bean gum), guar gum, gum karaya, gum tragacanth, algin (sodium alginate), sodium carboxymethylcellulose (cellulose gum), methylcellulose (meeting U.S.P. requirements and with methoxy content not less than 27.5 percent and not more than 31.5 percent on a dry-weight basis), carrageenan or salts of carrageenan complying with the requirements of § 172.620 or § 172.626 of this chapter, or any combination of two or more of these. Pectin may be standardized with a nutritive sweetening ingredient, but such sweetening ingredient shall not amount to more than 44 percent by weight of the standardized pectin and the quantity of such standardized pectin used shall not exceed 3 percent by weight of the finished food. Carrageenan or salts of carrageenan may be standardized with a nutritive sweetening ingredient, but such sweetening ingredient shall not amount to more than 25 percent by weight of the

standardized carrageenan or salts of carrageenan and the quantity of such standardized carrageenan or salts of carrageenan used shall not exceed 2 percent by weight of the finished food.

(e) The name of each artificially sweetened fruit preserve or artificially sweetened fruit jam for which a definition and standard of identity is prescribed by this section consists of the words “artificially sweetened” immediately followed by the name prescribed by §150.160(e)(1) for the fruit preserves or jams which correspond in fruit ingredient to the artificially sweetened article. The words “artificially sweetened” shall be prominently and conspicuously displayed in letters not smaller than the largest letter used in any other word in the name of the food.

(f)(1) The jelling ingredient used shall be named on the label by a statement “_____ added” or “with added _____”, the blank being filled in with the common name of the jelling ingredient used.

(2) When one of the optional ingredients specified in paragraph (a)(1) of this section is used, the label shall bear the statement, “_____ added” or “with added _____”, the blank being filled in with the words “spice”, “spice oil”, or “spice extract” as appropriate, but in lieu of the word “spice” in such statement the common name of the spice may be used.

(3) When the optional ingredient specified in paragraph (a)(4) of this section is used, the label shall bear the words “sodium hexametaphosphate added” or “with added sodium hexametaphosphate”.

(4) When any optional ingredient listed in paragraph (a)(6) of this section is used, the label shall bear the statement “_____ added as a preservative”, the blank being filled in with the common name by which the preservative ingredient used is designated in paragraph (a)(6) of this section.

(g) Wherever the name of the food appears on the label of the artificially sweetened fruit preserve or artificially sweetened fruit jam so conspicuously as to be easily seen under customary conditions of purchase, the words and statements specified in this section, showing the optional ingredients used,

shall immediately and conspicuously precede or follow such name without intervening written, printed, or graphic matter, except that the varietal name of the fruit used in preparing such preserve or jam may so intervene.

(h) Label declaration. Each of the ingredients used in the food shall be declared on the label as required by the applicable sections of parts 101 and 130 of this chapter.

[42 FR 14445, Mar. 15, 1977, as amended at 58 FR 2882, Jan. 6, 1993]

PART 152—FRUIT PIES

AUTHORITY: 21 U.S.C. 321, 341, 343, 348, 371, 379e.

Subpart A [Reserved]

Subpart B—Requirements for Specific Standardized Fruit Pies

§ 152.126 Frozen cherry pie.

(a) *Identity.* (1) Frozen cherry pie (excluding baked and then frozen) is the food prepared by incorporating in a filling contained in a pastry shell mature, pitted, stemmed cherries that are fresh, frozen, and/or canned. The top of the pie may be open or it may be wholly or partly covered with pastry or other suitable topping. Filling, pastry, and topping components of the food consist of optional ingredients as prescribed by paragraph (a)(2) of this section. The finished food is frozen.

(2) The optional ingredients referred to in paragraph (a)(1) of this section consist of suitable substances that are not food additives as defined in section 201(s) of the Federal Food, Drug, and Cosmetic Act or color additives as defined in section 201(t) of the act; or if they are food additives or color additives as so defined, they are used in conformity with regulations established pursuant to section 409 or 721 of the act. Ingredients that perform a useful function in the formulation of the filling, pastry, and topping components, when used in amounts reasonably required to accomplish their intended effect, are regarded as suitable except that artificial sweeteners are not suitable ingredients of frozen cherry pie.

(3) The name of the food for which a definition and standard of identity is established by this section is frozen cherry pie; however, if the maximum diameter of the food (measured across opposite outside edges of the pastry shell) is not more than 4 inches, the food alternatively may be designated by the name frozen cherry tart. The word "frozen" may be omitted from the name on the label if such omission is not misleading.

(4)(i) Label declaration. Each of the ingredients used in the food shall be declared on the label as required by the applicable sections of parts 101 and 130 of this chapter.

(ii) The label shall not bear any misleading pictorial representation of the cherries in the pie.

(b) *Quality.* (1) The standard of quality for frozen cherry pie is as follows:

(i) The fruit content of the pie is such that the weight of the washed and drained cherry content is not less than 25 percent of the weight of the pie when determined by the procedure prescribed by paragraph (b)(2) of this section.

(ii) Not more than 15 percent by count of the cherries in the pie are blemished with scab, hail injury, discoloration, scar tissue, or other abnormality. A cherry showing skin discoloration (other than scald) having an aggregate area exceeding that of a circle nine thirty-seconds of an inch in diameter is considered to be blemished. A cherry showing discoloration of any area but extending into the fruit tissue is also considered to be blemished.

(2) Compliance with the requirement for the weight of the washed and drained cherry content of the pie, as prescribed by paragraph (b)(1)(i) of this section, is determined by the following procedure:

(i) Select a random sample from a lot:

(a) At least 24 containers if they bear a weight declaration of 16 ounces or less.

(b) Enough containers to provide a total quantity of declared weight of at least 24 pounds if they bear a weight declaration of more than 16 ounces.

(ii) Determine net weight of each frozen pie.

(iii) Temper the pie until the top crust can be removed.

(iv) Remove the filling and cherries from the pie and transfer to the surface of a previously weighed 12-inch diameter U.S. No. 8 sieve (0.094-inch openings) stacked on a U.S. No. 20 sieve (0.033-inch openings).

(v) Distribute evenly over the surface and wash with a gentle spray of water at 70°–75 °F to free the cherries and cherry fragments from the adhering material.

(vi) Remove the U.S. No. 8 sieve and examine the U.S. No. 20 sieve and transfer all cherry fragments to the U.S. No. 8 sieve.

(vii) Drain the cherry contents on the No. 8 sieve for 2 minutes in an inclined position (15°–30° slope). Weigh the U.S. No. 8 sieve and the washed and drained cherries to the nearest 0.01 ounce.

(viii) The weight of the washed and drained cherries is the weight of the sieve and the cherry material less the weight of the sieve. Calculate the percent of the cherry content of each pie with the following formula, and then calculate the average percent of the entire random sample:

Percent of the cherry content of the pie = $\frac{[(\text{Weight of washed and drained cherries}) - (\text{Net weight of pie})] \times 100}{\text{Net weight of pie}}$

(3) If the quality of the frozen cherry pie falls below the standard of quality prescribed by paragraph (b)(1) of this section, the label shall bear the general statement of substandard quality specified in § 130.14(a) of this chapter, in the manner and form specified therein; but in lieu of the words prescribed for the second line inside the rectangle, the label may bear the alternative statement "Below standard in quality _____", the blank being filled in with the following words, as applicable: "too few cherries", or "blemished cherries". Such alternative statement shall immediately and conspicuously precede or follow, without intervening written, printed, or graphic matter, the name of the food as prescribed by paragraph (a) of this section.

[42 FR 14449, Mar. 15, 1977, as amended at 58 FR 2882, Jan. 6, 1993]

PART 155—CANNED VEGETABLES

Subpart A—General Provisions

Sec.

155.3 Definitions.

Subpart B—Requirements for Specific Standardized Canned Vegetables

- 155.120 Canned green beans and canned wax beans.
- 155.130 Canned corn.
- 155.131 Canned field corn.
- 155.170 Canned peas.
- 155.172 Canned dry peas.
- 155.190 Canned tomatoes.
- 155.191 Tomato concentrates.
- 155.194 Catsup.
- 155.200 Certain other canned vegetables.
- 155.201 Canned mushrooms.

AUTHORITY: 21 U.S.C. 321, 341, 343, 348, 371, 379e.

SOURCE: 42 FR 14449, Mar. 15, 1977, unless otherwise noted.

Subpart A—General Provisions

§ 155.3 Definitions.

For the purposes of this part:

(a) The procedure for determining drained weight is set forth in the “Official Methods of Analysis of the Association of Official Analytical Chemists,” 13th Ed. (1980), sections 32.001–32.003, which is incorporated by reference. Copies are available from the AOAC INTERNATIONAL, 481 North Frederick Ave., suite 500, Gaithersburg, MD 20877, or available for inspection at the National Archives and Records Administration (NARA). For information on the availability of this material at NARA, call 202–741–6030, or go to: http://www.archives.gov/federal_register/code_of_federal_regulations/ibr_locations.html.

(b) *Compliance* means the following: Unless otherwise provided in a standard, a lot of canned vegetables shall be deemed in compliance for the following factors, to be determined by the sampling and acceptance procedure as provided in paragraph (c) of this section, namely:

(1) *Quality*. The quality of a lot shall be considered acceptable when the number of defectives does not exceed the acceptance number (c) in the sampling plans.

(2) *Fill of container*. A lot shall be deemed to be in compliance for fill of container (packing medium and vegetable ingredient) when the number of defectives does not exceed the acceptance number (c) in the sampling plans.

(3) *Drained weight*. A lot shall be deemed to be in compliance for drained weight based on the average value of all samples analyzed according to the sampling plans.

(c) The *sampling and acceptance procedure* means the following:

(1) *Definitions*—(i) *Lot*. A collection of primary containers or units of the same size, type, and style manufactured or packed under similar conditions and handled as a single unit of trade.

(ii) *Lot size*. The number of primary containers or units in the lot.

(iii) *Sample size*. The total number of sample units drawn for examination from a lot.

(iv) *Sample unit*. A container, a portion of the contents of a container, or a composite mixture of product from small containers that is sufficient for the examination or testing as a single unit. For fill of container, the sample unit shall be the entire contents of the container.

(v) *Defective*. Any sample unit shall be regarded as defective when the sample unit does not meet the criteria set forth in the standards.

(vi) *Acceptance number (c)*. The maximum number of defective sample units permitted in the sample in order to consider the lot as meeting the specified requirements.

(vii) *Acceptable quality level (AQL)*. The maximum percent of defective sample units permitted in a lot that will be accepted approximately 95 percent of the time.

(2) *Sampling plans*.

Lot size (primary containers)	Size of container	
	<i>n</i> ¹	<i>c</i> ²
NET WEIGHT EQUAL TO OR LESS THAN 1 KG (2.2 LB)		
4,800 or less	13	2
4,801 to 24,000	21	3
24,001 to 48,000	29	4
48,001 to 84,000	48	6
84,001 to 144,000	84	9
144,001 to 240,000	126	13
Over 240,000	200	19

§ 155.120

21 CFR Ch. I (4-1-07 Edition)

Lot size (primary containers)	Size of container	
	<i>n</i> ¹	<i>c</i> ²
NET WEIGHT GREATER THAN 1 KG (2.2 LB) BUT NOT MORE THAN 4.5 KG (10 LB)		
2,400 or less	13	2
2,401 to 15,000	21	3
15,001 to 24,000	29	4
24,001 to 42,000	48	6
42,001 to 72,000	84	9
72,001 to 120,000	126	13
Over 120,000	200	19
NET WEIGHT GREATER THAN 4.5 KG (10 LB)		
600 or less	13	2
601 to 2,000	21	3
2,001 to 7,200	29	4
7,201 to 15,000	48	6
15,001 to 24,000	84	9
24,001 to 42,000	126	13
Over 42,000	200	19

¹ *n* = number of primary containers in sample.
² *c* = acceptance number.

(d) *Strength and redness of color* means at least as much red as is obtained by comparison of the prepared product, with the blended color produced by spinning a combination of the following concentric Munsell color discs of equal diameter, or the color equivalent of such discs:

- Disc 1—Red (5R 2.6/13) (glossy finish)
- Disc 2—Yellow (2.5 YR 5/12) (glossy finish)
- Disc 3—Black (N1) (glossy finish)
- Disc 4—Grey (N4) (mat finish)

Such comparison is to be made in full diffused daylight or under a diffused light source of approximately 2691 lux (250 footcandles) and having a spectral quality approximating that of daylight under a moderately overcast sky, with a correlated color temperature of 7,500 degrees Kelvin ±200 degrees. With the light source directly over the disc and product, observation is made at an angle of 45 degrees from a distance of about 24 inches from the product. Electronic color meters may be used as an alternate means of determining the color of tomato concentrates. Such meters shall be calibrated to indicate that the color of the product is as red or more red than that produced by spinning the Munsell color discs in the combination as set out above.

(e) *Tomato soluble solids* means the sucrose value as determined by the method prescribed in the "Official Methods of Analysis of the Association of Official Analytical Chemists," 13th Ed., 1980, sections 32.014 to 32.016 and 52.012,

under the headings "Soluble Solids in Tomato Products Official Final Action" and "Refractive Indices (n) of Sucrose Solutions at 20°," which is incorporated by reference. Copies are available from the AOAC INTERNATIONAL, 481 North Frederick Ave., suite 500, Gaithersburg, MD 20877, or are available for inspection at the National Archives and Records Administration (NARA). For information on the availability of this material at NARA, call 202-741-6030, or go to: http://www.archives.gov/federal_register/code_of_federal_regulations/ibr_locations.html. If no salt has been added, the sucrose value obtained from the referenced tables shall be considered the percent of tomato soluble solids. If salt has been added either intentionally or through the application of the acidified break, determine the percent of such added sodium chloride as specified in paragraph (f) of this section. Subtract the percentage so found from the percentage of total soluble solids found (sucrose value from the refractive index tables) and multiply the difference by 1.016. The resultant value is considered the percent of "tomato soluble solids."

(f) *Salt* means sodium chloride, determined as chloride and calculated as percent sodium chloride, by the method prescribed in "Official Methods of Analysis of the Association of Official Analytical Chemists," 13th Ed., 1980, sections 32.025 to 32.030, under the heading "Method III (Potentiometric Method)," which is incorporated by reference.

[45 FR 43398, June 27, 1980, as amended at 47 FR 11831, Mar. 19, 1982; 48 FR 3954, Jan. 28, 1983; 54 FR 24895, June 12, 1989; 63 FR 14035, Mar. 24, 1998]

Subpart B—Requirements for Specific Standardized Canned Vegetables

§ 155.120 Canned green beans and canned wax beans.

(a) *Identity*—(1) *Definition*. Canned green beans and canned wax beans are the foods prepared from succulent pods of fresh green bean or wax bean plants conforming to the characteristics of *Phaseolus vulgaris* L. and *Phaseolus*

coccineus L. The optional color and varietal types and styles of the bean ingredient are set forth in paragraph (a)(2) of this section. The product is packed with water or other suitable aqueous liquid medium to which may be added one or more of the other optional ingredients set forth in paragraph (a)(3) of this section. Such food is so processed by heat, in an appropriate manner before or after being sealed in a container, as to prevent spoilage.

(2) *Optional color and varietal types and styles of pack.* The optional color and varietal types and styles of the bean ingredient referred to in paragraph (a)(1) of this section are:

(i) *Optional color types.* The beans shall be one of the following distinct color types: (a) Green; or (b) Wax.

(ii) *Optional varietal types—(a) Round.* Beans having a width not greater than 1½ times the thickness of the bean; or

(b) *Flat.* Beans having a width greater than 1½ times the thickness of the bean.

(iii) *Optional styles of pack—(a) Whole.* Whole pods of any length.

(b) *Shoestring or sliced lengthwise or French style.* Pods sliced lengthwise.

(c) *Cuts.* Transversely cut pods not less than 19 mm (0.75 in) long as measured along the longitudinal axis, which may contain the shorter end pieces that result from cutting such pods.

(d) *Short cuts.* Pieces of pods cut transversely of which 75 percent, by count, or more are less than 19 mm (0.75 in) in length and not more than 1 percent by count are more than 32 mm (1¼ in) in length.

(e) *Diagonal cuts.* Pods cut in lengths as specified in paragraph (a)(2)(iii)(c) of this section, except the pods are cut at an angle approximately 45° to the longitudinal axis.

(f) *Diagonal short cuts.* Pods cut in lengths as specified in paragraph (a)(2)(iii)(d) of this section, except the pods are cut at an angle approximately 45° to the longitudinal axis.

(g) *Mixture.* Any mixture of two or more of the styles specified in paragraph (a)(2)(iii)(a) to (f), inclusive, of this section.

(3) *Optional ingredients.* In addition to the optional packing media listed in paragraph (a)(1) of this section and the optional types and styles of beans in-

redient listed in paragraph (a)(2) of this section, the following safe and suitable optional ingredients may be used:

(i) Salt.

(ii) Monosodium glutamate.

(iii) Disodium inosinate.

(iv) Disodium guanylate.

(v) Hydrolyzed vegetable protein.

(vi) Autolyzed yeast extract.

(vii) Nutritive carbohydrate sweeteners.

(viii) Spice.

(ix) Flavoring (except artificial).

(x) Pieces of green or red peppers or mixtures of both, either of which may be dried, or other vegetables not exceeding in total 15 percent by weight of the finished product.

(xi) Vinegar.

(xii) Lemon juice or concentrated lemon juice.

(xiii) Glucono delta-lactone.

(xiv) Mint leaves.

(xv) Butter or margarine in a quantity of not less than 3 percent by weight of the finished product. When butter or margarine is added, emulsifiers or stabilizers, or both, may be added. No spice or flavoring simulating the color or flavor imparted by butter or margarine is used.

(4) *Labeling.* (i) The name of the food is "green beans" or "wax beans" as appropriate. Wax beans may be additionally designated "golden" or "yellow".

(ii) The following shall be included as part of the name or in conjunction with the name of the food:

(a) A declaration of any flavoring that characterizes the product as specified in § 101.22 of this chapter.

(b) A declaration of any spice, seasoning, or garnishing that characterizes the product, e.g., "with added spice", or, in lieu of the word "spice", the common name of the spice, e.g., "seasoned with green peppers".

(c) The words "vacuum pack" or "vacuum packed" when the weight of the liquid in the container, as determined by the method prescribed in paragraph (b)(2)(i) of this section is not more than 25 percent of the net weight, and the container is closed under conditions creating a high vacuum in the container.

(d) The name of the optional style of bean ingredient as set forth in paragraph (a)(2)(iii) of this section or, if a product consists of a mixture of such styles, the words “mixture of ” the blank to be filled in with the names of the styles present, arranged in the order of decreasing predominance, if any, by weight of such ingredients. If the product consists of whole beans and the pods are packed parallel to the sides of the container, the word “whole” may be preceded or followed by the words “vertical pack”, or if the pods are cut at both ends and are of substantially equal lengths, the words “asparagus style” may be used in lieu of the words “vertical pack”. If the product consists of short cuts or diagonal short cuts, a numerical expression indicating the predominate length of cut in the finished food may be used in lieu of the word “short”, e.g., “½ inch cut”.

(iii) The following may be included in the name of the food:

(a) The word “stringless” where the beans are in fact stringless.

(b) The name of the optional varietal type as specified in paragraph (a)(2)(ii) of this section, or the specific varietal name, e.g., “Blue Lake Green Beans”, or both.

(iv) If a term designating diameter is used, it shall be supported by an exact graphic representation of the cross section of the bean pod or by a statement of the maximum diameter in common or decimal fractions of an inch and, optionally, by the millimeter equivalent stated parenthetically. The diameter of a whole, cut, diagonal cut, or short cut is determined by measuring the thickest portion of the pod at the shorter diameter of the bean perpendicular to the longitudinal axis.

(5) *Label declaration.* Each of the ingredients used in the food shall be declared on the label as required by the applicable sections of parts 101 and 130 of this chapter.

(b) *Quality.* (1) When tested by the method prescribed in paragraph (b)(2) of this section:

(i) In the case of cut beans and diagonal cut beans under paragraphs (a)(2)(iii) (c) and (d) of this section and mixtures of two or more optional forms under paragraph (a)(2)(iii)(g) of this

section, not more than 60 units per 340 g (12 oz) drained weight are less than 13 mm (0.50 in) long: *Provided*, That where the number of units per 340 g (12 oz) drained weight exceeds 240, not more than 25 percent by count of the total units are less than 13 mm (0.50 in) long.

(ii) In case there are present pods or pieces of pods 10.7 mm (²⁷/₆₄-inch) or more in diameter, there are not more than 12 strings per 340 gm (12 ounces) of drained weight which will support 227 gm (one-half pound) for 5 seconds or longer.

(iii) The deseeded pods contain not more than 0.15 percent by weight of fibrous material.

(iv) There are not more than 10 percent by weight of blemished units of which amount not more than one-half may be materially damaged by insect or pathological injury. A unit is considered blemished when the aggregate blemished area exceeds the area of a circle 3 mm (¹/₈ in) in diameter. Materially damaged means that the unit is damaged to the extent that the appearance or eating quality of the unit is seriously affected.

(v) There are not more than 8 unstemmed units per 340 g (12 oz) drained weight.

(vi) The combined number of leaves, detached stems, and other extraneous vegetable matter shall not average more than 3 pieces per 340 g (12 oz) drained beans.

(2) Canned beans shall be tested by the following method to determine whether they meet the requirements of paragraph (b)(1) of this section:

(i) Determine the gross weight of the container. Open and distribute the contents of the container over the meshes of a U.S. No. 8 circular sieve with openings of 2.36 mm (0.0937 in), which has been previously weighed. The diameter of the sieve is 20.3 cm (8 in) if the quantity of contents of the container is less than 1.36 kg (3 lb) and 30.5 cm (12 in) if such quantity is 1.36 kg (3 lb) or more. The bottom of the sieve is woven-wire cloth that complies with the specifications of such cloth set forth in “Official Methods of Analysis of the Association of Official Analytical Chemists,” 15th ed. (1990), vol. 2, p. xii, Table 1, “Nominal Dimensions of Standard Test Sieves (USA Standard Series),”

under the heading "Definitions of Terms and Explanatory Notes," which is incorporated by reference in accordance with 5 U.S.C. 552(a) and 1 CFR part 51. Copies may be obtained from the AOAC INTERNATIONAL, 481 North Frederick Ave., suite 500, Gaithersburg, MD 20877, or may be examined at the National Archives and Records Administration (NARA). For information on the availability of this material at NARA, call 202-741-6030, or go to: http://www.archives.gov/federal_register/code_of_federal_regulations/ibr_locations.html. Without shifting the material on the sieve, incline the sieve 17 to 20° to facilitate drainage. Two minutes after drainage begins, weigh the sieve and the drained material. Record in grams (ounces) the weight so found, less the weight of the sieve, as the drained weight. Dry and weigh the empty container and subtract this weight from the gross weight to obtain the net weight. Calculate the percent of drained liquid in the net weight.

(ii) Pour the drained material from the sieve into a flat tray and spread it in a layer of fairly uniform thickness. Count the total number of units. For the purpose of this count, loose seeds, pieces of seed, loose stems, and extraneous material are not to be included. Divide the number of units by the drained weight recorded in paragraph (b)(2)(i) of this section and multiply by 340 to obtain the number of units per 340 g (12 oz) drained weight.

(iii) Examine the drained material in the tray, weigh and record weight of blemished units, count and record the number of unstemmed units; and, in case the material consists of the optional ingredient specified in paragraph (a)(2)(iii) (c), (d) or (f) of this section, count and record the number of units which are less than 13 mm (0.50 in.) long. If the number of units per 340 g (12 oz.) is 240 or less, divide the number of units which are less than 13 mm (0.50 in.) by the drained weight recorded in paragraph (b)(2)(i) of this section and multiply by 340 to obtain the number of such units per 340 g (12 oz.) drained weight. If the number of units per 340 g (12 oz.) exceeds 240, divide the number of units less than 13 mm (0.50 in.) long by the total number of units and multiply by 100 to determine the

percentage by count of the total units which are less than 13 mm (0.50 in.) long.

(a) Divide the weight of blemished units by the drained weight recorded in paragraph (b)(2)(i) of this section and multiply by 100 to obtain the percentage by weight of blemished units in the container.

(b) Divide the number of unstemmed units by the drained weight recorded in paragraph (b)(2)(i) of this section and multiply by 340 to obtain the number of unstemmed units per 340 g (12 oz.) of drained weight.

(iv) Remove from the tray the extraneous vegetable material, count, record count, and return to tray.

(v) Remove from the tray one or more representative samples of 99 to 113 g (3½ to 4 ounces) covering each sample as taken to prevent evaporation.

(vi) From each representative sample selected in paragraph (b)(2)(v) of this section, discard any loose seed and extraneous vegetable material and detach and discard any attached stems. Except with optional style of ingredient specified in paragraph (a)(2)(iii)(b) of this section (pods sliced lengthwise), trim off, as far as the end of the space formerly occupied by the seed, any portion of pods from which the seed has become separated. Remove and discard any portions of seed from the trimmings and reserve the trimmings for paragraph (b)(2)(viii) of this section. Weigh and record the weight of the trimmed pods. Deseed the trimmed pods and reserve the deseeded pods for paragraph (b)(2)(viii) of this section. Remove strings from the pods during the deseeding operation. Reserve these strings for testing as prescribed in paragraph (b)(2)(vii) of this section. In the case of pods sliced lengthwise, remove seed and pieces of seed and reserve the deseeded pods for use as prescribed in paragraph (b)(2)(viii) of this section.

(vii) If strings have been removed for testing, as prescribed in paragraph (b)(2)(vi) of this section, test them as follows:

Fasten clamp, weighted to 250 g (8.8 oz.), to one end of the string, grasp the other end with the fingers (a cloth may be used to aid in holding the string), and lift gently. Count

the string as tough if it supports the 250 g (8.8 oz.) weight for at least 5 seconds. If the string breaks before 5 seconds, test such parts into which it breaks as are 13 mm (½ in.) or more in length; and if any such part of the string supports the 250 g (8.8 oz.) weight for at least 5 seconds, count the string as tough. Divide the number of tough strings by the weight of the sample recorded in paragraph (b)(2)(v) of this section and multiply by 340 to obtain the number of tough strings per 340 g (12 oz.) drained weight.

(viii) Combine the deseeded pods with the trimmings reserved in paragraph (b)(2)(vi) of this section, and, if strings were tested as prescribed in paragraph (b)(2)(vii) of this section, add such strings broken or unbroken. Weigh and record weight of combined material. Transfer to the metal cup of a malted-milk stirrer and mash with a pestle. Wash material adhering to the pestle back into cup with 200 cc of boiling water. Bring mixture nearly to a boil, add 25 cc of 50 percent (by weight) sodium hydroxide solution and bring to a boil. (If foaming is excessive, 1 cc of capryl alcohol may be added.) Boil for 5 minutes, then stir for 5 minutes with a malted-milk stirrer capable of a no-load speed of at least 7,200 rpm. Use a rotor with two scalloped buttons shaped as shown in exhibit 1 as follows:

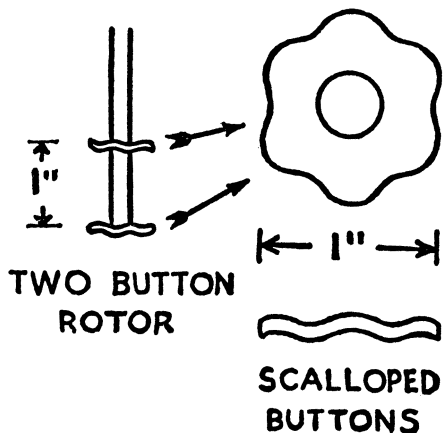

Transfer the material from the cup to a previously weighed 30-mesh monel metal screen having a diameter of about 9-10 cm (3½ to 4 in.) and side walls about 2.5 cm (1 in.) high, and wash fiber on the screen with a stream of water using a pressure not exceeding

a head (vertical distance between upper level of water and outlet of glass tube) of 152 cm (60 in.), delivered through a glass tube 7.6 cm (3 in.) long and 3 mm (¼ in.) inside diameter inserted into a rubber tube of 6 mm (¼ in.) inside diameter. Wash the pulpy portion of the material through the screen and continue washing until the remaining fibrous material, moistened with phenolphthalein solution, does not show any red color after standing 5 minutes. Again wash to remove phenolphthalein. Dry the screen containing the fibrous material for 2 hours at 100 °C, cool, weigh, and deduct weight of screen. Divide the weight of fibrous material by the weight of combined deseeded pods, trimmings, and strings and multiply by 100 to obtain the percentage of fibrous material.

(ix) If the drained weight recorded in paragraph (b)(2)(i) of this section was less than 340 g (12 oz.), open and examine separately for extraneous material, as directed in paragraph (b)(2)(iv) of this section, additional containers until a total of not less than 340 g (12 oz.) of drained material is obtained. To determine the number of pieces of extraneous vegetable material per 340 g (12 oz.) of drained weight, total the number of pieces of extraneous vegetable material found in all containers opened, divide this sum by the sum of the drained weights in these containers and multiply by 340.

(3) Determine compliance as specified in §155.3(b) except that a lot shall be deemed to be in compliance for extraneous plant material based on an average of all containers examined.

(4) If the quality of the canned green beans or canned wax beans falls below the standard of quality prescribed by paragraph (b)(1) of this section, the label shall bear the general statement of substandard quality specified in §130.14(a) of this chapter, in the manner and form therein specified; but in lieu of the words prescribed for the second line inside the rectangle the following words may be used, when the quality of canned green beans or canned wax beans falls below the standard in one only of the following respects:

(i) "Excessive number very short pieces", if the canned green beans or

canned wax beans fail to meet the requirements of paragraph (b)(1)(i) of this section.

(ii) "Excessive number blemished units", if they fail to meet the requirements of paragraph (b)(1)(iv) of this section.

(iii) "Excessive number unstemmed units", if they fail to meet the requirements of paragraph (b)(1)(v) of this section.

(iv) "Excessive foreign material", if they fail to meet the requirements of paragraph (b)(1)(vi) of this section.

[42 FR 14449, Mar. 15, 1977, as amended at 42 FR 30359, 30360, June 14, 1977; 45 FR 43398, June 27, 1980; 47 FR 11831, Mar. 19, 1982; 49 FR 10101, Mar. 19, 1984; 57 FR 34245, Aug. 4, 1992; 58 FR 2882, Jan. 6, 1993; 63 FR 14035, Mar. 24, 1998]

§ 155.130 Canned corn.

(a) *Identity*—(1) *Definition*. Canned sweet corn is the product prepared from clean, sound kernels of sweet corn packed with a suitable liquid packing medium which may include water and the creamy component from corn kernels. The tip caps are removed. The product is of the optional styles specified in paragraph (a)(2) of this section. It may contain one, or any combination of two or more, of the optional ingredients set forth in paragraph (a)(3) of this section. Such food is processed by heat, in an appropriate manner, before or after being sealed in a container, so as to prevent spoilage.

(2) *Styles*. The optional styles referred to in paragraph (a)(1) of this section consist of succulent sweet corn of the yellow (golden) or white color type, conforming to *Zea mays* L. having the sweet corn characteristic as follows:

(i) Whole kernel or whole grain or cut kernel consisting of whole or substantially whole cut kernels packed with a liquid medium.

(ii) Cream style consisting of whole or partially whole cut kernels packed in a creamy component from the corn kernels and other liquid or other ingredients to form a product of creamy consistency.

(3) *Optional ingredients*. The following safe and suitable optional ingredients may be used:

- (i) Salt.
- (ii) Monosodium glutamate.

- (iii) Disodium inosinate.
- (iv) Disodium guanylate.
- (v) Hydrolyzed vegetable protein.
- (vi) Autolyzed yeast extract.
- (vii) Nutritive carbohydrate sweeteners.
- (viii) Spice.
- (ix) Flavoring (except artificial).
- (x) Citric acid.
- (xi) Starch or food starch-modified in cream style corn when necessary to ensure smoothness.

(xii) Seasonings and garnishes.

- (a) Mint leaves.
- (b) Pieces of green peppers or red peppers, or mixtures of both, either of which may be sweet or hot and may be dried, or other vegetables, not exceeding 15 percent by weight of the finished food.

(c) Lemon juice or concentrated lemon juice.

(d) Butter or margarine in a quantity not less than 3 percent by weight of the finished food. When butter or margarine is added, emulsifiers or stabilizers, or both, may be added. When butter or margarine is added, no spice, or flavoring simulating the color or flavor imparted by butter or margarine is used.

(4) *Labeling*. The name of the food is "corn" or "sweet corn" or "sugar corn" and shall include a declaration of any flavoring that characterizes the product as specified in §101.22 of this chapter and a declaration of any spice, seasoning or garnishing that characterizes the product; for example, "With added spice", "Seasoned with red peppers", "Seasoned with butter". The name of the food shall also include the following:

(i) The optional style of the corn ingredient as specified in paragraph (a)(2) of this section.

(ii) The words "vacuum pack" or "vacuum packed" when the corn ingredient is as specified in paragraph (a)(2)(i) of this section and the weight of the liquid in the container, as determined by the method prescribed in paragraph (b)(2)(i) of this section, is not more than 20 percent of the net weight, and the container is closed under conditions creating a high vacuum in the container.

(iii) The color type used only when the product consists of white corn.

(iv) The color type used only when the product consists of white corn.

(5) *Label declaration.* Each of the ingredients used in the food shall be declared on the label as required by the applicable sections of parts 101 and 130 of this chapter.

(b) *Quality.* (1) The standard of quality for canned corn is as follows:

(i) When tested by the method prescribed in paragraph (b)(2) of this section, canned whole-kernel corn (paragraph (a)(2)(i) of this section):

(a) Contains not more than seven brown or black discolored kernels or pieces of kernel per 400 g. (14 ounces) of drained weight;

(b) Contains not more than 1 cubic centimeter of pieces of cob for each 400 g. (14 ounces) of drained weight;

(c) Contains not more than 7 square centimeters (1.1 square inch) of husk per 400 g. (14 ounces) of drained weight; and

(d) Contains not more than 180 mm. (7 inches) of silk per 28 g. (1 ounce) of drained weight.

(ii) When tested by the method prescribed in paragraph (b)(3) of this section, canned cream style corn (paragraph (a)(2)(ii) of this section):

(a) Contains not more than 10 brown or black discolored kernels or pieces of kernel per 600 g. (21.4 ounces) of net weight;

(b) Contains not more than 1 cubic centimeter of pieces of cob per 600 g. (21.4 ounces) of net weight;

(c) Contains not more than 7 square centimeters (1.1 square inch) of husk per 600 g. (21.4 ounces) of net weight;

(d) Contains not more than 150 mm. (6 inches) of silk for each 28 g. (1 ounce) of net weight; and

(e) Has a consistency such that the average diameter of the approximately circular area over which the prescribed sample spreads does not exceed 30.5 cm. (12 inches), except that when the washed drained material contains more than 20 percent of alcohol-insoluble solids, the average diameter of the approximately circular area over which the prescribed sample spreads does not exceed 25.4 cm. (10 inches).

(iii)(a) The weight of the alcohol-insoluble solids of whole-kernel corn (paragraph (a)(2)(i) of this section) does not exceed 27 percent of the drained

weight, when tested by the method prescribed in paragraph (b)(2) of this section.

(b) The weight of the alcohol-insoluble solids of the washed drained material of cream style corn (paragraph (a)(2)(ii) of this section) does not exceed 27 percent of the drained weight of such material, when tested by the method prescribed in paragraph (b)(3) of this section.

(2) The method referred to in paragraph (b)(1) of this section for testing whole-kernel corn (paragraph (a)(2)(i) of this section) is as follows:

(i) Determine the gross weight of the container. Open and distribute the contents of the container over the meshes of a U.S. No. 8 circular sieve which has previously been weighed. The diameter of the sieve is 20.3 cm. (8 inches) if the quantity of the contents of the container is less than 1.36 kg. (3 pounds), and 30.5 cm. (12 inches) if such quantity is 1.36 kg. (3 pounds) or more. The bottom of the sieve is woven-wire cloth that complies with the specifications for such sieve set forth in the "Definitions of Terms and Explanatory Notes" prescribed in "Official Methods of Analysis of the Association of Official Analytical Chemists," 13th Ed. (1980), Table 1, "Nominal Dimensions of Standard Test Sieves (U.S.A. Standard Series)," under the heading "Definitions of Terms and Explanatory Notes," which is incorporated by reference. Copies may be obtained from the AOAC INTERNATIONAL, 481 North Frederick Ave., suite 500, Gaithersburg, MD 20877, or may be examined at the National Archives and Records Administration (NARA). For information on the availability of this material at NARA, call 202-741-6030, or go to: http://www.archives.gov/federal_register/code_of_federal_regulations/ibr_locations.html. Without shifting the material on the sieve, so incline the sieve at approximately 17-20° angle to facilitate drainage. Two minutes from the time drainage begins, weigh the sieve and the drained material. Record, in g. (ounces), the weight so found, less the weight of the sieve, as the drained weight. Dry and weigh the empty container and subtract this weight from the gross weight to obtain the net

weight. Calculate the percent of drained liquid in the net weight.

(ii) Pour the drained material from the sieve into a flat tray and spread it in a layer of fairly uniform thickness. Count, but do not remove, the brown or black discolored kernels or pieces of kernel and calculate the number per 400 g. (14 ounces) of drained material. Remove pieces of silk more than 12.7 mm. (one-half inch) long, husk, cob, and any pieces of material other than corn. Measure the aggregate length of such pieces of silk and calculate the length of silk per 28 g. (1 ounce) of drained weight. Spread the husk flat, measure its aggregate area, and calculate the area of husk per 400 g. (14 ounces) of drained weight. Place all pieces of cob under a measured amount of water in a cylinder which is so graduated that the volume can be measured to 0.1 cubic centimeter. Take the increase in volume as the aggregate volume of the cob and calculate the volume of cob per 400 g. (14 ounces) of drained weight.

(iii) Comminute representative 100 g. sample of the drained corn from which the silk, husk, cob, and other material which is not corn (i.e., peppers) have been removed. An equal amount of water is used to facilitate this operation. Weigh to nearest 0.01 g. a portion of the comminuted material equivalent to approximately 10 g. of the drained corn into a 600 cubic centimeter beaker. Add 300 cubic centimeters of 80 percent alcohol (by volume), stir, cover beaker, and bring to a boil. Simmer slowly for 30 minutes. Fit a Buchner funnel with a previously prepared filter paper of such sizes that its edges extend 12.7 mm. (one-half inch) or more up the vertical sides of the funnel. The previous preparation of the filter paper consists of drying it in a flat-bottomed dish for 2 hours at 100 °C, covering the dish with a tight fitting cover, cooling it in a desiccator, and promptly weighing to the nearest 0.001 g. After the filter paper is fitted to the funnel, apply suction and transfer the contents of the beaker to the funnel. Do not allow any of the material to run over the edge of the paper. Wash the material on the filter with 80 percent alcohol (by volume) until the washings are clear and colorless. Transfer the fil-

ter paper with the material retained thereon to the dish used in preparing the filter paper. Dry the material in a ventilated oven, without covering the dish, for 2 hours at 100 °C. Place the cover on the dish, cool it in a desiccator, and promptly weigh to the nearest 0.001 g. From this weight subtract the weight of the dish, cover, and paper as previously found. Calculate the remainder to percentage.

(3) The method referred to in paragraph (b)(1) of this section for testing cream-style corn (paragraph (a)(2)(ii) of this section) is as follows:

(i) Allow the container to stand at least 24 hours at a temperature of 68 °F to 85 °F. Determine the gross weight, open, transfer the contents into a pan, and mix thoroughly in such a manner as not to incorporate air bubbles. (If the net contents of a single container is less than 510 g. (18 ounces) determine the gross weight, open, and mix the contents of the least number of containers necessary to obtain 510 g. (18 ounces). Fill level full a hollow, truncated cone so placed on a polished horizontal plate as to prevent leakage. The cone has an inside bottom diameter of 7.62 cm. (3 inches), inside top diameter of 5.08 cm. (2 inches), and height of 12.30 cm. ($4\frac{27}{32}$ inches). As soon as the cone is filled, lift it vertically. Determine the average of the longest and shortest diameters of the approximately circular area on the plate covered by the sample 30 seconds after lifting the cone. Dry and weigh each empty container and subtract the weight so found from the gross weight to obtain the net weight.

(ii) Transfer the material from the plate, cone, and pan onto a U.S. No. 8 sieve as prescribed in paragraph (b)(2)(i) of this section. The diameter of the sieve is 20.3 cm. (8 inches) if the quantity of the contents of the container is less than 1.36 kg. (3 pounds), and 30.5 cm. (12 inches) if such quantity is 1.36 kg. (3 pounds) or more. Set the sieve in a pan. Add enough water to bring the level within 9.53 mm. (three-eighth inch) to 6.35 mm. (one-fourth inch) of the top of the sieve. Gently wash the material on the sieve by combined up-and-down and circular motion for 30 seconds. Repeat washing with a second portion of water. Remove sieve

§ 155.131

21 CFR Ch. I (4-1-07 Edition)

from pan, incline to facilitate drainage, and drain for 2 minutes.

(iii) From the material remaining on the U.S. No. 8 sieve, count, but do not remove, the brown or black discolored kernels or pieces of kernel and calculate the number per 600 g. (21.4 ounces) of net weight. Remove pieces of silk more than 12.7 mm. (one-half inch) long, husk, cob, and other material which is not corn (i.e., peppers). Measure aggregate length of such pieces of silk and calculate the length per 28 g. (ounce) of net weight. Spread the husk flat and measure its aggregate area and calculate the area per 600 g. (21.4 ounces) of net weight. Place all pieces of cob under a measured amount of water in a cylinder which is so graduated that the volume may be measured to 0.1 cubic centimeter. Take the increase in volume as the aggregate volume of the cob and calculate the volume of cob per 600 g. (21.4 ounces) of net weight. Take a representative 100 g. sample of the material remaining on the U.S. No. 8 sieve (if such material weighs less than 100 g. take all of it) and determine the alcohol-insoluble solids as prescribed in paragraph (b)(2)(iii) of this section for whole kernel corn.

(4) Determine compliance as specified in §155.3(b).

(5) If the quality of canned corn falls below the standard prescribed in paragraph (b)(1) of this section, the label shall bear the general statement of substandard quality specified in §130.14(a) of this chapter, in the manner and form therein specified; however, if the quality of the canned corn falls below standard with respect to only one of the factors of quality specified by paragraphs (b)(1)(i) (a) to (d) of this section, or by paragraphs (b)(1)(ii) (a) to (e) of this section, there may be substituted for the second line of such general statement of substandard quality, "Good food—not high grade", a new line as specified after the corresponding subdivision designation of paragraph (b)(1) of this section, which the canned corn fails to meet:

- (i)(a) or (ii)(a) "Excessive discolored kernels".
- (i)(b) or (ii)(b) "Excessive cob".
- (i)(c) or (ii)(c) "Excessive husk".
- (i)(d) or (ii)(d) "Excessive silk".

(ii)(e) "Excessively liquid".

(c) *Fill of container.* (1) The standard of fill of container for canned corn is:

(i) Except in the case of vacuum pack corn the fill of the corn ingredient and packing medium, as determined by the general method for fill of container prescribed in §130.12(b) of this chapter, is not less than 90 percent of the total capacity of the container.

(ii) In whole kernel corn, the drained weight of the corn ingredient, determined by the procedure set forth in §155.3, shall not be less than 61 percent of the water capacity of the container.

(2) Determine compliance as specified in §155.3(b).

(3) If canned corn falls below the standard of fill of container prescribed in paragraphs (c)(1) and (2) of this section, the label shall bear the general statement of substandard fill specified in §130.14(b) of this chapter, in the manner and form therein specified.

[42 FR 14449, Mar. 15, 1977, as amended at 45 FR 43398, June 27, 1980; 47 FR 11831, 11832, Mar. 19, 1982; 49 FR 10101, Mar. 19, 1984; 54 FR 24895, June 12, 1989; 58 FR 2882, Jan. 6, 1993; 63 FR 14035, Mar. 24, 1998]

§ 155.131 Canned field corn.

(a) *Identity.* (1) Canned field corn conforms to the definition and standard of identity, and is subject to the requirements for label declaration of ingredients, prescribed for canned corn by §155.130(a), except that the corn ingredient consists of succulent field corn or a mixture of succulent field corn and succulent sweet corn.

(2) The name of the food conforms to the name specified in §155.130(a)(5), except that the words "Corn", "Sweet corn", and "Sugar corn" are replaced by the words "Field corn", and the term "Golden field corn" is not used.

(b) [Reserved]

(c) *Fill of container.* Canned cream-style field corn conforms to the standard of fill of container and label statement of substandard fill prescribed for canned cream-style corn by §155.130(c).

[42 FR 14449, Mar. 15, 1977, as amended at 58 FR 2882, Jan. 6, 1993]

§ 155.170 Canned peas.

(a) *Identity—(1) Definition.* Canned peas is the food prepared from fresh or

frozen succulent seeds of the pea plant of the species *Pisum sativum* L. but excluding the subspecies *macrocarpum*. Only sweet wrinkled varieties, smooth-skin varieties, or hybrids thereof may be used. The product is packed with water or other suitable aqueous liquid medium to which may be added one or more of the other optional ingredients set forth in paragraph (a)(2) of this section. Such food is sealed in a container and, before or after sealing, is so processed by heat as to prevent spoilage.

(2) *Optional ingredients.* In addition to the optional packing media provided for in paragraph (a)(1) of this section, the following safe and suitable optional ingredients may be used:

- (i) Salt.
- (ii) Monosodium glutamate.
- (iii) Disodium inosinate.
- (iv) Disodium guanylate.
- (v) Hydrolyzed vegetable protein.
- (vi) Autolyzed yeast extract.
- (vii) One or any combination of two or more of the dry or liquid forms of sugar, invert sugar sirup, dextrose, glucose sirup, and fructose.
- (viii) Spice.
- (ix) Flavoring (except artificial).
- (x) Color additives.
- (xi) Calcium salts, the total amount of which added to firm the peas shall not result in more than 350 milligrams/kilogram (0.01 ounce/2.2 pounds) of calcium in the finished food.
- (xii) Magnesium hydroxide, magnesium oxide, magnesium carbonate, or any mixture or combination of these in such quantity that the pH of the finished canned peas is not more than 8, as determined by the glass electrode method for the hydrogen ion concentration.
- (xiii) Seasonings and garnishes:
 - (a) Pieces of green or red peppers or mixtures of both, either of which may be dried, or other vegetables not exceeding in total 15 percent of the drained weight of the finished food.
 - (b) Lemon juice or concentrated lemon juice.
 - (c) Mint leaves.
 - (d) Butter or margarine in a quantity not less than 3 percent by weight of the finished food, or other vegetable or animal fats or oils in a quantity not less than 2.4 percent by weight of the finished foods. When butter, margarine, or

other vegetable or animal fats or oils are added, emulsifiers or stabilizers or both may be added, but no color, spice, or flavoring simulating the color or flavor imparted by butter or margarine may be used.

(3) *Labeling.* (i) The name of the food is "peas" and may include the designation "green." The term "early," "June," or "early June" shall precede or follow the name in the case of smooth-skin peas or substantially smooth-skin peas, such as Alaska-type peas or hybrids having similar characteristics. Where the peas are of sweet green wrinkled varieties or hybrids having similar characteristics, the name may include the designation "sweet," "wrinkled," or any combination thereof. The term "petit pois" may be used in conjunction with the name of the food when an average of 80 percent or more of the peas will pass through a circular opening of a diameter of 7.1 millimeters (0.28 inch). If any color additive has been added, the name of the food shall include the term "artificially colored."

(ii) The following shall be included as part of the name or in close proximity to the name of the food:

(a) A declaration of any flavoring that characterizes the food, as specified in §101.22 of this chapter.

(b) A declaration of any spice, seasoning, or garnishing that characterizes the product, e.g., "seasoned with green peppers", "seasoned with butter", "seasoned with _____ oil", the blank to be filled in with the common or usual name of the oil, "with added spice", or, in lieu of the word spice, the common or usual name of the spice.

(c) The words "vacuum pack" or "vacuum packed" when the weight of the liquid in the container, as determined by the method prescribed in §155.3(a) is not more than 20 percent of the net weight, and the container is closed under conditions creating a high vacuum in the container.

(4) *Label declaration.* Each of the ingredients used in the food shall be declared on the label as required by the applicable sections of parts 101 and 130 of this chapter.

(b) *Quality.* (1) The standard of quality for canned peas is as follows:

(i) *Blond and yellow peas.* Not more than 2 percent of the drained weight is blond and/or yellow peas, i.e., white or yellow but edible peas.

(ii) *Blemished peas.* Not more than 5 percent of the drained weight is blemished peas, i.e., slightly stained or spotted peas.

(iii) *Seriously blemished peas.* Not more than 1 percent of the drained weight is seriously blemished peas, i.e., peas that are hard, shrivelled, spotted, discolored, or otherwise blemished to an extent that the appearance or eating quality is seriously affected.

(iv) *Pea fragments.* Not more than 10 percent of the drained weight is pea fragments, i.e., portions of peas, separated or individual cotyledons, crushed, partial or broken cotyledons, and loose skins, but excluding entire intact peas with skins detached.

(v) *Extraneous vegetable material.* Not more than 0.5 percent of the drained weight is extraneous vegetable material, i.e., vine or leaf or pod material from the pea plant or other such material.

(vi) *Alcohol-insoluble solids.* The alcohol-insoluble solids of smooth-skin or substantially smooth-skin peas, such as Alaska-type peas or hybrids having similar characteristics, may not be more than 23.5 percent and, of sweet green wrinkled varieties or hybrids having similar characteristics, not more than 21 percent based on the procedure set forth in the “Official Methods of Analysis of the Association of Official Analytical Chemists,” 13th Ed. (1980), section 30.012, which is incorporated by reference. Copies are available from the AOAC INTERNATIONAL, 481 North Frederick Ave., suite 500, Gaithersburg, MD 20877, or available for inspection at the National Archives and Records Administration (NARA). For information on the availability of this material at NARA, call 202-741-6030, or go to: http://www.archives.gov/federal_register/code_of_federal_regulations/ibr_locations.html.

(vii) *Limitation.* The sum of the pea material described in paragraphs (b)(1) (i), (ii), (iii), (iv), and (v) of this section shall not exceed 12 percent.

(2) Determine compliance as specified in § 155.3(b).

(3) If the quality of canned peas falls below the standard prescribed in paragraph (b)(1) of this section, the label shall bear the general statement of substandard quality specified in § 130.14(a) of this chapter, in the manner and form therein specified; but in lieu of such general statement of substandard quality when the quality of canned peas falls below the standard in only one respect, the label may bear the alternative statement, “Below standard in quality _____”, the blank to be filled in with the words specified after the corresponding paragraph under paragraph (b)(1) of this section which such canned peas fail to meet, as follows: (i) “Excessive blond and/or yellow peas”; (ii) “Excessive blemished peas”; (iii) “Excessive seriously blemished peas”; (iv) “Excessive pea fragments”; (v) “Excessive vegetable material”; (vi) “Excessive mealy”. Such alternative statement shall immediately and conspicuously precede or follow without intervening written, printed, or graphic matter, the name “peas” and any words and statements required or authorized to appear with such name by paragraph (a)(3) of this section.

(c) *Fill of container.* (1) Except in the case of vacuum pack peas, the fill of pea ingredient and packing medium, as determined by the general method for fill of container prescribed in § 130.12(b) of this chapter, is not less than 90 percent of the total capacity of the container.

(2) When the peas and liquid are removed from the container and returned thereto, the leveled peas (irrespective of the quantity of the liquid), 15 seconds after they are so returned, completely fill the container. A container with lid attached by double seam shall be considered to be completely filled when it is filled to 5 millimeters (0.2 inch) vertical distance below the top of the double seam; and a glass container shall be considered to be completely filled when it is filled to 13 millimeters (0.5 inch) vertical distance below the top of the container.

(3) Determine compliance for fill of container as specified in § 155.3(b).

(4) If canned peas fall below the standard of fill of container prescribed in paragraph (c)(1) and/or (2) of this

section, the label shall bear the general statement of substandard fill specified in §130.14(b) of this chapter, in the manner and form therein specified.

[45 FR 43398, June 27, 1980, as amended at 47 FR 11832, Mar. 19, 1982; 48 FR 15241, Apr. 8, 1983; 54 FR 24895, June 12, 1989; 58 FR 2882, Jan. 6, 1993; 63 FR 14035, Mar. 24, 1998]

EFFECTIVE DATE NOTE: In §155.170, those portions of paragraph (a)(2) pertaining to the deletion of magnesium, hydroxide, magnesium oxide, and magnesium carbonate were stayed until further notice at 46 FR 35086, July 1, 1981, effective June 30, 1981.

§ 155.172 Canned dry peas.

(a) *Identity.* Canned dry peas conforms to the definition and standard of identity, and is subject to the requirements for label declaration of ingredients, prescribed for canned peas by §155.170(a), except that:

(1) The optional pea ingredient is the dry seeds of the pea plant of the species *Pisum sativum* L. but excluding the subspecies *macrocarpum*.

(2) The optional ingredients specified in §155.170(a)(2)(xii) shall not be used.

(3) The name of the food is "cooked dry peas" or "soaked dry peas". The optional terms specified by §155.170(a)(3), "early", "June", "sweet", "green", "wrinkled", or any combination thereof, shall not be used on the labels.

(b) *Quality.* (1) The standard of quality for canned dry peas is that specified for canned peas by §155.170(b) except that:

(i) The alcohol-insoluble solids maximums specified in §155.170(b)(1)(vi) do not apply.

(ii) The skins of not more than 25 percent by count of the peas in the container are ruptured to a width of 1.6 millimeters (0.06 inch) or more.

(2) If the quality of canned dry peas falls below the standard of quality prescribed by paragraph (b)(1) of this section, the label shall bear the statement of substandard quality in the manner and form specified in §155.170(b)(3) for canned peas, except that the words "Excessively mealy" shall not be used.

(c) *Fill of container.* (1) The standard of fill of container for canned dry peas is that prescribed for canned peas by §155.170(c).

(2) If canned dry peas fall below the standard of fill of container prescribed by paragraph (c)(1) of this section, the label shall bear the general statement of substandard fill specified in §130.14(b) of this chapter, in the manner and form therein specified.

[45 FR 43399, June 27, 1980, as amended at 48 FR 15241, Apr. 8, 1983; 58 FR 2883, Jan. 6, 1993]

§ 155.190 Canned tomatoes.

(a) *Identity*—(1) *Description.* (i) Canned tomatoes is the food prepared from mature tomatoes conforming to the characteristics of the fruit *Lycopersicon esculentum* P. Mill, of red or reddish varieties. The tomatoes may or may not be peeled, but shall have had the stems and calices removed and shall have been cored, except where the internal core is insignificant to texture and appearance.

(ii) Canned tomatoes may contain one or more of the safe and suitable optional ingredients specified in paragraph (a)(2) of this section, be packed without any added liquid or in one of the optional packing media specified in paragraph (a)(3) of this section and be prepared in one of the styles specified in paragraph (a)(4) of this section. Such food is sealed in a container and before or after sealing is so processed by heat as to prevent spoilage.

(2) *Optional ingredients.* One or more of the following safe and suitable ingredients may be used:

(i) Calcium salts in a quantity reasonably necessary to firm the tomatoes, but the amount of calcium in the finished canned tomatoes is not more than 0.045 percent of the weight, except that when the tomatoes are prepared in one of the styles specified in paragraphs (a)(4) (ii) to (iv) of this section the amount of calcium is not more than 0.08 percent of the weight of the food.

(ii) Organic acids for the purpose of acidification.

(iii) Dry nutritive carbohydrate sweeteners whenever any organic acid provided for in paragraph (a)(2)(ii) of this section is used, in a quantity reasonably necessary to compensate for the tartness resulting from such added acid.

(iv) Salt.

(v) Spices, spice oils.

(vi) Flavoring and seasoning.
 (vii) Vegetable ingredients such as onion, peppers, and celery, that may be fresh or preserved by physical means, in a quantity not more than 10 percent by weight of the finished food.

(3) *Packing media.* (i) The liquid draining from the tomatoes during or after peeling or coring.

(ii) The liquid strained from the residue from preparing tomatoes for canning consisting of peels and cores with or without tomatoes or pieces thereof.

(iii) The liquid strained from mature tomatoes (tomato juice).

(iv) Tomato paste, or tomato puree, or tomato pulp complying with the compositional requirements of § 155.191.

(4) *Styles.* (i) Whole.

(ii) Diced.

(iii) Sliced.

(iv) Wedges.

(5) *Name of the food.* (i) The name of the food is "tomatoes", except that when the tomatoes are not peeled the name is "unpeeled tomatoes".

(ii) The following shall be included as part of the name or in close proximity to the name of the food:

(a) A declaration of any flavoring that characterizes the product as specified in § 101.22 of this chapter.

(b) A declaration of any added spice, seasoning, or vegetable ingredient that characterizes the product, (e.g., "with added _____" or, "with _____" the blank to be filled in with the word(s) "spice(s)", "seasoning(s)", or the name(s) of the vegetable(s) used or in lieu of the word(s) "spice(s)" or "seasoning (s)" the common or usual name(s) of the spice(s) or seasoning(s) used) except that no declaration of the presence of onion, peppers, and celery is required for stewed tomatoes.

(c) The word "stewed" if the tomatoes contain characterizing amounts of at least the three optional vegetables listed in paragraph (a)(2)(vii) of this section.

(d) The styles: "Diced", "sliced", or "wedges" as appropriate.

(e) The name of the packing medium: "tomato paste", "tomato puree", or "tomato pulp" as provided in paragraph (a)(3)(iv) of this section, or "strained residual tomato material from preparation for canning" as provided for in paragraph (a)(3)(ii) of this

section, as appropriate. The name of the packing medium shall be preceded by the word "with".

(iii) The following may be included as part of the name or in close proximity to the name:

(a) The word "whole" if the tomato ingredient is whole or almost whole, and the weight of such ingredient is not less than 80 percent of the drained weight of the finished food as determined in accordance with the method prescribed in paragraph (b)(2) of this section.

(b) The words "solid pack" when none of the optional packing media specified in paragraph (a)(3) of this section are used.

(c) The words "in tomato juice" if the packing medium specified in paragraph (a)(3)(iii) of this section is used.

(6) *Label declaration.* The name of each ingredient used shall be declared on the label as required by the applicable sections of parts 101 and 130 of this chapter.

(b) *Quality.* (1) The standard of quality for canned tomatoes is as follows:

(i) The drained weight, as determined by the method prescribed in paragraph (b)(2)(i) of this section, is not less than 50 percent of the weight of water required to fill the container, as determined by the general method for water capacity of containers prescribed in § 130.12(a) of this chapter;

(ii) The strength and redness of color as determined by the method prescribed in paragraph (b)(2) of this section, are not less than that of the blended color of any combination of the color discs described in such method in which one-third the area of disc 1, and not more than one-third the area of disc 2, is exposed;

(iii) Peel per kilogram (2.2 pounds) of the finished food covers an area of not more than 15 cm² (2.3 square inches) which is equivalent to 6.8 cm² (1.06 square inches) per pound based on an average of all containers examined provided, however, that the area of peel is not a factor of quality for canned unpeeled tomatoes labeled in accordance with paragraph (a)(5)(i) of this section; and

(iv) Blemishes per kilogram (2.2 pounds) of the finished food cover an area of not more than 3.5 cm² (0.54

square inch) which is equivalent to 1.6 cm² (0.25 square inch) per pound based on an average of all containers examined.

(2) Canned tomatoes shall be tested by the following method to determine whether or not they meet the requirements of paragraphs (b)(1) (i) and (ii) of this section:

(i) Remove lid from container, but in the case of a container with lid attached by double seam, do not remove or alter the height of the double seam. Tilt the opened container so as to distribute the contents over the meshes of a circular sieve which has previously been weighed. The diameter of the sieve used is 20.3 centimeters (8 inches) if the quantity of the contents of the container is less than 1.4 kilograms (3 pounds) or 30.5 centimeters (12 inches) if such quantity is 1.4 kilograms (3 pounds) or more. The meshes of such sieve are made by so weaving wire of 1.4 mm (0.054 inch) diameter as to form square openings 11.3 mm by 11.3 mm (0.446 inch by 0.446 inch). Without shifting the tomatoes, so incline the sieve as to facilitate drainage of the liquid. Two minutes from the time drainage begins, weigh the sieve and drained tomatoes. The weight so found, less the weight of the sieve, shall be considered to be the drained weight.

(ii) Remove from the sieve the drained tomatoes, cut out and segregate successively those portions of least redness until 50 percent of the drained weight has been so segregated. Comminute the segregated portions to a uniform mixture without removing or breaking the seeds. Fill the mixture into a black container to a depth of at least 25.4 mm (1 inch). Free the mixture from air bubbles, and skim off or press below the surface all visible seeds. Compare the color of the mixture, in full diffused daylight or its equivalent, with the blended color of combinations of the following concentric Munsell color discs of equal diameter, or the color equivalent of such discs:

(a) Red—Munsell 5 R 2.6/13 (glossy finish).

(b) Yellow—Munsell 2.5 YR 5/12 (glossy finish).

(c) Black—Munsell N 1/ (glossy finish).

(d) Grey—Munsell N 4 (mat finish).

(3) Determine compliance as specified in § 155.3(b).

(4) If the quality of canned tomatoes falls below the standard prescribed in paragraph (b)(1) of this section, the label shall bear the general statement of substandard quality specified in § 130.14(a) of this chapter in the manner and form therein specified; if, however, the quality of canned tomatoes falls below standard with respect to only one of the factors of quality specified by paragraphs (b)(1) (i) to (iii) of this section, there may be substituted for the second line of such general statement of substandard quality (“Good Food—Not High Grade”) a new line, appropriate for the corresponding subparagraph designation of paragraph (b)(1) of this section which the canned tomatoes fail to meet, to read as follows:

(i) “Poor color” or

(ii) “Excessive peel” or

(iii) “Excessive blemishes”.

(c) *Fill of container.* (1) The standard of fill of container for canned tomatoes is a fill of not less than 90 percent of the total capacity of the container, as determined by the general method for fill of containers prescribed in § 130.12(b) of this chapter.

(2) Determine compliance as specified in § 155.3(b).

(3) If canned tomatoes fall below the standard of fill of container prescribed in paragraph (c)(1) of this section, the label shall bear the general statement of substandard fill specified in § 130.14(b) of this chapter, in the manner and form therein specified.

[42 FR 14449, Mar. 15, 1977, as amended at 43 FR 12858, Mar. 28, 1978; 43 FR 30274, July 14, 1978; 45 FR 43400, June 27, 1980; 58 FR 17103, Apr. 1, 1993; 59 FR 15051, Mar. 31, 1994]

§ 155.191 Tomato concentrates.

(a) *Identity*—(1) *Definition.* Tomato concentrates are the class of foods each of which is prepared by concentrating one or any combination of two or more of the following optional tomato ingredients:

(i) The liquid obtained from mature tomatoes of the red or reddish varieties (*Lycopersicon esculentum* P. Mill).

(ii) The liquid obtained from the residue from preparing such tomatoes for

canning, consisting of peelings and cores with or without such tomatoes or pieces thereof.

(iii) The liquid obtained from the residue from partial extraction of juice from such tomatoes.

Such liquid is obtained by so straining the tomatoes, with or without heating, as to exclude skins (peel), seeds, and other coarse or hard substances in accordance with good manufacturing practice. Prior to straining, food-grade hydrochloric acid may be added to the tomato material in an amount to obtain a pH no lower than 2.0. Such acid is then neutralized with food-grade sodium hydroxide so that the treated tomato material is restored to a pH of 4.2 ± 0.2 . Water may be added to adjust the final composition. The food contains not less than 8.0 percent tomato soluble solids as defined in §155.3(e). The food is preserved by heat sterilization (canning), refrigeration, or freezing. When sealed in a container to be held at ambient temperatures, it is so processed by heat, before or after sealing, as to prevent spoilage.

(2) *Optional ingredients.* One or any combination of two or more of the following safe and suitable ingredients may be used in the foods:

(i) Salt (sodium chloride formed during acid neutralization shall be considered added salt).

(ii) Lemon juice, concentrated lemon juice, or organic acids.

(iii) Sodium bicarbonate.

(iv) Water, as provided for in paragraph (a)(1) of this section.

(v) Spices.

(vi) Flavoring.

(3) *Labeling.* (i) The name of the food is:

(a) "Tomato puree" or "tomato pulp" if the food contains not less than 8.0 percent but less than 24.0 percent tomato soluble solids.

(b) "Tomato paste" if the food contains not less than 24.0 percent tomato soluble solids.

(c) The name "tomato concentrate" may be used in lieu of the name "tomato puree," "tomato pulp," or "tomato paste" whenever the concentrate complies with the requirements of such foods; except that the label shall bear the statement "for remanufacturing purposes only" when the concentrate is

packaged in No. 10 containers (3.1 kilograms or 109 avoirdupois ounces total water capacity) or containers that are smaller in size.

(d) "Concentrated tomato juice" if the food is prepared from the optional tomato ingredient described in paragraph (a)(1)(i) of this section and is of such concentration that upon diluting the food according to label directions as set forth in paragraph (a)(3)(iii) of this section, the diluted article will contain not less than 5.0 percent by weight tomato soluble solids.

(ii) The following shall be included as part of the name or in close proximity to the name of the food:

(a) The statement "Made from" or "Made in part from," as the case may be, "residual tomato material from canning" if the optional tomato ingredient specified in paragraph (a)(1)(ii) of this section is present.

(b) The statement "Made from" or "Made in part from," as the case may be, "residual tomato material from partial extraction of juice" if the optional tomato ingredient specified in paragraph (a)(1)(iii) of this section is present.

(c) A declaration of any flavoring that characterizes the product as specified in §101.22 of this chapter and a declaration of any spice that characterizes the product, e.g., "Seasoned with _____," the blank to be filled in with the words "added spice" or, in lieu of the word "spice," the common name of the spice.

(iii) The label of concentrated tomato juice shall bear adequate directions for dilution to result in a diluted article containing not less than 5.0 percent by weight tomato soluble solids; except that alternative methods may be used to convey adequate dilution directions for containers that are larger than No. 10 containers (3.1 kilograms or 109 avoirdupois ounces total water capacity).

(iv) Label declaration. Each of the ingredients used in the food shall be declared on the label as required by the applicable sections of parts 101 and 130 of this chapter; except that water need not be declared in the ingredient statement when added to adjust the tomato

soluble solids content of tomato concentrates within the range of soluble solids levels permitted for these foods.

(v) Determine percent tomato soluble solids as specified in §155.3(e). Determine compliance as specified in §155.3(b). A lot shall be deemed to be in compliance for tomato soluble solids as follows:

(a) The sample average meets or exceeds the required minimum.

(b) The number of sample units that are more than 1 percent tomato soluble solids below the minimum required does not exceed the acceptance number in the sampling plans set forth in §155.3(c)(2).

(b) *Quality.* (1) The standard of quality for tomato concentrate (except for concentrated tomato juice, which when diluted to 5.0 percent tomato soluble solids shall conform to the standard of quality for tomato juice set forth in §156.145 of this chapter) is as follows:

(i) The strength and redness of color of the food, when diluted with water (if necessary) to 8.1±0.1 percent tomato soluble solids is not less than the composite color produced by spinning the Munsell color discs in the following combination:

53 percent of the area of Disc 1;
28 percent of the area of Disc 2; and
19 percent of the area of either Disc 3 or Disc 4; or
9½ percent of the area of Disc 3 and 9½ percent of the area of Disc 4, whichever most nearly matches the appearance of the sample.

(ii) Not more than one whole seed per 600 grams (21 ounces).

(iii) Not more than 36 of the following defects, either singly or in combination, per 100 grams (3.5 ounces) of the product when diluted with water to 8.1±0.1 percent tomato soluble solids:

(a) Pieces of peel 5 millimeters (0.20 inch) or greater in length (without unrolling).

(b) Pieces of seed (seed particles) 1 millimeter (0.039 inch) or greater in length.

(c) Blemishes, such as dark brown or black particles (specks)—not more than four exceed 1.6 millimeters (0.0625 inch) in length of which not more than one exceeds 3.2 millimeters (0.125 inch) and none exceed 6.4 millimeters (0.25 inch).

(2) *Methodology.* Dilute with water, if necessary, to 8.1±0.1 percent tomato soluble solids. (i) Determine strength and redness of color as prescribed in §155.3(d).

(ii) Whole seeds—Weigh out 600 grams (21 ounces) of the well-mixed, diluted concentrate; place a U.S. No. 12 screen (1.68 millimeters (0.066 inch) openings) over the sink drain; transfer the product sample onto the screen; rinse container thoroughly with water and pour through screen; flush sample through screen by using an adequate spray of water; check screen for whole seeds; apply the appropriate allowance.

(iii) Peel, pieces of seed, and blemishes—Spread the prepared concentrate evenly on a large white tray and remove the individual defects, identify, classify, and measure.

(3) *Sampling and acceptance.* Determine compliance as specified in §155.3(b).

(4) If the quality of the tomato concentrate falls below the standard prescribed in paragraph (b) (1) and (3) of this section, the label shall bear the general statement of substandard quality specified in §130.14(a) of this chapter, in the manner and form therein specified, but in lieu of such general statement of substandard quality when the quality of the tomato concentrate falls below the standard in one or more respects, the label may bear the alternative statement, "Below Standard in Quality _____," the blank to be filled in with the words specified after the corresponding paragraph(s) under paragraph (b)(1) of this section which such tomato concentrate fails to meet, as follows:

(i) "Poor color."

(ii) "Excessive seeds."

(iii)(a) "Excessive pieces of peel."

(b) "Excessive pieces of seed."

(c) "Excessive blemishes."

(c) *Fill of container.* (1) The standard of fill of container for tomato concentrate, as determined by the general method for fill of container prescribed in §130.12(b) of this chapter, is not less than 90 percent of the total capacity, except when the food is frozen.

(2) Determine compliance as specified in §155.3(b).

(3) If the tomato concentrate falls below the standard of fill prescribed in

§ 155.194

21 CFR Ch. I (4-1-07 Edition)

paragraph (c) (1) and (2) of this section, the label shall bear the general statement of substandard fill specified in § 130.14(b) of this chapter, in the manner and form therein prescribed.

[48 FR 3954, Jan. 28, 1983, as amended at 49 FR 15073, Apr. 17, 1984; 58 FR 2883, Jan. 6, 1993; 58 FR 17104, Apr. 1, 1993]

§ 155.194 Catsup.

(a) *Identity*—(1) *Definition*. Catsup, ketchup, or catchup is the food prepared from one or any combination of two or more of the following optional tomato ingredients:

(i) Tomato concentrate as defined in § 155.191(a)(1), except that lemon juice, concentrated lemon juice, or safe and suitable organic acids may be used in quantities no greater than necessary to adjust the pH, and in compliance with § 155.191(b).

(ii) The liquid derived from mature tomatoes of the red or reddish varieties *Lycopersicum esculentum* P. Mill.

(iii) The liquid obtained from the residue from preparing such tomatoes for canning, consisting of peelings and cores with or without such tomatoes or pieces thereof.

(iv) The liquid obtained from the residue from partial extraction of juice from such tomatoes.

Such liquid is strained so as to exclude skins, seeds, and other coarse or hard substances in accordance with current good manufacturing practice. Prior to straining, food-grade hydrochloric acid may be added to the tomato material in an amount to obtain a pH no lower than 2.0. Such acid is then neutralized with food-grade sodium hydroxide so that the treated tomato material is restored to a pH of 4.2±0.2. The final composition of the food may be adjusted by concentration and/or by the addition of water. The food may contain salt (sodium chloride formed during acid neutralization shall be considered added salt) and is seasoned with ingredients as specified in paragraph (a)(2) of this section. The food is preserved by heat sterilization (canning), refrigeration, or freezing. When sealed in a container to be held at ambient temperatures, it is so processed by heat, before or after sealing, as to prevent spoilage.

(2) *Ingredients*. One or any combination of two or more of the following safe and suitable ingredients in each of the following categories is added to the tomato ingredients specified in paragraph (a)(1) of this section:

(i) Vinegars.

(ii) Nutritive carbohydrate sweeteners. Such sweeteners if defined in part 168 of this chapter shall be as defined therein.

(iii) Spices, flavoring, onions, or garlic.

(3) *Labeling*. (i) The name of the food is “Catsup,” “Ketchup,” or “Catchup.”

(ii) The following shall be included as part of the name or in close proximity to the name of the food:

(a) The statement “Made from” or “Made in part from,” as the case may be, “residual tomato material from canning” if the optional tomato ingredient specified in paragraph (a)(1)(iii) of this section or tomato concentrate containing the ingredient specified in § 155.191(a)(1)(ii) is present.

(b) The statement “Made from” or “Made in part from,” as the case may be, “residual tomato material from partial extraction of juice” if the optional tomato ingredient specified in paragraph (a)(1)(iv) of this section or tomato concentrate containing the ingredient specified in § 155.191(a)(1)(iii) is present.

(iii) Label declaration. Each of the ingredients used in the food shall be declared on the label as required by the applicable sections of parts 101 and 130 of this chapter; except that the name “tomato concentrate” may be used in lieu of the names “tomato puree,” “tomato pulp,” or “tomato paste” and when tomato concentrates are used, the labeling requirements of § 155.191(a)(3)(ii)(a) and (a)(3)(ii)(b) do not apply.

(b) *Quality*. (1) The standard of quality for catsup is as follows: The consistency of the finished food is such that its flow is not more than 14 centimeters in 30 seconds at 20 °C when tested in a Bostwick Consistometer in the following manner: Check temperature of mixture and adjust to 20±1 °C. The trough must also be at a temperature close to 20 °C. Adjust end-to-end level of Bostwick Consistometer by means of

the spirit level placed in trough of instrument. Side-to-side level may be adjusted by means of the built-in spirit level. Transfer sample to the dry sample chamber of the Bostwick Consistometer. Fill the chamber slightly more than level full, avoiding air bubbles as far as possible. Pass a straight edge across top of chamber starting from the gate end to remove excess product. Release gate of instrument by gradual pressure on lever, holding the instrument down at the same time to prevent its movement as the gate is released. Immediately start the stop watch or interval timer, and after 30 seconds read the maximum distance of flow to the nearest 0.1 centimeter. Clean and dry the instrument and repeat the reading on another portion of sample. Do not wash instrument with hot water if it is to be used immediately for the next determination, as this may result in an increase in temperature of the sample. For highest accuracy, the instrument should be maintained at a temperature of 20±1 °C. If readings vary more than 0.2 centimeter, repeat a third time or until satisfactory agreement is obtained. Report the average of two or more readings, excluding any that appear to be abnormal.

(2) Determine compliance as specified in §155.3(b).

(3) If the quality of catsup falls below the standard prescribed in paragraphs (b) (1) and (2) of this section, the label shall bear the general statement of substandard quality specified in §130.14(a) of this chapter, in the manner and form therein specified, but in lieu of such general statement of substandard quality when the quality of the catsup falls below the standard, the label may bear the alternative statement, "Below Standard in Quality—Low Consistency."

(c) *Fill of container.* (1) The standard of fill of container for catsup, as determined by the general method for fill of container prescribed in §130.12(b) of this chapter, is not less than 90 percent of the total capacity except:

- (i) When the food is frozen, or
- (ii) When the food is packaged in individual serving-size packages containing 56.7 grams (2 ounces) or less.

(2) Determine compliance as specified in §155.3(b).

(3) If the catsup falls below the standard of fill prescribed in paragraphs (c) (1) and (2) of this section, the label shall bear the general statement of substandard fill as specified in §130.14(b) of this chapter, in the manner and form therein specified.

[48 FR 3956, Jan. 28, 1983, as amended at 49 FR 15073, Apr. 17, 1984; 58 FR 2883, Jan. 6, 1993]

§ 155.200 Certain other canned vegetables.

(a) The canned vegetables for which definitions and standards of identity are prescribed by this section are those named in column I of the table set forth in paragraph (b) of this section. The vegetable ingredient in each such canned vegetable is obtained by proper preparation from the succulent vegetable prescribed in column II of such table. If two or more forms of such ingredient are designated in column III of such table, the vegetable in each such form is an optional ingredient. To the vegetable ingredient additional ingredients as required or permitted by paragraph (c) of this section are added, and the food is sealed in a container and so processed by heat as to prevent spoilage.

(b) The table referred to in paragraph (a) of this section is as follows:

I—Name or synonym of canned vegetable	II—Source	III—Optional forms of vegetable ingredient
Artichokes	Flower buds of the artichoke plant	Whole; half or halves or halved; whole hearts; halved hearts; quartered hearts.
Asparagus	Edible portions of sprouts of the asparagus plant, as follows: 3 and ¾ in or more of upper end	Stalks or spears.
	3 and ¾ in or more of peeled upper end	Peeled stalks or peeled spears.
	Not less than 2 and ¾ in but less than 3 and ¾ in of upper end.	Tips.
	Less than 2 and ¾ in of upper end	Points.
	Sprouts cut in pieces	Cut stalks or cut spears.

§ 155.200

21 CFR Ch. I (4-1-07 Edition)

I—Name or synonym of canned vegetable	II—Source	III—Optional forms of vegetable ingredient
Bean sprouts	Sprouts from which the tip has been removed, cut in pieces.	Bottom cuts or cuts—tips removed.
Shelled beans	Sprouts of the Mung bean.	
Lima beans or butter beans	Seed shelled from green or wax bean pods, with or without snaps (pieces of immature unshelled pods).	
Beets	Seed shelled from the pods of the lima bean plant.	
Beet greens	Root of the beet plant	Whole; slices or sliced; quarters or quartered; dice or diced; cut; shoestring or French style or julienne.
Broccoli	Leaves, or leaves and immature root, of the beet plant.	
Brussels sprouts	Heads of the broccoli plant.	
Cabbage	Sprouts of the brussels sprouts plant.	
Carrots	Cut pieces of the heads of the cabbage plant.	Do.
Cauliflower	Root of the carrot plant	
Celery	Cut pieces of the head of the cauliflower plant.	
Collards	Stalks of the celery plant	Cut; hearts.
Dandelion greens	Leaves of the collard plant.	
Kale	Leaves of the dandelion plant.	
Mustard greens	Leaves of the kale plant.	
Okra	Leaves of the mustard plant.	Whole; cut.
Onions	Pods of the okra plant	Do.
Parsnips	Bulb of the onion plant	Whole; quarters or quartered; slices or sliced; cut; shoestring or French style or julienne.
Black-eye peas or black-eyed peas	Root of the parsnip plant	
Field peas	Seed shelled from pods of the black-eye pea plant, with or without snaps (pieces of immature unshelled pods).	
Green sweet peppers	Seed shelled from pods of the field pea plant (other than the black-eye pea plant), with or without snaps (pieces of immature unshelled pods).	
Red sweet peppers	Green pods of the sweet pepper plant	Whole; halves or halved; pieces; dice or diced; strips; chopped.
Pimientos or pimentos	Red-ripe pods of the sweet pepper plant	Do.
Potatoes	Red-ripe pods of the pimiento, pimento, pepper plant.	Whole; halves or halved; pieces; dice or diced; slices or sliced; chopped.
Rutabagas	Tuber of the potato plant	Whole; slices or sliced; dice or diced; pieces; shoestring or French style or julienne; French fry cut.
Salsify	Root of the rutabaga plant	Whole; quarters or quartered; slices or sliced; dice or diced; cut.
Spinach	Root of the salsify plant.	Whole leaf; cut leaf or sliced; chopped.
Sweet potatoes	Leaves of the spinach plant	Whole; mashed; pieces or cuts or cut (longitudinally cut halves may be named on labels as halves or halved in lieu of pieces or cuts or cut).
Swiss chard	Tuber of the sweet potato plant	
Truffles	Leaves of the Swiss chard plant.	
Turnip greens	Fruit of the truffle.	
Turnips	Leaves of the turnip plant.	Whole; quarters or quartered; slices or sliced; dice or diced; cut.
	Root of the turnip plant	

(c) Water is added to the vegetable ingredient, except that pimientos may be canned with or without added water, and sweet potatoes in mashed form are canned without added water. Asparagus may be canned with added water, asparagus juice, or a mixture of both. For the purposes of this section, asparagus juice is the clear, unfermented liquid expressed from the washed and

heated sprouts or parts of sprouts of the asparagus plant, and mixtures of asparagus juice and water are considered to be water when such mixtures are used as a packing medium for canned asparagus. In the case of artichokes, a vinegar or any safe and suitable organic acid, which either is not a food additive as defined in section 201(s) of the Federal Food, Drug, and

Cosmetic Act, or if it is a food additive as so defined, is used in conformity with regulations established pursuant to section 409 of the act, is added in such quantity as to reduce the pH of the finished canned vegetable to 4.5 or below. The following optional ingredients, in the case of the vegetables specified, may be added:

(1) An edible vegetable oil, in the cases of artichokes and pimientos.

(2) Snaps, in the cases of shelled beans, black-eyed peas, and field peas.

(3) In the case of all vegetables (except canned mashed sweet potatoes as regards the seasonings listed in paragraph (c)(3)(iii) of this section) one or more of the following optional seasoning ingredients may be added in a quantity sufficient to season the food.

(i) Refined sugar (sucrose).

(ii) Refined corn sugar (dextrose).

(iii) Corn sirup, glucose sirup.

(iv) Dried corn sirup, dried glucose sirup.

(v) Spice.

(vi) A vinegar.

(vii) Green peppers or red peppers which may be dried.

(viii) Mint leaves.

(ix) Onions, which may be dried.

(x) Garlic, which may be dried.

(xi) Horseradish.

(xii) Lemon juice or concentrated lemon juice.

(xiii) Butter or margarine in a quantity not less than 3 percent by weight of the finished food. When butter or margarine is added, safe and suitable emulsifiers or stabilizers, or both, may be added. When butter or margarine is added, no spice or flavoring simulating the color or flavor imparted by butter or margarine is used.

(4) In the case of all vegetables, the following optional ingredients may be added:

(i) Salt.

(ii) Monosodium glutamate.

(iii) Disodium inosinate complying with the provisions of §172.535 of this chapter.

(iv) Disodium guanylate complying with the provisions of §172.530 of this chapter.

(v) Hydrolyzed vegetable protein.

(vi) Autolyzed yeast extract.

(5) In the case of all vegetables flavoring (except artificial) may be added.

(6) In the case of bean sprouts, lima beans, carrots, green sweet peppers, red sweet peppers, and potatoes, any safe and suitable calcium salts may be added as a firming agent.

(7) In the case of canned artichokes packed in glass containers, ascorbic acid may be added in a quantity not to exceed 32 milligrams per 100 grams of the finished food.

(8) In the case of canned asparagus, ascorbic acid, erythorbic acid, or the sodium salts of ascorbic acid or erythorbic acid may be added in an amount necessary to preserve color in the "white" and "green-tipped and white" color types.

(9) In the case of canned asparagus packed in glass containers, stannous chloride may be added in a quantity not to exceed 15 parts per million calculated as tin (Sn), except that in the case of asparagus packed in glass containers with lids lined with an inert material the quantity of stannous chloride added may exceed 15 parts per million but not 20 parts per million calculated as tin (Sn).

(10) In the case of canned black-eyed peas, disodium EDTA may be added in a quantity not to exceed 145 parts per million.

(11) In the case of potatoes, calcium disodium EDTA may be added in a quantity not to exceed 110 parts per million.

(12) A vinegar or any safe and suitable organic acid for all vegetables (except artichokes, in which the quantity of such optional ingredient is prescribed by the introductory text of paragraph (c) of this section) in a quantity which, together with the amount of any lemon juice or concentrated lemon juice that may be added, is not more than sufficient to permit effective processing by heat without discoloration or other impairment of the article.

(d) The name of each canned vegetable for which a definition and standard of identity is prescribed by this section is the name or any synonym thereof whereby such vegetable is designated in column I of the table in paragraph (b) of this section.

(e) When two or more forms of the vegetable are specified in column III of

the table in paragraph (b) of this section, the label shall bear the specified word or words, or in case synonyms are so specified, one of such synonyms, showing the form of the vegetable ingredient present; except that in the case of canned spinach, if the whole leaf is the optional form used, the word "spinach" unmodified may be used in lieu of the words "whole leaf spinach".

(f)(1) If the optional ingredient specified in paragraph (c)(1) of this section is present, the label shall bear the statement "_____ oil added" or "With added _____ oil", the blank being filled in with the common or usual name of the oil.

(2) If asparagus juice is used as a packing medium in canned asparagus, the label shall bear the statement "Packed in asparagus juice".

(3) If the optional ingredient specified in paragraph (c)(2) of this section is present, the label shall bear the statement "With snaps".

(g) The name of the food shall include a declaration of any flavoring that characterizes the product as specified in §101.22 of this chapter, and a declaration of any spice or seasoning that characterizes the product; for example, "with added spice", "seasoned with red peppers", "seasoned with butter". Wherever the name of the vegetable appears on the label so conspicuously as to be easily seen under customary conditions of purchase, the words and statements specified in paragraphs (e) and (f) (1) through (3) of this section shall immediately and conspicuously precede or follow such name, without intervening written, printed, or graphic matter, except that the varietal name of the vegetable may so intervene.

(h) Label declaration. Each of the ingredients used in the food shall be declared on the label as required by the applicable sections of parts 101 and 130 of this chapter.

[42 FR 14449, Mar. 15, 1977, as amended at 42 FR 30358, June 14, 1977; 46 FR 56410, Nov. 17, 1981; 48 FR 10813, Mar. 15, 1983; 49 FR 6711, Feb. 23, 1984; 58 FR 2883, Jan. 6, 1993; 59 FR 15052, Mar. 31, 1994]

§ 155.201 Canned mushrooms.

(a) *Identity*—(1) *Definition*. Canned mushrooms is the food properly pre-

pared from the caps and stems of succulent mushrooms conforming to the characteristics of the species *Agaricus (Psalliota) bisporus* or *A. bitorquis*, in one of the optional styles specified in paragraph (a)(2) of this section, packed with a suitable liquid medium which may include water; and may contain one or more safe and suitable optional ingredients specified in paragraph (a)(3) of this section. The food is sealed in a container and, before or after sealing, is so processed by heat as to prevent spoilage.

(2) *Styles*. The optional styles of the mushroom ingredient referred to in paragraph (a)(1) of this section are:

(i) *Buttons*—consisting of whole mushrooms with attached stems not exceeding 5 millimeters (0.2 inch) in length, measured from the bottom of the veil.

(ii) *Whole*—consisting of whole mushrooms with attached stems cut to a length not exceeding the diameter of the cap, measured from the bottom of the veil.

(iii) *Quarters*—consisting of buttons or whole style cut into four approximately equal parts.

(iv) *Slices or sliced*—consisting of buttons or whole style of which not less than 50 percent are cut parallel to the longitudinal axis of the stem and 2 millimeters to 8 millimeters (0.08 inch to 0.32 inch) in thickness.

(v) *Random sliced*—consisting of buttons or whole style sliced in a random manner.

(vi) *Pieces and stems*—consisting of pieces of caps and stems of irregular shapes and sizes.

(3) *Optional ingredients*. One or any combination of two or more of the following safe and suitable optional ingredients as provided for in paragraph (a)(1) of this section may be used:

(i) Salt.

(ii) Monosodium glutamate.

(iii) Disodium inosinate complying with the provisions of §172.535 of this chapter.

(iv) Disodium guanylate complying with the provisions of §172.530 of this chapter.

(v) Hydrolyzed vegetable protein.

(vi) Autolyzed yeast extract.

(vii) Ascorbic acid (vitamin C) in a quantity not to exceed 132 milligrams

for each 100 grams (37.5 milligrams for each ounce) of drained weight of mushrooms.

(viii) Organic acids (except no vinegar is permitted), only where the inside metal of the container is fully enamel-lined and in glass containers with fully enamel-lined caps. Ascorbic acid as provided for in paragraph (a)(3)(vii) of this section.

(ix) Calcium disodium ethylenediaminetetraacetate (CaNa₂ EDTA) in a quantity not to exceed 200 parts per million for use to promote color retention.

(4) *Labeling requirements.* (i) The name of the food is mushrooms. The style as provided for in paragraph (a)(2) of this section shall be included as part of the name or in close proximity to the name of the food.

(ii) Label declaration. Each of the ingredients used in the food shall be declared on the label as required by the applicable sections of parts 101 and 130 of this chapter.

(b) [Reserved]

(c) *Fill of container.* (1) The standard of fill of container for canned mushrooms is:

(i) The fill of the mushroom ingredient and packing medium, as determined by the general method for fill of container prescribed in §130.12(b) of this chapter, is not less than 90 percent of the total capacity of the container.

(ii) The drained weight of the mushroom ingredient is not less than 56 percent of the water capacity of the container.

(iii) Determine drained weight as specified in §155.3(a).

(2) Determine compliance for minimum fill and drained weight as specified in §155.3(b).

(3) If the canned mushrooms fall below the standard of fill prescribed in paragraph (c)(1) (i) and/or (ii) and (2) of this section, the label shall bear the general statement of substandard fill specified in §130.14(b) of this chapter, in the manner and form therein prescribed.

[48 FR 10813, Mar. 15, 1983, as amended at 58 FR 2883, Jan. 6, 1993]

PART 156—VEGETABLE JUICES

Subpart A—General Provisions

Sec.

156.3 Definitions.

Subpart B—Requirements for Specific Standardized Vegetable Juices

156.145 Tomato juice.

AUTHORITY: 21 U.S.C. 321, 341, 343, 348, 371.

Subpart A—General Provisions

§ 156.3 Definitions.

For the purpose of this part:

(a) *Strength and redness of color* means at least as much red as obtained by comparison of the prepared product, with the blended color produced by spinning a combination of the following concentric Munsell color discs of equal diameter, or the color equivalent of such discs:

Disc 1—Red (5R 2.6/13) (glossy finish)

Disc 2—Yellow (2.5 YR 5/12) (glossy finish)

Disc 3—Black (N1) (glossy finish)

Disc 4—Grey (N4) (mat finish)

Such comparison is to be made in full diffused daylight or under a diffused light source of approximately 2691 lux (250 footcandles) and having a spectral quality approximating that of daylight under a moderately overcast sky, with a correlated color temperature of 7,500 degrees Kelvin ±200 degrees. With the light source directly over the disc and product, observation is made at an angle of 45 degrees from a distance of about 24 inches from the product. Electronic color meters may be used as an alternate means of determining the color of tomato juice. Such meters shall be calibrated to indicate that the color of the product is as red or more red than that produced by spinning the Munsell color discs in the combination as set out above.

(b) *Tomato soluble solids* means the sucrose value as determined by the method prescribed in "Official Methods of Analysis of the Association of Official Analytical Chemists," 13th Ed., 1980, sections 32.014 to 32.016 and 52.012, under the headings "Soluble Solids in

§ 156.3

21 CFR Ch. I (4-1-07 Edition)

Tomato Products Official Final Action” and “Refractive Indices (n) of Sucrose Solutions at 20°,” which is incorporated by reference. Copies are available from the AOAC INTERNATIONAL, 481 North Frederick Ave., suite 500, Gaithersburg, MD 20877, or available for inspection at the National Archives and Records Administration (NARA). For information on the availability of this material at NARA, call 202-741-6030, or go to: http://www.archives.gov/federal_register/code_of_federal_regulations/ibr_locations.html. If no salt has been added, the sucrose value obtained from the referenced tables shall be considered the percent of tomato soluble solids. If salt has been added, either intentionally or through the application of the acidified break, determine the percent of such added sodium chloride as specified in paragraph (c) of this section. Subtract the percentage so found from the percentage of tomato soluble solids found (sucrose value from the refractive index tables) and multiply the difference by 1.016. The resultant value is considered the percent of “tomato soluble solids.”

(c) *Salt* means sodium chloride, determined as chloride and calculated as percent sodium chloride, by the method prescribed in “Official Methods of Analysis of the Association of Official Analytical Chemists,” 13th Ed., 1980, sections 32.025 to 32.030, under the heading “Method III (Potentiometric Method),” which is incorporated by reference.

(d) *Compliance* means the following: Unless otherwise provided in a standard, a lot of canned vegetable juice shall be deemed in compliance for the following factors, to be determined by the sampling and acceptance procedure as provided in paragraph (e) of this section, namely:

(1) *Quality*. The quality of a lot shall be considered acceptable when the number of defectives does not exceed the acceptance number (c) in the sampling plans.

(2) *Fill of container*. A lot shall be deemed to be in compliance for fill of container when the number of defectives does not exceed the acceptance number (c) in the sampling plans.

(e) *Sampling and acceptance procedure* means the following:

(1) *Definitions*—(i) *Lot*. A collection of primary containers or units of the same size, type, and style manufactured or packed under similar conditions and handled as a single unit of trade.

(ii) *Lot size*. The number of primary containers or units in the lot.

(iii) *Sample size (n)*. The total number of sample units drawn for examination from a lot.

(iv) *Sample unit*. A container, a portion of the contents of a container, or a composite mixture of product from small containers that is sufficient for the examination or testing as a single unit. For fill of container, the sample unit shall be the entire contents of the container.

(v) *Defective*. Any sample unit shall be regarded as defective when the sample unit does not meet the criteria set forth in the standards.

(vi) *Acceptance number (c)*. The maximum number of defective sample units permitted in the sample in order to consider the lot as meeting the specified requirements.

(vii) *Acceptable quality level (AQL)*. The maximum percent of defective sample units permitted in a lot that will be accepted approximately 95 percent of the time.

(2) *Sampling plans*:

ACCEPTABLE QUALITY LEVEL (AQL) 6.5

Lot size (primary containers)	Size of container	
	n	c
NET WEIGHT EQUAL TO OR LESS THAN 1 KG (2.2 LB)		
4,800 or less	13	2
4,801 to 24,000	21	3
24,001 to 48,000	29	4
48,001 to 84,000	48	6
84,001 to 144,000	84	9
144,001 to 240,000	126	13
Over 240,000	200	19
NET WEIGHT GREATER THAN 1 KG (2.2 LB) BUT NOT MORE THAN 4.5 KG (10 LB)		
2,400 or less	13	2
2,401 to 15,000	21	3
15,001 to 24,000	29	4
24,001 to 42,000	48	6
42,001 to 72,000	84	9
72,001 to 120,000	126	13
Over 120,000	200	19
NET WEIGHT GREATER THAN 4.5 KG (10 LB)		
600 or less	13	2

ACCEPTABLE QUALITY LEVEL (AQL) 6.5—
Continued

Lot size (primary containers)	Size of container	
	<i>n</i>	<i>c</i>
601 to 2,000	21	3
2,001 to 7,200	29	4
7,201 to 15,000	48	6
15,001 to 24,000	84	9
24,001 to 42,000	126	13
Over 42,000	200	19

n—number of primary containers in sample.
c—acceptance number.

[48 FR 3956, Jan. 28, 1983, as amended at 54 FR 24895, June 12, 1989; 63 FR 14035, Mar. 24, 1998]

Subpart B—Requirements for Specific Standardized Vegetable Juices

§ 156.145 Tomato juice.

(a) *Identity*—(1) *Definition*. Tomato juice is the food intended for direct consumption, obtained from the unfermented liquid extracted from mature tomatoes of the red or reddish varieties of *Lycopersicon esculentum* P. Mill, with or without scalding followed by draining. In the extraction of such liquid, heat may be applied by any method which does not add water thereto. Such juice is strained free from peel, seeds, and other coarse or hard substances, but contains finely divided insoluble solids from the flesh of the tomato in accordance with current good manufacturing practice. Such juice may be homogenized, may be seasoned with salt, and may be acidified with any safe and suitable organic acid. The juice may have been concentrated and later reconstituted with water and/or tomato juice to a tomato soluble solids content of not less than 5.0 percent by weight as determined by the method prescribed in §156.3(b). The food is preserved by heat sterilization (canning), refrigeration, or freezing. When sealed in a container to be held at ambient temperatures, it is so processed by heat, before or after sealing, as to prevent spoilage.

(2) *Labeling*. (i) The name of the food is:

(a) “Tomato juice” if it is prepared from unconcentrated undiluted liquid extracted from mature tomatoes of reddish varieties.

(b) “Tomato juice from concentrate” if the finished juice has been prepared from concentrated tomato juice as specified in paragraph (a)(1) of this section or if the finished juice is a mixture of tomato juice and tomato juice from concentrate.

(ii) *Label declaration*. Each of the ingredients used in the food shall be declared on the label as required by the applicable sections of parts 101 and 130 of this chapter.

(b) *Quality*. (1) The standard of quality for tomato juice is as follows:

(i) The strength and redness of color is not less than the composite color produced by spinning the Munsell color discs in the following combination: 53 percent of the area of Disc 1; 28 percent of the area of Disc 2; and 19 percent of the area of either Disc 3 or Disc 4; or 9½ percent of the area of Disc 3 and 9½ percent of the area of Disc 4, whichever most nearly matches the appearance of the tomato juice.

(ii) Not more than two defects for peel and blemishes, either singly or in combination, in addition to three defects for seeds or pieces of seeds, defined as follows, per 500 milliliters (16.9 fluid ounces):

(a) Pieces of peel 3.2 millimeters (0.125 inch) or greater in length.

(b) Blemishes such as dark brown or black particles (specks) greater than 1.6 millimeters (0.0625 inch) in length.

(c) Seeds or pieces of seeds 3.2 millimeters (0.125 inch) or greater in length.

(2) *Methodology*. (i) Determine strength and redness of color as specified in §156.3(a).

(ii) Examine a total of 500 milliliters for peel, blemishes, and seeds. Divide the 500-milliliter sample into two 250-milliliter aliquots and pour each aliquot onto separate 30.5 × 45.7 centimeters (12 × 18 inches) white grading trays. Remove defects and evaluate for color and size as defined in paragraph (b)(1)(ii) of this section.

(3) Determine compliance as specified in §156.3(d).

(4) If the quality of the tomato juice falls below the standard prescribed in paragraph (b)(1) and (3) of this section, the label shall bear the general statement of substandard quality specified in §130.14(a) of this chapter, in the manner and form therein specified, but

in lieu of such general statement of substandard quality when the quality of the tomato juice falls below the standard in one or more respects, the label may bear the alternative statement, "Below Standard in Quality _____", the blank to be filled in with the words specified after the corresponding paragraph (s) under paragraph (b)(1) of this section which such tomato juice fails to meet, as follows:

- (i) "Poor color".
- (ii)(a) "Excessive pieces of peel".
- (b) "Excessive blemishes".
- (c) "Excessive seeds" or "excessive pieces of seed".

(c) *Fill of container.* (1) The standard of fill of container for tomato juice, as determined by the general method for fill of container prescribed in §130.12(b) of this chapter, is not less than 90 percent of the total capacity, except when the food is frozen.

(2) Determine compliance as specified in §156.3(d).

(3) If the tomato juice falls below the standard of fill prescribed in paragraph (c)(1) and (2) of this section, the label shall bear the general statement of substandard fill specified in §130.14(b) of this chapter, in the manner and form therein prescribed.

[48 FR 3957, Jan. 28, 1983, as amended at 58 FR 2883, Jan. 6, 1993]

PART 158—FROZEN VEGETABLES

Subpart A—General Provisions

Sec.
158.3 Definitions.

Subpart B—Requirements for Specific Standardized Frozen Vegetables

158.170 Frozen peas.
AUTHORITY: 21 U.S.C. 321, 341, 343, 348, 371.

Subpart A—General Provisions

§ 158.3 Definitions.

For the purposes of this part the following definitions shall apply:

(a) *Lot.* A collection of primary containers or units of the same size, type and style manufactured or packed under similar conditions and handled as a single unit of trade.

(b) *Lot size.* The number of primary containers or units (pounds when in bulk) in the lot.

(c) *Sample size.* The total number of sample units drawn for examination from a lot.

(d) *Sample unit.* A container, a portion of the contents of a container, or a composite mixture of product from small containers that is sufficient for the examination or testing as a single unit.

(e) *Defective.* Any sample unit shall be regarded as defective when the sample unit does not meet the criteria set forth in the standards.

(f) *Acceptance number.* The maximum number of defective sample units permitted in the sample in order to consider the lot as meeting the specified requirements. The following acceptance numbers shall apply:

Lot size (primary container)	Size container	
	n ¹	c ²
NET WEIGHT EQUAL TO OR LESS THAN 1 KG (2.2 LB)		
4,800 or less	13	2
4,801 to 24,000	21	3
24,001 to 48,000	29	4
48,001 to 84,000	48	6
84,001 to 144,000	84	9
144,001 to 240,000	126	13
Over 240,000	200	19
NET WEIGHT GREATER THAN 1 KG (2.2 LB)		
Number of Pounds		
20,000 or less	13	2
More than 20,000 to 100,000	21	3
More than 100,000 to 200,000	29	4
More than 200,000 to 400,000	48	6
More than 400,000 to 600,000	84	9
More than 600,000 to 1,000,000	126	13
More than 1,000,000	200	19

¹ n=number of sample units.
² c=acceptance number.

(g) *Acceptable quality level (AQL).* The maximum percent of defective sample units permitted in a lot that will be accepted approximately 95 percent of the time.

[42 FR 14461, Mar. 15, 1977]

Subpart B—Requirements for Specific Standardized Frozen Vegetables

§ 158.170 Frozen peas.

(a) *Identity—(1) Product definition.* Frozen peas is the food in "package" form as that term is defined in §1.20 of

this chapter, prepared from the succulent seed of the pea plant of the species *Pisum sativum* L. Any suitable variety of pea may be used. It is blanched, drained, and preserved by freezing in such a way that the range of temperature of maximum crystallization is passed quickly. The freezing process shall not be regarded as complete until the product temperature has reached -18 °C (0 °F) or lower at the thermal center, after thermal stabilization. Such food may contain one, or any combination of two or more, of the following safe and suitable optional ingredients:

- (i) Natural and artificial flavors.
- (ii) Condiments such as spices and mint leaves.
- (iii) Dry nutritive carbohydrate sweeteners.
- (iv) Salt.
- (v) Monosodium glutamate and other glutamic acid salts.

(2) *Size specifications.* If size graded, frozen peas shall contain not less than 80 percent by weight of peas of the size declared or of smaller sizes. The sample unit may not contain more than 20 percent by weight of peas of the next two larger sizes, of which not more than one quarter by weight of such peas may be of the larger of these two sizes, and may contain no peas larger than the next two larger sizes, if such there be. The following sizes and designations shall apply:

Size designation	Round hole sieve size through which peas will pass	
	Millimeters	Inch
Extra small	Up to 7.5	0.295
Very small	Up to 8.232
Small	Up to 8.7534
Medium	Up to 10.240
Large	Over 10.240

(3) *Labeling.* The name of the product is "peas". The term "early", "June", or "early June" shall precede or follow the name in the case of smooth-skin or substantially smooth-skin peas, such as Alaska-type peas. Where the peas are of sweet green wrinkled varieties, the name may include the designation "sweet", "green", "wrinkled", or any combination thereof. The label shall contain the words "frozen" or "quick frozen". The name of the food shall include a declaration of any flavoring

that characterizes the product as specified in §101.22 of this chapter and a declaration of any condiment such as spices and mint leaves that characterizes the product, e.g., "Spice added". Where a statement of pea size is made, such statement shall indicate either the size designation as specified in paragraph (a)(2) of this section or the applicable sieve size. However, the optional descriptive words "petite" or "tiny" may be used in conjunction with the product name when an average of 80 percent or more of the peas will pass through a circular opening of a diameter of 8.75 mm (0.34 in) or less for sweet green wrinkled peas and 8.2 mm (0.32 in) for smooth-skin or substantially smooth-skin peas, such as Alaska-type peas.

(4) *Label declaration.* Each of the ingredients used in the food shall be declared on the label as required by the applicable sections of parts 101 and 130 of this chapter.

(b) *Quality.* (1) The standard of quality for frozen peas is as follows:

- (i) Not more than 4 percent by weight blond peas, i.e., yellow or white but edible peas;
- (ii) Not more than 10 percent by weight blemished peas, i.e., slightly stained or spotted peas;
- (iii) Not more than 2 percent by weight seriously blemished peas, i.e., peas that are hard, shrivelled, spotted, discolored or otherwise blemished to an extent that the appearance or eating quality is seriously affected.

(iv) Not more than 15 percent by weight pea fragments, i.e., portions of peas, separated or individual cotyledons, crushed, partial or broken cotyledons and loose skins, but excluding entire intact peas with skins detached;

(v) Not more than 0.5 percent by weight, or more than 12 sq cm (2 sq in) in area, extraneous vegetable material, i.e., vine or leaf or pod material from the pea plant or other such material per sample unit as defined in paragraph (b) of this section.

(vi) The sum of the pea material described in paragraphs (b)(1) (i), (ii), (iii), and (iv) of this section shall not exceed 15 percent.

(vii) For peas that meet the organoleptic and analytical characteristics of sweet green wrinkled varieties:

(a) The alcohol-insoluble solids may not be more than 19 percent based on the procedure set forth in paragraph (b)(3) of this section.

(b) Not more than 15 percent by count of the peas may sink in a solution containing 16 percent salt by weight according to the brine flotation test set forth in paragraph (b)(4) of this section;

(viii) For smooth-skin or substantially smooth-skin varieties the alcohol insoluble solids may not be more than 23 percent based on the procedure set forth in paragraph (b)(3) of this section.

(ix) The quality of a lot shall be considered acceptable when the number of defectives does not exceed the acceptance number in the sampling plans set forth in § 158.3(f).

(2) The sample unit for determining compliance with the requirements of paragraph (b)(1) of this section other than those of paragraphs (b)(1)(vii)(a) and (b)(1)(viii) of this section, shall be 500 g (17.6 oz). For the determination of alcohol-insoluble solids as specified in paragraph (b)(3) of this section, the container may be the sample unit.

(3) *Alcohol-insoluble solids determination.* (i) Extracting solutions:

(a) One hundred parts of ethanol denatured with five parts of methanol volume to volume (formula 3A denatured alcohol), or

(b) A mixture of 95 parts of formula 3A denatured alcohol and five parts of isopropanol v/v.

(ii) Eighty percent alcohol (8 liters of extracting solutions, specified in paragraph (b)(3)(i) (a) or (b) of this section, diluted to 9.5 liters with water).

(iii) Drying dish—a flat-bottom dish with a tight fitting cover.

(iv) Drying oven—a properly ventilated oven thermostatically controlled at 100 ± 2 °C.

(v) Procedure—Transfer frozen contents of package to plastic bag; tie bag securely and immerse in water bath with continuous flow at room temperature. Avoid agitation of bag during thawing by using clamps or weights. When sample completely thaws, re-

move bag, blot off adhering water, and transfer peas to U.S. No. 8 sieve, using (20 cm.) size for container of less than 3 lb. net weight and (30.5 cm.) for larger quantities. Without shifting peas, incline sieve to aid drainage, drain 2 minutes. With cloth wipe surplus water from lower screen surface. Weigh 250 g. of peas into high-speed blender, add 250 g. of water and blend to smooth paste. For less than 250 g. sample, use entire sample with equal weight of water. Weigh 20 g. ± 10 mg. of the paste into 250 ml. distillation flask, add 120 ml. of extracting solutions specified in paragraph (b)(3)(i) (a) or (b) of this section, and reflux 30 minutes on steam or water bath or hotplate. Fit into a buchner funnel a filter paper of appropriate size (previously prepared by drying in flatbottom dish for 2 hours in drying oven, covering, cooling in desiccator, and weighing). Apply vacuum to buchner funnel and transfer contents of beaker so as to avoid running over edge of paper. Aspirate to dryness and wash material on filter with 80 percent alcohol until washings are clear and colorless. Transfer paper and alcohol-insoluble solids to drying dish used to prepare paper, dry uncovered for 2 hours in drying oven, cover, cool in desiccator, and weigh at once. From this weight deduct weight of dish, cover, and paper. Calculate percent by weight of alcohol-insoluble solids.

(4) *Brine flotation test.* (i) Explanation—The brine flotation test utilizes salt solutions of various specific gravities to separate the peas according to maturity. The brine solutions are based on the percentage by weight of pure salt (NaCl) in solution at 20 °C. In making the test the brine solutions are standardized to the proper specific gravity equivalent to the specified “percent of salt solutions at 20 °C” by using a salometer spindle accurately calibrated at 20 °C. A 250 ml glass beaker or similar receptacle is filled with the brine solution to a depth of approximately 50 mm. The brine solution and sample (100 peas per container) must be at the same temperature and should closely approximate 20 °C.

(ii) Procedure—After carefully removing the skins from the peas, place the peas into the solution. Pieces of peas and loose skins should not be used

in making the brine flotation test. If cotyledons divide, use both cotyledons in the test and consider the two separated cotyledons as 1 pea; and, if an odd cotyledon sinks, consider it as one pea. Only peas that sink to the bottom of the receptacle within 10 seconds after immersion are counted as "peas that sink".

(5) If the quality of the frozen peas falls below the standard prescribed in paragraph (b)(1) of this section, the label shall bear the general statement of substandard quality specified in the Code of Federal Regulations but in lieu of the words prescribed in the second line of the rectangle the following words may be used where the frozen peas fall below the standard in only one respect: "Below standard in quality _____", the blank to be filled in with the specific reason for substandard quality as listed in the standard.

[42 FR 14461, Mar. 15, 1977, as amended at 42 FR 15673, Mar. 22, 1977; 58 FR 2883, Jan. 6, 1993]

PART 160—EGGS AND EGG PRODUCTS

Subpart A [Reserved]

Subpart B—Requirements for Specific Standardized Eggs and Egg Products

Sec.

160.100	Eggs.
160.105	Dried eggs.
160.110	Frozen eggs.
160.115	Liquid eggs.
160.140	Egg whites.
160.145	Dried egg whites.
160.150	Frozen egg whites.
160.180	Egg yolks.
160.185	Dried egg yolks.
160.190	Frozen egg yolks.

AUTHORITY: 21 U.S.C. 321, 341, 343, 348, 371, 379e.

SOURCE: 42 FR 14462, Mar. 15, 1977, unless otherwise noted.

Subpart A [Reserved]

Subpart B—Requirements for Specific Standardized Eggs and Egg Products

§ 160.100 Eggs.

No regulation shall be promulgated fixing and establishing a reasonable definition and standard of identity for the food commonly known as eggs.

§ 160.105 Dried eggs.

(a) Dried eggs, dried whole eggs are prepared by drying liquid eggs that conform to §160.115, with such precautions that the finished food is free of viable *Salmonella* microorganisms. They may be powdered. Before drying, the glucose content of the liquid eggs may be reduced by one of the optional procedures set forth in paragraph (b) of this section. Either silicon dioxide complying with the provisions of §172.480 of this chapter or sodium silicoaluminate may be added as an optional anticaking ingredient, but the amount of silicon dioxide used is not more than 1 percent and the amount of sodium silicoaluminate used is less than 2 percent by weight of the finished food. The finished food shall contain not less than 95 percent by weight total egg solids.

(b) The optional glucose-removing procedures are:

(1) *Enzyme procedure.* A glucose-oxidase-catalase preparation and hydrogen peroxide solution are added to the liquid eggs. The quantity used and the time of reaction are sufficient to substantially reduce the glucose content of the liquid eggs. The glucose-oxidase-catalase preparation used is one that is generally recognized as safe within the meaning of section 201(s) of the Federal Food, Drug, and Cosmetic Act. The hydrogen peroxide solution used shall comply with the specifications of the United States Pharmacopeia, except that it may exceed the concentration specified therein and it does not contain a preservative.

(2) *Yeast procedure.* The pH of the liquid eggs is adjusted to the range of 6.0 to 7.0, if necessary, by the addition of dilute, chemically pure hydrochloric acid, and controlled fermentation is maintained by adding food-grade baker's yeast (*Saccharomyces cerevisiae*). The quantity of yeast used and the

§ 160.110

21 CFR Ch. I (4-1-07 Edition)

time of reaction are sufficient to substantially reduce the glucose content of the liquid eggs.

(c) The name of the food for which a definition and standard of identity is prescribed by this section is “Dried eggs” or “Dried whole eggs” and if the glucose content was reduced, as provided in paragraph (b) of this section, the name shall be followed immediately by the statement “Glucose removed for stability” or “Stabilized, glucose removed”.

(d)(1) When either of the optional anticaking ingredients specified in paragraph (a) of this section is used, the label shall bear the statement “Not more than 1 percent silicon dioxide added as an anticaking agent” or “Less than 2 percent sodium silicoaluminate added as an anticaking agent”, whichever is applicable.

(2) The name of any optional ingredient used, as provided in paragraph (d)(1) of this section, shall be listed on the principal display panel or panels of the label with such prominence and conspicuousness as to render such statement likely to be read and understood by the ordinary individual under customary conditions of purchase.

(e) Label declaration. Each of the ingredients used in the food shall be declared on the label as required by the applicable sections of parts 101 and 130 of this chapter.

[42 FR 14462, Mar. 15, 1977, as amended at 58 FR 2883, Jan. 6, 1993]

§ 160.110 Frozen eggs.

(a) Frozen eggs, frozen whole eggs, frozen mixed eggs is the food prepared by freezing liquid eggs that conform to § 160.115, with such precautions that the finished food is free of viable *Salmonella* microorganisms.

(b) Monosodium phosphate or monopotassium phosphate may be added either directly or in a water carrier, but the amount added does not exceed 0.5 percent of the weight of the frozen eggs. If a water carrier is used, it shall contain not less than 50 percent by weight of such monosodium phosphate or monopotassium phosphate.

(c) When one of the optional ingredients specified in paragraph (b) of this section is used, the label shall bear the statement “Monosodium phosphate (or

monopotassium phosphate) added to preserve color”, or, in case the optional ingredient used is added in a water carrier, the statement shall be “Monosodium phosphate (or monopotassium phosphate), with __ percent water as a carrier, added to preserve color”, the blank being filled in to show the percent by weight of water used in proportion to the weight of the finished food. The statement declaring the optional ingredient used shall appear on the principal display panel or panels with such prominence and conspicuousness as to render it likely to be read and understood under customary conditions of purchase.

(d) *Label declaration.* Each of the ingredients used in the food shall be declared on the label as required by the applicable sections of parts 101 and 130 of this chapter.

[42 FR 14462, Mar. 15, 1977, as amended at 58 FR 2883, Jan. 6, 1993]

§ 160.115 Liquid eggs.

(a) Liquid eggs, mixed eggs, liquid whole eggs, mixed whole eggs are eggs of the domestic hen broken from the shells and with yolks and whites in their natural proportion as so broken. They may be mixed, or mixed and strained, and they are pasteurized or otherwise treated to destroy all viable *Salmonella* microorganisms. Pasteurization or such other treatment is deemed to permit the adding of safe and suitable substances (other than chemical preservatives) that are essential to the method of pasteurization or other treatment used. For the purposes of this paragraph, safe and suitable substances are those that perform a useful function in the pasteurization or other treatment to render the liquid eggs free of viable *Salmonella* microorganisms, and that are not food additives as defined in section 201(s) of the Federal Food, Drug, and Cosmetic Act; or, if they are food additives, they are used in conformity with regulations established pursuant to section 409 of the act.

(b) *Label declaration.* Each of the ingredients used in the food shall be declared on the label as required by the

applicable sections of parts 101 and 130 of this chapter.

[42 FR 14462, Mar. 15, 1977, as amended at 58 FR 2883, Jan. 6, 1993]

§ 160.140 Egg whites.

(a) Egg whites, liquid egg whites, liquid egg albumen is the food obtained from eggs of the domestic hen, broken from the shells and separated from yolks. The food may be mixed, or mixed and strained, and is pasteurized or otherwise treated to destroy all viable *Salmonella* microorganisms. Pasteurization or such other treatment is deemed to permit the adding of safe and suitable substances (other than chemical preservatives) that are essential to the method of pasteurization or other treatment used. Safe and suitable substances that aid in protecting or restoring the whipping properties of liquid egg whites may be added. For the purposes of this paragraph, safe and suitable substances are those that perform a useful function as whipping aids or in the pasteurization or other treatment to render liquid egg whites free of viable *Salmonella* microorganisms and that are not food additives as defined in section 201(s) of the Federal Food, Drug, and Cosmetic Act; or, if they are food additives, they are used in conformity with regulations established pursuant to section 409 of the act.

(b) Any optional ingredients used as whipping aids, as provided for in paragraph (a) of this section, shall be named on the principal display panel or panels of labels with such prominence and conspicuousness as to render such names likely to be read and understood by ordinary individuals under customary conditions of purchase.

(c) *Label declaration.* Each of the ingredients used in the food shall be declared on the label as required by the applicable sections of parts 101 and 130 of this chapter.

[42 FR 14462, Mar. 15, 1977, as amended at 58 FR 2883, Jan. 6, 1993]

§ 160.145 Dried egg whites.

(a) The food dried egg whites, egg white solids, dried egg albumen, egg albumen solids is prepared by drying liquid egg whites conforming to the re-

quirements of §160.140 (or deviating from that section only by not being *Salmonella* free). As a preliminary step to drying, the lysozyme and avidin contents may be reduced. If lysozyme and avidin levels are reduced, cation exchange resins regulated for use under §173.25 of this chapter shall be used. As a further preliminary step to drying, the glucose content of the liquid egg whites is reduced by adjusting the pH, where necessary, with food-grade acid and by following one of the optional procedures set forth in paragraph (b) of this section. If the food is prepared from liquid egg whites conforming in all respects to the requirements of §160.140, drying shall be done with such precautions that the finished food is free of viable *Salmonella* microorganisms. If the food is prepared from liquid egg whites that are not *Salmonella* free, the dried product shall be so treated by heat or otherwise as to render the finished food free of viable *Salmonella* microorganisms. Dried egg whites may be powdered.

(b) The optional glucose-removing procedures are:

(1) *Enzyme procedure.* A glucose-oxidase-catalase preparation and hydrogen peroxide solution are added to liquid egg whites. The quantity used and the time of reaction are sufficient to substantially reduce the glucose content. The glucose-oxidase-catalase preparation used is one that is generally recognized as safe within the meaning of section 201(s) of the Federal Food, Drug, and Cosmetic Act. The hydrogen peroxide solution used shall comply with the specifications of the United States Pharmacopeia, except that it may exceed the concentration specified therein and it does not contain a preservative.

(2) *Controlled fermentation procedures*—(i) *Yeast procedure.* Food-grade baker's yeast (*Saccharomyces cerevisiae*) is added to the liquid egg whites and controlled fermentation is maintained. The quantity of yeast used and the time of reaction are sufficient to substantially reduce the glucose content.

(ii) *Bacterial procedure.* The liquid egg whites are subjected to the action of a culture of glucose-fermenting bacteria either generally recognized as safe within the meaning of section 201(s) of

§ 160.150

the Federal Food, Drug, and Cosmetic Act or the subject of a regulation established pursuant to section 409 of the act, and the culture is used in conformity with such regulation. The quantity of the culture used is sufficient to predominate in the fermentation and the time and temperature of reaction are sufficient to substantially reduce the glucose content.

(c)(1) Dried egg whites in which the lysozyme and avidin have been reduced shall not be nutritionally inferior, as defined in §101.3(e)(4)(i) of this chapter, and shall be considered nutritionally equivalent to untreated egg whites if they meet the conditions that the biological quality of the protein contained is equal to or greater than that of untreated egg white from the same batch of liquid egg white.

(2) Compliance with the biological quality of protein requirement of paragraph (c)(1) of this section shall be determined by the analytical method prescribed in "Official Methods of Analysis of the Association of Official Analytical Chemists," 14th Ed. (1984), section 43.253-43.257, "Protein Efficiency Ratio, Rat Bioassay, Final Action," which is incorporated by reference. Copies may be obtained from the AOAC INTERNATIONAL, 481 North Frederick Ave., suite 500, Gaithersburg, MD 20877, or may be examined at the National Archives and Records Administration (NARA). For information on the availability of this material at NARA, call 202-741-6030, or go to: http://www.archives.gov/federal_register/code_of_federal_regulations/ibr_locations.html.

(d) When the dried egg whites are prepared from liquid egg whites containing any optional ingredients added as whipping aids, as provided for in §160.140(a), the common names of such optional ingredients shall be listed on the principal display panel or panels of the label with such prominence and conspicuousness as to render the names likely to be read and understood by ordinary individuals under customary conditions of purchase.

(e) The name of the food for which a definition and standard of identity is prescribed in this section is alternatively "Dried egg whites", "Egg white solids", "Dried egg albumen", or "Egg

21 CFR Ch. I (4-1-07 Edition)

albumen solids". If the lysozyme and avidin content is reduced as provided in paragraph (a) of this section, the name shall be immediately preceded or followed by the statement "lysozyme and avidin reduced" when the dried egg whites are sold as such. When the dried egg whites are used in a fabricated food, the statement "lysozyme and avidin reduced" may be omitted from any declaration of ingredients required under §101.4 of this chapter.

(f) *Label declaration.* Each of the ingredients used in the food shall be declared on the label as required by the applicable sections of parts 101 and 130 of this chapter.

[42 FR 14462, Mar. 15, 1977, as amended at 51 FR 11435, Apr. 3, 1986; 51 FR 25362, July 14, 1986; 54 FR 24895, June 12, 1989; 58 FR 2883, Jan. 6, 1993; 63 FR 14035, Mar. 24, 1998]

§ 160.150 Frozen egg whites.

(a) Frozen egg whites, frozen egg albumen is the food prepared by freezing liquid egg whites that conform to §160.140, with such precautions that the finished food is free of viable *Salmonella* microorganisms.

(b) When frozen egg whites are prepared from liquid egg whites containing any optional ingredients added as whipping aids, as provided for in §160.140(a), the common names of such optional ingredients shall be listed on the principal display panel or panels of the label with such prominence and conspicuousness as to render such names likely to be read and understood by ordinary individuals under customary conditions of purchase.

(c) *Label declaration.* Each of the ingredients used in the food shall be declared on the label as required by the applicable sections of parts 101 and 130 of this chapter.

[42 FR 14462, Mar. 15, 1977, as amended at 58 FR 2883, Jan. 6, 1993]

§ 160.180 Egg yolks.

(a) Egg yolks, liquid egg yolks, yolks, liquid yolks are yolks of eggs of the domestic hen so separated from the whites thereof as to contain not less than 43 percent total egg solids, as determined by the method prescribed in "Official Methods of Analysis of the Association of Official Analytical Chemists," 13th Ed. (1980), sections

17.006 and 17.007 under “Total Solids, Vacuum Method (3)—Official Final Action,” which is incorporated by reference. Copies may be obtained from the AOAC INTERNATIONAL, 481 North Frederick Ave., suite 500, Gaithersburg, MD 20877, or may be examined at the National Archives and Records Administration (NARA). For information on the availability of this material at NARA, call 202-741-6030, or go to: http://www.archives.gov/federal_register/code_of_federal_regulations/ibr_locations.html. They may be mixed, or mixed and strained, and they are pasteurized or otherwise treated to destroy all viable *Salmonella* microorganisms. Pasteurization or such other treatment is deemed to permit the adding of safe and suitable substances (other than chemical preservatives) that are essential to the method of pasteurization or other treatment used. For the purposes of this paragraph, safe and suitable substances are those that perform a useful function in the pasteurization or other treatment to render the egg yolks free of viable *Salmonella* microorganisms, and that are not food additives as defined in section 201(s) of the Federal Food, Drug, and Cosmetic Act; or, if they are food additives, they are used in conformity with regulations established pursuant to section 409 of the act.

(b) *Label declaration.* Each of the ingredients used in the food shall be declared on the label as required by the applicable sections of parts 101 and 130 of this chapter.

[42 FR 14462, Mar. 15, 1977, as amended at 47 FR 11832, Mar. 19, 1982; 49 FR 10102, Mar. 19, 1984; 54 FR 24895, June 12, 1989; 58 FR 2883, Jan. 6, 1993; 63 FR 14035, Mar. 24, 1998]

§ 160.185 Dried egg yolks.

(a) Dried egg yolks, dried yolks is the food prepared by drying egg yolks that conform to §160.180, with such precautions that the finished food is free of viable *Salmonella* microorganisms. Before drying, the glucose content of the liquid egg yolks may be reduced by one of the optional procedures set forth in paragraph (b) of this section. Either silicon dioxide complying with the provisions of §172.480 of this chapter or sodium silicoaluminate may be added as an optional anticaking ingredient, but

the amount of silicon dioxide used is not more than 1 percent and the amount of sodium silicoaluminate used is less than 2 percent by weight of the finished food. The finished food shall contain not less than 95 percent by weight total egg solids.

(b) The optional glucose-removing procedures are:

(1) *Enzyme procedure.* A glucose-oxidase-catalase preparation and hydrogen peroxide solution are added to the liquid egg yolks. The quantity used and the time of reaction are sufficient to substantially reduce the glucose content of the liquid egg yolks. The glucose-oxidase-catalase preparation used is one that is generally recognized as safe within the meaning of section 201(s) of the Federal Food, Drug, and Cosmetic Act. The hydrogen peroxide solution used shall comply with the specification of the United States Pharmacopeia, except that it may exceed the concentration specified therein and it does not contain a preservative.

(2) *Yeast procedure.* The pH of the liquid egg yolks is adjusted to the range of 6.0 to 7.0, if necessary, by the addition of dilute, chemically pure hydrochloric acid, and controlled fermentation is maintained by adding food-grade baker's yeast (*Saccharomyces cerevisiae*). The quantity of yeast used and the time of reaction are sufficient to substantially reduce the glucose content of the liquid egg yolks.

(c) The name of the food for which a definition and standard of identity is prescribed by this section is “Dried egg yolks”, or “Dried yolks”, and if the glucose content was reduced, as provided in paragraph (b) of this section, the name shall be followed immediately by the statement “Glucose removed for stability” or “Stabilized, glucose removed”.

(d)(1) When either of the optional anticaking ingredients specified in paragraph (a) of this section is used, the label shall bear the statement “Not more than 1 percent silicon dioxide added as an anticaking agent” or “Less than 2 percent sodium silicoaluminate added as an anticaking agent”, whichever is applicable.

(2) The name of any optional ingredient used, as provided in paragraph

§ 160.190

(d)(1) of this section, shall be listed on the principal display panel or panels of the label with such prominence and conspicuousness as to render such statement likely to be read and understood by the ordinary individual under customary conditions of purchase.

(e) *Label declaration.* Each of the ingredients used in the food shall be declared on the label as required by the applicable sections of parts 101 and 130 of this chapter.

[42 FR 14462, Mar. 15, 1977, as amended at 58 FR 2883, Jan. 6, 1993]

§ 160.190 Frozen egg yolks.

(a) Frozen egg yolks, frozen yolks is the food prepared by freezing egg yolks that conform to § 160.180, with such precautions that the finished food is free of viable *Salmonella* microorganisms.

(b) *Label declaration.* Each of the ingredients used in the food shall be declared on the label as required by the applicable sections of parts 101 and 130 of this chapter.

[42 FR 14462, Mar. 15, 1977, as amended at 58 FR 2884, Jan. 6, 1993]

PART 161—FISH AND SHELLFISH

Subpart A—General Provisions

Sec.

161.30 Declaration of quantity of contents on labels for canned oysters.

Subpart B—Requirements for Specific Standardized Fish and Shellfish

- 161.130 Oysters.
- 161.136 Olympia oysters.
- 161.145 Canned oysters.
- 161.170 Canned Pacific salmon.
- 161.173 Canned wet pack shrimp in transparent or nontransparent containers.
- 161.175 Frozen raw breaded shrimp.
- 161.176 Frozen raw lightly breaded shrimp.
- 161.190 Canned tuna.

AUTHORITY: 21 U.S.C. 321, 341, 343, 348, 371, 379e.

SOURCE: 42 FR 14464, Mar. 15, 1977, unless otherwise noted.

Subpart A—General Provisions

§ 161.30 Declaration of quantity of contents on labels for canned oysters.

(a) For many years packers of canned oysters in the Gulf area of the United

States have labeled their output with a declaration of the drained weight of oysters in the containers. Packers in other areas have marketed canned oysters with a declaration of the total weight of the contents of the container. Investigation reveals that under present-day practice consumers generally do not discard the liquid packing medium, but use it as a part of the food. Section 403(e)(2) of the Federal Food, Drug, and Cosmetic Act and the regulations thereunder require food in package form to bear an accurate label statement of the quantity of food in the container.

(b) It is concluded that compliance with the label declaration of quantity of contents requirement will be met by an accurate declaration of the total weight of the contents of the can. The requirements of § 161.145(c), establishing a standard of fill of container for canned oysters and specifying the statement of substandard fill for those canned oysters failing to meet that standard remain unaffected by this interpretation.

Subpart B—Requirements for Specific Standardized Fish and Shellfish

§ 161.130 Oysters.

(a) Oysters, raw oysters, shucked oysters, are the class of foods each of which is obtained by shucking shell oysters and preparing them in accordance with the procedure prescribed in paragraph (b) of this section. The name of each such food is the name specified in the applicable definition and standard of identity prescribed in §§ 161.131 to 161.140, inclusive.

(b) If water, or salt water containing less than 0.75 percent salt, is used in any vessel into which the oysters are shucked the combined volume of oysters and liquid when such oysters are emptied from such vessel is not less than four times the volume of such water or salt water. Any liquid accumulated with the oysters is removed. The oysters are washed, by blowing or otherwise, in water or salt water, or both. The total time that the oysters are in contact with water or salt water after leaving the shucker, including the time of washing, rinsing, and any

other contact with water or salt water is not more than 30 minutes. In computing the time of contact with water or salt water, the length of time that oysters are in contact with water or salt water that is agitated by blowing or otherwise, shall be calculated at twice its actual length. Any period of time that oysters are in contact with salt water containing not less than 0.75 percent salt before contact with oysters, shall not be included in computing the time that the oysters are in contact with water or salt water. Before packing into the containers for shipment or other delivery for consumption the oysters are thoroughly drained and are packed without any added substance.

(c) For the purposes of this section:

(1) *Shell oysters* means live oysters of any of the species, *Ostrea virginica*, *Ostrea gigas*, *Ostrea lurida*, in the shell, which, after removal from their beds, have not been floated or otherwise held under conditions which result in the addition of water.

(2) *Thoroughly drained* means one of the following:

(i) The oysters are drained on a strainer or skimmer which has an area of not less than 300 square inches per gallon of oysters, drained, and has perforations of at least ¼ of an inch in diameter and not more than 1¼ inches apart, or perforations of equivalent areas and distribution. The oysters are distributed evenly over the draining surface of the skimmer and drained for not less than 5 minutes; or

(ii) The oysters are drained by any method other than that prescribed by paragraph (c)(2)(i) of this section whereby liquid from the oysters is removed so that when the oysters are tested within 15 minutes after packing by draining a representative gallon of oysters on a skimmer of the dimensions and in the manner described in paragraph (c)(2)(i) of this section for 2 minutes, not more than 5 percent of liquid by weight is removed by such draining.

§ 161.136 Olympia oysters.

Olympia oysters, raw Olympia oysters, shucked Olympia oysters, are of the species *Ostrea lurida* and conform

to the definition and standard of identity prescribed for oysters in § 161.130.

§ 161.145 Canned oysters.

(a) *Identity*. (1) Canned oysters is the food prepared from one or any mixture of two or all of the forms of oysters specified in paragraph (a)(2) of this section, and a packing medium of water, or the watery liquid draining from oysters before or during processing, or a mixture of such liquid and water. The food may be seasoned with salt. It is sealed in containers and so processed by heat as to prevent spoilage.

(2) The forms of oysters referred to in paragraph (a)(1) of this section are prepared from oysters which have been removed from their shells and washed and which may be steamed while in the shell or steamed or blanched or both after removal therefrom, and are as follows:

(i) Whole oysters with such broken pieces of oysters as normally occur in removing oysters from their shells, washing, and packing.

(ii) Pieces of oysters obtained by segregating pieces of oysters broken in shucking, washing, or packing whole oysters.

(iii) Cut oysters obtained by cutting whole oysters.

(3)(i) When the form of oysters specified in paragraph (a)(2)(i) of this section is used, the name of the food is "Oysters" or "Cove oysters", if of the species *Ostrea virginica*; "Oysters" or "Pacific oysters", if of the species *Ostrea gigas*; "Oysters" or "Olympia oysters", if of the species *Ostrea lurida*.

(ii) When the form of oysters specified in paragraph (a)(2)(ii) of this section is used, the name of the food is "Pieces of _____", the blank being filled in with the name "Oysters" or "Cove oysters", if of the species *Ostrea virginica*; "Oysters" or "Pacific oysters", if of the species *Ostrea gigas*; "Oysters" or "Olympia oysters", if of the species *Ostrea lurida*.

(iii) When the form of oysters specified in paragraph (a)(2)(iii) of this section is used, the name of the food is "Cut _____", the blank being filled in with the name "Oysters" or "Cove oysters", if of the species *Ostrea virginica*; "Oysters" or "Pacific oysters", if of the species *Ostrea gigas*; "Oysters" or

§ 161.170

21 CFR Ch. I (4-1-07 Edition)

“Olympia oysters”, if of the species *Ostrea lurida*.

(iv) In case a mixture of two or all such forms of oysters is used, the name is a combination of the names specified in this paragraph (a)(3) of the forms of oysters used, arranged in order of their predominance by weight.

(4) Label declaration. Each of the ingredients used in the food shall be declared on the label as required by the applicable sections of parts 101 and 130 of this chapter.

(b) [Reserved]

(c) *Fill of container.* (1) The standard of fill of container for canned oysters is a fill such that the drained weight of oysters taken from each container is not less than 59 percent of the water capacity of the container.

(2) Water capacity of containers is determined by the general method provided in §130.12(a) of this chapter.

(3) Drained weight is determined by the following method: Keep the unopened canned oyster container at a temperature of not less than 68° or more than 95 °Fahrenheit for at least 12 hours immediately preceding the determination. After opening, tilt the container so as to distribute its contents evenly over the meshes of a circular sieve which has been previously weighed. The diameter of the sieve is 8 inches if the quantity of the contents of the container is less than 3 pounds, and 12 inches if such quantity is 3 pounds or more. The bottom of the sieve is woven-wire cloth that complies with the specifications for such cloth set forth under “2.38 mm (No. 8)” in “Official Methods of Analysis of the Association of Official Analytical Chemists,” 13th Ed. (1980), Table 1, “Nominal Dimensions of Standard Test Sieves (U.S.A. Standard Series),” under the heading “Definitions of Terms and Explanatory Notes,” which is incorporated by reference. Copies may be obtained from the AOAC INTERNATIONAL, 481 North Frederick Ave., suite 500, Gaithersburg, MD 20877, or may be examined at the National Archives and Records Administration (NARA). For information on the availability of this material at NARA, call 202-741-6030, or go to: http://www.archives.gov/federal_register/code_of_federal_regulations/

ibr_locations.html. Without shifting the material on the sieve, so incline the sieve as to facilitate drainage. Two minutes from the time drainage begins, weigh the sieve and the drained oysters. The weight so found, less the weight of the sieve, shall be considered to be the drained weight of the oysters.

(4) If canned oysters fall below the standard of fill of container prescribed in paragraph (a) of this section, the label shall bear the general statement of substandard fill specified in §130.14(b) of this chapter in the manner and form therein specified, followed by the statement, “A can of this size should contain _____ oz. of oysters. This can contains only _____ oz.”, the blanks being filled in with the applicable figures.

[42 FR 14464, Mar. 15, 1977, as amended at 47 FR 11832, Mar. 19, 1982; 49 FR 10102, Mar. 19, 1984; 54 FR 24895, June 12, 1989; 58 FR 2884, Jan. 6, 1993; 63 FR 14035, Mar. 24, 1998]

§ 161.170 Canned Pacific salmon.

(a) *Identity.* (1) Canned Pacific salmon is the food prepared from one of the species of fish enumerated in paragraph (a)(2) of this section, prepared in one of the forms of pack specified in paragraph (a)(3) of this section, and to which may be added one or more of the optional ingredients specified in paragraph (a)(4) of this section. The food is packed in hermetically sealed containers and so processed by heat as to prevent spoilage and soften bones. The food is labeled in accordance with paragraph (a)(5) of this section.

(2)(i) The species of fish which may be used in this food are:

<i>Oncorhynchus tshawytscha</i>	Chinook, king, spring.
<i>Oncorhynchus nerka</i>	Blueback, red, sockeye
<i>Oncorhynchus kisutch</i>	Coho, Cohoe, medium red, silver
<i>Oncorhynchus gorbuscha</i>	Pink
<i>Oncorhynchus keta</i>	Chum, keta
<i>Oncorhynchus masou</i>	Masou, cherry

(ii) For the purpose of paragraph (a)(5)(i) of this section, the common or usual name or names of each species of fish enumerated in paragraph (a)(2)(i) of this section is (are) the name(s) immediately following the scientific name of each species.

(3) The optional forms of canned Pacific salmon are processed from fish prepared by removing the head, gills,

and tail, and the viscera, blood, fins, and damaged or discolored flesh to the greatest extent practicable in accordance with good manufacturing practice; and then washing. Canned Pacific salmon is prepared in one of the following forms of pack:

(i) "Regular" consists of sections or steaks which are cut transversely from the fish and filled vertically into the can. In preparation, segments of skin or large backbone may be removed. The sections or steaks are so packed that the cut surfaces approximately parallel the ends of the container. A small portion of salmon may be added if necessary to complete the fill of the container.

(ii) "Skinless and backbone removed" consists of the regular form of canned salmon set forth in paragraph (a)(3)(i) of this section from which the skin and vertebrae have been removed in accordance with good manufacturing practices.

(iii) "Minced salmon" consists of salmon which has been minced or ground.

(iv) "Salmon tips or tidbits" consists of small pieces of salmon.

(v) "No salt added" consists of canned salmon to which no salt has been added.

(4) One or more of the following optional ingredients may be added to the food:

- (i) Salt.
- (ii) Edible salmon oil comparable in color, viscosity, and flavor to the oil which would occur naturally in the species of salmon canned.

(5)(i) The name of the food is "salmon" together with the common or usual name or names of the species. At least one species name shall be printed in letters of the same style of type and not less in height than those used for the word "salmon".

(ii)(a) Whenever the form of pack is that described in paragraph (a)(3) (ii), (iii), or (iv) of this section, the word or words describing the form of pack shall immediately precede or follow the name of the food without intervening written, printed, or graphic matter in the manner prescribed in §101.3(c) of this chapter; for example, "red salmon" as the name of the food followed by "skinless and backbone removed".

(b) Whenever the form of pack is that described in paragraph (a)(3)(v) of this section and words describing the form of pack are declared on the label, the label shall also bear the statements required by §105.69 of this chapter.

(iii) Label declaration. Each of the ingredients used in the food shall be declared on the label as required by the applicable sections of parts 101 and 130 of this chapter.

(b) [Reserved]

(c) *Fill of container.* (1) The standard of fill of container for canned salmon is a fill including all the contents of the container and is not less than the minimum net weight specified for the corresponding can size in the following table:

I. Can size	II. Minimum net weight
603×405	1,814 kg (64 oz).
301×411	454 g (16 oz).
301×408	439 g (15½ oz).
401×211	439 g (15½ oz).
607×406×108	439 g (15½ oz).
301×308	340 g (12 oz).
307×200.25	220 g (7¾ oz).
513×307×103	220 g (7¾ oz).
307×113	191 g (6¾ oz).
301×106	106 g (3¾ oz).
407×213×015	106 g (3¾ oz).

If the can size in question is not listed, calculate the value for Column II as follows: From the list, select as the comparable can size, that one having the nearest water capacity of the can size in question, multiply the net weight listed in Column II by the water capacity of the can size in question, and divide by the water capacity of the comparable can size. Water capacities are determined by the general method provided in §130.12(a) of this chapter.

(2) Sampling and acceptance procedure: The sample size of the sample representing the lot will be selected in accordance with the sampling plan shown in paragraph (c)(2)(ii) of this section. A lot is to be considered acceptable when the average net weight of all the sample units is not less than the minimum net weight stated in paragraph (c)(1) of this section for the corresponding can size.

(i) Definitions of terms to be used in the sampling plans in paragraph (c)(2)(ii) of this section are as follows:

(a) *Lot.* A collection of primary containers or units of the same size, type,

§ 161.173

21 CFR Ch. I (4-1-07 Edition)

and style manufactured or packed under similar conditions and handled as a single unit of trade.

(b) *Lot size.* The number of primary containers or units in the lot.

(c) *Sample size (n).* The total number of sample units drawn for examination from a lot.

(d) *Sample unit.* A container, the entire contents of a container, a portion of the contents of a container, or a composite mixture of product from small containers that is sufficient for examination or testing as a single unit.

(ii) Sampling plans:

Lot size (primary containers)	Size of container ¹ (n)
4,800 or less	13
4,801 to 24,000	21
24,001 to 48,000	29
48,001 to 84,000	48
84,001 to 144,000	84
144,001 to 240,000	126
Over 240,000	200

¹ Net weight equal to or less than 1 kg. (2.2 lb).

Lot size (primary containers)	Size of container ¹ (n)
2,400 or less	13
2,401 to 15,000	21
15,001 to 24,000	29
24,001 to 42,000	48
42,001 to 72,000	84
72,001 to 120,000	126
Over 120,000	200

n-number of primary containers in sample.

¹ Net weight greater than 1 kg (2.2 lb) but not more than 4.5 kgs (10 lb).

(3) If canned salmon falls below the standard of fill of container prescribed in paragraph (c)(1) of this section, the label shall bear the general statement of substandard fill specified in §130.14(b) of this chapter, in the manner and form therein specified.

[42 FR 14464, Mar. 15, 1977, as amended at 58 FR 2884, Jan. 6, 1993]

§ 161.173 Canned wet pack shrimp in transparent or nontransparent containers.

(a) *Identity.* (1) Canned wet pack shrimp is the food consisting of the processed meat of peeled shrimp, free of heads and, to the extent practicable under good manufacturing practice, free of shells, legs, and antennae; in one or any combination of species enumerated in paragraph (a)(2) of this section; prepared in one of the styles spec-

ified in paragraph (a)(3) of this section, in sufficient water or other suitable aqueous packing medium to fill the interstices and permit proper processing in accordance with good manufacturing practice. Canned shrimp may contain one or more of the optional ingredients specified in paragraph (a)(4) of this section. It is packed in hermetically sealed transparent or nontransparent containers and so processed by heat as to prevent spoilage.

(2) The species of shrimp that may be used in the food are of the families: Penaeidae, Pandalidae, Crangonidae, and Palaemonidae.

(3) *Styles.* Canned shrimp is prepared in one of the following styles:

(i) Shrimp with readily visible dark vein (dorsal tract, back vein, or sand vein).

(ii) Deveined shrimp containing not less than 95 percent by weight of shrimp prepared by removing the dark vein from the first five segments by deliberate cutting action.

(iii) Shrimp, other than “deveined” as described in paragraph (a)(3)(ii) of this section, containing not less than 95 percent by weight of shrimp with no readily visible dark vein within the first five segments.

(iv) Broken shrimp, consisting of less than four segments and otherwise conforming to one of the styles described in paragraph (a)(3)(i), (ii), or (iii) of this section.

(4) *Optional ingredients.* The following safe and suitable optional ingredients may be used:

(i) Salt.
 (ii) Lemon juice.
 (iii) Organic acids.
 (iv) Nutritive carbohydrate sweeteners.

(v) Spices or spice oils or spice extracts.

(vi) Flavorings.
 (vii) Sodium bisulfite.

(viii) Calcium disodium EDTA (calcium disodium ethylenediaminetetraacetate), complying with the provisions of §172.120 of this chapter.

(5) *Labeling.* (i) The name of the food is “shrimp” or “shrimps.” The word “prawns” may appear on the label in parentheses immediately after the word “shrimp” or “shrimps” if the shrimp are of large or extra large size

as designated in paragraph (a)(5)(iv) of this section.

(ii) When the food is of the style described in paragraph (a)(3)(ii) of this section, the words “cleaned,” “cleaned (deveined),” or “deveined” may be declared on the label.

(iii) When the food is of the style described in paragraph (a)(3)(iii) of this section, the words “contain no dark

veins” or their equivalent may be declared on the label.

(iv) When the food is whole shrimp within a size range designated in table I as “extra large,” “large,” “medium,” or “small” and does not contain broken shrimp as defined in paragraph (a)(3)(iv) of this section in excess of the amount listed in table II for the applicable size, the appropriate size designation may be declared on the label.

TABLE I

Size	Number of shrimp per 28.4 g (1 oz) of drained product		Number of shrimp per 100 g (3.5 oz) of drained product	
	Other than deveined style	Deveined style	Other than deveined style	Deveined style
Extra large or jumbo	Less than 3.5	Less than 3.8	Less than 12.3	Less than 13.4.
Large	3.5 to 5.0 inclusive	3.8 to 5.4 inclusive	12.3 to 17.7 inclusive	13.4 to 19.1 inclusive.
Medium	More than 5.0 but not more than 9.0.	More than 5.4 but not more than 9.8.	More than 17.7 but not more than 31.8.	More than 19.1 but not more than 34.6.
Small	More than 9.0 but not more than 17.0.	More than 9.8 but not more than 18.4.	More than 31.8 but not more than 60.0.	More than 34.6 but not more than 65.3.
Tiny	More than 17.0	More than 18.4	More than 60.0	More than 65.3.

TABLE II

Size	Maximum percent by weight of broken shrimp ^a
Extra large or jumbo	5
Large	5
Medium	5
Small	10
Tiny	15

^aGrams of broken shrimp per 100 g of cut-out weight as determined in §161.173(c) of this section.

(v) When the food consists of tiny shrimp, as designated in table I in paragraph (a)(5)(iv) of this section and does not contain broken shrimp as defined in paragraph (a)(3)(iv) of this section in excess of 15 percent by weight, the name of the food on the label shall be accompanied by the word “tiny” in type size equal to that used in the name of the food.

(vi) When the food consists of tiny shrimp, as designated in table I in paragraph (a)(5)(iv) of this section and contains more than 15 percent by weight of broken shrimp as defined in paragraph (a)(3)(iv) of this section, the name of the food on the label shall be accompanied by the word “broken” or “pieces” rather than the word “tiny,” in type size equal to that used in the name of the food.

(vii) When the food consists wholly or in part of sizes other than tiny, as des-

ignated in table I in paragraph (a)(5)(iv) of this section and contains more than 10 percent by weight of broken shrimp as defined in paragraph (a)(3)(iv) of this section, the name of the food on the label shall be accompanied by the word “broken” or “pieces” in type size equal to that used in the name of the food.

(viii) The name of the food shall include a declaration of any flavoring that characterizes the food, as specified in §101.22 of this chapter, and the term “spiced” if spice characterizes the food.

(ix) *Label declaration.* Each of the ingredients used in the food shall be declared on the label as required by the applicable sections of parts 101 and 130 of this chapter.

(6) *Sampling and acceptance procedure.* A lot is to be considered acceptable when the number of defectives does not exceed the acceptance number in the sampling plans given in paragraph (a)(6)(ii) of this section.

(i) Definitions of terms to be used in the sampling plans in paragraph (a)(6)(ii) of this section are as follows:

(a) *Lot.* A collection of primary containers or units of the same size, type, and style manufactured or packed under similar conditions and handled as a single unit of trade.

(b) *Lot size.* The number of primary containers or units in the lot.

(c) *Sample size (n).* The total number of sample units drawn for examination from a lot.

(d) *Sample unit.* A container, the entire contents of a container, a portion of the contents of a container, or a composite mixture of product from small containers that is sufficient for the examination or testing as a single unit.

(e) *Defective.* Any sample unit shall be regarded as defective when it fails to meet the minimum requirements in paragraph (a)(3) (ii) or (iii) of this section for the applicable style, when it exceeds the tolerances in paragraph (a)(5)(iv) of this section for the applicable size, or when the labeling fails to meet the requirements of paragraph (a)(5) (v), (vi), or (vii) of this section of the applicable size.

(f) *Acceptance number (c).* The maximum number of defective sample units permitted in the sample in order to consider the lot as meeting the specified requirements.

(g) *Acceptable quality level (AQL).* The maximum percent of defective sample units permitted in a lot that will be accepted approximately 95 percent of the time.

(ii) Sampling plans:

ACCEPTABLE QUALITY LEVEL 6.5

Lot size (primary containers)	Size of container	
	n ¹	c ²
NET WEIGHT EQUAL TO OR LESS THAN 1 KG (2.2 LB)		
4,800 or less	13	2
4,801 to 24,000	21	3
24,001 to 48,000	29	4
48,001 to 84,000	48	6
84,001 to 144,000	84	9
144,001 to 240,000	126	13
Over 240,000	200	19
NET WEIGHT GREATER THAN 1 KG (2.2 LB) BUT NOT MORE THAN 4.5 KG (10 LB)		
2,400 or less	13	2
2,401 to 15,000	21	3
15,001 to 24,000	29	4
24,001 to 42,000	48	6
42,001 to 72,000	84	9
72,001 to 120,000	126	13
Over 120,000	200	19

¹ n=Number of primary containers in sample.
² c=Acceptance number.

(b) [Reserved]

(c) *Fill of container.* (1) The standard of fill of transparent or nontransparent containers for canned wet pack shrimp is a fill such that the cut-out weight of shrimp taken from each container is not less than 60 percent of the weight of the water required to fill the container. The weight of the water required to fill the container is determined by the general method provided in §130.12(a) of this chapter. Cut-out weight is determined by the following method: Keep the unopened canned shrimp container at a temperature of not less than 68° nor more than 75 °Fahrenheit for at least 12 hours immediately preceding the determination. After opening, distribute the shrimp evenly over the meshes of a circular sieve that has been previously weighed. The diameter of the sieve is 20.3 centimeters (8 inches) if the quantity of the contents of the container is less than 1.36 kilograms (3 pounds), and 30.5 centimeters (12 inches), if such quantity is 1.36 kilograms (3 pounds) or more. The bottom of the sieve is woven-wire cloth that complies with the specifications for such cloth set forth as a 2.38 mm (No. 8) sieve in the "Definitions of Terms and Explanatory Notes" of the "Official Methods of Analysis of the Association of Official Analytical Chemists," 13th Ed. (1980), which is incorporated by reference. Copies may be obtained from the AOAC INTERNATIONAL, 481 North Frederick Ave., suite 500, Gaithersburg, MD 20877, or may be examined at the National Archives and Records Administration (NARA). For information on the availability of this material at NARA, call 202-741-6030, or go to: http://www.archives.gov/federal_register/code_of_federal_regulations/ibr_locations.html. Without shifting the material on the sieve, incline the sieve at an angle of approximately 17° to 20° to facilitate drainage. Allow the shrimp to drain for 2 minutes, measured from the moment the product is poured onto the sieve. Weigh the sieve and the drained shrimp. The weight so found, less the weight of the sieve, shall be considered to be the cut-out weight of the shrimp.

(2) Sampling and acceptance procedure: A container that falls below the

requirement for minimum fill prescribed in paragraph (c)(1) of this section is considered a “defective.” Determine compliance with paragraph (c)(1) of this section as specified in paragraph (a)(6) of this section except that the sample unit shall be the entire contents of the container.

(3) If canned wet pack shrimp in transparent or nontransparent containers falls below the applicable standard of fill of container prescribed in paragraph (c)(1) of this section, the label shall bear the general statement of substandard fill provided in §130.14(b) of this chapter, in the manner and form therein specified.

[43 FR 19840, May 9, 1978; 43 FR 25423, June 13, 1978, as amended at 47 FR 11833, Mar. 19, 1982; 49 FR 10102, Mar. 19, 1984; 54 FR 24896, June 12, 1989; 58 FR 2884, Jan. 6, 1994; 63 FR 14035, Mar. 24, 1998]

EFFECTIVE DATE NOTE: Paragraphs (a) and (c) of §161.173 were stayed until further notice by a document published at 44 FR 50328, Aug. 28, 1979.

§ 161.175 Frozen raw breaded shrimp.

(a) Frozen raw breaded shrimp is the food prepared by coating one of the optional forms of shrimp specified in paragraph (c) of this section with safe and suitable batter and breading ingredients as provided in paragraph (d) of this section. The food is frozen.

(b) The food tests not less than 50 percent of shrimp material as determined by the method prescribed in paragraph (g) of this section, except that if the shrimp are composite units the method prescribed in paragraph (h) of this section is used.

(c) The term *shrimp* means the tail portion of properly prepared shrimp of commercial species. Except for composite units, each shrimp unit is individually coated. The optional forms of shrimp are:

(1) Fantail or butterfly: Prepared by splitting the shrimp; the shrimp are peeled, except that tail fins remain attached and the shell segment immediately adjacent to the tail fins may be left attached.

(2) Butterfly, tail off: Prepared by splitting the shrimp; tail fins and all shell segments are removed.

(3) Round: Round shrimp, not split; the shrimp are peeled, except that tail

fins remain attached and the shell segment immediately adjacent to the tail fins may be left attached.

(4) Round, tail off: Round shrimp, not split; tail fins and all shell segments are removed.

(5) Pieces: Each unit consists of a piece or a part of a shrimp; tail fins and all shell segments are removed.

(6) Composite units: Each unit consists of two or more whole shrimp or pieces of shrimp, or both, formed and pressed into composite units prior to coating; tail fins and all shell segments are removed; large composite units, prior to coating, may be cut into smaller units.

(d) The batter and breading ingredients referred to in paragraph (a) of this section are the fluid constituents and the solid constituents of the coating around the shrimp. These ingredients consist of suitable substances which are not food additives as defined in section 201(s) of the Federal Food, Drug, and Cosmetic Act; or if they are food additives as so defined, they are used in conformity with regulations established pursuant to section 409 of the act. Batter and breading ingredients that perform a useful function are regarded as suitable, except that artificial flavorings, artificial sweeteners, artificial colors, and chemical preservatives, other than those provided for in this paragraph, are not suitable ingredients of frozen raw breaded shrimp. Chemical preservatives that are suitable are:

(1) Ascorbic acid, which may be used in a quantity sufficient to retard development of dark spots on the shrimp; and

(2) The antioxidant preservatives listed in subpart D of part 182 of this chapter that may be used to retard development of rancidity of the fat content of the food, in amounts within the limits prescribed by that section.

(e) The label shall name the food, as prepared from each of the optional forms of shrimp specified in paragraph (c) (1) to (6), inclusive, of this section, and following the numbered sequence of such subparagraph, as follows:

(1) “Breaded fantail shrimp.” The word “butterfly” may be used in lieu of “fantail” in the name.

(2) "Breaded butterfly shrimp, tail off."

(3) "Breaded round shrimp."

(4) "Breaded round shrimp, tail off."

(5) "Breaded shrimp pieces."

(6) Composite units:

(i) If the composite units are in a shape similar to that of breaded fish sticks the name is "Breaded shrimp sticks"; if they are in the shape of meat cutlets, the name is "Breaded shrimp cutlets".

(ii) If prepared in a shape other than that of sticks or cutlets, the name is "Breaded shrimp _____", the blank to be filled in with the word or phrase that accurately describes the shape, but which is not misleading.

In the case of the names specified in paragraphs (e) (1) through (5) of this section, the words in each name may be arranged in any order, provided they are so arranged as to be accurately descriptive of the food. The word "prawns" may be added in parentheses immediately after the word "shrimp" in the name of the food if the shrimp are of large size; for example, "Fantail breaded shrimp (prawns)". If the shrimp are from a single geographical area, the adjectival designation of that area may appear as part of the name; for example, "Breaded Alaskan shrimp sticks".

(f) The names of the optional ingredients used, as provided for in paragraph (d) of this section, shall be listed on the principal display panel or panels of the label with such prominence and conspicuousness as to render them likely to be read and understood by the ordinary individual under customary conditions of purchase. If a spice that also imparts color is used, it shall be designated as "spice and coloring", unless the spice is designated by its specific name. If ascorbic acid is used to retard development of dark spots on the shrimp, it shall be designated as "Ascorbic acid added as a preservative" or "Ascorbic acid added to retard discoloration of shrimp". If any other antioxidant preservative, as provided in paragraph (d) of this section, is used, such preservative shall be designated by its common name followed by the statement "Added as a preservative".

(g) The method for determining percentage of shrimp material for those

forms specified in paragraphs (c) (1) through (5) of this section is as follows:

(1) *Equipment needed.* (i) Two-gallon container, approximately 9 inches in diameter.

(ii) Two-vaned wooden paddle, each vane measuring approximately 1¾ inches by 3¾ inches.

(iii) Stirring device capable of rotating the wooden paddle at 120 r.p.m.

(iv) Balance accurate to 0.01 ounce (or 0.1 gram).

(v) U.S. Standard Sieve No. 20, 30.5 centimeter (12 inch) diameter. The sieves shall comply with the specifications for such cloth set forth in "Official Methods of Analysis of the Association of Official Analytical Chemists" (AOAC), 13th Ed. (1980), Table 1, "Nominal Dimensions of Standard Test Sieves (U.S.A. Standard Series)," under the heading "Definitions of Terms and Explanatory Notes," which is incorporated by reference. Copies may be obtained from the AOAC INTERNATIONAL, 481 North Frederick Ave., suite 500, Gaithersburg, MD 20877, or may be examined at the National Archives and Records Administration (NARA). For information on the availability of this material at NARA, call 202-741-6030, or go to: http://www.archives.gov/federal_register/code_of_federal_regulations/ibr_locations.html.

(vi) U.S. Standard sieve, ½-inch sieve opening, 12-inch diameter.

(vii) Forceps, blunt points.

(viii) Shallow baking pans.

(ix) Rubber-tipped glass stirring rod.

(2) *Procedure.* (1) Weigh the sample to be debreaded. Fill the container three-fourths full of water at 70°-80 °F. Suspend the paddle in the container, leaving a clearance of at least 5 inches below the paddle vanes, and adjust speed to 120 r.p.m. Add shrimp and stir for 10 minutes. Stack the sieves, the ½-inch mesh over the No. 20, and pour the contents of the container onto them. Set the sieves under a faucet, preferably with spray attached, and rinse shrimp with no rubbing of flesh, being careful to keep all rinsings over the sieves and not having the stream of water hit the shrimp on the sieve directly. Lay the shrimp out singly on the sieve as rinsed. Inspect each shrimp and use the rubber-tipped rod and the

spray to remove the breading material that may remain on any of them, being careful to avoid undue pressure or rubbing, and return each shrimp to the sieve. Remove the top sieve and drain on a slope for 2 minutes, then remove the shrimp to weighing pan. Rinse contents of the No. 20 sieve onto a flat pan and collect any particles other than breading (i.e., flesh and tail fins) and add to shrimp on balance pan and weigh.

(ii) Calculate percent shrimp material:

$$\text{Percent shrimp material} = \frac{\text{Weight of debreaded sample}}{\text{Weight of sample}} \times 100 + 2$$

(h) The method for determining percentage of shrimp material for composite units, specified in paragraph (c)(6) of this section, is as follows:

(1) *Equipment needed.* (i) Water bath (for example a 3-liter to 4-liter beaker).

(ii) Balance accurate to 0.1 gram.

(iii) Clip tongs of wire, plastic, or glass.

(iv) Stop-watch or regular watch readable to a second.

(v) Paper towels.

(vi) Spatula, 4-inch blade with rounded tip.

(vii) Nut picker.

(viii) Thermometer (immersion type) accurate to ± 2 °F.

(ix) Copper sulfate crystals ($\text{CuSO}_4 \cdot 5\text{H}_2\text{O}$).

(2) *Procedure.* (i) Weigh all composite units in the sample while they are still hard frozen.

(ii) Place each composite unit individually in a water bath that is maintained at 63 °F–86 °F, and allow to remain until the breading becomes soft and can easily be removed from the still frozen shrimp material (between 10 seconds to 80 seconds for composite units held in storage at 0 °F). If the composite units were prepared using batters that are difficult to remove after one dipping, redip them for up to 5 seconds after the initial debreading and remove residual batter materials.

NOTE: Several preliminary trials may be necessary to determine the exact dip time required for “debreading” the composite units in a sample. For these trials only, a saturated solution of copper sulfate (1 pound of copper sulfate in 2 liters of tap water) is

necessary. The correct dip time is the minimum time of immersion in the copper sulfate solution required before the breading can easily be scraped off: *Provided*, That the “debreaded” units are still solidly frozen and only a slight trace of blue color is visible on the surface of the “debreaded” shrimp material.

(iii) Remove the unit from the bath; blot lightly with double thickness of paper toweling; and scrape off or pick out coating from the shrimp material with the spatula or nut picker.

(iv) Weigh all the “debreaded” shrimp material.

(v) Calculate the percentage of shrimp material in the sample, using the following formula:

$$\text{Percent shrimp material} = \frac{\text{Weight of debreaded shrimp sample}}{\text{Weight of sample}} \times 100$$

(i) *Label declaration.* Each of the ingredients used in the food shall be declared on the label as required by the applicable sections of parts 101 and 130 of this chapter.

[42 FR 14464, Mar. 15, 1977, as amended at 47 FR 11833, Mar. 19, 1982; 49 FR 10102, Mar. 19, 1984; 54 FR 24896, June 12, 1989; 58 FR 2884, Jan. 6, 1993; 63 FR 14035, Mar. 24, 1998]

§ 161.176 Frozen raw lightly breaded shrimp.

Frozen raw lightly breaded shrimp complies with the provisions of § 161.175, except that it contains not less than 65 percent of shrimp material, as determined by the method prescribed in § 161.175 (g) or (h), as appropriate, and that in the name prescribed the word “lightly” immediately precedes the words “breaded shrimp”.

§ 161.190 Canned tuna.

(a) *Identity.* (1) Canned tuna is the food consisting of processed flesh of fish of the species enumerated in paragraph (a)(2) of this section, prepared in one of the optional forms of pack specified in paragraph (a)(3) of this section, conforming to one of the color designations specified in paragraph (a)(4) of this section, in one of the optional packing media specified in paragraph (a)(5) of this section, and may contain one or more of the seasonings and flavorings specified in paragraph (a)(6) of this section. For the purpose of inhibiting the development of struvite

crystals, sodium acid pyrophosphate may be added in a quantity not in excess of 0.5 percent by weight of the finished food. It is packed in hermetically sealed containers and so processed by heat as to prevent spoilage. It is labeled in accordance with the provisions of paragraph (a)(8) of this section.

(2) The fish included in the class known as tuna fish are:

- Thunnus thynnus* (Linnaeus, 1758)—Northern bluefin tuna
- Thunnus maccoyii* (Castelnau, 1872)—Southern bluefin tuna
- Thunnus alalunga* (Bonnaterre, 1788)—Albacore
- Thunnus atlanticus* (Lesson, 1830)—Blackfin tuna
- Thunnus obesus* (Lowe, 1839)—Bigeye tuna
- Thunnus albacares* (Bonnaterre, 1788)—Yellowfin tuna
- Thunnus tonggol* (Bleeker, 1851)—Longtail tuna
- Katsuwonus pelamis* (Linnaeus, 1758)—Skipjack tuna
- Euthynnus alletteratus* (Rafinesque, 1810)—Spotted tunny
- Euthynnus lineatus* Kishinouye, 1920—Black skipjack tuna
- Euthynnus affinis* (Cantor, 1849)—Kawakawa
- Allothunnus fallai* Serventy, 1948—Slender tuna
- Auxis rochei* (Risso, 1810)—Bullet tuna
- Auxis thazard* (Lacepede, 1800)—Frigate tuna

(3) The optional forms of processed tuna consist of loins and other striated muscular tissue of the fish. The loin is the longitudinal quarter of the great lateral muscle freed from skin, scales, visible blood clots, bones, gills, viscera and from the nonstriated part of such muscle, which part (known anatomically as the median superficial muscle) is highly vascular in structure, dark in color because of retained blood, and granular in form. Canned tuna is prepared in one of the following forms of pack, the identity of which is determined in accordance with the methods prescribed in paragraph (c)(2) of this section.

(i) Solid or solid pack consists of loins freed from any surface tissue discolored by diffused hemolyzed blood, cut in transverse segments to which no free fragments are added. In containers of 1 pound or less of net contents, such segments are cut in lengths suitable for packing in one layer. In containers of more than 1 pound net contents, such segments may be cut in lengths

suitable for packing in one or more layers of equal thickness. Segments are placed in the can with the planes of their transverse cut ends parallel to the ends of the can. A piece of a segment may be added if necessary to fill a container. The proportion of free flakes broken from loins in the canning operation shall not exceed 18 percent.

(ii) Chunk, chunks, chunk style consists of a mixture of pieces of tuna in which the original muscle structure is retained. The pieces may vary in size, but not less than 50 percent of the weight of the pressed contents of a container is retained on a ½-inch-mesh screen.

(iii) Flake or flakes consist of a mixture of pieces of tuna in which more than 50 percent of the weight of the pressed contents of the container will pass through a ½-inch-mesh screen, but in which the muscular structure of the flesh is retained.

(iv) Grated consists of a mixture of particles of tuna that have been reduced to uniform size, that will pass through a ½-inch-mesh screen, and in which the particles are discrete and do not comprise a paste.

(v) Any of the specified forms of pack of canned tuna may be smoked. Canned smoked tuna shall be labeled in accordance with the provisions of paragraph (a)(8)(v) of this section.

(4) Canned tuna, in any of the forms of pack specified in paragraph (a)(3) of this section, falls within one of the following color designations, measured by visual comparison with matte surface neutral reflectance standards corresponding to the specified Munsell units of value, determined in accordance with paragraph (a)(7) of this section.

(i) *White*. This color designation is limited to the species *Thunnus alalunga* (albacore), and is not darker than Munsell value 6.3.

(ii) *Light*. This color designation includes any tuna not darker than Munsell value 5.3.

(iii) *Dark*. This color designation includes all tuna darker than Munsell value 5.3.

(iv) *Blended*. This color designation may be applied only to tuna flakes specified in paragraph (a)(3)(iii) of this section, consisting of a mixture of tuna

flakes of which not less than 20 percent by weight meet the color standard for either white tuna or light tuna, and the remainder of which fall within the color standard for dark tuna. The color designation for blended tuna is determined in accordance with paragraph (a)(7) of this section.

(5) Canned tuna is packed in one of the following optional packing media:

(i) Any edible vegetable oil other than olive oil, or any mixture of such oils not containing olive oil.

(ii) Olive oil.

(iii) Water.

(6) Canned tuna may be seasoned or flavored with one or more of the following:

(i) Salt.

(ii) Monosodium glutamate.

(iii) Hydrolyzed protein declared in accordance with the applicable provisions of §101.22.

(iv) Spices or spice oils or spice extracts.

(v) Vegetable broth in an amount not in excess of 5 percent of the volume capacity of the container, such broth to consist of a minimum of 0.5 percent by weight of vegetable extractives and to be prepared from two or more of the following vegetables: Beans, cabbage, carrots, celery, garlic, onions, parsley, peas, potatoes, green bell peppers, red bell peppers, spinach, and tomatoes.

(vi) Garlic.

(vii) Lemon flavoring to be prepared from lemon oil and citric acid together with safe and suitable carriers for the lemon oil which are present at non-functional and insignificant levels in the finished canned food. When lemon flavoring is added, a safe and suitable solubilizing and dispersing ingredient may be added in a quantity not exceeding 0.005 percent by weight of the finished food. A substance used in accordance with this paragraph is deemed to be suitable if it is used in an amount no greater than necessary to achieve the intended flavor effect, and is deemed to be safe if it is not a food additive as defined in section 201(s) of the Federal Food, Drug, and Cosmetic Act (the act), or if it is a food additive as so defined, it is used in conformity with regulations established pursuant to section 409 of the act.

(viii) Edible vegetable oil or partially hydrogenated vegetable oil, excluding olive oil, used alone or in combination in an amount not to exceed 5 percent of the volume capacity of the container, with or without any suitable form of emulsifying and suspending ingredients that has been affirmed as GRAS or approved as a food additive to aid in dispersion of the oil, as seasoning in canned tuna packed in water.

(7) For determination of the color designations specified in paragraph (a)(4) of this section, the following method shall be used: Recombine the separations of pressed cake resulting from the method prescribed in paragraph (c)(2) of this section. Pass the combined portions through a sieve fitted with woven-wire cloth of ¼-inch mesh complying with the specifications for such cloth set forth in "Official Methods of Analysis of the Association of Official Analytical Chemists," 13th Ed. (1980), Table 1, "Nominal Dimensions of Standard Test Sieves (U.S.A. Standard Series)," under the heading "Definitions of Terms and Explanatory Notes," which is incorporated by reference. Copies may be obtained from the AOAC INTERNATIONAL, 481 North Frederick Ave., suite 500, Gaithersburg, MD 20877, or may be examined at the National Archives and Records Administration (NARA). For information on the availability of this material at NARA, call 202-741-6030, or go to: http://www.archives.gov/federal_register/code_of_federal_regulations/ibr_locations.html. Mix the sieved material and place a sufficient quantity into a 307 × 113 size container (bearing a top seam and having a false bottom approximately ½-inch deep and painted flat black inside and outside) so that after tamping and smoothing the surface of the sample the material will be ⅜-inch to ¼-inch below the top of the container. Within 10 minutes after sieving through the ¼-inch mesh woven-wire cloth, determine the Munsell value of sample surface.

(i) Determine the Munsell value of the sample surface so prepared. The following method may be used, employing an optical comparator, consisting of a lens and prism system which brings two beams of light, reflected

from equal areas of sample surface and standard surface, respectively, together, within an eyepiece, so as to show an equally divided optical field. The scanned areas of sample and standard surface are not smaller than 2 square inches. Light reaching the eye is rendered sufficiently diffuse, by design of eyepiece and comparator, so that detail of the sample surface will remain undefined, to a degree such as to avoid visual confusion in observation of a match of over-all intensity of reflected light. The eyepiece contains a color filter centering at a wavelength between 550 m μ and 560 m μ . The filter does not pass appreciable visible radiation of wavelengths below 540 m μ or above 570 m μ . The passed wavelength band is of a monochromaticity sufficient to cause a sample and a neutral standard of equal reflectance to appear of the same hue. The comparator is rigidly mounted on a vertical stand attached to a base in which arrangement is provided for securely and accurately positioning two cans of size 307 \times 113 in the two fields of view. Mounted on the base are two shaded lamps, which direct the center of their beams of light at about a 45° angle to the plane of the sample and standard surfaces. The lamps are so positioned that light from one bears mainly upon the sample surface and light from the other mainly on the standard surface, and are so placed in relation to sample and standard that no shadows, as from the can rims, appear in the fields of view. The lamps are strong enough to furnish adequate and convenient illumination through eyepiece and filter. Means are provided to alter the light intensity of one lamp in relation to the other, as may conveniently be achieved by using a 100-watt tungsten filament bulb in one lamp and using, in the other, a similar 150-watt bulb connected with the power source through a suitable rheostat. The stand is equipped with non-glossy black curtains on the side of the observer, to exclude variation in extraneous light reflected from the person of the observer.

(ii) To adjust the comparator, place a pair of matte surface standards of Munsell value 5.3, mounted as described in paragraph (a)(7)(iv) of this section, in position in the comparator

base, and adjust the intensity of the variable lamp until the two halves of the optical field, viewed through the eyepiece, are of equal brightness. Then remove one of the standards and replace it with the prepared sample. Without altering any other adjustments, observe through the eyepiece whether the sample appears lighter or darker than the standard. In case of examination of albacore designated "white", conduct the procedure using standards of Munsell value 6.3.

(iii) The standards with which comparisons are made are essentially neutral matte-finish standards, equivalent in luminous reflectance of light of 555 μ wavelength to 33.7 percent of the luminous reflectance of magnesium oxide (for Munsell value 6.3) and 22.6 percent of the luminous reflectance of magnesium oxide (for Munsell value 5.3), as given by the relationship between Munsell value and luminous reflectance derived by a subcommittee of the Optical Society of America and published in the "Journal of the Optical Society of America," Vol. 33, page 406 (1943), which is incorporated by reference. Copies are available from the Center for Food Safety and Applied Nutrition (HFS-150), Food and Drug Administration, 5100 Paint Branch Pkwy., College Park, MD 20740, or available for inspection at the National Archives and Records Administration (NARA). For information on the availability of this material at NARA, call 202-741-6030, or go to: http://www.archives.gov/federal_register/code_of_federal_regulations/ibr_locations.html.

(iv) These standards shall be cut in circles 3 $\frac{1}{4}$ inches in diameter and shall be mounted in 307 \times 113 size containers, bearing a top seam and painted flat black inside and outside, so that the surfaces of the standards are $\frac{3}{16}$ inch below the top of the containers in which they are mounted.

(v) In the case of blended tuna, the foregoing method shall be varied by first separating the tuna flakes of the two different colors before passing them through the $\frac{1}{4}$ -inch mesh sieve, then proceeding with each portion separately for the determination of its color value, employing, if necessary, a

sample container with false bottom greater than ½ inch deep.

(8)(i) The specified names of the canned tuna for which definitions and standards of identity are prescribed by this section, except where water is the packing medium or where the tuna is smoked, are formed by combining the designation of form of pack with the color designation of the tuna; for example, "Solid pack white tuna", "Grated dark tuna", etc. In the case of blended tuna, there shall be used both applicable color designations of the blended flakes, in precedence determined in accordance with the predominating portion found in the container; for example, "Blended white and dark tuna flakes", "Blended dark and light tuna flakes".

(ii) The specified name of canned tuna when water is used as the packing medium is formed as described in paragraph (a)(8)(i) of this section, followed by the words "in water"; for example, "Grated light tuna in water".

(iii) When the packing medium is vegetable oil or olive oil, the label shall bear the name of the optional packing medium used, as specified in paragraph (a)(5) of this section, preceded by the word "in" or the words "packed in". In case of the optional ingredient specified in paragraph (a)(5)(i) of this section, the name or names of the oil used may be stated, or the general term "vegetable oil" may be used.

(iv) In case solid pack tuna is packed in olive oil, the designation "Tonno" may also appear.

(v) In case any of the specified forms of canned tuna are smoked, the word "smoked" shall appear as a part of the name on the label; for example, "Smoked light tuna flakes".

(vi) Where the canned tuna contains one or more of the ingredients provided for in paragraph (a)(6) of this section, the label shall bear the statement "Seasoned with _____", the blank being filled in with the name or names of the ingredient or ingredients used, except that if the ingredient designated in paragraph (a)(6)(v) of this section is used, the blank shall be filled in with the term "vegetable broth", and if the ingredients designated in paragraph (a)(6)(viii) of this section are used, the blank may be filled in with the term

"oil", and if the ingredient designated in paragraph (a)(6)(iv) of this section is used alone, the label may alternatively bear either the statement "spiced" or the statement "with added spice"; and if salt is the only seasoning ingredient used, the label may alternatively bear any of the statements "salted", "with added salt", or "salt added". If the flavoring ingredients designated in paragraph (a)(6)(vii) of this section are used, the words "lemon flavored" or "with lemon flavoring" shall appear as part of the name on the label; for example, "lemon flavored chunk light tuna". Citric acid and any optional solubilizing and dispersing agent used as specified in paragraph (a)(6)(vii) of this section in connection with lemon flavoring ingredients or emulsifying and suspending ingredients used as specified in paragraph (a)(6)(viii) of this section shall be designated on the label by their common or usual name.

(vii) Where the canned tuna contains the optional ingredient sodium acid pyrophosphate as provided in paragraph (a)(1) of this section, the label shall bear the statement "pyrophosphate added" or "with added pyrophosphate".

(viii) Wherever the name of the food appears on the label so conspicuously as to be easily seen under customary conditions of purchase, the names of the optional ingredients used, as specified in paragraphs (a)(8)(iii), (vi), and (vii) of this section (except if lemon flavoring is added, this subparagraph applies only to the terms "lemon flavored" or "with lemon flavoring", not to the constituent ingredients of that flavoring or to any optional solubilizing or dispersing ingredient used in connection with lemon flavoring ingredients), shall immediately and conspicuously precede or follow such name without intervening, written, printed, or graphic matter except that the common name of the species of tuna fish may so intervene; but the species name "albacore" may be employed only for canned tuna of that species which meets the color designation "white" as prescribed by paragraph (a)(4)(i) of this section.

(ix) Statements of optional ingredients present required by paragraph

§ 161.190

21 CFR Ch. I (4-1-07 Edition)

(a)(8)(vi) of this section, but not subject to the provisions of paragraph (a)(8)(viii) of this section shall be set forth on the label with such prominence and conspicuousness as to render them likely to be read and understood by the ordinary individual under customary conditions of purchase.

(b) [Reserved]

(c) *Fill of container.* (1) The standard of fill of container for canned tuna is a fill such that the average weight of the pressed cake from 24 cans, as determined by the method prescribed by paragraph (c)(2) of this section, is not less than the minimum value specified for the corresponding can size and form of tuna ingredient in the following table:

I. Can size and form of tuna ingredient	II. Minimum value for weights of pressed cake (average of 24 cans) (in ounces)
211×109:	
Solid	2.25
Chunks	1.98
Flakes	1.98
Grated	2.00
307×113:	
Solid	4.47
Chunks	3.92
Flakes	3.92
Grated	3.96
401×206:	
Solid	8.76
Chunks	7.68
Flakes	7.68
Grated	7.76
603×408:	
Solid	43.2
Chunks	37.9
Flakes	37.9
Grated	38.3

If the can size in question is not listed, calculate the value for column II as follows: From the list select as the comparable can size that one having nearest the water capacity of the can size in question, multiply the value listed in column II for the same form of tuna ingredient by the water capacity of the can size in question, and divided by the water capacity of the comparable can size. Water capacities are determined by the general method provided in §130.12(a) of this chapter. For the purposes of this section, cans of dimensions 211×109 shall be deemed to have a water capacity at 68 °F of 3.55 avoirdupois ounces of water; cans of di-

mensions 307×113, a water capacity of 7.05 avoirdupois ounces of water; cans of dimensions 401×206, a water capacity of 13.80 avoirdupois ounces of water; and cans of dimensions 603×408, a water capacity of 68.15 avoirdupois ounces of water.

(2) The methods referred to in paragraph (c)(1) of this section for determining the weight of the pressed cake and referred to in paragraph (a)(3)(i) of this section for determining the percent of free flakes and the percent of pieces that pass through a ½-inch-mesh sieve are as follows:

(i) Have each of the 24 cans and contents at a temperature of 75 °F within ±5 °F. Test each can in turn as follows:

(ii) Cut out the top of the can (code end), using a can opener that does not remove nor distort the double seam.

(iii) With the cut top held on the can contents, invert the can, and drain the free liquid by gentle finger pressure on the cut lid so that most of the free liquid drains from the can.

(iv) With the cut lid still in place, cut out the bottom of the can with the can opener, then turn the can upright and remove the cut can top (code end). Scrape off any adhering tuna particles into the tuna mass in the can.

(v) Place the proper size of press cylinder as provided in paragraph (c)(3)(i) of this section in a horizontal position on a table; then, using the cut bottom of the can as a pusher, gently force the can contents from the can into the cylinder so that the flat side of the can contents lies in contact with the bottom of the cylinder. Remove the bottom of the can that was used as the pusher and scrape any adhering particles from the can body and bottom of the can, and put them in the cylinder.

(vi) Place the cylinder plunger on top of the can contents in the cylinder. Remove the eyebolt and put the cylinder and plunger in position on the press (paragraph (c)(3)(iii) of this section).

(vii) Begin the operation of the press and as soon as liquid is observed coming from the cylinder start timing the operation. Apply pressure to the plunger slowly and at a uniform rate, so that a full minute is used to reach a pressure of 384 pounds per square inch of plunger face in contact with the can

contents. Hold this pressure for 1 additional minute and then release the pressure and disengage the plunger from the press shaft. Tip the press cylinder so that any free liquid is drained out.

(viii) Remove press cylinder with plunger from the press, insert eyebolt in plunger and withdraw it from the cylinder. Loosen the pressed cake from the cylinder with a thin blade and remove the entire pressed cake as gently as possible, to keep the mass in a single cake during this operation. Place the pressed cake and any pieces that adhered to the plunger and cylinder in a tared receiving pan and determine the weight of the pressed material.

(ix) For cans larger than 401×206, cut out the top of the can and drain off free liquid from the can contents as in operations described in paragraphs (c)(2)(ii) and (iii) of this section. Determine the gross weight of the can and remaining contents. Using a tared core cutter as provided for in paragraph (c)(3)(ii) of this section, cut vertically a core of the drained material in the can. Determine the weight of the core. With a thin spatula transfer the core to the pressing cylinder for 401×206 cans. Determine the weight of the pressed cake as in the operations described in paragraphs (c)(2)(v) through (viii) of this section. Remove the remaining drained contents of the can, reserving the contents for the determination of free flakes (paragraph (c)(2)(xi) of this section), weigh the empty can, and calculate the weight of the total drained material. Calculate the weight of pressed cake on the entire can basis by multiplying the weight of the pressed cake of the core by the ratio of the weight of the drained contents of the can to the weight of the core before pressing.

(x) Repeat the determination of weight of pressed cake on the remainder of the 24 cans and determine the average weight of pressed cake for the purpose of paragraph (c)(1) of this section.

(xi) Determination of free flakes: If the optional form of tuna ingredient is solid pack, determine the percent of free flakes. Any flakes resulting from the operations described in this paragraph (c)(2)(xi) or in other parts of this

paragraph are to be weighed as free flakes. Only fragments that were broken in the canning procedure are considered to be free flakes. If the can is of such size that its entire drained contents were pressed as described in paragraphs (c)(2)(i) to (viii) of this section, inclusive, examine the pressed cake carefully for free flakes. Using a spatula, scrape free flakes gently from the outside of the cake. Weigh the aggregate free flakes that were broken from the loin segments in the canning procedure and calculate their percentage of the total weight of pressed cake. If the can is of such size that a core was cut for pressing as described in paragraph (c)(2)(ix) of this section, make the examination for free flakes on a weighed portion of the drained material remaining after the core was removed. The weight of the portion examined should approximately equal the weight of the core before pressing. Calculate the weight of the free flakes that were broken from the loins in the canning procedure as a percentage of the weight of the portion examined.

(xii) Determination of particle size: If the optional form of tuna ingredient is chunks, flakes, or grated, the pressed cake resulting from the operations described in paragraphs (c)(2)(i) to (ix) of this section, inclusive, is gently separated by hand, care being taken to avoid breaking the pieces. The separated pieces are evenly distributed over the top sieve of the screen separation equipment described in paragraph (c)(3)(iv) of this section. Beginning with the top sieve, lift and drop each sieve by its open edge three times. Each time, the open edge of the sieve is lifted the full distance permitted by the device. Combine and weigh the material remaining on the three top sieves (1½-inch, 1-inch, ½-inch screens), and determine the combined percentage retention by weight in relation to the total weight of the pressed cake.

(3)(i) The press cylinder and plunger referred to in paragraph (c)(2) of this section are made of stainless steel. The press cylinders are made with a lip to facilitate drainage of the liquid. Plungers have a threaded center hole, about half as deep as the thickness of the

plunger, for receiving a ringbolt to assist in removing the plunger from the press cylinder. Dimensions for press cylinders and plungers are as follows:

For can size 211×109

Press cylinder:
 Inside depth, approximately 3¾ inches.
 Inside diameter, 2.593 inches.
 Wall thickness, approximately ⅜ inch.
 Plunger:
 Thickness, approximately 1 inch.
 Diameter, 2.568 inches.

For can size 307×113

Press cylinder:
 Inside depth, approximately 4 inches.
 Inside diameter, 3.344 inches.
 Wall thickness, approximately ⅜ inch.
 Plunger:
 Thickness, approximately 1¼ inches.
 Diameter, 3.319 inches.

For can size 401×206

Press cylinder:
 Inside depth, approximately 4⅞ inches.
 Inside diameter, 3.969 inches.
 Wall thickness, approximately ½ inch.
 Plunger:
 Thickness, approximately 1¼ inches.
 Diameter, 3.944 inches.

For can sizes where the diameter is greater than 401, the core cutter described in paragraph (c)(3)(ii) of this section shall be used and the resulting core pressed in the press cylinder for can size 401×206. For can sizes differing from those specified in this paragraph (c)(3)(i), special press cylinders and plungers may be used. Special press less than the outside diameters, at the cylinders have inside diameters ¼-inch double seam, for the can sizes for which the cylinders are used; plunger diameters are 0.025-inch less than the inside diameters of the press cylinders.

(ii) The core cutter referred to in paragraph (c)(2) (ix) and (xi) of this section and paragraph (c)(3)(i) of this section is made from a previously sealed 300×407 can. The cover, including the top seam, is cut out. The edge is smoothed and sharpened. A small hole to permit passage of air is made in the bottom.

(iii) The hydraulic press referred to in paragraph (c)(2) (vi) to (x) of this section, inclusive, is made by so mounting a hydraulic jack, in a strong frame, that it will press horizontally against the center of the plunger in the

press cylinder used. The frame is so braced that it does not change shape when pressure is applied. The gauge on the hydraulic jack is so calibrated that it will indicate, for the plunger being used, when the plunger is pressing against the contents of the press cylinder with a pressure of 384 pounds per square inch of plunger face.

(iv) The sieving device referred to in paragraph (c)(2)(xii) of this section consists of three sieves, each approximately 1 foot square, loosely mounted, one above the other, in a metal frame. The mesh in the top sieve complies with the specifications for 1½-inch woven-wire cloth as prescribed in paragraph (a)(7) of this section. The meshes in the sieves below comply with similar specifications for 1-inch and ½-inch woven-wire cloth as set forth in the same publication. The sides of each sieve are formed, in a raised rim, from ¾-inch × ¼-inch metal strap. The frame has tracks made of ⅜-inch angle metal to support each sieve under each side. The tracks are so positioned as to permit each sieve a free vertical travel of 1¾ inches.

(4) If canned tuna falls below the applicable standard of fill of container prescribed in paragraph (c)(1) of this section, the label shall bear the general statement of substandard fill provided in §130.14(b) of this chapter, in the manner and form therein specified.

[42 FR 14464, Mar. 15, 1977, as amended at 47 FR 11833, Mar. 19, 1982; 49 FR 10102, Mar. 19, 1984; 54 FR 24896, June 12, 1989; 55 FR 45797, Oct. 31, 1990; 56 FR 6263, Feb. 15, 1991; 58 FR 2884, Jan. 6, 1993; 61 FR 14480, Apr. 2, 1996; 63 FR 14035, Mar. 24, 1998; 66 FR 56035, Nov. 6, 2001]

PART 163—CACAO PRODUCTS

Subpart A—General Provisions

Sec.
 163.5 Methods of analysis.

Subpart B—Requirements for Specific Standardized Cacao Products

163.110 Cacao nibs.
 163.111 Chocolate liquor.
 163.112 Breakfast cocoa.
 163.113 Cocoa.
 163.114 Lowfat cocoa.
 163.117 Cocoa with dioctyl sodium sulfosuccinate for manufacturing.

- 163.123 Sweet chocolate.
- 163.124 White chocolate.
- 163.130 Milk chocolate.
- 163.135 Buttermilk chocolate.
- 163.140 Skim milk chocolate.
- 163.145 Mixed dairy product chocolates.
- 163.150 Sweet cocoa and vegetable fat coating.
- 163.153 Sweet chocolate and vegetable fat coating.
- 163.155 Milk chocolate and vegetable fat coating.

AUTHORITY: 21 U.S.C. 321, 331, 341, 343, 348, 371, 379e.

SOURCE: 58 FR 29529, May 21, 1993, unless otherwise noted.

Subpart A—General Provisions

§ 163.5 Methods of analysis.

Shell and cacao fat content in cacao products shall be determined by the following methods of analysis prescribed in “Official Methods of Analysis of the Association of Official Analytical Chemists,” which are incorporated by reference in accordance with 5 U.S.C. 552(a) and 1 CFR part 51. Copies may be obtained from the AOAC INTERNATIONAL, 481 North Frederick Ave., suite 500, Gaithersburg, MD 20877, or may be examined at the National Archives and Records Administration (NARA). For information on the availability of this material at NARA, call 202-741-6030, or go to: http://www.archives.gov/federal_register/code_of_federal_regulations/ibr_locations.html.

(a) Shell content—12th ed. (1975), methods 13.010–13.014, under the heading “Shell in Cacao Nibs—Official Final Action,” pp. 208–210.

(b) Fat content—15th ed. (1990), method 963.15, under the heading “Fat in Cacao Products—Soxhlet Extraction Method—Final Action, 1973,” pp. 770–771.

[58 FR 29529, May 21, 1993, as amended at 63 FR 14035, Mar. 24, 1998]

Subpart B—Requirements for Specific Standardized Cacao Products

§ 163.110 Cacao nibs.

(a) *Description.* (1) Cacao nibs is the food prepared by removing the shell from cured, cleaned, dried, and cracked

cacao beans. The cacao shell content is not more than 1.75 percent by weight, calculated on an alkali free basis, as determined by the method prescribed in § 163.5(a).

(2) The cacao nibs, or the cacao beans from which they are prepared, may be processed by heating with one or more of the optional alkali ingredients specified in paragraph (b)(1) of this section.

(3) The cacao nibs, or the cacao beans from which they are prepared, as appropriate, may be further processed with one or more of the optional neutralizing agents specified in paragraph (b)(2) of this section.

(b) *Optional ingredients.* The following safe and suitable ingredients may be used:

(1) Alkali ingredients. Ammonium, potassium, or sodium bicarbonate, carbonate, or hydroxide, or magnesium carbonate or oxide, added as such, or in aqueous solution. For each 100 parts by weight of cacao nibs, used as such, or before shelling from the cacao beans, the total quantity of alkali ingredients used is not greater in neutralizing value (calculated from the respective combined weights of the alkali ingredients used) than the neutralizing value of 3 parts by weight of anhydrous potassium carbonate.

(2) Neutralizing agents. Phosphoric acid, citric acid, and *L*-tartaric acid, added as such, or in aqueous solution. For each 100 parts by weight of cacao nibs, used as such, or before shelling from the cacao beans, the total quantity of phosphoric acid used is not greater than 0.5 part by weight, expressed as P₂O₅. The total amount, singly or in combination, of citric acid and *L*-tartaric acid is not greater than 1.0 part by weight.

(c) *Nomenclature.* The name of the food is “cacao nibs”, “cocoa nibs”, or “cracked cocoa”. (1) When the cacao nibs, or the cacao beans from which they are prepared, are processed with alkali ingredients specified in paragraph (b)(1) of this section, the name of the food shall be accompanied by the statement “Processed with alkali” or “Processed with _____”, the blank being filled in with the common or usual name of the specific alkali ingredient used in the food.

(2) When the cacao nibs, or the cacao beans from which they are prepared, are processed with neutralizing agents specified in paragraph (b)(2) of this section, the name of the food shall be accompanied by the statement “Processed with neutralizing agent” or “Processed with _____”, the blank being filled in with the common or usual name of the specific neutralizing agent used in the food.

(3) Whenever the name of the food appears on the label so conspicuously as to be easily seen under customary conditions of purchase, the statements prescribed in paragraphs (c)(1) and (c)(2) of this section shall precede or follow the name without intervening printed or graphic matter.

(d) *Label declaration.* Each of the ingredients used in the food shall be declared on the label as required by the applicable sections of parts 101 and 130 of this chapter.

§ 163.111 Chocolate liquor.

(a) *Description.* (1) Chocolate liquor is the solid or semiplastic food prepared by finely grinding cacao nibs. The fat content of the food may be adjusted by adding one or more of the optional ingredients specified in paragraph (b)(1) of this section to the cacao nibs. Chocolate liquor contains not less than 50 percent nor more than 60 percent by weight of cacao fat as determined by the method prescribed in § 163.5(b).

(2) Optional alkali ingredients specified in paragraph (b)(2) of this section may be used as such in the preparation of chocolate liquor under the conditions and limitations specified in § 163.110(b)(1).

(3) Optional neutralizing agents specified in paragraph (b)(3) of this section may be used as such in the preparation of the chocolate liquor under the conditions and limitations specified in § 163.110(b)(2).

(4) Chocolate liquor may be spiced, flavored, or seasoned with one or more of the ingredients listed in paragraphs (b)(4), (b)(5), and (b)(6) of this section.

(b) *Optional ingredients.* The following safe and suitable ingredients may be used:

(1) Cacao fat and cocoas (breakfast cocoa, cocoa, or lowfat cocoa);

(2) Alkali ingredients. Ammonium, potassium, or sodium bicarbonate, carbonate, or hydroxide, or magnesium carbonate or oxide, added as such, or in aqueous solution;

(3) Neutralizing agents. Phosphoric acid, citric acid, and *L*-tartaric acid, added as such, or in aqueous solution;

(4) Spices, natural and artificial flavorings, ground whole nut meats, ground coffee, dried malted cereal extract, and other seasonings that do not either singly or in combination impart a flavor that imitates the flavor of chocolate, milk, or butter;

(5) Butter or milkfat; or

(6) Salt.

(c) *Nomenclature.* The name of the food is “chocolate liquor”, “chocolate”, “unsweetened chocolate”, “bitter chocolate”, “baking chocolate”, “cooking chocolate”, “chocolate coating”, or “unsweetened chocolate coating”.

(1) When any optional alkali ingredient specified in paragraph (b)(2) of this section is used, including those used in the preparation of the cacao nibs and cocoas from which the chocolate liquor was prepared, the name of the food shall be accompanied by the statement “Processed with alkali” or “Processed with _____”, the blank being filled in with the common or usual name of the specific alkali ingredient used in the food.

(2) When any optional neutralizing agent specified in paragraph (b)(3) of this section is used, including those used in the preparation of the cacao nibs and cocoas from which the chocolate liquor was prepared, the name of the food shall be accompanied by the statement “Processed with neutralizing agent” or “Processed with _____”, the blank being filled in with the common or usual name of the specific neutralizing ingredient used in the food.

(3) When one or more spices, flavorings, or seasonings specified in paragraphs (b)(4) and (b)(5) of this section are used in the chocolate liquor, the label shall bear an appropriate statement, e.g., “Spice added”, “Flavored with _____”, “Seasoned with _____”, or “With _____ added”, the blank being filled in with the common or usual name of the spice, flavoring,

or seasoning used, in accordance with § 101.22 of this chapter.

(4) When two or more of the statements set forth in this paragraph are required, such statements may be combined in a manner that is appropriate, but not misleading.

(5) Whenever the name of the food appears on the label so conspicuously as to be easily seen under customary conditions of purchase, the statements prescribed in this section, showing optional ingredients used, shall precede or follow the name without intervening printed or graphic matter.

(d) *Label declaration.* Each of the ingredients used in the food shall be declared on the label as required by the applicable sections of parts 101 and 130 of this chapter.

§ 163.112 Breakfast cocoa.

(a) *Description.* (1) Breakfast cocoa is the food prepared by pulverizing the material remaining after part of the cacao fat has been removed from ground cacao nibs. Breakfast cocoa contains not less than 22 percent by weight of cacao fat as determined by the method prescribed in § 163.5(b).

(2) Optional alkali ingredients specified in paragraph (b)(1) of this section may be used as such in the preparation of breakfast cocoa under the conditions and limitations specified in § 163.110(b)(1).

(3) Optional neutralizing agents specified in paragraph (b)(2) of this section may be used as such in the preparation of the breakfast cocoa under the conditions and limitations specified in § 163.110(b)(2).

(4) Breakfast cocoa may be spiced, flavored, or seasoned with one or more of the ingredients listed in paragraphs (b)(3) and (b)(4) of this section.

(b) *Optional ingredients.* The following safe and suitable ingredients may be used:

(1) Alkali ingredients. Ammonium, potassium, or sodium bicarbonate, carbonate, or hydroxide, or magnesium carbonate or oxide, used as such, or in aqueous solution;

(2) Neutralizing agents. Phosphoric acid, citric acid and L-tartaric acid, used as such, or in aqueous solution;

(3) Spices, natural and artificial flavorings, and other seasonings that

do not either singly or in combination impart a flavor that imitates the flavor of chocolate, milk, or butter; or

(4) Salt.

(c) *Nomenclature.* The name of the food is “breakfast cocoa”, or “high fat cocoa”.

(1) When any optional alkali ingredient specified in paragraph (b)(1) of this section is used, including those used in the preparation of the cacao nibs from which the breakfast cocoa was prepared, the name of the food shall be accompanied by the statement “Processed with alkali”, or “Processed with _____”, the blank being filled in with the common or usual name of the specific alkali ingredient used in the food.

(2) When any optional neutralizing agent specified in paragraph (b)(2) of this section is used, including those used in the preparation of the cacao nibs from which the breakfast cocoa was prepared, the name of the food shall be accompanied by the statement “Processed with neutralizing agent” or “Processed with _____”, the blank being filled in with the common or usual name of the specific neutralizing agent used in the food.

(3) When one or more of the spices, flavorings, or seasonings specified in paragraph (b)(3) of this section are used in the breakfast cocoa, the label shall bear an appropriate statement, e.g., “Spice added”, “Flavored with _____”, or “With _____ added”, the blank being filled in with the common or usual name of the spice, flavoring, or seasoning used, in accordance with § 101.22 of this chapter.

(4) When two or more of the statements set forth in this paragraph are required, such statements may be combined in a manner that is appropriate, but not misleading.

(5) Whenever the name of the food appears on the label so conspicuously as to be easily seen under customary conditions of purchase, the statements prescribed in this paragraph showing optional ingredients used shall precede or follow the name without intervening printed or graphic matter.

(d) *Label declaration.* Each of the ingredients used in the food shall be declared on the label as required by the

§ 163.113

applicable sections of parts 101 and 130 of this chapter.

§ 163.113 Cocoa.

(a) *Description.* Cocoa is the food that conforms to the definition and standard of identity, and is subject to the requirements for label declaration of ingredients for breakfast cocoa in § 163.112, except that the cacao fat content is less than 22 percent, but not less than 10 percent by weight, as determined by the method prescribed in § 163.5(b).

(b) *Nomenclature.* The name of the food is “cocoa” or “medium fat cocoa”.

§ 163.114 Lowfat cocoa.

(a) *Description.* Lowfat cocoa is the food that conforms to the definition and standard of identity, and is subject to the requirements for label declaration of ingredients for breakfast cocoa in § 163.112, except that the cacao fat content is less than 10 percent by weight, as determined by the method prescribed in § 163.5(b).

(b) *Nomenclature.* The name of the food is “lowfat cocoa”.

§ 163.117 Cocoa with dioctyl sodium sulfosuccinate for manufacturing.

(a) *Description.* Cocoa with dioctyl sodium sulfosuccinate for manufacturing is the food additive complying with the provisions prescribed in § 172.520 of this chapter. It conforms to the definition and standard of identity, and is subject to the requirements for label declaration of ingredients, for breakfast cocoa in § 163.112, or for cocoa in § 163.113, or for lowfat cocoa in § 163.114, except that the food additive contains dioctyl sodium sulfosuccinate (complying with the requirements of § 172.810 of this chapter, including the limit of not more than 0.4 percent by weight of the finished food additive).

(b) *Nomenclature.* The name of the food additive is “cocoa with dioctyl sodium sulfosuccinate for manufacturing” to which is added any modifier of the word “cocoa” required by the definition and standard of identity to which the food additive otherwise conforms. When the food additive is used in a fabricated food, the phrase “for manufacturing” may be omitted from

21 CFR Ch. I (4–1–07 Edition)

any declaration of ingredients required under § 101.4 of this chapter.

§ 163.123 Sweet chocolate.

(a) *Description.* (1) Sweet chocolate is the solid or semiplastic food prepared by intimately mixing and grinding chocolate liquor with one or more optional nutritive carbohydrate sweeteners, and may contain one or more of the other optional ingredients specified in paragraph (b) of this section.

(2) Sweet chocolate contains not less than 15 percent by weight of chocolate liquor complying with the requirements of § 163.111, as calculated by subtracting from the weight of the chocolate liquor used the weight of the cacao fat therein and the weights therein of any alkali, neutralizing, and seasoning ingredients, and multiplying the remainder by 2.2, dividing the result by the weight of the finished sweet chocolate, and multiplying the quotient by 100. The finished sweet chocolate contains less than 12 percent by weight of total milk solids based on those dairy ingredients specified in paragraph (b)(4) of this section, exclusive of any added sweetener or other dairy derived ingredient that is added beyond that amount that is normally present in the specified dairy ingredient.

(3) Semisweet chocolate or bitter-sweet chocolate is sweet chocolate that contains not less than 35 percent by weight of chocolate liquor complying with the requirements of § 163.111 and calculated in the same manner as set forth in paragraph (a)(2) of this section.

(4) Cacao fat is determined by the method prescribed in § 163.5(b).

(b) *Optional ingredients.* The following safe and suitable ingredients may be used:

- (1) Cacao fat;
- (2) Nutritive carbohydrate sweeteners;
- (3) Spices, natural and artificial flavorings, ground whole nut meats, ground coffee, dried malted cereal extract, salt, and other seasonings that do not either singly or in combination impart a flavor that imitates the flavor of chocolate, milk, or butter;
- (4) Dairy ingredients:
 - (i) Cream, milkfat, butter;

(ii) Milk, concentrated milk, evaporated milk, sweetened condensed milk, dried milk;

(iii) Skim milk, concentrated skim milk, evaporated skim milk, sweetened condensed skim milk, nonfat dry milk;

(iv) Concentrated buttermilk, dried buttermilk; and

(v) Malted milk; or

(5) Emulsifying agents, used singly or in combination, the total amount of which does not exceed 1.0 percent by weight.

(c) *Nomenclature.* The name of the food is “sweet chocolate”, “sweet chocolate coating”, “semisweet chocolate”, “semisweet chocolate coating”, “bittersweet chocolate”, or “bittersweet chocolate coating”, as appropriate.

(1) When optional alkalizing ingredients are used in the preparation of the chocolate liquor or the cacao nibs from which the chocolate was prepared, the label shall bear the statement “Processed with alkali”, or “Processed with _____”, the blank being filled in with the common or usual name of the specific alkali ingredient used in the food.

(2) When optional neutralizing agents are used in the preparation of the chocolate liquor or the cacao nibs from which the chocolate was prepared, the label shall bear the statement “Processed with neutralizing agents”, or “Processed with _____”, the blank being filled in with the common or usual name of the specific neutralizing agent used in the food.

(3) When one or more of the spices, flavorings, or seasonings specified in paragraph (b)(3) of this section are used in the breakfast cocoa, the label shall bear an appropriate statement, e.g., “Spice added”, “Flavored with _____”, or “With _____ added”, the blank being filled in with the common or usual name of the spice, flavoring, or seasoning used, in accordance with §101.22 of this chapter.

(4) When two or more of the statements set forth in this paragraph are required, such statements may be combined in a manner that is appropriate, but not misleading.

(5) Whenever the name of the food appears on the label so conspicuously as to be easily seen under customary conditions of purchase, the statements prescribed in this paragraph showing

optional ingredients used shall precede or follow such name without intervening printed or graphic matter.

(d) *Label declaration.* Each of the ingredients used in the food shall be declared on the label as required by the applicable sections of parts 101 and 130 of this chapter.

§ 163.124 White chocolate.

(a) *Description.* (1) White chocolate is the solid or semiplastic food prepared by intimately mixing and grinding cacao fat with one or more of the optional dairy ingredients specified in paragraph (b)(2) of this section and one or more optional nutritive carbohydrate sweeteners and may contain one or more of the other optional ingredients specified in paragraph (b) of this section. White chocolate shall be free of coloring material.

(2) White chocolate contains not less than 20 percent by weight of cacao fat as calculated by subtracting from the weight of the total fat the weight of the milkfat, dividing the result by the weight of the finished white chocolate, and multiplying the quotient by 100. The finished white chocolate contains not less than 3.5 percent by weight of milkfat and not less than 14 percent by weight of total milk solids, calculated by using only those dairy ingredients specified in paragraph (b)(2) of this section, and not more than 55 percent by weight nutritive carbohydrate sweetener.

(b) *Optional ingredients.* The following safe and suitable ingredients may be used:

(1) Nutritive carbohydrate sweeteners;

(2) Dairy ingredients:

(i) Cream, milkfat, butter;

(ii) Milk, dry whole milk, concentrated milk, evaporated milk, sweetened condensed milk;

(iii) Skim milk, concentrated skim milk, evaporated skim milk, sweetened condensed skim milk, nonfat dry milk;

(iv) Concentrated buttermilk, dried buttermilk; and

(v) Malted milk;

(3) Emulsifying agents, used singly or in combination, the total amount of which does not exceed 1.5 percent by weight;

(4) Spices, natural and artificial flavorings, ground whole nut meats, ground coffee, dried malted cereal extract, salt, and other seasonings that do not either singly or in combination impart a flavor that imitates the flavor of chocolate, milk, or butter;

(5) Antioxidants; and

(6) Whey or whey products, the total amount of which does not exceed 5 percent by weight.

(c) *Nomenclature.* The name of the food is “white chocolate” or “white chocolate coating.” When one or more of the spices, flavorings, or seasonings specified in paragraph (b)(4) of this section are used, the label shall bear an appropriate statement, e.g., “Spice added”, “Flavored with _____”, or “With _____ added”, the blank being filled in with the common or usual name of the spice, flavoring, or seasoning used, in accordance with §101.22 of this chapter.

(d) *Label declaration.* Each of the ingredients used in the food shall be declared on the label as required by the applicable sections of parts 101 and 130 of this chapter.

[67 FR 62177, Oct. 4, 2002]

§ 163.130 Milk chocolate.

(a) *Description.* (1) Milk chocolate is the solid or semiplastic food prepared by intimately mixing and grinding chocolate liquor with one or more of the optional dairy ingredients and one or more optional nutritive carbohydrate sweeteners, and may contain one or more of the other optional ingredients specified in paragraph (b) of this section.

(2) Milk chocolate contains not less than 10 percent by weight of chocolate liquor complying with the requirements of §163.111 as calculated by subtracting from the weight of the chocolate liquor used the weight of cacao fat therein and the weights of alkali, neutralizing and seasoning ingredients, multiplying the remainder by 2.2, dividing the result by the weight of the finished milk chocolate, and multiplying the quotient by 100. The finished milk chocolate contains not less than 3.39 percent by weight of milkfat and not less than 12 percent by weight of total milk solids based on those dairy ingredients specified in paragraph

(b)(4) of this section, exclusive of any added sweetener or other dairy-derived ingredient that is added beyond that amount that is normally present in the specified dairy ingredient.

(b) *Optional ingredients.* The following safe and suitable ingredients may be used:

(1) Cacao fat;

(2) Nutritive carbohydrate sweeteners;

(3) Spices, natural and artificial flavorings, ground whole nut meats, ground coffee, dried malted cereal extract, salt, and other seasonings that do not either singly or in combination impart a flavor that imitates the flavor of chocolate, milk, or butter;

(4) Dairy ingredients:

(i) Cream, milkfat, butter;

(ii) Milk, concentrated milk, evaporated milk, sweetened condensed milk, dried milk; and

(iii) Skim milk, concentrated skim milk, evaporated skim milk, sweetened condensed skim milk, nonfat dry milk; or

(5) Emulsifying agents, used singly or in combination, the total amount of which does not exceed 1.0 percent by weight.

(c) *Nomenclature.* The name of the food is “milk chocolate” or “milk chocolate coating”.

(1) When optional alkali ingredients are used in the preparation of the chocolate liquor or the cacao nibs from which the milk chocolate was prepared, the label shall bear the statement “Processed with alkali”, or “Processed with _____”, the blank being filled in with the common or usual name of the specific alkali ingredient used in the food.

(2) When optional neutralizing agents are used in the preparation of the chocolate liquor or the cacao nibs from which the milk chocolate was prepared, the label shall bear the statement “Processed with neutralizing agents”, or “Processed with _____”, the blank being filled in with the common or usual name of the specific neutralizing agent used in the food.

(3) When one or more of the spices, flavorings, or seasonings specified in paragraph (b)(3) of this section are used in the breakfast cocoa, the label shall bear an appropriate statement, e.g.,

“Spice added”, “Flavored with _____”, or “With _____ added”, the blank being filled in with the common or usual name of the spice, flavoring, or seasoning used, in accordance with §101.22 of this chapter.

(4) When two or more of the statements set forth in this paragraph are required, such statements may be combined in a manner that is appropriate, but not misleading.

(5) Whenever the name of the food appears on the label so conspicuously as to be easily seen under customary conditions of purchase, the statements prescribed in this paragraph showing optional ingredients used shall precede or follow such name without intervening printed or graphic matter.

(d) *Label declaration.* Each of the ingredients used in the food shall be declared on the label as required by the applicable sections of parts 101 and 130 of this chapter.

§ 163.135 Buttermilk chocolate.

(a) *Description.* Buttermilk chocolate is the food that conforms to the standard of identity, and is subject to the requirements for label declaration of ingredients for milk chocolate in §163.130, except that:

(1) The optional dairy ingredients are limited to sweet cream buttermilk, concentrated sweet cream buttermilk, dried sweet cream buttermilk, and any combination of these; and

(2) The finished buttermilk chocolate contains less than 3.39 percent by weight of milkfat and not less than 12 percent by weight of sweet cream buttermilk solids based on those dairy ingredients specified in paragraph (a)(1) of this section, exclusive of any added sweetener or other dairy-derived ingredient that is added beyond that amount that is normally present in the specified dairy ingredient.

(b) *Nomenclature.* The name of the food is “buttermilk chocolate”, “buttermilk chocolate coating”, “sweet buttermilk chocolate”, “sweet buttermilk chocolate coating”, “sweet cream buttermilk chocolate”, or “sweet cream buttermilk chocolate coating”.

§ 163.140 Skim milk chocolate.

(a) *Description.* Skim milk chocolate is the food that conforms to the stand-

ard of identity, and is subject to the requirements for label declaration of ingredients for milk chocolate in §163.130, except that:

(1) The optional dairy ingredients are limited to skim milk, evaporated skim milk, concentrated skim milk, sweetened condensed skim milk, nonfat dry milk, and any combination of these; and

(2) The finished skim milk chocolate contains less than 3.39 percent by weight of milkfat and not less than 12 percent by weight of skim milk solids based on those dairy ingredients specified in paragraph (a)(1) of this section, exclusive of any added sweetener or other dairy-derived ingredient that is added beyond that amount that is normally present in the specified dairy ingredient.

(b) *Nomenclature.* The name of the food is “skim milk chocolate”, “skim milk chocolate coating”, “sweet skim milk chocolate”, or “sweet skim milk chocolate coating”.

§ 163.145 Mixed dairy product chocolates.

(a) *Description.* Mixed dairy product chocolates are the foods that conform to the standard of identity, and are subject to the requirements for label declaration of ingredients for milk chocolate in §163.130, except that:

(1) The optional dairy ingredients for each of the foods are mixtures of two or more of the following:

(i) Any dairy ingredients specified in §163.130;

(ii) Any dairy ingredients specified in §163.135;

(iii) Any dairy ingredients specified in §163.140; or

(iv) Malted milk; and

(2) The finished mixed dairy product chocolates shall contain not less than 12 percent by weight of total milk solids derived from those dairy products referred to in paragraph (a)(1) of this section, exclusive of any added sweetener or other dairy-derived ingredient that is added beyond that amount that is normally present in the specified dairy product, and may contain less than 3.39 percent by weight of milkfat. The quantity of each component used in any such mixture is such that no component contributes less than one

§ 163.150

21 CFR Ch. I (4-1-07 Edition)

third of the weight of the total milk solids contributed by that component which is used in the largest proportion.

(b) *Nomenclature.* The name of the food is “chocolate”, or “chocolate coating”, preceded by the designation of the type of milk ingredients used as prescribed in paragraph (a) of this section in order of predominance by weight, e.g., “milk and skim milk chocolate”.

§ 163.150 Sweet cocoa and vegetable fat coating.

(a) *Description.* Sweet cocoa and vegetable fat coating is the food that conforms to the definition and standard of identity, and is subject to the requirements for label declaration of ingredients for sweet chocolate in § 163.123, except that:

(1) In the preparation of the product, cocoa or a mixture of cocoa and chocolate liquor is used in such quantity that the finished food contains not less than 6.8 percent by weight of nonfat cacao solids, calculated on a moisture-free basis;

(2) One or more optional ingredients specified in paragraph (b) of this section are used; and

(3) The requirement in § 163.123(a)(2) limiting the total milk solids content to less than 12 percent by weight does not apply.

(b) *Optional ingredients.* (1) Breakfast cocoa, cocoa, lowfat cocoa;

(2) Chocolate liquor;

(3) Safe and suitable vegetable derived fats, oils, and stearins other than cacao fat. The fats, oils, and stearins may be hydrogenated;

(4) Safe and suitable dairy-derived ingredients; and

(5) Safe and suitable bulking agents, formulation aids, humectants, and texturizers.

(c) *Nomenclature.* The name of the food is “sweet cocoa and vegetable fat coating”. Alternatively, the common or usual name of the vegetable derived fat ingredient may be used in the name of the food, e.g., “sweet cocoa and _____ oil coating”, the blank being filled in with the common or usual name of the specific vegetable fat used.

§ 163.153 Sweet chocolate and vegetable fat coating.

(a) *Description.* Sweet chocolate and vegetable fat coating is the food that conforms to the definition and standard of identity, and is subject to the requirements for label declaration of ingredients for sweet chocolate in § 163.123, except that one or more optional ingredients specified in paragraph (b) of this section are used. Compliance with the requirement in § 163.123(a)(2) limiting the total milk solids content to less than 12 percent by weight shall be calculated by including only those dairy ingredients referred to in § 163.123(b)(4), exclusive of any added sweetener or other dairy-derived ingredient that is added beyond that amount that is normally present in the specified dairy ingredient.

(b) *Optional ingredients.* (1) Safe and suitable vegetable derived fats, oils, and stearins other than cacao fat. The fats, oils, and stearins may be hydrogenated;

(2) Safe and suitable dairy-derived ingredients; and

(3) Safe and suitable bulking agents, formulation aids, humectants, and texturizers.

(c) *Nomenclature.* The name of the food is “sweet chocolate and vegetable fat coating”. Alternatively, the common or usual name of the vegetable derived fat ingredient may be used in the name of the food, e.g., “sweet chocolate and _____ oil coating”, the blank being filled in with the common or usual name of the specific vegetable fat used.

§ 163.155 Milk chocolate and vegetable fat coating.

(a) *Description.* Milk chocolate and vegetable fat coating is the food that conforms to the standard of identity, and is subject to the requirements for label declaration of ingredients for milk chocolate in § 163.130 or skim milk chocolate in § 163.140, except that one or more optional ingredients specified in paragraph (b) of this section are used. Compliance with the requirement in § 163.130(a)(2) that the product contains not less than 12 percent by weight

of nonfat milk solids shall be calculated using only those dairy ingredients referred to in §163.130(b)(4), exclusive of any added sweetener or other dairy-derived ingredient that is added beyond that amount that is normally present in the specified dairy ingredient.

(b) *Optional ingredients.* (1) Safe and suitable vegetable derived oils, fats, and stearins other than cacao fat. The oils, fats, and stearins may be hydrogenated;

(2) Safe and suitable dairy-derived ingredients; and

(3) Safe and suitable bulking agents, formulation aids, humectants, and texturizers.

(c) *Nomenclature.* The name of the food is "milk chocolate and vegetable fat coating" or "skim milk chocolate and vegetable fat coating", as appropriate. Alternatively, the common or usual name of the vegetable derived fat ingredient may be used in the name of the food, e.g., "milk chocolate and _____ oil coating", the blank being filled in with the common or usual name of the specific vegetable fat used.

PART 164—TREE NUT AND PEANUT PRODUCTS

Subpart A [Reserved]

Subpart B—Requirements for Specific Standardized Tree Nut and Peanut Products

Sec.

164.110 Mixed nuts.

164.120 Shelled nuts in rigid or semirigid containers.

164.150 Peanut butter.

AUTHORITY: 21 U.S.C. 321, 341, 343, 348, 371, 379e.

SOURCE: 42 FR 14475, Mar. 15, 1977, unless otherwise noted.

Subpart A [Reserved]

Subpart B—Requirements for Specific Standardized Tree Nut and Peanut Products

§ 164.110 Mixed nuts.

(a) Mixed nuts is the food consisting of a mixture of four or more of the optional shelled tree nut ingredients,

with or without one or more of the optional shelled peanut ingredients, of the kinds prescribed by paragraph (b) of this section; except that when 2 ounces or less of the food is packed in transparent containers, three or more of the optional tree nut ingredients shall be present. Each such kind of nut ingredient when used shall be present in a quantity not less than 2 percent and not more than 80 percent by weight of the finished food. For purposes of this section, each kind of tree nut and peanut is an optional ingredient that may be prepared by any suitable method in accordance with good manufacturing practice. The finished food may contain one or more of the optional nonnut ingredients provided for in paragraph (c) of this section.

(b) The optional shelled nut ingredients referred to in paragraph (a) of this section are:

(1) Almonds, black walnuts, Brazil nuts, cashews, English walnuts (alternatively "walnuts"), filberts, pecans, and other suitable kinds of tree nuts.

(2) Peanuts of the Spanish, Valencia, Virginia, or similar varieties, or any combination of two or more such varieties.

(c) The optional nonnut ingredients referred to in paragraph (a) of this section consist of suitable substances that are not food additives as defined in section 201(s) of the Federal Food, Drug, and Cosmetic Act; or if they are food additives as so defined, they are used in conformity with regulations established pursuant to section 409 of the act. Nonnut ingredients that perform a useful function are regarded as suitable, except that color additives are not suitable ingredients of the food.

(d) The name of the food is "mixed nuts". If the percentage of a single tree nut ingredient or the total peanut content by weight of the finished food exceeds 50 percent but not 60 percent, the statement "contains up to 60% _____" or "contains 60% _____" or "60% _____" shall immediately follow the name "mixed nuts" and shall appear on the same background, be of the same color or, in the case of multicolors, in the color showing distinct contrast with the background, and be in letters not less than one-half the height of the largest letter in the words "mixed

§ 164.120

21 CFR Ch. I (4-1-07 Edition)

nuts". The blank is to be filled in with the appropriate name of the predominant nut ingredient; for example, "contains up to 60% pecans" or "contains up to 60% Spanish peanuts". The numbers "70" or "80" shall be substituted for the number "60" when the percentage of the predominant nut ingredient exceeds 60 but not 70, or exceeds 70 but not 80, respectively. Compliance with the requirements for percentage of nut ingredients of this section and the fill of container requirements of §164.120(c) will be determined by the following procedure:

(1) Take at random from a lot, in the case of containers bearing a weight declaration of 16 ounces or less, at least 24 containers, and for containers bearing a weight declaration of more than 16 ounces, enough containers to provide a total quantity of at least 24 pounds of nuts.

(2) If compliance with §164.120(c) is to be determined, first follow the procedure set forth therein.

(3) Determine the percent by weight of each nut ingredient present in each container separately. Calculate the average percentage of each nut ingredient present. If the average percent found for each nut ingredient present is 2 percent or more and none of the individual nut ingredients exceeds 80 percent by weight of the finished food, the lot will be deemed to be in compliance with the percentage requirements of paragraph (a) of this section. If the average percent found for a single nut ingredient exceeds 50 percent by weight of the finished food and the average percent found is within the range indicated by the number declared on the label in accordance with this paragraph, the lot will be deemed to be in compliance with the labeling requirements of this paragraph.

(e) *Label declaration.* Each of the ingredients used in the food shall be declared on the label as required by the applicable sections of parts 101 and 130 of this chapter, except that:

(1) If the Spanish variety of peanuts is used, it shall be declared as "Spanish peanuts". Other varieties of peanuts shall be declared as "peanuts", or alternatively "_____ peanuts", the blank being filled in with the varietal name of the peanuts used.

(2) If the peanut ingredient or ingredients as provided for in paragraph (b)(2) of this section are unblanched, the label shall show that fact by such statement as "Peanuts unblanched", "Peanuts skins on", or words of similar import, unless the vignette clearly depicts peanuts with skins on.

(f) The words and statements specified in paragraph (e) of this section showing the ingredients present shall be listed on the principal display panel or panels or any appropriate information panel without obscuring design, vignettes, or crowding. The declaration shall appear in conspicuous and easily legible letters of boldface print or type the size of which shall be not less than one-half of that required by part 101 of this chapter for the statement of net quantity of contents appearing on the label, but in no case less than one-sixteenth of an inch in height. The entire ingredient statement shall appear on at least one panel of the label. If the label bears any pictorial representation of the mixture of nuts, it shall depict the relative proportions of the nut ingredients of the food. If the label bears a pictorial representation of only one of each nut ingredient present, the nuts shall be depicted in the order of decreasing predominance by weight. A factual statement that the food does not contain a particular nut ingredient or ingredients may be shown on the label if the statement is not misleading and does not result in an insufficiency of label space for the proper declaration of information required by or under authority of the act to appear on the label.

[42 FR 14475, Mar. 15, 1977, as amended at 58 FR 2885, Jan. 6, 1993]

§ 164.120 Shelled nuts in rigid or semirigid containers.

(a)-(b) [Reserved]

(c) *Fill of container.* (1) The standard of fill for shelled nuts in rigid or semirigid containers is a fill such that the average volume of nuts, from the number of containers specified in §164.110(d)(1), is not less than 85 percent of the container volume as determined by the method in paragraph (c)(2) of this section.

(2) The method for determining the percent of fill is as follows:

(i) For the shelled nuts in each container, determine the loose volume, the settled volume, and the average volume in cubic centimeters. For the purposes of this subparagraph, consider volume in milliliters to be numerically equal to volume in cubic centimeters. Open the container and pour the nuts loosely into a vertical graduated cylinder (do not tilt) of appropriate size fitted with a funnel which has been modified, if necessary, to provide a minimum opening of 1½-inch diameter. (If the loose volume of the nuts is less than 500 milliliters, use a 500-milliliter cylinder with an inside diameter of approximately 1⅞ inches; but if the loose volume is 500 milliliters or more, use a 1,000-milliliter cylinder with an inside diameter of approximately 2¼ inches.) Without shaking the cylinder, estimate the location of a horizontal plane representing the average height of the product, read the volume of the nuts, and record as the loose volume. Raise the cylinder 2 inches and allow it a free vertical drop onto a level, firm, but resilient surface (do not tamp) for a total of 5 times and observe the volume as above. Repeat in successive five-drop increments until the nuts have so settled that the volume decreases less than 2 percent in the last five-drop increment. Read the last volume in the manner described above and record as the settled volume. The arithmetical average of the loose volume and the settled volume equals the average volume of nuts.

(ii) Classify the container by shape and determine its volume in cubic centimeters according to one of the following methods as appropriate:

(a) For containers of irregular shape, including glass jars, follow the general method for water capacity of containers as prescribed in §130.12(a) of this chapter and determine the container volume, considering the water capacity in grams to be numerically equivalent to volume in cubic centimeters, or the water capacity in ounces (avoirdupois) to be equivalent to 28.35 cubic centimeters per ounce.

(b) For box-shaped containers (that is, with opposite sides parallel), measure the inside height, width, and depth and calculate the volume as the product of these three dimensions. For such

containers used to enclose vacuum packs and containing 4 ounces or less of the product, consider the height to be the inside height minus three-eighths inch.

(c) For cylindrical containers, calculate the container volume in cubic centimeters as the product of the height times the square of the diameter, both measured in inches, times 12.87; or as the product of the height times the square of the diameter, both measured in centimeters, times 0.7854. For containers that do not have indented ends, use the inside height and inside diameter as the dimensions. For metal cans with indented ends (that is, metal cans with ends attached by double seams), consider the height to be the outside height at the double seam minus three-eighths inch (0.953 centimeter) and the diameter to be the outside diameter at the double seam minus one-eighth inch (0.318 centimeter). For fiber-bodied containers with indented ends (that is, fiber-bodied cans with metal ends attached by double seams), consider the height to be the outside height at the double seam minus three-eighths inch (0.953 centimeter) and the diameter to be the outside diameter at the double seam minus three-sixteenths inch (0.476 centimeter).

(iii) Calculate the percent fill of the container as follows: Divide the average volume of nuts found according to paragraph (c)(2)(i) of this section by the appropriate container volume found according to paragraph (c)(2)(ii) of this section and multiply by 100. The result shall be considered to be the percent fill of the container.

(3) If shelled nuts fall below the standard of fill of container prescribed in paragraph (c)(1) of this section, the label shall bear the general statement of substandard fill specified in §130.14(b) of this chapter, in the manner and form therein specified.

§ 164.150 Peanut butter.

(a) Peanut butter is the food prepared by grinding one of the shelled and roasted peanut ingredients provided for by paragraph (b) of this section, to which may be added safe and suitable seasoning and stabilizing ingredients provided for by paragraph (c) of this

section, but such seasoning and stabilizing ingredients do not in the aggregate exceed 10 percent of the weight of the finished food. To the ground peanuts, cut or chopped, shelled, and roasted peanuts may be added. During processing, the oil content of the peanut ingredient may be adjusted by the addition or subtraction of peanut oil. The fat content of the finished food shall not exceed 55 percent when determined as prescribed in "Official Methods of Analysis of the Association of Official Analytical Chemists," 13th Ed. (1980), section 27.006(a) under "Crude Fat—Official First Action, Direct Method," in paragraph (a), which is incorporated by reference. Copies may be obtained from the AOAC INTERNATIONAL, 481 North Frederick Ave., suite 500, Gaithersburg, MD 20877, or may be examined at the National Archives and Records Administration (NARA). For information on the availability of this material at NARA, call 202-741-6030, or go to: http://www.archives.gov/federal_register/code_of_federal_regulations/ibr_locations.html.

(b) The peanut ingredients referred to in paragraph (a) of this section are:

(1) Blanched peanuts, in which the germ may or may not be included.

(2) Unblanched peanuts, including the skins and germ.

(c) The seasoning and stabilizing ingredients referred to in paragraph (a) of this section are suitable substances which are not food additives as defined in section 201(s) of the Federal Food, Drug, and Cosmetic Act (the act), or if they are food additives as so defined, they are used in conformity with regulations established pursuant to section 409 of the act. Seasoning and stabilizing ingredients that perform a useful function are regarded as suitable, except that artificial flavorings, artificial sweeteners, chemical preservatives, and color additives are not suitable ingredients in peanut butter. Oil products used as optional stabilizing ingredients shall be hydrogenated vegetable oils. For the purposes of this section, hydrogenated vegetable oil shall be considered to include partially hydrogenated vegetable oil.

(d) If peanut butter is prepared from unblanched peanuts as specified in

paragraph (b)(2) of this section, the name shall show that fact by some such statement as "prepared from unblanched peanuts (skins left on)." Such statement shall appear prominently and conspicuously and shall be in type of the same style and not less than half of the point size of that used for the words "peanut butter." This statement shall immediately precede or follow the words "peanut butter," without intervening written, printed, or graphic matter.

(e) *Label declaration.* Each of the ingredients used in the food shall be declared on the label as required by the applicable sections of parts 101 and 130 of this chapter.

[42 FR 14475, Mar. 15, 1977, as amended at 47 FR 11834, Mar. 19, 1982; 49 FR 10103, Mar. 19, 1984; 54 FR 24896, June 12, 1989; 58 FR 2886, Jan. 6, 1993; 61 FR 9325, Mar. 8, 1996; 63 FR 14035, Mar. 24, 1998]

PART 165—BEVERAGES

Subpart A—General Provisions

Sec.

165.3 Definitions.

Subpart B—Requirements for Specific Standardized Beverages

165.110 Bottled water.

AUTHORITY: 21 U.S.C. 321, 341, 343, 343-1, 348, 349, 371, 379e.

SOURCE: 60 FR 57124, Nov. 13, 1995, unless otherwise noted.

Subpart A—General Provisions

§ 165.3 Definitions.

(a) *A lot* is:

(1) For purposes of determining quality factors related to manufacture, processing, or packing, a collection of primary containers or units of the same size, type, and style produced under conditions as nearly uniform as possible and usually designated by a common container code or marking, or in the absence of any common container code or marking, a day's production.

(2) For purposes of determining quality factors related to distribution and storage, a collection of primary containers or units transported, stored, or

held under conditions as nearly uniform as possible.

(b) A *sample* consists of 10 subsamples (consumer units), one taken from each of 10 different randomly chosen shipping cases to be representative of a given lot, unless otherwise specified in a specific standard in this part.

(c) An *analytical unit* is the portion(s) of food taken from a subsample of a sample for the purpose of analysis.

Subpart B—Requirements for Specific Standardized Beverages

§ 165.110 Bottled water.

(a) *Identity*—(1) *Description*. Bottled water is water that is intended for human consumption and that is sealed in bottles or other containers with no added ingredients except that it may optionally contain safe and suitable antimicrobial agents. Fluoride may be optionally added within the limitations established in § 165.110(b)(4)(ii). Bottled water may be used as an ingredient in beverages (e.g., diluted juices, flavored bottled waters). It does not include those food ingredients that are declared in ingredient labeling as “water,” “carbonated water,” “disinfected water,” “filtered water,” “seltzer water,” “soda water,” “sparkling water,” and “tonic water.” The processing and bottling of bottled water shall comply with applicable regulations in part 129 of this chapter.

(2) *Nomenclature*. The name of the food is “bottled water,” “drinking water,” or alternatively one or more of the following terms as appropriate:

(i) The name of water from a well tapping a confined aquifer in which the water level stands at some height above the top of the aquifer is “artesian water” or “artesian well water.” Artesian water may be collected with the assistance of external force to enhance the natural underground pressure. On request, plants shall demonstrate to appropriate regulatory officials that the water level stands at some height above the top of the aquifer.

(ii) The name of water from a subsurface saturated zone that is under a pressure equal to or greater than atmospheric pressure is “ground water.” Ground water must not be under the di-

rect influence of surface water as defined in 40 CFR 141.2.

(iii) The name of water containing not less than 250 parts per million (ppm) total dissolved solids (TDS), coming from a source tapped at one or more bore holes or springs, originating from a geologically and physically protected underground water source, may be “mineral water.” Mineral water shall be distinguished from other types of water by its constant level and relative proportions of minerals and trace elements at the point of emergence from the source, due account being taken of the cycles of natural fluctuations. No minerals may be added to this water.

(iv) The name of water that has been produced by distillation, deionization, reverse osmosis, or other suitable processes and that meets the definition of “purified water” in the United States Pharmacopeia, 23d Revision, January 1, 1995, which is incorporated by reference in accordance with 5 U.S.C. 551(a) and 1 CFR part 51. (Copies may be obtained from the United States Pharmacopial Convention, Inc., 12601 Twinbrook Pkwy., Rockville, MD 20852 and may be examined at the Center for Food Safety and Applied Nutrition’s Library, 5100 Paint Branch Pkwy., College Park, MD 20740, or at the National Archives and Records Administration (NARA). For information on the availability of this material at NARA, call 202-741-6030, or go to: http://www.archives.gov/federal_register/code_of_federal_regulations/ibr_locations.html), may be “purified water” or “demineralized water.” Alternatively, the water may be called “deionized water” if the water has been processed by deionization, “distilled water” if it is produced by distillation, “reverse osmosis water” if the water has been processed by reverse osmosis, and “_____ drinking water” with the blank being filled in with one of the defined terms describing the water in this paragraph (e.g., “purified drinking water” or “deionized drinking water”).

(v) The name of water that, after treatment and possible replacement of carbon dioxide, contains the same amount of carbon dioxide from the source that it had at emergence from

the source may be “sparkling bottled water.”

(vi) The name of water derived from an underground formation from which water flows naturally to the surface of the earth may be “spring water.” Spring water shall be collected only at the spring or through a bore hole tapping the underground formation feeding the spring. There shall be a natural force causing the water to flow to the surface through a natural orifice. The location of the spring shall be identified. Spring water collected with the use of an external force shall be from the same underground stratum as the spring, as shown by a measurable hydraulic connection using a hydrogeologically valid method between the bore hole and the natural spring, and shall have all the physical properties, before treatment, and be of the same composition and quality, as the water that flows naturally to the surface of the earth. If spring water is collected with the use of an external force, water must continue to flow naturally to the surface of the earth through the spring’s natural orifice. Plants shall demonstrate, on request, to appropriate regulatory officials, using a hydrogeologically valid method, that an appropriate hydraulic connection exists between the natural orifice of the spring and the bore hole.

(vii) The name of water that meets the requirements under “Sterility Tests” <71> in the United States Pharmacopeia, 23d Revision, January 1, 1995, which is incorporated by reference in accordance with 5 U.S.C. 552(a) and 1 CFR 51. (Copies may be obtained from the United States Pharmacopeial Convention, Inc., 12601 Twinbrook Pkwy., Rockville, MD 20852 and may be examined at the Center for Food Safety and Applied Nutrition’s Library, 5100 Paint Branch Pkwy., College Park, MD 20740, or at the National Archives and Records Administration (NARA). For information on the availability of this material at NARA, call 202-741-6030, or go to: http://www.archives.gov/federal_register/code_of_federal_regulations/ibr_locations.html), may be “sterile water.” Alternatively, the water may be called “sterilized water.”

(viii) The name of water from a hole bored, drilled, or otherwise constructed in the ground which taps the water of an aquifer may be “well water.”

(3) *Other label statements.* (i) If the TDS content of mineral water is below 500 ppm, or if it is greater than 1,500 ppm, the statement “low mineral content” or the statement “high mineral content”, respectively, shall appear on the principal display panel following the statement of identity in type size at least one-half the size of the statement of identity but in no case of less than one-sixteenth of an inch. If the TDS of mineral water is between 500 and 1,500 ppm, no additional statement need appear.

(ii) When bottled water comes from a community water system, as defined in 40 CFR 141.2, except when it has been treated to meet the definitions in paragraphs (a)(2)(iv) and (a)(2)(vii) of this section and is labeled as such, the label shall state “from a community water system” or, alternatively, “from a municipal source” as appropriate, on the principal display panel or panels. This statement shall immediately and conspicuously precede or follow the name of the food without intervening written, printed, or graphic matter, other than statements required by paragraph (c) of this section, in type size at least one-half the size of the statement of identity but in no case of less than one-sixteenth of an inch.

(iii) When the label or labeling of a bottled water product states or implies (e.g., through label statements or vignettes with references to infants) that the bottled water is for use in feeding infants, and the product is not commercially sterile under §113.3(e)(3)(i) of this chapter, the product’s label shall bear conspicuously and on the principal display panel the statement “Not sterile. Use as directed by physician or by labeling directions for use of infant formula.”

(4) *Label declaration.* Each of the ingredients used in the food shall be declared on the label as required by the applicable sections of parts 101 and 130 of this chapter.

(b) *Quality.* The standard of quality for bottled water, including water for use as an ingredient in beverages (except those described in the labeling as

“water,” “carbonated water,” “disinfected water,” “filtered water,” “seltzer water,” “soda water,” “sparkling water,” and “tonic water”), is as follows:

(1) *Definitions.* (i) *Trihalomethane (THM)* means one of the family of organic compounds, named as derivatives of methane, wherein three of the four hydrogen atoms in methane are each substituted by a halogen atom in the molecular structure.

(ii) *Total trihalomethanes (TTHM)* means the sum of the concentration in milligrams per liter of the trihalomethane compounds (trichloromethane, dibromochloromethane, bromodichloromethane, and tribromomethane), rounded to two significant figures.

(iii) *Haloacetic acids (five) (HAA5)* means the sum of the concentrations in milligrams per liter of the haloacetic acid compounds (monochloroacetic acid, dichloroacetic acid, trichloroacetic acid, monobromoacetic acid, and dibromoacetic acid), rounded to two significant figures after addition.

(2) *Microbiological quality.* Bottled water shall, when a sample consisting of analytical units of equal volume is examined by the methods described in applicable sections of “Standard Methods for the Examination of Water and Wastewater,” 15th Ed. (1980), American Public Health Association, which is incorporated by reference in accordance with 5 U.S.C. 552(a) and 1 CFR part 51 (copies may be obtained from the American Public Health Association, 800 I St. NW., Washington, DC 20001, or a copy may be examined at the National Archives and Records Administration (NARA), or at the Center for Food Safety and Applied Nutrition’s Library, 200 C St., SW., Washington, DC, for information on the availability of this material at NARA, call 202-741-6030, or go to: http://www.archives.gov/federal_register/code_of_federal_regulations/ibr_locations.html), meet the following standards of microbiological quality:

(i) *Multiple-tube fermentation method.* Not more than one of the analytical units in the sample shall have a most probable number (MPN) of 2.2 or more coliform organisms per 100 milliliters

and no analytical unit shall have an MPN of 9.2 or more coliform organisms per 100 milliliters; or

(ii) *Membrane filter method.* Not more than one of the analytical units in the sample shall have 4.0 or more coliform organisms per 100 milliliters and the arithmetic mean of the coliform density of the sample shall not exceed one coliform organism per 100 milliliters.

(3) *Physical quality.* Bottled water shall, when a composite of analytical units of equal volume from a sample is examined by the method described in applicable sections of “Standard Methods for the Examination of Water and Wastewater,” 15th Ed. (1980), which is incorporated by reference (the availability of this incorporation by reference is given in paragraph (b)(2) of this section), meet the following standards of physical quality:

(i) The turbidity shall not exceed 5 units.

(ii) The color shall not exceed 15 units.¹

(iii) The odor shall not exceed threshold odor No. 3.¹

(4) *Chemical quality.* (i)(A) Bottled water shall, when a composite of analytical units of equal volume from a sample is examined by the methods described in paragraph (b)(4)(i)(B) of this section, meet standards of chemical quality and shall not contain chemical substances in excess of the following concentrations:

Substance	Concentration in milligrams per liter
Chloride ¹	250.0
Iron ¹	0.3
Manganese ¹	0.05
Phenols	0.001
Total dissolved solids ¹	500.0
Zinc ¹	5.0

¹Mineral water is exempt from allowable level. The exemptions are aesthetically based allowable levels and do not relate to a health concern.

(B) Analyses conducted to determine compliance with paragraph (b)(4)(i)(A) of this section shall be made in accordance with the methods described in the applicable sections of “Standard Methods for the Examination of Water and Wastewater,” 15th Ed. (1980), or

¹Mineral water is exempt from allowable level. The exemptions are aesthetically based allowable levels and do not relate to a health concern.

“Methods for Chemical Analysis of Water and Wastes,” Environmental Monitoring and Support Laboratory (EMSL), EPA-600/4-79-020, March 1983, U.S. Environmental Protection Agency (EPA), both of which are incorporated by reference in accordance with 5 U.S.C. 552(a) and 1 CFR part 51.

(C) Analyses for organic substances shall be determined by the appropriate methods set forth below. The methods in paragraphs (b)(4)(i) (C)(1) and (C)(2) of this section are incorporated by reference in accordance with 5 U.S.C. 552(a) and 1 CFR part 51 and are described in “Standard Methods for Examination of Water and Wastewater,” 15th Ed. (1980). Copies may be obtained from the American Public Health Association, 800 I St. NW., Washington DC 20001, and examined at the National Archives and Records Administration (NARA), or the Center for Food Safety and Applied Nutrition’s Library, 200 C St. NW., Washington DC. For information on the availability of this material at NARA, call 202-741-6030, or go to:

http://www.archives.gov/federal_register/code_of_federal_regulations/ibr_locations.html. The methods in paragraphs (b)(4)(i)(C)(3) and (C)(4) are cross-referenced in 40 CFR part 141, subpart C, appendix C.

(1) “Methods for Organochlorine Pesticides in Industrial Effluents;”

(2) “Methods for Chlorinated Phenoxy Acid Herbicides in Industrial Effluents,” November 28, 1973;

(3) “Part I: The Analysis of Trihalomethanes in Finished Waters by the Purge and Trap Method;” which is cross-referenced in 40 CFR part 141, subpart C, appendix C;

(4) “Part II: The Analysis of Trihalomethanes in Drinking Water by Liquid/Liquid Extraction,” which is cross-referenced in 40 CFR part 141, subpart C, appendix C;

(ii)(A) Bottled water packaged in the United States to which no fluoride is added shall not contain fluoride in excess of the levels in Table 1 and these levels shall be based on the annual average of maximum daily air tempera-

tures at the location where the bottled water is sold at retail.

TABLE 1

Annual average of maximum daily air temperatures (°F)	Fluoride concentration in milligrams per liter
53.7 and below	2.4
53.8–58.3	2.2
58.4–63.8	2.0
63.9–70.6	1.8
70.7–79.2	1.6
79.3–90.5	1.4

(B) Imported bottled water to which no fluoride is added shall not contain fluoride in excess of 1.4 milligrams per liter.

(C) Bottled water packaged in the United States to which fluoride is added shall not contain fluoride in excess of levels in Table 2 and these levels shall be based on the annual average of maximum daily air temperatures at the location where the bottled water is sold at retail.

TABLE 2

Annual average of maximum daily air temperatures (°F)	Fluoride concentration in milligrams per liter
53.7 and below	1.7
53.8–58.3	1.5
58.4–63.8	1.3
63.9–70.6	1.2
70.7–79.2	1.0
79.3–90.5	0.8

(D) Imported bottled water to which fluoride is added shall not contain fluoride in excess of 0.8 milligram per liter.

(iii) Having consulted with EPA as required by section 410 of the Federal Food, Drug, and Cosmetic Act, the Food and Drug Administration has determined that bottled water, when a composite of analytical units of equal volume from a sample is examined by the methods listed in paragraphs (b)(4)(iii)(E) through (b)(4)(iii)(F), and (b)(4)(iii)(G) of this section, shall not contain the following chemical contaminants in excess of the concentrations specified in paragraphs (b)(4)(iii)(A) through (b)(4)(iii)(D) of this section.

(A) The allowable levels for inorganic substances are as follows:

Contaminant	Concentration in milligrams per liter (or as specified)
Arsenic	0.010
Antimony	.006
Barium	2
Beryllium	0.004
Cadmium	0.005
Chromium	0.1
Copper	1.0
Cyanide	0.2
Lead	0.005
Mercury	0.002
Nickel	0.1
Nitrate	10 (as nitrogen)
Nitrite	1 (as nitrogen)
Total Nitrate and Nitrite	10 (as nitrogen)
Selenium	0.05
Thallium	0.002

(B) The allowable levels for volatile organic chemicals (VOC's) are as follows:

Contaminant (CAS Reg. No.)	Concentration in milligrams per liter
Benzene (71-43-2)	0.005
Carbon tetrachloride (56-23-5)	0.005
<i>o</i> -Dichlorobenzene (95-50-1)	0.6
<i>p</i> -Dichlorobenzene (106-46-7)	0.075
1,2-Dichloroethane (107-06-2)	0.005
1,1-Dichloroethylene (75-35-4)	0.007
<i>cis</i> -1,2-Dichloroethylene (156-59-2)	0.07
<i>trans</i> -1,2-Dichloroethylene (156-60-5)	0.1
Dichloromethane (75-09-2)	0.005
1,2-Dichloropropane (78-87-5)	0.005
Ethylbenzene (100-41-4)	0.7
Monochlorobenzene (108-90-7)	0.1
Styrene (100-42-5)	0.1
Tetrachloroethylene (127-18-4)	0.005
Toluene (108-88-3)	1
1,2,4-Trichlorobenzene (120-82-1)	0.07
1,1,1-Trichloroethane (71-55-6)	0.20
1,1,2-Trichloroethane (79-00-5)	0.005
Trichloroethylene (79-01-6)	0.005
Vinyl chloride (75-01-4)	0.002
Xylenes (1330-20-7)	10

(C) The allowable levels for pesticides and other synthetic organic chemicals (SOC's) are as follows:

Contaminant (CAS Reg. No.)	Concentration in milligrams per liter
Alachlor (15972-60-8)	0.002
Atrazine (1912-24-9)	0.003
Benzo(a)pyrene (50-32-8)	0.0002
Carbofuran (1563-66-2)	0.04
Chlordane (57-74-9)	0.002
Dalapon (75-99-0)	0.2
1,2-Dibromo-3-chloropropane (96-12-8)	0.0002
2,4-D (94-75-7)	0.07
Di(2-ethylhexyl)adipate (103-23-1)	0.4
Dinoseb (88-85-7)	0.007
Diquat (85-00-7)	0.02
Endothall (145-73-3)	0.1
Endrin (72-20-8)	0.002
Ethylene dibromide (106-93-4)	0.00005
Glyphosate (1071-53-6)	0.7
Heptachlor (76-44-8)	0.0004
Heptachlor epoxide (1024-57-3)	0.0002
Hexachlorobenzene (118-74-4)	0.001

Contaminant (CAS Reg. No.)	Concentration in milligrams per liter
Hexachlorocyclopentadiene (77-47-4) ...	0.05
Lindane (58-89-9)	0.0002
Methoxychlor (72-43-5)	0.04
Oxamyl (23135-22-0)	0.2
Pentachlorophenol (87-86-5)	0.001
PCB's (as decachlorobiphenyl) (1336-36-3)	0.0005
Picloram (1918-02-1)	0.5
Simazine (122-34-9)	0.004
2,3,7,8-TCDD (Dioxin) (1746-01-6)	3x10 ⁻⁸
Toxaphene (8001-35-2)	0.003
2,4,5-TP (Silvex) (93-72-1)	0.05

(D) The allowable levels for certain chemicals for which EPA has established secondary maximum contaminant levels in its drinking water regulations (40 CFR part 143) are as follows:

Contaminant	Concentration in milligrams per liter
Aluminum	0.2
Silver	0.1
Sulfate ¹	250.0

¹ Mineral water is exempt from allowable level. The exemptions are aesthetically based allowable levels and do not relate to a health concern.

(E) Analyses to determine compliance with the requirements of paragraph (b)(4)(iii)(A) of this section shall be conducted in accordance with an applicable method and applicable revisions to the methods listed in paragraphs (b)(4)(iii)(E)(I) through (b)(4)(iii)(E)(I4) of this section and described, unless otherwise noted, in "Methods for Chemical Analysis of Water and Wastes," U.S. EPA Environmental Monitoring and Support Laboratory (EMSL), Cincinnati, OH 45258 (EPA-600/4-79-020), March 1983, which is incorporated by reference in accordance with 5 U.S.C. 552(a) and 1 CFR

part 51. Copies of this publication are available from the National Technical Information Service (NTIS), U.S. Department of Commerce, 5825 Port Royal Rd., Springfield, VA 22161, or may be examined at the Center for Food Safety and Applied Nutrition's Library, Food and Drug Administration, 5100 Paint Branch Pkwy., College Park, MD 20740, or at the National Archives and Records Administration (NARA). For information on the availability of this material at NARA, call 202-741-6030, or go to: http://www.archives.gov/federal_register/code_of_federal_regulations/ibr_locations.html.

(I) Antimony shall be measured using the following methods:

(i) Method 204.2—"Atomic Absorption; furnace technique," which is incorporated by reference in accordance with 5 U.S.C. 552(a) and 1 CFR part 51. The availability of this incorporation by reference is given in paragraph (b)(4)(iii)(E) of this section.

(ii) Method 200.8—"Determination of Trace Elements in Water and Wastes by Inductively Coupled Plasma-Mass Spectrometry," Rev. 4.4, April 1991, U.S. EPA, EMSL. The revision is contained in the manual entitled "Methods for the Determination of Metals in Environmental Samples," Office of Research and Development, Washington, DC 20460, (EPA/600/4-91/010), June 1991, which is incorporated by reference in accordance with 5 U.S.C. 552(a) and 1 CFR part 51. Copies of this publication are available from the National Technical Information Service, U.S. Department of Commerce, 5825 Port Royal Rd., Springfield, VA 22161, or may be examined at the Center for Food Safety and Applied Nutrition's Library, Food and Drug Administration, 5100 Paint Branch Pkwy., College Park, MD 20740, or at the National Archives and Records Administration (NARA). For information on the availability of this material at NARA, call 202-741-6030, or go to: http://www.archives.gov/federal_register/code_of_federal_regulations/ibr_locations.html.

(iii) Method 200.9—"Determination of Trace Elements by Stabilized Temperature Graphite Furnace Atomic Absorption Spectrometry," Rev. 1.2, April

1991, U.S. EPA, EMSL. The revision is contained in the manual entitled "Methods for the Determination of Metals in Environmental Samples," Office of Research and Development, Washington, DC 20460, (EPA/600/4-91/010), June 1991, which is incorporated by reference in accordance with 5 U.S.C. 552(a) and 1 CFR part 51. The availability of this incorporation by reference is given in paragraph (b)(4)(iii)(E)(I)(ii) of this section.

(iv) Method D-3697-92—"Standard Test Method for Antimony in Water," contained in the Annual Book of ASTM Standards, vols. 11.01 and 11.02, 1995, American Society for Testing and Materials, 100 Barr Harbor Dr., West Conshohocken, PA 19428, which is incorporated by reference in accordance with 5 U.S.C. 552(a) and 1 CFR part 51. Copies of this publication are available from American Society for Testing and Materials, 100 Barr Harbor Dr., West Conshohocken, PA 19428, or may be examined at the Center for Food Safety and Applied Nutrition's Library, Food and Drug Administration, 5100 Paint Branch Pkwy., College Park, MD 20740, or at the National Archives and Records Administration (NARA). For information on the availability of this material at NARA, call 202-741-6030, or go to: http://www.archives.gov/federal_register/code_of_federal_regulations/ibr_locations.html.

(2) Barium shall be measured using the following methods:

(i) Method 208.2—"Atomic Absorption; furnace technique," which is incorporated by reference in accordance with 5 U.S.C. 552(a) and 1 CFR part 51, or

(ii) Method 208.1—"Atomic Absorption; direct aspiration," which is incorporated by reference in accordance with 5 U.S.C. 552(a) and 1 CFR part 51. The availability of this incorporation by reference is given in paragraph (b)(4)(iii)(E) of this section.

(iii) Method 200.7—"Determination of Metals and Trace Elements in Water and Wastes by Inductively Coupled Plasma-Atomic Emission Spectrometry," Rev. 3.3, April 1991, U.S. EPA, EMSL. The revision is contained in the

manual entitled "Methods for the Determination of Metals in Environmental Samples," Office of Research and Development, Washington, DC 20460, (EPA/600/4-91/010), June 1991, which is incorporated by reference in accordance with 5 U.S.C. 552(a) and 1 CFR part 51. The availability of this incorporation by reference is given in paragraph (b)(4)(iii)(E)(I)(ii) of this section.

(3) Beryllium shall be measured using the following methods:

(i) Method 210.2—"Atomic Absorption; Furnace Technique," which is incorporated by reference in accordance with 5 U.S.C. 552(a) and 1 CFR part 51. The availability of this incorporation by reference is given in paragraph (b)(4)(iii)(E) of this section.

(ii) Method 200.7—"Determination of Metals and Trace Elements in Water and Wastes by Inductively Coupled Plasma-Atomic Emission Spectrometry," Rev. 3.3, April 1991, U.S. EPA, EMSL. The revision is contained in the manual entitled "Methods for the Determination of Metals in Environmental Samples," Office of Research and Development, Washington, DC 20460, (EPA/600/4-91/010), June 1991, which is incorporated by reference in accordance with 5 U.S.C. 552(a) and 1 CFR part 51. The availability of this incorporation by reference is given in paragraph (b)(4)(iii)(E)(I)(ii) of this section.

(iii) Method 200.8—"Determination of Trace Elements in Water and Wastes by Inductively Coupled Plasma-Mass Spectrometry," Rev. 4.4, April 1991, U.S. EPA, EMSL. The revision is contained in the manual entitled "Methods for the Determination of Metals in Environmental Samples," Office of Research and Development, Washington, DC 20460, (EPA/600/4-91/010), June 1991, which is incorporated by reference in accordance with 5 U.S.C. 552(a) and 1 CFR part 51. The availability of this incorporation by reference is given in paragraph (b)(4)(iii)(E)(I)(ii) of this section.

(iv) Method 200.9—"Determination of Trace Elements by Stabilized Temperature Graphite Furnace Atomic Absorption Spectrometry," Rev. 1.2, April 1991, U.S. EPA, EMSL. The revision is contained in the manual entitled

"Methods for the Determination of Metals in Environmental Samples," Office of Research and Development, Washington, DC 20460, (EPA/600/4-91/010), June 1991, which is incorporated by reference in accordance with 5 U.S.C. 552(a) and 1 CFR part 51. The availability of this incorporation by reference is given in paragraph (b)(4)(iii)(E)(I)(ii) of this section.

(4) Cadmium shall be measured using the following methods:

(i) Method 213.2—"Atomic Absorption; Furnace Technique," which is incorporated by reference in accordance with 5 U.S.C. 552(a) and 1 CFR part 51. The availability of this incorporation by reference is given in paragraph (b)(4)(iii)(E) of this section.

(ii) Method 200.7—"Determination of Metals and Trace Elements in Water and Wastes by Inductively Coupled Plasma-Atomic Emission Spectrometry," Rev. 3.3, April 1991, U.S. EPA, EMSL. The revision is contained in the manual entitled "Methods for the Determination of Metals in Environmental Samples," Office of Research and Development, Washington, DC 20460, (EPA/600/4-91/010), June 1991, which is incorporated by reference in accordance with 5 U.S.C. 552(a) and 1 CFR part 51. The availability of this incorporation by reference is given in paragraph (b)(4)(iii)(E)(I)(ii) of this section.

(5) Chromium shall be measured using the following methods:

(i) Method 218.2—"Atomic Absorption; furnace technique," which is incorporated by reference in accordance with 5 U.S.C. 552(a) and 1 CFR part 51. The availability of this incorporation by reference is given in paragraph (b)(4)(iii)(E) of this section.

(ii) Method 200.7—"Determination of Metals and Trace Elements in Water and Wastes by Inductively Coupled Plasma-Atomic Emission Spectrometry," Rev. 3.3, April 1991, U.S. EPA, EMSL. The revision is contained in the manual entitled "Methods for the Determination of Metals in Environmental Samples," Office of Research and Development, Washington, DC 20460, (EPA/600/4-91/010), June 1991, which is incorporated by reference in accordance with 5 U.S.C. 552(a) and 1

CFR part 51. The availability of this incorporation by reference is given in paragraph (b)(4)(iii)(E)(I)(ii) of this section.

(6) Copper shall be measured as total recoverable metal without filtration using the following methods:

(i) Method 220.2—“Atomic Absorption; furnace technique,” which is incorporated by reference in accordance with 5 U.S.C. 552(a) and 1 CFR part 51, or

(ii) Method 220.1—“Atomic Absorption; direct aspiration,” which is incorporated by reference in accordance with 5 U.S.C. 552(a) and 1 CFR part 51. The availability of these incorporation by reference is given in paragraph (b)(4)(iii)(E) of this section.

(iii) Method 200.7—“Determination of Metals and Trace Elements in Water and Wastes by Inductively Coupled Plasma-Atomic Emission Spectrometry,” Rev. 3.3, April 1991, U.S. EPA, EMSL. The revision is contained in the manual entitled “Methods for the Determination of Metals in Environmental Samples,” Office of Research and Development, Washington, DC 20460, (EPA/600/4-91/010), June 1991, which is incorporated by reference in accordance with 5 U.S.C. 552(a) and 1 CFR part 51. The availability of this incorporation by reference is given in paragraph (b)(4)(iii)(E)(I)(ii) of this section.

(iv) Method 200.8—“Determination of Trace Elements in Water and Wastes by Inductively Coupled Plasma-Mass Spectrometry,” Rev. 4.4, April 1991, U.S. EPA, EMSL. The revision is contained in the manual entitled “Methods for the Determination of Metals in Environmental Samples,” Office of Research and Development, Washington, DC 20460, (EPA/600/4-91/010), June 1991, which is incorporated by reference in accordance with 5 U.S.C. 552(a) and 1 CFR part 51. The availability of this incorporation by reference is given in paragraph (b)(4)(iii)(E)(1)(ii) of this section.

(v) Method 200.9—“Determination of Trace Elements by Stabilized Temperature Graphite Furnace Atomic Absorption Spectrometry,” Rev. 1.2, April 1991, U.S. EPA, EMSL. The revision is contained in the manual entitled “Methods for the Determination of

Metals in Environmental Samples,” Office of Research and Development, Washington, DC 20460, (EPA/600/4-91/010), June 1991, which is incorporated by reference in accordance with 5 U.S.C. 552(a) and 1 CFR part 51. The availability of this incorporation by reference is given in paragraph (b)(4)(iii)(E)(I)(ii) of this section.

(7) Cyanide shall be measured using the following methods:

(i) Method 335.1—“Titrimetric; Spectrophotometric” which is incorporated by reference in accordance with 5 U.S.C. 552(a) and 1 CFR part 51, or

(ii) Method 335.2—“Titrimetric; Spectrophotometric” which is incorporated by reference in accordance with 5 U.S.C. 552(a) and 1 CFR part 51, or

(iii) Method 335.3—“Colorimetric, Automated UV,” which is incorporated by reference in accordance with 5 U.S.C. 552(a) and 1 CFR part 51. The availability of these incorporation by reference is given in paragraph (b)(4)(iii)(E) of this section.

(iv) Method D-2036-91—“Standard Test Methods for Cyanides in Water,” contained in the Annual Book of ASTM Standards, vols. 11.01 and 11.02, 1995, American Society for Testing and Materials, 100 Barr Harbor Dr., West Conshohocken, PA 19428, which is incorporated by reference in accordance with 5 U.S.C. 552(a) and 1 CFR part 51. Copies of this publication are available from American Society for Testing and Materials, 100 Barr Harbor Dr., West Conshohocken, PA 19428, or may be examined at the Center for Food Safety and Applied Nutrition’s Library, 5100 Paint Branch Pkwy., College Park, MD 20740, or at the National Archives and Records Administration (NARA). For information on the availability of this material at NARA, call 202-741-6030, or go to: http://www.archives.gov/federal_register/code_of_federal_regulations/ibr_locations.html.

(8) Lead shall be measured as total recoverable metal without filtration using the following methods:

(i) Method 239.2—“Atomic Absorption; furnace technique,” which is incorporated by reference in accordance with 5 U.S.C. 552(a) and 1 CFR part 51.

The availability of this incorporation by reference is given in paragraph (b)(4)(iii)(E) of this section.

(ii) Method 200.8—“Determination of Trace Elements in Water and Wastes by Inductively Coupled Plasma-Mass Spectrometry,” Rev. 4.4, April 1991, U.S. EPA, EMSL. The revision is contained in the manual entitled “Methods for the Determination of Metals in Environmental Samples,” Office of Research and Development, Washington, DC 20460, (EPA/600/4-91/010), June 1991, which is incorporated by reference in accordance with 5 U.S.C. 552(a) and 1 CFR part 51. The availability of this incorporation by reference is given in paragraph (b)(4)(iii)(E)(I)(ii) of this section.

(iii) Method 200.9—“Determination of Trace Elements by Stabilized Temperature Graphite Furnace Atomic Absorption Spectrometry,” Rev. 1.2, April 1991, U.S. EPA, EMSL. The revision is contained in the manual entitled “Methods for the Determination of Metals in Environmental Samples,” Office of Research and Development, Washington, DC 20460, (EPA/600/4-91/010), June 1991, which is incorporated by reference in accordance with 5 U.S.C. 552(a) and 1 CFR part 51. The availability of this incorporation by reference is given in paragraph (b)(4)(iii)(E)(I)(ii) of this section.

(9) Mercury shall be measured using the following methods:

(i) Method 245.1—“Manual cold vapor technique,” which is incorporated by reference in accordance with 5 U.S.C. 552(a) and 1 CFR part 51, or

(ii) Method 245.2—“Automated cold vapor technique,” which is incorporated by reference in accordance with 5 U.S.C. 552(a) and 1 CFR part 51. The availability of these incorporation by reference is given in paragraph (b)(4)(iii)(E) of this section.

(10) Nickel shall be measured using the following methods:

(i) Method 249.1—“Atomic Absorption; direct aspiration,” which is incorporated by reference in accordance with 5 U.S.C. 552(a) and 1 CFR part 51, or

(ii) Method 249.2—“Atomic Absorption; furnace technique,” which is incorporated by reference in accordance with 5 U.S.C. 552(a) and 1 CFR part 51.

The availability of these incorporation by reference is given in paragraph (b)(4)(iii)(E) of this section.

(iii) Method 200.7—“Determination of Metals and Trace Elements in Water and Wastes by Inductively Coupled Plasma-Atomic Emission Spectrometry,” Rev. 3.3, April 1991, U.S. EPA, EMSL. The revision is contained in the manual entitled “Methods for the Determination of Metals in Environmental Samples,” Office of Research and Development, Washington, DC 20460, (EPA/600/4-91/010), June 1991, which is incorporated by reference in accordance with 5 U.S.C. 552(a) and 1 CFR part 51. The availability of this incorporation by reference is given in paragraph (b)(4)(iii)(E)(I)(ii) of this section.

(iv) Method 200.8—“Determination of Trace Elements in Water and Wastes by Inductively Coupled Plasma-Mass Spectrometry,” Rev. 4.4, April 1991, U.S. EPA, EMSL. The revision is contained in the manual entitled “Methods for the Determination of Metals in Environmental Samples,” Office of Research and Development, Washington, DC 20460, (EPA/600/4-91/010), June 1991, which is incorporated by reference in accordance with 5 U.S.C. 552(a) and 1 CFR part 51. The availability of this incorporation by reference is given in paragraph (b)(4)(iii)(E)(I)(ii) of this section.

(v) Method 200.9—“Determination of Trace Elements by Stabilized Temperature Graphite Furnace Atomic Absorption Spectrometry,” Rev. 1.2, April 1991, U.S. EPA, EMSL. The revision is contained in the manual entitled “Methods for the Determination of Metals in Environmental Samples,” Office of Research and Development, Washington, DC 20460, (EPA/600/4-91/010), June 1991, which is incorporated by reference in accordance with 5 U.S.C. 552(a) and 1 CFR part 51. The availability of this incorporation by reference is given in paragraph (b)(4)(iii)(E)(I)(ii) of this section.

(11) Nitrate and/or nitrite shall be measured using the following methods:

(i) Method 300.0—“The Determination of Inorganic Anions in Water by Ion Chromatography—Method 300.0,” EPA, EMSL (EPA-600/4-84-017), March 1984, which is incorporated by reference in

accordance with 5 U.S.C. 552(a) and 1 CFR part 51. Copies of this publication are available from NTIS, U.S. Department of Commerce, 5285 Port Royal Rd., Springfield, VA 22161, or may be examined at the Center for Food Safety and Applied Nutrition's Library, Food and Drug Administration, 5100 Paint Branch Pkwy., College Park, MD 20740, or at the National Archives and Records Administration (NARA). For information on the availability of this material at NARA, call 202–741–6030, or go to: http://www.archives.gov/federal_register/code_of_federal_regulations/ibr_locations.html.

(ii) Method 353.1—“Colorimetric, automated, hydrazine reduction,” for nitrate only, which is incorporated by reference in accordance with 5 U.S.C. 552(a) and 1 CFR part 51, or

(iii) Method 353.2—“Colorimetric, automated, cadmium reduction,” for both nitrate and nitrite, which is incorporated by reference in accordance with 5 U.S.C. 552(a) and 1 CFR part 51, or

(iv) Method 353.3—“Spectrophotometric, cadmium reduction,” for both nitrate and nitrite, which is incorporated by reference in accordance with 5 U.S.C. 552(a) and 1 CFR part 51, or

(12) Selenium shall be measured using the following methods:

(i) Method 270.2—“Atomic Absorption; furnace technique,” which is incorporated by reference in accordance with 5 U.S.C. 552(a) and 1 CFR part 51, or

(ii) Method 270.3—“Atomic Absorption; gaseous hydride,” which is incorporated by reference in accordance with 5 U.S.C. 552(a) and 1 CFR part 51. The availability of this incorporation by reference is given in paragraph (b)(4)(iii)(E) of this section.

(13) Thallium shall be measured using the following methods:

(i) Method 279.2—“Atomic Absorption; furnace technique,” which is incorporated by reference in accordance with 5 U.S.C. 552(a) and 1 CFR part 51. The availability of this incorporation by reference is given in paragraph (b)(4)(iii)(E) of this section.

(ii) Method 200.8—“Determination of Trace Elements in Water and Wastes

by Inductively Coupled Plasma-Mass Spectrometry,” Rev. 4.4, April 1991, U.S. EPA, EMSL. The revision is contained in the manual entitled “Methods for the Determination of Metals in Environmental Samples,” Office of Research and Development, Washington, DC 20460, (EPA/600/4-91/010), June 1991, which is incorporated by reference in accordance with 5 U.S.C. 552(a) and 1 CFR part 51. The availability of this incorporation by reference is given in paragraph (b)(4)(iii)(E)(1)(ii) of this section.

(iii) Method 200.9—“Determination of Trace Elements by Stabilized Temperature Graphite Furnace Atomic Absorption Spectrometry,” Rev. 1.2, April 1991, U.S. EPA, EMSL. The revision is contained in the manual entitled “Methods for the Determination of Metals in Environmental Samples,” Office of Research and Development, Washington, DC 20460, (EPA/600/4-91/010), June 1991, which is incorporated by reference in accordance with 5 U.S.C. 552(a) and 1 CFR part 51. The availability of this incorporation by reference is given in paragraph (b)(4)(iii)(E)(1)(ii) of this section.

(14) Arsenic shall be measured using the following methods:

(i) Method 200.8—“Determination of Trace Elements in Waters and Wastes by Inductively Coupled Plasma-Mass Spectrometry,” Revision 5.4, which is incorporated by reference in accordance with 5 U.S.C. 552(a) and 1 CFR part 51. Method 200.8 is contained in the manual entitled “Methods for the Determination of Metals in Environmental Samples—Supplement 1,” EPA/600/R-94/111, May 1994. Copies of this publication are available from the National Technical Information Service (NTIS), PB95-125472, U.S. Department of Commerce, 5285 Port Royal Rd., Springfield, VA 22161, or may be examined at the Center for Food Safety and Applied Nutrition's Library, Food and Drug Administration, 5100 Paint Branch Pkwy., College Park, MD 20740, or at the National Archives and Records Administration (NARA). For information on the availability of this material at NARA, call 202–741–6030, or go to: http://www.archives.gov/federal_register/

code_of_federal_regulations/ibr_locations.html.

(ii) Method 200.9—“Determination of Trace Elements by Stabilized Temperature Graphite Furnace Atomic Absorption,” Revision 2.2, which is incorporated by reference in accordance with 5 U.S.C. 552(a) and 1 CFR part 51. Method 200.9 is contained in the manual entitled “Methods for the Determination of Metals in Environmental Samples—Supplement 1,” EPA/600/R-94/111, May 1994. The availability of this incorporation by reference is given in paragraph (b)(4)(iii)(E)(14)(i) of this section.

(F) Analyses to determine compliance with the requirements of paragraphs (b)(4)(iii)(B) and (b)(4)(iii)(C) of this section shall be conducted in accordance with an applicable method or applicable revisions to the methods listed in paragraphs (b)(4)(iii)(F)(1) through (b)(4)(iii)(F)(20) of this section and described, unless otherwise noted, in “Methods for the Determination of Organic Compounds in Drinking Water,” Office of Research and Development, EMSL, EPA/600/4-88/039, December 1988, or in “Methods for the Determination of Organic Compounds in Drinking Water, Supplement 1,” Office of Research and Development, EMSL, EPA/600/4-90/020, July 1990, which are incorporated by reference in accordance with 5 U.S.C. 552(a) and 1 CFR part 51. Copies of these publications are available from NTIS, U.S. Department of Commerce, 5285 Port Royal Rd., Springfield, VA 22161, or may be examined at the Center for Food Safety and Applied Nutrition’s Library, Food and Drug Administration, 5100 Paint Branch Pkwy., College Park, MD 20740, or at the National Archives and Records Administration (NARA). For information on the availability of this material at NARA, call 202-741-6030, or go to: http://www.archives.gov/federal_register/code_of_federal_regulations/ibr_locations.html.

(I) Method 502.1—“Volatile Halogenated Organic Compounds in Water by Purge and Trap Gas Chromatography,” Rev. 2.0, 1989, (applicable to VOC’s), which is incorporated by reference in accordance with 5 U.S.C. 552(a) and 1 CFR part 51, or

(2) Method 502.2—“Volatile Organic Compounds in Water by Purge and Trap Capillary Column Gas Chromatography with Photoionization and Electrolytic Conductivity Detectors in Series,” Rev. 2.0, 1989, (applicable to VOC’s), which is incorporated by reference in accordance with 5 U.S.C. 552(a) and 1 CFR part 51, or

(3) Method 503.1—“Volatile Aromatic and Unsaturated Organic Compounds in Water by Purge and Trap Gas Chromatography,” Rev. 2.0, 1989, (applicable to VOC’s), which is incorporated by reference in accordance with 5 U.S.C. 552(a) and 1 CFR part 51, or

(4) Method 524.1—“Measurement of Purgeable Organic Compounds in Water by Packed Column Gas Chromatography/Mass Spectrometry,” Rev. 3.0, 1989, (applicable to VOC’s), which is incorporated by reference in accordance with 5 U.S.C. 552(a) and 1 CFR part 51, or

(5) Method 524.2—“Measurement of Purgeable Organic Compounds in Water by Capillary Column Gas Chromatography/Mass Spectrometry,” Rev. 3.0, 1989, (applicable to VOC’s), which is incorporated by reference in accordance with 5 U.S.C. 552(a) and 1 CFR part 51, or

(6) Method 504—“1,2-Dibromoethane (EDB) and 1,2-Dibromo-3-Chloropropane (DBCP) in Water by Microextraction and Gas Chromatography,” Rev. 2.0, 1989, (applicable to dibromochloropropane (DBCP) and ethylene dibromide (EDB)), which is incorporated by reference in accordance with 5 U.S.C. 552(a) and 1 CFR part 51, or

(7) Method 505—“Analysis of Organohalide Pesticides and Commercial Polychlorinated Biphenyl (PCB) Products in Water by Microextraction and Gas Chromatography,” Rev. 2.0, 1989, (applicable to alachlor, atrazine, chlordane, heptachlor, heptachlor epoxide, lindane, methoxychlor, toxaphene, endrin, hexachlorobenzene, hexachlorocyclopentadiene, simazine, and as a screen for PCB’s), which is incorporated by reference in accordance with 5 U.S.C. 552(a) and 1 CFR part 51, or

(8) Method 506—“Determination of Phthalate and Adipate Esters in Drinking Water by Liquid-Liquid Extraction

or Liquid-Solid Extraction and Gas Chromatography with Photoionization Detection," applicable to di(2-ethylhexyl) adipate which is incorporated by reference in accordance with 5 U.S.C. 552(a) and 1 CFR part 51, or

(9) Method 507—"Determination of Nitrogen- and Phosphorus-Containing Pesticides in Water by Gas Chromatography with a Nitrogen-Phosphorus Detector," Rev. 2.0, 1989, (applicable to alachlor, atrazine, and simazine), which is incorporated by reference in accordance with 5 U.S.C. 552(a) and 1 CFR part 51, or

(10) Method 508—"Determination of Chlorinated Pesticides in Water by Gas Chromatography with an Electron Capture Detector," Rev. 3.0, 1989, (applicable to chlordane, heptachlor, heptachlor epoxide, lindane, methoxychlor, toxaphene, endrin, hexachlorobenzene, and as a screen for PCB's), which is incorporated by reference in accordance with 5 U.S.C. 552(a) and 1 CFR part 51, or

(11) Method 508A—"Screening for Polychlorinated Biphenyls by Perchlorination and Gas Chromatography," Rev. 1.0, 1989, (used to quantitate PCB's as decachlorobiphenyl if detected in methods 505 or 508 in paragraph (b)(4)(iii)(F)(7) or (b)(4)(iii)(F)(9) of this section, respectively, which is incorporated by reference in accordance with 5 U.S.C. 552(a) and 1 CFR part 51, or

(12) Method 515.1—"Determination of Chlorinated Acids in Water by Gas Chromatography with an Electron Capture Detector," Rev. 5.0, 1991, (applicable to 2,4-D, 2,4,5-TP (Silvex), pentachlorophenol, dalapon, dinoseb, and picloram), which is incorporated by reference in accordance with 5 U.S.C. 552(a) and 1 CFR part 51, or

(13) Method 525.1—"Determination of Organic Compounds in Drinking Water by Liquid-Solid Extraction and Capillary Column Gas Chromatography/Mass Spectrometry," Rev. 2.2, May 1991, (applicable to alachlor, atrazine, chlordane, heptachlor, heptachlor epoxide, lindane, methoxychlor, pentachlorophenol, benzo(a)pyrene, di(2-ethylhexyl) adipate, endrin, hexachlorobenzene, hexachlorocyclopentadiene, and simazine), which is in-

corporated by reference in accordance with 5 U.S.C. 552(a) and 1 CFR part 51, or

(14) Method 531.1—"Measurement of N-Methylcarbamoyloximes and N-Methylcarbamates in Water by Direct Aqueous Injection HPLC with Post Column Derivatization," Rev. 3.0, 1989, (applicable to carbofuran and oxamyl (vydate)), which is incorporated by reference in accordance with 5 U.S.C. 552(a) and 1 CFR part 51, or

(15) Method 547—"Determination of Glyphosate in Drinking Water by Direct-Aqueous-Injection HPLC, Post-Column Derivatization, and Fluorescence Detection," (applicable to glyphosate), which is incorporated by reference in accordance with 5 U.S.C. 552(a) and 1 CFR part 51, or

(16) Method 548—"Determination of Endothall in Drinking Water by Aqueous Derivatization, Liquid-Solid Extraction, and Gas Chromatography with Electron-Capture Detection," (applicable to endothall), which is incorporated by reference in accordance with 5 U.S.C. 552(a) and 1 CFR part 51, or

(17) Method 549—"Determination of Diquat and Paraquat in Drinking Water by Liquid-Solid Extraction and HPLC with Ultraviolet Detection," (applicable to diquat), which is incorporated by reference in accordance with 5 U.S.C. 552(a) and 1 CFR part 51, or

(18) Method 550—"Determination of Polycyclic Aromatic Hydrocarbons in Drinking Water by Liquid-Liquid Extraction and HPLC with Coupled Ultraviolet and Fluorescence Detection," (applicable to benzo(a)pyrene and other polynuclear aromatic hydrocarbons), which is incorporated by reference in accordance with 5 U.S.C. 552(a) and 1 CFR part 51, or

(19) Method 550.1—"Determination of Polycyclic Aromatic Hydrocarbons in Drinking Water by Liquid-Solid Extraction and HPLC with Coupled Ultraviolet and Fluorescence Detection," (applicable to benzo(a)pyrene and other polynuclear aromatic hydrocarbons), which is incorporated by reference in accordance with 5 U.S.C. 552(a) and 1 CFR part 51. The availability of these incorporation by reference is given in paragraph (b)(4)(iii)(F) of this section.

(20) Method 1613—“Tetra- through Octa- Chlorinated Dioxins and Furans by Isotope Dilution HRGC/HRMS,” Rev. A, 1990, EPA, Office of Water Regulations and Standards, Industrial Technology Division, (applicable to 2,3,7,8-TCDD (Dioxin)), which is incorporated by reference in accordance with 5 U.S.C. 552(a) and 1 CFR part 51. Copies of this publication are available from USEPA-OST, Sample Control Center, P.O. Box 1407, Alexandria, VA 22313, or may be examined at the Center for Food Safety and Applied Nutrition’s Library, Food and Drug Administration, 5100 Paint Branch Pkwy., College Park, MD 20740, or at the National Archives and Records Administration (NARA). For information on the availability of this material at NARA, call 202-741-6030, or go to: http://www.archives.gov/federal_register/code_of_federal_regulations/ibr_locations.html.

(G) Analyses to determine compliance with the requirements of paragraph (b)(4)(iii)(D) of this section shall be conducted in accordance with an applicable method and applicable revisions to the methods listed in paragraphs (b)(4)(iii)(G)(1) through (b)(4)(iii)(G)(3) of this section and described, unless otherwise noted, in “Methods of Chemical Analysis of Water and Wastes,” which is incorporated by reference in accordance with 5 U.S.C. 552(a) and 1 CFR part 51. The availability of this incorporation by reference is given in paragraph (b)(4)(iii)(E) of this section.

(1) Aluminum shall be measured using the following methods:

(i) Method 202.1—“Atomic Absorption; direct aspiration technique,” which is incorporated by reference in accordance with 5 U.S.C. 552(a) and 1 CFR part 51, or

(ii) Method 202.2—“Atomic Absorption; furnace technique,” which is incorporated by reference in accordance with 5 U.S.C. 552(a) and 1 CFR part 51. The availability of this incorporation by reference is given in paragraph (b)(4)(iii)(E).

(iii) Method 200.7—“Determination of Trace Elements in Water and Wastes by Inductively Coupled Plasma-Atomic Emission Spectrometry,” Rev. 3.3, April 1991, U.S. EPA, EMSL. The revision

is contained in the manual entitled “Methods for the Determination of Metals in Environmental Samples,” Office of Research and Development, Washington, DC 20460, (EPA/600/4-91/010), June 1991, which is incorporated by reference in accordance with 5 U.S.C. 552(a) and 1 CFR part 51. The availability of this incorporation by reference is given in paragraph (b)(4)(iii)(E)(1)(ii) of this section.

(iv) Method 200.8—“Determination of Trace Elements in Water and Wastes by Inductively Coupled Plasma-Mass Spectrometry,” Rev. 4.4, April 1991, U.S. EPA, EMSL. The revision is contained in the manual entitled “Methods for the Determination of Metals in Environmental Samples,” Office of Research and Development, Washington, DC 20460, (EPA/600/4-91/010), June 1991, which is incorporated by reference in accordance with 5 U.S.C. 552(a) and 1 CFR part 51. The availability of this incorporation by reference is given in paragraph (b)(4)(iii)(E)(1)(ii) of this section.

(v) Method 200.9—“Determination of Trace Elements by Stabilized Temperature Graphite Furnace Atomic Absorption Spectrometry,” Rev. 1.2, April 1991, U.S. EPA, EMSL. The revision is contained in the manual entitled “Methods for the Determination of Metals in Environmental Samples,” Office of Research and Development, Washington, DC 20460, (EPA/600/4-91/010), June 1991, which is incorporated by reference in accordance with 5 U.S.C. 552(a) and 1 CFR part 51. The availability of this incorporation by reference is given in paragraph (b)(4)(iii)(E)(1)(ii) of this section.

(2) Silver shall be measured using the following methods:

(i) Method 272.1—“Atomic Absorption; direct aspiration technique,” which is incorporated by reference in accordance with 5 U.S.C. 552(a) and 1 CFR part 51, or

(ii) Method 272.2—“Atomic Absorption; furnace technique,” which is incorporated by reference in accordance with 5 U.S.C. 552(a) and 1 CFR part 51. The availability of this incorporation by reference is given in paragraph (b)(4)(iii)(E) of this section.

(iii) Method 200.7—“Determination of Trace Elements in Water and Wastes

by Inductively Coupled Plasma-Atomic Emission Spectrometry,” Rev. 3.3, April 1991, U.S. EPA, EMSL. The revision is contained in the manual entitled “Methods for the Determination of Metals in Environmental Samples,” Office of Research and Development, Washington, DC 20460, (EPA/600/4-91/010), June 1991, which is incorporated by reference in accordance with 5 U.S.C. 552(a) and 1 CFR part 51. The availability of this incorporation by reference is given in paragraph (b)(4)(iii)(E)(I)(ii) of this section.

(iv) Method 200.8—“Determination of Trace Elements in Water and Wastes by Inductively Coupled Plasma-Mass Spectrometry,” Rev. 4.4, April 1991, U.S. EPA, EMSL. The revision is contained in the manual entitled “Methods for the Determination of Metals in Environmental Samples,” Office of Research and Development, Washington, DC 20460, (EPA/600/4-91/010), June 1991, which is incorporated by reference in accordance with 5 U.S.C. 552(a) and 1 CFR part 51. The availability of this incorporation by reference is given in paragraph (b)(4)(iii)(E)(I)(ii) of this section.

(v) Method 200.9—“Determination of Trace Elements by Stabilized Temperature Graphite Furnace Atomic Absorption Spectrometry,” Rev. 1.2, April 1991, U.S. EPA, EMSL. The revision is contained in the manual entitled “Methods for the Determination of Metals in Environmental Samples,” Office of Research and Development, Washington, DC 20460, (EPA/600/4-91/010), June 1991, which is incorporated by reference in accordance with 5 U.S.C. 552(a) and 1 CFR part 51. The availability of these incorporation by reference is given in paragraph (b)(4)(iii)(E)(I)(ii) of this section.

(3) Sulfate shall be measured using the following methods:

(i) Method 300.0—“The Determination of Inorganic Anions in Water by Ion Chromatography—Method 300.0,” EPA, EMSL (EPA-600/4-84-017), March 1984, which is incorporated by reference in accordance with 5 U.S.C. 552(a) and 1 CFR part 51. The availability of this incorporation by reference is given in paragraph (b)(4)(iii)(E)(I)(i) of this section.

(ii) Method 375.1—“Colorimetric, Automated, Chloranilate,” which is incorporated by reference in accordance with 5 U.S.C. 552(a) and 1 CFR part 51, or

(iii) Method 375.3—“Gravimetric,” which is incorporated by reference in accordance with 5 U.S.C. 552(a) and 1 CFR part 51, or

(iv) Method 375.4—“Turbidimetric,” which is incorporated by reference in accordance with 5 U.S.C. 552(a) and 1 CFR part 51. The availability of these incorporation by reference is given in paragraph (b)(4)(iii)(E) of this section.

(H) The allowable levels for residual disinfectants and disinfection byproducts are as follows:

Substance	Concentration in milligrams per liter
Disinfection byproducts	
Bromate	0.010
Chlorite	1.0
Haloacetic acids (five) (HAA5)	0.060
Total Trihalomethanes (TTHM)	0.080
Residual disinfectants	
Chloramine	4.0 (as Cl ₂)
Chlorine	4.0 (as Cl ₂)
Chlorine dioxide	0.8 (as ClO ₂)

(I) Analysis to determine compliance with the requirements of paragraph (b)(4)(iii)(H) of this section shall be conducted in accordance with an applicable method listed in paragraphs (b)(4)(iii)(I)(1) through (b)(4)(iii)(I)(7) of this section and described in “Method 300.1, Determination of Inorganic Anions in Drinking Water by Ion Chromatography,” Rev. 1.0, U.S. EPA, 1997, EPA/600/R-98/118; “Methods for the Determination of Inorganic Substances in Environmental Samples,” U.S. EPA, August 1993, EPA/600/R-93/100; “Methods for the Determination of Organic Compounds in Drinking Water-Supplement II,” U.S. EPA, August 1992, EPA/600/R-92/129; “Methods for the Determination of Organic Compounds in Drinking Water-Supplement III,” U.S. EPA, August 1995, EPA/600/R-95/131; “Standard Methods for the Examination of Water and Wastewater,” 19th Ed., American Public Health Association, 1995; and “Annual Book of ASTM Standards,” vol. 11.01, American Society for Testing and Materials, 1996, which are incorporated by reference in accordance with 5 U.S.C. 552(a) and 1 CFR part 51. Copies of the following

publications are available from the National Technical Information Service (NTIS): EPA/600/R-95/131 (NTIS number PB95-261616), EPA/600/R-92/129 (NTIS number PB92-207703), EPA/600/R-93/100 (NTIS number PB94-121811), and EPA/600/R-98/118 (NTIS number PB98-169196). NTIS can be contacted at NTIS, U.S. Department of Commerce, 5285 Port Royal Rd., Springfield, VA 22161, 1-800-553-6847 or 703-605-6000, www.ntis.gov. Copies of the publication EPA/600/R-98/118 are also available from the Chemical Exposure Research Branch, Microbiological and Chemical Exposure Assessment Research Division, National Exposure Research Laboratory, U.S. EPA, Cincinnati, OH 45268, 513-569-7757, (FAX) 513-569-7757. Copies of "Standard Methods for the Examination of Water and Wastewater," 19th Ed., are available from the American Public Health Association, 1015 15th Street, NW., Washington, DC 20005. All of the publications cited in paragraph (b)(4)(iii)(I) of this section may be examined at the National Archives and Records Administration (NARA), or at the Center for Food Safety and Applied Nutrition's Library, 5100 Paint Branch Pkwy., College Park, MD 20740. For information on the availability of this material at NARA, call 202-741-6030, or go to: http://www.archives.gov/federal_register/code_of_federal_regulations/ibr_locations.html. Copies of "Annual Book of ASTM Standards," 1996, vol. 11.01, are available from the American Society for Testing and Materials, 100 Barr Harbor Dr., West Conshohocken, PA 19428, or may be examined at the Office of the Federal Register. Copies of the methods incorporated by reference in paragraph (b)(4)(iii)(I) of this section may also be examined at the Center for Food Safety and Applied Nutrition's Library, 5100 Paint Branch Pkwy., College Park, MD 20740.

(1) Bromate shall be measured using the following method: Method 300.1—"Determination of Inorganic Anions in Drinking Water by Ion Chromatography," Rev. 1.0, U.S. EPA, 1997, EPA/600/R-98/118, which is incorporated by reference in accordance with 5 U.S.C. 552(a) and 1 CFR part 51. The availability of this incorporation by reference is given in paragraph (b)(4)(iii)(I) of this section.

(2) Chlorite shall be measured using the following methods:

(i) Method 300.0—"Determination of Inorganic Anions by Ion Chromatography," Rev. 2.1. The revision is contained in the manual entitled "Methods for the Determination of Inorganic Substances in Environmental Samples," U.S. EPA, August 1993, EPA/600/R-93/100, which is incorporated by reference in accordance with 5 U.S.C. 552(a) and 1 CFR part 51. The availability of this incorporation by reference is given in paragraph (b)(4)(iii)(I) of this section.

(ii) Method 300.1—"Determination of Inorganic Anions in Drinking Water by Ion Chromatography," Rev. 1.0, U.S. EPA, 1997, EPA/600/R-98/118, which is incorporated by reference in accordance with 5 U.S.C. 552(a) and 1 CFR part 51. The availability of this incorporation by reference is given in paragraph (b)(4)(iii)(I) of this section.

(3) HAA5 shall be measured using the following methods:

(i) Method 552.1—"Determination of Haloacetic Acids and Dalapon in Drinking Water by Ion Exchange Liquid-Solid Extraction and Gas Chromatography with Electron Capture Detection," Rev. 1.0. The revision is contained in the manual entitled "Methods for the Determination of Organic Compounds in Drinking Water-Supplement II," U.S. EPA, August 1992, EPA/600/R-92/129, which is incorporated by reference in accordance with 5 U.S.C. 552(a) and 1 CFR part 51. The availability of this incorporation by reference is given in paragraph (b)(4)(iii)(I) of this section.

(ii) Method 552.2—"Determination of Haloacetic Acids and Dalapon in Drinking Water by Liquid-Liquid Extraction, Derivatization and Gas Chromatography with Electron Capture Detection," Rev. 1.0. The revision is contained in the manual entitled "Methods for the Determination of Organic Compounds in Drinking Water-Supplement III," U.S. EPA, August 1993, EPA/600/R-95/131, which is incorporated by reference in accordance with 5 U.S.C. 552(a) and 1 CFR part 51. The availability of this incorporation by reference is given in paragraph (b)(4)(iii)(I) of this section.

(iii) Method 6251 B—“Disinfection By-Products: Haloacetic Acids and Trichlorophenol,” which is contained in the book entitled “Standard Methods for the Examination of Water and Wastewater,” 19th Ed., which is incorporated by reference in accordance with 5 U.S.C. 552(a) and 1 CFR part 51. The availability of this incorporation by reference is given in paragraph (b)(4)(iii)(I) of this section.

(4) TTHM shall be measured using the following methods:

(i) Method 502.2—“Volatile Organic Compounds in Water by Purge and Trap Capillary Column Gas Chromatography with Photoionization and Electrolytic Conductivity Detectors in Series,” Rev. 2.1. The revision is contained in the manual entitled “Methods for the Determination of Organic Compounds in Drinking Water-Supplement III,” U.S. EPA, August 1993, EPA/600/R-95/131, which is incorporated by reference in accordance with 5 U.S.C. 552(a) and 1 CFR part 51. The availability of this incorporation by reference is given in paragraph (b)(4)(iii)(I) of this section.

(ii) Method 524.2—“Measurement of Purgeable Organic Compounds in Water by Capillary Column Gas Chromatography/Mass Spectrometry,” Rev. 1.0. The revision is contained in the manual entitled “Methods for the Determination of Organic Compounds in Drinking Water-Supplement III,” U.S. EPA, August 1993, EPA/600/R-95/131, which is incorporated by reference in accordance with 5 U.S.C. 552(a) and 1 CFR part 51. The availability of this incorporation by reference is given in paragraph (b)(4)(iii)(I) of this section.

(iii) Method 551.1—“Determination of Chlorination Disinfection Byproducts, Chlorinated Solvents, and Halogenated Pesticides/Herbicides in Drinking Water by Liquid-Liquid Extraction and Gas Chromatography with Electron-Capture Detection,” Rev. 1.0. The revision is contained in the manual entitled “Methods for the Determination of Organic Compounds in Drinking Water-Supplement III,” U.S. EPA, August 1993, EPA/600/R-95/131, which is incorporated by reference in accordance with 5 U.S.C. 552(a) and 1 CFR part 51. The availability of this incorporation

by reference is given in paragraph (b)(4)(iii)(I) of this section.

(5) Compliance with the chloramine standard can be determined by measuring combined or total chlorine. The following methods shall be used to measure chloramine:

(i) ASTM Method D1253-86—“Standard Test Method for Residual Chlorine in Water,” which is contained in the book entitled “Annual Book of ASTM Standards,” 1996, vol. 11.01, which is incorporated by reference in accordance with 5 U.S.C. 552(a) and 1 CFR part 51. The availability of this incorporation by reference is given in paragraph (b)(4)(iii)(I) of this section.

(ii) Method 4500-Cl D—“Amperometric Titration Method,” which is contained in the book entitled “Standard Methods for the Examination of Water and Wastewater,” 19th Ed., which is incorporated by reference in accordance with 5 U.S.C. 552(a) and 1 CFR part 51. The availability of this incorporation by reference is given in paragraph (b)(4)(iii)(I) of this section.

(iii) Method 4500-Cl F—“DPD Ferrous Titrimetric Method,” which is contained in the book entitled “Standard Methods for the Examination of Water and Wastewater,” 19th Ed., which is incorporated by reference in accordance with 5 U.S.C. 552(a) and 1 CFR part 51. The availability of this incorporation by reference is given in paragraph (b)(4)(iii)(I) of this section.

(iv) Method 4500-Cl G—“DPD Colorimetric Method,” which is contained in the book entitled “Standard Methods for the Examination of Water and Wastewater,” 19th Ed., which is incorporated by reference in accordance with 5 U.S.C. 552(a) and 1 CFR part 51. The availability of this incorporation by reference is given in paragraph (b)(4)(iii)(I) of this section.

(v) Method 4500-Cl E—“Low-Level Amperometric Titration Method,” which is contained in the book entitled “Standard Methods for the Examination of Water and Wastewater,” 19th Ed., which is incorporated by reference in accordance with 5 U.S.C. 552(a) and 1 CFR part 51. The availability of this incorporation by reference is given in paragraph (b)(4)(iii)(I) of this section.

(vi) Method 4500-Cl I—“Iodometric Electrode Technique,” which is contained in the book entitled “Standard Methods for the Examination of Water and Wastewater,” 19th Ed., which is incorporated by reference in accordance with 5 U.S.C. 552(a) and 1 CFR part 51. The availability of this incorporation by reference is given in paragraph (b)(4)(iii)(I) of this section.

(6) Compliance with the chlorine standard can be determined by measuring free or total chlorine. The following methods shall be used to measure chlorine:

(i) ASTM Method D1253-86—“Standard Test Method for Residual Chlorine in Water,” which is contained in the book entitled “Annual Book of ASTM Standards,” 1996, vol. 11.01, which is incorporated by reference in accordance with 5 U.S.C. 552(a) and 1 CFR part 51. The availability of this incorporation by reference is given in paragraph (b)(4)(iii)(I) of this section.

(ii) Method 4500-Cl D—“Amperometric Titration Method,” which is contained in the book entitled “Standard Methods for the Examination of Water and Wastewater,” 19th Ed., which is incorporated by reference in accordance with 5 U.S.C. 552(a) and 1 CFR part 51. The availability of this incorporation by reference is given in paragraph (b)(4)(iii)(I) of this section.

(iii) Method 4500-Cl F—“DPD Ferrous Titrimetric Method,” which is contained in the book entitled “Standard Methods for the Examination of Water and Wastewater,” 19th Ed., which is incorporated by reference in accordance with 5 U.S.C. 552(a) and 1 CFR part 51. The availability of this incorporation by reference is given in paragraph (b)(4)(iii)(I) of this section.

(iv) Method 4500-Cl G—“DPD Colorimetric Method,” which is contained in the book entitled “Standard Methods for the Examination of Water and Wastewater,” 19th Ed., which is incorporated by reference in accordance with 5 U.S.C. 552(a) and 1 CFR part 51. The availability of this incorporation by reference is given in paragraph (b)(4)(iii)(I) of this section.

(v) Method 4500-Cl E—“Low-Level Amperometric Titration Method,” which is contained in the book entitled “Standard Methods for the Examination

of Water and Wastewater,” 19th Ed., which is incorporated by reference in accordance with 5 U.S.C. 552(a) and 1 CFR part 51. The availability of this incorporation by reference is given in paragraph (b)(4)(iii)(I) of this section.

(vi) Method 4500-Cl I—“Iodometric Electrode Technique,” which is contained in the book entitled “Standard Methods for the Examination of Water and Wastewater,” 19th Ed., which is incorporated by reference in accordance with 5 U.S.C. 552(a) and 1 CFR part 51. The availability of this incorporation by reference is given in paragraph (b)(4)(iii)(I) of this section.

(vii) Method 4500-Cl H—“Syringaldazine (FACTS) Method,” which is contained in the book entitled “Standard Methods for the Examination of Water and Wastewater,” 19th Ed., which is incorporated by reference in accordance with 5 U.S.C. 552(a) and 1 CFR part 51. The availability of this incorporation by reference is given in paragraph (b)(4)(iii)(I) of this section.

(7) Chlorine dioxide shall be measured using the following methods:

(i) Method 4500-ClO₂ D—“DPD Method,” which is contained in the book entitled “Standard Methods for the Examination of Water and Wastewater,” 19th Ed., which is incorporated by reference in accordance with 5 U.S.C. 552(a) and 1 CFR part 51. The availability of this incorporation by reference is given in paragraph (b)(4)(iii)(I) of this section.

(ii) Method 4500-ClO₂E—“Amperometric Method II,” which is contained in the book entitled “Standard Methods for the Examination of Water and Wastewater,” 19th Ed., which is incorporated by reference in accordance with 5 U.S.C. 552(a) and 1 CFR part 51. The availability of this incorporation by reference is given in paragraph (b)(4)(iii)(I) of this section.

(5) *Radiological quality.* (i) Bottled water shall, when a composite of analytical units of equal volume from a sample is examined by the methods described in paragraph (b)(5)(ii) of this section, meet standards of radiological quality as follows:

(A) The bottled water shall not contain a combined radium-226 and radium-228 activity in excess of 5 picocuries per liter of water.

(B) The bottled water shall not contain a gross alpha particle activity (including radium-226, but excluding radon and uranium) in excess of 15 picocuries per liter of water.

(C) The bottled water shall not contain beta particle and photon radioactivity from manmade radionuclides in excess of that which would produce an annual dose equivalent to the total body or any internal organ of 4 millirems per year calculated on the basis of an intake of 2 liters of the water per day. If two or more beta or photon-emitting radionuclides are present, the sum of their annual dose equivalent to the total body or to any internal organ shall not exceed 4 millirems per year.

(D) The bottled water shall not contain uranium in excess of 30 micrograms per liter of water.

(ii) Analyses conducted to determine compliance with the requirements of paragraph (b)(5)(i) of this section shall be made in accordance with the methods described in the applicable sections of “Standard Methods for the Examination of Water and Wastewater,” 20th Ed., which is incorporated by reference in accordance with 5 U.S.C. 552(a) and 1 CFR part 51. Copies of “Standard Methods for the Examination of Water and Wastewater,” 20th Ed., may be obtained from the American Public Health Association, 1015 15th St. NW., Washington, DC 20005. Copies of the methods incorporated by reference in this paragraph (b)(5)(ii) may also be examined at the National Archives and Records Administration (NARA), or at the Center for Food Safety and Applied Nutrition’s Library, 5100 Paint Branch Pkwy., College Park, MD. For information on the availability of this material at NARA, call 202-741-6030, or go to:

http://www.archives.gov/federal_register/code_of_federal_regulations/ibr_locations.html.

(A) Combined radium-226/-228 shall be measured using the following methods:

(1) Method 7500–Ra B—“Precipitation Method,” which is contained in “Standard Methods for the Examination of Water and Wastewater,” 20th Ed., which is incorporated by reference in accordance with 5 U.S.C. 552(a) and 1 CFR part 51. The availability of this in-

corporation by reference is given in the introductory text of paragraph (b)(5)(ii) of this section.

(2) Method 7500–Ra D—“Sequential Precipitation Method,” which is contained in “Standard Methods for the Examination of Water and Wastewater,” 20th Ed., which is incorporated by reference in accordance with 5 U.S.C. 552(a) and 1 CFR part 51. The availability of this incorporation by reference is given in the introductory text of paragraph (b)(5)(ii) of this section.

(B) Gross alpha particle radioactivity shall be measured using the following method: Method 7110 C—“Coprecipitation Method for Gross Alpha Radioactivity in Drinking Water,” which is contained in “Standard Methods for the Examination of Water and Wastewater,” 20th Ed., which is incorporated by reference in accordance with 5 U.S.C. 552(a) and 1 CFR part 51. The availability of this incorporation by reference is given in the introductory text of paragraph (b)(5)(ii) of this section.

(C) Beta particle and photon radioactivity shall be measured using the following methods:

(1) Method 7500–Sr B—“Precipitation Method,” which is contained in “Standard Methods for the Examination of Water and Wastewater,” 20th Ed., which is incorporated by reference in accordance with 5 U.S.C. 552(a) and 1 CFR part 51. The availability of this incorporation by reference is given in the introductory text of paragraph (b)(5)(ii) of this section.

(2) Method 7500–³H B—“Liquid Scintillation Spectrometric Method,” which is contained in “Standard Methods for the Examination of Water and Wastewater,” 20th Ed., which is incorporated by reference in accordance with 5 U.S.C. 552(a) and 1 CFR part 51. The availability of this incorporation by reference is given in the introductory text of paragraph (b)(5)(ii) of this section.

(3) Method 7120 B—“Gamma Spectroscopic Method,” which is contained in “Standard Methods for the Examination of Water and Wastewater,” 20th Ed., which is incorporated by reference in accordance with 5 U.S.C. 552(a) and 1 CFR part 51. The

Food and Drug Administration, HHS

§ 166.40

availability of this incorporation by reference is given in the introductory text of paragraph (b)(5)(ii) of this section.

(D) Uranium shall be measured using the following methods:

(1) Method 7500-U B—“Radiochemical Method” which is contained in “Standard Methods for the Examination of Water and Wastewater,” 20th Ed., which is incorporated by reference in accordance with 5 U.S.C. 552(a) and 1 CFR part 51. The availability of this incorporation by reference is given in the introductory text of paragraph (b)(5)(ii) of this section.

(2) Method 7500-U C—“Isotopic Method” which is contained in “Standard Methods for the Examination of Water and Wastewater,” 20th Ed., which is incorporated by reference in accordance with 5 U.S.C. 552(a) and 1 CFR part 51. The availability of this incorporation by reference is given in the introductory text of paragraph (b)(5)(ii) of this section.

(c) *Label statements.* When the microbiological, physical, chemical, or radiological quality of bottled water is below that prescribed by paragraphs (b)(2) through (b)(5), of this section, the label shall bear the statement of substandard quality specified in §130.14(a) of this chapter except that, as appropriate, instead of or in addition to the statement specified in §130.14(a) the following statement(s) shall be used:

(1) “Contains Excessive Bacteria” if the bottled water fails to meet the requirements of paragraph (b)(2) of this section.

(2) “Excessively Turbid”, “Abnormal Color”, and/or “Abnormal Odor” if the bottled water fails to meet the requirements of paragraph (b)(3) (i), (ii), or (iii), respectively, of this section.

(3) “Contains Excessive _____,” with the blank filled in with the name of the chemical for which a maximum contaminant level in paragraph (b)(4) of this section is exceeded (e.g., “Contains Excessive Arsenic,” “Contains Excessive Trihalomethanes”) except that “Contains Excessive Chemical Substances” may be used if the bottled water is not mineral water.

(4) “Excessively Radioactive” if the bottled water fails to meet the require-

ments of paragraph (b)(5) of this section.

(d) *Adulteration.* Bottled water containing a substance at a level considered injurious to health under section 402(a)(1) of the act is deemed to be adulterated, regardless of whether or not the water bears a label statement of substandard quality prescribed by paragraph (c) of this section.

[60 FR 57124, Nov. 13, 1995; 60 FR 66495, Dec. 22, 1995, as amended at 61 FR 13264, Mar. 26, 1996; 61 FR 14480, Apr. 2, 1996; 63 FR 25769, May 11, 1998; 66 FR 16865, Mar. 28, 2001; 66 FR 17359, Mar. 30, 2001; 66 FR 35373, July 5, 2001; 66 FR 56035, Nov. 6, 2001; 58 FR 15355, Mar. 31, 2003; 68 FR 9881, Mar. 3, 2003; 70 FR 33700, June 9, 2005]

PART 166—MARGARINE

Subpart A—General Provisions

Sec.

166.40 Labeling of margarine.

Subpart B—Requirements for Specific Standardized Margarine

166.110 Margarine.

AUTHORITY: 21 U.S.C. 321, 341, 343, 347, 348, 371, 379e.

Subpart A—General Provisions

§ 166.40 Labeling of margarine.

The Federal Food, Drug, and Cosmetic Act was amended by Pub. L. 459, 81st Congress (64 Stat. 20) on colored oleomargarine or margarine by adding thereto a new section numbered 407. Among other things, this section requires that there appear on the label of the package the word “oleomargarine” or “margarine” in type or lettering at least as large as any other type or lettering on the label, and a full and accurate statement of all the ingredients contained in such oleomargarine or margarine. It provides that these requirements “shall be in addition to and not in lieu of any of the other requirements of this Act”.

(a) Under section 403(g) of the Federal Food, Drug, and Cosmetic Act, any article that is represented as or purports to be oleomargarine or margarine must conform to the definition and standard of identity for oleomargarine

or margarine promulgated under section 401 of the act (Subpart B of this part), and its label must bear the name “oleomargarine” or “margarine”.

(b) The identity standard for oleomargarine or margarine applies to both the uncolored and the colored article.

(c) In considering the requirement that the word “oleomargarine” or “margarine” be in type or lettering at least as large as any other type or lettering on the label, it must be borne in mind that at least three factors are involved—the height of each letter, the area occupied by each letter as measured by a closely fitting rectangle drawn around it, and the boldness of letters or breadth of the lines forming the letters. The type or lettering used should meet the following tests:

(1) The height of each letter in the word “oleomargarine” or “margarine” should equal or exceed the height of any other letter elsewhere on the label.

(2) The area of the closely fitting rectangle with respect to any of the letters in the word “oleomargarine” or “margarine” should equal or exceed the area of such rectangle applied to the same or a corresponding letter elsewhere on the label.

(3) The letters in the word “oleomargarine” or “margarine” should be equal to or exceed in prominence and boldness, such as breadth of lines forming the letters, the same or corresponding letters elsewhere on the label.

(d) [Reserved]

(e) The word “oleomargarine” or “margarine” (and thus the other information called for by the statute) should appear on each panel of the package label that might reasonably be selected by the grocer for display purposes at the point of sale.

(f) The amendment covering colored oleomargarine or colored margarine states that, “for the purposes of * * * section 407 of the Federal Food, Drug, and Cosmetic Act, as amended, the term ‘oleomargarine’ or ‘margarine’ includes: (1) All substances, mixtures, and compounds known as oleomargarine or margarine; (2) all substances, mixtures, and compounds which have a consistency similar to that of butter and which contain any edible oils or fats other than milk fat if

made in imitation or semblance of butter”. Notwithstanding the difference between this definition and the definition and standard of identity for oleomargarine or margarine promulgated under section 401 of the act, it was the clear intent of Congress that any article which is represented as or purports to be oleomargarine or margarine is misbranded if it fails to comply with the definition and standard of identity for oleomargarine or margarine even though it may meet the statutory definition.

(g) Section 407(a) states that “Colored oleomargarine or colored margarine which is sold in the same State or Territory in which it is produced shall be subject in the same manner and to the same extent to the provisions of this act as if it had been introduced in interstate commerce”.

(h) Section 407(b)(4) requires that each part of the contents of the package be “contained in a wrapper which bears the word ‘oleomargarine’ or ‘margarine’ in type or lettering not smaller than 20-point type”. The Food and Drug Administration interprets this to mean that the height of the actual letters is no less than 20 points, or 20/72 of 1 inch.

(i) The wrappers on the subdivisions of oleomargarine or margarine contained within the package sold at retail are labels within the meaning of section 201(k) and shall contain all of the label information required by sections 403 and 407 of the Federal Food, Drug, and Cosmetic Act, just as in the case of 1-pound cartons, except that wrappers on the subdivisions contained within the retail package shall be exempt from compliance with the requirements of section 403 (e)(1), (g)(2), (i)(2), and (k) of the act with respect to the requirements for label declaration of the name and place of business of the manufacturer, packer, or distributor and label declaration of ingredients when (1) the subdivisions are securely enclosed within and are not intended to be separated from the retail package under conditions of retail sale; (2) the wrappers on the subdivisions are labeled with the statement “This Unit Not Labeled For Retail Sale” in type size not less than one-sixteenth inch in height. The word “Individual” may be

used in lieu of or immediately preceding the word "Retail" in the statement.

[42 FR 14477, Mar. 15, 1977, as amended at 46 FR 31005, June 12, 1981; 47 FR 32421, July 27, 1982]

Subpart B—Requirements for Specific Standardized Margarine

§ 166.110 Margarine.

(a) *Description.* Margarine (or oleomargarine) is the food in plastic form or liquid emulsion, containing not less than 80 percent fat determined by the method prescribed in "Official Methods of Analysis of the Association of Official Analytical Chemists," 13th Ed. (1980), section 16.206, "Indirect Method," under the heading "Fat (47)—Official Final Action," which is incorporated by reference. Copies may be obtained from the AOAC INTERNATIONAL, 481 North Frederick Ave., suite 500, Gaithersburg, MD 20877, or may be examined at the National Archives and Records Administration (NARA). For information on the availability of this material at NARA, call 202-741-6030, or go to: http://www.archives.gov/federal_register/code_of_federal_regulations/ibr_locations.html. Margarine contains only safe and suitable ingredients, as defined in §130.3(d) of this chapter. It is produced from one or more of the optional ingredients in paragraph (a)(1) of this section, and one or more of the optional ingredients in paragraph (a)(2) of this section, to which may be added one or more of the optional ingredients in paragraph (b) of this section. Margarine contains vitamin A as provided for in paragraph (a)(3) of this section.

(1) Edible fats and/or oils, or mixtures of these, whose origin is vegetable or rendered animal carcass fats, or any form of oil from a marine species that has been affirmed as GRAS or listed as a food additive for this use, any or all of which may have been subjected to an accepted process of physico-chemical modification. They may contain small amounts of other lipids, such as phosphatides or unsaponifiable constituents, and of free fatty acids naturally present in the fat or oil.

(2) One or more of the following aqueous phase ingredients:

(i) Water and/or milk and/or milk products.

(ii) Suitable edible protein including, but not limited to, the liquid, condensed, or dry form of whey, whey modified by the reduction of lactose and/or minerals, nonlactose containing whey components, albumin, casein, caseinate, vegetable proteins, or soy protein isolate, in amounts not greater than reasonably required to accomplish the desired effect.

(iii) Any mixture of two or more of the articles named under paragraphs (a)(2) (i) and (ii) of this section.

(iv) The ingredients in paragraphs (a)(2) (i), (ii), and (iii) of this section shall be pasteurized and then may be subjected to the action of harmless bacterial starters. One or more of the articles designated in paragraphs (a)(2) (i), (ii), and (iii) of this section is intimately mixed with the edible fat and/or ingredients to form a solidified or liquid emulsion.

(3) Vitamin A in such quantity that the finished margarine contains not less than 15,000 international units per pound.

(b) *Optional ingredients.* (1) Vitamin D in such quantity that the finished oleomargarine contains not less than 1,500 international units of vitamin D per pound.

(2) Salt (sodium chloride); potassium chloride for dietary margarine or oleomargarine.

(3) Nutritive carbohydrate sweeteners.

(4) Emulsifiers.

(5) Preservatives including but not limited to the following within these maximum amounts in percent by weight of the finished food: Sorbic acid, benzoic acid and their sodium, potassium, and calcium salts, individually, 0.1 percent, or in combination, 0.2 percent, expressed as the acids; calcium disodium EDTA, 0.0075 percent; propyl, octyl, and dodecyl gallates, BHT, BHA, ascorbyl palmitate, ascorbyl stearate, all individually or in combination, 0.02 percent; stearyl citrate, 0.15 percent; isopropyl citrate mixture, 0.02 percent.

(6) Color additives. For the purpose of this subparagraph, provitamin A (beta-

carotene) shall be deemed to be a color additive.

(7) Flavoring substances. If the flavoring ingredients impart to the food a flavor other than in semblance of butter, the characterizing flavor shall be declared as part of the name of the food in accordance with §101.22 of this chapter.

(8) Acidulants.

(9) Alkalizers.

(c) *Nomenclature.* The name of the food for which a definition and standard of identity are prescribed in this section is “margarine” or “oleo-margarine”.

(d) *Label declaration.* Each of the ingredients used in the food shall be declared on the label as required by the applicable sections of parts 101 and 130 of this chapter. For the purposes of this section the use of the term “milk” unqualified means milk from cows. If any milk other than cow’s milk is used in whole or in part, the animal source shall be identified in conjunction with the word milk in the ingredient statement. Colored margarine shall be subject to the provisions of section 407 of the Federal Food, Drug, and Cosmetic Act as amended.

[42 FR 14478, Mar. 15, 1977, as amended at 47 FR 11834, Mar. 19, 1982; 48 FR 13024, Mar. 29, 1983; 49 FR 10103, Mar. 19, 1984; 54 FR 24896, June 12, 1989; 58 FR 2886, Jan. 6, 1993; 58 FR 21649, Apr. 23, 1993; 59 FR 26939, May 25, 1994; 63 FR 14035, Mar. 24, 1998]

PART 168—SWEETENERS AND TABLE SIRUPS

Subpart A [Reserved]

Subpart B—Requirements for Specific Standardized Sweeteners and Table Sirups

Sec.	
168.110	Dextrose anhydrous.
168.111	Dextrose monohydrate.
168.120	Glucose sirup.
168.121	Dried glucose sirup.
168.122	Lactose.
168.130	Cane sirup.
168.140	Maple sirup.
168.160	Sorghum sirup.
168.180	Table sirup.

AUTHORITY: 21 U.S.C. 321, 341, 343, 348, 371, 379e.

SOURCE: 42 FR 14479, Mar. 15, 1977, unless otherwise noted.

Subpart A [Reserved]

Subpart B—Requirements for Specific Standardized Sweeteners and Table Sirups

§ 168.110 Dextrose anhydrous.

(a) Dextrose anhydrous is purified and crystallized D-glucose without water of crystallization and conforms to the specifications of §168.111, except that the total solids content is not less than 98.0 percent m/m.

(b) The name of the food is “Dextrose anhydrous” or “Anhydrous dextrose” or alternatively, “_____ sugar anhydrous” or “Anhydrous sugar”, with the blank to be filled with the name of the food source, for example, “Corn sugar anhydrous”.

[42 FR 14479, Mar. 15, 1977, as amended at 58 FR 2886, Jan. 6, 1993]

§ 168.111 Dextrose monohydrate.

(a) Dextrose monohydrate is purified and crystallized D-glucose containing one molecule of water of crystallization with each molecule of D-glucose.

(b) The food shall meet the following specifications:

(1) The total solids content is not less than 90.0 percent mass/mass (m/m), and the reducing sugar content (dextrose equivalent), expressed as D-glucose, is not less than 99.5 percent m/m calculated on a dry basis.

(2) The sulfated ash content is not more than 0.25 percent m/m (calculated on a dry basis), and the sulfur dioxide content is not more than 20 mg/kg.

(c) The name of the food is “Dextrose monohydrate” or “Dextrose” or alternatively, “_____ sugar monohydrate” or “_____ sugar”, with the blank to be filled with the name of the food source, for example, “Corn sugar monohydrate” or “Corn sugar”.

(d) For purposes of this section, the methods of analysis to be used to determine if the food meets the specifications of paragraph (b) (1) and (2) of this section are the following sections in “Official Methods of Analysis of the Association of Official Analytical Chemists,” 13th Ed. (1980), which is incorporated by reference. Copies may be obtained from the AOAC INTERNATIONAL, 481 North Frederick Ave.,

Food and Drug Administration, HHS

§ 168.121

suite 500, Gaithersburg, MD 20877, or may be examined at the National Archives and Records Administration (NARA). For information on the availability of this material at NARA, call 202-741-6030, or go to: http://www.archives.gov/federal_register/code_of_federal_regulations/ibr_locations.html.

- (1) Total solids content, 31.005.
- (2) Reducing sugar content, section 31.220(a).
- (3) Sulfated ash content, section 31.216.
- (4) Sulfur dioxide content, sections 20.106–20.111.

[42 FR 14479, Mar. 15, 1977, as amended at 47 FR 11834, Mar. 19, 1982; 49 FR 10103, Mar. 19, 1984; 54 FR 24896, June 12, 1989; 58 FR 2886, Jan. 6, 1993; 63 FR 14035, Mar. 24, 1998]

§ 168.120 Glucose sirup.

(a) Glucose sirup is the purified, concentrated, aqueous solution of nutritive saccharides obtained from edible starch.

(b) The food shall meet the following specifications:

(1) The total solids content is not less than 70.0 percent mass/mass (m/m), and the reducing sugar content (dextrose equivalent), expressed as D-glucose, is not less than 20.0 percent m/m calculated on a dry basis.

(2) The sulfated ash content is not more than 1.0 percent m/m (calculated on a dry basis), and the sulfur dioxide content is not more than 40 mg/kg.

(c) The name of the food is “Glucose sirup”. When the food is derived from a specific type of starch, the name may alternatively be “_____ sirup”, the blank to be filled in with the name of the starch. For example, “Corn sirup”, “Wheat sirup”, “Tapioca sirup”. When the starch is derived from sorghum grain, the alternative name of the food is “Sorghum grain sirup”. The word “sirup” may also be spelled “syrup”.

(d) For purposes of this section, the methods of analysis to be used to determine if the food meets the specifications of paragraph (b)(1) and (2) of this section are the following sections in “Official Methods of Analysis of the Association of Official Analytical Chemists,” 13th Ed. (1980), which is incorporated by reference. Copies may be obtained from the AOAC INTER-

NATIONAL, 481 North Frederick Ave., suite 500, Gaithersburg, MD 20877, or may be examined at the National Archives and Records Administration (NARA). For information on the availability of this material at NARA, call 202-741-6030, or go to: http://www.archives.gov/federal_register/code_of_federal_regulations/ibr_locations.html.

- (1) Total solids content, sections 31.208–31.209.
- (2) Reducing sugar content, section 31.220(a).
- (3) Sulfated ash content, section 31.216.
- (4) Sulfur dioxide content, sections 20.106–20.111.

[42 FR 14479, Mar. 15, 1977, as amended at 47 FR 11834, Mar. 19, 1982; 49 FR 10103, Mar. 19, 1984; 54 FR 24896, June 12, 1989; 63 FR 14035, Mar. 24, 1998]

§ 168.121 Dried glucose sirup.

(a) Dried glucose sirup is glucose sirup from which the water has been partially removed and conforms to the specifications of §168.120, except that:

(1) The total solids content is not less than 90.0 percent m/m when the reducing sugar content (dextrose equivalent), expressed as D-glucose, is not less than 88.0 percent m/m, calculated on a dry basis; or

(2) The total solids content is not less than 93.0 percent m/m when the reducing sugar content, (dextrose equivalent) expressed as D-glucose, is less than 88.0 percent m/m, calculated on a dry basis.

(b) The name of the food is “Dried glucose sirup” or “Glucose sirup solids”. When the food is derived from a specific type of starch, the name may alternatively be “Dried _____ sirup” or “_____ sirup solids”, the blank to be filled in with the name of the starch; for example, “Dried corn sirup”, “Corn sirup solids”, “Dried wheat sirup”, “Wheat sirup solids”, “Dried tapioca sirup”, “Tapioca sirup solids”. When the starch is derived from sorghum grain, the alternative name of the food is “Dried sorghum grain sirup” or “Sorghum grain sirup solids”. The word “sirup” may also be spelled “syrup”.

§ 168.122

21 CFR Ch. I (4-1-07 Edition)

§ 168.122 Lactose.

(a) Lactose is the carbohydrate normally obtained from whey. It may be anhydrous or contain one molecule of water of crystallization or be a mixture of both forms.

(b) The food shall meet the following specifications:

(1) The lactose content is not less than 98.0 percent, mass over mass (m/m), calculated on a dry basis.

(2) The sulfated ash content is not more than 0.3 percent, m/m, calculated on a dry basis.

(3) The pH of a 10.0-percent m/m solution is not less than 4.5 nor more than 7.5.

(4) The loss on drying for 16 hours at 120 °C is not more than 6.0 percent, m/m.

(c) The name of the food is "Lactose" or, alternatively, "Milk sugar".

(d) The methods of analysis in paragraphs (d)(1), (d)(2), (d)(3), (d)(4), and (d)(5) of this section are to be used to determine whether the food meets the requirements of paragraphs (b)(1), (b)(2), (b)(3), and (b)(4) of this section. The methods are contained in "Official Methods of Analysis of the Association of Official Analytical Chemists", 14th Ed. (1984), including the 4th Supp. (1988), which is incorporated by reference in accordance with 5 U.S.C. 552(a). Copies of the material incorporated by reference may be obtained from the AOAC INTERNATIONAL, 481 North Frederick Ave., suite 500, Gaithersburg, MD 20877, or may be examined at the National Archives and Records Administration (NARA). For information on the availability of this material at NARA, call 202-741-6030, or go to: http://www.archives.gov/federal_register/code_of_federal_regulations/ibr_locations.html.

(1) Lactose content, sections 31.064 to 31.071, "Purity of Lactose, Liquid Chromatographic Method," First Action, 14th Ed. (1984), pp. 583 and 584.

(2) Lactose content, sections 31.064 to 31.071, "Purity of Lactose, Liquid Chromatographic Method," "Changes in Official Methods of Analysis," 14th Ed., 4th Supp. (1988), p. 212. This reference recognizes the change in status of the method from first action to final action.

(3) Sulfated ash content, section 31.014, "Ash of Sugars and Sirups," Final Action, Sulfated Ash, 14th Ed. (1984), p. 575.

(4) pH, section 14.022, "pH of Flour, Potentiometric Method," Final Action, except that a 10-percent m/m solution of lactose in water is used for the determination, 14th Ed. (1984), p. 252.

(5) Loss on drying at 120 °C, section 31.070, 14th Ed. (1984), p. 584.

[42 FR 14479, Mar. 15, 1977, as amended at 47 FR 11834, Mar. 19, 1982; 49 FR 10103, Mar. 19, 1984; 54 FR 24896, June 12, 1989; 55 FR 8459, Mar. 8, 1990; 63 FR 14035, Mar. 24, 1998]

§ 168.130 Cane sirup.

(a) Cane sirup is the liquid food derived by concentration and heat treatment of the juice of sugarcane (*Saccharum officinarum* L.) or by solution in water of sugarcane concrete made from such juice. It contains not less than 74 percent by weight of soluble solids derived solely from such juice. The concentration may be adjusted with or without added water. It may contain one or more of the optional ingredients provided for in paragraph (b) of this section. All ingredients from which the food is fabricated shall be safe and suitable.

(b) The optional ingredients that may be used in cane sirup are:

(1) Salt.

(2) Preservatives.

(3) Defoaming agents.

(c) The name of the food is "Cane sirup" or "Sugar cane sirup". Alternatively, the word "sirup" may be spelled "syrup".

(d) *Label declaration.* Each of the ingredients used in the food shall be declared on the label as required by the applicable sections of parts 101 and 130 of this chapter.

[42 FR 14479, Mar. 15, 1977, as amended at 58 FR 2886, Jan. 6, 1993]

§ 168.140 Maple sirup.

(a) Maple sirup is the liquid food derived by concentration and heat treatment of the sap of the maple tree (*Acer*) or by solution in water of maple sugar (maple concrete) made from such sap. It contains not less than 66 percent by weight of soluble solids derived solely from such sap. The concentration may be adjusted with or without added

water. It may contain one or more of the optional ingredients provided for in paragraph (b) of this section. All ingredients from which the food is fabricated shall be safe and suitable.

(b) The optional ingredients that may be used in maple sirup are:

- (1) Salt.
- (2) Chemical preservatives.
- (3) Defoaming agents.

(c) The name of the food is "Maple sirup". Alternatively, the word "sirup" may be spelled "syrup".

(d) *Label declaration.* Each of the ingredients used in the food shall be declared on the label as required by the applicable sections of parts 101 and 130 of this chapter.

[42 FR 14479, Mar. 15, 1977, as amended at 58 FR 2896, Jan. 6, 1993]

§ 168.160 Sorghum sirup.

(a) Sorghum sirup is the liquid food derived by concentration and heat treatment of the juice of sorghum cane (sorgos) (*Sorghum vulgare*). It contains not less than 74 percent by weight of soluble solids derived solely from such juice. The concentration may be adjusted with or without added water. It may contain one or more of the optional ingredients provided for in paragraph (b) of this section. All ingredients from which the food is fabricated shall be safe and suitable.

(b) The optional ingredients that may be used in sorghum sirup are:

- (1) Salt.
- (2) Chemical preservatives.
- (3) Defoaming agents.
- (4) Enzymes.
- (5) Anticrystallizing agents.
- (6) Antisolidifying agents.

(c) The name of the food is "Sorghum sirup" or "Sorghum". Alternatively, the word "sirup" may be spelled "syrup".

(d) *Label declaration.* Each of the ingredients used in the food shall be declared on the label as required by the applicable sections of parts 101 and 130 of this chapter.

[42 FR 14479, Mar. 15, 1977, as amended at 58 FR 2886, Jan. 6, 1993]

§ 168.180 Table sirup.

(a) Table sirup is the liquid food consisting of one or more of the optional

sweetening ingredients provided for in paragraph (b)(1) of this section. The food contains not less than 65 percent soluble sweetener solids by weight and is prepared with or without added water. It may contain one or more of the optional ingredients prescribed in paragraphs (b)(2) through (12) of this section. All ingredients from which the food is fabricated shall be safe and suitable. (Vitamins, minerals, and protein added for nutritional purposes and artificial sweeteners are not considered to be suitable ingredients for this food.)

(b) The optional ingredients that may be used in table sirup are:

(1) One or more of the nutritive carbohydrate sweeteners provided for in this paragraph (b)(1). When a sweetener provided for in paragraph (b)(1)(i) or (ii) of this section is used it shall constitute not less than 2 percent by weight of the finished food.

(i) The sirups identified by §§ 168.130, 168.140, and 168.160, except that the use of any such ingredient is so limited that the finished food does not meet the requirement prescribed for any sirup by §§ 168.130, 168.140, or 168.160.

(ii) Honey.

(iii) Other nutritive carbohydrate sweeteners.

(2) Butter, in a quantity not less than 2 percent by weight of the finished food.

(3) Edible fats and oils, except that, in products designated as "battered sirups", butter as provided for in paragraph (b)(2) of this section is the only fat that may be used.

(4) Emulsifiers or stabilizers or both.

(5) Natural and artificial flavorings, either fruit or nonfruit, alone or in carriers.

(6) Color additives.

(7) Salt.

(8) Chemical preservatives.

(9) Viscosity adjusting agents.

(10) Acidifying, alkalizing, or buffering agents.

(11) Defoaming agents.

(12) Any other ingredient (e.g., shredded coconut, ground orange peel) that is not incompatible with other ingredients in the food.

(c) Except as provided for in this paragraph and in paragraphs (d) (2) and (3) of this section, the name of the food is "Table sirup", "Sirup", "Pancake

sirup”, “Waffle sirup”, “Pancake and waffle sirup”, or “_____ sirup”, the blank being filled in with the word or words that designate the sweetening ingredient that characterizes the food, except “maple”, “cane”, or “sorghum” alone, such sirups being required to comply in all respects with §§168.130, 168.140, and 168.160, respectively, and in the case of more than one sweetening ingredient, in descending order of predominance by weight in the food. The type shall be of uniform style and size.

(1) When one of the sweeteners constitutes at least 80 percent of the total sweetener solids, the name of the food may be designated as the corresponding sirup, for example, “Corn sirup”, provided that the name is immediately and conspicuously followed, without intervening written, printed, or graphic matter, by the statement “with _____” as part of the name, the blank being filled in with the name or names of each additional sweetening ingredient present, stated in a clear legible manner in letters of uniform style and size not less than one-half the height of, nor larger than, the letters used in the name of the principal sweetener.

(2) When butter is used, as provided for in paragraph (b)(2) of this section, the name of the food may be “Buttered _____”, the blank being filled in with the name otherwise prescribed in this paragraph. The percentage by weight of butter present shall be declared as part of the name of the food as prescribed by part 102 of this chapter.

(3) Alternatively, the word “sirup” may be spelled “syrup”.

(d)(1) *Label declaration.* Each of the ingredients used in the food shall be declared on the label as required by the applicable sections of parts 101 and 130 of this chapter.

(2) A statement (other than in the ingredient listing) or a vignette identifying a flavor may be included on the label only if such flavor contributes the primary recognizable flavor that characterizes the sirup. When maple, honey, or both maple and honey are represented as the characterizing flavors, the total quantity of maple sirup or honey, singly, or of maple sirup and honey in combination, shall be not less than 10 percent by weight of the fin-

ished food. The presence of any natural or artificial flavor in the food shall be declared on the label as prescribed by the applicable sections of part 101 of this chapter.

(3) The percentage of any optional ingredient used shall be declared as part of the name of the food as prescribed by part 102 of this chapter when all of the following conditions apply to the use of the ingredient:

(i) It is one of the characterizing ingredients permitted by paragraphs (b)(1) (i) and (ii) of this section.

(ii) The ingredient is either named on the label other than in the list of ingredients or is suggested by vignette or other labeling.

[42 FR 14479, Mar. 15, 1977, as amended at 58 FR 2886, Jan. 6, 1993]

PART 169—FOOD DRESSINGS AND FLAVORINGS

Subpart A—General Provisions

Sec.

169.3 Definitions.

Subpart B—Requirements for Specific Standardized Food Dressings and Flavorings

169.115	French dressing.
169.140	Mayonnaise.
169.150	Salad dressing.
169.175	Vanilla extract.
169.176	Concentrated vanilla extract.
169.177	Vanilla flavoring.
169.178	Concentrated vanilla flavoring.
169.179	Vanilla powder.
169.180	Vanilla-vanillin extract.
169.181	Vanilla-vanillin flavoring.
169.182	Vanilla-vanillin powder.

AUTHORITY: 21 U.S.C. 321, 341, 343, 348, 371, 379e.

SOURCE: 42 FR 14481, Mar. 15, 1977, unless otherwise noted.

Subpart A—General Provisions

§ 169.3 Definitions.

For the purposes of this part:

(a) The term *vanilla beans* means the properly cured and dried fruit pods of *Vanilla planifolia Andrews* and of *Vanilla tahitensis Moore*.

(b) The term *unit weight of vanilla beans* means, in the case of vanilla

beans containing not more than 25 percent moisture, 13.35 ounces of such beans; and, in the case of vanilla beans containing more than 25 percent moisture, it means the weight of such beans equivalent in content of moisture-free vanilla-bean solids to 13.35 ounces of vanilla beans containing 25 percent moisture. (For example, one unit weight of vanilla beans containing 33.25 percent moisture amounts to 15 ounces.) The moisture content of vanilla beans is determined by the method prescribed in "Official Methods of Analysis of the Association of Official Analytical Chemists," 13th Ed. (1980), sections 7.004 and 7.005, which is incorporated by reference, except that the toluene used is blended with 20 percent by volume of benzene and the total distillation time is 4 hours. Copies of the material incorporated by reference may be obtained from the AOAC INTERNATIONAL, 481 North Frederick Ave., suite 500, Gaithersburg, MD 20877, or may be examined at the National Archives and Records Administration (NARA). For information on the availability of this material at NARA, call 202-741-6030, or go to: http://www.archives.gov/federal_register/code_of_federal_regulations/ibr_locations.html. To prepare samples for analysis, the pods are chopped into pieces approximately 1/4-inch in longest dimension, using care to avoid moisture change.

(c) The term *unit of vanilla constituent* means the total sapid and odorous principles extractable from one unit weight of vanilla beans, as defined in paragraph (b) of this section, by an aqueous alcohol solution in which the content of ethyl alcohol by volume amounts to not less than 35 percent.

[42 FR 14481, Mar. 15, 1977, as amended at 47 FR 11834, Mar. 19, 1982; 49 FR 10103, Mar. 19, 1984; 54 FR 24896, June 12, 1989; 63 FR 14035, Mar. 24, 1998]

Subpart B—Requirements for Specific Standardized Food Dressings and Flavorings

§ 169.115 French dressing.

(a) *Description.* French dressing is the separable liquid food or the emulsified viscous fluid food prepared from vegetable oil(s) and one or both of the

acidifying ingredients specified in paragraph (b) of this section. One or more of the ingredients specified in paragraph (c) of this section may also be used. The vegetable oil(s) used may contain an optional crystallization inhibitor as specified in paragraph (c)(11) of this section. All the ingredients from which the food is fabricated shall be safe and suitable. French dressing contains not less than 35 percent by weight of vegetable oil. French dressing may be mixed and packed in an atmosphere in which air is replaced in whole or in part by carbon dioxide or nitrogen.

(b) *Acidifying ingredients.* (1) Any vinegar or any vinegar diluted with water, or any such vinegar or diluted vinegar mixed with an optional acidifying ingredient as specified in paragraph (c)(9) of this section. For the purpose of this paragraph, any blend of two or more vinegars is considered to be a vinegar.

(2) Lemon juice and/or lime juice in any appropriate form, which may be diluted with water.

(c) *Other optional ingredients.* The following optional ingredients may also be used:

- (1) Salt.
- (2) Nutritive carbohydrate sweeteners.
- (3) Spices and/or natural flavorings.
- (4) Monosodium glutamate.
- (5) Tomato paste, tomato puree, catsup, sherry wine.
- (6) Eggs and ingredients derived from eggs.
- (7) Color additives that will impart the color traditionally expected.
- (8) Stabilizers and thickeners to which calcium carbonate or sodium hexametaphosphate may be added. Dioctyl sodium sulfosuccinate may be added in accordance with §172.810 of this chapter.
- (9) Citric and/or malic acid, in an amount not greater than 25 percent of the weight of the acids of the vinegar or diluted vinegar calculated as acetic acid.
- (10) Sequestrant(s), including but not limited to calcium disodium EDTA (calcium disodium ethylenediaminetetraacetate) and/or disodium EDTA (disodium ethylenediaminetetraacetate), may be used to preserve color and/or flavor.

§ 169.140

21 CFR Ch. I (4-1-07 Edition)

(11) Crystallization inhibitors, including but not limited to oxystearin, lecithin, or polyglycerol esters of fatty acids.

(d) *Nomenclature.* The name of the food is "French dressing".

(e) *Label declaration.* Each of the ingredients used in the food shall be declared on the label as required by the applicable sections of parts 101 and 130 of this chapter.

[42 FR 14481 Mar. 15, 1977, as amended at 58 FR 2886, Jan. 6, 1993]

§ 169.140 Mayonnaise.

(a) *Description.* Mayonnaise is the emulsified semisolid food prepared from vegetable oil(s), one or both of the acidifying ingredients specified in paragraph (b) of this section, and one or more of the egg yolk-containing ingredients specified in paragraph (c) of this section. One or more of the ingredients specified in paragraph (d) of this section may also be used. The vegetable oil(s) used may contain an optional crystallization inhibitor as specified in paragraph (d)(7) of this section. All the ingredients from which the food is fabricated shall be safe and suitable. Mayonnaise contains not less than 65 percent by weight of vegetable oil. Mayonnaise may be mixed and packed in an atmosphere in which air is replaced in whole or in part by carbon dioxide or nitrogen.

(b) *Acidifying ingredients.* (1) Any vinegar or any vinegar diluted with water to an acidity, calculated as acetic acid, of not less than 2½ percent by weight, or any such vinegar or diluted vinegar mixed with an optional acidifying ingredient as specified in paragraph (d)(6) of this section. For the purpose of this paragraph, any blend of two or more vinegars is considered to be a vinegar.

(2) Lemon juice and/or lime juice in any appropriate form, which may be diluted with water to an acidity, calculated as citric acid, of not less than 2½ percent by weight.

(c) *Egg yolk-containing ingredients.* Liquid egg yolks, frozen egg yolks, dried egg yolks, liquid whole eggs, frozen whole eggs, dried whole eggs, or any one or more of the foregoing ingredients listed in this paragraph with liquid egg white or frozen egg white.

(d) *Other optional ingredients.* The following optional ingredients may also be used:

(1) Salt.

(2) Nutritive carbohydrate sweeteners.

(3) Any spice (except saffron or turmeric) or natural flavoring, provided it does not impart to the mayonnaise a color simulating the color imparted by egg yolk.

(4) Monosodium glutamate.

(5) Sequestrant(s), including but not limited to calcium disodium EDTA (calcium disodium ethylenediaminetetraacetate) and/or disodium EDTA (disodium ethylenediaminetetraacetate), may be used to preserve color and/or flavor.

(6) Citric and/or malic acid in an amount not greater than 25 percent of the weight of the acids of the vinegar or diluted vinegar, calculated as acetic acid.

(7) Crystallization inhibitors, including but not limited to oxystearin, lecithin, or polyglycerol esters of fatty acids.

(e) *Nomenclature.* The name of the food is "Mayonnaise".

(f) *Label declaration.* Each of the ingredients used in the food shall be declared on the label as required by the applicable sections of parts 101 and 130 of this chapter.

[42 FR 14481, Mar. 15, 1977, as amended at 57 FR 34246, Aug. 4, 1992; 58 FR 2886, Jan. 6, 1993]

§ 169.150 Salad dressing.

(a) *Description.* Salad dressing is the emulsified semisolid food prepared from vegetable oil(s), one or both of the acidifying ingredients specified in paragraph (b) of this section, one or more of the egg yolk-containing ingredients specified in paragraph (c) of this section, and a starchy paste prepared as specified in paragraph (e) of this section. One or more of the ingredients in paragraph (e) of this section may also be used. The vegetable oil(s) used may contain an optional crystallization inhibitor as specified in paragraph (e)(8) of this section. All the ingredients from which the food is fabricated shall be safe and suitable. Salad dressing contains not less than 30 percent by weight of vegetable oil and not less egg yolk-containing ingredient than is

equivalent in egg yolk solids content to 4 percent by weight of liquid egg yolks. Salad dressing may be mixed and packed in an atmosphere in which air is replaced in whole or in part by carbon dioxide or nitrogen.

(b) *Acidifying ingredients.* (1) Any vinegar or any vinegar diluted with water, or any such vinegar or diluted vinegar mixed with an optional acidifying ingredient as specified in paragraph (e)(6) of this section. For the purpose of this paragraph, any blend of two or more vinegars is considered to be a vinegar.

(2) Lemon juice and/or lime juice in any appropriate form, which may be diluted with water.

(c) *Egg yolk-containing ingredients.* Liquid egg yolks, frozen egg yolks, dried egg yolks, liquid whole eggs, frozen whole eggs, dried whole eggs, or any one of more of the foregoing ingredients listed in this paragraph with liquid egg white or frozen egg white.

(d) *Starchy paste.* It may be prepared from a food starch, food starch-modified, tapioca flour, wheat flour, rye flour, or any two or more of these. Water may be added in the preparation of the paste.

(e) *Other optional ingredients.* The following optional ingredients may also be used:

- (1) Salt.
- (2) Nutritive carbohydrate sweeteners.
- (3) Any spice (except saffron or turmeric) or natural flavoring, provided it does not impart to the salad dressing a color simulating the color imparted by egg yolk.
- (4) Monosodium glutamate.
- (5) Stabilizers and thickeners. Dioctyl sodium sulfosuccinate may be added in accordance with §172.810 of this chapter.
- (6) Citric and/or malic acid may be used in an amount not greater than 25 percent of the weight of the acids of the vinegar or diluted vinegar calculated as acetic acid.
- (7) Sequestrant(s), including but not limited to calcium disodium EDTA (calcium disodium ethylenediaminetetraacetate) and/or disodium EDTA (disodium ethylenediaminetetraacetate), may be used to preserve color and/or flavor.

(8) Crystallization inhibitors, including but not limited to oxystearin, lecithin, or polyglycerol esters of fatty acids.

(f) *Nomenclature.* The name of the food is "Salad dressing".

(g) *Label declaration.* Each of the ingredients used in the food shall be declared on the label as required by the applicable sections of parts 101 and 130 of this chapter.

[42 FR 14481, Mar. 15, 1977, as amended at 42 FR 25325, May 17, 1977; 58 FR 2886, Jan. 6, 1993]

§ 169.175 Vanilla extract.

(a) Vanilla extract is the solution in aqueous ethyl alcohol of the sapid and odorous principles extractable from vanilla beans. In vanilla extract the content of ethyl alcohol is not less than 35 percent by volume and the content of vanilla constituent, as defined in §169.3(c), is not less than one unit per gallon. The vanilla constituent may be extracted directly from vanilla beans or it may be added in the form of concentrated vanilla extract or concentrated vanilla flavoring or vanilla flavoring concentrated to the semisolid form called vanilla oleo-resin. Vanilla extract may contain one or more of the following optional ingredients:

- (1) Glycerin.
- (2) Propylene glycol.
- (3) Sugar (including invert sugar).
- (4) Dextrose.
- (5) Corn sirup (including dried corn sirup).

(b)(1) The specified name of the food is "Vanilla extract" or "Extract of vanilla".

(2) When the vanilla extract is made in whole or in part by dilution of vanilla oleoresin, concentrated vanilla extract, or concentrated vanilla flavoring, the label shall bear the statement "Made from _____" or "Made in part from _____", the blank being filled in with the name or names "vanilla oleoresin", "concentrated vanilla extract", or "concentrated vanilla flavoring", as appropriate. If the article contains two or more units of vanilla constituent, the name of the food shall include the designation "____-fold", the blank being filled in with the whole

§ 169.176

number (disregarding fractions) expressing the number of units of vanilla constituent per gallon of the article.

(3) Wherever the name of the food appears on the label so conspicuously as to be easily seen under customary conditions of purchase, the labeling required by paragraph (b)(2) of this section shall immediately and conspicuously precede or follow such name, without intervening written, printed, or graphic matter.

(c) *Label declaration.* Each of the ingredients used in the food shall be declared on the label as required by the applicable sections of parts 101 and 130 of this chapter.

[42 FR 14479, Mar. 15, 1977, as amended at 58 FR 2886, Jan. 6, 1993]

§ 169.176 Concentrated vanilla extract.

(a) Concentrated vanilla extract conforms to the definition and standard of identity and is subject to any requirement for label statement of ingredients prescribed for vanilla extract by §169.175, except that it is concentrated to remove part of the solvent, and each gallon contains two or more units of vanilla constituent as defined in §169.3(c). The content of ethyl alcohol is not less than 35 percent by volume.

(b) The specified name of the food is "Concentrated vanilla extract __-fold" or " __-fold concentrated vanilla extract", the blank being filled in with the whole number (disregarding fractions) expressing the number of units of vanilla constituent per gallon of the article. (For example, "Concentrated vanilla extract 2-fold".)

[42 FR 14479, Mar. 15, 1977, as amended at 58 FR 2886, Jan. 6, 1993]

§ 169.177 Vanilla flavoring.

(a) Vanilla flavoring conforms to the definition and standard of identity and is subject to any requirement for label statement of ingredients prescribed for vanilla extract by §169.175, except that its content of ethyl alcohol is less than 35 percent by volume.

(b) The specified name of the food is "Vanilla flavoring".

[42 FR 14479, Mar. 15, 1977, as amended at 58 FR 2886, Jan. 6, 1993]

21 CFR Ch. I (4-1-07 Edition)

§ 169.178 Concentrated vanilla flavoring.

(a) Concentrated vanilla flavoring conforms to the definition and standard of identity and is subject to any requirement for label statement of ingredients prescribed for vanilla flavoring by §169.177, except that it is concentrated to remove part of the solvent, and each gallon contains two or more units of vanilla constituent as defined in §169.3(c).

(b) The specified name of the food is "Concentrated vanilla flavoring __-fold" or " __-fold concentrated vanilla flavoring", the blank being filled in with the whole number (disregarding fractions) expressing the number of units of vanilla constituent per gallon of the article. (For example, "Concentrated vanilla flavoring 3-fold".)

[42 FR 14479, Mar. 15, 1977, as amended at 58 FR 2886, Jan. 6, 1993]

§ 169.179 Vanilla powder.

(a) Vanilla powder is a mixture of ground vanilla beans or vanilla oleoresin or both, with one or more of the following optional blending ingredients:

- (1) Sugar.
- (2) Dextrose.
- (3) Lactose.
- (4) Food starch (including food starch-modified as prescribed in §172.892 of this chapter).
- (5) Dried corn sirup.
- (6) Gum acacia.

Vanilla powder may contain one or any mixture of two or more of the anticaking ingredients specified in paragraph (b) of this section, but the total weight of any such ingredient or mixture is not more than 2 percent of the weight of the finished vanilla powder. Vanilla powder contains in each 8 pounds not less than one unit of vanilla constituent, as defined in §169.3(c).

(b) The anticaking ingredients referred to in paragraph (a) of this section are:

- (1) Aluminum calcium silicate.
- (2) Calcium silicate.
- (3) Calcium stearate.
- (4) Magnesium silicate.
- (5) Tricalcium phosphate.

(c)(1) The specified name of the food is "Vanilla powder __-fold" or " __-fold

vanilla powder”, except that if sugar is the optional blending ingredient used, the word “sugar” may replace the word “powder”. The blank in the name is filled in with the whole number (disregarding fractions) expressing the number of units of vanilla constituent per 8 pounds of the article. However, if the strength of the article is less than 2-fold, the term “__-fold” is omitted from the name.

(2) The label of vanilla powder shall bear the common names of any of the optional ingredients specified in paragraphs (a) and (b) of this section that are used, except that where the alternative name “Vanilla sugar” is used for designating the food it is not required that sugar be named as an optional ingredient.

(3) Wherever the name of the food appears on the label so conspicuously as to be easily seen under customary conditions of purchase, the labeling required by paragraph (c)(2) of this section shall immediately and conspicuously precede or follow such name, without intervening written, printed, or graphic matter.

(d) *Label declaration.* Each of the ingredients used in the food shall be declared on the label as required by the applicable sections of parts 101 and 130 of this chapter.

[42 FR 14479, Mar. 15, 1977, as amended at 58 FR 2887, Jan. 6, 1993]

§ 169.180 Vanilla-vanillin extract.

(a) Vanilla-vanillin extract conforms to the definition and standard of identity and is subject to any requirement for label statement of ingredients prescribed for vanilla extract by §169.175, except that for each unit of vanilla constituent, as defined in §169.3(c), contained therein, the article also contains not more than 1 ounce of added vanillin.

(b) The specified name of the food is “Vanilla-vanillin extract __-fold” or “__-fold vanilla-vanillin extract”, followed immediately by the statement “contains vanillin, an artificial flavor (or flavoring)”. The blank in the name is filled in with the whole number (disregarding fractions) expressing the sum of the number of units of vanilla constituent plus the number of ounces of added vanillin per gallon of the article.

However, if the strength of the article is less than 2-fold, the term “__-fold” is omitted from the name.

[42 FR 14479, Mar. 15, 1977, as amended at 58 FR 2887, Jan. 6, 1993]

§ 169.181 Vanilla-vanillin flavoring.

(a) Vanilla-vanillin flavoring conforms to the definition and standard of identity and is subject to any requirement for label statement of ingredients prescribed for vanilla-vanillin extract by §169.180, except that its content of ethyl alcohol is less than 35 percent by volume.

(b) The specified name of the food is “Vanilla-vanillin flavoring __-fold” or “__-fold vanilla-vanillin flavoring”, followed immediately by the statement “contains vanillin, an artificial flavor (or flavoring)”. The blank in the name is filled in with the whole number (disregarding fractions) expressing the sum of the number of units of vanilla constituent plus the number of ounces of added vanillin per gallon of the article. However, if the strength of the article is less than 2-fold, the term “__-fold” is omitted from the name.

[42 FR 14479, Mar. 15, 1977, as amended at 58 FR 2887, Jan. 6, 1993]

§ 169.182 Vanilla-vanillin powder.

(a) Vanilla-vanillin powder conforms to the definition and standard of identity and is subject to any requirement for label statement of ingredients prescribed for vanilla powder by §169.179, except that for each unit of vanilla constituent as defined in §169.3(c) contained therein, the article also contains not more than 1 ounce of added vanillin.

(b) The specified name of the food is “Vanilla-vanillin powder __-fold” or “__-fold vanilla-vanillin powder”, followed immediately by the statement “contains vanillin, an artificial flavor (or flavoring)”. If sugar is the optional blending ingredient used, the word “sugar” may replace the word “powder” in the name. The blank in the name is filled in with the whole number (disregarding fractions) expressing the sum of the number of units of vanilla constituent plus the number of ounces of added vanillin per 8 pounds of the article. However, if the strength of

§ 169.182

21 CFR Ch. I (4-1-07 Edition)

the article is less than 2-fold the term
“__-fold” is omitted from the name.

[42 FR 14479, Mar. 15, 1977, as amended at 58
FR 2887, Jan. 6, 1993]